



FCC RF Test Report

APPLICANT : Motorola Mobility LLC
EQUIPMENT : Mobile Cellular Phone
BRAND NAME : Motorola
MODEL NAME : XT1920DL
FCC ID : IHDT56XF2
STANDARD : FCC Part 15 Subpart E §15.407
CLASSIFICATION : (NII) Unlicensed National Information Infrastructure

This is a data re-used report which is only valid together with the original test report. The product was received on Mar. 23, 2018 and testing was completed on Apr. 12, 2018. We, Sporton International (Shenzhen) Inc., would like to declare that the tested sample has been evaluated in accordance with the test procedures and has been in compliance with the applicable technical standards.

The test results in this report apply exclusively to the tested model / sample. Without written approval of Sporton International (Shenzhen) Inc., the test report shall not be reproduced except in full.



Approved by: Eric Shih / Manager

Sporton International (Shenzhen) Inc.

**1/F, 2/F, Bldg 5, Shiling Industrial Zone, Xinwei Village, Xili, Nanshan Shenzhen City
Guangdong Province 518055 China**



TABLE OF CONTENTS

REVISION HISTORY..... 3

SUMMARY OF TEST RESULT 4

1 GENERAL DESCRIPTION 5

 1.1 Applicant 5

 1.2 Manufacturer 5

 1.3 Product Feature of Equipment Under Test..... 5

 1.4 Product Specification of Equipment Under Test..... 6

 1.5 Specification of Accessory 6

 1.6 Re-use of Measured Data 7

 1.7 Modification of EUT 8

 1.8 Testing Location 8

 1.9 Applicable Standards 9

2 TEST CONFIGURATION OF EQUIPMENT UNDER TEST 10

 2.1 Carrier Frequency and Channel 10

 2.2 Test Mode 11

 2.3 Connection Diagram of Test System 12

 2.4 Support Unit used in test configuration and system 13

 2.5 EUT Operation Test Setup 13

3 TEST RESULT 14

 3.1 Maximum Conducted Output Power Measurement 14

 3.2 Unwanted Emissions Measurement 15

 3.3 AC Conducted Emission Measurement..... 21

 3.4 Automatically Discontinue Transmission 25

 3.5 Antenna Requirements 26

4 LIST OF MEASURING EQUIPMENT 27

5 UNCERTAINTY OF EVALUATION 28

APPENDIX A. CONDUCTED TEST RESULTS

APPENDIX B. RADIATED SPURIOUS EMISSION

APPENDIX C. DUTY CYCLE PLOTS

APPENDIX D. SETUP PHOTOGRAPHS

APPENDIX E. REFERENCE REPORT



REVISION HISTORY

REPORT NO.	VERSION	DESCRIPTION	ISSUED DATE
FR832306E	Rev. 01	Initial issue of report	May 09, 2018



SUMMARY OF TEST RESULT

Report Section	FCC Rule	Description	Limit	Result	Remark
-	15.403(i)	6dB, 26dB and 99% Occupied Bandwidth	> 500kHz	Pass	1
3.1	15.407(a)	Maximum Conducted Output Power	≤ 30 dBm	Pass	-
-	15.407(a)	Power Spectral Density	≤ 30 dBm/500kHz	Pass	1
3.2	15.407(b)	Unwanted Emissions	15.407(b)(4)(i) & 15.209(a)	Pass	Under limit 14.07 dB at 913.670 MHz
3.3	15.207	AC Conducted Emission	15.207(a)	Pass	Under limit 16.30 dB at 0.590 MHz
3.6	15.407(c)	Automatically Discontinue Transmission	Discontinue Transmission	Pass	-
3.7	15.203 & 15.407(a)	Antenna Requirement	N/A	Pass	-

Remark: 1. All conducted related test items refer to Sporton report No.FR7D1310E.



1 General Description

1.1 Applicant

Motorola Mobility LLC
222 W, Merchandise Mart Plaza, Chicago IL 60654 USA

1.2 Manufacturer

Motorola Mobility LLC
222 W, Merchandise Mart Plaza, Chicago IL 60654 USA

1.3 Product Feature of Equipment Under Test

Product Feature	
Equipment	Mobile Cellular Phone
Brand Name	Motorola
Model Name	XT1920DL
FCC ID	IHDT56XF2
EUT supports Radios application	CDMA/EVDO/GSM/GPRS/EGPRS/WCDMA/HSPA/ DC-HSDPA/HSPA+(16QAM uplink is not supported)/LTE WLAN 2.4GHz 802.11b/g/n HT20 WLAN 5GHz 802.11a/n HT20/HT40 Bluetooth v3.0+EDR/ Bluetooth v4.0 LE Bluetooth v4.1 LE/Bluetooth v4.2 LE
IMEI Code	Conducted: NA Radiation: 35413209000676 Conduction: 354132090007199
HW Version	DVT1B
SW Version	OPP28.1
EUT Stage	Identical Prototype

Remark: The above EUT's information was declared by manufacturer. Please refer to the specifications or user's manual for more detailed description.



1.4 Product Specification of Equipment Under Test

Standards-related Product Specification	
Tx/Rx Channel Frequency Range	5745 MHz ~ 5825 MHz
Maximum Output Power	<5745 MHz ~ 5825 MHz> 802.11a : 17.60 dBm / 0.0575 W 802.11n HT20 : 17.59 dBm / 0.0574 W 802.11n HT40 : 17.56 dBm / 0.0570 W
Type of Modulation	802.11a/n : OFDM (BPSK / QPSK / 16QAM / 64QAM)
Antenna Type / Gain	IFA Antenna with gain -2.00 dBi

1.5 Specification of Accessory

Specification of Accessory				
AC Adapter 1	Brand Name	Motorola (Acbel)	Model Name	C-P35 SPN5945A
	Power Rating	I/P: 100-240 Vac, 300mA, O/P: 5.2Vdc,2000mA		
AC Adapter 2	Brand Name	Motorola (Salom)	Model Name	SSW-2919UMTJ C-P35 SPN5945A
	Power Rating	I/P: 100-240 Vac, 300mA, O/P: 5.2Vdc,2000mA		
Battery	Brand Name	Motorola (SCUD)	Model Name	BL270
	Power Rating	3.85Vdc,4000mAh	Type	Li-ion, ATL426580
USB Cable	Brand Name	Motorola (Saibao)	Model Name	SLQ-A077A
	Signal Line Type	1.0 meter, shielded cable, without ferrite core		



1.6 Re-use of Measured Data

1.6.1 Introduction Section

This application re-uses data collected on a similar device. The subject device of this application (Model: XT1920DL, FCC ID: IHDT56XF2) is electrically identical to the reference device: (Model: XT1922-6, XT1922-7, XT1922-9, FCC ID: IHDT56XB1) for the portions of the circuitry corresponding to the data being re-used, as treated by KDB Publication 484596 D01.

1.6.2 Difference Section

For details concerning the similarity with respect to component placement, mechanical/electrical design etc., please refer to the Product Equality Declaration.

The re-used RF data includes the following bands provided in Appendix E (Sporton RF Report No. FR7D1310E for the reference device Model: XT1922-6, XT1922-7, XT1922-9, FCC ID: IHDT56XB1):

1.6.3 Spot Check Verification Data Section

For conducted test items, In order to confirm hardware similarity of the subject device with the reference device, spot check measurements were performed on the subject device for conducted power, the test result were consistent with FCC ID: IHDT56XB1 and RSE/Conduction to re-test.

Assertions concerning the similarity of these devices are based on representations by the applicant. The applicant accepts full responsibility for the validity of the similarity claim, and for the determination that verification test data are sufficient to support it.

1.6.4 Reference detail Section:

Equipment Class	Reference FCC ID	Folder Test	Report Title/Section
NII(B1~B4)	IHDT56XB1	Part15E(FR7D1310D)	All conducted sections(except Conducted Power) applicable
NII(B4)	IHDT56XB1	Part15E(FR7D1310E)	All conducted sections(except Conducted Power) applicable
NII(DFS)	IHDT56XB1	Part15E(FZ7D1310)	All sections applicable



1.7 Modification of EUT

No modifications are made to the EUT during all test items.

1.8 Testing Location

Sporton International (Shenzhen) Inc. is accredited to ISO 17025 by National Voluntary Laboratory Accreditation Program (NVLAP code: 600156-0) and the FCC designation No are CN5018 and CN5019.

Test Site	Sporton International (Shenzhen) Inc.		
Test Site Location	1/F, 2/F, Bldg 5, Shiling Industrial Zone, Xinwei Village, Xili, Nanshan Shenzhen City Guangdong Province 518055 China TEL: +86-755-8637-9589 FAX: +86-755-8637-9595		
Test Site No.	Sporton Site No.		FCC Test Firm Registration No.
	TH01-SZ	CO01-SZ	251365

Test Site	Sporton International (Shenzhen) Inc.		
Test Site Location	No. 3 Bldg the third floor of south, Shahe River west, Fengzeyuan Warehouse, Nanshan District Shenzhen City Guangdong Province 518055 China TEL: +86-755-3320-2398		
Test Site No.	Sporton Site No.		FCC Test Firm Registration No.
	03CH04-SZ		577730

Note: The test site complies with ANSI C63.4 2014 requirement.



1.9 Applicable Standards

According to the specifications of the manufacturer, the EUT must comply with the requirements of the following standards:

- ♦ FCC Part 15 Subpart E
- ♦ FCC KDB 789033 D02 General UNII Test Procedures New Rules v02r01
- ♦ ANSI C63.10-2013

Remark:

1. All test items were verified and recorded according to the standards and without any deviation during the test.
2. This EUT has also been tested and complied with the requirements of FCC Part 15, Subpart B, recorded in a separate test report.



2 Test Configuration of Equipment Under Test

The EUT has been associated with peripherals and configuration operated in a manner tended to maximize its emission characteristics in a typical application. Frequency range investigated: conducted emission (150 kHz to 30 MHz) and radiated emission (9 kHz to the 10th harmonic of the highest fundamental frequency or to 40 GHz, whichever is lower). For radiated measurement, pre-scanned in three orthogonal panels, X, Y, Z. The worst cases (Z-Plane) were recorded in this report.

2.1 Carrier Frequency and Channel

Frequency Band	Channel	Freq. (MHz)	Channel	Freq. (MHz)
5745-5825 MHz Band 4 (U-NII-3)	149	5745	157	5785
	151*	5755	159*	5795
	153	5765	161	5805
	-	-	165	5825

Note: The above Frequency and Channel in "*" were 802.11n HT40.



2.2 Test Mode

Final test mode of conducted test items and radiated spurious emissions are considering the modulation and worse data rates as below table.

Modulation	Data Rate
802.11a	6 Mbps
802.11n HT20	MCS0
802.11n HT40	MCS0

AC Conducted Emission	Mode 1 : WCDMA Band II Idle + Bluetooth Link + WLAN Link (5G) + USB Cable (Charging from Adapter 2) + Earphone + Camera(Front)
Remark: For Radiated Test Cases, The tests were performed with Earphone, Adapter 1 and USB Cable.	

Ch. #		Band IV : 5745-5825 MHz		
		802.11a	802.11n HT20	802.11n HT40
L	Low	149	149	151
M	Middle	157	157	-
H	High	165	165	159

2.3 Connection Diagram of Test System

<WLAN Tx Mode>

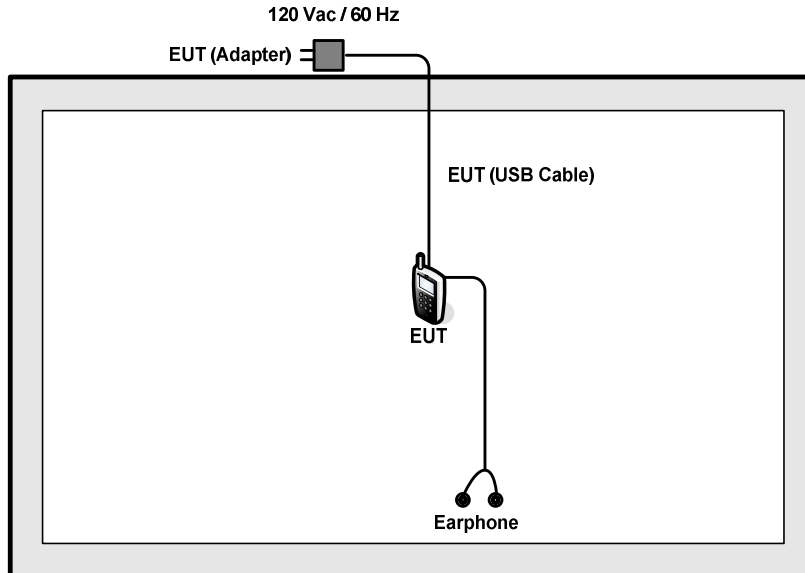

<AC Conducted Emission Mode>

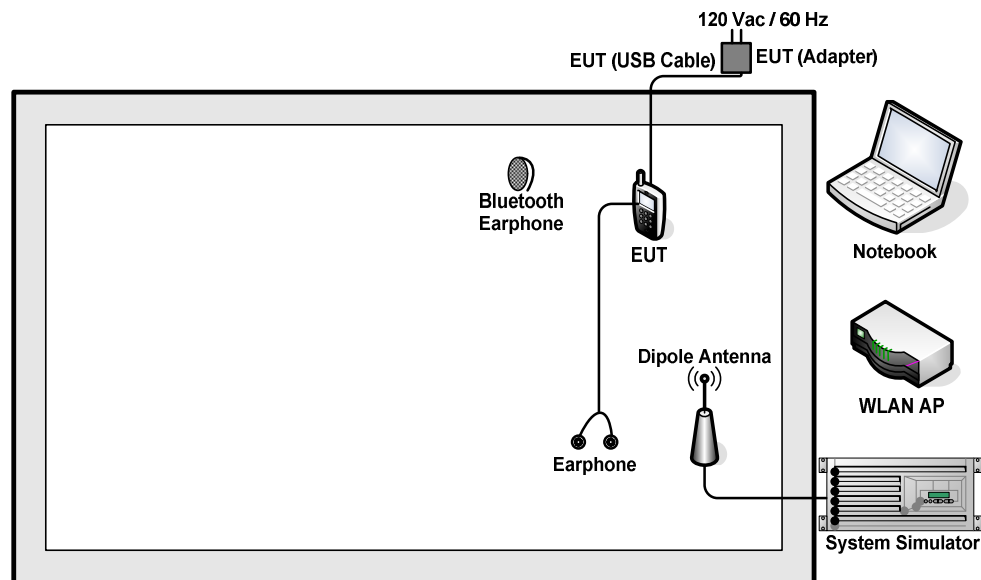



2.4 Support Unit used in test configuration and system

Item	Equipment	Trade Name	Model Name	FCC ID	Data Cable	Power Cord
1.	System Simulator	Anritsu	MT8820C	N/A	N/A	Unshielded, 1.8 m
2.	WLAN AP	D-Link	DIR-820L	KA2IR820LA1	N/A	Unshielded, 1.8 m
3.	Notebook	Lenovo	E540	FCC DoC	N/A	AC I/P: Unshielded, 1.2m DC O/P: Shielded, 1.8m
4.	Bluetooth Earphone	Samsung	EO-MG900	PYAHS-107W	N/A	N/A
5.	SD Card	N/A	MicroSD HC	FCC DoC	N/A	N/A
6.	Earphone	Ashley ROW	N/A	N/A	Unshielded, 1.2m	N/A

2.5 EUT Operation Test Setup

For WLAN RF test items, an engineering test program was provided and enabled to make EUT continuously transmit/receive.

For AC power line conducted emissions, the EUT was set to connect with the WLAN AP under large package sizes transmission.

3 Test Result

3.1 Maximum Conducted Output Power Measurement

3.1.1 Limit of Maximum Conducted Output Power

For the band 5.725–5.85 GHz, the maximum conducted output power over the frequency band of operation shall not exceed 1 W.

If transmitting antennas of directional gain greater than 6 dBi are used, the peak output power shall be reduced by the amount in dB that the directional gain of the antenna exceeds 6 dBi.

3.1.2 Measuring Instruments

The measuring equipment is listed in the section 4 of this test report.

3.1.3 Test Procedures

The testing follows Method PM of FCC KDB 789033 D02 General UNII Test Procedures New Rules v02r01.

Method PM (Measurement using an RF average power meter):

1. Measurement is performed using a wideband RF power meter.
2. The EUT is configured to transmit continuously with a consistent duty cycle at its maximum power control level.
3. Measure the average power of the transmitter, and the average power is corrected with duty factor, $10 \log(1/x)$, where x is the duty cycle.

3.1.4 Test Setup

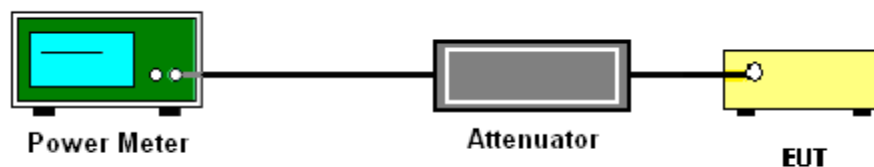

3.1.5 Test Result of Maximum Conducted Output Power

Please refer to Appendix A.



3.2 Unwanted Emissions Measurement

This section as specified in FCC Part 15.407(b) is to measure unwanted emissions through radiated measurement for band edge spurious emissions and out of band emissions measurement. The unwanted emissions shall comply with 15.407(b)(1) to (6), and restricted bands per FCC Part15.205.

3.2.1 Limit of Unwanted Emissions

(1) For transmitters operating in the 5.725-5.85 GHz band:

15.407(b)(4)(i) All emissions shall be limited to a level of -27 dBm/MHz at 75 MHz or more above or below the band edge increasing linearly to 10 dBm/MHz at 25 MHz above or below the band edge, and from 25 MHz above or below the band edge increasing linearly to a level of 15.6 dBm/MHz at 5 MHz above or below the band edge, and from 5 MHz above or below the band edge increasing linearly to a level of 27 dBm/MHz at the band edge.

(2) Unwanted spurious emissions fallen in restricted bands per FCC Part15.205 shall comply with the general field strength limits set forth in § 15.209 as below table,

Frequency (MHz)	Field Strength (microvolts/meter)	Measurement Distance (meters)
0.009 – 0.490	2400/F(kHz)	300
0.490 – 1.705	24000/F(kHz)	30
1.705 – 30.0	30	30
30 – 88	100	3
88 – 216	150	3
216 - 960	200	3
Above 960	500	3

Note: The following formula is used to convert the EIRP to field strength.

$$E = \frac{1000000\sqrt{30P}}{3} \mu\text{V/m, where P is the eirp (Watts)}$$



EIRP (dBm)	Field Strength at 3m (dBμV/m)
-17	78.3

(3) KDB789033 D02 v01r04 G)2)c)

- (i) Section 15.407(b)(1) to (b)(3) specify the unwanted emission limits for the U-NII-1 and U-NII-2 bands. As specified, emissions above 1000 MHz that are outside of the restricted bands are subject to a peak emission limit of -27 dBm/MHz.³
- (ii) Section 15.407(b)(4) specifies the unwanted emission limit for the U-NII-3 band. A band emissions mask is specified in Section 15.407(b)(4)(i). The emission limits are in terms of a Peak detector. An alternative to the band emissions mask is specified in Section 15.407(b)(4)(ii). The alternative limits are based on the highest antenna gain specified in the filing. There are also marketing and importation restrictions for the devices using the alternative limit.⁴

Note 3: An out-of-band emission that complies with both the average and peak limits of Section 15.209 is not required to satisfy the -27 dBm/MHz peak emission limit.

Note 4: Only devices with antenna gains of 10 dBi or less may be approved using the emission limits specified in Section 15.247(d) till March 2, 2018; all other devices operating in this band must use the mask specified in Section 15.407(b)(4)(i).



3.2.2 Measuring Instruments

The measuring equipment is listed in the section 4 of this test report.

3.2.3 Test Procedures

1. The testing follows FCC KDB 789033 D02 General UNII Test Procedures New Rules v01r04. Section G) Unwanted emissions measurement.

(1) Procedure for Unwanted Emissions Measurements Below 1000MHz

- RBW = 120 kHz
- VBW = 300 kHz
- Detector = Peak
- Trace mode = max hold

(2) Procedure for Peak Unwanted Emissions Measurements Above 1000 MHz

- RBW = 1 MHz
- VBW \geq 3 MHz
- Detector = Peak
- Sweep time = auto
- Trace mode = max hold

(3) Procedures for Average Unwanted Emissions Measurements Above 1000MHz

- RBW = 1 MHz
- VBW = 10 Hz, when duty cycle is no less than 98 percent.
- VBW \geq 1/T, when duty cycle is less than 98 percent where T is the minimum transmission duration over which the transmitter is on and is transmitting at its maximum power control level for the tested mode of operation.
- Detector = Peak

2. The EUT was placed on a turntable with 0.8 meter for frequency below 1GHz and 1.5 meter for frequency above 1GHz respectively above ground.
3. The EUT was set 3 meters from the interference receiving antenna which was mounted on the top of a variable height antenna tower.
4. The antenna is a broadband antenna and its height is adjusted between one meter and four meters above ground to find the maximum value of the field strength for both horizontal polarization and vertical polarization of the antenna.
5. For each suspected emission, the EUT was arranged to its worst case and then adjust the antenna tower (from 1 m to 4 m) and turntable (from 0 degree to 360 degrees) to find the maximum reading.
6. For testing below 1GHz, if the emission level of the EUT in peak mode was 3 dB lower than the limit specified, then peak values of EUT will be reported, otherwise, the emissions will be repeated one by one using the CISPR quasi-peak method and reported.
7. For testing above 1GHz, the emission level of the EUT in peak mode was 20dB lower than average limit (that means the emission level in average mode also complies with the limit in average mode), then peak values of EUT will be reported, otherwise, the emissions will be measured in average mode again and reported.

3.2.4 Test Setup

For radiated emissions below 30MHz

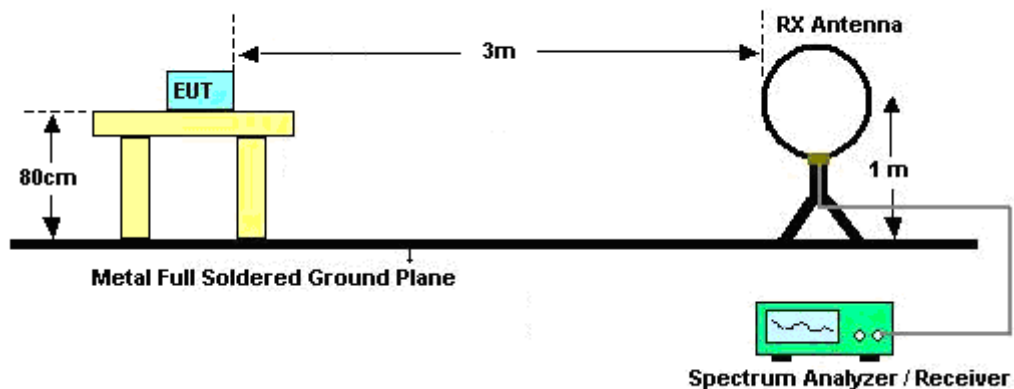

For radiated emissions from 30MHz to 1GHz

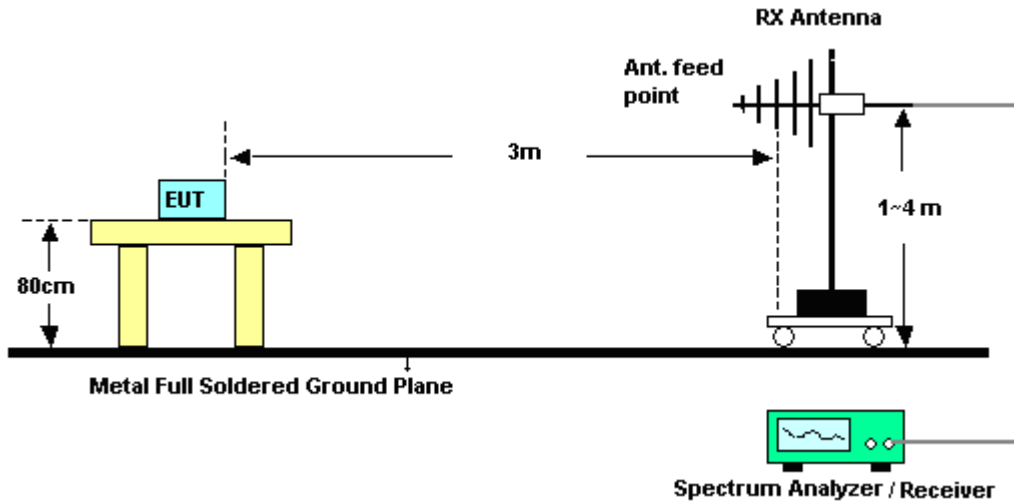

For radiated emissions above 1GHz

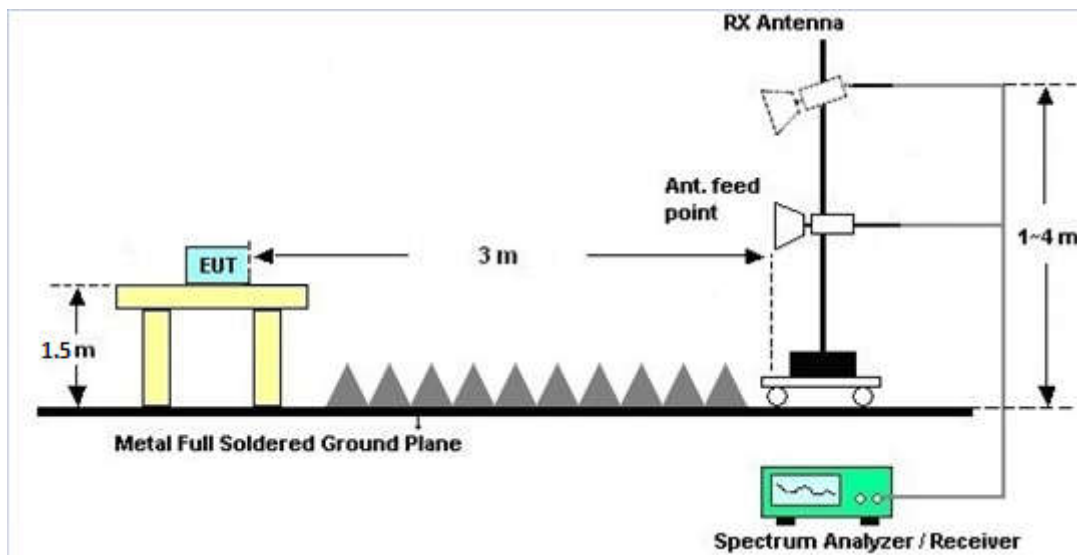



3.2.5 Test Results of Radiated Spurious Emissions (9 kHz ~ 30 MHz)

The low frequency, which started from 9 kHz to 30MHz, was pre-scanned and the result which was 20dB lower than the limit line per 15.31(o) was not reported.

3.2.6 Test Result of Radiated Spurious at Band Edges

Please refer to Appendix B.

3.2.7 Duty Cycle

Please refer to Appendix C.

3.2.8 Test Result of Radiated Spurious Emissions (30MHz ~ 10th Harmonic)

Please refer to Appendix B.



3.3 AC Conducted Emission Measurement

3.3.1 Limit of AC Conducted Emission

For equipment that is designed to be connected to the public utility (AC) power line, the radio frequency voltage that is conducted back onto the AC power line on any frequency or frequencies within the band 150 kHz to 30 MHz shall not exceed the limits in the following table.

Frequency of emission (MHz)	Conducted limit (dBµV)	
	Quasi-peak	Average
0.15-0.5	66 to 56*	56 to 46*
0.5-5	56	46
5-30	60	50

*Decreases with the logarithm of the frequency.

3.3.2 Measuring Instruments

The measuring equipment is listed in the section 4 of this test report.

3.3.3 Test Procedures

1. The EUT was placed 0.4 meter from the conducting wall of the shielding room was kept at least 80 centimeters from any other grounded conducting surface.
2. Connect EUT to the power mains through a line impedance stabilization network (LISN).
3. All the support units are connecting to the other LISN.
4. The LISN provides 50 ohm coupling impedance for the measuring instrument.
5. The FCC states that a 50 ohm, 50 microhenry LISN should be used.
6. Both sides of AC line were checked for maximum conducted interference.
7. The frequency range from 150 kHz to 30 MHz was searched.
8. Set the test-receiver system to Peak Detect Function and specified bandwidth with Maximum Hold Mode.

3.3.4 Test Setup

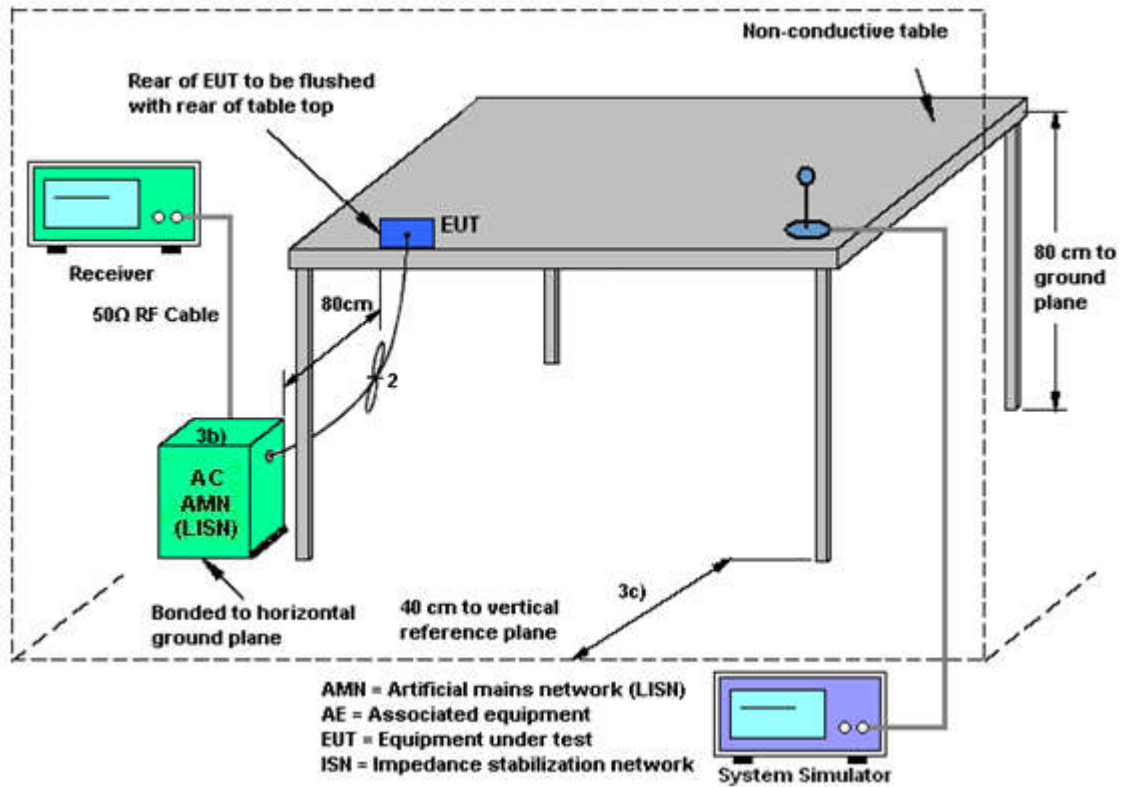



3.3.5 Test Result of AC Conducted Emission

Test Mode :	Mode 1	Temperature :	22~25°C
Test Engineer :	Lion Gao	Relative Humidity :	50~55%
Test Voltage :	120Vac / 60Hz	Phase :	Line
Function Type :	WCDMA Band II Idle + Bluetooth Link + WLAN Link (5G) + USB Cable (Charging from Adapter 2) + Earphone + Camera(Front)		

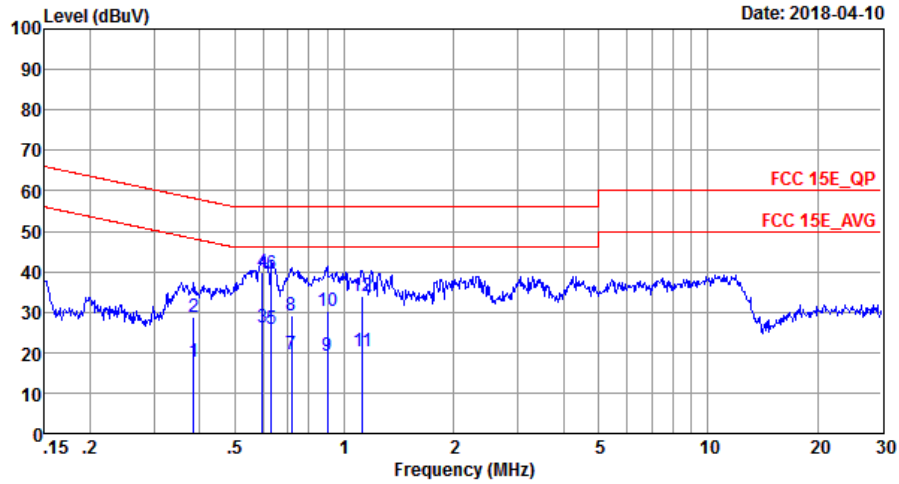

Site : CO01-SZ
 Condition: FCC 15E_QP LISN_20170907_L LINE

	Freq	Level	Over Limit	Limit Line	Read Level	LISN Factor	Cable Loss	Remark
	MHz	dBuV	dB	dBuV	dBuV	dB	dB	
1	0.39	17.71	-30.46	48.17	7.60	0.03	10.08	Average
2	0.39	28.71	-29.46	58.17	18.60	0.03	10.08	QP
3	0.59	26.20	-19.80	46.00	16.10	0.02	10.08	Average
4 *	0.59	39.70	-16.30	56.00	29.60	0.02	10.08	QP
5	0.63	26.00	-20.00	46.00	15.90	0.02	10.08	Average
6	0.63	39.60	-16.40	56.00	29.50	0.02	10.08	QP
7	0.72	19.60	-26.40	46.00	9.50	0.02	10.08	Average
8	0.72	29.30	-26.70	56.00	19.20	0.02	10.08	QP
9	0.90	19.24	-26.76	46.00	9.09	0.06	10.09	Average
10	0.90	30.34	-25.66	56.00	20.19	0.06	10.09	QP
11	1.12	20.27	-25.73	46.00	10.10	0.08	10.09	Average
12	1.12	33.97	-22.03	56.00	23.80	0.08	10.09	QP



Test Mode :	Mode 1	Temperature :	22~25°C
Test Engineer :	Lion Gao	Relative Humidity :	50~55%
Test Voltage :	120Vac / 60Hz	Phase :	Neutral
Function Type :	WCDMA Band II Idle + Bluetooth Link + WLAN Link (5G) + USB Cable (Charging from Adapter 2) + Earphone + Camera(Front)		

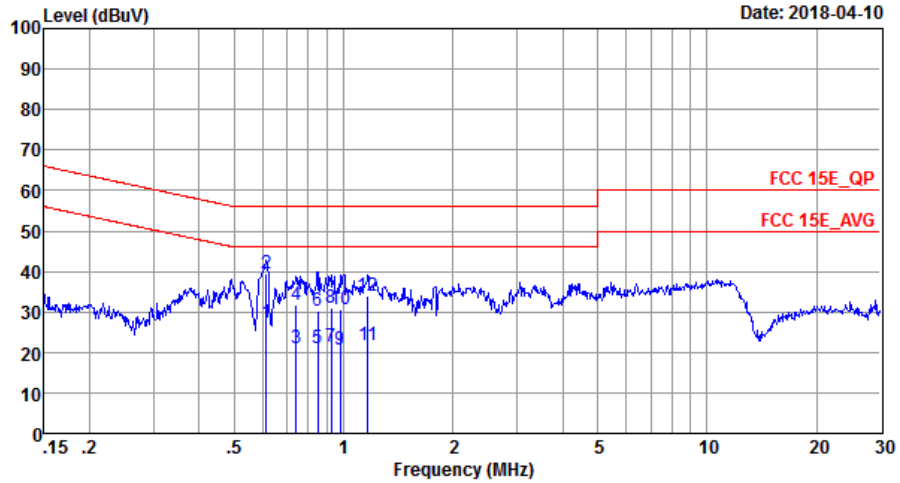

Site : C001-SZ
 Condition: FCC 15E_QP LISN_20170907_N NEUTRAL

	Freq	Level	Over Limit	Limit Line	Read Level	LISN Factor	Cable Loss	Remark
	MHz	dBuV	dB	dBuV	dBuV	dB	dB	
1	0.61	27.30	-18.70	46.00	17.20	0.02	10.08	Average
2 *	0.61	39.50	-16.50	56.00	29.40	0.02	10.08	QP
3	0.74	21.01	-24.99	46.00	10.91	0.02	10.08	Average
4	0.74	31.81	-24.19	56.00	21.71	0.02	10.08	QP
5	0.85	21.02	-24.98	46.00	10.89	0.04	10.09	Average
6	0.85	30.32	-25.68	56.00	20.19	0.04	10.09	QP
7	0.92	21.23	-24.77	46.00	11.10	0.04	10.09	Average
8	0.92	31.03	-24.97	56.00	20.90	0.04	10.09	QP
9	0.98	20.84	-25.16	46.00	10.70	0.05	10.09	Average
10	0.98	30.74	-25.26	56.00	20.60	0.05	10.09	QP
11	1.17	21.64	-24.36	46.00	11.50	0.05	10.09	Average
12	1.17	33.84	-22.16	56.00	23.70	0.05	10.09	QP



3.4 Automatically Discontinue Transmission

3.4.1 Limit of Automatically Discontinue Transmission

The device shall automatically discontinue transmission in case of either absence of information to transmit or operational failure. These provisions are not intended to preclude the transmission of control or signaling information or the use of repetitive codes used by certain digital technologies to complete frame or burst intervals. Applicants shall include in their application for equipment authorization to describe how this requirement is met.

3.4.2 Measuring Instruments

The measuring equipment is listed in the section 4 of this test report.

3.4.3 Test Result of Automatically Discontinue Transmission

While the EUT is not transmitting any information, the EUT can automatically discontinue transmission and become standby mode for power saving. The EUT can detect the controlling signal of ACK message transmitting from remote device and verify whether it shall resend or discontinue transmission.



3.5 Antenna Requirements

3.5.1 Standard Applicable

According to FCC 47 CFR Section 15.407(a)(1)(2) ,if transmitting antenna directional gain is greater than 6 dBi, both the peak transmit power and the peak power spectral density shall be reduced by the amount in dB that the directional gain of the antenna exceeds 6 dBi.

3.5.2 Antenna Anti-Replacement Construction

An embedded-in antenna design is used.

3.5.3 Antenna Gain

The antenna gain is less than 6 dBi. Therefore, it is not necessary to reduce maximum peak output power limit.



4 List of Measuring Equipment

Instrument	Manufacturer	Model No.	Serial No.	Characteristics	Calibration Date	Test Date	Due Date	Remark
Spectrum Analyzer	R&S	FSV40	101078	10Hz~40GHz	Apr. 20, 2017	Apr. 10, 2018	Apr. 19, 2018	Conducted (TH01-SZ)
Pulse Power Sensor	Anritsu	MA2411B	1207253	30MHz~40GHz	Dec. 26, 2017	Apr. 10, 2018	Dec. 25, 2018	Conducted (TH01-SZ)
Power Meter	Anritsu	ML2495A	1218010	50MHz Bandwidth	Dec. 26, 2017	Apr. 10, 2018	Dec. 25, 2018	Conducted (TH01-SZ)
EMI Test Receiver	R&S	ESR7	101404	9kHz~7GHz	Apr. 20, 2017	Apr. 12, 2018	Apr. 19, 2018	Radiation (03CH04-SZ)
EXA Spectrum Analyzer	KEYSIGHT	N9010A	MY55150213	10Hz~44GHz	Apr. 20, 2017	Apr. 12, 2018	Apr. 19, 2018	Radiation (03CH04-SZ)
Loop Antenna	R&S	HFH2-Z2	100354	9kHz~30MHz	May 14, 2017	Apr. 12, 2018	May 13, 2018	Radiation (03CH04-SZ)
Bilog Antenna	TeseQ	CBL6111D	41909	30MHz~1GHz	May 16, 2017	Apr. 12, 2018	May 15, 2018	Radiation (03CH04-SZ)
Double Ridge Horn Antenna	SCHWARZBECK	BBHA9120D	9120D-1285	1GHz~18GHz	Dec. 13, 2017	Apr. 12, 2018	Dec. 12, 2018	Radiation (03CH04-SZ)
Horn Antenna	SCHWARZBECK	BBHA9170	9170#679	15GHz~40GHz	May 17, 2017	Apr. 12, 2018	May 16, 2018	Radiation (03CH04-SZ)
Amplifier	Burgeon	BPA-530	102211	0.01Hz ~3000MHz	Oct. 19, 2017	Apr. 12, 2018	Oct. 18, 2018	Radiation (03CH04-SZ)
HF Amplifier	MITEQ	AMF-7D-001 01800-30-10 P-R	1989346	1GHz~18GHz	Jul. 27, 2017	Apr. 12, 2018	Jul. 26, 2018	Radiation (03CH04-SZ)
HF Amplifier	MITEQ	TTA1840-35- HG	1988315	18GHz~40GHz	Jul. 27, 2017	Apr. 12, 2018	Jul. 26, 2018	Radiation (03CH04-SZ)
Amplifier	Agilent Technologies	83017A	MY53270156	500MHz~26.5G Hz	Apr. 20, 2017	Apr. 12, 2018	Apr. 19, 2018	Radiation (03CH04-SZ)
AC Power Source	Chroma	61601	N/A	N/A	NCR	Apr. 12, 2018	NCR	Radiation (03CH04-SZ)
Turn Table	EM	EM1000	N/A	0~360 degree	NCR	Apr. 12, 2018	NCR	Radiation (03CH04-SZ)
Antenna Mast	EM	EM1000	N/A	1 m~4 m	NCR	Apr. 12, 2018	NCR	Radiation (03CH04-SZ)
EMI Receiver	R&S	ESR7	101630	9kHz~7GHz;	Dec. 26, 2017	Apr. 10, 2018	Dec. 25, 2018	Conduction (CO01-SZ)
AC LISN	EMCO	3816/2SH	00103912	9kHz~30MHz	Dec. 26, 2017	Apr. 10, 2018	Dec. 25, 2018	Conduction (CO01-SZ)
AC LISN (for auxiliary equipment)	MessTec	3816/2SH	00103892	9kHz~30MHz	Nov. 01, 2017	Apr. 10, 2018	Oct. 31, 2018	Conduction (CO01-SZ)
AC Power Source	Chroma	61602	6160200008 91	100Vac~250Vac	Jul. 19, 2017	Apr. 10, 2018	Jul. 18, 2018	Conduction (CO01-SZ)

NCR: No Calibration Required



5 Uncertainty of Evaluation

Uncertainty of Conducted Emission Measurement (150kHz ~ 30MHz)

Measuring Uncertainty for a Level of Confidence of 95% (U = 2Uc(y))	2.6dB
---	-------

Uncertainty of Radiated Emission Measurement (30 MHz ~ 1000 MHz)

Measuring Uncertainty for a Level of Confidence of 95% (U = 2Uc(y))	5.1dB
---	-------

Uncertainty of Radiated Emission Measurement (1000 MHz ~ 18000 MHz)

Measuring Uncertainty for a Level of Confidence of 95% (U = 2Uc(y))	4.8dB
---	-------

Uncertainty of Radiated Emission Measurement (18000 MHz ~ 40000 MHz)

Measuring Uncertainty for a Level of Confidence of 95% (U = 2Uc(y))	5.1dB
---	-------

Appendix A. Test Result of Conducted Test Items

Test Engineer:	Wilson Chen	Temperature:	21~25	°C
Test Date:	2018/4/10	Relative Humidity:	51~54	%

TEST RESULTS DATA
Average Power Table

Band IV										
Mod.	Data Rate	N _{TX}	CH.	Freq. (MHz)	Duty Factor (dB)	Average Conducted Power (dBm)	FCC Conducted Power Limit (dBm)	DG (dBi)		Pass/Fail
11a	6M bps	1	149	5745	0.58	17.60	30.00	-2.00		Pass
11a	6Mbps	1	157	5785	0.58	17.03	30.00	-2.00		Pass
11a	6Mbps	1	165	5825	0.58	16.51	30.00	-2.00		Pass
HT20	MCS 0	1	149	5745	0.64	17.59	30.00	-2.00		Pass
HT20	MCS 0	1	157	5785	0.64	17.01	30.00	-2.00		Pass
HT20	MCS 0	1	165	5825	0.64	16.49	30.00	-2.00		Pass
HT40	MCS 0	1	151	5755	1.18	17.56	30.00	-2.00		Pass
HT40	MCS 0	1	159	5795	1.18	16.88	30.00	-2.00		Pass



Appendix B. Radiated Spurious Emission

Band 4 - 5725~5850MHz WIFI 802.11a (Band Edge @ 3m)

WIFI	Note	Frequency	Level	Over	Limit	Read	Antenna	Cable	Preamp	Ant	Table	Peak	Pol.
Ant.				Limit	Line	Level	Factor	Loss	Factor	Pos	Pos	Avg.	
1		(MHz)	(dBμV/m)	(dB)	(dBμV/m)	(dBμV)	(dB/m)	(dB)	(dB)	(cm)	(deg)	(P/A)	(H/V)
802.11a CH 149 5745MHz		5600.2	53.39	-14.81	68.2	41.57	32.39	6.27	26.84	100	297	P	H
		5692.8	52.99	-46.9	99.89	41.19	32.45	6.23	26.88	100	297	P	H
		5712.6	60.06	-48.67	108.73	48.27	32.46	6.22	26.89	100	297	P	H
		5725	72.13	-50.07	122.2	60.32	32.48	6.22	26.89	100	297	P	H
	*	5745	102.25	-	-	90.46	32.49	6.2	26.9	100	297	P	H
	*	5745	94.59	-	-	82.8	32.49	6.2	26.9	100	297	A	H
		5607.6	52.45	-15.75	68.2	40.64	32.39	6.27	26.85	100	322	P	V
		5692.4	52.36	-47.24	99.6	40.56	32.45	6.23	26.88	100	322	P	V
		5718.8	63.96	-46.5	110.46	52.15	32.48	6.22	26.89	100	322	P	V
		5725	73.69	-48.51	122.2	61.88	32.48	6.22	26.89	100	322	P	V
	*	5745	105.07	-	-	93.28	32.49	6.2	26.9	100	322	P	V
	*	5745	97.59	-	-	85.8	32.49	6.2	26.9	100	322	A	V



WIFI Ant. 1	Note	Frequency (MHz)	Level (dBμV/m)	Over Limit (dB)	Limit Line (dBμV/m)	Read Level (dBμV)	Antenna Factor (dB/m)	Cable Loss (dB)	Preamp Factor (dB)	Ant Pos (cm)	Table Pos (deg)	Peak Avg. (P/A)	Pol. (H/V)
		5644.6	52.93	-15.27	68.2	41.14	32.4	6.25	26.86	100	296	P	H
		5651	51.99	-16.95	68.94	40.18	32.42	6.25	26.86	100	296	P	H
		5711.6	49.8	-58.65	108.45	38.01	32.46	6.22	26.89	100	296	P	H
		5721.6	49.78	-64.67	114.45	37.97	32.48	6.22	26.89	100	296	P	H
	*	5785	99.96	-	-	88.18	32.52	6.18	26.92	100	296	P	H
	*	5785	92.87	-	-	81.09	32.52	6.18	26.92	100	296	A	H
		5854.6	51.03	-60.68	111.71	39.08	32.6	6.29	26.94	100	296	P	H
		5872.8	52.16	-53.66	105.82	40.07	32.64	6.4	26.95	100	296	P	H
		5920.8	51.7	-19.6	71.3	39.43	32.72	6.52	26.97	100	296	P	H
		5928.4	52.1	-16.1	68.2	39.79	32.76	6.52	26.97	100	296	P	H
		5637	52.07	-16.13	68.2	40.28	32.4	6.25	26.86	100	316	P	V
		5661	52.89	-23.48	76.37	41.11	32.42	6.23	26.87	100	316	P	V
		5707.8	51.42	-55.97	107.39	39.63	32.46	6.22	26.89	100	316	P	V
		5725	51.17	-71.03	122.2	39.36	32.48	6.22	26.89	100	316	P	V
	*	5785	104.84	-	-	93.06	32.52	6.18	26.92	100	316	P	V
	*	5785	98.08	-	-	86.3	32.52	6.18	26.92	100	316	A	V
		5850.2	50.46	-71.28	121.74	38.53	32.58	6.29	26.94	100	316	P	V
		5856.4	51.15	-59.26	110.41	39.09	32.6	6.4	26.94	100	316	P	V
		5891.8	51.8	-40.93	92.73	39.68	32.68	6.4	26.96	100	316	P	V
		5942	51.73	-16.47	68.2	39.28	32.8	6.63	26.98	100	316	P	V



WiFi Ant. 1	Note	Frequency (MHz)	Level (dBμV/m)	Over Limit (dB)	Limit Line (dBμV/m)	Read Level (dBμV)	Antenna Factor (dB/m)	Cable Loss (dB)	Preamp Factor (dB)	Ant Pos (cm)	Table Pos (deg)	Peak Avg. (P/A)	Pol. (H/V)
802.11a CH 165 5825MHz	*	5825	100.34	-	-	88.41	32.57	6.29	26.93	106	297	P	H
	*	5825	93.33	-	-	81.4	32.57	6.29	26.93	106	297	A	H
		5851.6	55.19	-63.36	118.55	43.26	32.58	6.29	26.94	106	297	P	H
		5862.4	51.75	-56.98	108.73	39.7	32.6	6.4	26.95	106	297	P	H
		5878.8	52.82	-49.56	102.38	40.73	32.64	6.4	26.95	106	297	P	H
		5927.6	51.39	-16.81	68.2	39.08	32.76	6.52	26.97	106	297	P	H
	*	5825	104.08	-	-	92.15	32.57	6.29	26.93	101	316	P	V
	*	5825	97.94	-	-	86.01	32.57	6.29	26.93	101	316	A	V
		5850.6	56.71	-64.12	120.83	44.78	32.58	6.29	26.94	101	316	P	V
		5857.8	52.79	-57.22	110.01	40.74	32.6	6.4	26.95	101	316	P	V
		5923.2	53.07	-16.46	69.53	40.76	32.76	6.52	26.97	101	316	P	V
		5939.2	52.68	-15.52	68.2	40.23	32.8	6.63	26.98	101	316	P	V
Remark	1. No other spurious found. 2. All results are PASS against Peak and Average limit line.												



Band 4 5725~5850MHz

WIFI 802.11a (Harmonic @ 3m)

WIFI Ant. 1	Note	Frequency (MHz)	Level (dBμV/m)	Over Limit (dB)	Limit Line (dBμV/m)	Read Level (dBμV)	Antenna Factor (dB/m)	Cable Loss (dB)	Preamp Factor (dB)	Ant Pos (cm)	Table Pos (deg)	Peak Avg. (P/A)	Pol. (H/V)
802.11a CH 149 5745MHz		11490	50.53	-23.47	74	57.11	39.28	9.5	55.36	152	360	P	H
		17235	50.99	-17.21	68.2	49.55	43.04	14.89	56.49	149	0	P	H
		11490	49.44	-24.56	74	56.08	39.22	9.5	55.36	160	360	P	V
		17235	49.13	-19.07	68.2	49.24	41.49	14.89	56.49	170	360	P	V
802.11a CH 157 5785MHz		11570	49.24	-24.76	74	55.66	39.3	9.52	55.24	175	198	P	H
		17355	49.99	-18.21	68.2	47.64	43.81	15.12	56.58	189	185	P	H
		11570	49.91	-24.09	74	56.49	39.14	9.52	55.24	204	174	P	V
		17355	47.88	-20.32	68.2	47.1	42.24	15.12	56.58	105	79	P	V
802.11a CH 165 5825MHz		11650	49.91	-24.09	74	56.2	39.3	9.54	55.13	156	347	P	H
		17475	45.83	-22.37	68.2	42.57	44.58	15.36	56.68	150	360	P	H
		11650	49.62	-24.38	74	56.12	39.09	9.54	55.13	150	321	P	V
		17475	44.91	-23.29	68.2	43.24	42.99	15.36	56.68	143	311	P	V
Remark	1. No other spurious found. 2. All results are PASS against Peak and Average limit line.												



Band 4 5725~5850MHz
WIFI 802.11n HT20 (Band Edge @ 3m)

Table with 14 columns: WIFI Ant. 1, Note, Frequency (MHz), Level (dBµV/m), Over Limit (dB), Limit Line (dBµV/m), Read Level (dBµV), Antenna Factor (dB/m), Cable Loss (dB), Preamp Factor (dB), Ant Pos (cm), Table Pos (deg), Peak Avg. (P/A), Pol. (H/V). Rows include frequencies from 5605.2 to 5745 MHz with various test parameters.



WIFI Ant. 1	Note	Frequency (MHz)	Level (dBμV/m)	Over Limit (dB)	Limit Line (dBμV/m)	Read Level (dBμV)	Antenna Factor (dB/m)	Cable Loss (dB)	Preamp Factor (dB)	Ant Pos (cm)	Table Pos (deg)	Peak Avg. (P/A)	Pol. (H/V)
		5613.4	52.01	-16.19	68.2	40.2	32.39	6.27	26.85	100	290	P	H
		5680.4	51.42	-39.31	90.73	39.64	32.43	6.23	26.88	100	290	P	H
		5709	49.95	-57.77	107.72	38.16	32.46	6.22	26.89	100	290	P	H
		5721.8	50.03	-64.87	114.9	38.22	32.48	6.22	26.89	100	290	P	H
	*	5785	99.66	-	-	87.88	32.52	6.18	26.92	100	290	P	H
	*	5785	91.88	-	-	80.1	32.52	6.18	26.92	100	290	A	H
		5853.6	49.12	-64.87	113.99	37.17	32.6	6.29	26.94	100	290	P	H
		5868.4	52.4	-54.65	107.05	40.35	32.6	6.4	26.95	100	290	P	H
		5890.2	51.87	-42.05	93.92	39.75	32.68	6.4	26.96	100	290	P	H
		5925	51.43	-16.77	68.2	39.12	32.76	6.52	26.97	100	290	P	H
		5644.2	51.94	-16.26	68.2	40.15	32.4	6.25	26.86	100	316	P	V
		5657	51.19	-22.21	73.4	39.39	32.42	6.25	26.87	100	316	P	V
		5702.6	50.99	-54.94	105.93	39.19	32.46	6.22	26.88	100	316	P	V
		5721	50.95	-62.13	113.08	39.14	32.48	6.22	26.89	100	316	P	V
	*	5785	104.26	-	-	92.48	32.52	6.18	26.92	100	316	P	V
	*	5785	96.67	-	-	84.89	32.52	6.18	26.92	100	316	A	V
		5850.8	50.81	-69.57	120.38	38.88	32.58	6.29	26.94	100	316	P	V
		5858.2	51.31	-58.59	109.9	39.26	32.6	6.4	26.95	100	316	P	V
		5906.6	52.17	-29.61	81.78	39.89	32.72	6.52	26.96	100	316	P	V
		5943.2	51.61	-16.59	68.2	39.16	32.8	6.63	26.98	100	316	P	V



WIFI Ant. 1	Note	Frequency (MHz)	Level (dBμV/m)	Over Limit (dB)	Limit Line (dBμV/m)	Read Level (dBμV)	Antenna Factor (dB/m)	Cable Loss (dB)	Preamp Factor (dB)	Ant Pos (cm)	Table Pos (deg)	Peak Avg. (P/A)	Pol. (H/V)
802.11n HT20 CH 165 5825MHz	*	5825	98.75	-	-	86.82	32.57	6.29	26.93	100	290	P	H
	*	5825	91.05	-	-	79.12	32.57	6.29	26.93	100	290	A	H
		5850.4	54.44	-66.85	121.29	42.51	32.58	6.29	26.94	100	290	P	H
		5855.2	52.47	-58.27	110.74	40.52	32.6	6.29	26.94	100	290	P	H
		5892.2	52.36	-40.08	92.44	40.24	32.68	6.4	26.96	100	290	P	H
		5928.4	51.21	-16.99	68.2	38.9	32.76	6.52	26.97	100	290	P	H
	*	5825	103.79	-	-	91.86	32.57	6.29	26.93	100	316	P	V
	*	5825	95.88	-	-	83.95	32.57	6.29	26.93	100	316	A	V
		5850	60.28	-61.92	122.2	48.35	32.58	6.29	26.94	100	316	P	V
		5856.2	54.58	-55.88	110.46	42.52	32.6	6.4	26.94	100	316	P	V
		5877.4	52.35	-51.07	103.42	40.26	32.64	6.4	26.95	100	316	P	V
	5943.4	51.15	-17.05	68.2	38.7	32.8	6.63	26.98	100	316	P	V	
Remark	1. No other spurious found. 2. All results are PASS against Peak and Average limit line.												



Band 4 5725~5850MHz
WIFI 802.11n HT20 (Harmonic @ 3m)

WIFI Ant. 1	Note	Frequency (MHz)	Level (dBμV/m)	Over Limit (dB)	Limit Line (dBμV/m)	Read Level (dBμV)	Antenna Factor (dB/m)	Cable Loss (dB)	Preamp Factor (dB)	Ant Pos (cm)	Table Pos (deg)	Peak Avg. (P/A)	Pol. (H/V)
802.11n HT20		11490	50.44	-23.56	74	57.02	39.28	9.5	55.36	152	360	P	H
		17235	50.56	-17.64	68.2	49.12	43.04	14.89	56.49	149	21	P	H
CH 149 5745MHz		11490	49.78	-24.22	74	56.42	39.22	9.5	55.36	160	360	P	V
		17235	48.89	-19.31	68.2	49	41.49	14.89	56.49	170	360	P	V
802.11n HT20		11570	49.82	-24.18	74	56.24	39.3	9.52	55.24	175	198	P	H
		17355	49.47	-18.73	68.2	47.12	43.81	15.12	56.58	189	185	P	H
CH 157 5785MHz		11570	50.47	-23.53	74	57.05	39.14	9.52	55.24	201	311	P	V
		17355	47.98	-20.22	68.2	47.2	42.24	15.12	56.58	175	301	P	V
802.11n HT20		11650	50.18	-23.82	74	56.47	39.3	9.54	55.13	150	321	P	H
		17475	47.09	-21.11	68.2	43.83	44.58	15.36	56.68	143	311	P	H
CH 165 5825MHz		11650	49.54	-24.46	74	56.04	39.09	9.54	55.13	156	347	P	V
		17475	45.79	-22.41	68.2	44.12	42.99	15.36	56.68	150	360	P	V
Remark	1. No other spurious found. 2. All results are PASS against Peak and Average limit line.												



Band 4 5725~5850MHz
WIFI 802.11n HT40 (Band Edge @ 3m)

Table with 14 columns: WIFI Ant. 1, Note, Frequency (MHz), Level (dBµV/m), Over Limit (dB), Limit Line (dBµV/m), Read Level (dBµV), Antenna Factor (dB/m), Cable Loss (dB), Preamp Factor (dB), Ant Pos (cm), Table Pos (deg), Peak Avg. (P/A), Pol. (H/V). Rows include frequencies from 5627.8 to 5937.6 MHz.



WIFI Ant. 1	Note	Frequency (MHz)	Level (dBμV/m)	Over Limit (dB)	Limit Line (dBμV/m)	Read Level (dBμV)	Antenna Factor (dB/m)	Cable Loss (dB)	Preamp Factor (dB)	Ant Pos (cm)	Table Pos (deg)	Peak Avg. (P/A)	Pol. (H/V)
802.11n HT40 CH 159 5795MHz		5628	52.48	-15.72	68.2	40.69	32.39	6.25	26.85	101	303	P	H
		5656	51.8	-20.86	72.66	40	32.42	6.25	26.87	101	303	P	H
		5718.8	50.59	-59.87	110.46	38.78	32.48	6.22	26.89	101	303	P	H
		5720.8	49.85	-62.77	112.62	38.04	32.48	6.22	26.89	101	303	P	H
	*	5795	96.08	-	-	84.28	32.54	6.18	26.92	101	303	P	H
	*	5795	88.66	-	-	76.86	32.54	6.18	26.92	101	303	A	H
		5850.2	50.81	-70.93	121.74	38.88	32.58	6.29	26.94	101	303	P	H
		5858.4	51.14	-58.71	109.85	39.09	32.6	6.4	26.95	101	303	P	H
		5879	51.49	-50.74	102.23	39.4	32.64	6.4	26.95	101	303	P	H
		5933.8	51.34	-16.86	68.2	38.92	32.76	6.63	26.97	101	303	P	H
		5600.2	52.86	-15.34	68.2	41.04	32.39	6.27	26.84	100	28	P	V
		5690.2	52.11	-45.86	97.97	40.31	32.45	6.23	26.88	100	28	P	V
		5710.4	51.75	-56.36	108.11	39.96	32.46	6.22	26.89	100	28	P	V
		5724.8	51.01	-70.73	121.74	39.2	32.48	6.22	26.89	100	28	P	V
	*	5795	101.16	-	-	89.36	32.54	6.18	26.92	100	28	P	V
	*	5795	94.05	-	-	82.25	32.54	6.18	26.92	100	28	A	V
		5851.2	53.64	-65.82	119.46	41.71	32.58	6.29	26.94	100	28	P	V
		5855.4	52.3	-58.39	110.69	40.35	32.6	6.29	26.94	100	28	P	V
	5889.4	52.64	-41.87	94.51	40.52	32.68	6.4	26.96	100	28	P	V	
	5934.8	51.35	-16.85	68.2	38.94	32.76	6.63	26.98	100	28	P	V	
Remark	1. No other spurious found. 2. All results are PASS against Peak and Average limit line.												



Band 4 5725~5850MHz
WIFI 802.11n HT40 (Harmonic @ 3m)

WIFI Ant. 1	Note	Frequency (MHz)	Level (dBμV/m)	Over Limit (dB)	Limit Line (dBμV/m)	Read Level (dBμV)	Antenna Factor (dB/m)	Cable Loss (dB)	Preamp Factor (dB)	Ant Pos (cm)	Table Pos (deg)	Peak Avg. (P/A)	Pol. (H/V)
802.11n HT40		11510	49.4	-24.6	74	55.94	39.3	9.5	55.34	152	360	P	H
		17265	50.17	-18.03	68.2	48.46	43.26	14.97	56.52	170	319	P	H
CH 151 5755MHz		11510	49.36	-24.64	74	56	39.2	9.5	55.34	160	360	P	V
		17265	49.25	-18.95	68.2	49.09	41.71	14.97	56.52	170	360	P	V
802.11n HT40		11590	49.15	-24.85	74	55.53	39.3	9.53	55.21	170	300	P	H
		17385	48.7	-19.5	68.2	46.08	44.03	15.2	56.61	150	200	P	H
CH 159 5795MHz		11590	50.43	-23.57	74	56.98	39.13	9.53	55.21	150	343	P	V
		17385	48.1	-20.1	68.2	47.06	42.45	15.2	56.61	150	146	P	V
Remark	1. No other spurious found. 2. All results are PASS against Peak and Average limit line.												



Emission below 1GHz
5GHz WIFI 802.11a (LF @ 3m)

Table with 14 columns: WIFI, Note, Frequency, Level, Over, Limit, Read, Antenna, Cable, Preamp, Ant, Table, Peak, Pol. It contains 12 rows of test data for 5GHz WIFI 802.11a LF and a Remark section at the bottom.



Note symbol

*	Fundamental Frequency which can be ignored. However, the level of any unwanted emissions shall not exceed the level of the fundamental frequency.
!	Test result is over limit line.
P/A	Peak or Average
H/V	Horizontal or Vertical



A calculation example for radiated spurious emission is shown as below:

WIFI	Note	Frequency	Level	Over	Limit	Read	Antenna	Cable	Preamp	Ant	Table	Peak	Pol.
Ant.				Limit	Line	Level	Factor	Loss	Factor	Pos	Pos	Avg.	
2		(MHz)	(dBμV/m)	(dB)	(dBμV/m)	(dBμV)	(dB/m)	(dB)	(dB)	(cm)	(deg)	(P/A)	(H/V)
802.11b		2390	55.45	-18.55	74	54.51	32.22	4.58	35.86	103	308	P	H
CH 01													
2412MHz		2390	43.54	-10.46	54	42.6	32.22	4.58	35.86	103	308	A	H

- Level(dBμV/m) =
Antenna Factor(dB/m) + Cable Loss(dB) + Read Level(dBμV) - Preamp Factor(dB)
- Over Limit(dB) = Level(dBμV/m) – Limit Line(dBμV/m)

For Peak Limit @ 2390MHz:

- Level(dBμV/m)
= Antenna Factor(dB/m) + Cable Loss(dB) + Read Level(dBμV) - Preamp Factor(dB)
= 32.22(dB/m) + 4.58(dB) + 54.51(dBμV) – 35.86 (dB)
= 55.45 (dBμV/m)
- Over Limit(dB)
= Level(dBμV/m) – Limit Line(dBμV/m)
= 55.45(dBμV/m) – 74(dBμV/m)
= -18.55(dB)

For Average Limit @ 2390MHz:

- Level(dBμV/m)
= Antenna Factor(dB/m) + Cable Loss(dB) + Read Level(dBμV) - Preamp Factor(dB)
= 32.22(dB/m) + 4.58(dB) + 42.6(dBμV) – 35.86 (dB)
= 43.54 (dBμV/m)
- Over Limit(dB)
= Level(dBμV/m) – Limit Line(dBμV/m)
= 43.54(dBμV/m) – 54(dBμV/m)
= -10.46(dB)

Both peak and average measured complies with the limit line, so test result is “PASS”.



Appendix C. Duty Cycle Plots

Band	Duty Cycle(%)	T(ms)	1/T(kHz)	VBW Setting
802.11a	87.50	1.370	0.730	1kHz
802.11n HT20	86.27	1.275	0.784	1kHz
802.11n HT40	76.22	0.636	1.572	3kHz

802.11a

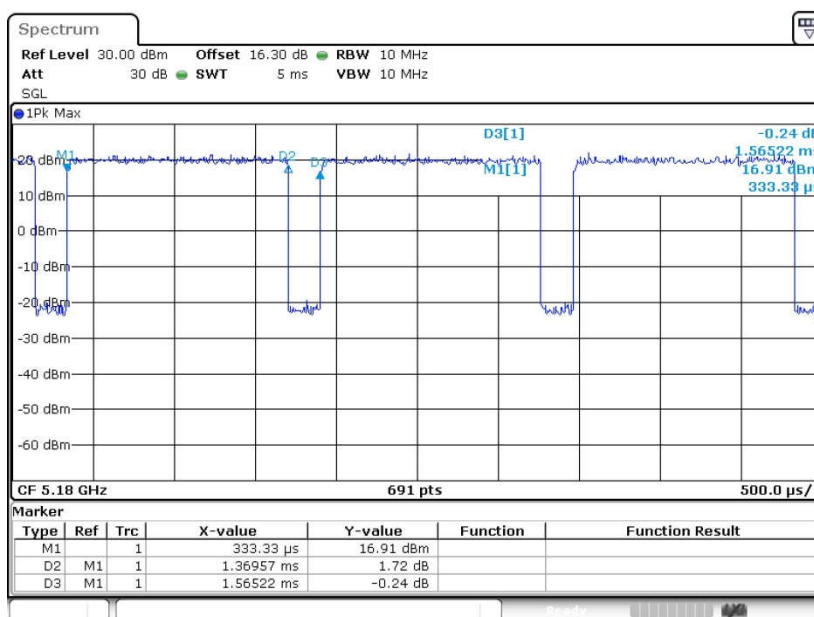



802.11n HT20

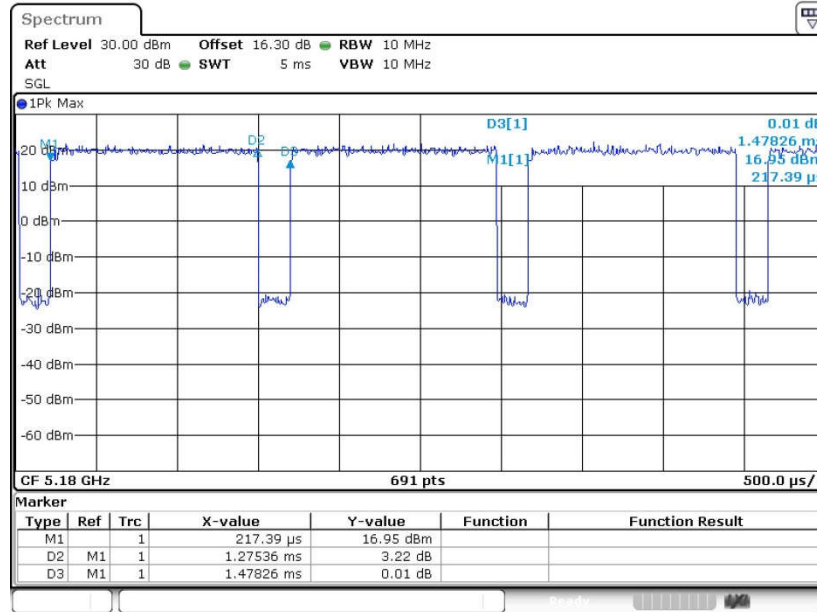

802.11n HT40

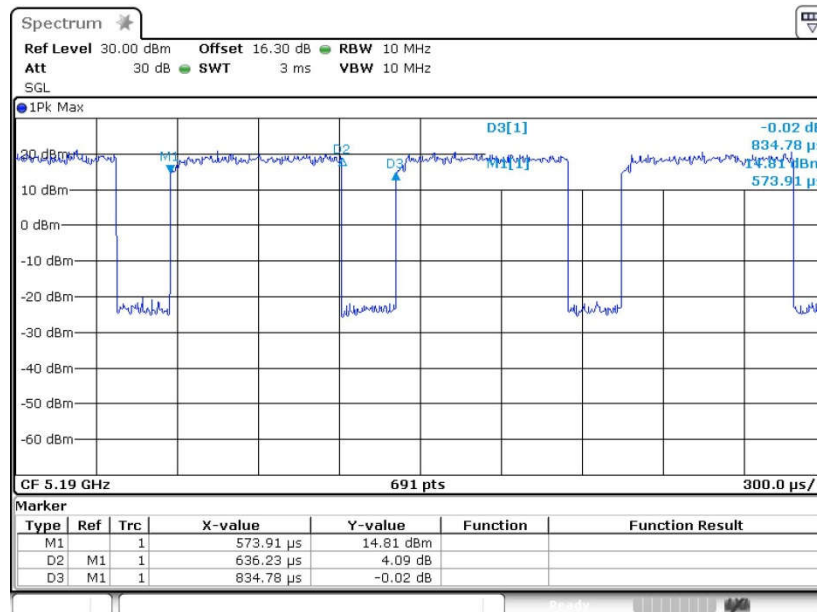



Appendix E. Reference Report

Please refer to Sporton report number FR7D1310E which is issued separately.