



# FCC RF Test Report

**APPLICANT** : Motorola Mobility LLC  
**EQUIPMENT** : Mobile Cellular Phone  
**BRAND NAME** : Motorola  
**MODEL NAME** : XT1929-1(SS)  
**FCC ID** : IHDT56XE2  
**STANDARD** : FCC Part 15 Subpart C §15.247  
**CLASSIFICATION** : (DTS) Digital Transmission System

The product was received on Jan. 18, 2018 and testing was completed on Mar. 03, 2018. We, SPORTON INTERNATIONAL INC., would like to declare that the tested sample has been evaluated in accordance with the test procedures and has been in compliance with the applicable technical standards.

The test results in this report apply exclusively to the tested model / sample. Without written approval of SPORTON INTERNATIONAL INC., the test report shall not be reproduced except in full.

Reviewed by: Joseph Lin / Supervisor

Approved by: Jones Tsai / Manager



## **SPORTON INTERNATIONAL INC.**

**No. 52, Hwa Ya 1<sup>st</sup> Rd., Hwa Ya Technology Park, Kwei-Shan District, Tao Yuan City, Taiwan, R.O.C.**

SPORTON INTERNATIONAL INC.

TEL : 886-3-327-3456

FAX : 886-3-328-4978

FCC ID: IHDT56XE2

Page Number : 1 of 34

Report Issued Date : Mar. 12, 2018

Report Version : Rev. 01

Report Template No.: BU5-FR15CWLAC MA Version 2.0



# TABLE OF CONTENTS

**REVISION HISTORY.....3**

**SUMMARY OF TEST RESULT .....4**

**1 GENERAL DESCRIPTION .....5**

    1.1 Applicant .....5

    1.2 Manufacturer.....5

    1.3 Product Feature of Equipment Under Test.....5

    1.4 Product Specification of Equipment Under Test.....6

    1.5 Modification of EUT .....6

    1.6 Testing Location .....7

    1.7 Applicable Standards.....7

**2 TEST CONFIGURATION OF EQUIPMENT UNDER TEST .....8**

    2.1 Carrier Frequency and Channel .....8

    2.2 Test Mode.....8

    2.3 Connection Diagram of Test System.....9

    2.4 Support Unit used in test configuration and system .....10

    2.5 EUT Operation Test Setup .....10

    2.6 Measurement Results Explanation Example.....10

**3 TEST RESULT.....11**

    3.1 6dB and 99% Bandwidth Measurement .....11

    3.2 Output Power Measurement.....13

    3.3 Power Spectral Density Measurement .....14

    3.4 Conducted Band Edges and Spurious Emission Measurement .....16

    3.5 Radiated Band Edges and Spurious Emission Measurement .....26

    3.6 AC Conducted Emission Measurement.....30

    3.7 Antenna Requirements .....32

**4 LIST OF MEASURING EQUIPMENT .....33**

**5 UNCERTAINTY OF EVALUATION .....34**

**APPENDIX A. CONDUCTED TEST RESULTS**

**APPENDIX B. AC CONDUCTED EMISSION TEST RESULT**

**APPENDIX C. RADIATED SPURIOUS EMISSION**

**APPENDIX D. RADIATED SPURIOUS EMISSION PLOTS**

**APPENDIX E. DUTY CYCLE PLOTS**





### SUMMARY OF TEST RESULT

Report Section	FCC Rule	Description	Limit	Result	Remark
3.1	15.247(a)(2)	6dB Bandwidth	$\geq 0.5\text{MHz}$	Pass	-
3.1	-	99% Bandwidth	-	Pass	-
3.2	15.247(b)	Power Output Measurement	$\leq 30\text{dBm}$	Pass	-
3.3	15.247(e)	Power Spectral Density	$\leq 8\text{dBm}/3\text{kHz}$	Pass	-
3.4	15.247(d)	Conducted Band Edges	$\leq 20\text{dBc}$	Pass	-
		Conducted Spurious Emission		Pass	-
3.5	15.247(d)	Radiated Band Edges and Radiated Spurious Emission	15.209(a) & 15.247(d)	Pass	Under limit 3.11 dB at 7386.000 MHz
3.6	15.207	AC Conducted Emission	15.207(a)	Pass	Under limit 13.84 dB at 0.263 MHz
3.7	15.203 & 15.247(b)	Antenna Requirement	N/A	Pass	-



# 1 General Description

## 1.1 Applicant

Motorola Mobility LLC  
222 W,Merchandise Mart Plaza, Chicago IL 60654 USA

## 1.2 Manufacturer

Motorola Mobility LLC  
222 W,Merchandise Mart Plaza, Chicago IL 60654 USA

## 1.3 Product Feature of Equipment Under Test

Product Feature	
Equipment	Mobile Cellular Phone
Brand Name	Motorola
Model Name	XT1929-1(SS)
FCC ID	IHDT56XE2
IMEI Code	<b>Conducted :</b> IMEI: 351885090004200 <b>Conduction :</b> IMEI: 351885090010991 <b>Radiation :</b> IMEI: 351885090010702
EUT supports Radios application	CDMA/EV-DO/GSM/EGPRS/WCDMA/HSPA/LTE/GNSS/NFC WLAN 11b/g/n HT20 WLAN 11a/n HT20/HT40 WLAN 11ac VHT20/VHT40/VHT80 Bluetooth BR/EDR/LE
HW Version	DVT2
EUT Stage	Identical Prototype

**Remark:** The above EUT's information was declared by manufacturer. Please refer to the specifications or user's manual for more detailed description.



Accessory List	
AC Adapter 1	Brand Name : Motorola
	Model Name : SC-22 SPN5970A
	Manufacturer : Salom
AC Adapter 2	Brand Name : Motorola
	Model Name : SC-22 SPN5993A
	Manufacturer : Chenyang
Battery	Brand Name : Motorola
	Model Name : JS40
	Manufacturer : SUNWODA
C2Audio Cable 1	Brand Name : Motorola
	Model Name : SC18C27844
	Manufacturer : Luxshare
C2Audio Cable 2	Brand Name : Motorola
	Model Name : SC18C27845
	Manufacturer : Cabletech
USB Cable 1	Brand Name : Cabletech
	Model Name : SKN6473A
USB Cable 2	Brand Name : FOXLINK
	Model Name : SKN6473A 17195-C 0403532
USB Cable 3	Brand Name : SAIBAO
	Model Name : SKN6473A 17214-C 1127044
USB Cable 4	Brand Name : Luxshare
	Model Name : SKN6473A 17227-C 1126538

### 1.4 Product Specification of Equipment Under Test

Standards-related Product Specification	
Tx/Rx Channel Frequency Range	2412 MHz ~ 2462 MHz
Maximum (Peak) Output Power to antenna	802.11b : 21.65 dBm (0.1462 W) 802.11g : 21.76 dBm (0.1500 W) 802.11n HT20 : 21.76 dBm (0.1500 W)
Antenna Type / Gain	Loop Antenna with gain -5.0 dBi
Type of Modulation	802.11b : DSSS (DBPSK / DQPSK / CCK) 802.11g/n : OFDM (BPSK / QPSK / 16QAM / 64QAM)

### 1.5 Modification of EUT

No modifications are made to the EUT during all test items.



### 1.6 Testing Location

Sporton Lab is accredited to ISO 17025 by Taiwan Accreditation Foundation (TAF code : 1190) and the FCC designation No. TW1190 and TW0007 under the FCC 2.948(e) by Mutual Recognition Agreement (MRA) in FCC Test.

<b>Test Site</b>	SPORTON INTERNATIONAL INC.	
<b>Test Site Location</b>	No. 52, Hwa Ya 1 <sup>st</sup> Rd., Hwa Ya Technology Park, Kwei-Shan District, Tao Yuan City, Taiwan, R.O.C. TEL: +886-3-327-3456 FAX: +886-3-328-4978	
<b>Test Site No.</b>	<b>Sporton Site No.</b>	
	TH05-HY	CO05-HY

**Note:** The test site complies with ANSI C63.4 2014 requirement.

<b>Test Site</b>	SPORTON INTERNATIONAL INC.	
<b>Test Site Location</b>	No.58, Aly. 75, Ln. 564, Wenhua 3rd Rd. Guishan Dist, Taoyuan City, Taiwan (R.O.C.) TEL: +886-3-327-3456 FAX: +886-3-328-4978	
<b>Test Site No.</b>	<b>Sporton Site No.</b>	
	03CH12-HY	

**Note:** The test site complies with ANSI C63.4 2014 requirement.

### 1.7 Applicable Standards

According to the specifications of the manufacturer, the EUT must comply with the requirements of the following standards:

- ♦ FCC Part 15 Subpart C §15.247
- ♦ FCC KDB Publication No. 558074 D01 DTS Meas. Guidance v04
- ♦ ANSI C63.10-2013

**Remark:**

1. All test items were verified and recorded according to the standards and without any deviation during the test.
2. This EUT has also been tested and complied with the requirements of FCC Part 15, Subpart B, recorded in a separate test report.



## 2 Test Configuration of Equipment Under Test

- a. The EUT has been associated with peripherals and configuration operated in a manner tended to maximize its emission characteristics in a typical application. Frequency range investigated: conduction emission (150 kHz to 30 MHz), radiation emission (9 kHz to the 10th harmonic of the highest fundamental frequency or to 40 GHz, whichever is lower). For radiated measurement, pre-scanned in three orthogonal panels, X, Y, Z. The worst cases (Z plane) were recorded in this report.
- b. AC power line Conducted Emission was tested under maximum output power.

### 2.1 Carrier Frequency and Channel

Frequency Band	Channel	Freq. (MHz)	Channel	Freq. (MHz)
2400-2483.5 MHz	1	2412	7	2442
	2	2417	8	2447
	3	2422	9	2452
	4	2427	10	2457
	5	2432	11	2462
	6	2437		

### 2.2 Test Mode

Final test modes are considering the modulation and worse data rates as below table.

Modulation	Data Rate
802.11b	1 Mbps
802.11g	6 Mbps
802.11n HT20	MCS0

Test Cases	
AC Conducted Emission	Mode 1 :GSM850 Idle + Bluetooth Link + WLAN (2.4GHz) Link + MP3 + Battery + USB Cable 1 Type C (Charging from Adapter 1)
<b>Remark:</b> For Radiated Test Cases, The tests were performance with Adapter 1, and USB Cable 1 Type C.	



## 2.3 Connection Diagram of Test System

<EUT with Adapter>

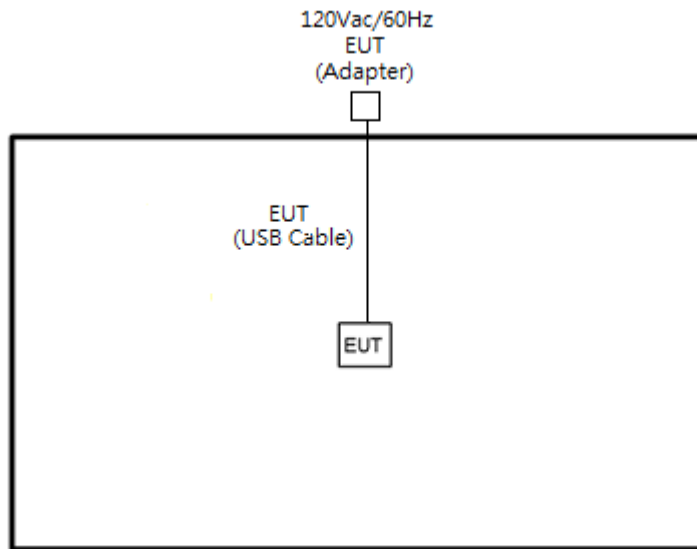

<AC Conducted Emission Mode>

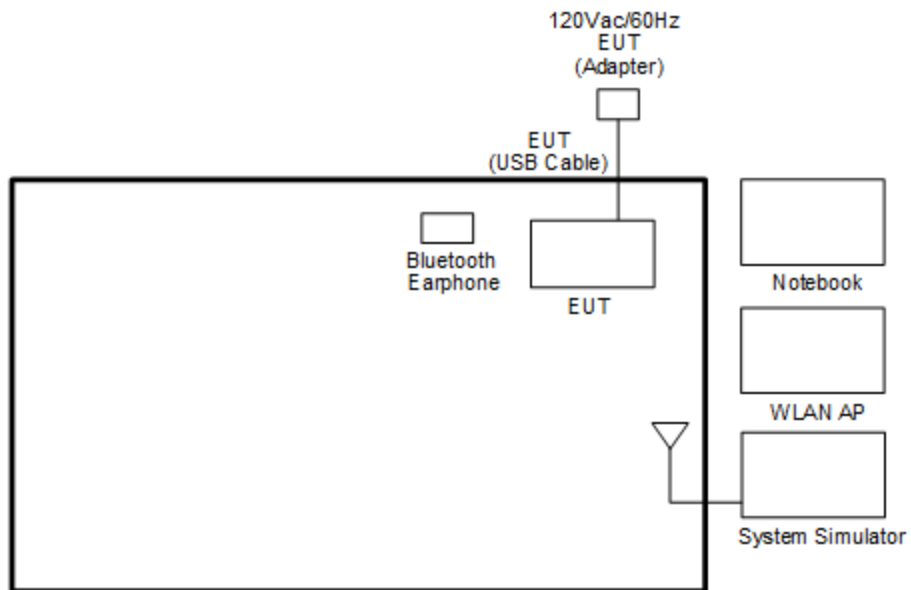



## 2.4 Support Unit used in test configuration and system

Item	Equipment	Trade Name	Model Name	FCC ID	Data Cable	Power Cord
1.	System Simulator	Anritsu	MT8820C	N/A	N/A	Unshielded, 1.8 m
2.	WLAN AP	ASUS	RT-AC66U	KA2DIR628A2	N/A	Unshielded, 1.8 m
3.	Notebook	DELL	Latitude E6320	FCC DoC/ Contains FCC ID: QDS-BRCM1054	N/A	AC I/P: Unshielded, 1.2 m DC O/P: Shielded, 1.8 m
4.	Notebook	Lenovo	E335	FCC DoC	N/A	AC I/P: Unshielded, 1.2 m DC O/P: Shielded, 1.8 m
5.	SD Card	SanDisk	MicroSD HC	FCC DoC	N/A	N/A
6.	Bluetooth Earphone	Lenovo	LBH 301	PYAHS-107W	N/A	N/A

## 2.5 EUT Operation Test Setup

The RF test items, utility “QRCT” was installed in Notebook which was programmed in order to make the EUT get into the engineering modes to provide channel selection, power level, data rate and the application type and for continuous transmitting signals.

## 2.6 Measurement Results Explanation Example

**For all conducted test items:**

The offset level is set in the spectrum analyzer to compensate the RF cable loss and attenuator factor between EUT conducted output port and spectrum analyzer. With the offset compensation, the spectrum analyzer reading level is exactly the EUT RF output level.

Example:

The spectrum analyzer offset is derived from RF cable loss and attenuator factor.

*Offset = RF cable loss + attenuator factor.*

Following shows an offset computation example with cable loss 4.2 dB and 10dB attenuator.

*Offset(dB) = RF cable loss(dB) + attenuator factor(dB).*

*= 4.2 + 10 = 14.2 (dB)*

### 3 Test Result

#### 3.1 6dB and 99% Bandwidth Measurement

##### 3.1.1 Limit of 6dB and 99% Bandwidth

The minimum 6 dB bandwidth shall be at least 500 kHz.

##### 3.1.2 Measuring Instruments

The measuring equipment is listed in the section 4 of this test report.

##### 3.1.3 Test Procedures

1. The testing follows FCC KDB Publication No. 558074 DTS D01 Meas. Guidance v04.
2. The RF output of EUT was connected to the spectrum analyzer by RF cable and attenuator. The path loss was compensated to the results for each measurement.
3. Set to the maximum power setting and enable the EUT transmit continuously.
4. Make the measurement with the spectrum analyzer's resolution bandwidth (RBW) = 100 kHz. Set the Video bandwidth (VBW) = 300 kHz. In order to make an accurate measurement. The 6 dB bandwidth must be greater than 500 kHz.
5. For 99% Bandwidth Measurement, the spectrum analyzer's resolution bandwidth (RBW) = 1MHz and set the Video bandwidth (VBW) = 3MHz.
6. Measure and record the results in the test report.

##### 3.1.4 Test Setup

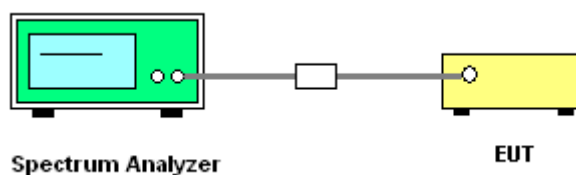



### 3.1.5 Test Result of 6dB and 99% Occupied Bandwidth

Please refer to Appendix A.

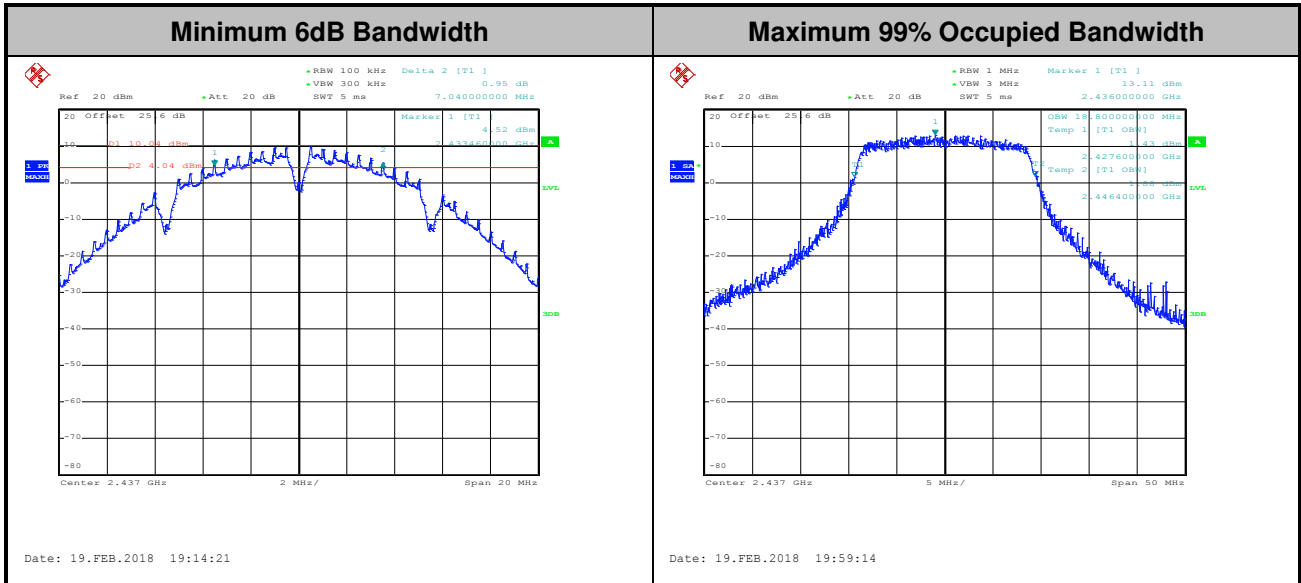

Note : The occupied channel bandwidth is maintained within the band of operation for all of the modulations.

## 3.2 Output Power Measurement

### 3.2.1 Limit of Output Power

For systems using digital modulation in the 2400-2483.5MHz, the limit for peak output power is 30dBm. If transmitting antenna with directional gain greater than 6dBi is used, the peak output power from the intentional radiator shall be reduced below the above stated value by the amount in dB that the directional gain of the antenna exceeds 6 dBi. In case of point-to-point operation, the limit has to be reduced by 1dB for every 3dB that the directional gain of the antenna exceeds 6dBi.

### 3.2.2 Measuring Instruments

The measuring equipment is listed in the section 4 of this test report.

### 3.2.3 Test Procedures

1. The testing follows the Measurement Procedure of FCC KDB No. 558074 DTS D01 Meas. Guidance v04 section 9.1.3 PKPM1 Peak power meter method.
2. The RF output of EUT was connected to the power meter by RF cable and attenuator. The path loss was compensated to the results for each measurement.
3. Set to the maximum power setting and enable the EUT transmit continuously.
4. Measure the conducted output power and record the results in the test report.

### 3.2.4 Test Setup

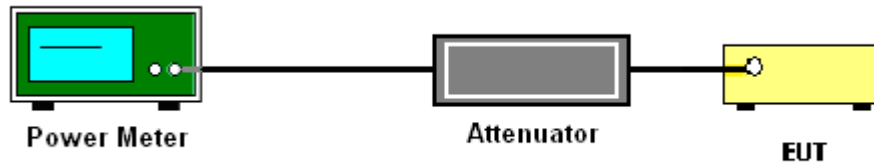

### 3.2.5 Test Result of Peak Output Power

Please refer to Appendix A.

### 3.2.6 Test Result of Average output Power (Reporting Only)

Please refer to Appendix A.

### 3.3 Power Spectral Density Measurement

#### 3.3.1 Limit of Power Spectral Density

The peak power spectral density shall not be greater than 8dBm in any 3kHz band at any time interval of continuous transmission.

#### 3.3.2 Measuring Instruments

The measuring equipment is listed in the section 4 of this test report.

#### 3.3.3 Test Procedures

1. The testing follows Measurement Procedure 10.2 Method PKPSD of FCC KDB Publication No. 558074 D01 DTS Meas. Guidance v04
2. The RF output of EUT was connected to the spectrum analyzer by RF cable and attenuator. The path loss was compensated to the results for each measurement.
3. Set to the maximum power setting and enable the EUT transmit continuously.
4. Make the measurement with the spectrum analyzer's resolution bandwidth (RBW) = 3 kHz. Video bandwidth VBW = 10 kHz In order to make an accurate measurement, set the span to 1.5 times DTS Channel Bandwidth. (6dB BW)
5. Detector = peak, Sweep time = auto couple, Trace mode = max hold, Allow trace to fully stabilize. Use the peak marker function to determine the maximum power level.
6. Measure and record the results in the test report.

#### 3.3.4 Test Setup





### 3.3.5 Test Result of Power Spectral Density

Please refer to Appendix A.

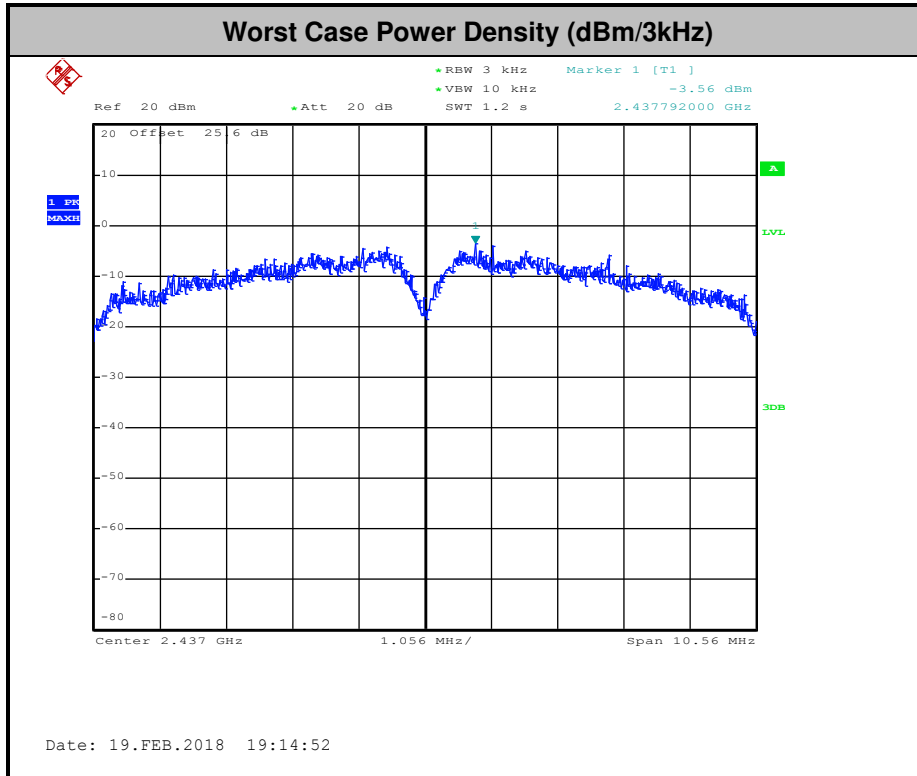

## 3.4 Conducted Band Edges and Spurious Emission Measurement

### 3.4.1 Limit of Conducted Band Edges and Spurious Emission Measurement

In any 100 kHz bandwidth outside of the authorized frequency band, the emissions which fall in the non-restricted bands shall be attenuated at least 20 dB / 30dB relative to the maximum PSD level in 100 kHz by RF conducted measurement.

### 3.4.2 Measuring Instruments

The measuring equipment is listed in the section 4 of this test report.

### 3.4.3 Test Procedures

1. The testing follows FCC KDB Publication No. 558074 D01 DTS Meas. Guidance v04.
2. The RF output of EUT was connected to the spectrum analyzer by RF cable and attenuator. The path loss was compensated to the results for each measurement.
3. Set to the maximum power setting and enable the EUT transmit continuously.
4. Set RBW = 100 kHz, VBW=300 kHz, Peak Detector. Unwanted Emissions measured in any 100 kHz bandwidth outside of the authorized frequency band shall be attenuated by at least 20 dB relative to the maximum in-band peak PSD level in 100 kHz when maximum peak conducted output power procedure is used. If the transmitter complies with the conducted power limits based on the use of RMS averaging over a time interval, the attenuation required under this paragraph shall be 30 dB instead of 20 dB per 15.247(d).
5. Measure and record the results in the test report.
6. The RF fundamental frequency should be excluded against the limit line in the operating frequency band.

### 3.4.4 Test Setup







### 3.4.5 Test Result of Conducted Band Edges and Spurious Emission

Test Engineer : White Lin and Luffy Lin	Temperature :	21~25°C
	Relative Humidity :	54~51%

Number of TX = 1, Ant. 1 (Measured)

Test Mode :	802.11b	Test Channel :	01
-------------	---------	----------------	----

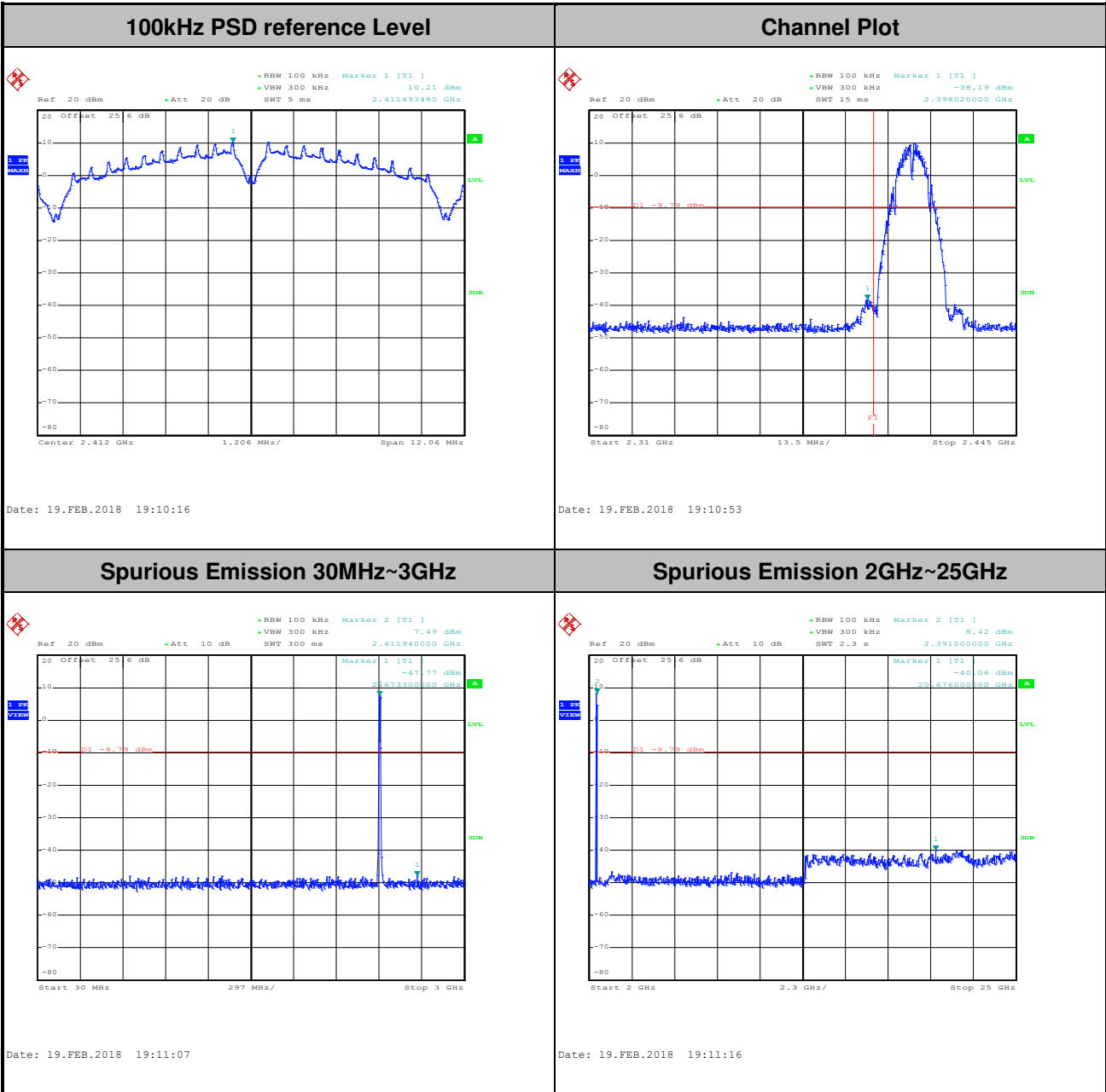



Test Mode :	802.11b	Test Channel :	06
-------------	---------	----------------	----

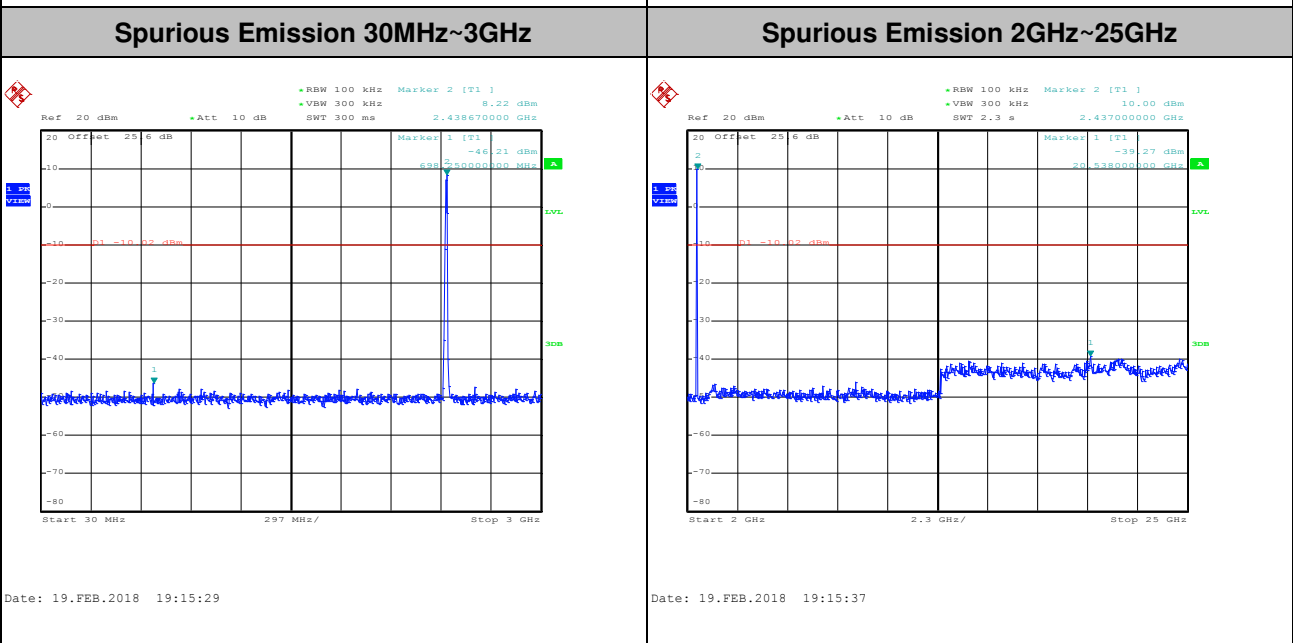
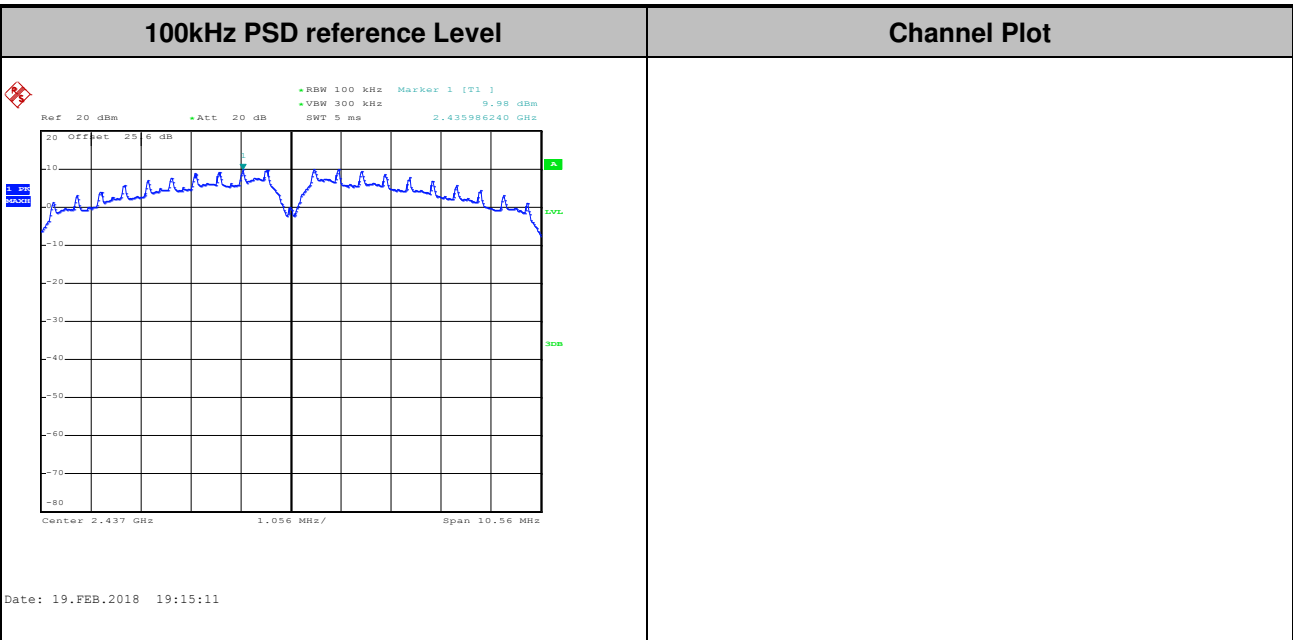



Test Mode :	802.11b	Test Channel :	11
-------------	---------	----------------	----

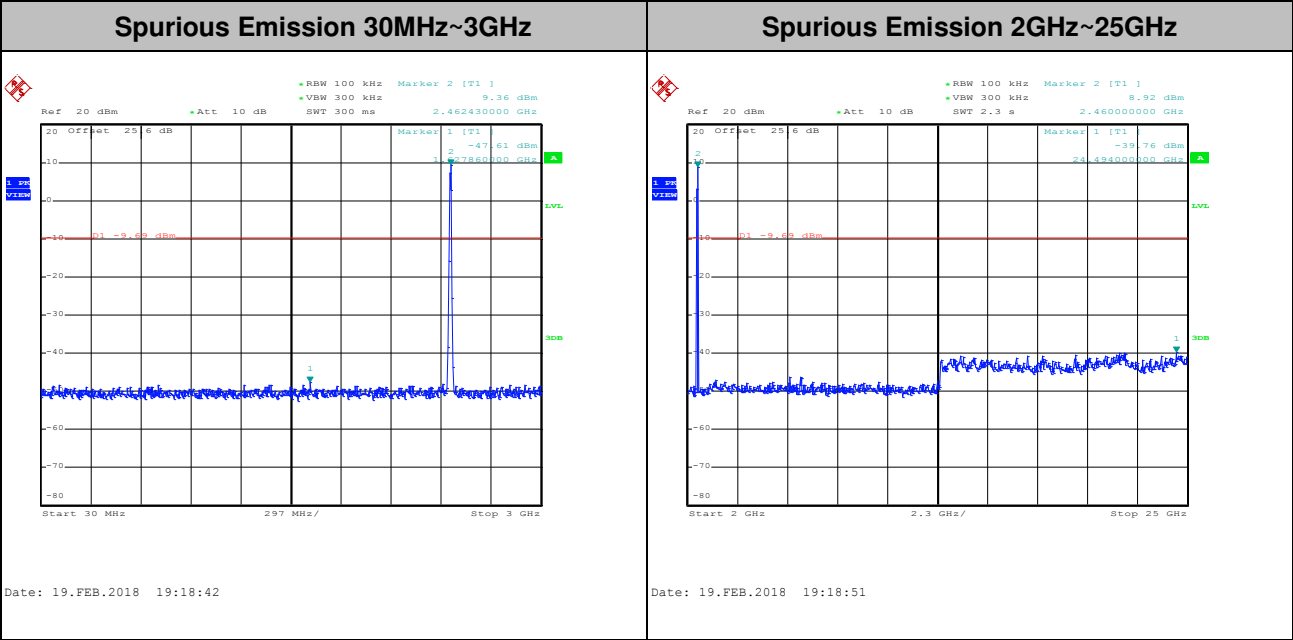
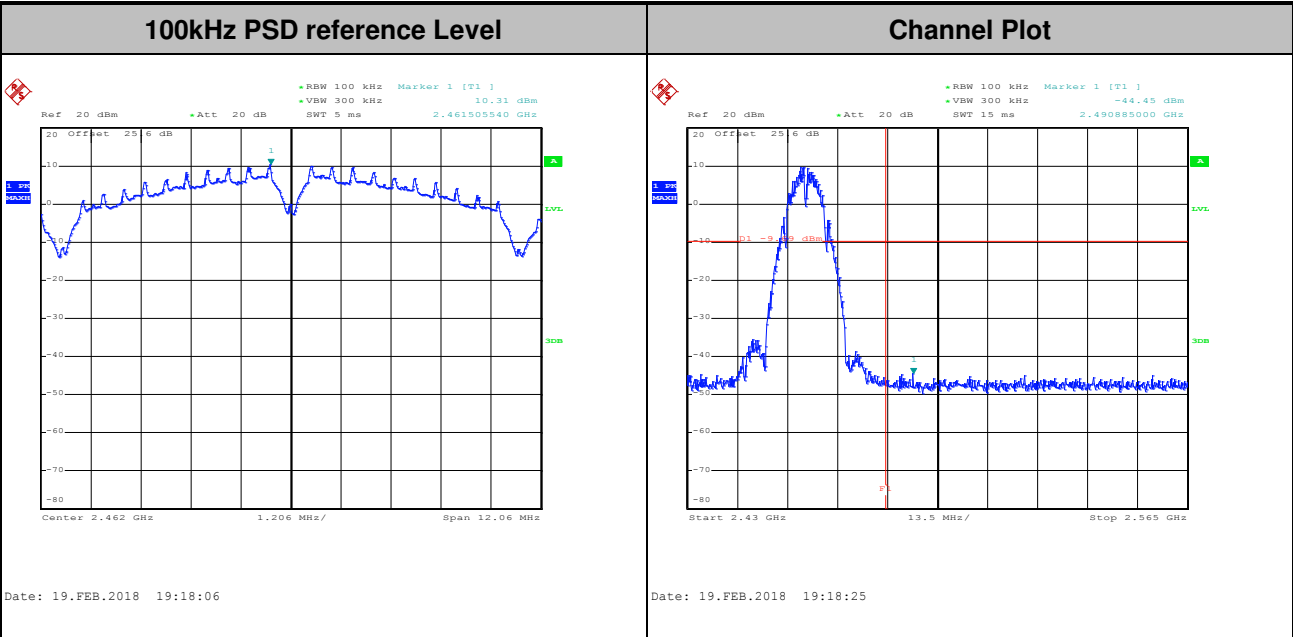



Test Mode : 802.11g Test Channel : 01

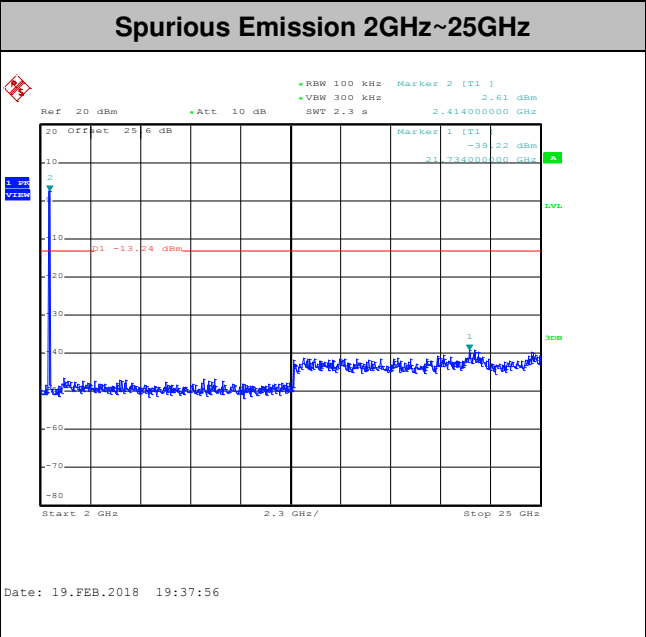
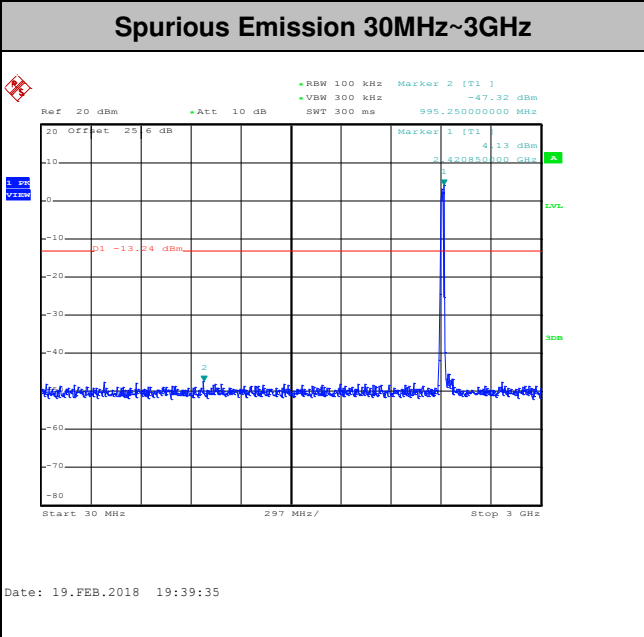
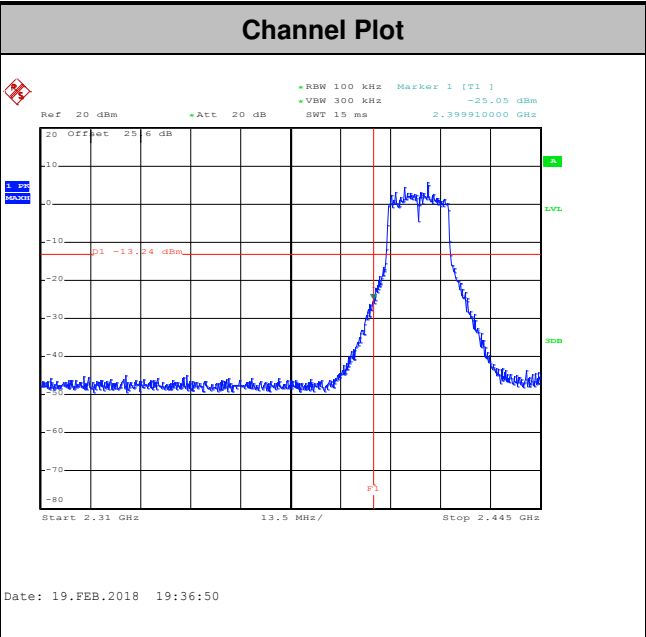
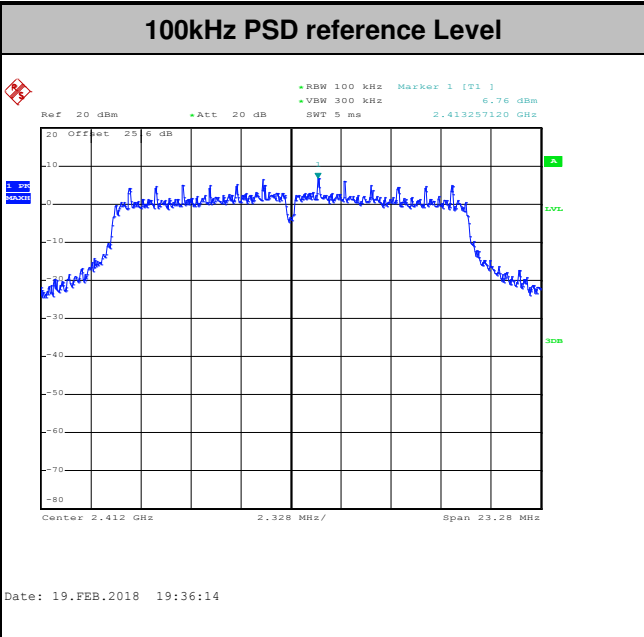



Test Mode :	802.11g	Test Channel :	06
-------------	---------	----------------	----

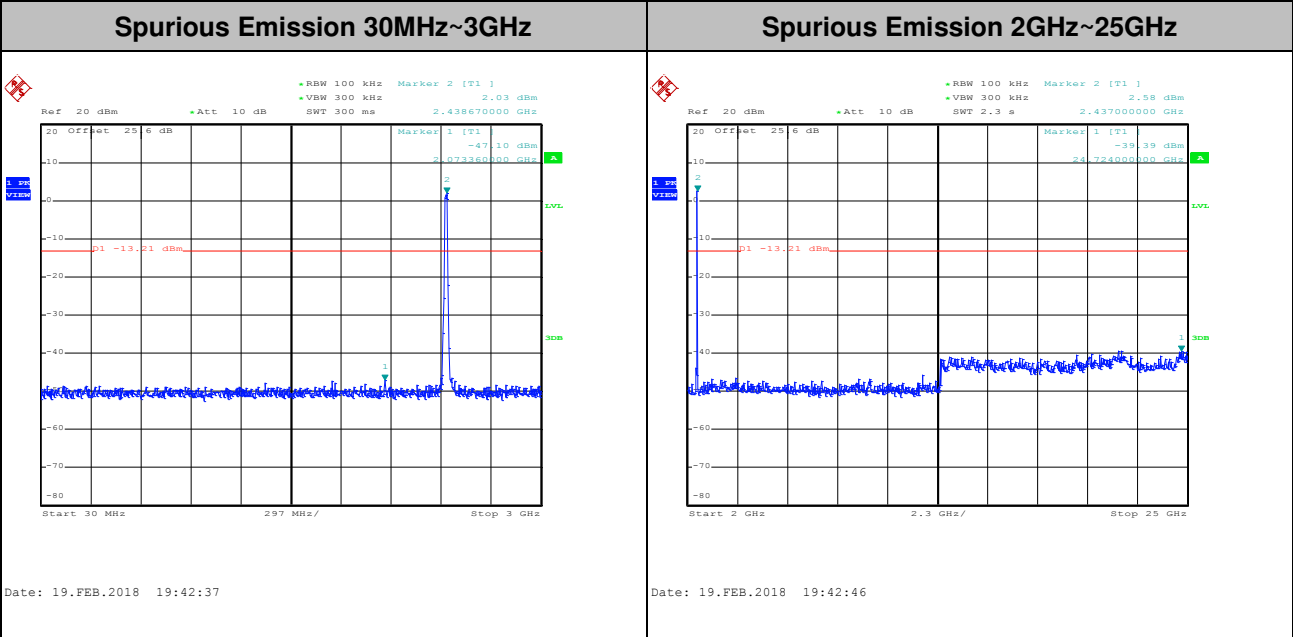
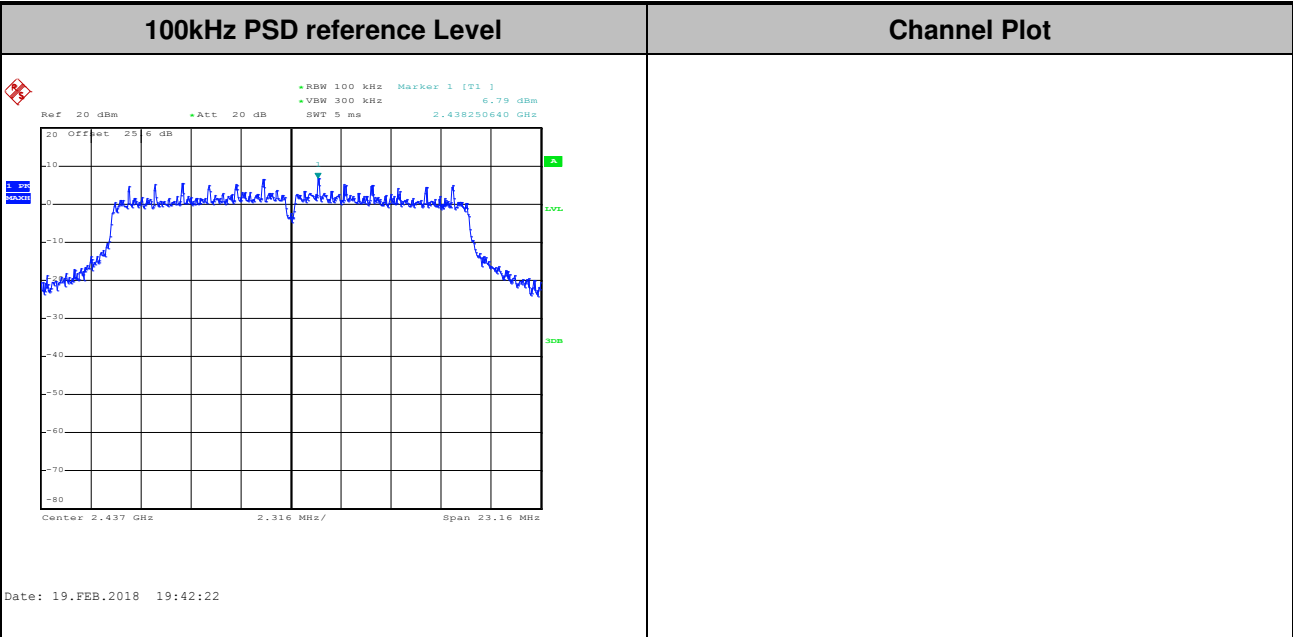



Test Mode :	802.11g	Test Channel :	11
-------------	---------	----------------	----

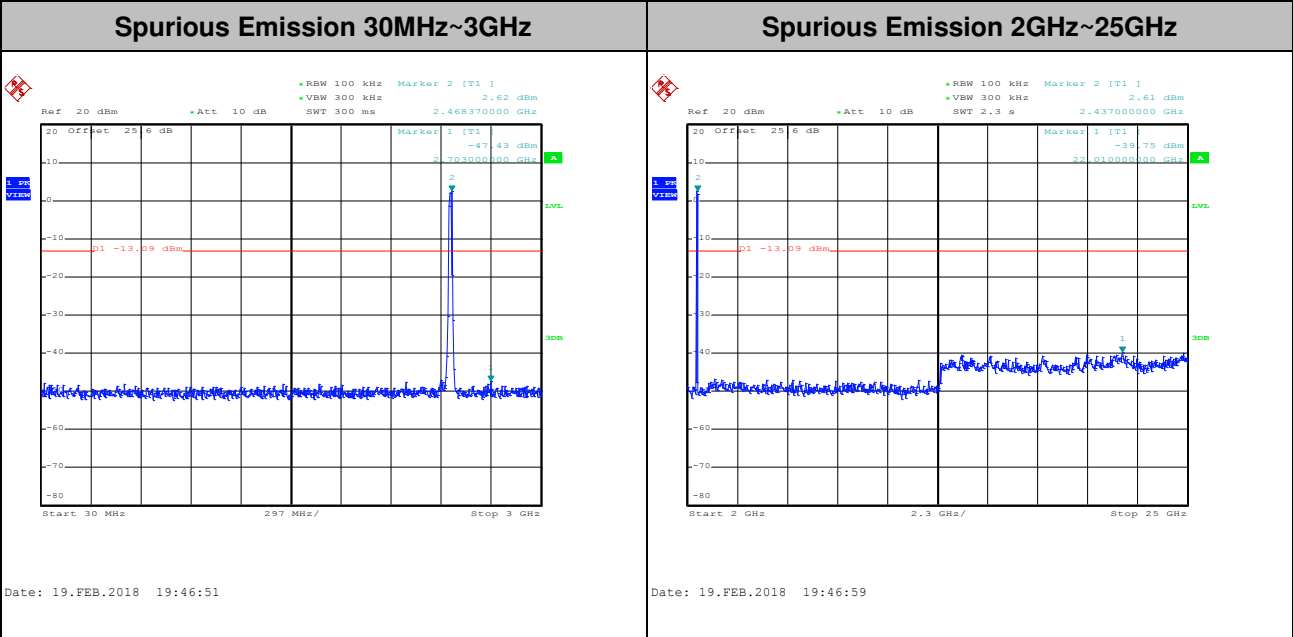
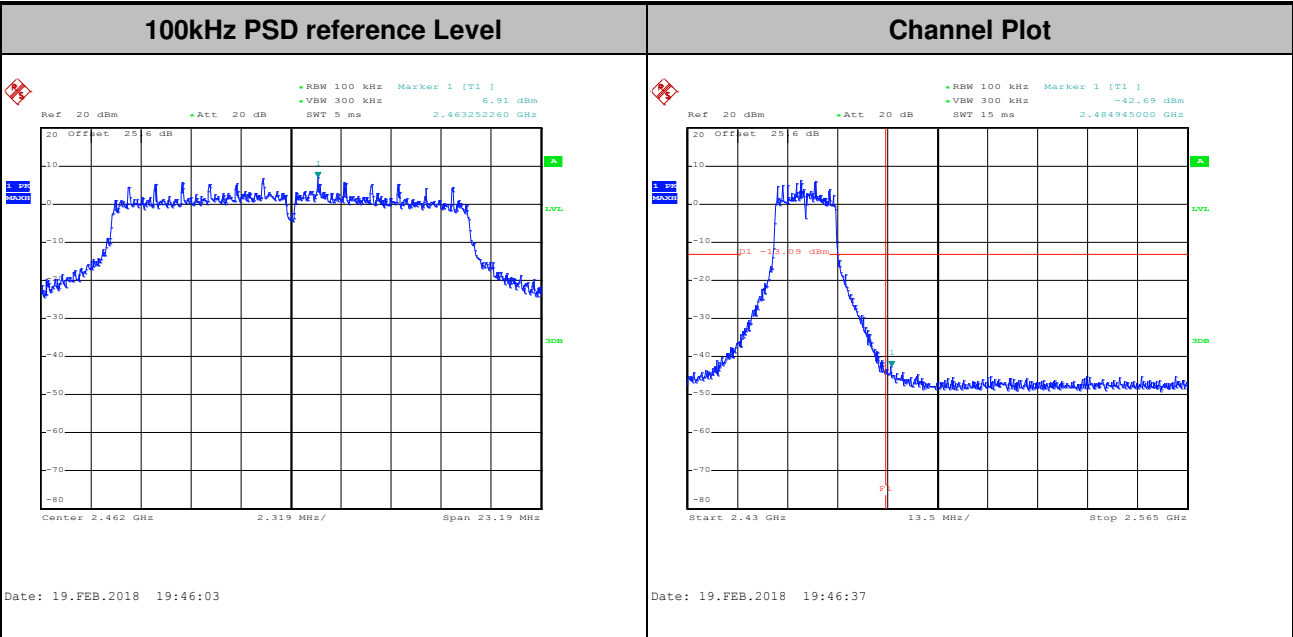



Test Mode : 802.11n HT20 Test Channel : 01

100kHz PSD reference Level

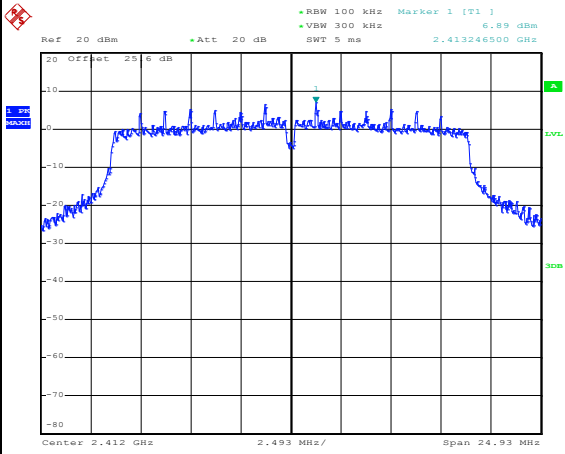

Date: 19.FEB.2018 19:49:59

Channel Plot

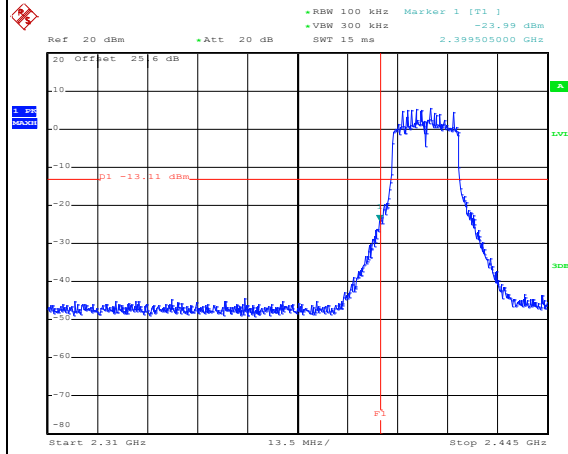

Date: 19.FEB.2018 19:50:22

Spurious Emission 30MHz~3GHz

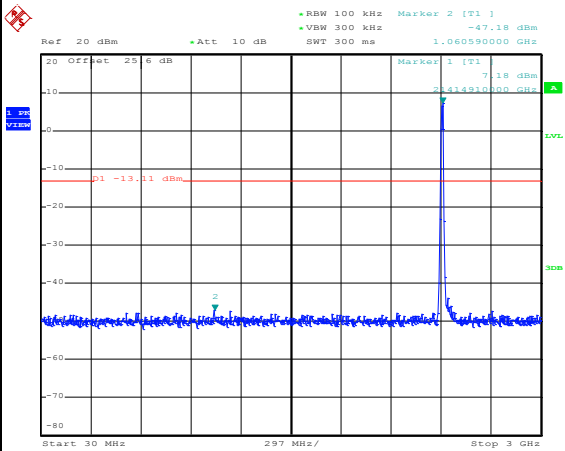

Date: 19.FEB.2018 19:52:56

Spurious Emission 2GHz~25GHz

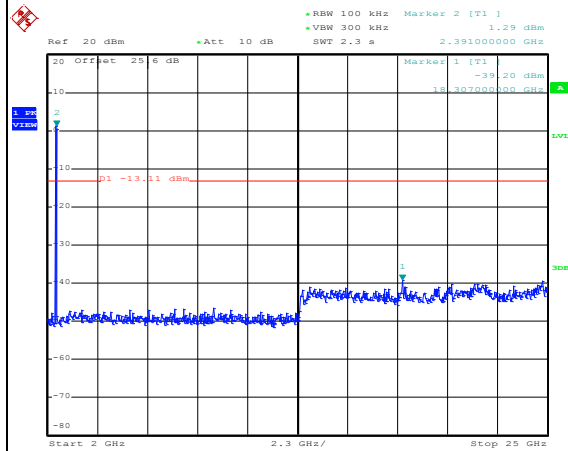

Date: 19.FEB.2018 19:51:25



Test Mode :	802.11n HT20	Test Channel :	06
-------------	--------------	----------------	----

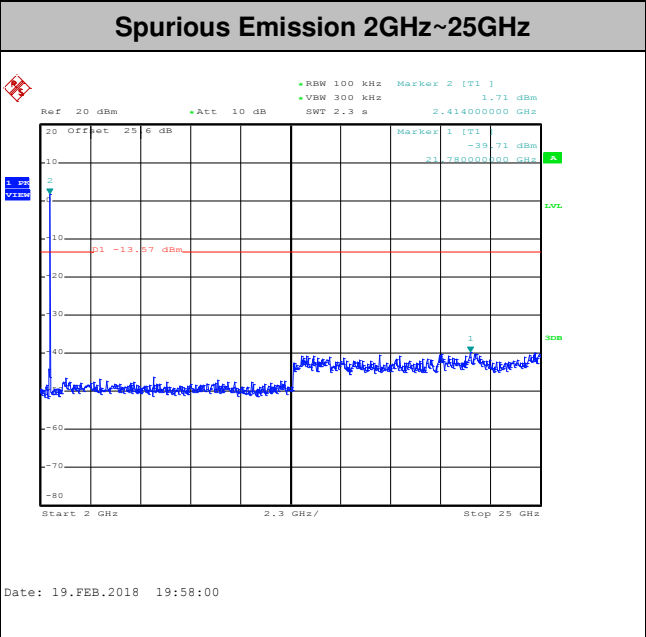
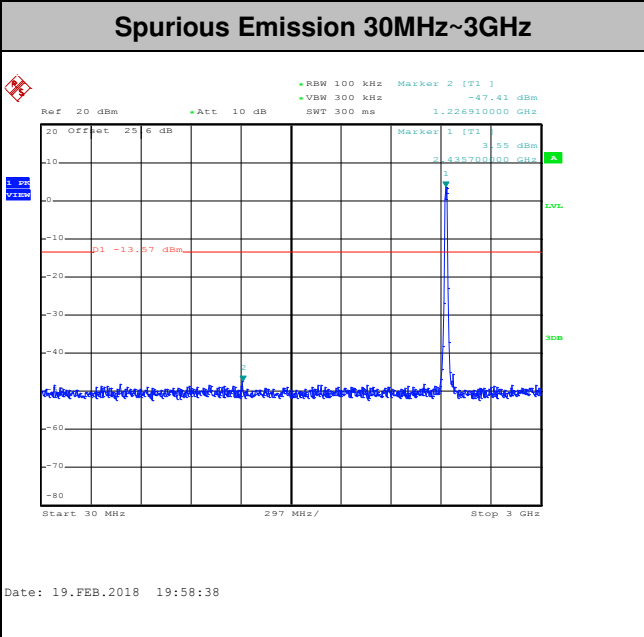
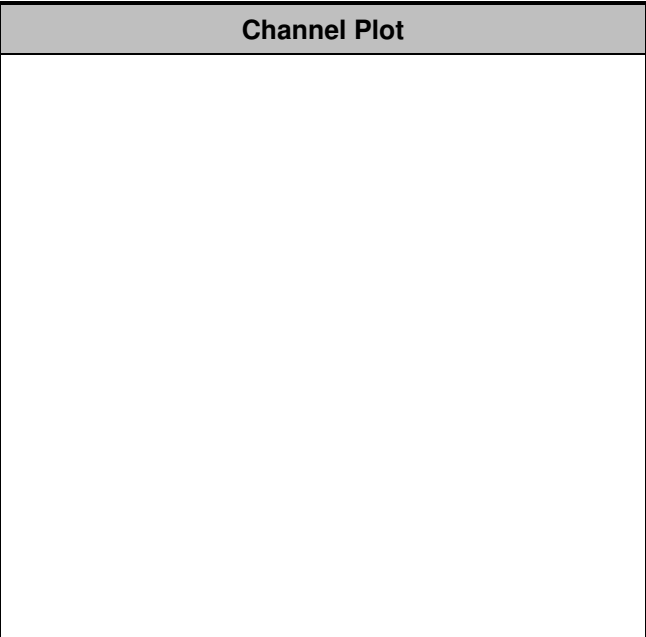
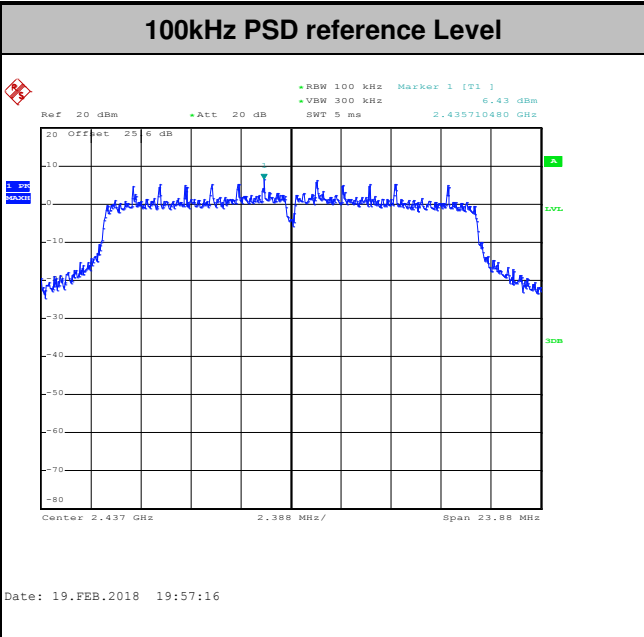





Test Mode :	802.11n HT20	Test Channel :	11
-------------	--------------	----------------	----

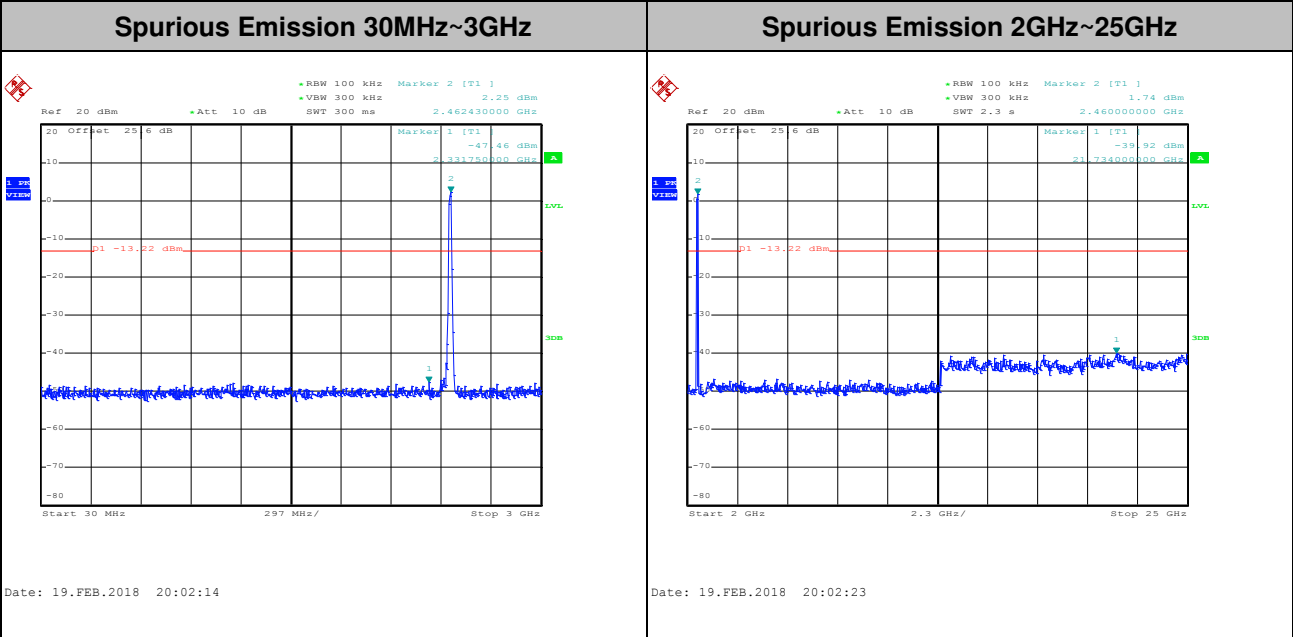
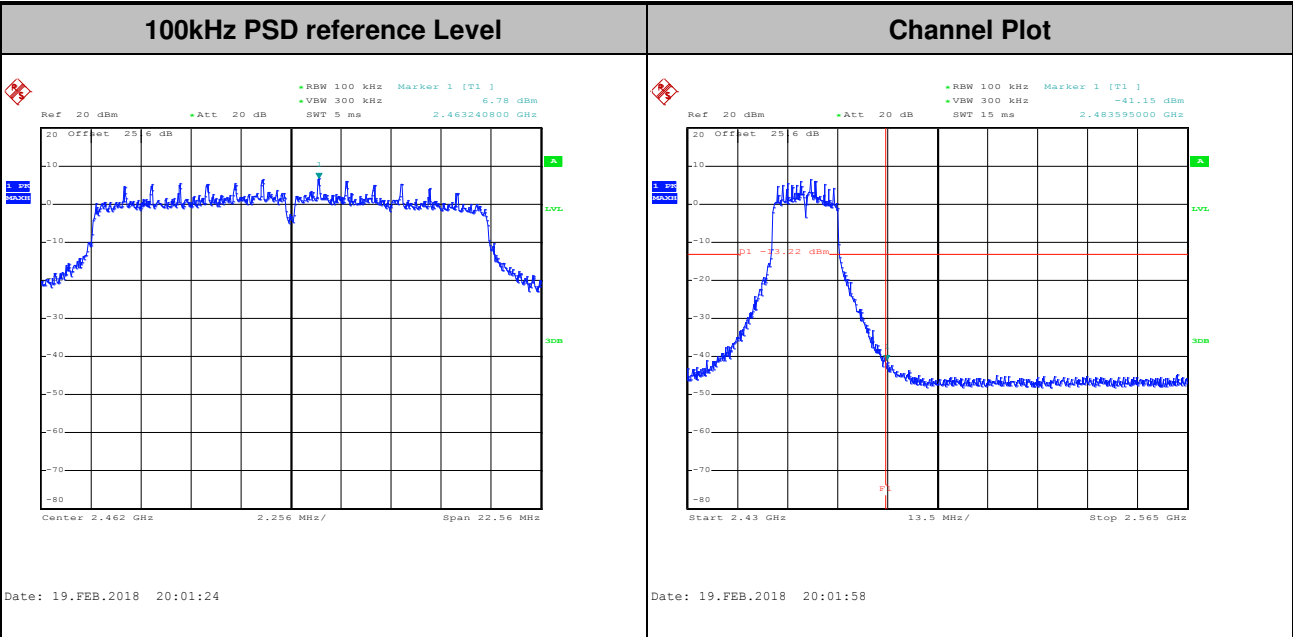



### 3.5 Radiated Band Edges and Spurious Emission Measurement

#### 3.5.1 Limit of Radiated band edge and Spurious Emission Measurement

In any 100 kHz bandwidth outside the intentional radiator frequency band, all harmonics/spurious must be at least 20 dB below the highest emission level within the authorized band. If the output power of this device was measured by spectrum analyzer, the attenuation under this paragraph shall be 30 dB instead of 20 dB. In addition, radiated emissions which fall in the restricted bands must also comply with the limits as below.

Frequency (MHz)	Field Strength (microvolts/meter)	Measurement Distance (meters)
0.009 – 0.490	2400/F(kHz)	300
0.490 – 1.705	24000/F(kHz)	30
1.705 – 30.0	30	30
30 – 88	100	3
88 – 216	150	3
216 - 960	200	3
Above 960	500	3

#### 3.5.2 Measuring Instruments

The measuring equipment is listed in the section 4 of this test report.



### 3.5.3 Test Procedures

1. The testing follows FCC KDB Publication No. 558074 D01 DTS Meas. Guidance v04.
2. The EUT was arranged to its worst case and then tune the antenna tower (from 1 m to 4 m) and turntable (from 0 degree to 360 degrees) to find the maximum reading. A pre-amp and a high pass filter are used for the test in order to get better signal level.
3. The EUT was placed on a turntable with 0.8 meter for frequency below 1GHz and 1.5 meter for frequency above 1GHz respectively above ground.
4. The EUT was set 3 meters from the interference receiving antenna, which was mounted on the top of a variable height antenna tower.
5. Corrected Reading: Antenna Factor + Cable Loss + Read Level - Preamp Factor = Level
6. For testing below 1GHz, if the emission level of the EUT in peak mode was 3 dB lower than the limit specified, then peak values of EUT will be reported, otherwise, the emissions will be repeated one by one using the CISPR quasi-peak method and reported.
7. For testing above 1GHz, the emission level of the EUT in peak mode was 20dB lower than average limit (that means the emission level in average mode also complies with the limit in average mode), then peak values of EUT will be reported, otherwise, the emissions will be measured in average mode again and reported.
8. Use the following spectrum analyzer settings:
  - (1) Span shall wide enough to fully capture the emission being measured;
  - (2) Set RBW=100 kHz for  $f < 1$  GHz; VBW  $\geq$  RBW; Sweep = auto; Detector function = peak; Trace = max hold;
  - (3) Set RBW = 1 MHz, VBW= 3MHz for  $f \geq 1$  GHz for peak measurement.  
For average measurement:
    - VBW = 10 Hz, when duty cycle is no less than 98 percent.
    - VBW  $\geq 1/T$ , when duty cycle is less than 98 percent where T is the minimum transmission duration over which the transmitter is on and is transmitting at its maximum power control level for the tested mode of operation.

### 3.5.4 Test Setup

For radiated emissions below 30MHz



For radiated emissions from 30MHz to 1GHz

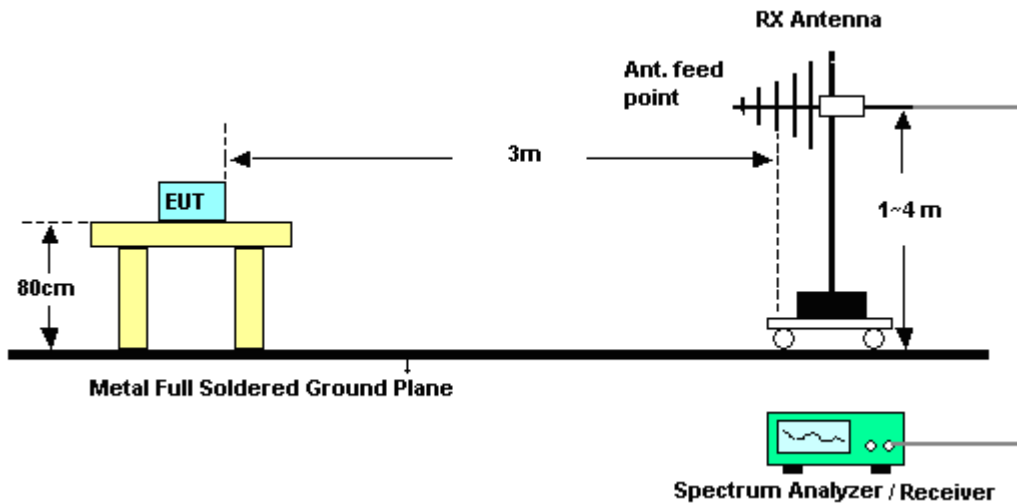

For radiated emissions above 1GHz

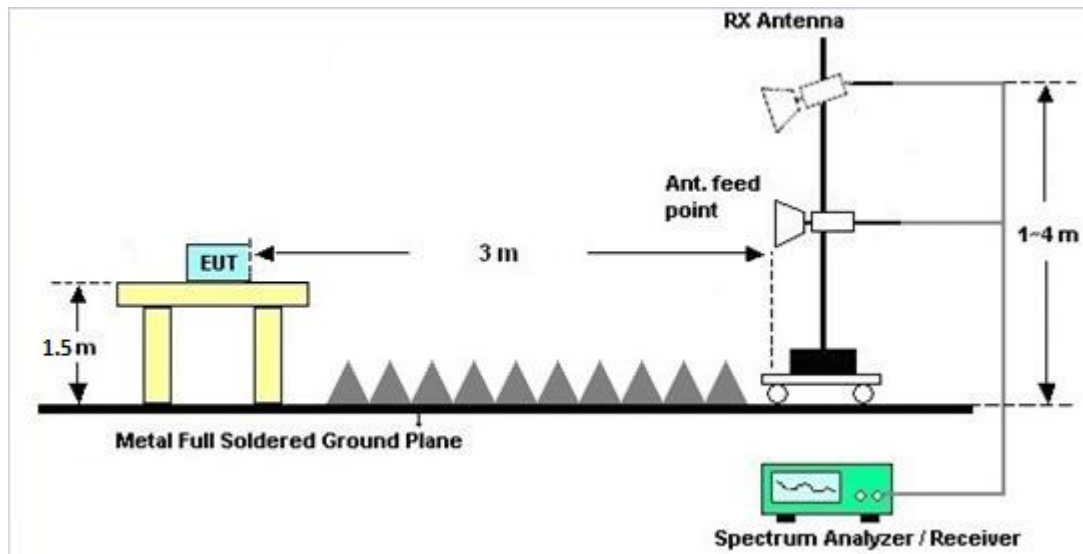

### 3.5.5 Test Results of Radiated Spurious Emissions (9kHz ~ 30MHz)

The low frequency, which started from 9 kHz to 30MHz, was pre-scanned and the result which was 20dB lower than the limit line was not reported.

There is a comparison data of both open-field test site and semi-Anechoic chamber, and the result came out very similar.

### 3.5.6 Test Result of Radiated Spurious at Band Edges

Please refer to Appendix C and D.

### 3.5.7 Duty Cycle

Please refer to Appendix E.

### 3.5.8 Test Result of Radiated Spurious Emission (30MHz ~ 10<sup>th</sup> Harmonic)

Please refer to Appendix C and D.



### 3.6 AC Conducted Emission Measurement

#### 3.6.1 Limit of AC Conducted Emission

For equipment that is designed to be connected to the public utility (AC) power line, the radio frequency voltage that is conducted back onto the AC power line on any frequency or frequencies within the band 150 kHz to 30 MHz shall not exceed the limits in the following table.

Frequency of Emission (MHz)	Conducted Limit (dBµV)	
	Quasi-Peak	Average
0.15-0.5	66 to 56*	56 to 46*
0.5-5	56	46
5-30	60	50

\*Decreases with the logarithm of the frequency.

#### 3.6.2 Measuring Instruments

The measuring equipment is listed in the section 4 of this test report.

#### 3.6.3 Test Procedures

1. The EUT was placed 0.4 meter from the conducting wall of the shielding room, and it was kept at least 80 centimeters from any other grounded conducting surface.
2. Connect EUT to the power mains through a line impedance stabilization network (LISN).
3. All the support units are connecting to the other LISN.
4. The LISN provides 50 ohm coupling impedance for the measuring instrument.
5. The FCC states that a 50 ohm, 50 microhenry LISN should be used.
6. Both sides of AC line were checked for maximum conducted interference.
7. The frequency range from 150 kHz to 30 MHz was searched.
8. Set the test-receiver system to Peak Detect Function and specified bandwidth (IF bandwidth = 9kHz) with Maximum Hold Mode.

### 3.6.4 Test Setup

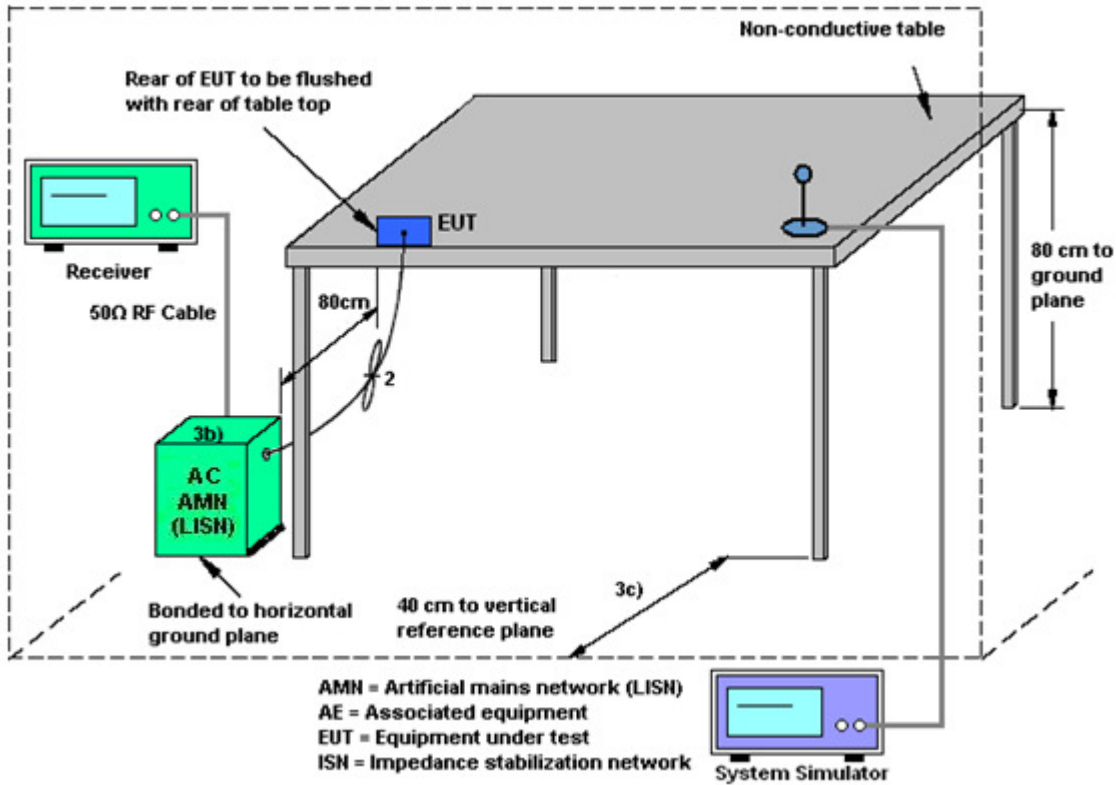

### 3.6.5 Test Result of AC Conducted Emission

Please refer to Appendix B.



## **3.7 Antenna Requirements**

### **3.7.1 Standard Applicable**

If directional gain of transmitting Antennas is greater than 6dBi, the power shall be reduced by the same level in dB comparing to gain minus 6dBi. The use of a permanently attached Antenna or of an Antenna that uses a unique coupling to the intentional radiator shall be considered sufficient to comply with the rule.

### **3.7.2 Antenna Anti-Replacement Construction**

An embedded-in antenna design is used.

### **3.7.3 Antenna Gain**

The antenna peak gain of EUT is less than 6 dBi. Therefore, it is not necessary to reduce maximum peak output power limit.





## 4 List of Measuring Equipment

Instrument	Manufacturer	Model No.	Serial No.	Characteristics	Calibration Date	Test Date	Due Date	Remark
Power Meter	Anritsu	ML2495A	0932001	N/A	Sep. 26, 2017	Feb. 12, 2018~ Feb. 19, 2018	Sep. 25, 2018	Conducted (TH05-HY)
Power Sensor	Anritsu	MA2411B	0846202	300MHz~40GHz z	Sep. 26, 2017	Feb. 12, 2018~ Feb. 19, 2018	Sep. 25, 2018	Conducted (TH05-HY)
Spectrum Analyzer	Rohde & Schwarz	FSP30	101067	9kHz ~ 30GHz	Nov. 13, 2017	Feb. 12, 2018~ Feb. 19, 2018	Nov. 12, 2018	Conducted (TH05-HY)
AC Power Source	ChainTek	APC-1000W	N/A	N/A	N/A	Feb. 27, 2018	N/A	Conduction (CO05-HY)
EMI Test Receiver	Rohde & Schwarz	ESR3	102388	3.6GHz	Dec. 08, 2017	Feb. 27, 2018	Dec. 07, 2018	Conduction (CO05-HY)
LISN	Rohde & Schwarz	ENV216	100080	9kHz~30MHz	Nov. 30, 2017	Feb. 27, 2018	Nov. 29, 2018	Conduction (CO05-HY)
Amplifier	MITEQ	TTA1840-35-HG	1871923	18GHz~40GHz, VSWR : 2.5:1 max	Jul. 18, 2017	Feb. 27, 2018~ Mar. 03, 2018	Jul. 17, 2018	Radiation (03CH12-HY)
Bilog Antenna	TESEQ	CBL 6111D&00800 N1D01N-06	40103&07	30MHz~1GHz	Jan. 10, 2018	Feb. 27, 2018~ Mar. 03, 2018	Jan. 09, 2019	Radiation (03CH12-HY)
Loop Antenna	Rohde & Schwarz	HFH2-Z2	100488	9 kHz~30 MHz	Nov. 23, 2017	Feb. 27, 2018~ Mar. 03, 2018	Nov. 22, 2019	Radiation (03CH12-HY)
EMI Test Receiver	Rohde & Schwarz	ESU26	100390	20Hz~26.5GHz	Dec. 25, 2017	Feb. 27, 2018~ Mar. 03, 2018	Dec. 24, 2018	Radiation (03CH12-HY)
Horn Antenna	SCHWARZBECK	BBHA 9120D	9120D-132 8	1GHz ~ 18GHz	Oct. 20, 2017	Feb. 27, 2018~ Mar. 03, 2018	Oct. 19, 2018	Radiation (03CH12-HY)
Preamplifier	COM-POWER	PA-103	161075	10MHz~1GHz	Mar. 23, 2017	Feb. 27, 2018~ Mar. 03, 2018	Mar. 22, 2018	Radiation (03CH12-HY)
Preamplifier	Keysight	83017A	MY532701 48	1GHz~26.5GHz	Jan. 15, 2018	Feb. 27, 2018~ Mar. 03, 2018	Jan. 14, 2019	Radiation (03CH12-HY)
Preamplifier	MITEQ	AMF-7D-0010 1800	2025787	1GHz~18GHz	Feb. 13, 2017	Feb. 27, 2018~ Mar. 03, 2018	Feb. 12, 2019	Radiation (03CH12-HY)
Antenna Mast	EMEC	AM-BS-4500-B	N/A	1m~4m	N/A	Feb. 27, 2018~ Mar. 03, 2018	N/A	Radiation (03CH12-HY)
Turn Table	EMEC	TT2000	N/A	0~360 Degree	N/A	Feb. 27, 2018~ Mar. 03, 2018	N/A	Radiation (03CH12-HY)
Attenuator	Fairview Microwave	SA18S5W-10	n/a	10db	Mar. 24, 2017	Feb. 27, 2018~ Mar. 03, 2018	Mar. 23, 2018	Radiation (03CH12-HY)
SHF-EHF Horn Antenna	SCHWARZBECK	BBHA 9170	BBHA9170 576	18GHz ~ 40GHz	Apr. 27, 2017	Feb. 27, 2018~ Mar. 03, 2018	Apr. 26, 2018	Radiation (03CH12-HY)
Spectrum Analyzer	Keysight	N9010A	MY553705 26	10Hz~44GHz	Mar. 15, 2017	Feb. 27, 2018~ Mar. 03, 2018	Mar. 14, 2018	Radiation (03CH12-HY)



## 5 Uncertainty of Evaluation

### Uncertainty of Conducted Emission Measurement (150kHz ~ 30MHz)

Measuring Uncertainty for a Level of Confidence of 95% ( $U = 2Uc(y)$ )	2.70
---	------

### Uncertainty of Radiated Emission Measurement (30 MHz ~ 1000 MHz)

Measuring Uncertainty for a Level of Confidence of 95% ( $U = 2Uc(y)$ )	5.10
---	------

### Uncertainty of Radiated Emission Measurement (1000 MHz ~ 18000 MHz)

Measuring Uncertainty for a Level of Confidence of 95% ( $U = 2Uc(y)$ )	5.20
---	------

### Uncertainty of Radiated Emission Measurement (18000 MHz ~ 40000 MHz)

Measuring Uncertainty for a Level of Confidence of 95% ( $U = 2Uc(y)$ )	4.70
---	------

**Appendix A. Test Result of Conducted Test Items**

Test Engineer:	White Lin / Luffy Lin	Temperature:	21~25	°C
Test Date:	2018/2/12 ~ 2018/02/19	Relative Humidity:	51~54	%

**TEST RESULTS DATA**  
**6dB and 99% Occupied Bandwidth**

2.4GHz Band								
Mod.	Data Rate	N <sub>TX</sub>	CH.	Freq. (MHz)	99% Occupied BW (MHz)	6dB BW (MHz)	6dB BW Limit (MHz)	Pass/Fail
11b	1Mbps	1	1	2412	12.75	8.04	0.50	Pass
11b	1Mbps	1	6	2437	12.95	7.04	0.50	Pass
11b	1Mbps	1	11	2462	12.70	8.04	0.50	Pass
11g	6Mbps	1	1	2412	17.50	15.52	0.50	Pass
11g	6Mbps	1	6	2437	17.75	15.44	0.50	Pass
11g	6Mbps	1	11	2462	17.50	15.46	0.50	Pass
HT20	MCS0	1	1	2412	18.70	16.62	0.50	Pass
HT20	MCS0	1	6	2437	18.80	15.92	0.50	Pass
HT20	MCS0	1	11	2462	18.60	15.04	0.50	Pass

**TEST RESULTS DATA**  
**Peak Power Table**

2.4GHz Band										
Mod.	Data Rate	N <sub>TX</sub>	CH.	Freq. (MHz)	Peak Conducted Power (dBm)	Conducted Power Limit (dBm)	DG (dBi)	EIRP Power (dBm)	EIRP Power Limit (dBm)	Pass /Fail
11b	1Mbps	1	1	2412	21.33	30.00	-5.00	16.33	36.00	Pass
11b	1Mbps	1	6	2437	21.65	30.00	-5.00	16.65	36.00	Pass
11b	1Mbps	1	11	2462	21.48	30.00	-5.00	16.48	36.00	Pass
11g	6Mbps	1	1	2412	21.52	30.00	-5.00	16.52	36.00	Pass
11g	6Mbps	1	6	2437	21.76	30.00	-5.00	16.76	36.00	Pass
11g	6Mbps	1	11	2462	21.66	30.00	-5.00	16.66	36.00	Pass
HT20	MCS0	1	1	2412	21.55	30.00	-5.00	16.55	36.00	Pass
HT20	MCS0	1	6	2437	21.76	30.00	-5.00	16.76	36.00	Pass
HT20	MCS0	1	11	2462	21.46	30.00	-5.00	16.46	36.00	Pass

**TEST RESULTS DATA**  
**Average Power Table**  
***(Reporting Only)***

2.4GHz Band						
Mod.	Data Rate	N <sub>TX</sub>	CH.	Freq. (MHz)	Duty Factor (dB)	Average Conducted Power (dBm)
11b	1Mbps	1	1	2412	0.05	18.66
11b	1Mbps	1	6	2437	0.05	18.97
11b	1Mbps	1	11	2462	0.05	18.77
11g	6Mbps	1	1	2412	0.25	16.83
11g	6Mbps	1	6	2437	0.25	16.97
11g	6Mbps	1	11	2462	0.25	16.86
HT20	MCS0	1	1	2412	0.26	16.68
HT20	MCS0	1	6	2437	0.26	16.88
HT20	MCS0	1	11	2462	0.26	16.64

**TEST RESULTS DATA**  
**Peak Power Density**

2.4GHz Band								
Mod.	Data Rate	N <sub>TX</sub>	CH.	Freq. (MHz)	Peak PSD (dBm /3kHz)	DG (dBi)	Peak PSD Limit (dBm /3kHz)	Pass/Fail
11b	1Mbps	1	1	2412	-4.19	-5.00	8.00	Pass
11b	1Mbps	1	6	2437	-3.56	-5.00	8.00	Pass
11b	1Mbps	1	11	2462	-4.74	-5.00	8.00	Pass
11g	6Mbps	1	1	2412	-8.18	-5.00	8.00	Pass
11g	6Mbps	1	6	2437	-9.51	-5.00	8.00	Pass
11g	6Mbps	1	11	2462	-8.92	-5.00	8.00	Pass
HT20	MCS0	1	1	2412	-9.46	-5.00	8.00	Pass
HT20	MCS0	1	6	2437	-9.68	-5.00	8.00	Pass
HT20	MCS0	1	11	2462	-9.39	-5.00	8.00	Pass



## Appendix B. AC Conducted Emission Test Results

Test Engineer :	Shareef Yu	Temperature :	22~23°C
		Relative Humidity :	58~62%



# EUT Information

Report NO : 811821-02  
 Test Mode : Mode 1  
 Test Voltage : 120Vac/60Hz  
 Phase : Line

Full Spectrum

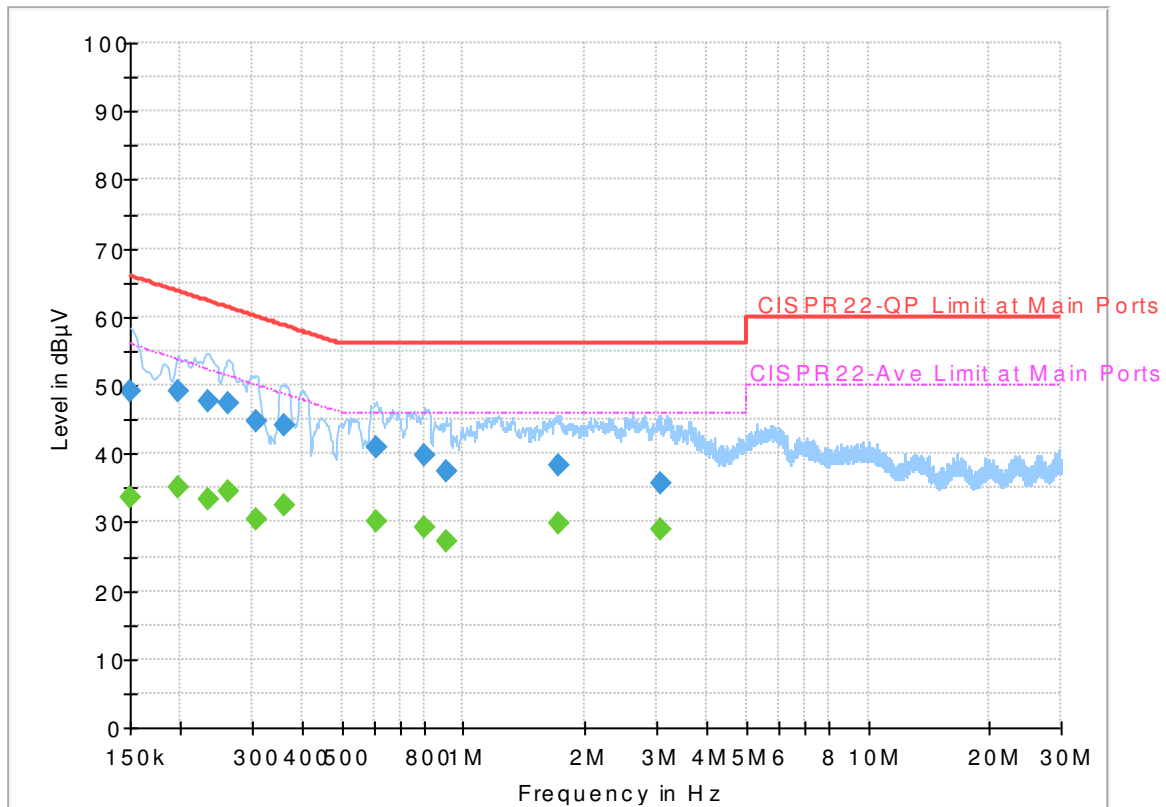

## Final Result

Frequency (MHz)	QuasiPeak (dBµV)	Average (dBµV)	Limit (dBµV)	Margin (dB)	Line	Filter	Corr. (dB)
0.150000	---	33.62	56.00	22.38	L1	OFF	19.5
0.150000	48.99	---	66.00	17.01	L1	OFF	19.5
0.197250	---	35.10	53.73	18.63	L1	OFF	19.5
0.197250	49.05	---	63.73	14.68	L1	OFF	19.5
0.233250	---	33.43	52.33	18.90	L1	OFF	19.5
0.233250	47.65	---	62.33	14.68	L1	OFF	19.5
0.262500	---	34.39	51.35	16.96	L1	OFF	19.5
0.262500	47.51	---	61.35	13.84	L1	OFF	19.5
0.307500	---	30.45	50.04	19.59	L1	OFF	19.5
0.307500	44.80	---	60.04	15.24	L1	OFF	19.5
0.361500	---	32.36	48.69	16.33	L1	OFF	19.5
0.361500	44.18	---	58.69	14.51	L1	OFF	19.5
0.606750	---	30.19	46.00	15.81	L1	OFF	19.5
0.606750	40.89	---	56.00	15.11	L1	OFF	19.5
0.802500	---	29.31	46.00	16.69	L1	OFF	19.5
0.802500	39.85	---	56.00	16.15	L1	OFF	19.5
0.908250	---	27.34	46.00	18.66	L1	OFF	19.5
0.908250	37.36	---	56.00	18.64	L1	OFF	19.5
1.727250	---	29.79	46.00	16.21	L1	OFF	19.6
1.727250	38.29	---	56.00	17.71	L1	OFF	19.6
3.054750	---	28.83	46.00	17.17	L1	OFF	19.6

3.054750	35.72	---	56.00	20.28	L1	OFF	19.6
----------	-------	-----	-------	-------	----	-----	------

# EUT Information

Report NO : 811821-02  
 Test Mode : Mode 1  
 Test Voltage : 120Vac/60Hz  
 Phase : Neutral

Full Spectrum

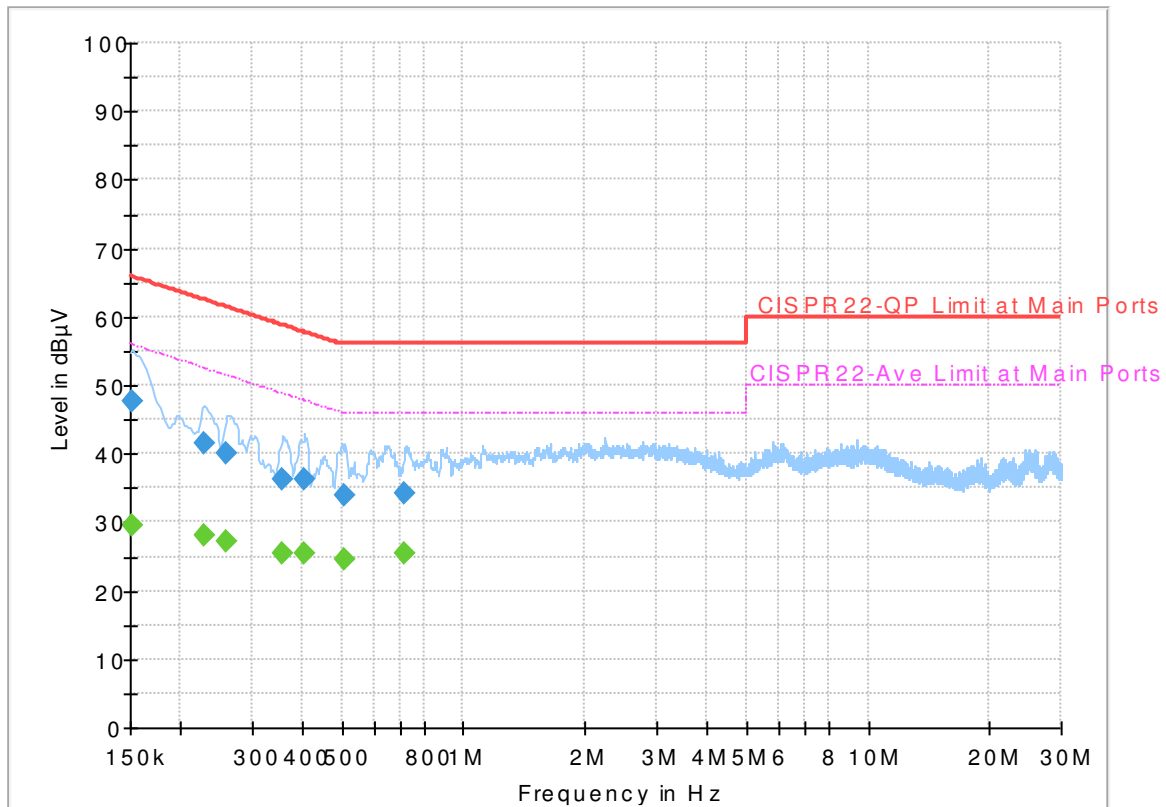

## Final Result

Frequency (MHz)	QuasiPeak (dBµV)	Average (dBµV)	Limit (dBµV)	Margin (dB)	Line	Filter	Corr. (dB)
0.152250	---	29.43	55.88	26.45	N	OFF	19.5
0.152250	47.78	---	65.88	18.10	N	OFF	19.5
0.228750	---	28.17	52.50	24.33	N	OFF	19.5
0.228750	41.40	---	62.50	21.10	N	OFF	19.5
0.260250	---	27.12	51.42	24.30	N	OFF	19.5
0.260250	40.19	---	61.42	21.23	N	OFF	19.5
0.357000	---	25.51	48.80	23.29	N	OFF	19.5
0.357000	36.31	---	58.80	22.49	N	OFF	19.5
0.404250	---	25.55	47.77	22.22	N	OFF	19.5
0.404250	36.19	---	57.77	21.58	N	OFF	19.5
0.510000	---	24.63	46.00	21.37	N	OFF	19.5
0.510000	34.06	---	56.00	21.94	N	OFF	19.5
0.717000	---	25.42	46.00	20.58	N	OFF	19.5
0.717000	34.14	---	56.00	21.86	N	OFF	19.5



## Appendix C. Radiated Spurious Emission

Test Engineer :	Watt Tseng, Karl Hou, and Nick Yu	Temperature :	21~23°C
		Relative Humidity :	57~60%

### 2.4GHz 2400~2483.5MHz

#### WIFI 802.11b (Band Edge @ 3m)

WIFI Ant.	Note	Frequency ( MHz )	Level ( dBμV/m )	Over Limit ( dB )	Limit Line ( dBμV/m )	Read Level ( dBμV )	Antenna Factor ( dB/m )	Path Loss ( dB )	Preamp Factor ( dB )	Ant Pos ( cm )	Table Pos ( deg )	Peak Avg. ( P/A )	Pol. ( H/V )	
802.11b CH 01 2412MHz		2371.845	54.14	-19.86	74	44.57	27.11	14.04	31.58	316	135	P	H	
		2389.38	41.85	-12.15	54	32.22	27.15	14.06	31.58	316	135	A	H	
	*	2412	107.8	-	-	98.1	27.19	14.08	31.57	316	135	P	H	
	*	2412	103.57	-	-	93.87	27.19	14.08	31.57	316	135	A	H	
													H	
			2369.745	53.55	-20.45	74	43.98	27.11	14.04	31.58	188	82	P	V
			2389.275	42.07	-11.93	54	32.44	27.15	14.06	31.58	188	82	A	V
	*		2412	109.82	-	-	100.12	27.19	14.08	31.57	188	82	P	V
	*		2412	105.63	-	-	95.93	27.19	14.08	31.57	188	82	A	V
														V
802.11b CH 06 2437MHz		2370.48	53.47	-20.53	74	43.9	27.11	14.04	31.58	107	144	P	H	
		2387.98	41.31	-12.69	54	31.68	27.15	14.06	31.58	107	144	A	H	
	*	2437	106.44	-	-	96.63	27.28	14.1	31.57	107	144	P	H	
	*	2437	102.22	-	-	92.41	27.28	14.1	31.57	107	144	A	H	
			2492.02	53.44	-20.56	74	43.45	27.4	14.14	31.55	107	144	P	H
			2487.33	41.65	-12.35	54	31.71	27.36	14.14	31.56	107	144	A	H
			2324.84	53.6	-20.4	74	44.19	26.99	14.01	31.59	137	90	P	V
			2389.1	41.41	-12.59	54	31.78	27.15	14.06	31.58	137	90	A	V
	*		2437	109.96	-	-	100.15	27.28	14.1	31.57	137	90	P	V
	*		2437	105.65	-	-	95.84	27.28	14.1	31.57	137	90	A	V
			2484.95	55.81	-18.19	74	45.87	27.36	14.14	31.56	137	90	P	V
			2487.47	41.82	-12.18	54	31.88	27.36	14.14	31.56	137	90	A	V



<b>802.11b</b> <b>CH 11</b> <b>2462MHz</b>	*	2462	108.51	-	-	98.64	27.32	14.11	31.56	302	134	P	H
	*	2462	104.29	-	-	94.42	27.32	14.11	31.56	302	134	A	H
		2487.44	53.79	-20.21	74	43.85	27.36	14.14	31.56	302	134	P	H
		2483.52	42.27	-11.73	54	32.33	27.36	14.14	31.56	302	134	A	H
													H
													H
	*	2462	109.33	-	-	99.46	27.32	14.11	31.56	206	80	P	V
	*	2462	105.22	-	-	95.35	27.32	14.11	31.56	206	80	A	V
		2489.92	54.85	-19.15	74	44.87	27.4	14.14	31.56	206	80	P	V
		2483.68	42.45	-11.55	54	32.51	27.36	14.14	31.56	206	80	A	V
													V
													V
<b>Remark</b>	1. No other spurious found. 2. All results are PASS against Peak and Average limit line.												



**2.4GHz 2400~2483.5MHz  
WIFI 802.11b (Harmonic @ 3m)**

WIFI Ant. 1	Note	Frequency ( MHz )	Level ( dBμV/m )	Over Limit ( dB )	Limit Line ( dBμV/m )	Read Level ( dBμV )	Antenna Factor ( dB/m )	Path Loss ( dB )	Preamp Factor ( dB )	Ant Pos ( cm )	Table Pos ( deg )	Peak Avg. ( P/A )	Pol. ( H/V )	
802.11b CH 01 2412MHz		4824	44.57	-29.43	74	71.25	31.36	6.7	64.74	100	0	P	H	
													H	
													H	
													H	
			4824	42.59	-31.41	74	69.27	31.36	6.7	64.74	100	0	P	V
														V
														V
802.11b CH 06 2437MHz		4874	42.39	-31.61	74	68.9	31.46	6.73	64.7	100	0	P	H	
		7311	44.76	-29.24	74	65.4	36.11	8.07	64.82	100	0	P	H	
													H	
													H	
			4874	42.11	-31.89	74	68.62	31.46	6.73	64.7	100	0	P	V
			7311	44.99	-29.01	74	65.63	36.11	8.07	64.82	100	0	P	V
														V
802.11b CH 11 2462MHz		4924	45.36	-28.64	74	71.73	31.56	6.73	64.66	100	0	P	H	
		7386	57.76	-16.24	74	78.28	36.33	8.01	64.86	241	0	P	H	
		7386	50.89	-3.11	54	71.41	36.33	8.01	64.86	241	0	A	H	
													H	
			4924	45.32	-28.68	74	71.69	31.56	6.73	64.66	100	0	P	V
			7386	55.88	-18.12	74	76.4	36.33	8.01	64.86	226	327	P	V
			7386	49.11	-4.89	54	69.63	36.33	8.01	64.86	226	327	A	V
													V	
Remark	1. No other spurious found. 2. All results are PASS against Peak and Average limit line.													



**2.4GHz 2400~2483.5MHz  
WIFI 802.11g (Band Edge @ 3m)**

WIFI Ant. 1	Note	Frequency ( MHz )	Level ( dBμV/m )	Over Limit ( dB )	Limit Line ( dBμV/m )	Read Level ( dBμV )	Antenna Factor ( dB/m )	Path Loss ( dB )	Preamp Factor ( dB )	Ant Pos ( cm )	Table Pos ( deg )	Peak Avg. ( P/A )	Pol. ( H/V )	
802.11g CH 01 2412MHz		2390	56.22	-17.78	74	46.58	27.15	14.06	31.57	315	136	P	H	
		2390	45.83	-8.17	54	36.19	27.15	14.06	31.57	315	136	A	H	
	*	2412	107.17	-	-	97.47	27.19	14.08	31.57	315	136	P	H	
	*	2412	97.34	-	-	87.64	27.19	14.08	31.57	315	136	A	H	
													H	
														H
			2389.695	58.51	-15.49	74	48.88	27.15	14.06	31.58	121	113	P	V
			2390	47.07	-6.93	54	37.43	27.15	14.06	31.57	121	113	A	V
	*		2412	108.97	-	-	99.27	27.19	14.08	31.57	121	113	P	V
	*		2412	99.12	-	-	89.42	27.19	14.08	31.57	121	113	A	V
														V
														V
802.11g CH 06 2437MHz		2389.24	54.32	-19.68	74	44.69	27.15	14.06	31.58	307	138	P	H	
		2389.8	42.79	-11.21	54	33.15	27.15	14.06	31.57	307	138	A	H	
	*	2437	108.81	-	-	99	27.28	14.1	31.57	307	138	P	H	
	*	2437	98.78	-	-	88.97	27.28	14.1	31.57	307	138	A	H	
			2484.81	60.7	-13.3	74	50.76	27.36	14.14	31.56	307	138	P	H
			2485.16	43.49	-10.51	54	33.55	27.36	14.14	31.56	307	138	A	H
			2387.7	56.39	-17.61	74	46.76	27.15	14.06	31.58	212	98	P	V
			2389.24	43.55	-10.45	54	33.92	27.15	14.06	31.58	212	98	A	V
	*		2437	109.91	-	-	100.1	27.28	14.1	31.57	212	98	P	V
	*		2437	100.25	-	-	90.44	27.28	14.1	31.57	212	98	A	V
			2484.04	62.08	-11.92	74	52.14	27.36	14.14	31.56	212	98	P	V
			2486.7	43.83	-10.17	54	33.89	27.36	14.14	31.56	212	98	A	V



<b>802.11g CH 11 2462MHz</b>	*	2462	107.65	-	-	97.78	27.32	14.11	31.56	301	140	P	H
	*	2462	97.9	-	-	88.03	27.32	14.11	31.56	301	140	A	H
		2486.68	63.35	-10.65	74	53.41	27.36	14.14	31.56	301	140	P	H
		2483.56	47.23	-6.77	54	37.29	27.36	14.14	31.56	301	140	A	H
													H
													H
	*	2462	109.12	-	-	99.25	27.32	14.11	31.56	100	111	P	V
	*	2462	98.94	-	-	89.07	27.32	14.11	31.56	100	111	A	V
		2488.56	63.63	-10.37	74	53.65	27.4	14.14	31.56	100	111	P	V
		2483.52	47.13	-6.87	54	37.19	27.36	14.14	31.56	100	111	A	V
													V
													V
<b>Remark</b>	1. No other spurious found. 2. All results are PASS against Peak and Average limit line.												





**2.4GHz 2400~2483.5MHz  
WIFI 802.11g (Harmonic @ 3m)**

WIFI Ant. 1	Note	Frequency ( MHz )	Level ( dBμV/m )	Over Limit ( dB )	Limit Line ( dBμV/m )	Read Level ( dBμV )	Antenna Factor ( dB/m )	Path Loss ( dB )	Preamp Factor ( dB )	Ant Pos ( cm )	Table Pos ( deg )	Peak Avg. ( P/A )	Pol. ( H/V )	
802.11g CH 01 2412MHz		4824	41.05	-32.95	74	67.73	31.36	6.7	64.74	100	0	P	H	
													H	
													H	
													H	
			4824	40.24	-33.76	74	66.92	31.36	6.7	64.74	100	0	P	V
														V
														V
802.11g CH 06 2437MHz		4874	40	-34	74	66.51	31.46	6.73	64.7	100	0	P	H	
		7311	61.26	-12.74	74	81.9	36.11	8.07	64.82	244	0	P	H	
		7311	42.96	-11.04	54	63.6	36.11	8.07	64.82	244	0	A	H	
														H
			4874	40.17	-33.83	74	66.68	31.46	6.73	64.7	100	0	P	V
			7311	59.41	-14.59	74	80.05	36.11	8.07	64.82	208	346	P	V
			7311	41.61	-12.39	54	62.25	36.11	8.07	64.82	208	346	A	V
802.11g CH 11 2462MHz		4924	41.51	-32.49	74	67.88	31.56	6.73	64.66	100	0	P	H	
		7386	58.55	-15.45	74	79.07	36.33	8.01	64.86	239	0	P	H	
		7386	42.04	-11.96	54	62.56	36.33	8.01	64.86	239	0	A	H	
														H
			4924	42.18	-31.82	74	68.55	31.56	6.73	64.66	100	0	P	V
			7386	55.99	-18.01	74	76.51	36.33	8.01	64.86	212	340	P	V
			7386	39.2	-14.8	54	59.72	36.33	8.01	64.86	212	340	A	V
													V	
Remark	1. No other spurious found. 2. All results are PASS against Peak and Average limit line.													



**2.4GHz 2400~2483.5MHz  
WIFI 802.11n HT20 (Band Edge @ 3m)**

WIFI Ant. 1	Note	Frequency ( MHz )	Level ( dBμV/m )	Over Limit ( dB )	Limit Line ( dBμV/m )	Read Level ( dBμV )	Antenna Factor ( dB/m )	Path Loss ( dB )	Preamp Factor ( dB )	Ant Pos ( cm )	Table Pos ( deg )	Peak Avg. ( P/A )	Pol. ( H/V )	
802.11n HT20 CH 01 2412MHz		2389.8	59.33	-14.67	74	49.69	27.15	14.06	31.57	314	136	P	H	
		2390	48.48	-5.52	54	38.84	27.15	14.06	31.57	314	136	A	H	
	*	2412	107.18	-	-	97.48	27.19	14.08	31.57	314	136	P	H	
	*	2412	97.38	-	-	87.68	27.19	14.08	31.57	314	136	A	H	
													H	
														H
			2388.855	61.03	-12.97	74	51.4	27.15	14.06	31.58	190	81	P	V
			2389.905	49.86	-4.14	54	40.22	27.15	14.06	31.57	190	81	A	V
		*	2412	109.15	-	-	99.45	27.19	14.08	31.57	190	81	P	V
		*	2412	99.15	-	-	89.45	27.19	14.08	31.57	190	81	A	V
													V	
													V	
802.11n HT20 CH 06 2437MHz		2389.38	55.73	-18.27	74	46.1	27.15	14.06	31.58	308	135	P	H	
		2388.68	42.96	-11.04	54	33.33	27.15	14.06	31.58	308	135	A	H	
	*	2437	108.27	-	-	98.46	27.28	14.1	31.57	308	135	P	H	
	*	2437	98.29	-	-	88.48	27.28	14.1	31.57	308	135	A	H	
			2485.86	60.27	-13.73	74	50.33	27.36	14.14	31.56	308	135	P	H
			2484.32	43.9	-10.1	54	33.96	27.36	14.14	31.56	308	135	A	H
			2389.52	57.27	-16.73	74	47.64	27.15	14.06	31.58	213	82	P	V
			2388.96	43.57	-10.43	54	33.94	27.15	14.06	31.58	213	82	A	V
		*	2437	109.73	-	-	99.92	27.28	14.1	31.57	213	82	P	V
		*	2437	99.69	-	-	89.88	27.28	14.1	31.57	213	82	A	V
		2487.54	61.69	-12.31	74	51.71	27.4	14.14	31.56	213	82	P	V	
		2483.69	44.15	-9.85	54	34.21	27.36	14.14	31.56	213	82	A	V	



<b>802.11n</b> <b>HT20</b> <b>CH 11</b> <b>2462MHz</b>	*	2462	107.5	-	-	97.63	27.32	14.11	31.56	302	134	P	H
	*	2462	97.63	-	-	87.76	27.32	14.11	31.56	302	134	A	H
		2486.32	65.59	-8.41	74	55.65	27.36	14.14	31.56	302	134	P	H
		2483.6	47.77	-6.23	54	37.83	27.36	14.14	31.56	302	134	A	H
													H
													H
	*	2462	108.68	-	-	98.81	27.32	14.11	31.56	265	82	P	V
	*	2462	99.16	-	-	89.29	27.32	14.11	31.56	265	82	A	V
		2485.32	65.89	-8.11	74	55.95	27.36	14.14	31.56	265	82	P	V
		2483.76	48.32	-5.68	54	38.38	27.36	14.14	31.56	265	82	A	V
													V
												V	
<b>Remark</b>	1. No other spurious found. 2. All results are PASS against Peak and Average limit line.												



**2.4GHz 2400~2483.5MHz  
WIFI 802.11n HT20 (Harmonic @ 3m)**

WIFI Ant. 1	Note	Frequency ( MHz )	Level ( dBμV/m )	Over Limit ( dB )	Limit Line ( dBμV/m )	Read Level ( dBμV )	Antenna Factor ( dB/m )	Path Loss ( dB )	Preamp Factor ( dB )	Ant Pos ( cm )	Table Pos ( deg )	Peak Avg. (P/A)	Pol. (H/V)	
802.11n HT20 CH 01 2412MHz		4824	40.83	-33.17	74	67.51	31.36	6.7	64.74	100	0	P	H	
													H	
													H	
													H	
			4824	41.14	-32.86	74	67.82	31.36	6.7	64.74	100	0	P	V
														V
														V
802.11n HT20 CH 06 2437MHz		4874	40.82	-33.18	74	67.33	31.46	6.73	64.7	100	0	P	H	
		7311	63.26	-10.74	74	83.9	36.11	8.07	64.82	242	0	P	H	
		7311	42.31	-11.69	54	62.95	36.11	8.07	64.82	242	0	A	H	
														H
			4874	41.01	-32.99	74	67.52	31.46	6.73	64.7	100	0	P	V
			7311	61.04	-12.96	74	81.68	36.11	8.07	64.82	207	345	P	V
			7311	40.41	-13.59	54	61.05	36.11	8.07	64.82	207	345	A	V
													V	
802.11n HT20 CH 11 2462MHz		4924	42.11	-31.89	74	68.48	31.56	6.73	64.66	100	0	P	H	
		7386	59.97	-14.03	74	80.49	36.33	8.01	64.86	236	0	P	H	
		7386	41.08	-12.92	54	61.6	36.33	8.01	64.86	236	0	A	H	
														H
			4924	41.49	-32.51	74	67.86	31.56	6.73	64.66	100	0	P	V
			7386	57.77	-16.23	74	78.29	36.33	8.01	64.86	209	316	P	V
			7386	38.55	-15.45	54	59.07	36.33	8.01	64.86	209	316	A	V
													V	
Remark	1. No other spurious found. 2. All results are PASS against Peak and Average limit line.													



**Emission below 1GHz  
2.4GHz WIFI 802.11b (LF)**

WIFI	Note	Frequency	Level	Over	Limit	Read	Antenna	Path	Preamp	Ant	Table	Peak	Pol.	
Ant.				Limit	Line	Level	Factor	Loss	Factor	Pos	Pos	Avg.		
1		( MHz )	( dBμV/m )	( dB )	( dBμV/m )	( dBμV )	( dB/m )	( dB )	( dB )	( cm )	( deg )	(P/A)	(H/V)	
2.4GHz 802.11b LF		30.27	23.75	-16.25	40	29.1	24.39	0.44	30.18			P	H	
		93.45	21.37	-22.13	43.5	35.56	15.36	0.86	30.41			P	H	
		254.37	23.37	-22.63	46	32.89	19.24	1.44	30.2			P	H	
		560.4	28.26	-17.74	46	29.96	25.98	2.03	29.71			P	H	
		747.3	31.08	-14.92	46	30.26	27.95	2.31	29.44	100	0	P	H	
		971.3	34.6	-19.4	54	29.99	30.89	2.74	29.02			P	H	
														H
														H
														H
														H
														H
														H
			36.75	24.99	-15.01	40	33.56	21.24	0.46	30.27			P	V
			123.96	22.42	-21.08	43.5	34.33	17.53	0.93	30.37			P	V
			263.82	21.87	-24.13	46	30.81	19.79	1.46	30.19			P	V
			478.5	25.33	-20.67	46	29.7	23.63	1.83	29.83			P	V
			742.4	40.68	-5.32	46	39.93	27.89	2.31	29.45	100	0	P	V
			965.7	35.27	-18.73	54	30.54	31.02	2.74	29.03			P	V
														V
														V
													V	
													V	
													V	
													V	
<b>Remark</b>	1. No other spurious found. 2. All results are PASS against limit line.													



**Note symbol**

*	<b>Fundamental Frequency</b> which can be ignored. However, the level of any unwanted emissions shall not exceed the level of the fundamental frequency.
!	Test result is <b>over limit</b> line.
P/A	<b>Peak</b> or <b>Average</b>
H/V	<b>Horizontal</b> or <b>Vertical</b>



A calculation example for radiated spurious emission is shown as below:

WIFI	Note	Frequency	Level	Over	Limit	Read	Antenna	Path	Preamp	Ant	Table	Peak	Pol.
Ant.				Limit	Line	Level	Factor	Loss	Factor	Pos	Pos	Avg.	
1		( MHz )	( dBμV/m )	( dB )	( dBμV/m )	( dBμV )	( dB/m )	( dB )	( dB )	( cm )	( deg )	( P/A )	( H/V )
802.11b		2390	55.45	-18.55	74	54.51	32.22	4.58	35.86	103	308	P	H
CH 01													
2412MHz		2390	43.54	-10.46	54	42.6	32.22	4.58	35.86	103	308	A	H

1. Path Loss(dB) = Cable loss(dB) + Filter loss(dB) + Attenuator loss(dB)
2. Level(dBμV/m) =  
Antenna Factor(dB/m) + Path Loss(dB) + Read Level(dBμV) - Preamp Factor(dB)
3. Over Limit(dB) = Level(dBμV/m) – Limit Line(dBμV/m)

**For Peak Limit @ 2390MHz:**

1. Level(dBμV/m)  
= Antenna Factor(dB/m) + Path Loss(dB) + Read Level(dBμV) - Preamp Factor(dB)  
= 32.22(dB/m) + 4.58(dB) + 54.51(dBμV) – 35.86 (dB)  
= 55.45 (dBμV/m)
2. Over Limit(dB)  
= Level(dBμV/m) – Limit Line(dBμV/m)  
= 55.45(dBμV/m) – 74(dBμV/m)  
= -18.55(dB)

**For Average Limit @ 2390MHz:**

1. Level(dBμV/m)  
= Antenna Factor(dB/m) + Path Loss(dB) + Read Level(dBμV) - Preamp Factor(dB)  
= 32.22(dB/m) + 4.58(dB) + 42.6(dBμV) – 35.86 (dB)  
= 43.54 (dBμV/m)
2. Over Limit(dB)  
= Level(dBμV/m) – Limit Line(dBμV/m)  
= 43.54(dBμV/m) – 54(dBμV/m)  
= -10.46(dB)

Both peak and average measured complies with the limit line, so test result is “PASS”.



## Appendix D. Radiated Spurious Emission Plots

Test Engineer :	Watt Tseng, Karl Hou, and Nick Yu	Temperature :	21~23°C
		Relative Humidity :	57~60%

### Note symbol

-L	Low channel location
-R	High channel location





2.4GHz 2400~2483.5MHz
WIFI 802.11b (Band Edge @ 3m)

Table with 4 columns: WIFI, ANT, 1, and two sub-columns for Horizontal and Fundamental. Rows are labeled Peak and Avg. Each cell contains a spectral plot with technical details like Site, Condition, and Date.



WIFI	2.4GHz 2400~2483.5MHz Band Edge @ 3m	
ANT	802.11b CH01 2412MHz	
1	Vertical	Fundamental
Peak	<p>Site : 03CH12-HY Condition : PEAK_BE_74 3m HORN_9120D_1328 VERTICAL : RBW:1000.000kHz VBW:3000.000kHz SWT:Auto</p>	<p>Site : 03CH12-HY Condition : PEAK_74 3m HORN_9120D_1328 VERTICAL : RBW:1000.000kHz VBW:3000.000kHz SWT:Auto</p>
Avg.	<p>Site : 03CH12-HY Condition : AVG_BE_54 3m HORN_9120D_1328 VERTICAL : RBW:1000.000kHz VBW:0.010kHz SWT:Auto</p>	<p>Site : 03CH12-HY Condition : AVG_54 3m HORN_9120D_1328 VERTICAL : RBW:1000.000kHz VBW:0.010kHz SWT:Auto</p>

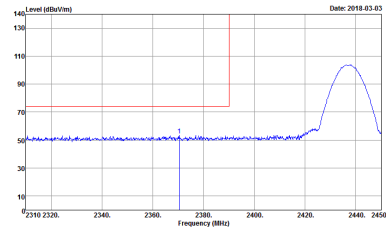
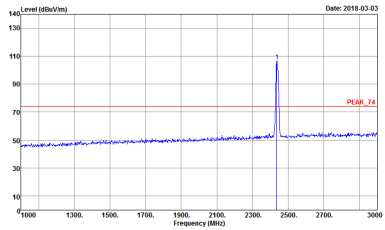
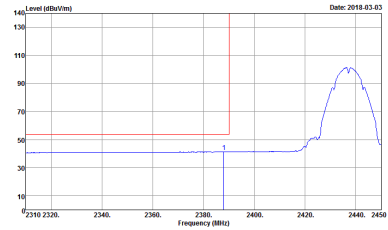
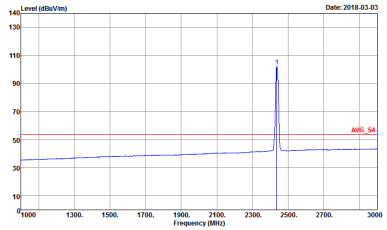

WIFI	2.4GHz 2400~2483.5MHz Band Edge @ 3m	
ANT	802.11b CH06 2437MHz - L	
1	Horizontal	Fundamental
<b>Peak</b>	 <p>Site : 03CH12-HY Condition : PEAK_BE_74 3m HORN_91200_1328 HORIZONTAL : RBW:1000.000kHz VBW:3000.000kHz SWT:Auto</p>	 <p>Site : 03CH12-HY Condition : PEAK_74 3m HORN_91200_1328 HORIZONTAL : RBW:1000.000kHz VBW:3000.000kHz SWT:Auto</p>
<b>Avg.</b>	 <p>Site : 03CH12-HY Condition : AVG_BE_54 3m HORN_91200_1328 HORIZONTAL : RBW:1000.000kHz VBW:0.010kHz SWT:Auto</p>	 <p>Site : 03CH12-HY Condition : AVG_54 3m HORN_91200_1328 HORIZONTAL : RBW:1000.000kHz VBW:0.010kHz SWT:Auto</p>



WIFI	2.4GHz 2400~2483.5MHz Band Edge @ 3m	
ANT	802.11b CH06 2437MHz - R	
1	Horizontal	Fundamental
Peak	<p>Site : 03CH12-HY Condition : PEAK_BE_74 3m HORN_9120D_1328 HORIZONTAL : RBW:1000.000kHz VBW:3000.000kHz SWT:Auto</p>	Left blank
Avg.	<p>Site : 03CH12-HY Condition : AVG_BE_54 3m HORN_9120D_1328 HORIZONTAL : RBW:1000.000kHz VBW:0.010kHz SWT:Auto</p>	Left blank



WIFI	2.4GHz 2400~2483.5MHz Band Edge @ 3m	
ANT	802.11b CH06 2437MHz - L	
1	Vertical	Fundamental
Peak	<p>Site : 03CH12-HY Condition : PEAK_BE_74 3m HORN_9120D_1328 VERTICAL : RBW:1000.000KHz VBW:3000.000KHz SWT:Auto</p>	<p>Site : 03CH12-HY Condition : PEAK_74 3m HORN_9120D_1328 VERTICAL : RBW:1000.000KHz VBW:3000.000KHz SWT:Auto</p>
Avg.	<p>Site : 03CH12-HY Condition : AVG_BE_54 3m HORN_9120D_1328 VERTICAL : RBW:1000.000KHz VBW:0.010KHz SWT:Auto</p>	<p>Site : 03CH12-HY Condition : AVG_54 3m HORN_9120D_1328 VERTICAL : RBW:1000.000KHz VBW:0.010KHz SWT:Auto</p>



WIFI	2.4GHz 2400~2483.5MHz Band Edge @ 3m	
ANT	802.11b CH06 2437MHz - R	
1	Vertical	Fundamental
Peak	<p>Site : 03CH12-HY Condition : PEAK_BE_74 3m HORN_9120D_1328 VERTICAL : RBW:1000.000kHz VBW:3000.000kHz SWT:Auto</p>	Left blank
Avg.	<p>Site : 03CH12-HY Condition : AVG_BE_54 3m HORN_9120D_1328 VERTICAL : RBW:1000.000kHz VBW:0.010kHz SWT:Auto</p>	Left blank



WIFI	2.4GHz 2400~2483.5MHz Band Edge @ 3m	
ANT	802.11b CH11 2462MHz	
1	Horizontal	Fundamental
Peak	<p>Site : 03CH12-HY Condition : PEAK_BE_74 3m HORN_9120D_1328 HORIZONTAL : RBW:1000.000KHz VBW:3000.000KHz SWT:Auto</p>	<p>Site : 03CH12-HY Condition : PEAK_74 3m HORN_9120D_1328 HORIZONTAL : RBW:1000.000KHz VBW:3000.000KHz SWT:Auto</p>
Avg.	<p>Site : 03CH12-HY Condition : AVG_BE_54 3m HORN_9120D_1328 HORIZONTAL : RBW:1000.000KHz VBW:0.010KHz SWT:Auto</p>	<p>Site : 03CH12-HY Condition : AVG_54 3m HORN_9120D_1328 HORIZONTAL : RBW:1000.000KHz VBW:0.010KHz SWT:Auto</p>



WIFI	2.4GHz 2400~2483.5MHz Band Edge @ 3m	
ANT	802.11b CH11 2462MHz	
1	Vertical	Fundamental
Peak	<p>Site : 03CH12-HY Condition : PEAK_BE_74 3m HORN_9120D_1328 VERTICAL : RBW:1000.000kHz VBW:3000.000kHz SWT:Auto</p>	<p>Site : 03CH12-HY Condition : PEAK_74 3m HORN_9120D_1328 VERTICAL : RBW:1000.000kHz VBW:3000.000kHz SWT:Auto</p>
Avg.	<p>Site : 03CH12-HY Condition : AVG_BE_54 3m HORN_9120D_1328 VERTICAL : RBW:1000.000kHz VBW:0.010kHz SWT:Auto</p>	<p>Site : 03CH12-HY Condition : AVG_54 3m HORN_9120D_1328 VERTICAL : RBW:1000.000kHz VBW:0.010kHz SWT:Auto</p>



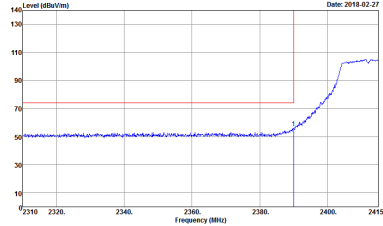
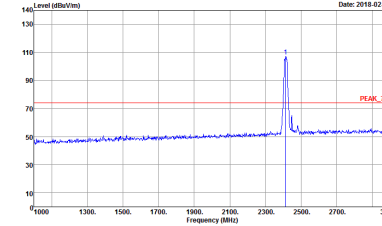
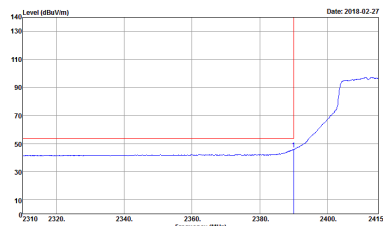
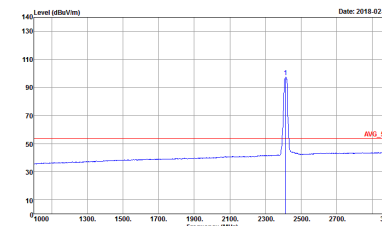

2.4GHz 2400~2483.5MHz  
 WIFI 802.11g (Band Edge @ 3m)

WIFI	2.4GHz 2400~2483.5MHz Band Edge @ 3m	
ANT	802.11g CH01 2412MHz	
1	Horizontal	Fundamental
Peak	 <p>Site : 03CH12-HY            Condition : PEAK_BE_74 3m HORN_9120D_1328 HORIZONTAL            : RBW:1000.000kHz VBW:3000.000kHz SWT:Auto</p>	 <p>Site : 03CH12-HY            Condition : PEAK_74 3m HORN_9120D_1328 HORIZONTAL            : RBW:1000.000kHz VBW:3000.000kHz SWT:Auto</p>
Avg.	 <p>Site : 03CH12-HY            Condition : AVG_BE_54 3m HORN_9120D_1328 HORIZONTAL            : RBW:1000.000kHz VBW:1.000kHz SWT:Auto</p>	 <p>Site : 03CH12-HY            Condition : AVG_54 3m HORN_9120D_1328 HORIZONTAL            : RBW:1000.000kHz VBW:1.000kHz SWT:Auto</p>



WIFI	2.4GHz 2400~2483.5MHz Band Edge @ 3m	
ANT	802.11g CH01 2412MHz	
1	Vertical	Fundamental
<b>Peak</b>	<p>Site : 03CH12-HY Condition : PEAK_BE_74 3m HORN_91200_1328 VERTICAL : RBW:1000.000kHz VBW:3000.000kHz SWT:Auto</p>	<p>Site : 03CH12-HY Condition : PEAK_74 3m HORN_91200_1328 VERTICAL : RBW:1000.000kHz VBW:3000.000kHz SWT:Auto</p>
<b>Avg.</b>	<p>Site : 03CH12-HY Condition : AVG_BE_54 3m HORN_91200_1328 VERTICAL : RBW:1000.000kHz VBW:1.000kHz SWT:Auto</p>	<p>Site : 03CH12-HY Condition : AVG_54 3m HORN_91200_1328 VERTICAL : RBW:1000.000kHz VBW:1.000kHz SWT:Auto</p>

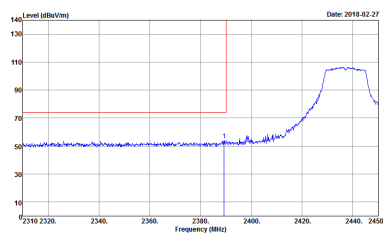
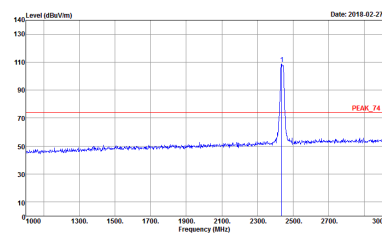
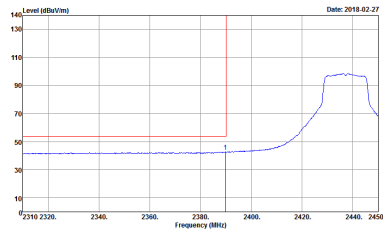
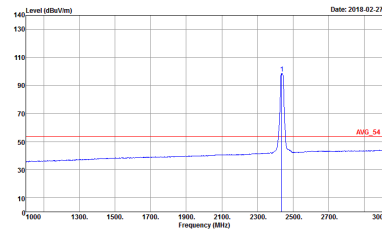

WIFI	2.4GHz 2400~2483.5MHz Band Edge @ 3m	
ANT	802.11g CH06 2437MHz - L	
1	Horizontal	Fundamental
Peak	 <p>Site : 03CH12-HY Condition : PEAK_BE_74 3m HORN_91200_1328 HORIZONTAL : RBW:1000.000kHz VBW:3000.000kHz SWT:Auto</p>	 <p>Site : 03CH12-HY Condition : PEAK_74 3m HORN_91200_1328 HORIZONTAL : RBW:1000.000kHz VBW:3000.000kHz SWT:Auto</p>
Avg.	 <p>Site : 03CH12-HY Condition : AVG_BE_54 3m HORN_91200_1328 HORIZONTAL : RBW:1000.000kHz VBW:1.000kHz SWT:Auto</p>	 <p>Site : 03CH12-HY Condition : AVG_54 3m HORN_91200_1328 HORIZONTAL : RBW:1000.000kHz VBW:1.000kHz SWT:Auto</p>



WIFI	2.4GHz 2400~2483.5MHz Band Edge @ 3m	
ANT	802.11g CH06 2437MHz - R	
1	Horizontal	Fundamental
Peak	<p>Site : 03CH12-HY Condition : PEAK_BE_74 3m HORN_9120D_1328 HORIZONTAL : RBW:1000.000KHz VBW:3000.000KHz SWT:Auto</p>	Left blank
Avg.	<p>Site : 03CH12-HY Condition : AVG_BE_54 3m HORN_9120D_1328 HORIZONTAL : RBW:1000.000KHz VBW:1.000KHz SWT:Auto</p>	Left blank



WIFI	2.4GHz 2400~2483.5MHz Band Edge @ 3m	
ANT	802.11g CH06 2437MHz - L	
1	Vertical	Fundamental
Peak	<p>Site : 03CH12-HY Condition : PEAK_BE_74 3m HORN_9120D_1328 VERTICAL : RBW:1000.000kHz VBW:3000.000kHz SWT:Auto</p>	<p>Site : 03CH12-HY Condition : PEAK_74 3m HORN_9120D_1328 VERTICAL : RBW:1000.000kHz VBW:3000.000kHz SWT:Auto</p>
Avg.	<p>Site : 03CH12-HY Condition : AVG_BE_54 3m HORN_9120D_1328 VERTICAL : RBW:1000.000kHz VBW:1.000kHz SWT:Auto</p>	<p>Site : 03CH12-HY Condition : AVG_54 3m HORN_9120D_1328 VERTICAL : RBW:1000.000kHz VBW:1.000kHz SWT:Auto</p>



WIFI	2.4GHz 2400~2483.5MHz Band Edge @ 3m	
ANT	802.11g CH06 2437MHz - R	
1	Vertical	Fundamental
Peak	<p>Site : 03CH12-HY Condition : PEAK_BE_74 3m HORN_9120D_1328 VERTICAL : RBW:1000.000KHz VBW:3000.000KHz SWT:Auto</p>	Left Blank
Avg.	<p>Site : 03CH12-HY Condition : AVG_BE_54 3m HORN_9120D_1328 VERTICAL : RBW:1000.000KHz VBW:1.000KHz SWT:Auto</p>	Left Blank



WIFI	2.4GHz 2400~2483.5MHz Band Edge @ 3m	
ANT	802.11g CH11 2462MHz	
1	Horizontal	Fundamental
Peak	<p>Site : 03CH12-HY Condition : PEAK_BE_74 3m HORN_9120D_1328 HORIZONTAL : RBW:1000.000kHz VBW:3000.000kHz SWT:Auto</p>	<p>Site : 03CH12-HY Condition : PEAK_74 3m HORN_9120D_1328 HORIZONTAL : RBW:1000.000kHz VBW:3000.000kHz SWT:Auto</p>
Avg.	<p>Site : 03CH12-HY Condition : AVG_BE_54 3m HORN_9120D_1328 HORIZONTAL : RBW:1000.000kHz VBW:1.000kHz SWT:Auto</p>	<p>Site : 03CH12-HY Condition : AVG_54 3m HORN_9120D_1328 HORIZONTAL : RBW:1000.000kHz VBW:1.000kHz SWT:Auto</p>



WIFI	2.4GHz 2400~2483.5MHz Band Edge @ 3m	
ANT	802.11g CH11 2462MHz	
1	Vertical	Fundamental
Peak	<p>Site : 03CH12-HY Condition : PEAK_BE_74 3m HORN_9120D_1328 VERTICAL : RBW:1000.000kHz VBW:3000.000kHz SWT:Auto</p>	<p>Site : 03CH12-HY Condition : PEAK_74 3m HORN_9120D_1328 VERTICAL : RBW:1000.000kHz VBW:3000.000kHz SWT:Auto</p>
Avg.	<p>Site : 03CH12-HY Condition : AVG_BE_54 3m HORN_9120D_1328 VERTICAL : RBW:1000.000kHz VBW:1.000kHz SWT:Auto</p>	<p>Site : 03CH12-HY Condition : AVG_54 3m HORN_9120D_1328 VERTICAL : RBW:1000.000kHz VBW:1.000kHz SWT:Auto</p>



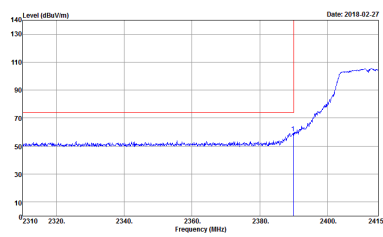
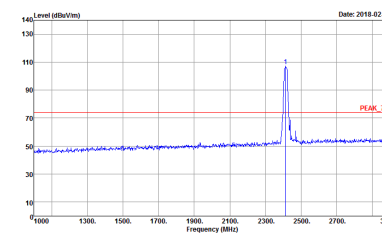
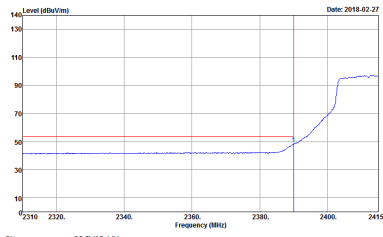
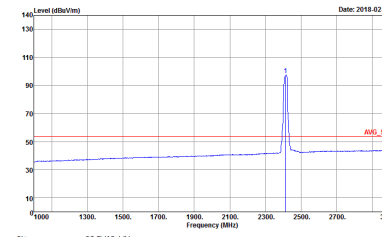

**2.4GHz 2400~2483.5MHz**  
**WIFI 802.11n HT20 (Band Edge @ 3m)**

WIFI	2.4GHz 2400~2483.5MHz Band Edge @ 3m	
ANT	802.11n HT20 CH01 2412MHz	
1	Horizontal	Fundamental
<b>Peak</b>	 <p>Site : 03CH12-HY            Condition : PEAK_BE_74 3m HORN_9120D_1328 HORIZONTAL            : RBW:1000.000kHz VBW:3000.000kHz SWT:Auto</p>	 <p>Site : 03CH12-HY            Condition : PEAK_74 3m HORN_9120D_1328 HORIZONTAL            : RBW:1000.000kHz VBW:3000.000kHz SWT:Auto</p>
<b>Avg.</b>	 <p>Site : 03CH12-HY            Condition : AVG_BE_54 3m HORN_9120D_1328 HORIZONTAL            : RBW:1000.000kHz VBW:1.000kHz SWT:Auto</p>	 <p>Site : 03CH12-HY            Condition : AVG_54 3m HORN_9120D_1328 HORIZONTAL            : RBW:1000.000kHz VBW:1.000kHz SWT:Auto</p>



WIFI	2.4GHz 2400~2483.5MHz Band Edge @ 3m	
ANT	802.11n HT20 CH01 2412MHz	
1	Vertical	Fundamental
<b>Peak</b>	<p>Site : 03CH12-HY Condition : PEAK_BE_74 3m HORN_91200_1328 VERTICAL : RBW:1000.000kHz VBW:3000.000kHz SWT:Auto</p>	<p>Site : 03CH12-HY Condition : PEAK_74 3m HORN_91200_1328 VERTICAL : RBW:1000.000kHz VBW:3000.000kHz SWT:Auto</p>
<b>Avg.</b>	<p>Site : 03CH12-HY Condition : AVG_BE_54 3m HORN_91200_1328 VERTICAL : RBW:1000.000kHz VBW:1.000kHz SWT:Auto</p>	<p>Site : 03CH12-HY Condition : AVG_54 3m HORN_91200_1328 VERTICAL : RBW:1000.000kHz VBW:1.000kHz SWT:Auto</p>

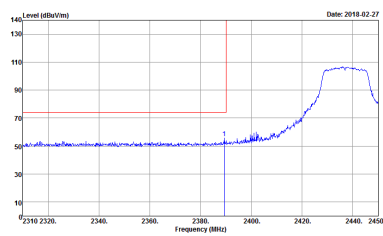
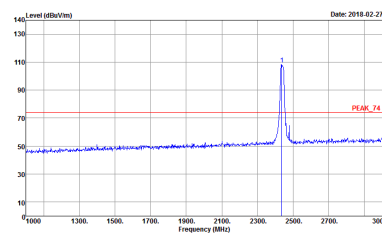
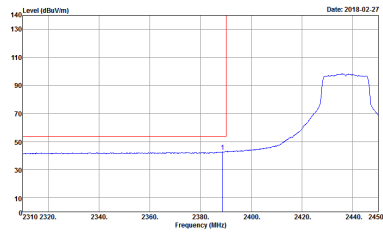
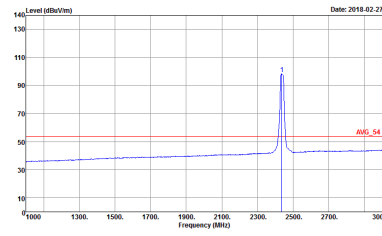

WIFI	2.4GHz 2400~2483.5MHz Band Edge @ 3m	
ANT	802.11n HT20 CH06 2437MHz - L	
1	Horizontal	Fundamental
<b>Peak</b>	 <p>Site : 03CH12-HY Condition : PEAK_BE_74 3m HORN_9120D_1328 HORIZONTAL : RBW:1000.000kHz VBW:3000.000kHz SWT:Auto</p>	 <p>Site : 03CH12-HY Condition : PEAK_74 3m HORN_9120D_1328 HORIZONTAL : RBW:1000.000kHz VBW:3000.000kHz SWT:Auto</p>
<b>Avg.</b>	 <p>Site : 03CH12-HY Condition : AVG_BE_54 3m HORN_9120D_1328 HORIZONTAL : RBW:1000.000kHz VBW:1.000kHz SWT:Auto</p>	 <p>Site : 03CH12-HY Condition : AVG_54 3m HORN_9120D_1328 HORIZONTAL : RBW:1000.000kHz VBW:1.000kHz SWT:Auto</p>



WIFI	2.4GHz 2400~2483.5MHz Band Edge @ 3m	
ANT	802.11n HT20 CH06 2437MHz - R	
1	Horizontal	Fundamental
<p><b>Peak</b></p>	<p>Site : 03CH12-HY Condition : PEAK_BE_74 3m HORN_9120D_1328 HORIZONTAL : RBW:1000.000KHz VBW:3000.000KHz SWT:Auto</p>	<p>Left blank</p>
<p><b>Avg.</b></p>	<p>Site : 03CH12-HY Condition : AVG_BE_54 3m HORN_9120D_1328 HORIZONTAL : RBW:1000.000KHz VBW:1.000KHz SWT:Auto</p>	<p>Left blank</p>



WIFI	2.4GHz 2400~2483.5MHz Band Edge @ 3m	
ANT	802.11n HT20 CH06 2437MHz - L	
1	Vertical	Fundamental
Peak	<p>Site : 03CH12-HY Condition : PEAK_BE_74 3m HORN_9120D_1328 VERTICAL : RBW:1000.000KHz VBW:3000.000KHz SWT:Auto</p>	<p>Site : 03CH12-HY Condition : PEAK_74 3m HORN_9120D_1328 VERTICAL : RBW:1000.000KHz VBW:3000.000KHz SWT:Auto</p>
Avg.	<p>Site : 03CH12-HY Condition : AVG_BE_54 3m HORN_9120D_1328 VERTICAL : RBW:1000.000KHz VBW:1.000KHz SWT:Auto</p>	<p>Site : 03CH12-HY Condition : AVG_54 3m HORN_9120D_1328 VERTICAL : RBW:1000.000KHz VBW:1.000KHz SWT:Auto</p>



WIFI	2.4GHz 2400~2483.5MHz Band Edge @ 3m	
ANT	802.11n HT20 CH06 2437MHz - R	
1	Vertical	Fundamental
Peak	<p>Site : 03CH12-HY Condition : PEAK_BE_74 3m HORN_9120D_1328 VERTICAL : RBW:1000.000KHz VBW:3000.000KHz SWT:Auto</p>	Left Blank
Avg.	<p>Site : 03CH12-HY Condition : AVG_BE_54 3m HORN_9120D_1328 VERTICAL : RBW:1000.000KHz VBW:1.000KHz SWT:Auto</p>	Left Blank

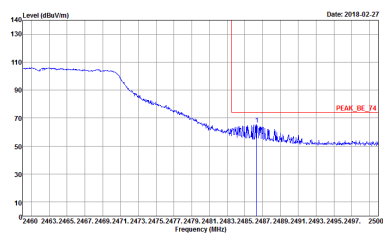
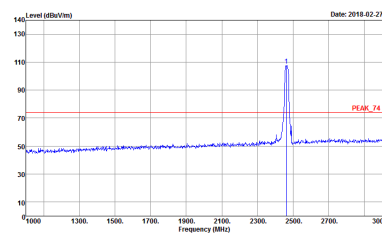
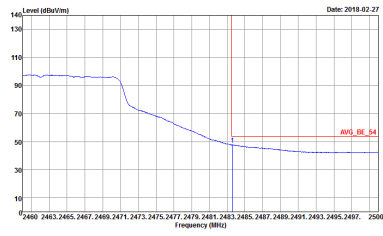
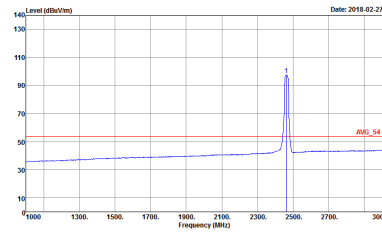

WIFI	2.4GHz 2400~2483.5MHz Band Edge @ 3m	
ANT	802.11n HT20 CH11 2462MHz	
1	Horizontal	Fundamental
Peak	 <p>Site : 03CH12-HY Condition : PEAK_BE_74 3m HORN_9120D_1328 HORIZONTAL : RBW:1000.000kHz VBW:3000.000kHz SWT:Auto</p>	 <p>Site : 03CH12-HY Condition : PEAK_74 3m HORN_9120D_1328 HORIZONTAL : RBW:1000.000kHz VBW:3000.000kHz SWT:Auto</p>
Avg.	 <p>Site : 03CH12-HY Condition : AVG_BE_54 3m HORN_9120D_1328 HORIZONTAL : RBW:1000.000kHz VBW:1.000kHz SWT:Auto</p>	 <p>Site : 03CH12-HY Condition : AVG_54 3m HORN_9120D_1328 HORIZONTAL : RBW:1000.000kHz VBW:1.000kHz SWT:Auto</p>



WIFI	2.4GHz 2400~2483.5MHz Fundamental @ 3m	
ANT	802.11n HT20 CH11 2462MHz	
1	Vertical	Fundamental
Peak	<p>Site : 03CH12-HY Condition : PEAK_BE_74 3m HORN_9120D_1328 VERTICAL : RBW:1000.000KHz VBW:3000.000KHz SWT:Auto</p>	<p>Site : 03CH12-HY Condition : PEAK_74 3m HORN_9120D_1328 VERTICAL : RBW:1000.000KHz VBW:3000.000KHz SWT:Auto</p>
Avg.	<p>Site : 03CH12-HY Condition : AVG_BE_54 3m HORN_9120D_1328 VERTICAL : RBW:1000.000KHz VBW:1.000KHz SWT:Auto</p>	<p>Site : 03CH12-HY Condition : AVG_54 3m HORN_9120D_1328 VERTICAL : RBW:1000.000KHz VBW:1.000KHz SWT:Auto</p>





2.4GHz 2400~2483.5MHz  
 WIFI 802.11b (Harmonic @ 3m)

WIFI	2.4GHz 2400~2483.5MHz Harmonic @ 3m	
ANT	802.11b CH01 2412MHz	
1	Horizontal	Vertical
Peak Avg.	<p>Site : 03CH12-HY        Condition : PEAK_74 3m HORN_91200_1328 HORIZONTAL        Detector : Peak</p>	<p>Site : 03CH12-HY        Condition : PEAK_74 3m HORN_91200_1328 VERTICAL        Detector : Peak</p>

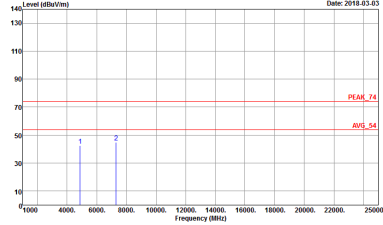
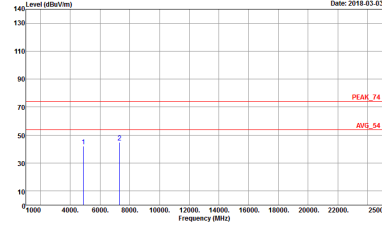

WIFI	2.4GHz 2400~2483.5MHz Harmonic @ 3m	
ANT	802.11b CH06 2437MHz	
1	Horizontal	Vertical
<p>Peak Avg.</p>	 <p>Site : 03CH12-HY Condition : PEAK_74 3m HORN_91200_1328 HORIZONTAL Detector : Peak</p>	 <p>Site : 03CH12-HY Condition : PEAK_74 3m HORN_91200_1328 VERTICAL Detector : Peak</p>



WIFI	2.4GHz 2400~2483.5MHz Harmonic @ 3m	
ANT	802.11b CH11 2462MHz	
1	Horizontal	Vertical
<b>Peak</b> <b>Avg.</b>	<p>Site : 03CH12-HY Condition : PEAK_74 3m HORN_91200_1328 HORIZONTAL Detector : Peak</p>	<p>Site : 03CH12-HY Condition : PEAK_74 3m HORN_91200_1328 VERTICAL Detector : Peak</p>



2.4GHz 2400~2483.5MHz  
 WIFI 802.11g (Harmonic @ 3m)

WIFI	2.4GHz 2400~2483.5MHz Harmonic @ 3m	
ANT	802.11g CH01 2412MHz	
1	Horizontal	Vertical
Peak Avg.	<p>Site : 03CH12-HY          Condition : PEAK_74 3m HORN_91200_1328 HORIZONTAL          Detector : Peak</p>	<p>Site : 03CH12-HY          Condition : PEAK_74 3m HORN_91200_1328 VERTICAL          Detector : Peak</p>

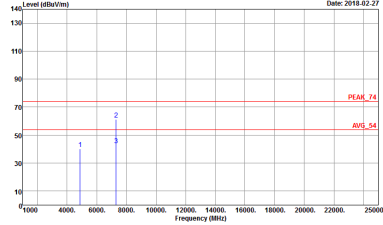
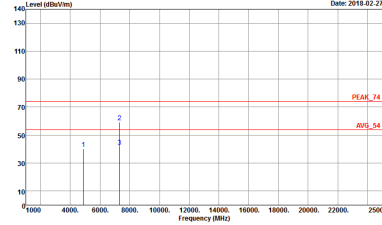

WIFI	2.4GHz 2400~2483.5MHz Harmonic @ 3m	
ANT	802.11g CH06 2437MHz	
1	Horizontal	Vertical
<p>Peak Avg.</p>	 <p>Site : 03CH12-HY Condition : PEAK_74 3m HORN_91200_1328 HORIZONTAL Detector : Peak</p>	 <p>Site : 03CH12-HY Condition : PEAK_74 3m HORN_91200_1328 VERTICAL Detector : Peak</p>



WIFI	2.4GHz 2400~2483.5MHz Harmonic @ 3m	
ANT	802.11g CH11 2462MHz	
1	Horizontal	Vertical
<b>Peak</b> <b>Avg.</b>	<p>Site : 03CH12-HY Condition : PEAK_74 3m HORN_91200_1328 HORIZONTAL Detector : Peak</p>	<p>Site : 03CH12-HY Condition : PEAK_74 3m HORN_91200_1328 VERTICAL Detector : Peak</p>



2.4GHz 2400~2483.5MHz  
 WIFI 802.11n HT20 (Harmonic @ 3m)

WIFI	2.4GHz 2400~2483.5MHz Harmonic @ 3m	
ANT	802.11n HT20 CH01 2412MHz	
1	Horizontal	Vertical
Peak Avg.	<p>Site : 03CH12-HY          Condition : PEAK_74 3m HORN_91200_1328 HORIZONTAL          Detector : Peak</p>	<p>Site : 03CH12-HY          Condition : PEAK_74 3m HORN_91200_1328 VERTICAL          Detector : Peak</p>

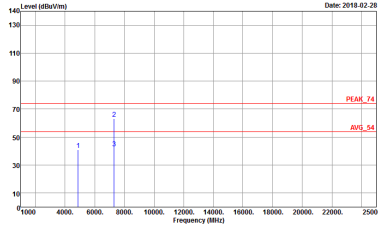
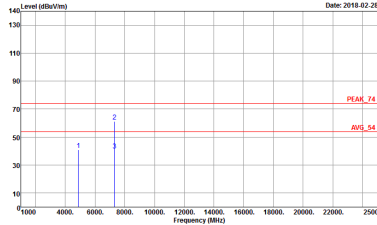

WIFI	2.4GHz 2400~2483.5MHz Harmonic @ 3m	
ANT	802.11n HT20 CH06 2437MHz	
1	Horizontal	Vertical
<p>Peak Avg.</p>	 <p>Site : 03CH12-HY Condition : PEAK_74 3m HORN_91200_1328 HORIZONTAL Detector : Peak</p>	 <p>Site : 03CH12-HY Condition : PEAK_74 3m HORN_91200_1328 VERTICAL Detector : Peak</p>



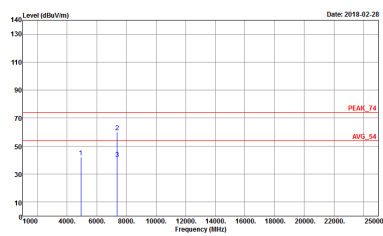
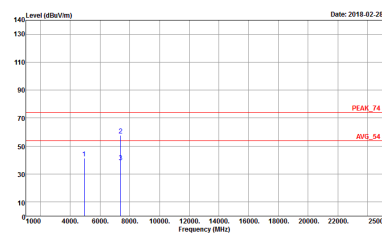

<b>WIFI</b>	<b>2.4GHz 2400~2483.5MHz Harmonic @ 3m</b>	
<b>ANT</b>	<b>802.11n HT20 CH11 2462MHz</b>	
<b>1</b>	<b>Horizontal</b>	<b>Vertical</b>
<p><b>Peak</b> <b>Avg.</b></p>	 <p>Site : 03CH12-HY Condition : PEAK_74 3m HORN_91200_1328 HORIZONTAL Detector : Peak</p>	 <p>Site : 03CH12-HY Condition : PEAK_74 3m HORN_91200_1328 VERTICAL Detector : Peak</p>



Emission below 1GHz  
2.4GHz WIFI 802.11b (LF)

WIFI	2.4GHz 2400~2483.5MHz	
ANT	802.11b LF	
1	Horizontal	Vertical
QP / Peak	<p>Site : 03CH12-HY Condition : QP 3m BTL06_6111D_40103 HORIZONTAL Detector : Peak</p>	<p>Site : 03CH12-HY Condition : QP 3m BTL06_6111D_40103 VERTICAL Detector : Peak</p>

## Appendix E. Duty Cycle Plots

Band	Duty Cycle(%)	T(us)	1/T(kHz)	VBW Setting	Duty Factor(dB)
802.11b	98.89	-	-	10Hz	0.05
802.11g	94.50	2.060	0.49	1KHz	0.25
2.4GHz 802.11n HT20	94.12	1.920	0.52	1KHz	0.26

### 802.11b

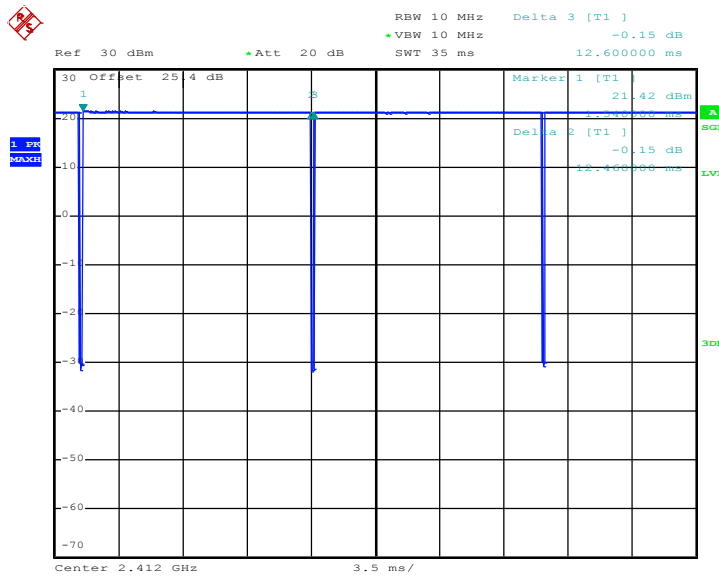

Date: 7.FEB.2018 20:43:46



802.11g

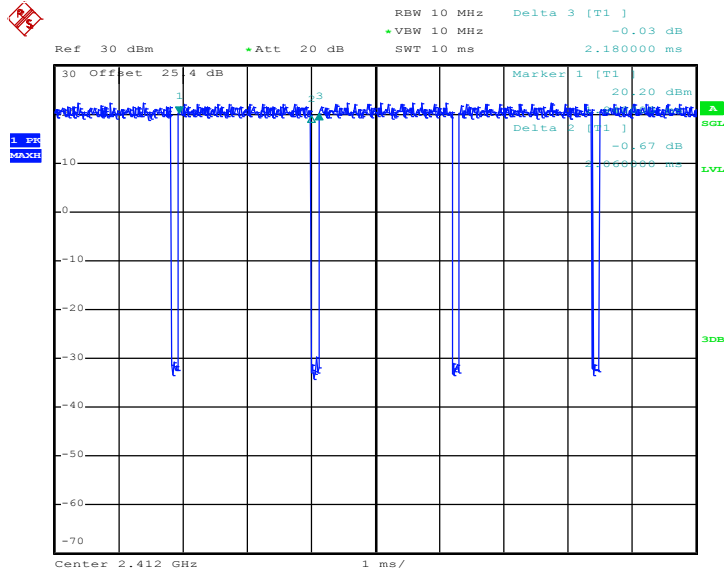

Date: 12.FEB.2018 11:36:29

802.11n HT20

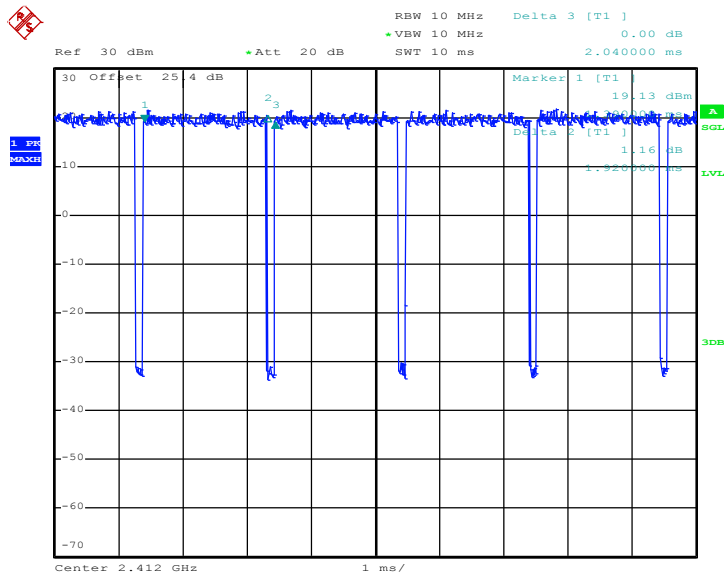

Date: 12.FEB.2018 11:45:22