



FCC RF Test Report

APPLICANT : Motorola Mobility LLC
EQUIPMENT : Mobile Cellular Phone
BRAND NAME : Motorola
MODEL NAME : XT1929-1(SS)
FCC ID : IHDT56XE2
STANDARD : FCC Part 15 Subpart C §15.247
CLASSIFICATION : (DTS) Digital Transmission System

The product was received on Jan. 18, 2018 and testing was completed on Mar. 03, 2018. We, SPORTON INTERNATIONAL INC., would like to declare that the tested sample has been evaluated in accordance with the test procedures and has been in compliance with the applicable technical standards.

The test results in this report apply exclusively to the tested model / sample. Without written approval of SPORTON INTERNATIONAL INC., the test report shall not be reproduced except in full.

Reviewed by: Joseph Lin / Supervisor

Approved by: Jones Tsai / Manager



SPORTON INTERNATIONAL INC.

No. 52, Hwa Ya 1st Rd., Hwa Ya Technology Park, Kwei-Shan District, Tao Yuan City, Taiwan, R.O.C.

SPORTON INTERNATIONAL INC.

TEL : 886-3-327-3456

FAX : 886-3-328-4978

FCC ID: IHDT56XE2

Page Number : 1 of 44

Report Issued Date : Mar. 08, 2018

Report Version : Rev. 01

Report Template No.: BU5-FR15CBT4.0 Version 2.0



TABLE OF CONTENTS

REVISION HISTORY.....3

SUMMARY OF TEST RESULT4

1 GENERAL DESCRIPTION.....5

 1.1 Applicant5

 1.2 Manufacturer.....5

 1.3 Product Feature of Equipment Under Test.....5

 1.4 Product Specification of Equipment Under Test.....6

 1.5 Modification of EUT6

 1.6 Testing Location7

 1.7 Applicable Standards.....7

2 TEST CONFIGURATION OF EQUIPMENT UNDER TEST.....8

 2.1 Carrier Frequency Channel8

 2.2 Test Mode.....9

 2.3 Connection Diagram of Test System.....10

 2.4 Support Unit used in test configuration and system11

 2.5 EUT Operation Test Setup11

 2.6 Measurement Results Explanation Example.....11

3 TEST RESULT12

 3.1 6dB and 99% Bandwidth Measurement12

 3.2 Output Power Measurement.....19

 3.3 Power Spectral Density Measurement20

 3.4 Conducted Band Edges and Spurious Emission Measurement27

 3.5 Radiated Band Edges and Spurious Emission Measurement36

 3.6 AC Conducted Emission Measurement.....40

 3.7 Antenna Requirements42

4 LIST OF MEASURING EQUIPMENT.....43

5 UNCERTAINTY OF EVALUATION.....44

APPENDIX A. TEST RESULT OF CONDUCTED TEST ITEMS

APPENDIX B. AC CONDUCTED EMISSION TEST RESULT

APPENDIX C. RADIATED SPURIOUS EMISSION

APPENDIX D. RADIATED SPURIOUS EMISSION PLOTS

APPENDIX E. DUTY CYCLE PLOTS



REVISION HISTORY

REPORT NO.	VERSION	DESCRIPTION	ISSUED DATE
FR811821-02B	Rev. 01	Initial issue of report	Mar. 08, 2018



SUMMARY OF TEST RESULT

Report Section	FCC Rule	Description	Limit	Result	Remark
3.1	15.247(a)(2)	6dB Bandwidth	$\geq 0.5\text{MHz}$	Pass	-
3.1	-	99% Bandwidth	-	Pass	-
3.2	15.247(b)(3)	Peak Output Power	$\leq 30\text{dBm}$	Pass	-
3.3	15.247(e)	Power Spectral Density	$\leq 8\text{dBm}/3\text{kHz}$	Pass	-
3.4	15.247(d)	Conducted Band Edges and Spurious Emission	$\leq 20\text{dBc}$	Pass	-
3.5	15.247(d)	Radiated Band Edges and Spurious Emission	15.209(a) & 15.247(d)	Pass	Under limit 6.74 dB at 2483.520 MHz
3.6	15.207	AC Conducted Emission	15.207(a)	Pass	Under limit 13.84 dB at 0.263 MHz
3.7	15.203 & 15.247(b)	Antenna Requirement	N/A	Pass	-



1 General Description

1.1 Applicant

Motorola Mobility LLC
222 W,Merchandise Mart Plaza, Chicago IL 60654 USA

1.2 Manufacturer

Motorola Mobility LLC
222 W,Merchandise Mart Plaza, Chicago IL 60654 USA

1.3 Product Feature of Equipment Under Test

Product Feature	
Equipment	Mobile Cellular Phone
Brand Name	Motorola
Model Name	XT1929-1(SS)
FCC ID	IHDT56XE2
IMEI Code	Conducted : IMEI: 351885090004200 Conduction : IMEI: 351885090010991 Radiation : IMEI: 351885090010702
EUT supports Radios application	CDMA/EV-DO/GSM/EGPRS/WCDMA/HSPA/LTE/GNSS/NFC WLAN 11b/g/n HT20 WLAN 11a/n HT20/HT40 WLAN 11ac VHT20/VHT40/VHT80 Bluetooth BR/EDR/LE
HW Version	DVT2
EUT Stage	Identical Prototype

Remark: The above EUT's information was declared by manufacturer. Please refer to the specifications or user's manual for more detailed description.



Accessory List	
AC Adapter 1	Brand Name : Motorola
	Model Name : SC-22 SPN5970A
	Manufacturer : Salom
AC Adapter 2	Brand Name : Motorola
	Model Name : SC-22 SPN5993A
	Manufacturer : Chenyang
Battery	Brand Name : Motorola
	Model Name : JS40
	Manufacturer : SUNWODA
C2Audio Cable 1	Brand Name : Motorola
	Model Name : SC18C27844
	Manufacturer : Luxshare
C2Audio Cable 2	Brand Name : Motorola
	Model Name : SC18C27845
	Manufacturer : Cabletech
USB Cable 1	Brand Name : Cabletech
	Model Name : SKN6473A
USB Cable 2	Brand Name : FOXLINK
	Model Name : SKN6473A 17195-C 0403532
USB Cable 3	Brand Name : SAIBAO
	Model Name : SKN6473A 17214-C 1127044
USB Cable 4	Brand Name : Luxshare
	Model Name : SKN6473A 17227-C 1126538

1.4 Product Specification of Equipment Under Test

Standards-related Product Specification	
Tx/Rx Frequency Range	2402 MHz ~ 2480 MHz
Number of Channels	40
Carrier Frequency of Each Channel	40 Channel(37 hopping + 3 advertising channel)
Maximum Output Power to Antenna	Bluetooth LE (1Mbps) : 12.33 dBm (0.0171 W) Bluetooth LE (2Mbps) : 12.62 dBm (0.0183 W)
99% Occupied Bandwidth	Bluetooth LE (1Mbps) : 1.028MHz Bluetooth LE (2Mbps) : 2.048MHz
Antenna Type / Gain	Internal Antenna with gain -5.0 dBi
Type of Modulation	Bluetooth LE : GFSK

1.5 Modification of EUT

No modifications are made to the EUT during all test items.



1.6 Testing Location

Sporton Lab is accredited to ISO 17025 by Taiwan Accreditation Foundation (TAF code : 1190) and the FCC designation No. TW1190 and TW0007 under the FCC 2.948(e) by Mutual Recognition Agreement (MRA) in FCC Test.

Test Site	SPORTON INTERNATIONAL INC.	
Test Site Location	No. 52, Hwa Ya 1st Rd., Hwa Ya Technology Park, Kwei-Shan District, Tao Yuan City, Taiwan, R.O.C. TEL: +886-3-327-3456 FAX: +886-3-328-4978	
Test Site No.	Sporton Site No.	
	TH05-HY	CO05-HY

Note: The test site complies with ANSI C63.4 2014 requirement.

Test Site	SPORTON INTERNATIONAL INC.	
Test Site Location	No.58, Aly. 75, Ln. 564, Wenhua 3rd Rd. Guishan Dist, Taoyuan City, Taiwan (R.O.C.) TEL: +886-3-327-3456 FAX: +886-3-328-4978	
Test Site No.	Sporton Site No.	
	03CH12-HY	

Note: The test site complies with ANSI C63.4 2014 requirement.

1.7 Applicable Standards

According to the specifications of the manufacturer, the EUT must comply with the requirements of the following standards:

- ♦ FCC Part 15 Subpart C §15.247
- ♦ FCC KDB Publication No. 558074 D01 DTS Meas. Guidance v04
- ♦ ANSI C63.10-2013

Remark:

1. All test items were verified and recorded according to the standards and without any deviation during the test.
2. This EUT has also been tested and complied with the requirements of FCC Part 15, Subpart B, recorded in a separate test report.



2 Test Configuration of Equipment Under Test

2.1 Carrier Frequency Channel

Frequency Band	Channel	Freq. (MHz)	Channel	Freq. (MHz)
2400-2483.5 MHz	0	2402	21	2444
	1	2404	22	2446
	2	2406	23	2448
	3	2408	24	2450
	4	2410	25	2452
	5	2412	26	2454
	6	2414	27	2456
	7	2416	28	2458
	8	2418	29	2460
	9	2420	30	2462
	10	2422	31	2464
	11	2424	32	2466
	12	2426	33	2468
	13	2428	34	2470
	14	2430	35	2472
	15	2432	36	2474
	16	2434	37	2476
	17	2436	38	2478
	18	2438	39	2480
	19	2440	-	-
20	2442	-	-	



2.2 Test Mode

- a. The EUT has been associated with peripherals and configuration operated in a manner tended to maximize its emission characteristics in a typical application. Frequency range investigated: conduction emission (150 kHz to 30 MHz), radiation emission (9 kHz to the 10th harmonic of the highest fundamental frequency or to 40 GHz, whichever is lower). For radiated measurement, pre-scanned in three orthogonal panels, X, Y, Z. The worst cases (Z plane) were recorded in this report.
- b. AC power line Conducted Emission was tested under maximum output power.

The following summary table is showing all test modes to demonstrate in compliance with the standard.

Summary table of Test Cases	
Test Item	Data Rate / Modulation
	Bluetooth – LE / GFSK
Conducted TCs	Mode 1: Bluetooth Tx CH00_2402 MHz_1Mbps Mode 2: Bluetooth Tx CH19_2440 MHz_1Mbps Mode 3: Bluetooth Tx CH39_2480 MHz_1Mbps
Radiated TCs	Mode 1: Bluetooth Tx CH00_2402 MHz_1Mbps Mode 2: Bluetooth Tx CH19_2440 MHz_1Mbps Mode 3: Bluetooth Tx CH39_2480 MHz_1Mbps
AC Conducted Emission	Mode 1 :GSM850 Idle + Bluetooth Link + WLAN (2.4GHz) Link + MP3 + Battery + USB Cable 1 Type C (Charging from Adapter 1)
Remark: For Radiated Test Cases, The tests were performance with USB Cable 1 Type C.	

2.3 Connection Diagram of Test System

<Bluetooth – LE Tx Mode>

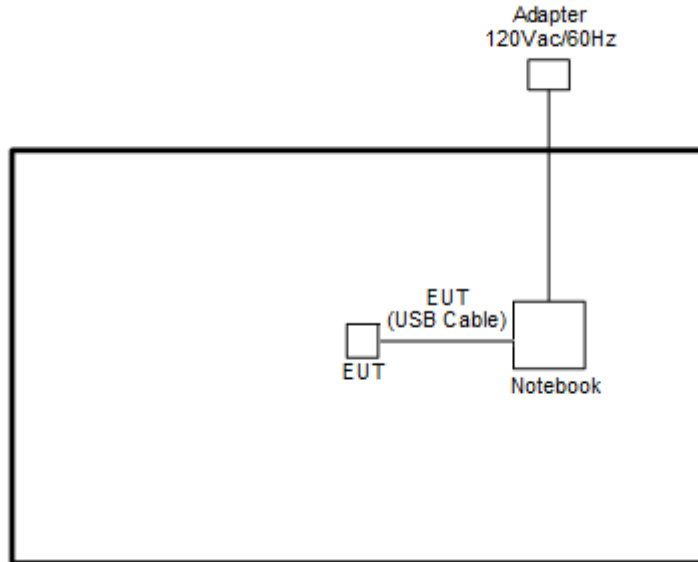

<AC Conducted Emission Mode>

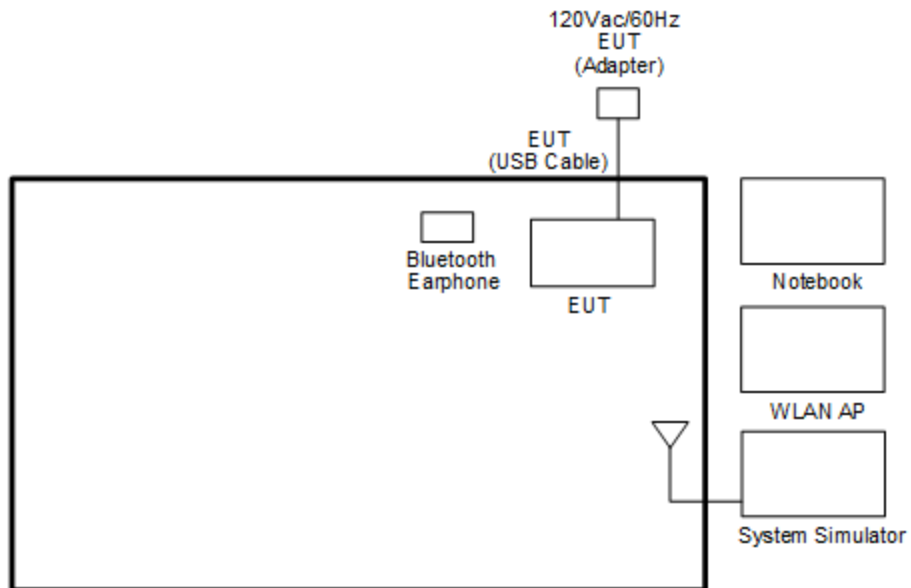



2.4 Support Unit used in test configuration and system

Item	Equipment	Trade Name	Model Name	FCC ID	Data Cable	Power Cord
1.	System Simulator	Anritsu	MT8820C	N/A	N/A	Unshielded, 1.8 m
2.	WLAN AP	ASUS	RT-AC66U	KA2DIR628A2	N/A	Unshielded, 1.8 m
3.	Notebook	DELL	Latitude E6320	FCC DoC/ Contains FCC ID: QDS-BRCM1054	N/A	AC I/P: Unshielded, 1.2 m DC O/P: Shielded, 1.8 m
4.	Notebook	Lenovo	E335	FCC DoC	N/A	AC I/P: Unshielded, 1.2 m DC O/P: Shielded, 1.8 m
5.	SD Card	SanDisk	MicroSD HC	FCC DoC	N/A	N/A
6.	Bluetooth Earphone	Lenovo	LBH 301	PYAHS-107W	N/A	N/A

2.5 EUT Operation Test Setup

The RF test items, utility “QRCT” was installed in Notebook which was programmed in order to make the EUT get into the engineering modes to provide channel selection, power level, data rate and the application type and for continuous transmitting signals.

2.6 Measurement Results Explanation Example

For all conducted test items:

The offset level is set in the spectrum analyzer to compensate the RF cable loss and attenuator factor between EUT conducted output port and spectrum analyzer. With the offset compensation, the spectrum analyzer reading level is exactly the EUT RF output level.

Example :

The spectrum analyzer offset is derived from RF cable loss and attenuator factor.

Offset = RF cable loss + attenuator factor.

Following shows an offset computation example with cable loss 4.2 dB and 10dB attenuator.

$$\begin{aligned} \text{Offset(dB)} &= \text{RF cable loss(dB)} + \text{attenuator factor(dB)}. \\ &= 4.2 + 10 = 14.2 \text{ (dB)} \end{aligned}$$

3 Test Result

3.1 6dB and 99% Bandwidth Measurement

3.1.1 Limit of 6dB and 99% Bandwidth

The minimum 6 dB bandwidth shall be at least 500 kHz.

3.1.2 Measuring Instruments

The section 4.0 of List of Measuring Equipment of this test report is used for test.

3.1.3 Test Procedures

1. The testing follows FCC KDB Publication No. 558074 D01 DTS Meas. Guidance v04.
2. The RF output of EUT was connected to the spectrum analyzer by RF cable and attenuator. The path loss was compensated to the results for each measurement.
3. Set to the maximum power setting and enable the EUT transmit continuously.
4. Make the measurement with the spectrum analyzer's resolution bandwidth (RBW) = 100 kHz. Set the Video bandwidth (VBW) = 300 kHz. In order to make an accurate measurement. The 6 dB bandwidth must be greater than 500 kHz.
5. For 99% Bandwidth Measurement, the spectrum analyzer's resolution bandwidth (RBW) is set 30kHz and set the Video bandwidth (VBW) = 100kHz.
6. Measure and record the results in the test report.

3.1.4 Test Setup





3.1.5 Test Result of 6dB Bandwidth

Please refer to Appendix A.

<1Mbps>

6 dB Bandwidth Plot on Channel 00

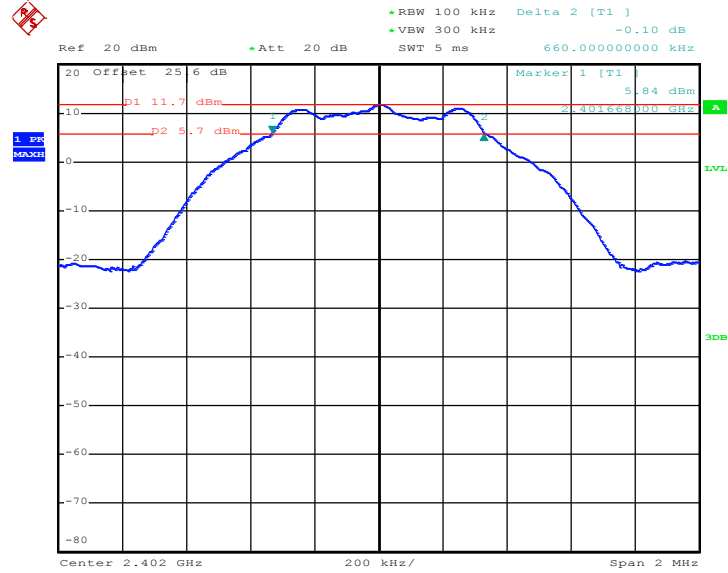

Date: 19.FEB.2018 18:30:50

6 dB Bandwidth Plot on Channel 19

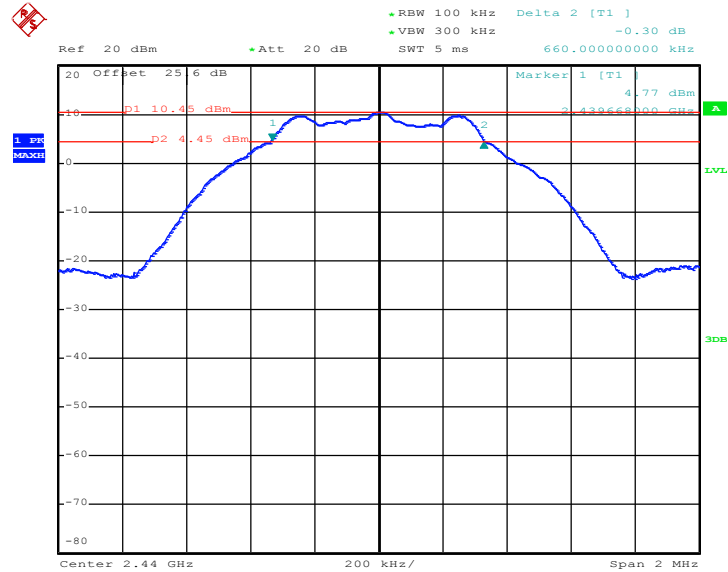

Date: 19.FEB.2018 18:38:34



6 dB Bandwidth Plot on Channel 39

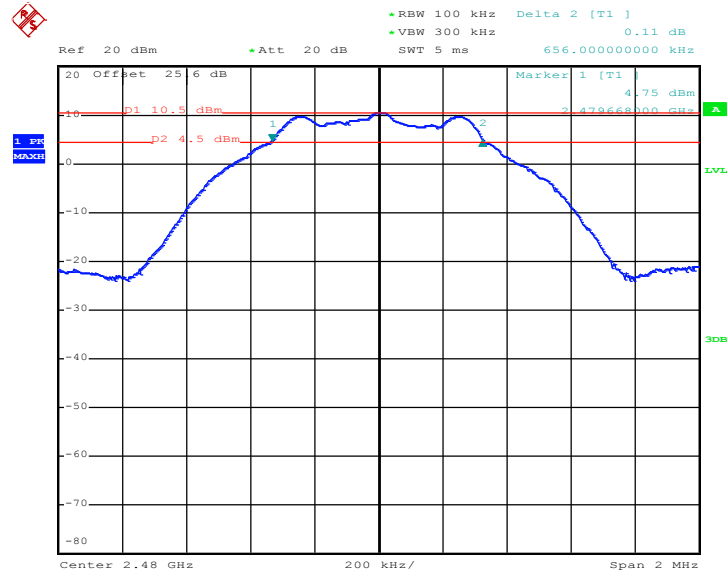

Date: 19.FEB.2018 18:41:51

<2Mbps>

6 dB Bandwidth Plot on Channel 00

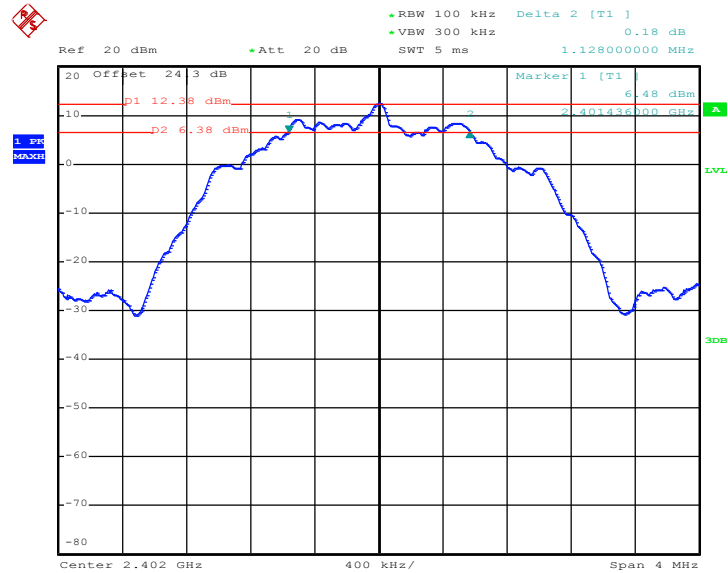

Date: 26.FEB.2018 21:15:56



6 dB Bandwidth Plot on Channel 19

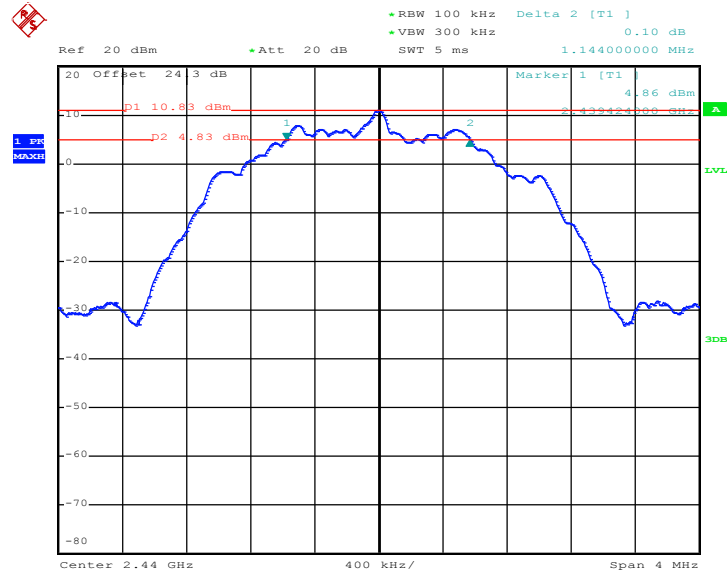

Date: 26.FEB.2018 21:22:15

6 dB Bandwidth Plot on Channel 39

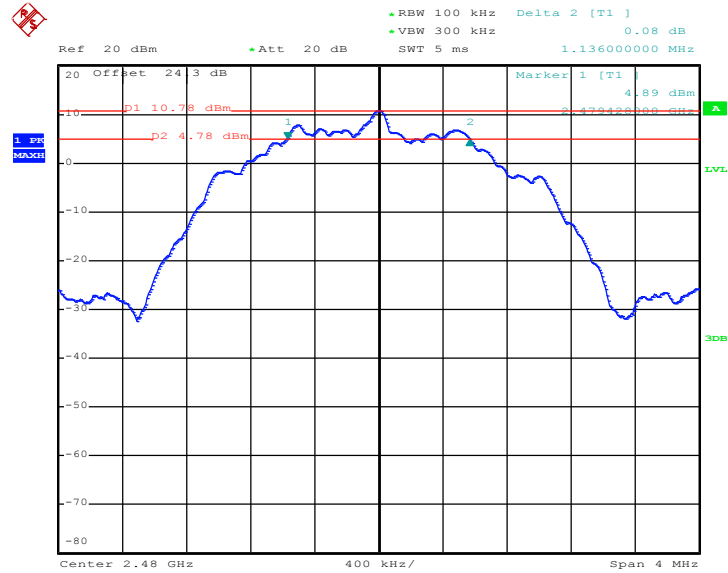

Date: 26.FEB.2018 21:27:42



3.1.6 Test Result of 99% Occupied Bandwidth

Please refer to Appendix A.

<1Mbps>

99% Bandwidth Plot on Channel 00

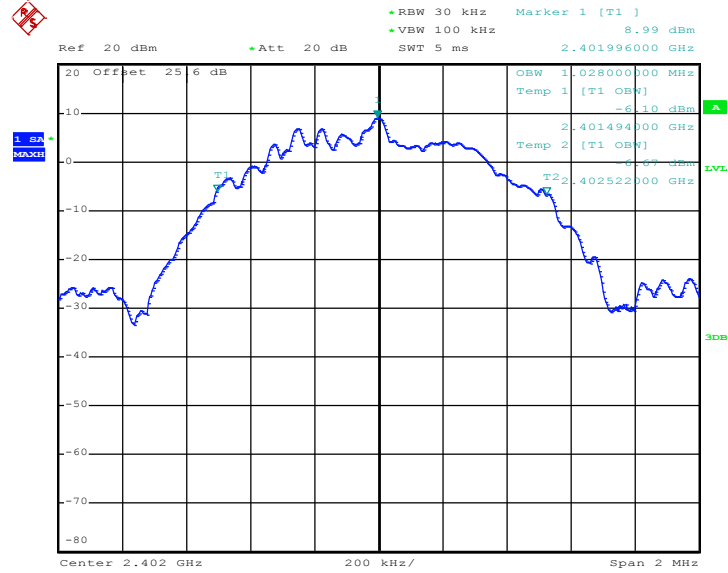

Date: 19.FEB.2018 18:36:07

99% Occupied Bandwidth Plot on Channel 19

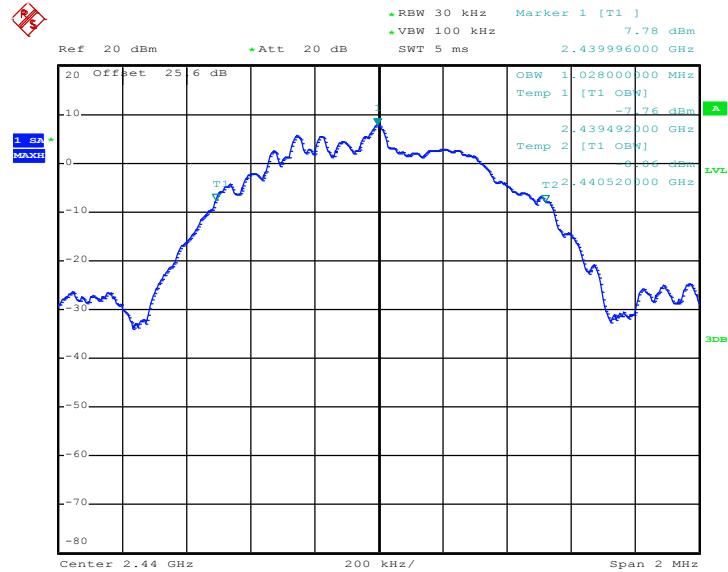

Date: 19.FEB.2018 18:40:09



99% Occupied Bandwidth Plot on Channel 39

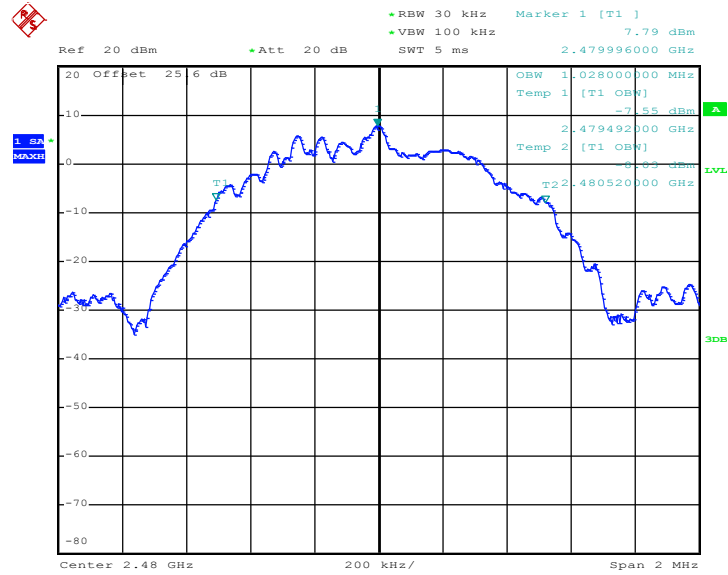

Date: 19.FEB.2018 18:43:22

<2Mbps>

99% Bandwidth Plot on Channel 00

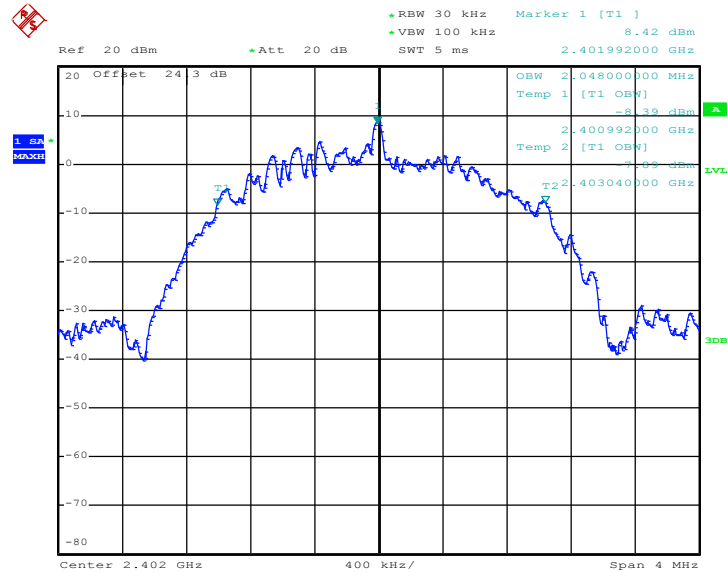

Date: 26.FEB.2018 21:18:01



99% Occupied Bandwidth Plot on Channel 19

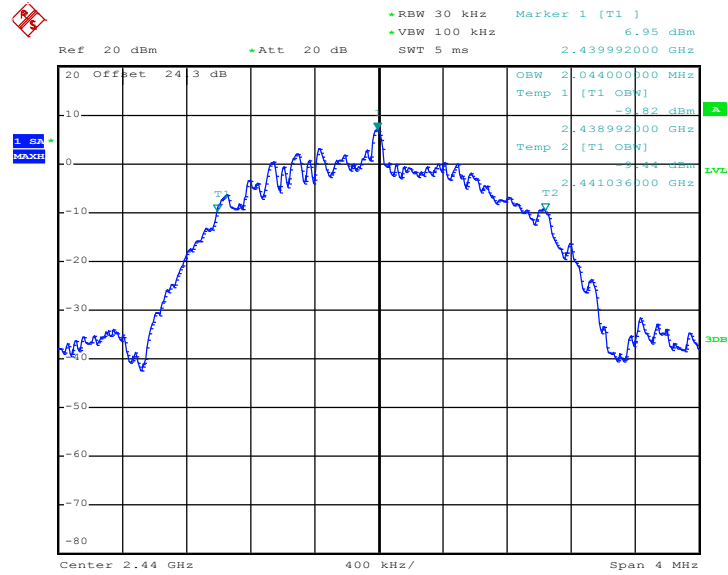

Date: 26.FEB.2018 21:24:48

99% Occupied Bandwidth Plot on Channel 39

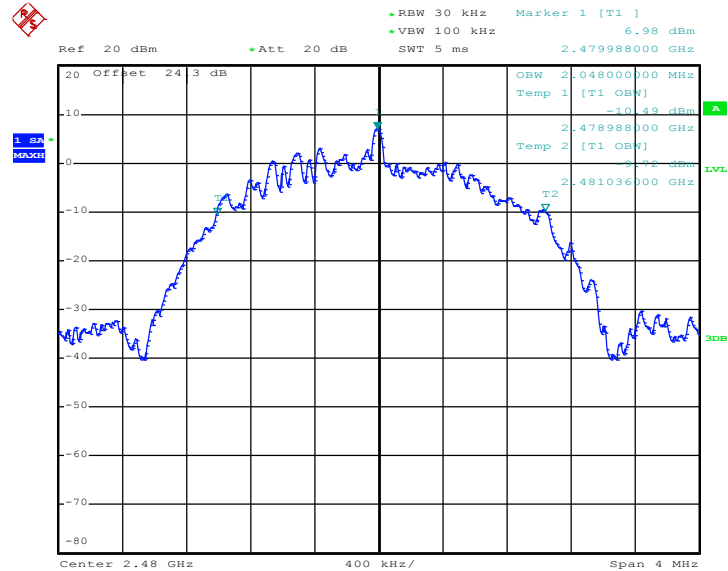

Date: 26.FEB.2018 21:30:03

Note : The occupied channel bandwidth is maintained within the band of operation for all of the modulations.

3.2 Output Power Measurement

3.2.1 Limit of Output Power

For systems using digital modulation in the 2400-2483.5MHz, the limit for peak output power is 30dBm. If transmitting antenna of directional gain greater than 6dBi is used, the peak output power from the intentional radiator shall be reduced below the above stated value by the amount in dB that the directional gain of the antenna exceeds 6 dBi. In case of point-to-point operation, the limit has to be reduced by 1dB for every 3dB that the directional gain of the antenna exceeds 6dBi.

3.2.2 Measuring Instruments

The section 4.0 of List of Measuring Equipment of this test report is used for test.

3.2.3 Test Procedures

1. The testing follows the Measurement Procedure of FCC KDB No. 558074 DTS D01 Meas. Guidance v04 section 9.1.3 PKPM1 Peak power meter method.
2. The RF output of EUT was connected to the power meter by RF cable and attenuator. The path loss was compensated to the results for each measurement.
3. Set to the maximum power setting and enable the EUT transmit continuously.
4. Measure the conducted output power and record the results in the test report.

3.2.4 Test Setup

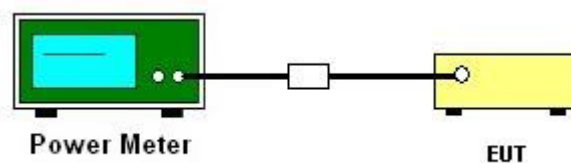

3.2.5 Test Result of Peak Output Power

Please refer to Appendix A.

3.2.6 Test Result of Average Output Power (Reporting Only)

Please refer to Appendix A.

3.3 Power Spectral Density Measurement

3.3.1 Limit of Power Spectral Density

The peak power spectral density shall not be greater than 8dBm in any 3kHz band at any time interval of continuous transmission.

3.3.2 Measuring Instruments

The section 4.0 of List of Measuring Equipment of this test report is used for test.

3.3.3 Test Procedures

1. The testing follows Measurement Procedure 10.2 Method PKPSD of FCC KDB Publication No. 558074 D01 DTS Meas. Guidance v04
2. The RF output of EUT was connected to the spectrum analyzer by RF cable and attenuator. The path loss was compensated to the results for each measurement.
3. Set to the maximum power setting and enable the EUT transmit continuously.
4. Make the measurement with the spectrum analyzer's resolution bandwidth (RBW) = 3 kHz. Video bandwidth VBW = 10 kHz In order to make an accurate measurement, set the span to 1.5 times DTS Channel Bandwidth. (6dB BW)
5. Detector = peak, Sweep time = auto couple, Trace mode = max hold, Allow trace to fully stabilize. Use the peak marker function to determine the maximum power level.
6. Measure and record the results in the test report.
7. The Measured power density (dBm)/ 100kHz is a reference level and used as 20dBc down limit line for Conducted Band Edges and Conducted Spurious Emission.

3.3.4 Test Setup

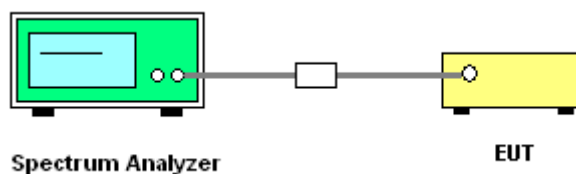

3.3.5 Test Result of Power Spectral Density

Please refer to Appendix A.



3.3.6 Test Result of Power Spectral Density Plots (100kHz)

<1Mbps>

PSD 100kHz Plot on Channel 00

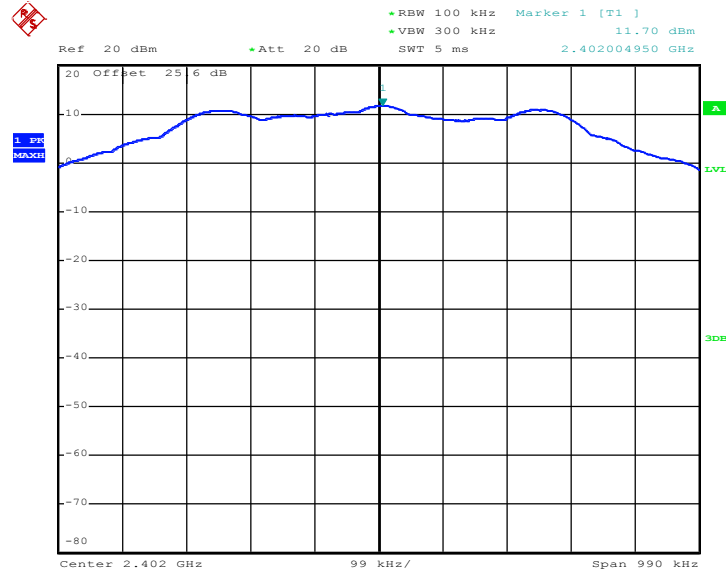

Date: 19.FEB.2018 18:32:17

PSD 100kHz Plot on Channel 19

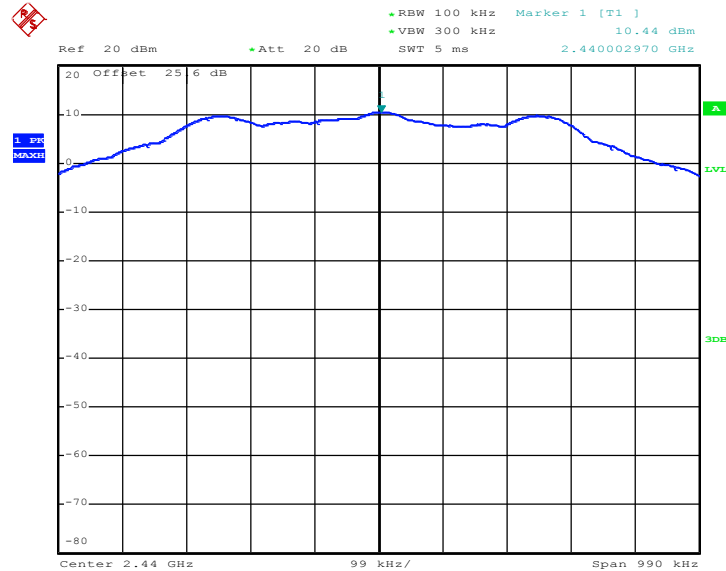

Date: 19.FEB.2018 18:39:08



PSD 100kHz Plot on Channel 39

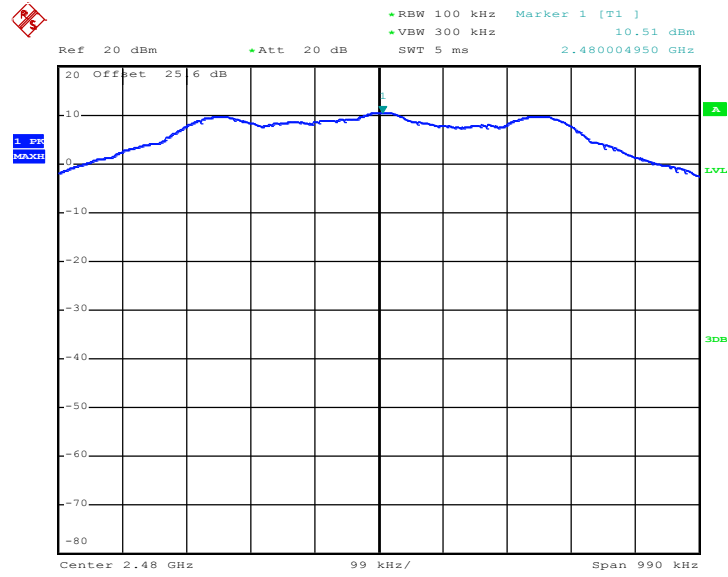

Date: 19.FEB.2018 18:42:24

<2Mbps>

PSD 100kHz Plot on Channel 00

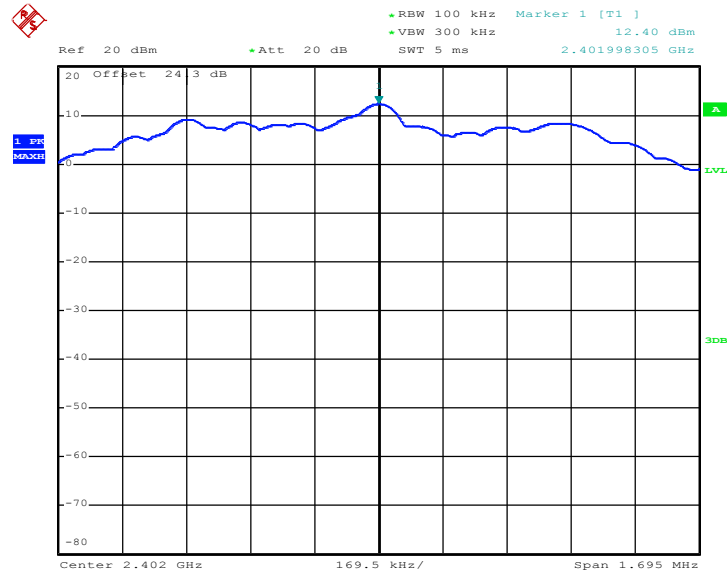

Date: 26.FEB.2018 21:16:46



PSD 100kHz Plot on Channel 19

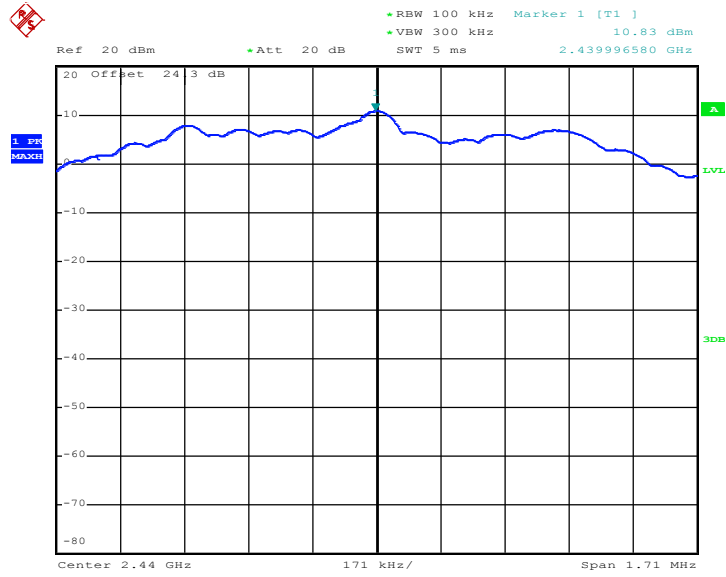

Date: 26.FEB.2018 21:22:55

PSD 100kHz Plot on Channel 39

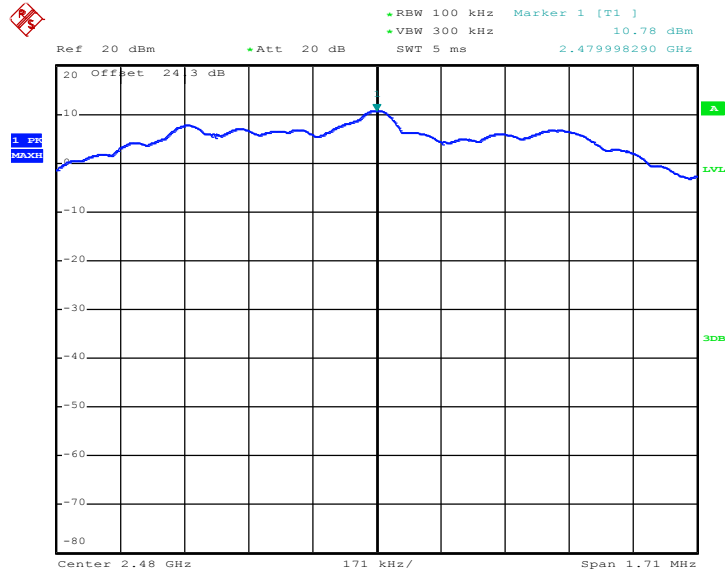

Date: 26.FEB.2018 21:28:23



3.3.7 Test Result of Power Spectral Density Plots (3kHz)

<1Mbps>

PSD 3kHz Plot on Channel 00

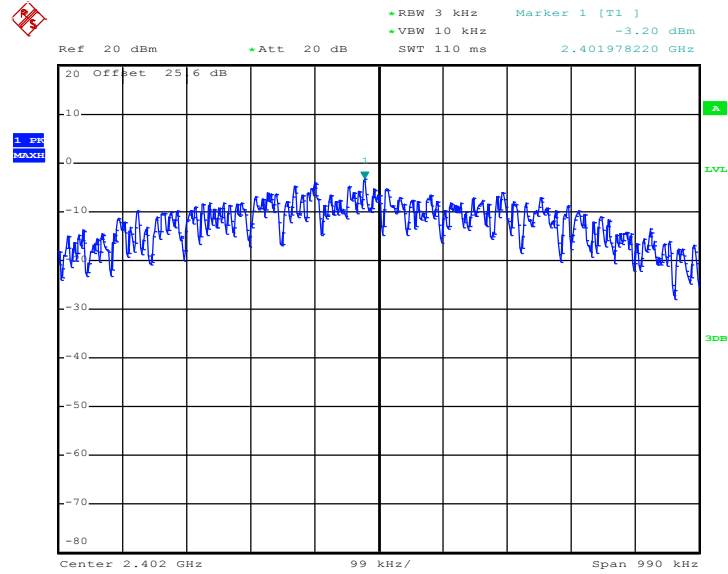

Date: 19.FEB.2018 18:31:42

PSD 3kHz Plot on Channel 19

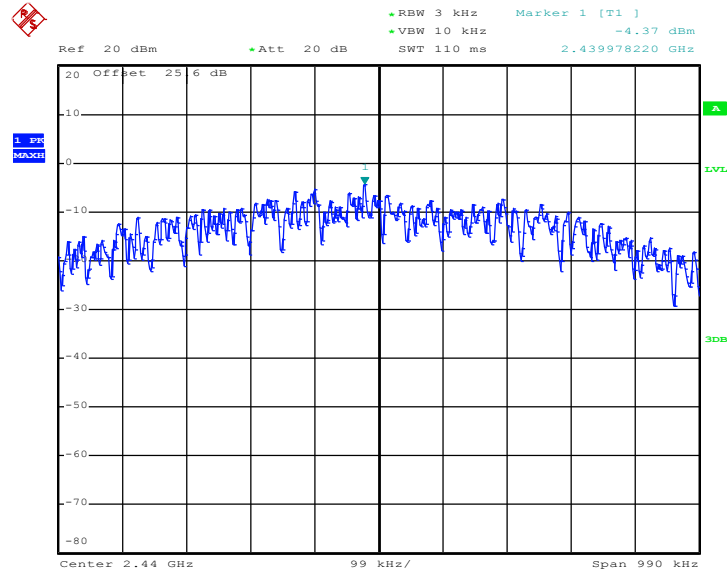

Date: 19.FEB.2018 18:38:53



PSD 3kHz Plot on Channel 39

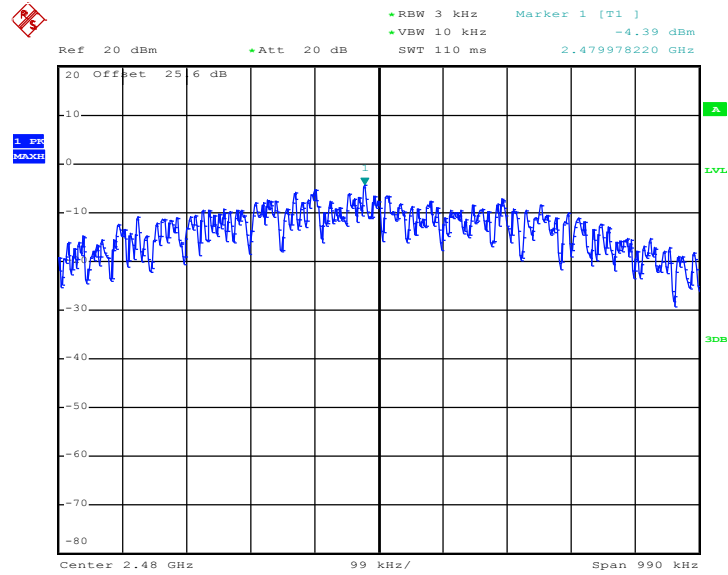

Date: 19.FEB.2018 18:42:11

<2Mbps>

PSD 3kHz Plot on Channel 00

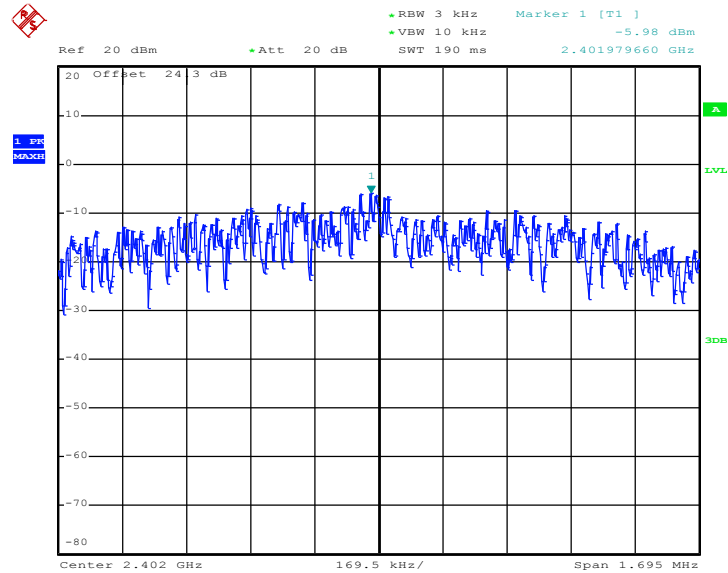

Date: 26.FEB.2018 21:16:16



PSD 3kHz Plot on Channel 19

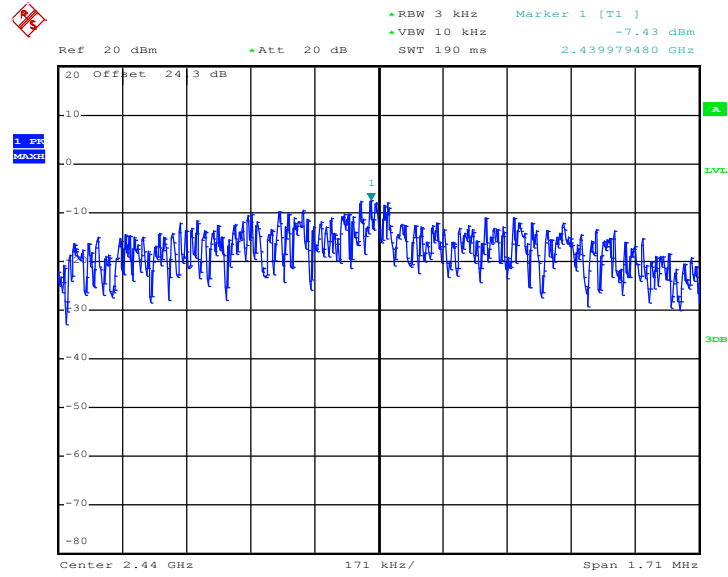

Date: 26.FEB.2018 21:22:32

PSD 3kHz Plot on Channel 39

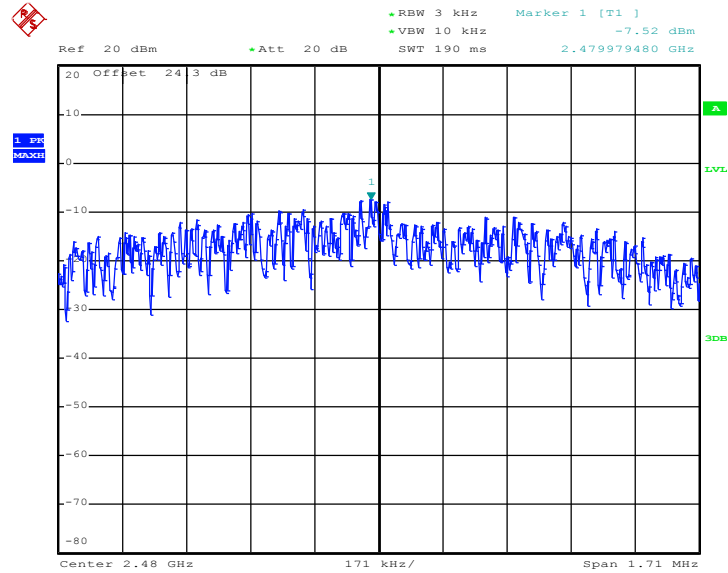

Date: 26.FEB.2018 21:28:02

3.4 Conducted Band Edges and Spurious Emission Measurement

3.4.1 Limit of Conducted Band Edges and Spurious Emission

All harmonics/spurious must be at least 20 dB down from the highest emission level within the authorized band.

3.4.2 Measuring Instruments

The section 4.0 of List of Measuring Equipment of this test report is used for test.

3.4.3 Test Procedure

1. The testing follows FCC KDB Publication No. 558074 D01 DTS Meas. Guidance v04.
2. The RF output of EUT was connected to the spectrum analyzer by RF cable and attenuator. The path loss was compensated to the results for each measurement.
3. Set to the maximum power setting and enable the EUT transmit continuously.
4. Set RBW = 100 kHz, VBW=300 kHz, Peak Detector. Unwanted Emissions measured in any 100 kHz bandwidth outside of the authorized frequency band shall be attenuated by at least 20 dB relative to the maximum in-band peak PSD level in 100 kHz when maximum peak conducted output power procedure is used. If the transmitter complies with the conducted power limits based on the use of RMS averaging over a time interval, the attenuation required under this paragraph shall be 30 dB instead of 20 dB.
5. Measure and record the results in the test report.
6. The RF fundamental frequency should be excluded against the limit line in the operating frequency band.

3.4.4 Test Setup





3.4.5 Test Result of Conducted Band Edges Plots

<1Mbps>

Low Band Edge Plot on Channel 00

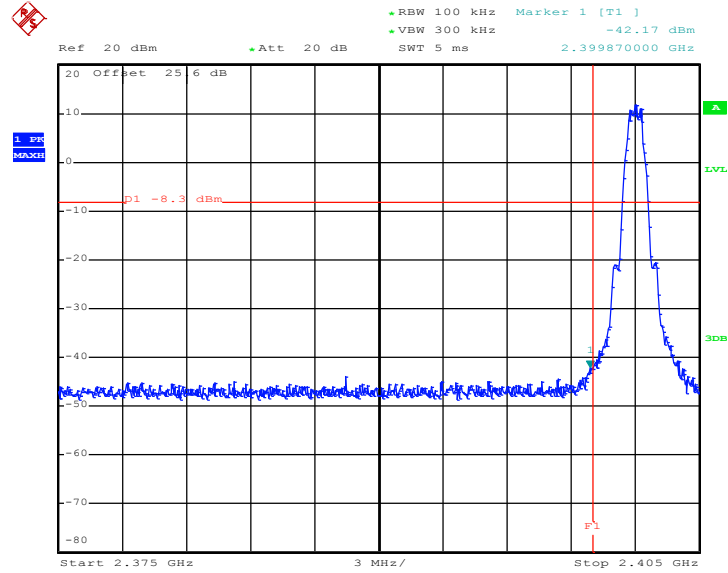

Date: 19.FEB.2018 18:32:52

High Band Edge Plot on Channel 39

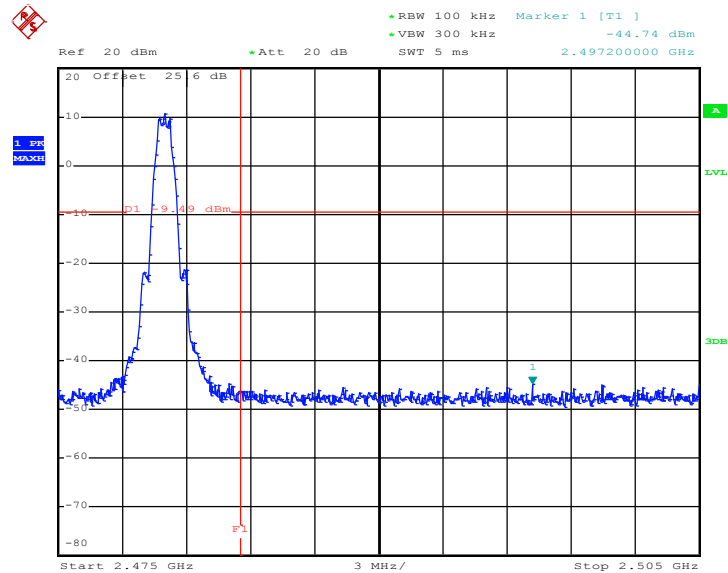

Date: 19.FEB.2018 18:42:40



<2Mbps>

Low Band Edge Plot on Channel 00

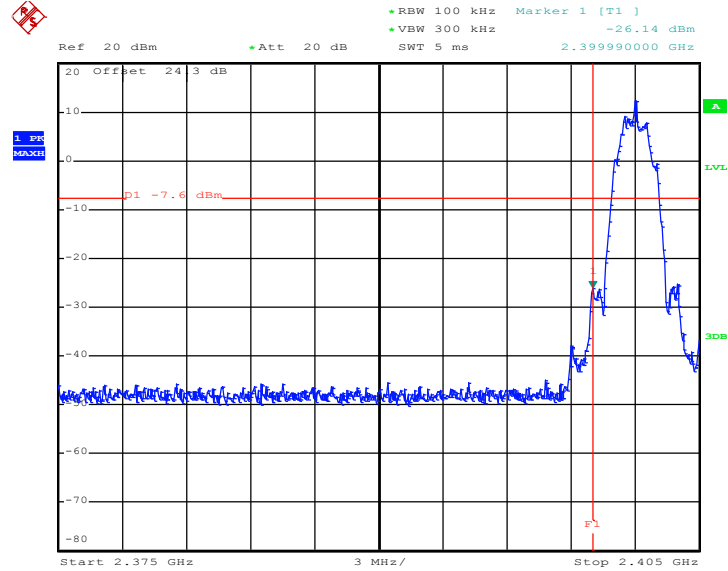

Date: 26.FEB.2018 21:17:03

High Band Edge Plot on Channel 39

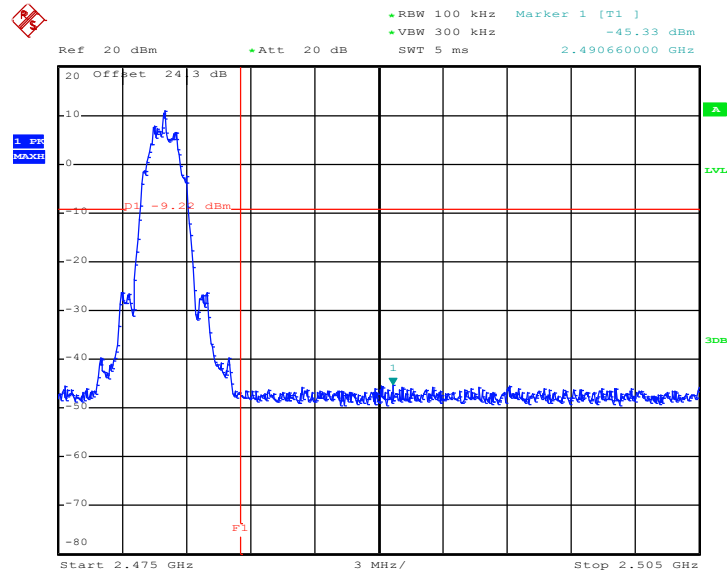

Date: 26.FEB.2018 21:28:45



3.4.6 Test Result of Conducted Spurious Emission Plots

Conducted Spurious Emission Plot on Bluetooth LE 1Mbps GFSK Channel 00

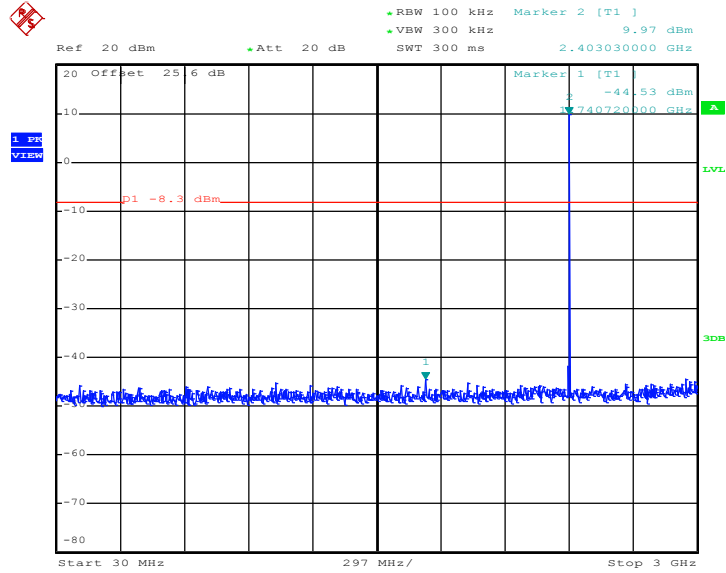

Date: 19.FEB.2018 18:35:12

Conducted Spurious Emission Plot on Bluetooth LE 1Mbps GFSK Channel 00

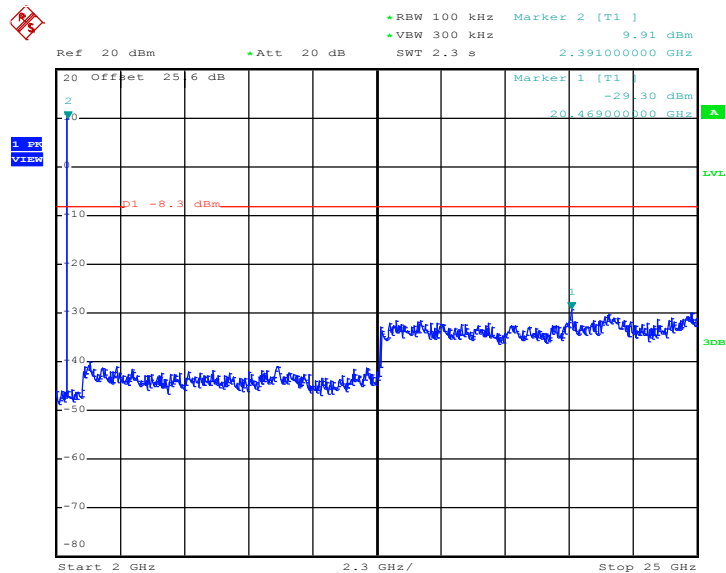

Date: 19.FEB.2018 18:35:21



Conducted Spurious Emission Plot on Bluetooth LE 1Mbps GFSK Channel 19

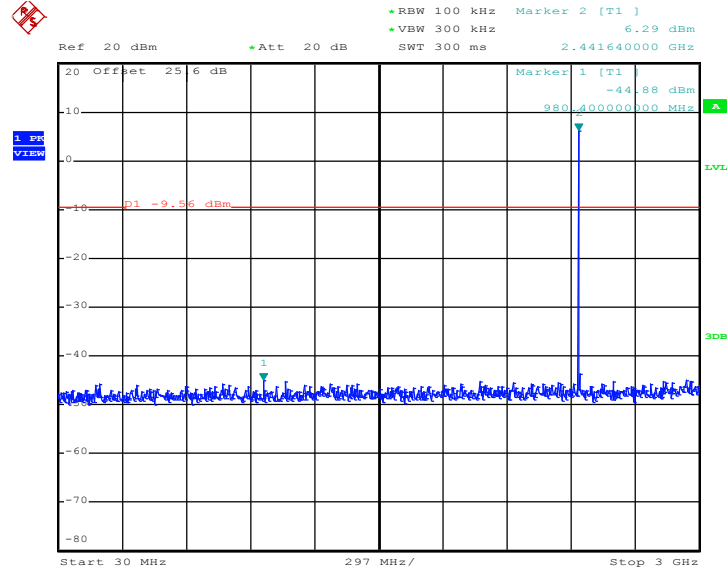

Date: 19.FEB.2018 18:39:26

Conducted Spurious Emission Plot on Bluetooth LE 1Mbps GFSK Channel 19

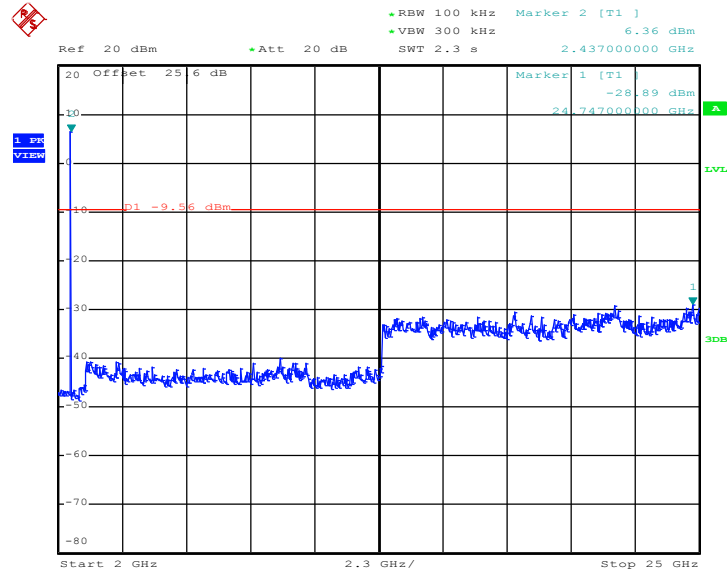

Date: 19.FEB.2018 18:39:34



Conducted Spurious Emission Plot on Bluetooth LE 1Mbps GFSK Channel 39

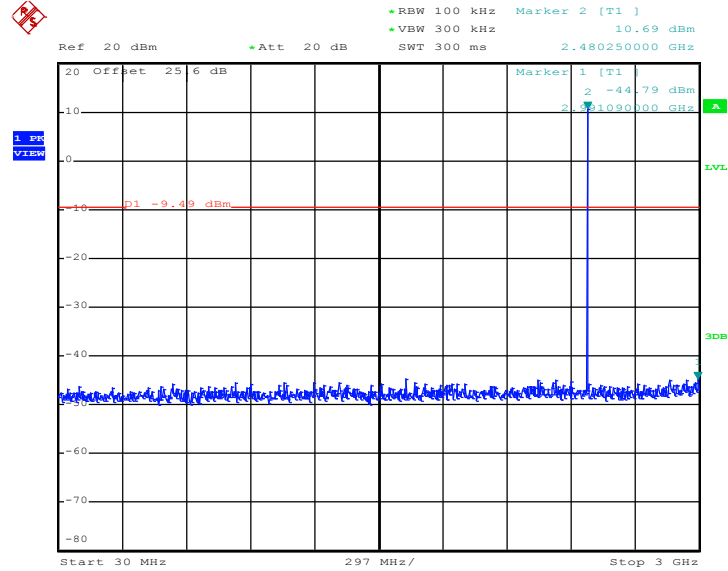

Date: 19.FEB.2018 18:42:53

Conducted Spurious Emission Plot on Bluetooth LE 1Mbps GFSK Channel 39

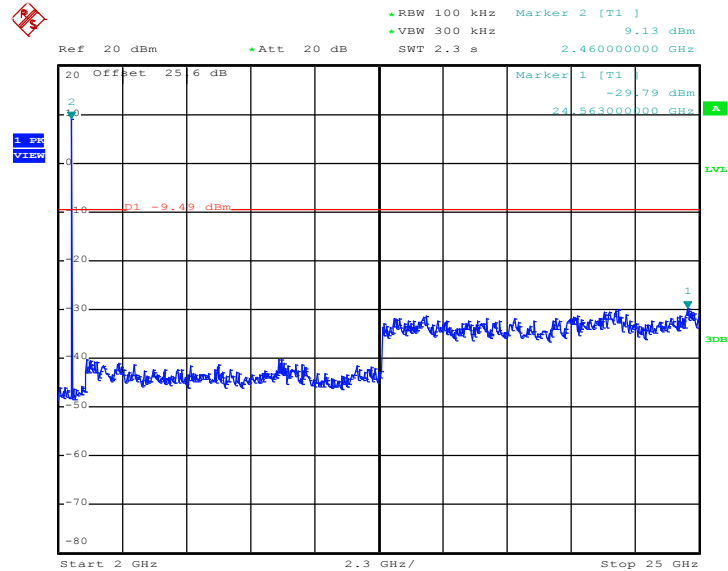

Date: 19.FEB.2018 18:43:02



Conducted Spurious Emission Plot on Bluetooth LE 2Mbps GFSK Channel 00

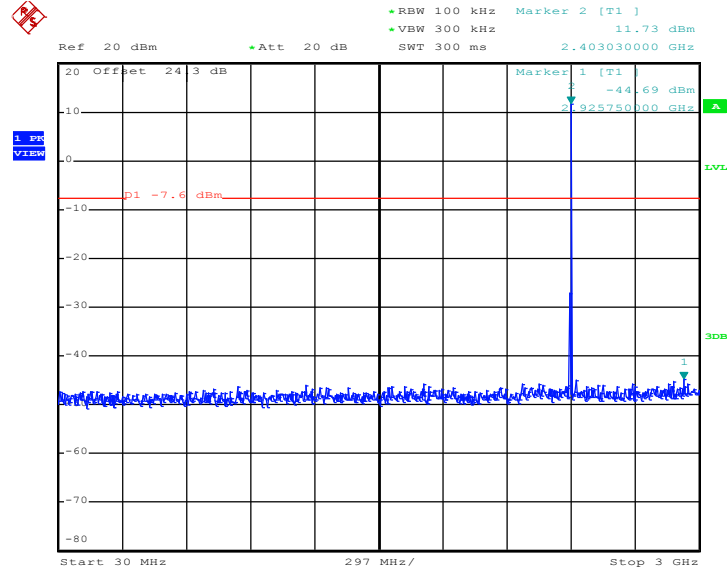

Date: 26.FEB.2018 21:17:17

Conducted Spurious Emission Plot on Bluetooth LE 2Mbps GFSK Channel 00

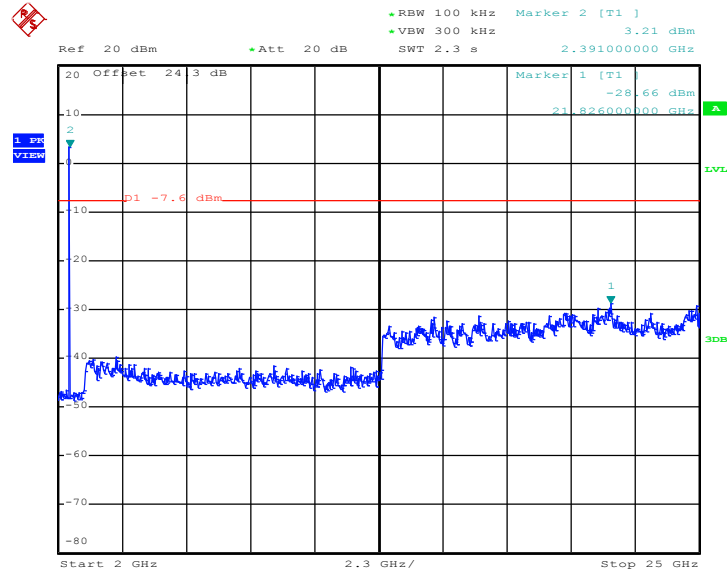

Date: 26.FEB.2018 21:17:25



Conducted Spurious Emission Plot on Bluetooth LE 2Mbps GFSK Channel 19

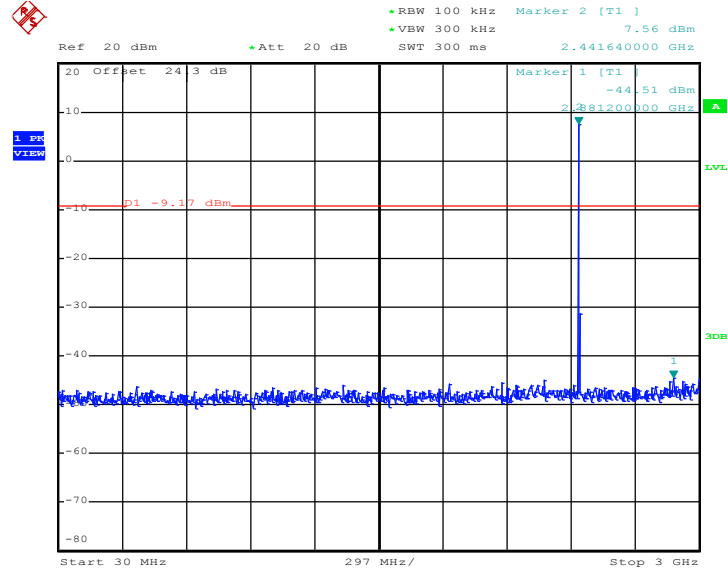

Date: 26.FEB.2018 21:23:07

Conducted Spurious Emission Plot on Bluetooth LE 2Mbps GFSK Channel 19

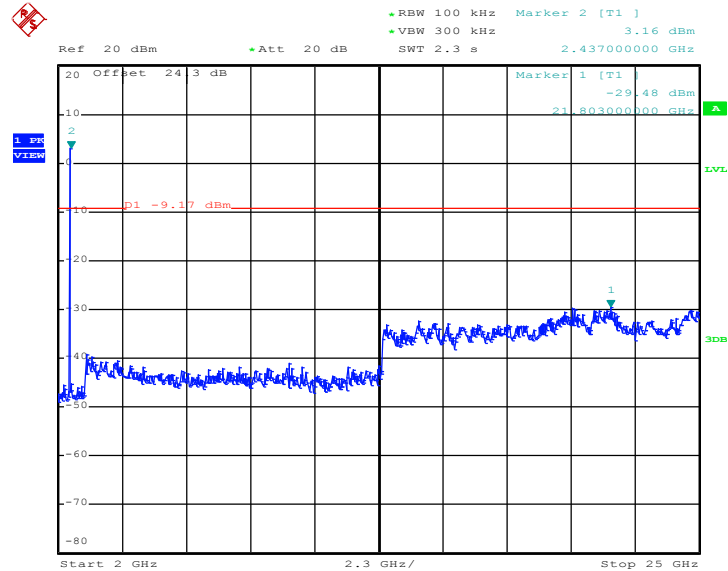

Date: 26.FEB.2018 21:23:15



Conducted Spurious Emission Plot on Bluetooth LE 2Mbps GFSK Channel 39

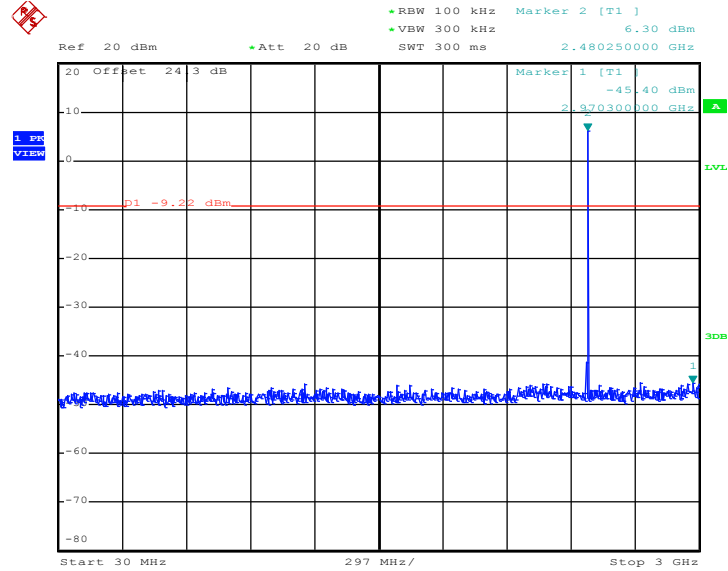

Date: 26.FEB.2018 21:29:21

Conducted Spurious Emission Plot on Bluetooth LE 2Mbps GFSK Channel 39

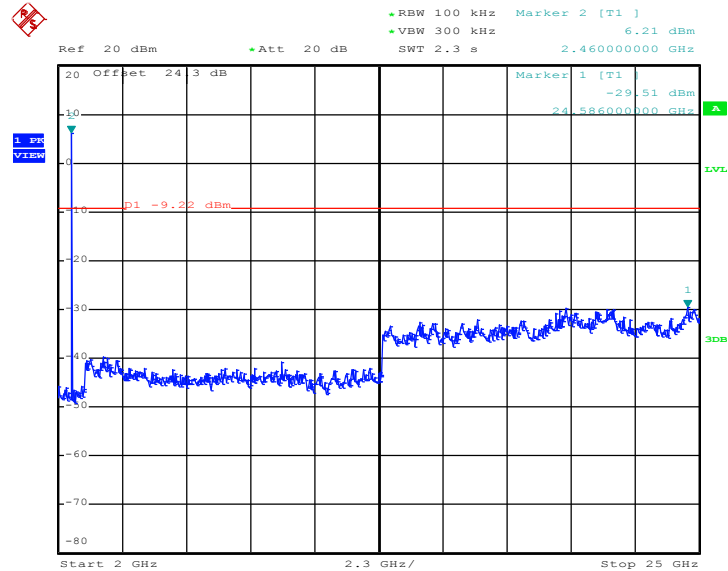

Date: 26.FEB.2018 21:29:30



3.5 Radiated Band Edges and Spurious Emission Measurement

3.5.1 Limit of Radiated Band Edges and Spurious Emission

In any 100 kHz bandwidth outside the intentional radiator frequency band, all harmonics/spurious must be at least 20 dB below the highest emission level within the authorized band. If the output power of this device was measured by spectrum analyzer, the attenuation under this paragraph shall be 30 dB instead of 20 dB. In addition, radiated emissions which fall in the restricted bands must also comply with the limits as below.

Frequency (MHz)	Field Strength (microvolts/meter)	Measurement Distance (meters)
0.009 – 0.490	2400/F(kHz)	300
0.490 – 1.705	24000/F(kHz)	30
1.705 – 30.0	30	30
30 – 88	100	3
88 – 216	150	3
216 - 960	200	3
Above 960	500	3

3.5.2 Measuring Instruments

The section 4.0 of List of Measuring Equipment of this test report is used for test.



3.5.3 Test Procedures

1. The testing follows FCC KDB Publication No. 558074 D01 DTS Meas. Guidance v04.
2. The EUT was arranged to its worst case and then tune the antenna tower (from 1 m to 4 m) and turntable (from 0 degree to 360 degrees) to find the maximum reading. A pre-amp and a high pass filter are used for the test in order to get better signal level.
3. The EUT was placed on a turntable with 0.8 meter for frequency below 1GHz and 1.5 meter for frequency above 1GHz respectively above ground.
4. The EUT was set 3 meters from the interference receiving antenna, which was mounted on the top of a variable height antenna tower.
5. Corrected Reading: Antenna Factor + Cable Loss + Read Level - Preamp Factor = Level
6. For testing below 1GHz, if the emission level of the EUT in peak mode was 3 dB lower than the limit specified, then peak values of EUT will be reported, otherwise, the emissions will be repeated one by one using the CISPR quasi-peak method and reported.
7. For testing above 1GHz, the emission level of the EUT in peak mode was 20dB lower than average limit (that means the emission level in average mode also complies with the limit in average mode), then peak values of EUT will be reported, otherwise, the emissions will be measured in average mode again and reported.
8. Use the following spectrum analyzer settings:
 - (1) Span shall wide enough to fully capture the emission being measured;
 - (2) Set RBW=100 kHz for $f < 1$ GHz; $VBW \geq RBW$; Sweep = auto; Detector function = peak; Trace = max hold;
 - (3) Set RBW = 1 MHz, VBW= 3MHz for $f \geq 1$ GHz for peak measurement.
For average measurement:
 - $VBW = 10$ Hz, when duty cycle is no less than 98 percent.
 - $VBW \geq 1/T$, when duty cycle is less than 98 percent where T is the minimum transmission duration over which the transmitter is on and is transmitting at its maximum power control level for the tested mode of operation.

3.5.4 Test Setup

For radiated emissions below 30MHz

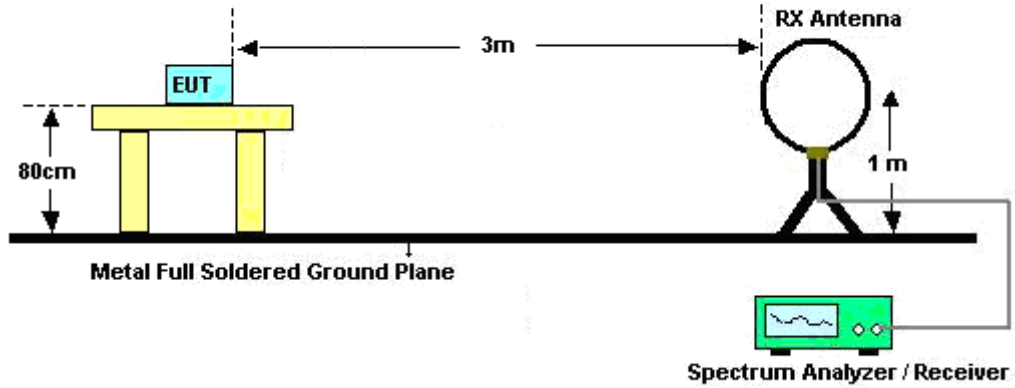

For radiated emissions from 30MHz to 1GHz

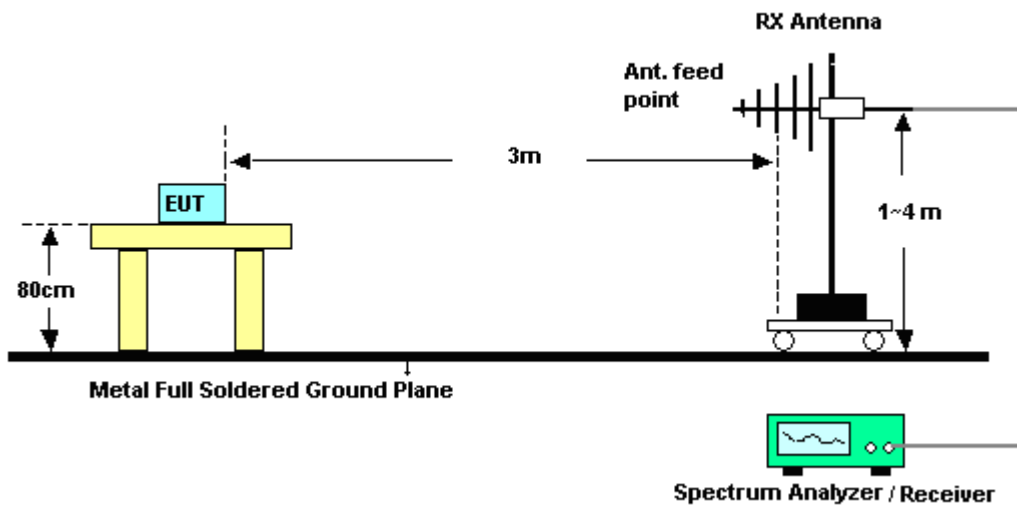

For radiated emissions above 1GHz

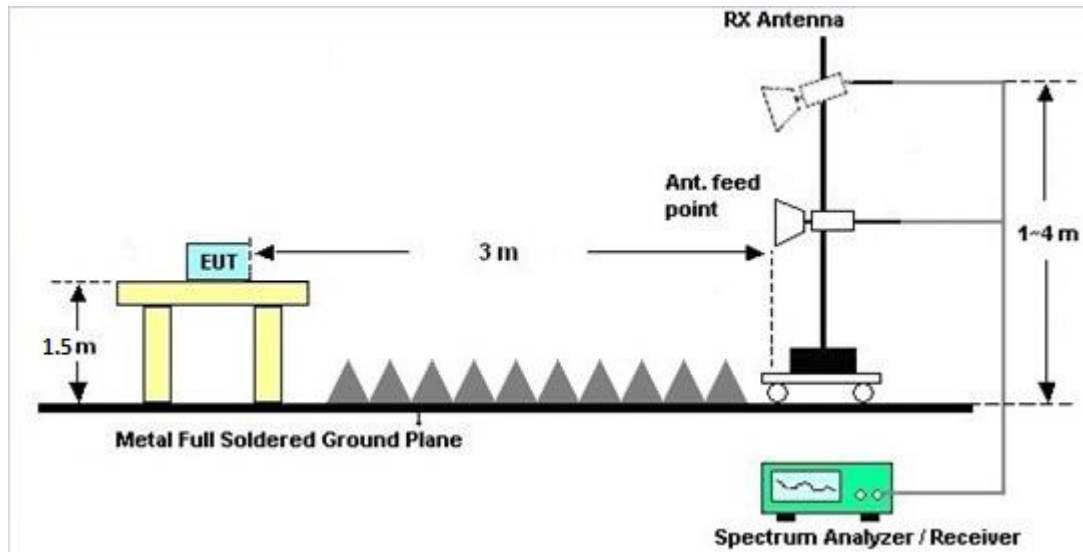

3.5.5 Test Results of Radiated Spurious Emissions (9 kHz ~ 30 MHz)

The low frequency, which started from 9 kHz to 30MHz, was pre-scanned and the result which was 20dB lower than the limit line was not reported.

There is a comparison data of both open-field test site and semi-Anechoic chamber, and the result came out very similar.

3.5.6 Test Result of Radiated Spurious at Band Edges

Please refer to Appendix C and D.

3.5.7 Duty Cycle

Please refer to Appendix E.

3.5.8 Test Result of Radiated Spurious Emission (30MHz ~ 10th Harmonic)

Please refer to Appendix C and D.



3.6 AC Conducted Emission Measurement

3.6.1 Limit of AC Conducted Emission

For equipment that is designed to be connected to the public utility (AC) power line, the radio frequency voltage that is conducted back onto the AC power line on any frequency or frequencies within the band 150 kHz to 30 MHz shall not exceed the limits in the following table.

Frequency of emission (MHz)	Conducted limit (dBµV)	
	Quasi-peak	Average
0.15-0.5	66 to 56*	56 to 46*
0.5-5	56	46
5-30	60	50

*Decreases with the logarithm of the frequency.

3.6.2 Measuring Instruments

The section 4.0 of List of Measuring Equipment of this test report is used for test.

3.6.3 Test Procedures

1. The EUT was placed 0.4 meter from the conducting wall of the shielding room was kept at least 80 centimeters from any other grounded conducting surface.
2. Connect EUT to the power mains through a line impedance stabilization network (LISN).
3. All the support units are connecting to the other LISN.
4. The LISN provides 50 ohm coupling impedance for the measuring instrument.
5. The FCC states that a 50 ohm, 50 microhenry LISN should be used.
6. Both sides of AC line were checked for maximum conducted interference.
7. The frequency range from 150 kHz to 30 MHz was searched.
8. Set the test-receiver system to Peak Detect Function and specified bandwidth (IF Bandwidth = 9kHz) with Maximum Hold Mode. Then measurement is also conducted by Average Detector and Quasi-Peak Detector Function respectively.

3.6.4 Test Setup

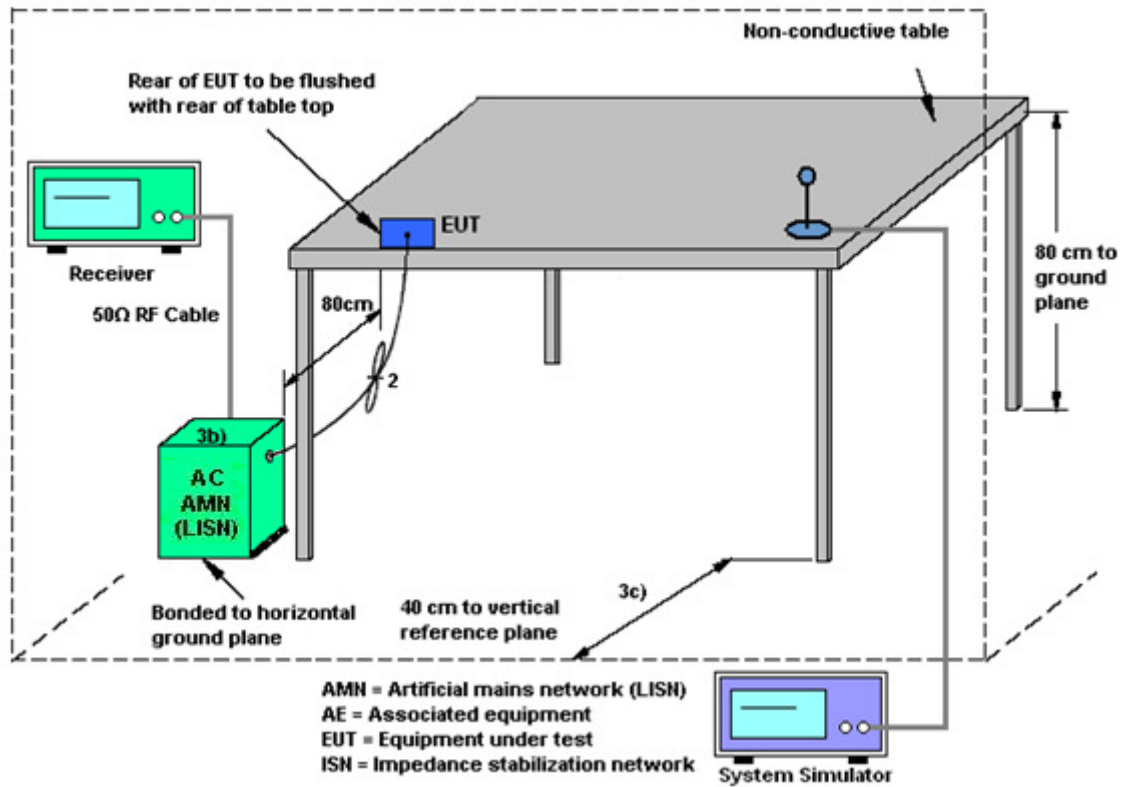

3.6.5 Test Result of AC Conducted Emission

Please refer to Appendix B.



3.7 Antenna Requirements

3.7.1 Standard Applicable

If directional gain of transmitting antennas is greater than 6dBi, the power shall be reduced by the same level in dB comparing to gain minus 6dBi. The use of a permanently attached antenna or of an antenna that uses a unique coupling to the intentional radiator shall be considered sufficient to comply with the rule.

3.7.2 Antenna Anti-Replacement Construction

An embedded-in antenna design is used.

3.7.3 Antenna Gain

The antenna peak gain of EUT is less than 6 dBi. Therefore, it is not necessary to reduce maximum peak output power limit.



4 List of Measuring Equipment

Instrument	Manufacturer	Model No.	Serial No.	Characteristics	Calibration Date	Test Date	Due Date	Remark
Power Meter	Anritsu	ML2495A	0932001	N/A	Sep. 26, 2017	Feb. 13, 2018~ Feb. 26, 2018	Sep. 25, 2018	Conducted (TH05-HY)
Power Sensor	Anritsu	MA2411B	0846202	300MHz~40GHz	Sep. 26, 2017	Feb.13, 2018~ Feb. 26, 2018	Sep. 25, 2018	Conducted (TH05-HY)
Spectrum Analyzer	Rohde & Schwarz	FSP30	101067	9kHz ~ 30GHz	Nov. 13, 2017	Feb. 13, 2018~ Feb. 26, 2018	Nov. 12, 2018	Conducted (TH05-HY)
AC Power Source	ChainTek	APC-1000W	N/A	N/A	N/A	Feb. 27, 2018	N/A	Conduction (CO05-HY)
EMI Test Receiver	Rohde & Schwarz	ESR3	102388	3.6GHz	Dec. 08, 2017	Feb. 27, 2018	Dec. 07, 2018	Conduction (CO05-HY)
LISN	Rohde & Schwarz	ENV216	100080	9kHz~30MHz	Nov. 30, 2017	Feb. 27, 2018	Nov. 29, 2018	Conduction (CO05-HY)
Amplifier	MITEQ	TTA1840-35-HG	1871923	18GHz~40GHz, VSWR : 2.5:1 max	Jul. 18, 2017	Feb. 27, 2018~ Mar. 03, 2018	Jul. 17, 2018	Radiation (03CH12-HY)
Bilog Antenna	TESEQ	CBL 6111D&00800 N1D01N-06	40103&07	30MHz~1GHz	Jan. 10, 2018	Feb. 27, 2018~ Mar. 03, 2018	Jan. 09, 2019	Radiation (03CH12-HY)
Loop Antenna	Rohde & Schwarz	HFH2-Z2	100488	9 kHz~30 MHz	Nov. 23, 2017	Feb. 27, 2018~ Mar. 03, 2018	Nov. 22, 2019	Radiation (03CH12-HY)
EMI Test Receiver	Rohde & Schwarz	ESU26	100390	20Hz~26.5GHz	Dec. 25, 2017	Feb. 27, 2018~ Mar. 03, 2018	Dec. 24, 2018	Radiation (03CH12-HY)
Horn Antenna	SCHWARZBECK	BBHA 9120D	9120D-132 8	1GHz ~ 18GHz	Oct. 20, 2017	Feb. 27, 2018~ Mar. 03, 2018	Oct. 19, 2018	Radiation (03CH12-HY)
Preamplifier	COM-POWER	PA-103	161075	10MHz~1GHz	Mar. 23, 2017	Feb. 27, 2018~ Mar. 03, 2018	Mar. 22, 2018	Radiation (03CH12-HY)
Preamplifier	Keysight	83017A	MY532701 48	1GHz~26.5GHz	Jan. 15, 2018	Feb. 27, 2018~ Mar. 03, 2018	Jan. 14, 2019	Radiation (03CH12-HY)
Preamplifier	MITEQ	AMF-7D-0010 1800	2025787	1GHz~18GHz	Feb. 13, 2017	Feb. 27, 2018~ Mar. 03, 2018	Feb. 12, 2019	Radiation (03CH12-HY)
Antenna Mast	EMEC	AM-BS-4500-B	N/A	1m~4m	N/A	Feb. 27, 2018~ Mar. 03, 2018	N/A	Radiation (03CH12-HY)
Turn Table	EMEC	TT2000	N/A	0~360 Degree	N/A	Feb. 27, 2018~ Mar. 03, 2018	N/A	Radiation (03CH12-HY)
Attenuator	Fairview Microwave	SA18S5W-10	n/a	10db	Mar. 24, 2017	Feb. 27, 2018~ Mar. 03, 2018	Mar. 23, 2018	Radiation (03CH12-HY)
SHF-EHF Horn Antenna	SCHWARZBECK	BBHA 9170	BBHA9170 576	18GHz ~ 40GHz	Apr. 27, 2017	Feb. 27, 2018~ Mar. 03, 2018	Apr. 26, 2018	Radiation (03CH12-HY)
Spectrum Analyzer	Keysight	N9010A	MY553705 26	10Hz~44GHz	Mar. 15, 2017	Feb. 27, 2018~ Mar. 03, 2018	Mar. 14, 2018	Radiation (03CH12-HY)



5 Uncertainty of Evaluation

Uncertainty of Conducted Emission Measurement (150 kHz ~ 30 MHz)

Measuring Uncertainty for a Level of Confidence of 95% ($U = 2Uc(y)$)	2.70
-------------------------------------------------------------------------	------

Uncertainty of Radiated Emission Measurement (30 MHz ~ 1000 MHz)

Measuring Uncertainty for a Level of Confidence of 95% ($U = 2Uc(y)$)	5.10
-------------------------------------------------------------------------	------

Uncertainty of Radiated Emission Measurement (1000 MHz ~ 18000 MHz)

Measuring Uncertainty for a Level of Confidence of 95% ($U = 2Uc(y)$)	5.20
-------------------------------------------------------------------------	------

Uncertainty of Radiated Emission Measurement (18000 MHz ~ 40000 MHz)

Measuring Uncertainty for a Level of Confidence of 95% ($U = 2Uc(y)$)	4.70
-------------------------------------------------------------------------	------

Appendix A. Test Result of Conducted Test Items

Test Engineer:	Shiming Liu / Luffy Lin	Temperature:	21~25	°C
Test Date:	2018/2/13 ~ 2018/02/26	Relative Humidity:	51~54	%

<For 1Mbps>

TEST RESULTS DATA
6dB and 99% Occupied Bandwidth

Mod.	Data Rate	NTX	CH.	Freq. (MHz)	99% Occupied BW (MHz)	6dB BW (MHz)	6dB BW Limit (MHz)	Pass/Fail
BLE	1Mbps	1	0	2402	1.028	0.660	0.50	Pass
BLE	1Mbps	1	19	2440	1.028	0.660	0.50	Pass
BLE	1Mbps	1	39	2480	1.028	0.656	0.50	Pass

TEST RESULTS DATA
Peak Power Table

Mod.	Data Rate	NTX	CH.	Freq. (MHz)	Peak Conducted Power (dBm)	Conducted Power Limit (dBm)	DG (dBi)	EIRP Power (dBm)	EIRP Power Limit (dBm)	Pass /Fail
BLE	1Mbps	1	0	2402	12.33	30.00	-5.00	7.33	36.00	Pass
BLE	1Mbps	1	19	2440	11.08	30.00	-5.00	6.08	36.00	Pass
BLE	1Mbps	1	39	2480	11.18	30.00	-5.00	6.18	36.00	Pass

TEST RESULTS DATA
Average Power Table
(Reporting Only)

Mod.	Data Rate	NTX	CH.	Freq. (MHz)	Duty Factor (dB)	Average Conducted Power (dBm)
BLE	1Mbps	1	0	2402	2.05	12.15
BLE	1Mbps	1	19	2440	2.05	10.75
BLE	1Mbps	1	39	2480	2.05	10.95

TEST RESULTS DATA
Peak Power Density

Mod.	Data Rate	NTX	CH.	Freq. (MHz)	Peak PSD (dBm /100kHz)	Peak PSD (dBm /3kHz)	DG (dBi)	Peak PSD Limit (dBm /3kHz)	Pass/Fail
BLE	1Mbps	1	0	2402	11.70	-3.20	-5.00	8.00	Pass
BLE	1Mbps	1	19	2440	10.44	-4.37	-5.00	8.00	Pass
BLE	1Mbps	1	39	2480	10.51	-4.39	-5.00	8.00	Pass

Note: PSD (dBm/ 100kHz) is a reference level used for Conducted Band Edges and Conducted Spurious Emission 20dBc limit.

<For 2Mbps>

TEST RESULTS DATA
6dB and 99% Occupied Bandwidth

Mod.	Data Rate	NTX	CH.	Freq. (MHz)	99% Occupied BW (MHz)	6dB BW (MHz)	6dB BW Limit (MHz)	Pass/Fail
BLE	2Mbps	1	0	2402	2.048	1.128	0.50	Pass
BLE	2Mbps	1	19	2440	2.044	1.144	0.50	Pass
BLE	2Mbps	1	39	2480	2.048	1.136	0.50	Pass

TEST RESULTS DATA
Peak Power Table

Mod.	Data Rate	NTX	CH.	Freq. (MHz)	Peak Conducted Power (dBm)	Conducted Power Limit (dBm)	DG (dBi)	EIRP Power (dBm)	EIRP Power Limit (dBm)	Pass /Fail
BLE	2Mbps	1	0	2402	12.62	30.00	-5.00	7.62	36.00	Pass
BLE	2Mbps	1	19	2440	11.26	30.00	-5.00	6.26	36.00	Pass
BLE	2Mbps	1	39	2480	11.08	30.00	-5.00	6.08	36.00	Pass

TEST RESULTS DATA
Average Power Table
(Reporting Only)

Mod.	Data Rate	NTX	CH.	Freq. (MHz)	Duty Factor (dB)	Average Conducted Power (dBm)
BLE	2Mbps	1	0	2402	4.86	12.35
BLE	2Mbps	1	19	2440	4.86	10.82
BLE	2Mbps	1	39	2480	4.86	10.86

TEST RESULTS DATA
Peak Power Density

Mod.	Data Rate	NTX	CH.	Freq. (MHz)	Peak PSD (dBm /100kHz)	Peak PSD (dBm /3kHz)	DG (dBi)	Peak PSD Limit (dBm /3kHz)	Pass/Fail
BLE	2Mbps	1	0	2402	12.40	-5.98	-5.00	8.00	Pass
BLE	2Mbps	1	19	2440	10.83	-7.43	-5.00	8.00	Pass
BLE	2Mbps	1	39	2480	10.78	-7.52	-5.00	8.00	Pass

Note: PSD (dBm/ 100kHz) is a reference level used for Conducted Band Edges and Conducted Spurious Emission 20dBc limit.



Appendix B. AC Conducted Emission Test Results

Test Engineer :	Shareef Yu	Temperature :	22~23°C
		Relative Humidity :	58~62%

EUT Information

Report NO : 811821-02
 Test Mode : Mode 1
 Test Voltage : 120Vac/60Hz
 Phase : Line

Full Spectrum

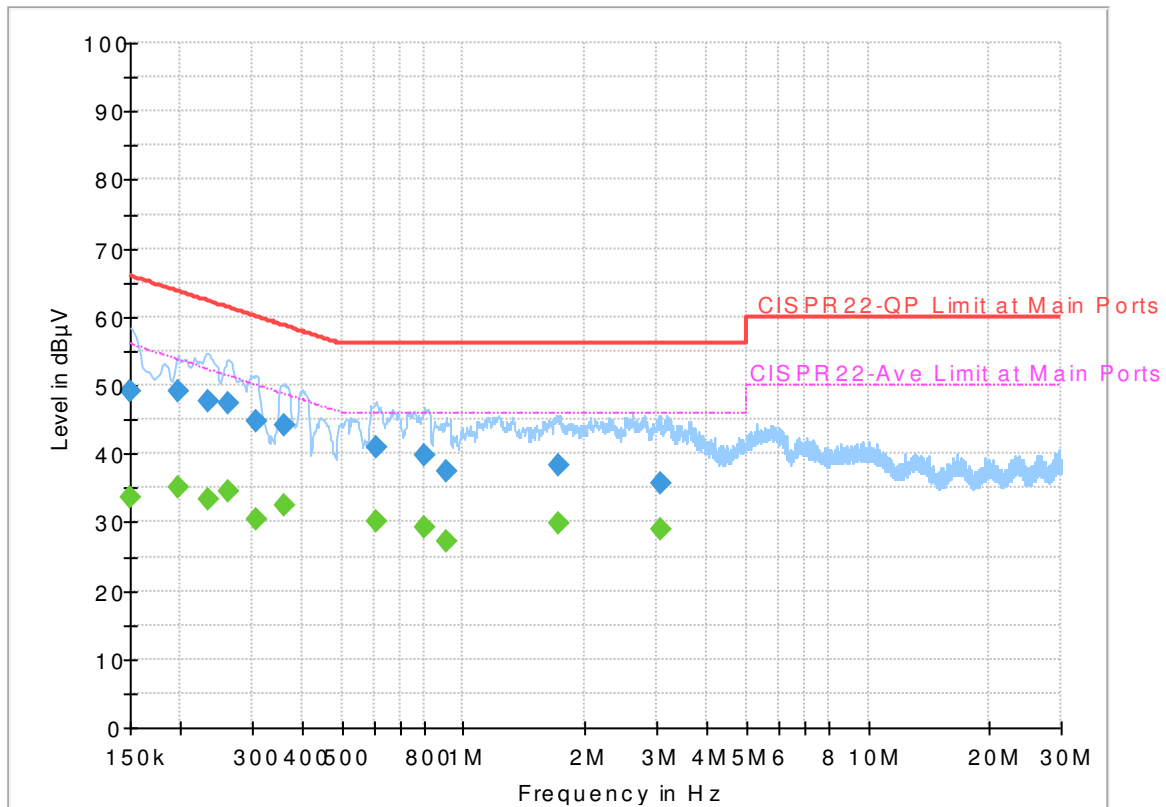

Final Result

Frequency (MHz)	QuasiPeak (dBµV)	Average (dBµV)	Limit (dBµV)	Margin (dB)	Line	Filter	Corr. (dB)
0.150000	---	33.62	56.00	22.38	L1	OFF	19.5
0.150000	48.99	---	66.00	17.01	L1	OFF	19.5
0.197250	---	35.10	53.73	18.63	L1	OFF	19.5
0.197250	49.05	---	63.73	14.68	L1	OFF	19.5
0.233250	---	33.43	52.33	18.90	L1	OFF	19.5
0.233250	47.65	---	62.33	14.68	L1	OFF	19.5
0.262500	---	34.39	51.35	16.96	L1	OFF	19.5
0.262500	47.51	---	61.35	13.84	L1	OFF	19.5
0.307500	---	30.45	50.04	19.59	L1	OFF	19.5
0.307500	44.80	---	60.04	15.24	L1	OFF	19.5
0.361500	---	32.36	48.69	16.33	L1	OFF	19.5
0.361500	44.18	---	58.69	14.51	L1	OFF	19.5
0.606750	---	30.19	46.00	15.81	L1	OFF	19.5
0.606750	40.89	---	56.00	15.11	L1	OFF	19.5
0.802500	---	29.31	46.00	16.69	L1	OFF	19.5
0.802500	39.85	---	56.00	16.15	L1	OFF	19.5
0.908250	---	27.34	46.00	18.66	L1	OFF	19.5
0.908250	37.36	---	56.00	18.64	L1	OFF	19.5
1.727250	---	29.79	46.00	16.21	L1	OFF	19.6
1.727250	38.29	---	56.00	17.71	L1	OFF	19.6
3.054750	---	28.83	46.00	17.17	L1	OFF	19.6

3.054750	35.72	---	56.00	20.28	L1	OFF	19.6
----------	-------	-----	-------	-------	----	-----	------

EUT Information

Report NO : 811821-02
 Test Mode : Mode 1
 Test Voltage : 120Vac/60Hz
 Phase : Neutral

Full Spectrum

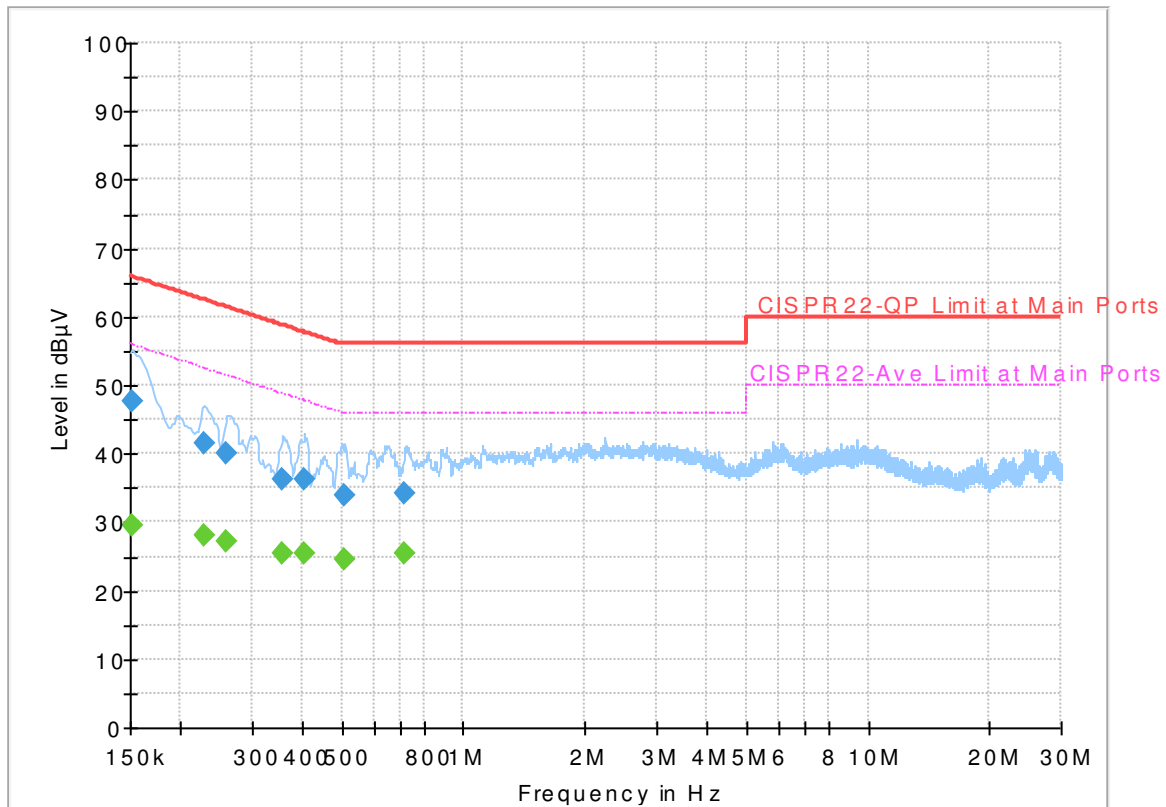

Final Result

Frequency (MHz)	QuasiPeak (dBµV)	Average (dBµV)	Limit (dBµV)	Margin (dB)	Line	Filter	Corr. (dB)
0.152250	---	29.43	55.88	26.45	N	OFF	19.5
0.152250	47.78	---	65.88	18.10	N	OFF	19.5
0.228750	---	28.17	52.50	24.33	N	OFF	19.5
0.228750	41.40	---	62.50	21.10	N	OFF	19.5
0.260250	---	27.12	51.42	24.30	N	OFF	19.5
0.260250	40.19	---	61.42	21.23	N	OFF	19.5
0.357000	---	25.51	48.80	23.29	N	OFF	19.5
0.357000	36.31	---	58.80	22.49	N	OFF	19.5
0.404250	---	25.55	47.77	22.22	N	OFF	19.5
0.404250	36.19	---	57.77	21.58	N	OFF	19.5
0.510000	---	24.63	46.00	21.37	N	OFF	19.5
0.510000	34.06	---	56.00	21.94	N	OFF	19.5
0.717000	---	25.42	46.00	20.58	N	OFF	19.5
0.717000	34.14	---	56.00	21.86	N	OFF	19.5



Appendix C. Radiated Spurious Emission

Test Engineer :	Watt Tseng, Karl Hou, and Nick Yu	Temperature :	21~23°C
		Relative Humidity :	57~60%

<For 1Mbps>

2.4GHz 2400~2483.5MHz

BLE (Band Edge @ 3m)

BLE	Note	Frequency	Level	Over Limit	Limit Line	Read Level	Antenna Factor	Path Loss	Preamp Factor	Ant Pos	Table Pos	Peak Avg.	Pol.	
		(MHz)	(dBμV/m)	(dB)	(dBμV/m)	(dBμV)	(dB/m)	(dB)	(dB)	(cm)	(deg)	(P/A)	(H/V)	
BLE CH 00 2402MHz		2377.095	54.69	-19.31	74	45.1	27.11	14.06	31.58	287	53	P	H	
		2375.205	43.13	-10.87	54	33.54	27.11	14.06	31.58	287	53	A	H	
	*	2402	105.29	-	-	95.64	27.15	14.07	31.57	287	53	P	H	
	*	2402	104.07	-	-	94.42	27.15	14.07	31.57	287	53	A	H	
													H	
			2354.415	53.64	-20.36	74	44.12	27.07	14.03	31.58	159	92	P	V
			2382.24	43.07	-10.93	54	33.48	27.11	14.06	31.58	159	92	A	V
	*		2402	108.34	-	-	98.69	27.15	14.07	31.57	159	92	P	V
	*		2402	107.3	-	-	97.65	27.15	14.07	31.57	159	92	A	V
													V	
BLE CH 19 2440MHz		2330.86	53.78	-20.22	74	44.37	26.99	14.01	31.59	271	138	P	H	
		2345.84	43.45	-10.55	54	33.97	27.03	14.03	31.58	271	138	A	H	
	*	2440	105.84	-	-	96.03	27.28	14.1	31.57	271	138	P	H	
	*	2440	104.69	-	-	94.88	27.28	14.1	31.57	271	138	A	H	
			2495.94	54.37	-19.63	74	44.38	27.4	14.14	31.55	271	138	P	H
			2492.93	43.3	-10.7	54	33.31	27.4	14.14	31.55	271	138	A	H
			2338.42	53.44	-20.56	74	43.99	27.03	14.01	31.59	211	88	P	V
			2371.6	43.26	-10.74	54	33.69	27.11	14.04	31.58	211	88	A	V
	*		2440	107.63	-	-	97.82	27.28	14.1	31.57	211	88	P	V
	*		2440	106.51	-	-	96.7	27.28	14.1	31.57	211	88	A	V
			2494.82	54.83	-19.17	74	44.84	27.4	14.14	31.55	211	88	P	V
			2489.15	43.43	-10.57	54	33.45	27.4	14.14	31.56	211	88	A	V



BLE CH 39 2480MHz	*	2480	105.73	-	-	95.81	27.36	14.12	31.56	298	139	P	H
	*	2480	104.67	-	-	94.75	27.36	14.12	31.56	298	139	A	H
		2483.68	57.52	-16.48	74	47.58	27.36	14.14	31.56	298	139	P	H
		2483.56	43.59	-10.41	54	33.65	27.36	14.14	31.56	298	139	A	H
													H
													H
	*	2480	107.05	-	-	97.13	27.36	14.12	31.56	199	86	P	V
	*	2480	105.88	-	-	95.96	27.36	14.12	31.56	199	86	A	V
		2483.52	57.3	-16.7	74	47.36	27.36	14.14	31.56	199	86	P	V
		2491.84	43.55	-10.45	54	33.56	27.4	14.14	31.55	199	86	A	V
													V
													V
Remark	1. No other spurious found. 2. All results are PASS against Peak and Average limit line.												



2.4GHz 2400~2483.5MHz
BLE (Harmonic @ 3m)

BLE	Note	Frequency (MHz)	Level (dBµV/m)	Over Limit (dB)	Limit Line (dBµV/m)	Read Level (dBµV)	Antenna Factor (dB/m)	Path Loss (dB)	Preamp Factor (dB)	Ant Pos (cm)	Table Pos (deg)	Peak Avg. (P/A)	Pol. (H/V)	
BLE CH 00 2402MHz		4804	39.5	-34.5	74	66.23	31.32	6.7	64.75	100	0	P	H	
													H	
													H	
													H	
		4804	42.06	-31.94	74	68.79	31.32	6.7	64.75	100	0	P	V	
														V
														V
BLE CH 19 2440MHz		4880	39.52	-34.48	74	66.03	31.46	6.73	64.7	100	0	P	H	
		7320	49.01	-24.99	74	69.63	36.15	8.06	64.83	100	0	P	H	
													H	
													H	
		4880	39.77	-34.23	74	66.28	31.46	6.73	64.7	100	0	P	V	
		7320	46.82	-27.18	74	67.44	36.15	8.06	64.83	100	0	P	V	
														V
BLE CH 39 2480MHz		4960	40.11	-33.89	74	66.36	31.63	6.75	64.63	100	0	P	H	
		7440	48.24	-25.76	74	68.58	36.47	8.07	64.88	100	0	P	H	
													H	
													H	
		4960	39.87	-34.13	74	66.12	31.63	6.75	64.63	100	0	P	V	
		7440	45.5	-28.5	74	65.84	36.47	8.07	64.88	100	0	P	V	
														V
Remark	1. No other spurious found.													
	2. All results are PASS against Peak and Average limit line.													



<For 2Mbps>

2.4GHz 2400~2483.5MHz

BLE (Band Edge @ 3m)

BLE	Note	Frequency	Level	Over Limit	Limit Line	Read Level	Antenna Factor	Path Loss	Preamp Factor	Ant Pos	Table Pos	Peak Avg.	Pol.	
		(MHz)	(dBμV/m)	(dB)	(dBμV/m)	(dBμV)	(dB/m)	(dB)	(dB)	(cm)	(deg)	(P/A)	(H/V)	
BLE CH 00 2402MHz		2327.64	53.69	-20.31	74	44.28	26.99	14.01	31.59	289	54	P	H	
		2369.01	44.89	-9.11	54	35.32	27.11	14.04	31.58	289	54	A	H	
	*	2402	104.68	-	-	95.03	27.15	14.07	31.57	289	54	P	H	
	*	2402	102.94	-	-	93.29	27.15	14.07	31.57	289	54	A	H	
													H	
													H	
			2349.27	53.54	-20.46	74	44.06	27.03	14.03	31.58	158	90	P	V
			2387.49	44.53	-9.47	54	34.9	27.15	14.06	31.58	158	90	A	V
	*		2402	108.41	-	-	98.76	27.15	14.07	31.57	158	90	P	V
	*		2402	106.51	-	-	96.86	27.15	14.07	31.57	158	90	A	V
													V	
												V		
BLE CH 19 2440MHz		2382.66	53.38	-20.62	74	43.79	27.11	14.06	31.58	272	53	P	H	
		2384.2	44.29	-9.71	54	34.7	27.11	14.06	31.58	272	53	A	H	
	*	2440	105.2	-	-	95.39	27.28	14.1	31.57	272	53	P	H	
	*	2440	103.54	-	-	93.73	27.28	14.1	31.57	272	53	A	H	
			2491.88	53.75	-20.25	74	43.76	27.4	14.14	31.55	272	53	P	H
			2493.7	44.74	-9.26	54	34.75	27.4	14.14	31.55	272	53	A	H
			2370.2	53.6	-20.4	74	44.03	27.11	14.04	31.58	133	87	P	V
			2369.22	44.36	-9.64	54	34.79	27.11	14.04	31.58	133	87	A	V
	*		2440	107.26	-	-	97.45	27.28	14.1	31.57	133	87	P	V
	*		2440	105.33	-	-	95.52	27.28	14.1	31.57	133	87	A	V
			2486.21	53.69	-20.31	74	43.75	27.36	14.14	31.56	133	87	P	V
		2487.33	45.07	-8.93	54	35.13	27.36	14.14	31.56	133	87	A	V	



BLE CH 39 2480MHz	*	2480	105.82	-	-	95.9	27.36	14.12	31.56	296	52	P	H
	*	2480	103.67	-	-	93.75	27.36	14.12	31.56	296	52	A	H
		2483.64	57.64	-16.36	74	47.7	27.36	14.14	31.56	296	52	P	H
		2483.52	47.26	-6.74	54	37.32	27.36	14.14	31.56	296	52	A	H
													H
													H
	*	2480	107.33	-	-	97.41	27.36	14.12	31.56	153	87	P	V
	*	2480	105.37	-	-	95.45	27.36	14.12	31.56	153	87	A	V
		2483.72	59.26	-14.74	74	49.32	27.36	14.14	31.56	153	87	P	V
		2483.52	47.1	-6.9	54	37.16	27.36	14.14	31.56	153	87	A	V
													V
													V
Remark	1. No other spurious found. 2. All results are PASS against Peak and Average limit line.												



2.4GHz 2400~2483.5MHz
BLE (Harmonic @ 3m)

BLE	Note	Frequency (MHz)	Level (dBμV/m)	Over Limit (dB)	Limit Line (dBμV/m)	Read Level (dBμV)	Antenna Factor (dB/m)	Path Loss (dB)	Preamp Factor (dB)	Ant Pos (cm)	Table Pos (deg)	Peak Avg. (P/A)	Pol. (H/V)	
BLE CH 00 2402MHz		4804	39.54	-34.46	74	66.27	31.32	6.7	64.75	100	0	P	H	
													H	
													H	
													H	
			4804	42.54	-31.46	74	69.27	31.32	6.7	64.75	100	0	P	V
														V
														V
BLE CH 19 2440MHz		4880	38.44	-35.56	74	64.95	31.46	6.73	64.7	100	0	P	H	
		7320	50	-24	74	70.62	36.15	8.06	64.83	100	0	P	H	
													H	
													H	
			4880	38.85	-35.15	74	65.36	31.46	6.73	64.7	100	0	P	V
			7320	47.84	-26.16	74	68.46	36.15	8.06	64.83	100	0	P	V
														V
BLE CH 39 2480MHz		4960	41.06	-32.94	74	67.31	31.63	6.75	64.63	100	0	P	H	
		7440	47.36	-26.64	74	67.7	36.47	8.07	64.88	100	0	P	H	
													H	
													H	
			4960	39.21	-34.79	74	65.46	31.63	6.75	64.63	100	0	P	V
			7440	46.77	-27.23	74	67.11	36.47	8.07	64.88	100	0	P	V
														V
Remark	1. No other spurious found. 2. All results are PASS against Peak and Average limit line.													



Emission below 1GHz
2.4GHz BLE (LF)

BLE	Note	Frequency (MHz)	Level (dBµV/m)	Over Limit (dB)	Limit Line (dBµV/m)	Read Level (dBµV)	Antenna Factor (dB/m)	Path Loss (dB)	Preamp Factor (dB)	Ant Pos (cm)	Table Pos (deg)	Peak Avg. (P/A)	Pol. (H/V)	
2.4GHz BLE LF		33.24	23.49	-16.51	40	30.15	23.11	0.45	30.22			P	H	
		92.37	24.38	-19.12	43.5	38.7	15.27	0.82	30.41			P	H	
		258.42	24.14	-21.86	46	33.1	19.76	1.47	30.19			P	H	
		508.6	26.04	-19.96	46	29.91	24.01	1.9	29.78			P	H	
		778.1	31.52	-14.48	46	30.26	28.26	2.38	29.38	100	0	P	H	
		961.5	35.04	-18.96	54	30.19	31.14	2.75	29.04			P	H	
														H
														H
														H
														H
														H
														H
														H
			34.32	26.36	-13.64	40	33.47	22.69	0.45	30.25			P	V
			100.2	22.42	-21.08	43.5	35.82	16.15	0.85	30.4			P	V
			259.5	22.37	-23.63	46	31.07	20.02	1.47	30.19			P	V
			519.1	26.31	-19.69	46	30.1	24.07	1.91	29.77			P	V
			712.3	33.79	-12.21	46	34.2	26.84	2.26	29.51	100	0	P	V
			965	34.37	-19.63	54	29.62	31.04	2.74	29.03			P	V
														V
													V	
													V	
													V	
													V	
													V	
Remark	1. No other spurious found. 2. All results are PASS against limit line.													



Note symbol

*	Fundamental Frequency which can be ignored. However, the level of any unwanted emissions shall not exceed the level of the fundamental frequency.
!	Test result is over limit line.
P/A	Peak or Average
H/V	Horizontal or Vertical



A calculation example for radiated spurious emission is shown as below:

BLE	Note	Frequency	Level	Over	Limit	Read	Antenna	Path	Preamp	Ant	Table	Peak	Pol.
		(MHz)	(dBμV/m)	(dB)	(dBμV/m)	(dBμV)	(dB/m)	(dB)	(dB)	(cm)	(deg)	(P/A)	(H/V)
BLE CH 00 2402MHz		2390	55.45	-18.55	74	54.51	32.22	4.58	35.86	103	308	P	H
		2390	43.54	-10.46	54	42.6	32.22	4.58	35.86	103	308	A	H

1. Path Loss(dB) = Cable loss(dB) + Filter loss(dB) + Attenuator loss(dB)
2. Level(dBμV/m) =
Antenna Factor(dB/m) + Path Loss(dB) + Read Level(dBμV) - Preamp Factor(dB)
3. Over Limit(dB) = Level(dBμV/m) – Limit Line(dBμV/m)

For Peak Limit @ 2390MHz:

1. Level(dBμV/m)
= Antenna Factor(dB/m) + Path Loss(dB) + Read Level(dBμV) - Preamp Factor(dB)
= 32.22(dB/m) + 4.58(dB) + 54.51(dBμV) – 35.86 (dB)
= 55.45 (dBμV/m)
2. Over Limit(dB)
= Level(dBμV/m) – Limit Line(dBμV/m)
= 55.45(dBμV/m) – 74(dBμV/m)
= -18.55(dB)

For Average Limit @ 2390MHz:

1. Level(dBμV/m)
= Antenna Factor(dB/m) + Path Loss(dB) + Read Level(dBμV) - Preamp Factor(dB)
= 32.22(dB/m) + 4.58(dB) + 42.6(dBμV) – 35.86 (dB)
= 43.54 (dBμV/m)
2. Over Limit(dB)
= Level(dBμV/m) – Limit Line(dBμV/m)
= 43.54(dBμV/m) – 54(dBμV/m)
= -10.46(dB)

Both peak and average measured complies with the limit line, so test result is “PASS”.



Appendix D. Radiated Spurious Emission Plots

Test Engineer :	Watt Tseng, Karl Hou, and Nick Yu	Temperature :	21~23°C
		Relative Humidity :	57~60%

Note symbol

-L	Low channel location
-R	High channel location



<For 1Mbps>

2.4GHz 2400~2483.5MHz

BLE (Band Edge @ 3m)

BLE	2.4GHz 2400~2483.5MHz Band Edge @ 3m	
	BLE CH00 2402MHz	
	Horizontal	Fundamental
Peak	<p>Site Condition : 03CH12-14Y : PEAK_BE_74 3m HORN_91200_1328 HORIZONTAL : RBW:1000.000kHz VBW:3000.000kHz SWT:Auto</p>	<p>Site Condition : 03CH12-14Y : PEAK_74 3m HORN_91200_1328 HORIZONTAL : RBW:1000.000kHz VBW:3000.000kHz SWT:Auto</p>
Avg.	<p>Site Condition : 03CH12-14Y : AVG_BE_54 3m HORN_91200_1328 HORIZONTAL : RBW:1000.000kHz VBW:3.000kHz SWT:Auto</p>	<p>Site Condition : 03CH12-14Y : AVG_54 3m HORN_91200_1328 HORIZONTAL : RBW:1000.000kHz VBW:3.000kHz SWT:Auto</p>

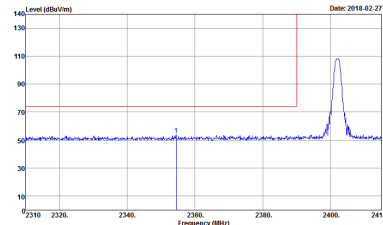
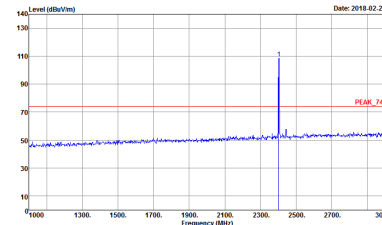
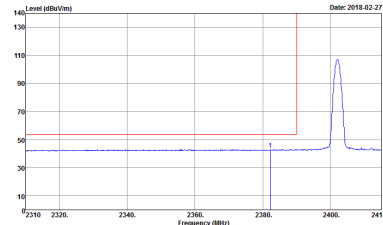
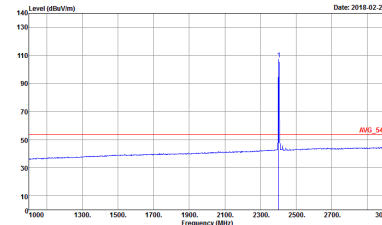

BLE	2.4GHz 2400~2483.5MHz Band Edge @ 3m	
BLE CH00 2402MHz		
	Vertical	Fundamental
Peak	 <p>Site : 03CH2-HY Condition : PEAK_BE_74 3m HORN_91200_1328 VERTICAL : RBW:1000.000kHz VBW:3000.000kHz SWT:Auto</p>	 <p>Site : 03CH2-HY Condition : PEAK_74 3m HORN_91200_1328 VERTICAL : RBW:1000.000kHz VBW:3000.000kHz SWT:Auto</p>
Avg	 <p>Site : 03CH2-HY Condition : AVG_BE_54 3m HORN_91200_1328 VERTICAL : RBW:1000.000kHz VBW:3.000kHz SWT:Auto</p>	 <p>Site : 03CH2-HY Condition : AVG_54 3m HORN_91200_1328 VERTICAL : RBW:1000.000kHz VBW:3.000kHz SWT:Auto</p>

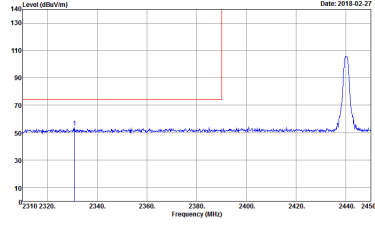
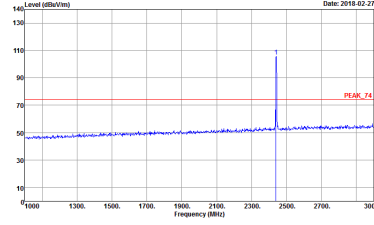
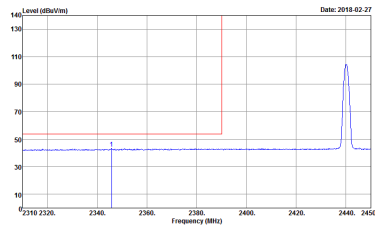
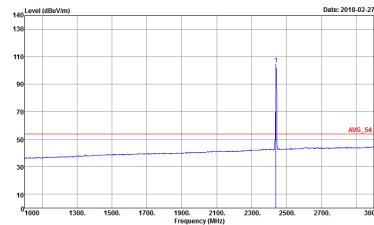

BLE	2.4GHz 2400~2483.5MHz Band Edge @ 3m	
	BLE CH19 2440MHz - L	
	Horizontal	Fundamental
Peak	 <p>Date: 2018-02-27</p> <p>Site : 03CH12-HY Condition : PEAK_BE_74 3m HORN_91200_1328 HORIZONTAL : RBW:1000.000KHz VBW:3000.000KHz SWT:Auto</p>	 <p>Date: 2018-02-27</p> <p>Site : 03CH12-HY Condition : PEAK_74 3m HORN_91200_1328 HORIZONTAL : RBW:1000.000KHz VBW:3000.000KHz SWT:Auto</p>
Avg.	 <p>Date: 2018-02-27</p> <p>Site : 03CH12-HY Condition : AVG_BE_54 3m HORN_91200_1328 HORIZONTAL : RBW:1000.000KHz VBW:3000.000KHz SWT:Auto</p>	 <p>Date: 2018-02-27</p> <p>Site : 03CH12-HY Condition : AVG_54 3m HORN_91200_1328 HORIZONTAL : RBW:1000.000KHz VBW:3000.000KHz SWT:Auto</p>

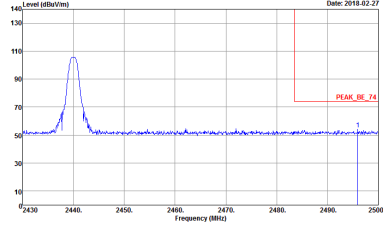
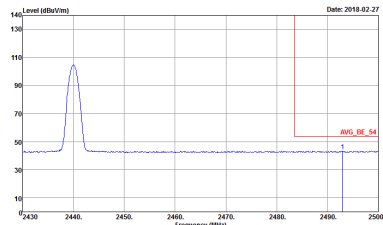

BLE	2.4GHz 2400~2483.5MHz Band Edge @ 3m	
BLE CH19 2440MHz - R		
	Horizontal	Fundamental
<p>Peak</p>	 <p>Site : 03CH12-HY Condition : PEAK_BE_74 3m HORN_91200_1328 HORIZONTAL : RBW:1000.000kHz VBW:3000.000Hz SWT:Auto</p>	<p>Left blank</p>
<p>Avg.</p>	 <p>Site : 03CH12-HY Condition : AVG_BE_54 3m HORN_91200_1328 HORIZONTAL : RBW:1000.000kHz VBW:3000.000Hz SWT:Auto</p>	<p>Left blank</p>

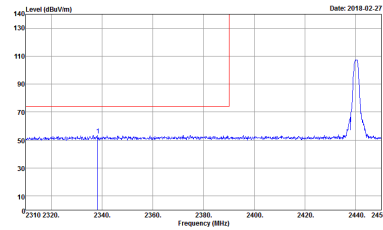
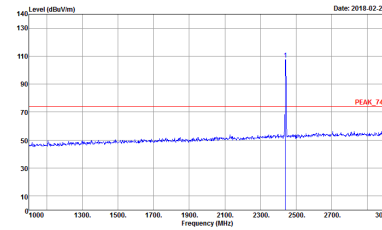
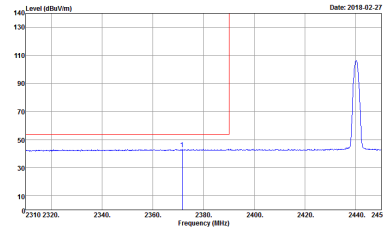
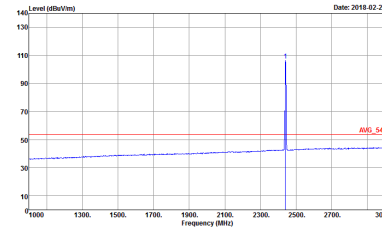

BLE	2.4GHz 2400~2483.5MHz Band Edge @ 3m	
BLE CH19 2440MHz - L		
	Vertical	Fundamental
Peak	 <p>Site : 03CH12-HY Condition : PEAK_BE_74 3m HORN_9120D_1328 VERTICAL : RBW:1000.000kHz VBW:3000.000kHz SWT:Auto</p>	 <p>Site : 03CH12-HY Condition : PEAK_74 3m HORN_9120D_1328 VERTICAL : RBW:1000.000kHz VBW:3000.000kHz SWT:Auto</p>
Avg.	 <p>Site : 03CH12-HY Condition : AVG_BE_54 3m HORN_9120D_1328 VERTICAL : RBW:1000.000kHz VBW:3.000kHz SWT:Auto</p>	 <p>Site : 03CH12-HY Condition : AVG_54 3m HORN_9120D_1328 VERTICAL : RBW:1000.000kHz VBW:3.000kHz SWT:Auto</p>



BLE	2.4GHz 2400~2483.5MHz Band Edge @ 3m	
BLE CH19 2440MHz - R		
	Vertical	Fundamental
<p>Peak</p>		<p>Left blank</p>
<p>Avg.</p>		<p>Left blank</p>

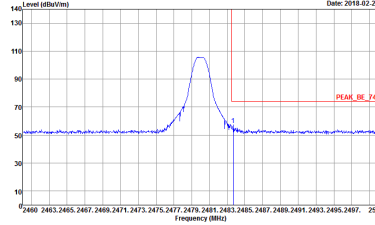
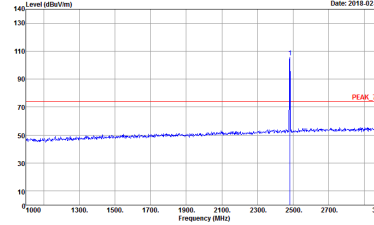
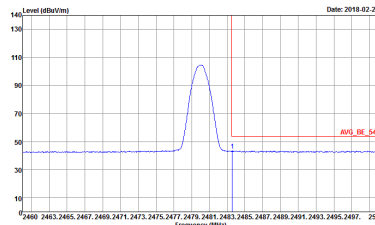
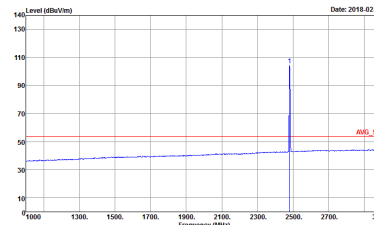

BLE	2.4GHz 2400~2483.5MHz Band Edge @ 3m	
BLE CH39 2480MHz		
	Horizontal	Fundamental
Peak	 <p>Site : 03CH12-HY Condition : PEAK_BE_74 3m HORN_9120D_1328 HORIZONTAL : RBW:1000.000kHz VBW:3000.000kHz SWT:Auto</p>	 <p>Site : 03CH12-HY Condition : PEAK_74 3m HORN_9120D_1328 HORIZONTAL : RBW:1000.000kHz VBW:3000.000kHz SWT:Auto</p>
Avg.	 <p>Site : 03CH12-HY Condition : AVG_BE_54 3m HORN_9120D_1328 HORIZONTAL : RBW:1000.000kHz VBW:3.000kHz SWT:Auto</p>	 <p>Site : 03CH12-HY Condition : AVG_54 3m HORN_9120D_1328 HORIZONTAL : RBW:1000.000kHz VBW:3.000kHz SWT:Auto</p>



BLE	2.4GHz 2400~2483.5MHz Band Edge @ 3m	
BLE CH39 2480MHz		
	Vertical	Fundamental
Peak	<p>Site : 03CH2-HY Condition : PEAK_BE_74 3m HORN_9120D_1328 VERTICAL : RBW:1000.000kHz VBW:3000.000kHz SWT:Auto</p>	<p>Site : 03CH2-HY Condition : PEAK_74 3m HORN_9120D_1328 VERTICAL : RBW:1000.000kHz VBW:3000.000kHz SWT:Auto</p>
Avg.	<p>Site : 03CH2-HY Condition : AVG_BE_54 3m HORN_9120D_1328 VERTICAL : RBW:1000.000kHz VBW:3000.000kHz SWT:Auto</p>	<p>Site : 03CH2-HY Condition : AVG_54 3m HORN_9120D_1328 VERTICAL : RBW:1000.000kHz VBW:3000.000kHz SWT:Auto</p>



2.4GHz 2400~2483.5MHz
BLE (Harmonic @ 3m)

BLE	2.4GHz 2400~2483.5MHz Harmonic @ 3m	
	BLE CH00 2402MHz	
	Horizontal	Vertical
Peak Avg.	<p>Site : 03CH12-HY Condition : PEAK_74 3m HORN_91200_1328 HORIZONTAL Detector : Peak</p>	<p>Site : 03CH12-HY Condition : PEAK_74 3m HORN_91200_1328 VERTICAL Detector : Peak</p>

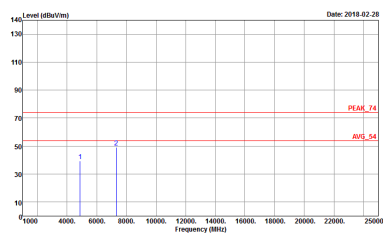
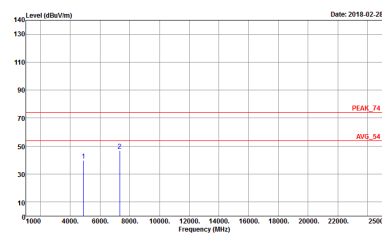

BLE	2.4GHz 2400~2483.5MHz Harmonic @ 3m	
BLE CH19 2440MHz		
Horizontal		Vertical
<p>Peak</p> <p>Avg.</p>	 <p>Site : 03CH12-HY Condition : PEAK_74 3m HORN_9120D_1328 HORIZONTAL Detector : Peak</p>	 <p>Site : 03CH12-HY Condition : PEAK_74 3m HORN_9120D_1328 VERTICAL Detector : Peak</p>



BLE	2.4GHz 2400~2483.5MHz Harmonic @ 3m	
	BLE CH39 2480MHz	
	Horizontal	Vertical
Peak	<p>Site : 03CH12-HY Condition : PEAK_74 3m HORN_91200_1328 HORIZONTAL Detector : Peak</p>	<p>Site : 03CH12-HY Condition : PEAK_74 3m HORN_91200_1328 VERTICAL Detector : Peak</p>



<For 2Mbps>

2.4GHz 2400~2483.5MHz

BLE (Band Edge @ 3m)

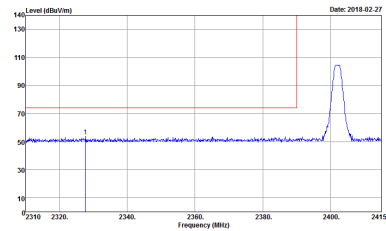
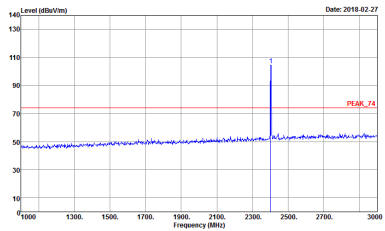
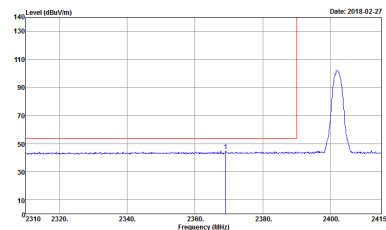
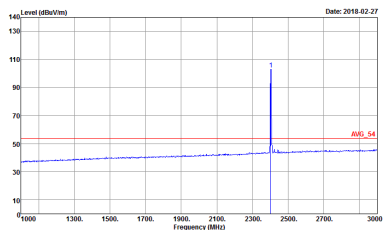
BLE	2.4GHz 2400~2483.5MHz Band Edge @ 3m	
	BLE CH00 2402MHz	
	Horizontal	Fundamental
Peak	 <p>Site Condition : 03CH12-4Y : PEAK_BE_74 3m HORN_91200_1328 HORIZONTAL : RBW:1000.000kHz VBW:3000.000kHz SWT:Auto</p>	 <p>Site Condition : 03CH12-4Y : PEAK_74 3m HORN_91200_1328 HORIZONTAL : RBW:1000.000kHz VBW:3000.000kHz SWT:Auto</p>
Avg.	 <p>Site Condition : 03CH12-4Y : AVG_BE_54 3m HORN_91200_1328 HORIZONTAL : RBW:1000.000kHz VBW:10.000kHz SWT:Auto</p>	 <p>Site Condition : 03CH12-4Y : AVG_54 3m HORN_91200_1328 HORIZONTAL : RBW:1000.000kHz VBW:10.000kHz SWT:Auto</p>

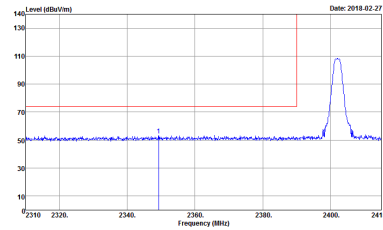
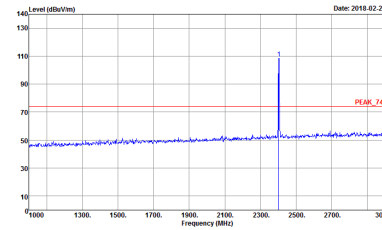
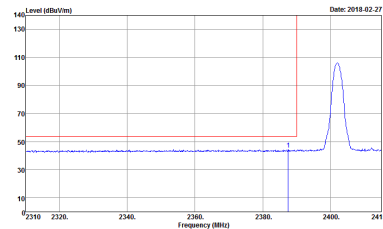
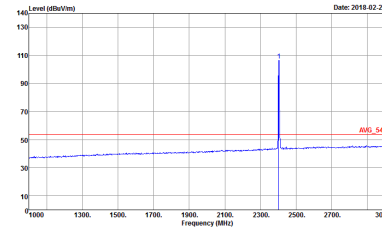

BLE	2.4GHz 2400~2483.5MHz Band Edge @ 3m	
BLE CH00 2402MHz		
	Vertical	Fundamental
Peak	 <p>Site : 03CH12-HY Condition : PEAK_BE_74 3m HORN_91200_1328 VERTICAL : RBW:1000.000kHz VBW:3000.000kHz SWT:Auto</p>	 <p>Site : 03CH12-HY Condition : PEAK_74 3m HORN_91200_1328 VERTICAL : RBW:1000.000kHz VBW:3000.000kHz SWT:Auto</p>
Avg	 <p>Site : 03CH12-HY Condition : AVG_BE_54 3m HORN_91200_1328 VERTICAL : RBW:1000.000kHz VBW:10.000kHz SWT:Auto</p>	 <p>Site : 03CH12-HY Condition : AVG_54 3m HORN_91200_1328 VERTICAL : RBW:1000.000kHz VBW:10.000kHz SWT:Auto</p>

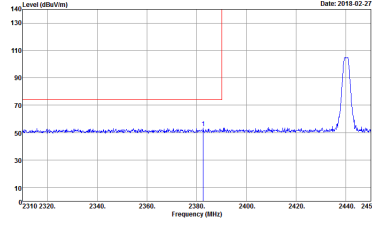
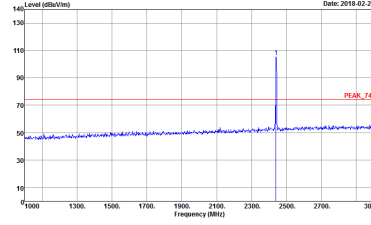
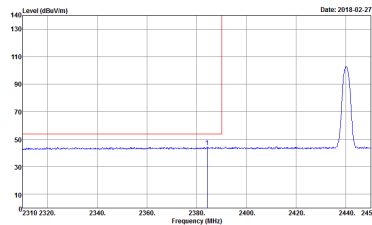
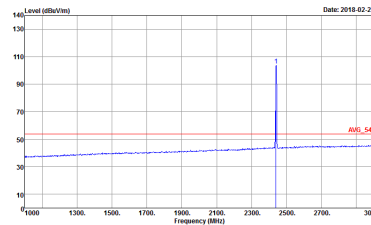

BLE	2.4GHz 2400~2483.5MHz Band Edge @ 3m	
	BLE CH19 2440MHz - L	
	Horizontal	Fundamental
Peak	 <p>Date: 2018-02-27</p> <p>Site : 03CH12-HY Condition : PEAK_BE_74 3m HORN_91200_1328 HORIZONTAL : RBW:1000.000kHz VBW:3000.000kHz SWT:Auto</p>	 <p>Date: 2018-02-27</p> <p>Site : 03CH12-HY Condition : PEAK_74 3m HORN_91200_1328 HORIZONTAL : RBW:1000.000kHz VBW:3000.000kHz SWT:Auto</p>
Avg.	 <p>Date: 2018-02-27</p> <p>Site : 03CH12-HY Condition : AVG_BE_54 3m HORN_91200_1328 HORIZONTAL : RBW:1000.000kHz VBW:10.000kHz SWT:Auto</p>	 <p>Date: 2018-02-27</p> <p>Site : 03CH12-HY Condition : AVG_54 3m HORN_91200_1328 HORIZONTAL : RBW:1000.000kHz VBW:10.000kHz SWT:Auto</p>



BLE	2.4GHz 2400~2483.5MHz Band Edge @ 3m	
	BLE CH19 2440MHz - R	
	Horizontal	Fundamental
Peak	<p>Site : 03CH12-HY Condition : PEAK_BE_74 3m HORN_91200_1328 HORIZONTAL : RBW:1000.000kHz VBW:3000.000kHz SWT:Auto</p>	Left blank
Avg.	<p>Site : 03CH12-HY Condition : AVG_BE_54 3m HORN_91200_1328 HORIZONTAL : RBW:1000.000kHz VBW:10.000kHz SWT:Auto</p>	Left blank



BLE	2.4GHz 2400~2483.5MHz Band Edge @ 3m	
BLE CH19 2440MHz - L		
	Vertical	Fundamental
Peak	<p>Site : 03CH12-HY Condition : PEAK_BE_74 3m HORN_9120D_1328 VERTICAL : RBW:1000.000kHz VBW:3000.000kHz SWT:Auto</p>	<p>Site : 03CH12-HY Condition : PEAK_74 3m HORN_9120D_1328 VERTICAL : RBW:1000.000kHz VBW:3000.000kHz SWT:Auto</p>
Avg.	<p>Site : 03CH12-HY Condition : AVG_BE_54 3m HORN_9120D_1328 VERTICAL : RBW:1000.000kHz VBW:10.000kHz SWT:Auto</p>	<p>Site : 03CH12-HY Condition : AVG_54 3m HORN_9120D_1328 VERTICAL : RBW:1000.000kHz VBW:10.000kHz SWT:Auto</p>

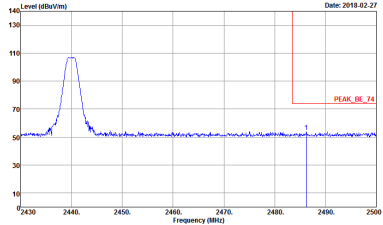
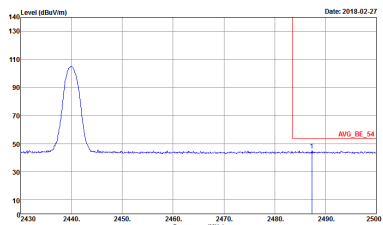

BLE	2.4GHz 2400~2483.5MHz Band Edge @ 3m	
BLE CH19 2440MHz - R		
	Vertical	Fundamental
Peak	 <p>Site : 03CH12-HY Condition : PEAK_BE_74 3m HORN_91200_1328 VERTICAL : RBW:1000.000kHz VBW:3000.000kHz SWT:Auto</p>	Left blank
Avg.	 <p>Site : 03CH12-HY Condition : AVG_BE_54 3m HORN_91200_1328 VERTICAL : RBW:1000.000kHz VBW:10.000kHz SWT:Auto</p>	Left blank

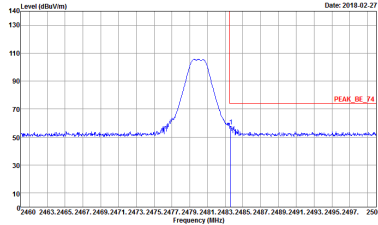
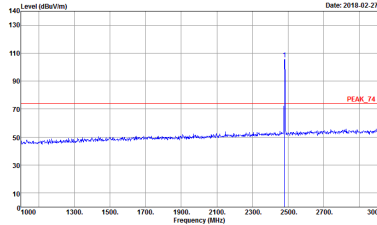
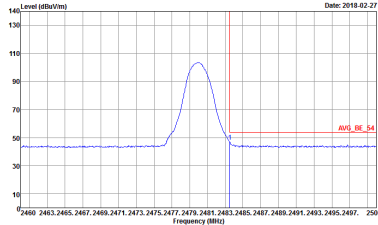
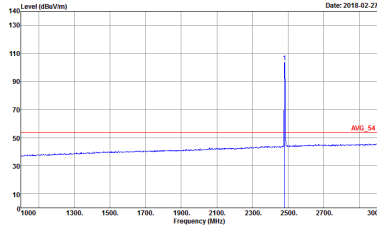

BLE	2.4GHz 2400~2483.5MHz Band Edge @ 3m	
BLE CH39 2480MHz		
	Horizontal	Fundamental
Peak	 <p>Site : 03CH12-HY Condition : PEAK_BE_74 3m HORN_9120D_1328 HORIZONTAL : RBW:1000.000kHz VBW:3000.000kHz SWT:Auto</p>	 <p>Site : 03CH12-HY Condition : PEAK_74 3m HORN_9120D_1328 HORIZONTAL : RBW:1000.000kHz VBW:3000.000kHz SWT:Auto</p>
Avg.	 <p>Site : 03CH12-HY Condition : AVG_BE_54 3m HORN_9120D_1328 HORIZONTAL : RBW:1000.000kHz VBW:10.000kHz SWT:Auto</p>	 <p>Site : 03CH12-HY Condition : AVG_54 3m HORN_9120D_1328 HORIZONTAL : RBW:1000.000kHz VBW:10.000kHz SWT:Auto</p>

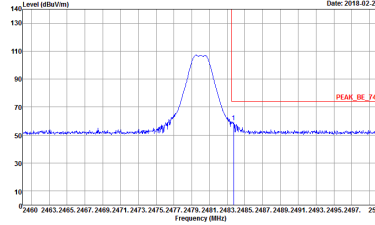
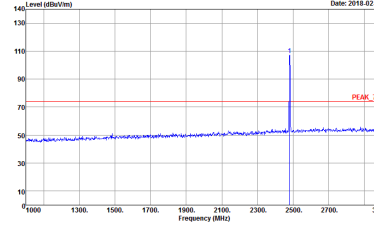
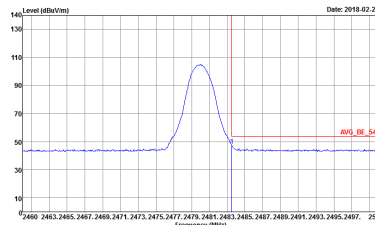
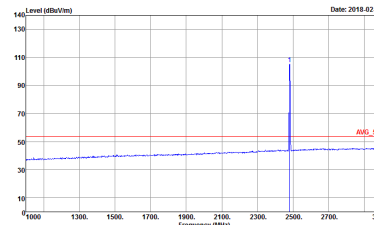

BLE	2.4GHz 2400~2483.5MHz Band Edge @ 3m	
BLE CH39 2480MHz		
	Vertical	Fundamental
Peak	 <p>Site : 03CH2-HY Condition : PEAK_BE_74 3m HORN_9120D_1328 VERTICAL : RBW:1000.000kHz VBW:3000.000kHz SWT:Auto</p>	 <p>Site : 03CH2-HY Condition : PEAK_74 3m HORN_9120D_1328 VERTICAL : RBW:1000.000kHz VBW:3000.000kHz SWT:Auto</p>
Avg.	 <p>Site : 03CH2-HY Condition : AVG_BE_54 3m HORN_9120D_1328 VERTICAL : RBW:1000.000kHz VBW:10.000kHz SWT:Auto</p>	 <p>Site : 03CH2-HY Condition : AVG_54 3m HORN_9120D_1328 VERTICAL : RBW:1000.000kHz VBW:10.000kHz SWT:Auto</p>



2.4GHz 2400~2483.5MHz
BLE (Harmonic @ 3m)

BLE	2.4GHz 2400~2483.5MHz Harmonic @ 3m	
	BLE CH00 2402MHz	
	Horizontal	Vertical
Peak Avg.	<p>Site : 03CH12-HY Condition : PEAK_74 3m HORN_91200_1328 HORIZONTAL Detector : Peak</p>	<p>Site : 03CH12-HY Condition : PEAK_74 3m HORN_91200_1328 VERTICAL Detector : Peak</p>



BLE	2.4GHz 2400~2483.5MHz Harmonic @ 3m	
	BLE CH19 2440MHz	
	Horizontal	Vertical
Peak Avg.	<p>Site : 03CH12-HY Condition : PEAK_74 3m HORN_91200_1328 HORIZONTAL Detector : Peak</p>	<p>Site : 03CH12-HY Condition : PEAK_74 3m HORN_91200_1328 VERTICAL Detector : Peak</p>



BLE	2.4GHz 2400~2483.5MHz Harmonic @ 3m	
	BLE CH39 2480MHz	
	Horizontal	Vertical
Peak	<p>Site : 03CH12-HY Condition : PEAK_74 3m HORN_91200_1328 HORIZONTAL Detector : Peak</p>	<p>Site : 03CH12-HY Condition : PEAK_74 3m HORN_91200_1328 VERTICAL Detector : Peak</p>



Emission below 1GHz
2.4GHz BLE (LF)

BLE	2.4GHz 2400~2483.5MHz	
	BLE LF	
	Horizontal	Vertical
QP / Peak	<p>Site : 03CH12-HY Condition : QP 3m BTL06_6111D_40103 HORIZONTAL Detector : Peak</p>	<p>Site : 03CH12-HY Condition : QP 3m BTL06_6111D_40103 VERTICAL Detector : Peak</p>



Appendix E. Duty Cycle Plots

Band	Duty Cycle(%)	T(us)	1/T(kHz)	VBW Setting	Duty Factor(dB)
Bluetooth -LE 1Mbps	62.42	392	2.55	3kHz	2.05
Bluetooth -LE 2Mbps	32.69	204	4.90	10kHz	4.86



Bluetooth – LE 1Mbps

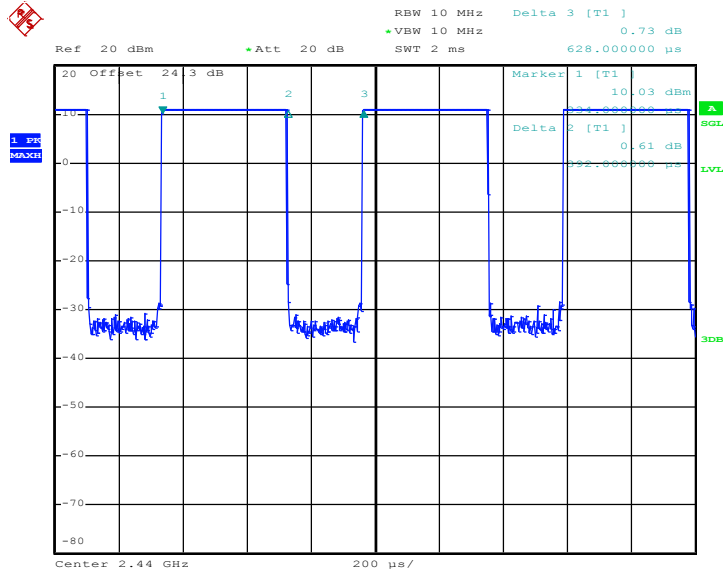

Date: 26.FEB.2018 21:41:50

Bluetooth – LE 2Mbps

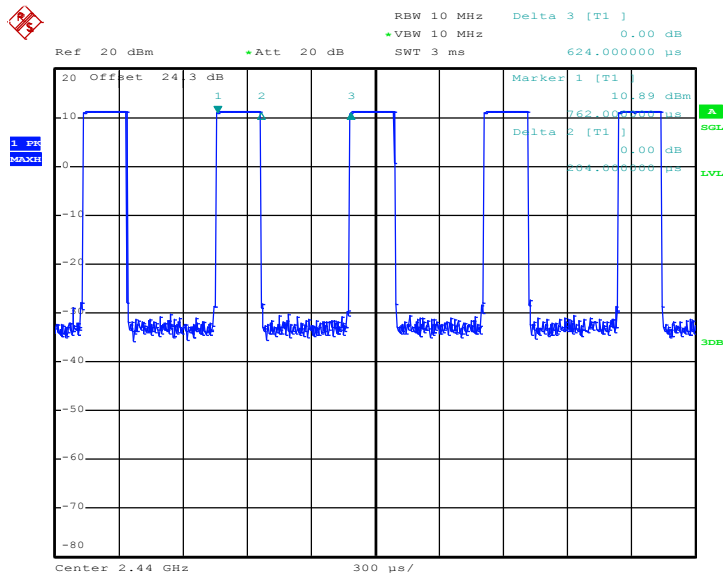

Date: 26.FEB.2018 21:20:26