



FCC RF Test Report

APPLICANT : Motorola Mobility LLC
EQUIPMENT : Mobile Cellular Phone
BRAND NAME : Motorola
MODEL NAME : XT1929-6
FCC ID : IHDT56XE4
STANDARD : FCC 47 CFR Part 2, 22(H), 24(E), 27(L)
CLASSIFICATION : PCS Licensed Transmitter Held to Ear (PCE)

This is a variant report. The product was received on Jan. 18, 2018 and testing was completed on Mar. 07, 2018. We, SPORTON INTERNATIONAL INC., would like to declare that the tested sample has been evaluated in accordance with the test procedures given in ANSI / TIA-603-E and has been in compliance with the applicable technical standards.

The test results in this report apply exclusively to the tested model / sample. Without written approval of SPORTON INTERNATIONAL INC., the test report shall not be reproduced except in full.

Reviewed by: Joseph Lin / Supervisor

Approved by: Jones Tsai / Manager



SPORTON INTERNATIONAL INC.

No. 52, Hwa Ya 1st Rd., Hwa Ya Technology Park, Kwei-Shan District, Tao Yuan City, Taiwan, R.O.C.

SPORTON INTERNATIONAL INC.

TEL : 886-3-327-3456

FAX : 886-3-328-4978

FCC ID : IHDT56XE4

Page Number : 1 of 23

Report Issued Date : Mar. 12, 2018

Report Version : Rev. 01

Report Template No.: BU5-FG22/24/27 Version 2.0



TABLE OF CONTENTS

REVISION HISTORY..... 3

SUMMARY OF TEST RESULT 4

1 GENERAL DESCRIPTION 5

 1.1 Applicant..... 5

 1.2 Manufacturer 5

 1.3 Product Feature of Equipment Under Test 5

 1.4 Product Specification of Equipment Under Test 7

 1.5 Modification of EUT 8

 1.6 Maximum ERP/EIRP Power, Frequency Tolerance, and Emission Designator 8

 1.7 Testing Location 9

 1.8 Applicable Standards 9

2 TEST CONFIGURATION OF EQUIPMENT UNDER TEST 10

 2.1 Test Mode..... 10

 2.2 Connection Diagram of Test System 11

 2.3 Support Unit used in test configuration 11

 2.4 Measurement Results Explanation Example 12

 2.5 Frequency List of Low/Middle/High Channels..... 12

3 CONDUCTED TEST RESULT..... 13

 3.1 Measuring Instruments..... 13

 3.2 Test Setup 13

 3.3 Test Result of Conducted Test..... 13

 3.4 Conducted Output Power and ERP/EIRP 14

 3.5 Peak-to-Average Ratio 15

 3.6 99% Occupied Bandwidth and 26dB Bandwidth Measurement..... 16

 3.7 Conducted Band Edge 17

 3.8 Conducted Spurious Emission 18

 3.9 Frequency Stability..... 19

4 RADIATED TEST ITEMS 20

 4.1 Measuring Instruments..... 20

 4.2 Test Setup 20

 4.3 Test Result of Radiated Test..... 20

 4.4 Field Strength of Spurious Radiation Measurement 21

5 LIST OF MEASURING EQUIPMENT 22

6 UNCERTAINTY OF EVALUATION 23

APPENDIX A. TEST RESULTS OF CONDUCTED TEST

APPENDIX B. TEST RESULTS OF ERP/EIRP AND RADIATED TEST



SUMMARY OF TEST RESULT

Report Section	FCC Rule	Description	Limit	Result	Remark
3.4	§2.1046	Conducted Output Power	Reporting Only	PASS	-
	§22.913(a)(2)	Effective Radiated Power	< 7 Watts	PASS	-
	§24.232(c)	Equivalent Isotropic Radiated Power	< 2 Watts	PASS	-
	§27.50(d)(4)	Equivalent Isotropic Radiated Power	< 1 Watts	PASS	-
3.5	§24.232(d)	Peak-to-Average Ratio	< 13 dB	PASS	-
3.6	§2.1049 §22.917(b) §24.238(b) §27.53(g)	Occupied Bandwidth	Reporting Only	PASS	-
3.7	§2.1051 §22.917(a) §24.238(a) §27.53(h)	Band Edge Measurement	< 43+10log ₁₀ (P[Watts])	PASS	-
3.8	§2.1051 §22.917(a) §24.238(a) §27.53(h)	Conducted Emission	< 43+10log ₁₀ (P[Watts])	PASS	-
3.9	§2.1055 §22.355	Frequency Stability for Temperature & Voltage	< 2.5 ppm for Part 22	PASS	-
	§2.1055 §24.235 §27.54		Within Authorized Band		
4.4	§2.1053 §22.917(a) §24.238(a) §27.53(h)	Field Strength of Spurious Radiation	< 43+10log ₁₀ (P[Watts])	PASS	Under limit 18.48 dB at 5730.000 MHz



1 General Description

1.1 Applicant

Motorola Mobility LLC
222 W, Merchandise Mart Plaza, Chicago IL 60654 USA

1.2 Manufacturer

Motorola Mobility LLC
222 W, Merchandise Mart Plaza, Chicago IL 60654 USA

1.3 Product Feature of Equipment Under Test

Product Feature	
Equipment	Mobile Cellular Phone
Brand Name	Motorola
Model Name	XT1929-6
FCC ID	IHDT56XE4
Sample 1	EUT with Dual SIM
Sample 2	EUT with Single SIM
IMEI Code	Conducted : IMEI 1: 354102090009370 IMEI 2: 354102090009388
	Radiation : IMEI 1: 354102090013794 IMEI 2: 354102090013802
EUT supports Radios application	GSM/EGPRS/WCDMA/HSPA/LTE/GNSS/NFC WLAN 11b/g/n HT20 WLAN 11a/n HT20/HT40 WLAN 11ac VHT20/VHT40/VHT80 Bluetooth BR/EDR/LE
HW Version	DVT2
EUT Stage	Identical Prototype

Remark:

1. The above EUT's information was declared by manufacturer. Please refer to the specifications or user's manual for more detailed description.
2. This is a variant report. Except Conducted test item for GSM850, Radiated Spurious Emission for GSM850, GSM1900, WCDMA Band II and Band V, Conducted Output Power, Equivalent Isotropic Radiated Power, and Effective Radiated Power, FG811821-05A report reuses test data from the FG811821A report.



Accessory List	
AC Adapter 1	Brand Name : Motorola
	Model Name : SC-22 SPN5970A
	Manufacturer : Salom
AC Adapter 2	Brand Name : Motorola
	Model Name : SC-22 SPN5993A
	Manufacturer : Chenyang
AC Adapter 3	Brand Name : Motorola
	Model Name : SC-23 SPN5971A
	Manufacturer : Salom
AC Adapter 4	Brand Name : Motorola
	Model Name : SC-23 SPN5989A
	Manufacturer : Chenyang
AC Adapter 5	Brand Name : Motorola
	Model Name : SC-27 SPN5975A
	Manufacturer : Salom
AC Adapter 6	Brand Name : Motorola
	Model Name : SC-27 SPN5992A
	Manufacturer : Chenyang
Battery	Brand Name : Motorola
	Model Name : JS40
	Manufacturer : SUNWODA
C2Audio Cable 1	Brand Name : Motorola
	Model Name : SC18C27844
	Manufacturer : Luxshare
C2Audio Cable 2	Brand Name : Motorola
	Model Name : SC18C27845
	Manufacturer : Cabletech
USB Cable 1	Brand Name : Cabletech
	Model Name : SKN6473A
USB Cable 2	Brand Name : FOXLINK
	Model Name : SKN6473A 17195-C 0403532
USB Cable 3	Brand Name : SAIBAO
	Model Name : SKN6473A 17214-C 1127044
USB Cable 4	Brand Name : Luxshare
	Model Name : SKN6473A 17227-C 1126538



1.4 Product Specification of Equipment Under Test

Standards-related Product Specification	
Tx Frequency	GSM/GPRS/EDGE: 850: 824.2 MHz ~ 848.8 MHz 1900: 1850.2 MHz ~ 1909.8MHz WCDMA: Band V: 826.4 MHz ~ 846.6 MHz Band II: 1852.4 MHz ~ 1907.6 MHz Band IV: 1712.4 MHz ~ 1752.6 MHz
Rx Frequency	GSM/GPRS/EDGE: 850: 869.2 MHz ~ 893.8 MHz 1900: 1930.2 MHz ~ 1989.8 MHz WCDMA: Band V: 871.4 MHz ~ 891.6 MHz Band II: 1932.4 MHz ~ 1987.6 MHz Band IV: 2112.4 MHz ~ 2152.6 MHz
Maximum Output Power to Antenna	GSM/GPRS/EDGE: 850: 32.69 dBm 1900: 29.37 dBm WCDMA: Band V: 22.59 dBm Band II: 22.67 dBm Band IV: 22.70 dBm
Antenna Type	Fixed Internal Antenna
Type of Modulation	GSM: GMSK GPRS: GMSK EDGE: GMSK / 8PSK WCDMA: BPSK (Uplink) HSDPA: 64QAM (Downlink) HSUPA: QPSK (Uplink)



1.5 Modification of EUT

No modifications are made to the EUT during all test items.

1.6 Maximum ERP/EIRP Power, Frequency Tolerance, and Emission Designator

FCC Rule	Frequency Range (MHz)	System	Type of Modulation	Maximum ERP/EIRP (W)	Frequency Tolerance (ppm)	Emission Designator
Part 22	824.2 ~848.8	GSM850 GPRS class 8	GMSK	0.3119	0.0120 ppm	245KGXW
Part 22	824.2 ~848.8	GSM850 EDGE class 8	8PSK	0.0684	0.0096 ppm	247KG7W
Part 22	826.4 ~846.6	WCDMA Band V RMC 12.2Kbps	BPSK	0.0305	-	-
Part 24	1850.2 ~1909.8	GSM1900 GPRS class 8	GMSK	0.5333	-	-
Part 24	1850.2 ~1909.8	GSM1900 EDGE class 8	8PSK	0.2198	-	-
Part 24	1852.4 ~ 1907.6	WCDMA Band II RMC 12.2Kbps	BPSK	0.1140	-	-
Part 27	1712.4 ~ 1752.6	WCDMA Band IV RMC 12.2Kbps	BPSK	0.1175	-	-



1.7 Testing Location

Sporton Lab is accredited to ISO 17025 by Taiwan Accreditation Foundation (TAF code : 1190) and the FCC designation No. TW1190 and TW0007 under the FCC 2.948(e) by Mutual Recognition Agreement (MRA) in FCC Test.

Test Site	SPORTON INTERNATIONAL INC.
Test Site Location	No. 52, Hwa Ya 1 st Rd., Hwa Ya Technology Park, Kwei-Shan District, Tao Yuan City, Taiwan, R.O.C. TEL: +886-3-327-3456 FAX: +886-3-328-4978
Test Site No.	Sporton Site No. TH03-HY

Test Site	SPORTON INTERNATIONAL INC.
Test Site Location	No.58, Aly. 75, Ln. 564, Wenhua 3rd Rd., Kwei-Shan District, Tao Yuan City, Taiwan R.O.C. TEL: +886-3-327-0868 FAX: +886-3-327-0855
Test Site No.	Sporton Site No. : 03CH13-HY

1.8 Applicable Standards

According to the specifications of the manufacturer, the EUT must comply with the requirements of the following standards:

- ♦ 47 CFR Part 2, 22(H), 24(E), 27(L)
- ♦ ANSI / TIA / EIA-603-D-2010
- ♦ FCC KDB 971168 D01 Power Meas. License Digital Systems v02r02
- ♦ FCC KDB 412172 D01 Determining ERP and EIRP v01r01

Remark:

1. All test items were verified and recorded according to the standards and without any deviation during the test.
2. This EUT has also been tested and complied with the requirements of FCC Part 15, Subpart B, recorded in a separate test report.



2 Test Configuration of Equipment Under Test

2.1 Test Mode

Antenna port conducted and radiated test items were performed according to KDB 971168 D01 Power Meas. License Digital Systems v02r02 with maximum output power.

Radiated measurements were performed with rotating EUT in different three orthogonal test planes to find the maximum emission.

Radiated emissions were investigated as following frequency range:

1. 30 MHz to 9000 MHz for GSM850 and WCDMA Band V.
2. 30 MHz to 18000 MHz for WCDMA Band IV.
3. 30 MHz to 19100 MHz for GSM1900 and WCDMA Band II
4. All modes and data rates and positions were investigated.

Test modes are chosen to be reported as the worst case configuration below:

Test Modes		
Band	Radiated TCs	Conducted TCs
GSM 850	<ul style="list-style-type: none"> ■ GPRS class 8 Link ■ EDGE class 8 Link 	<ul style="list-style-type: none"> ■ GPRS class 8 Link ■ EDGE class 8 Link
GSM 1900	<ul style="list-style-type: none"> ■ GPRS class 8 Link ■ EDGE class 8 Link 	-
WCDMA Band V	<ul style="list-style-type: none"> ■ RMC 12.2Kbps Link 	-
WCDMA Band II	<ul style="list-style-type: none"> ■ RMC 12.2Kbps Link 	-
WCDMA Band IV	<ul style="list-style-type: none"> ■ HSDPA Link 	-

Remark: All the radiated test cases were performance with Adapter 1, USB Cable 1, and Sample 1.

2.2 Connection Diagram of Test System

<EUT Standalone>

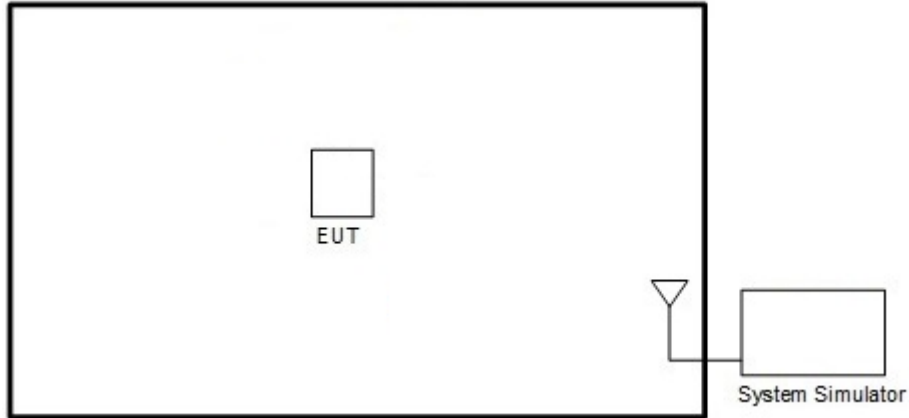

<EUT with Adapter>

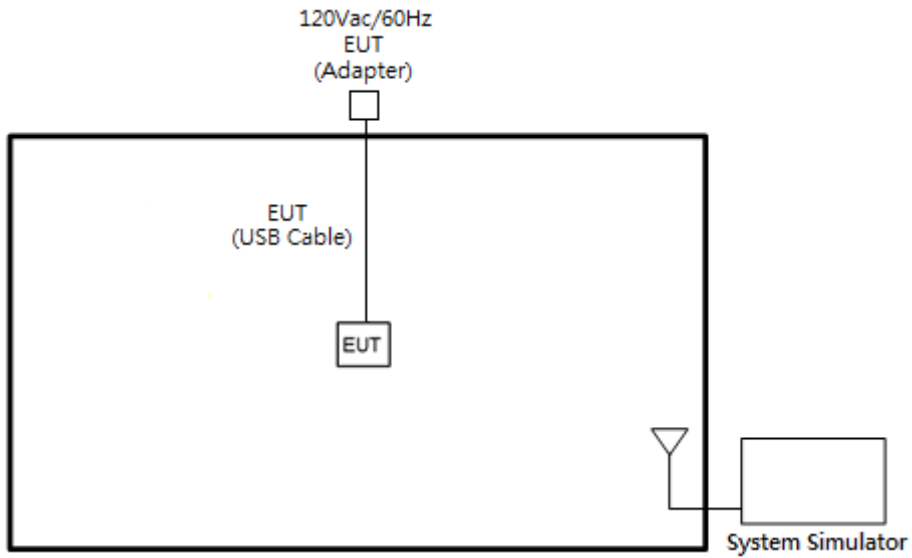

2.3 Support Unit used in test configuration

Item	Equipment	Trade Name	Model No.	FCC ID	Data Cable	Power Cord
1.	System Simulator	R&S	CMU 200	N/A	N/A	Unshielded, 1.8 m



2.4 Measurement Results Explanation Example

For all conducted test items:

The offset level is set in the spectrum analyzer to compensate the RF cable loss and attenuator factor between RF conducted output port and spectrum analyzer. With the offset compensation, the spectrum analyzer reading level will be exactly the RF output level.

The spectrum analyzer offset is derived from RF cable loss and attenuator factor.

$$\text{Offset} = \text{RF cable loss} + \text{attenuator factor}.$$

The following shows an offset computation example with RF cable loss 4.2 dB and a 10dB attenuator.

Example :

$$\begin{aligned} \text{Offset(dB)} &= \text{RF cable loss(dB)} + \text{attenuator factor(dB)}. \\ &= 4.2 + 10 = 14.2 \text{ (dB)} \end{aligned}$$

2.5 Frequency List of Low/Middle/High Channels

Frequency List				
Band	Channel/Frequency(MHz)	Lowest	Middle	Highest
GSM850	Channel	128	189	251
	Frequency	824.2	836.4	848.8
WCDMA Band V	Channel	4132	4182	4233
	Frequency	826.4	836.4	846.6
GSM1900	Channel	512	661	810
	Frequency	1850.2	1880.0	1909.8
WCDMA Band II	Channel	9262	9400	9538
	Frequency	1852.4	1880.0	1907.6
WCDMA Band IV	Channel	1312	1413	1513
	Frequency	1712.4	1732.6	1752.6

3 Conducted Test Result

3.1 Measuring Instruments

See list of measuring instruments of this test report.

3.2 Test Setup

3.2.1 Conducted Output Power

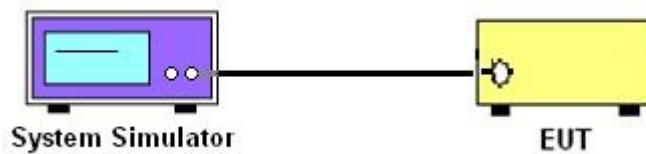

3.2.2 Peak-to-Average Ratio, Occupied Bandwidth, Conducted Band-Edge and Conducted Spurious Emission

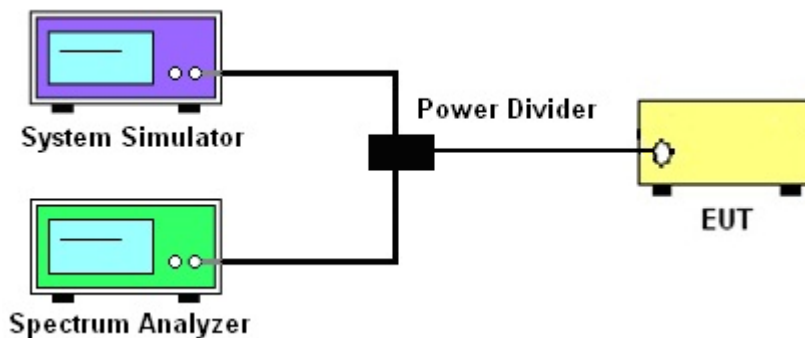

3.2.3 Frequency Stability

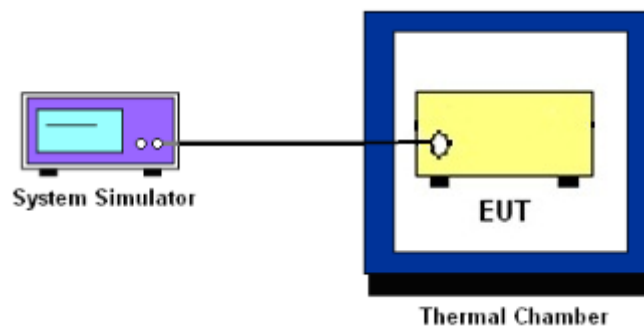

3.3 Test Result of Conducted Test

Please refer to Appendix A.



3.4 Conducted Output Power and ERP/EIRP

3.4.1 Description of the Conducted Output Power and ERP/EIRP

A system simulator was used to establish communication with the EUT. Its parameters were set to enforce EUT transmitting at the maximum power. The measured power in the radio frequency on the transmitter output terminals shall be reported.

The ERP of mobile transmitters must not exceed 7 Watts for GSM850 and WCDMA Band V.

The EIRP of mobile transmitters must not exceed 2 Watts for GSM1900 and WCDMA Band II.

The EIRP of mobile transmitters must not exceed 1 Watts for WCDMA Band IV.

According to KDB 412172 D01 Power Approach,

$EIRP = P_T + G_T - L_C$, $ERP = EIRP - 2.15$, where

P_T = transmitter output power in dBm

G_T = gain of the transmitting antenna in dBi

L_C = signal attenuation in the connecting cable between the transmitter and antenna in dB

3.4.2 Test Procedures

1. The transmitter output port was connected to the system simulator.
2. Set EUT at maximum power through system simulator.
3. Select lowest, middle, and highest channels for each band and different modulation.
4. Measure the maximum burst average power for GSM and maximum average power for other modulation signal.



3.5 Peak-to-Average Ratio

3.5.1 Description of the PAR Measurement

The peak-to-average ratio (PAR) of the transmission may not exceed 13 dB.

3.5.2 Test Procedures

1. The testing follows FCC KDB 971168 D01 v02r02 Section 5.7.1.
2. The EUT was connected to spectrum analyzer and system simulator via a power divider.
3. Set EUT to transmit at maximum output power.
4. When the duty cycle is less than 98%, then signal gating will be implemented on the spectrum analyzer by triggering from the system simulator.
5. Set the CCDF (Complementary Cumulative Distribution Function) option of the spectrum analyzer.
Record the maximum PAPR level associated with a probability of 0.1%.



3.6 99% Occupied Bandwidth and 26dB Bandwidth Measurement

3.6.1 Description of 99% Occupied Bandwidth and 26dB Bandwidth Measurement

The occupied bandwidth is the width of a frequency band such that, below the lower and above the upper frequency limits, the mean powers emitted are each equal to a specified percentage 0.5% of the total mean transmitted power.

The 26 dB emission bandwidth is defined as the frequency range between two points, one above and one below the carrier frequency, at which the spectral density of the emission is attenuated 26 dB below the maximum in-band spectral density of the modulated signal. Spectral density (power per unit bandwidth) is to be measured with a detector of resolution bandwidth equal to approximately 1.0% of the emission bandwidth.

3.6.2 Test Procedures

1. The testing follows FCC KDB 971168 v02r02 Section 4.2.
2. The EUT was connected to spectrum analyzer and system simulator via a power divider.
3. The spectrum analyzer center frequency is set to the nominal EUT channel center frequency. The span range for the spectrum analyzer shall be between two and five times the anticipated OBW.
4. The nominal resolution bandwidth (RBW) shall be in the range of 1 to 5 % of the anticipated OBW, and the VBW shall be at least 3 times the RBW.
5. Set the detection mode to peak, and the trace mode to max hold.
6. Determine the reference value: Set the EUT to transmit a modulated signal. Allow the trace to stabilize. Set the spectrum analyzer marker to the highest level of the displayed trace.
(this is the reference value)
7. Determine the “-26 dB down amplitude” as equal to (Reference Value – X).
8. Place two markers, one at the lowest and the other at the highest frequency of the envelope of the spectral display such that each marker is at or slightly below the “-X dB down amplitude” determined in step 6. If a marker is below this “-X dB down amplitude” value it shall be placed as close as possible to this value. The OBW is the positive frequency difference between the two markers.
9. Use the 99 % power bandwidth function of the spectrum analyzer and report the measured bandwidth.



3.7 Conducted Band Edge

3.7.1 Description of Conducted Band Edge Measurement

The power of any emission outside of the authorized operating frequency ranges must be lower than the transmitter power (P) by a factor of at least $43 + 10 \log (P)$ dB.

3.7.2 Test Procedures

1. The testing follows FCC KDB 971168 D01 v02r02 Section 6.0.
2. The EUT was connected to the spectrum analyzer and system simulator via a power divider.
3. The RF output of EUT was connected to the spectrum analyzer by an RF cable and attenuator. The path loss was compensated to the results for each measurement.
4. The band edges of low and high channels for the highest RF powers were measured.
5. The RF fundamental frequency should be excluded against the limit line in the operating frequency band.
6. The limit line is derived from $43 + 10\log(P)$ dB below the transmitter power P(Watts)



3.8 Conducted Spurious Emission

3.8.1 Description of Conducted Spurious Emission Measurement

The power of any emission outside of the authorized operating frequency ranges must be lower than the transmitter power (P) by a factor of at least $43 + 10 \log (P)$ dB.

It is measured by means of a calibrated spectrum analyzer and scanned from 30 MHz up to a frequency including its 10th harmonic.

3.8.2 Test Procedures

1. The testing follows FCC KDB 971168 D01 v02r02 Section 6.0.
2. The EUT was connected to the spectrum analyzer and system simulator via a power divider.
3. The RF output of EUT was connected to the spectrum analyzer by an RF cable and attenuator. The path loss was compensated to the results for each measurement.
4. The middle channel for the highest RF power within the transmitting frequency was measured.
5. The conducted spurious emission for the whole frequency range was taken.
6. The RF fundamental frequency should be excluded against the limit line in the operating frequency band.
7. The limit line is derived from $43 + 10\log(P)$ dB below the transmitter power P(Watts)



3.9 Frequency Stability

3.9.1 Description of Frequency Stability Measurement

The frequency stability shall be measured by variation of ambient temperature and variation of primary supply voltage to ensure that the fundamental emission stays within the authorized frequency block. The frequency stability of the transmitter shall be maintained within $\pm 0.00025\%$ ($\pm 2.5\text{ppm}$) of the center frequency.

3.9.2 Test Procedures for Temperature Variation

1. The testing follows FCC KDB 971168 D01 v02r02 Section 9.0.
2. The EUT was set up in the thermal chamber and connected with the system simulator.
3. With power OFF, the temperature was decreased to -30°C and the EUT was stabilized before testing. Power was applied and the maximum change in frequency was recorded within one minute.
4. With power OFF, the temperature was raised in 10°C steps up to 50°C . The EUT was stabilized at each step for at least half an hour. Power was applied and the maximum frequency change was recorded within one minute.

3.9.3 Test Procedures for Voltage Variation

1. The testing follows FCC KDB 971168 D01 v02r02 Section 9.0.
2. The EUT was placed in a temperature chamber at $20\pm 5^{\circ}\text{C}$ and connected with the system simulator.
3. The power supply voltage to the EUT was varied from 85% to 115% of the nominal value measured at the input to the EUT.
4. The variation in frequency was measured for the worst case.

4 Radiated Test Items

4.1 Measuring Instruments

See list of measuring instruments of this test report.

4.2 Test Setup

4.2.1 For radiated test from 30MHz to 1GHz

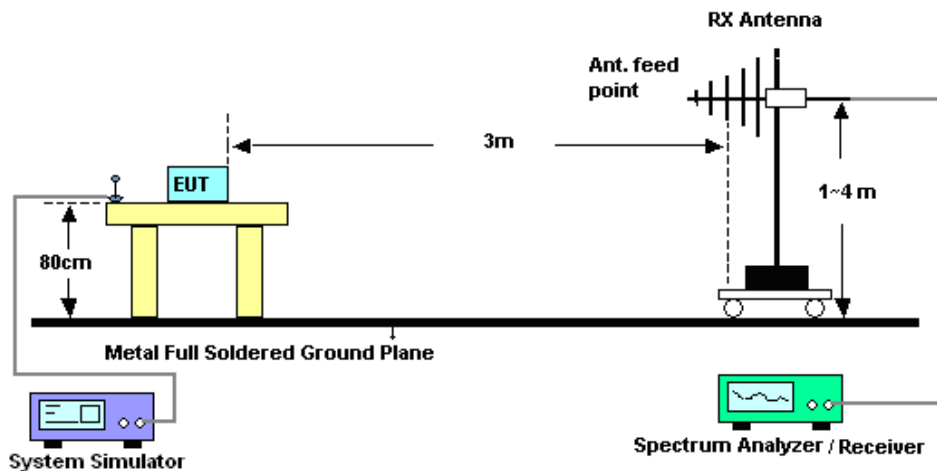

4.2.2 For radiated test above 1GHz

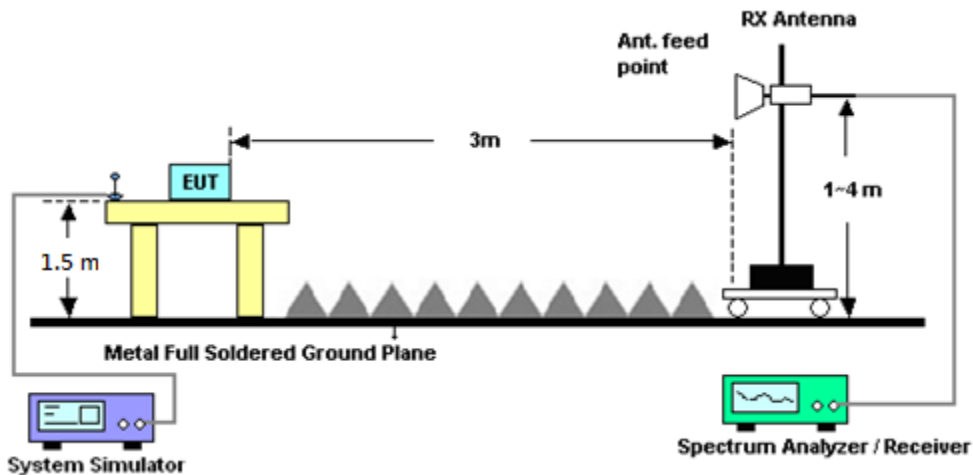

4.3 Test Result of Radiated Test

Please refer to Appendix B.



4.4 Field Strength of Spurious Radiation Measurement

4.4.1 Description of Field Strength of Spurious Radiated Measurement

The power of any emission outside of the authorized operating frequency ranges must be attenuated below the transmitter power (P) by a factor of at least $43 + 10 \log (P)$ dB. The spectrum is scanned from 30 MHz up to a frequency including its 10th harmonic.

4.4.2 Test Procedures

1. The testing follows FCC KDB 971168 D01 v02r02 Section 5.8 and ANSI / TIA-603-D-2010 Section 2.2.12.
2. The EUT was placed on a rotatable wooden table 0.8 meters for frequency below 1GHz and 1.5 meter for frequency above 1GHz above the ground.
3. The EUT was set 3 meters from the receiving antenna, which was mounted on the antenna tower.
4. The table was rotated 360 degrees to determine the position of the highest spurious emission.
5. The height of the receiving antenna is varied between one meter and four meters to search for the maximum spurious emission for both horizontal and vertical polarizations.
6. Make the measurement with the spectrum analyzer's RBW = 1MHz, VBW = 3MHz, taking record of maximum spurious emission.
7. A horn antenna was substituted in place of the EUT and was driven by a signal generator.
8. Tune the output power of signal generator to the same emission level with EUT maximum spurious emission.
9. Taking the record of output power at antenna port.
10. Repeat step 7 to step 8 for another polarization.
11. $EIRP \text{ (dBm)} = S.G. \text{ Power} - Tx \text{ Cable Loss} + Tx \text{ Antenna Gain}$
12. $ERP \text{ (dBm)} = EIRP - 2.15$
13. The RF fundamental frequency should be excluded against the limit line in the operating frequency band.
14. The limit line is derived from $43 + 10\log(P)$ dB below the transmitter power P(Watts)



5 List of Measuring Equipment

Instrument	Manufacturer	Model No.	Serial No.	Characteristics	Calibration Date	Test Date	Due Date	Remark
Spectrum Analyzer	Rohde & Schwarz	FSP30	101329	9kHz~30GHz	Jun. 26, 2017	Mar. 07, 2018	Jun. 25, 2018	Conducted (TH03-HY)
Temperature Chamber	ESPEC	SU-641	92013721	-30°C ~70°C	Nov. 16, 2016	Mar. 07, 2018	Nov. 15, 2018	Conducted (TH03-HY)
Programmable Power Supply	GW Instek	PSS-2005	EL883644	Voltage:0~20V; Current:0~5A	Nov. 22, 2016	Mar. 07, 2018	Nov. 21, 2018	Conducted (TH03-HY)
Base Station (Measure)	Rohde & Schwarz	CMU200	117995	GSM / GPRS / WCDMA / CDMA	Aug. 09, 2017	Mar. 07, 2018	Aug. 08, 2018	Conducted (TH03-HY)
Amplifier	MITEQ	TTA1840-35-HG	1871923	18GHz~40GHz, VSWR : 2.5:1 max	Jul. 18, 2017	Mar. 02, 2018~ Mar. 06, 2018	Jul. 17, 2018	Radiation (03CH13-HY)
Amplifier	Sonoma-Instrument	310 N	187282	9KHz~1GHz	Dec. 21, 2016	Mar. 02, 2018~ Mar. 06, 2018	Dec. 20, 2018	Radiation (03CH13-HY)
Bilog Antenna	TESEQ	CBL 6111D&00800N 1D01N-06	40103&07	30MHz to 1GHz	Jan. 10, 2018	Mar. 02, 2018~ Mar. 06, 2018	Jan. 09, 2019	Radiation (03CH13-HY)
Horn Antenna	SCHWARZBECK	BBHA 9120 D	9120D-1241	1GHz ~ 18GHz	Jun. 15, 2017	Mar. 02, 2018~ Mar. 06, 2018	Jun. 14, 2018	Radiation (03CH13-HY)
Preamplifier	MITEQ	AMF-7D-00101 800-30-10P	1590074	1GHz~18GHz	May 22, 2017	Mar. 02, 2018~ Mar. 06, 2018	May 21, 2018	Radiation (03CH13-HY)
Preamplifier	Keysight	83017A	MY53270147	1GHz~26.5GHz	Feb. 02, 2018	Mar. 02, 2018~ Mar. 06, 2018	Feb. 01, 2019	Radiation (03CH13-HY)
Spectrum Analyzer	Keysight	N9010A	MY55370526	10Hz~44GHz	Mar. 15, 2017	Mar. 02, 2018~ Mar. 06, 2018	Mar. 14, 2018	Radiation (03CH13-HY)
Controller	EMEC	EM1000	N/A	Control Turn table & Ant Mast	N/A	Mar. 02, 2018~ Mar. 06, 2018	N/A	Radiation (03CH13-HY)
Antenna Mast	EMEC	AM-BS-4500-B	N/A	1m~4m	N/A	Mar. 02, 2018~ Mar. 06, 2018	N/A	Radiation (03CH13-HY)
Turn Table	EMEC	TT2000	N/A	0~360 Degree	N/A	Mar. 02, 2018~ Mar. 06, 2018	N/A	Radiation (03CH13-HY)
SHF-EHF Horn Antenna	SCHWARZBECK	BBHA 9170	BBHA9170251	18GHz- 40GHz	Nov. 10, 2017	Mar. 02, 2018~ Mar. 06, 2018	Nov. 09, 2018	Radiation (03CH13-HY)
SHF-EHF Horn Antenna	SCHWARZBECK	BBHA 9170	BBHA9170584	18GHz- 40GHz	Nov. 27, 2017	Mar. 02, 2018~ Mar. 06, 2018	Nov. 26, 2018	Radiation (03CH13-HY)
Horn Antenna	SCHWARZBECK	BBHA 9120 D	9120D-1522	1G~18GHz	Mar. 17, 2017	Mar. 02, 2018~ Mar. 06, 2018	Mar. 16, 2018	Radiation (03CH13-HY)
Signal Generator	Rohde & Schwarz	SMF100A	101107	100kHz~40GHz	May 22, 2017	Mar. 02, 2018~ Mar. 06, 2018	May 21, 2018	Radiation (03CH13-HY)



6 Uncertainty of Evaluation

Uncertainty of Radiated Emission Measurement (30 MHz ~ 1000 MHz)

Measuring Uncertainty for a Level of Confidence of 95% ($U = 2Uc(y)$)	3.07
---	------

Uncertainty of Radiated Emission Measurement (1 GHz ~ 18 GHz)

Measuring Uncertainty for a Level of Confidence of 95% ($U = 2Uc(y)$)	3.48
---	------

Uncertainty of Radiated Emission Measurement (18 GHz ~ 40 GHz)

Measuring Uncertainty for a Level of Confidence of 95% ($U = 2Uc(y)$)	3.92
---	------



Appendix A. Test Results of Conducted Test

Conducted Output Power(Average power)

Conducted Power (*Unit: dBm)						
Band	GSM850			GSM1900		
Channel	128	189	251	512	661	810
Frequency	824.2	836.4	848.8	1850.2	1880	1909.8
GSM	31.81	32.34	32.69	29.37	29.29	29.10
GPRS class 8	31.87	32.44	32.65	29.36	29.26	29.02
GPRS class 10	30.50	30.92	31.47	28.19	28.19	28.13
GPRS class 11	29.20	29.32	29.52	26.78	26.62	26.66
GPRS class 12	27.20	27.61	27.77	24.84	24.85	24.92
EGPRS class 8	25.70	25.92	26.10	25.52	25.23	25.23
EGPRS class 10	24.62	24.81	24.76	24.84	24.32	24.18
EGPRS class 11	22.84	22.99	23.05	22.62	22.69	22.55
EGPRS class 12	21.05	21.15	21.43	20.92	21.00	20.91

Conducted Power (*Unit: dBm)						
Band	WCDMA Band V			WCDMA Band II		
Channel	4132	4182	4233	9262	9400	9538
Frequency	826.4	836.4	846.6	1852.4	1880	1907.6
RMC 12.2K	22.59	22.44	22.48	22.62	22.67	22.67
HSDPA Subtest-1	21.33	21.25	21.23	21.20	21.11	21.21
HSDPA Subtest-2	21.29	21.18	21.22	21.13	21.12	21.15
HSDPA Subtest-3	21.30	21.22	21.22	21.14	21.13	21.18
HSDPA Subtest-4	21.38	21.23	21.19	21.23	21.06	21.19
HSUPA Subtest-1	20.64	20.67	20.68	21.07	21.04	21.09
HSUPA Subtest-2	19.78	19.70	19.69	19.60	19.51	19.62
HSUPA Subtest-3	20.78	20.65	20.67	20.58	20.50	20.60
HSUPA Subtest-4	19.73	19.66	19.73	19.60	19.54	19.64
HSUPA Subtest-5	21.59	21.50	21.55	21.58	21.56	21.68



Conducted Power (*Unit: dBm)			
Band	WCDMA Band IV		
Channel	1312	1413	1513
Frequency	1712.4	1732.6	1752.6
RMC 12.2K	22.29	22.35	22.70
HSDPA Subtest-1	21.00	21.00	21.18
HSDPA Subtest-2	21.04	21.06	21.07
HSDPA Subtest-3	20.89	20.83	21.07
HSDPA Subtest-4	20.85	21.00	20.94
HSUPA Subtest-1	21.01	21.04	21.00
HSUPA Subtest-2	19.31	19.44	19.38
HSUPA Subtest-3	20.30	20.86	20.82
HSUPA Subtest-4	19.33	19.49	19.67
HSUPA Subtest-5	21.29	21.34	21.66



A2. GSM

Peak-to-Average Ratio

Mode	GSM850		Limit: 13dB
Mod.	GPRS class 8	EDGE class 8	Result
Lowest CH	0.56	3.24	PASS
Middle CH	0.48	3.24	
Highest CH	0.48	3.40	

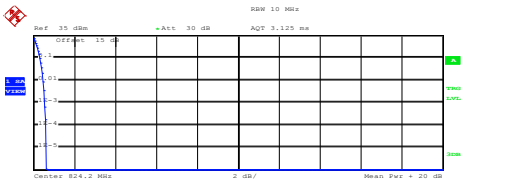
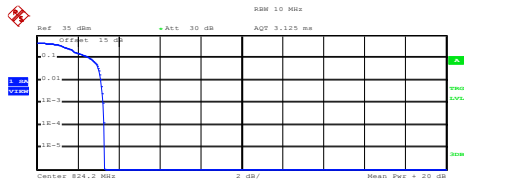
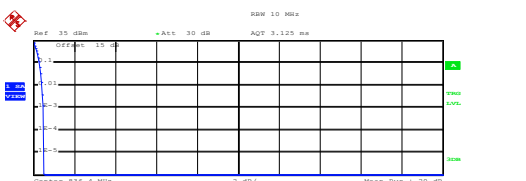
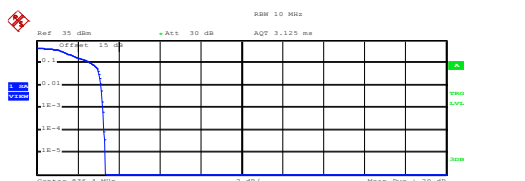
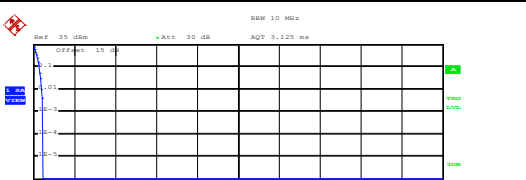
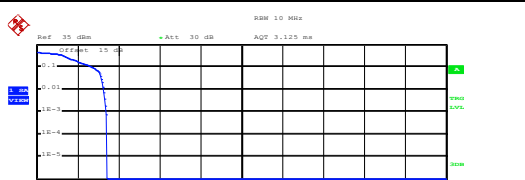

GSM850 (GPRS class 8)	GSM850 (EDGE class 8)																
<p style="text-align: center;">Lowest Channel</p>  <p>Center: 824.2 MHz 2 dB/ Mean Pwr = 20 dB</p> <p>Complementary Cumulative Distribution Function (100000 samples)</p> <p>Trace 1</p> <p>Mean 31.18 dBm Peak 31.80 dBm Crest 0.61 dB</p> <table border="1"> <tr><td>10 %</td><td>0.32 dB</td></tr> <tr><td>1 %</td><td>0.48 dB</td></tr> <tr><td>.1 %</td><td>0.56 dB</td></tr> <tr><td>.01 %</td><td>0.60 dB</td></tr> </table> <p>Date: 7.MAR.2018 17:59:20</p>	10 %	0.32 dB	1 %	0.48 dB	.1 %	0.56 dB	.01 %	0.60 dB	<p style="text-align: center;">Lowest Channel</p>  <p>Center: 824.2 MHz 2 dB/ Mean Pwr = 20 dB</p> <p>Complementary Cumulative Distribution Function (100000 samples)</p> <p>Trace 1</p> <p>Mean 25.48 dBm Peak 28.76 dBm Crest 3.28 dB</p> <table border="1"> <tr><td>10 %</td><td>2.56 dB</td></tr> <tr><td>1 %</td><td>3.12 dB</td></tr> <tr><td>.1 %</td><td>3.24 dB</td></tr> <tr><td>.01 %</td><td>3.28 dB</td></tr> </table> <p>Date: 7.MAR.2018 17:47:11</p>	10 %	2.56 dB	1 %	3.12 dB	.1 %	3.24 dB	.01 %	3.28 dB
10 %	0.32 dB																
1 %	0.48 dB																
.1 %	0.56 dB																
.01 %	0.60 dB																
10 %	2.56 dB																
1 %	3.12 dB																
.1 %	3.24 dB																
.01 %	3.28 dB																
<p style="text-align: center;">Middle Channel</p>  <p>Center: 836.4 MHz 2 dB/ Mean Pwr = 20 dB</p> <p>Complementary Cumulative Distribution Function (100000 samples)</p> <p>Trace 1</p> <p>Mean 31.00 dBm Peak 31.51 dBm Crest 0.52 dB</p> <table border="1"> <tr><td>10 %</td><td>0.28 dB</td></tr> <tr><td>1 %</td><td>0.40 dB</td></tr> <tr><td>.1 %</td><td>0.48 dB</td></tr> <tr><td>.01 %</td><td>0.52 dB</td></tr> </table> <p>Date: 7.MAR.2018 17:59:38</p>	10 %	0.28 dB	1 %	0.40 dB	.1 %	0.48 dB	.01 %	0.52 dB	<p style="text-align: center;">Middle Channel</p>  <p>Center: 836.4 MHz 2 dB/ Mean Pwr = 20 dB</p> <p>Complementary Cumulative Distribution Function (100000 samples)</p> <p>Trace 1</p> <p>Mean 25.56 dBm Peak 28.90 dBm Crest 3.34 dB</p> <table border="1"> <tr><td>10 %</td><td>2.64 dB</td></tr> <tr><td>1 %</td><td>3.12 dB</td></tr> <tr><td>.1 %</td><td>3.24 dB</td></tr> <tr><td>.01 %</td><td>3.28 dB</td></tr> </table> <p>Date: 7.MAR.2018 17:47:32</p>	10 %	2.64 dB	1 %	3.12 dB	.1 %	3.24 dB	.01 %	3.28 dB
10 %	0.28 dB																
1 %	0.40 dB																
.1 %	0.48 dB																
.01 %	0.52 dB																
10 %	2.64 dB																
1 %	3.12 dB																
.1 %	3.24 dB																
.01 %	3.28 dB																
<p style="text-align: center;">Highest Channel</p>  <p>Center: 848.8 MHz 2 dB/ Mean Pwr = 20 dB</p> <p>Complementary Cumulative Distribution Function (100000 samples)</p> <p>Trace 1</p> <p>Mean 31.33 dBm Peak 31.80 dBm Crest 0.46 dB</p> <table border="1"> <tr><td>10 %</td><td>0.28 dB</td></tr> <tr><td>1 %</td><td>0.40 dB</td></tr> <tr><td>.1 %</td><td>0.48 dB</td></tr> <tr><td>.01 %</td><td>0.48 dB</td></tr> </table> <p>Date: 7.MAR.2018 17:59:55</p>	10 %	0.28 dB	1 %	0.40 dB	.1 %	0.48 dB	.01 %	0.48 dB	<p style="text-align: center;">Highest Channel</p>  <p>Center: 848.8 MHz 2 dB/ Mean Pwr = 20 dB</p> <p>Complementary Cumulative Distribution Function (100000 samples)</p> <p>Trace 1</p> <p>Mean 25.62 dBm Peak 29.05 dBm Crest 3.43 dB</p> <table border="1"> <tr><td>10 %</td><td>2.72 dB</td></tr> <tr><td>1 %</td><td>3.28 dB</td></tr> <tr><td>.1 %</td><td>3.40 dB</td></tr> <tr><td>.01 %</td><td>3.44 dB</td></tr> </table> <p>Date: 7.MAR.2018 17:47:52</p>	10 %	2.72 dB	1 %	3.28 dB	.1 %	3.40 dB	.01 %	3.44 dB
10 %	0.28 dB																
1 %	0.40 dB																
.1 %	0.48 dB																
.01 %	0.48 dB																
10 %	2.72 dB																
1 %	3.28 dB																
.1 %	3.40 dB																
.01 %	3.44 dB																



26dB Bandwidth

Mode	GSM850	
Mod.	GPRS class 8	EDGE class 8
Lowest CH	0.303	0.300
Middle CH	0.307	0.301
Highest CH	0.311	0.297



GSM850 (GPRS class 8)	GSM850 (EDGE class 8)
Lowest Channel	Lowest Channel
<p>Ref: 35 dBm, Att: 30 dB, BW: 3 kHz, VSW: 10 kHz, SWT: 115 ms, Marker 1 [F1]: 23.74 dBm, 824.23800000 MHz</p> <p>Off: 15 dB, Att: 15 dB, BW: 3 kHz, VSW: 10 kHz, SWT: 115 ms, Marker 1 [F1]: -23.74 dBm, 824.23800000 MHz</p> <p>Temp 1 [F1 not]: -23.74 dBm, 824.23800000 MHz</p> <p>Temp 2 [F1 not]: -23.74 dBm, 824.23800000 MHz</p> <p>Center: 824.2 MHz, 100 kHz, Span: 1 MHz</p> <p>Date: 7.MAR.2018 17:50:07</p>	<p>Ref: 35 dBm, Att: 30 dB, BW: 3 kHz, VSW: 10 kHz, SWT: 115 ms, Marker 1 [F1]: 18.06 dBm, 824.25800000 MHz</p> <p>Off: 15 dB, Att: 15 dB, BW: 3 kHz, VSW: 10 kHz, SWT: 115 ms, Marker 1 [F1]: -18.06 dBm, 824.25800000 MHz</p> <p>Temp 1 [F1 not]: -18.06 dBm, 824.25800000 MHz</p> <p>Temp 2 [F1 not]: -18.06 dBm, 824.25800000 MHz</p> <p>Center: 824.2 MHz, 100 kHz, Span: 1 MHz</p> <p>Date: 7.MAR.2018 17:33:12</p>
Middle Channel	Middle Channel
<p>Ref: 35 dBm, Att: 30 dB, BW: 3 kHz, VSW: 10 kHz, SWT: 115 ms, Marker 1 [F1]: 23.74 dBm, 836.41800000 MHz</p> <p>Off: 15 dB, Att: 15 dB, BW: 3 kHz, VSW: 10 kHz, SWT: 115 ms, Marker 1 [F1]: -23.74 dBm, 836.41800000 MHz</p> <p>Temp 1 [F1 not]: -23.74 dBm, 836.41800000 MHz</p> <p>Temp 2 [F1 not]: -23.74 dBm, 836.41800000 MHz</p> <p>Center: 836.4 MHz, 100 kHz, Span: 1 MHz</p> <p>Date: 7.MAR.2018 17:51:01</p>	<p>Ref: 35 dBm, Att: 30 dB, BW: 3 kHz, VSW: 10 kHz, SWT: 115 ms, Marker 1 [F1]: 17.41 dBm, 836.37700000 MHz</p> <p>Off: 15 dB, Att: 15 dB, BW: 3 kHz, VSW: 10 kHz, SWT: 115 ms, Marker 1 [F1]: -17.41 dBm, 836.37700000 MHz</p> <p>Temp 1 [F1 not]: -17.41 dBm, 836.37700000 MHz</p> <p>Temp 2 [F1 not]: -17.41 dBm, 836.37700000 MHz</p> <p>Center: 836.4 MHz, 100 kHz, Span: 1 MHz</p> <p>Date: 7.MAR.2018 17:35:24</p>
Highest Channel	Highest Channel
<p>Ref: 35 dBm, Att: 30 dB, BW: 3 kHz, VSW: 10 kHz, SWT: 115 ms, Marker 1 [F1]: 24.06 dBm, 848.82100000 MHz</p> <p>Off: 15 dB, Att: 15 dB, BW: 3 kHz, VSW: 10 kHz, SWT: 115 ms, Marker 1 [F1]: -24.06 dBm, 848.82100000 MHz</p> <p>Temp 1 [F1 not]: -24.06 dBm, 848.82100000 MHz</p> <p>Temp 2 [F1 not]: -24.06 dBm, 848.82100000 MHz</p> <p>Center: 848.8 MHz, 100 kHz, Span: 1 MHz</p> <p>Date: 7.MAR.2018 17:51:36</p>	<p>Ref: 35 dBm, Att: 30 dB, BW: 3 kHz, VSW: 10 kHz, SWT: 115 ms, Marker 1 [F1]: 18.32 dBm, 848.80300000 MHz</p> <p>Off: 15 dB, Att: 15 dB, BW: 3 kHz, VSW: 10 kHz, SWT: 115 ms, Marker 1 [F1]: -18.32 dBm, 848.80300000 MHz</p> <p>Temp 1 [F1 not]: -18.32 dBm, 848.80300000 MHz</p> <p>Temp 2 [F1 not]: -18.32 dBm, 848.80300000 MHz</p> <p>Center: 848.8 MHz, 100 kHz, Span: 1 MHz</p> <p>Date: 7.MAR.2018 17:35:56</p>



Occupied Bandwidth

Mode	GSM850	
Mod.	GPRS class 8	EDGE class 8
Lowest CH	0.245	0.247
Middle CH	0.245	0.244
Highest CH	0.245	0.243



GSM850 (GPRS class 8)	GSM850 (EDGE class 8)
Lowest Channel	Lowest Channel
<p>Ref: 35 dBm, Att: 30 dB, RBW: 10 kHz, VSW: 30 kHz, SWT: 10 ms. Marker 1 [T1]: 28.75 dBm @ 824.23000000 MHz.</p> <p>Temp 1 [T1]: 11.75 dBm @ 824.07700000 MHz. Temp 2 [T2]: 12.84 dBm @ 824.07700000 MHz. Temp 3 [T3]: 14.37 dBm @ 824.07700000 MHz.</p> <p>Date: 7.MAR.2018 17:52:13</p>	<p>Ref: 35 dBm, Att: 30 dB, RBW: 10 kHz, VSW: 30 kHz, SWT: 10 ms. Marker 1 [T1]: 23.17 dBm @ 824.17700000 MHz.</p> <p>Temp 1 [T1]: 11.75 dBm @ 824.07700000 MHz. Temp 2 [T2]: 12.84 dBm @ 824.07700000 MHz. Temp 3 [T3]: 14.37 dBm @ 824.07700000 MHz.</p> <p>Date: 7.MAR.2018 17:36:34</p>
Middle Channel	Middle Channel
<p>Ref: 35 dBm, Att: 30 dB, RBW: 10 kHz, VSW: 30 kHz, SWT: 10 ms. Marker 1 [T1]: 28.95 dBm @ 836.38200000 MHz.</p> <p>Temp 1 [T1]: 11.91 dBm @ 836.07700000 MHz. Temp 2 [T2]: 13.71 dBm @ 836.07700000 MHz.</p> <p>Date: 7.MAR.2018 17:52:46</p>	<p>Ref: 35 dBm, Att: 30 dB, RBW: 10 kHz, VSW: 30 kHz, SWT: 10 ms. Marker 1 [T1]: 22.35 dBm @ 836.40700000 MHz.</p> <p>Temp 1 [T1]: 8.56 dBm @ 836.07700000 MHz. Temp 2 [T2]: 7.82 dBm @ 836.07700000 MHz.</p> <p>Date: 7.MAR.2018 17:37:06</p>
Highest Channel	Highest Channel
<p>Ref: 35 dBm, Att: 30 dB, RBW: 10 kHz, VSW: 30 kHz, SWT: 10 ms. Marker 1 [T1]: 28.02 dBm @ 848.80900000 MHz.</p> <p>Temp 1 [T1]: 14.26 dBm @ 848.07700000 MHz. Temp 2 [T2]: 12.84 dBm @ 848.07700000 MHz.</p> <p>Date: 7.MAR.2018 17:53:18</p>	<p>Ref: 35 dBm, Att: 30 dB, RBW: 10 kHz, VSW: 30 kHz, SWT: 10 ms. Marker 1 [T1]: 22.36 dBm @ 848.81600000 MHz.</p> <p>Temp 1 [T1]: 8.21 dBm @ 848.07700000 MHz. Temp 2 [T2]: 7.25 dBm @ 848.07700000 MHz.</p> <p>Date: 7.MAR.2018 17:37:39</p>



Conducted Band Edge

GSM850 (GPRS class 8)

Lowest Band Edge

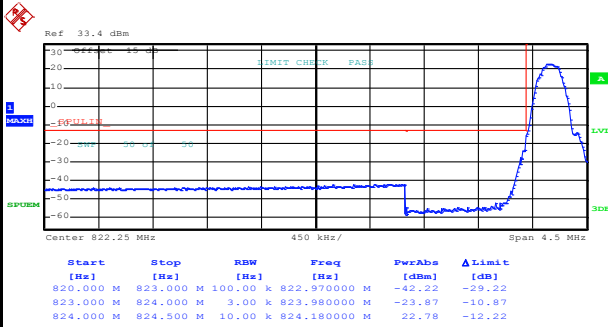

Date: 7.MAR.2018 17:54:52

Highest Band Edge

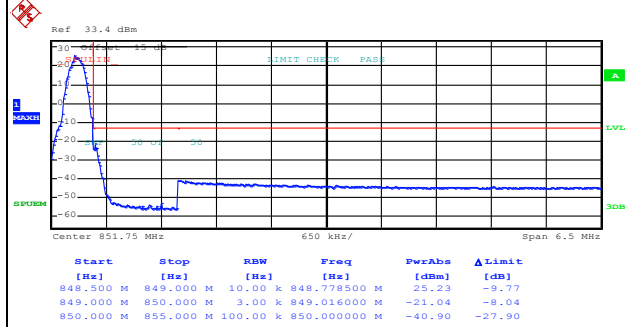

Date: 7.MAR.2018 17:56:24

GSM850 (EDGE class 8)

Lowest Band Edge

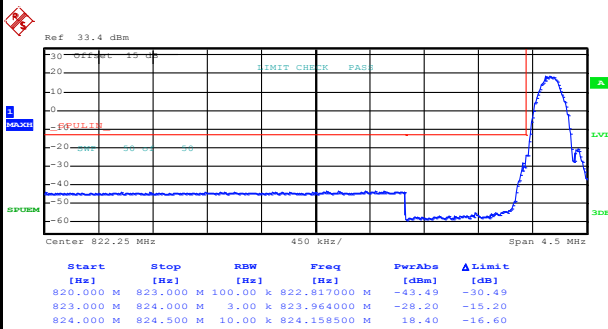

Date: 7.MAR.2018 17:42:40

Highest Band Edge

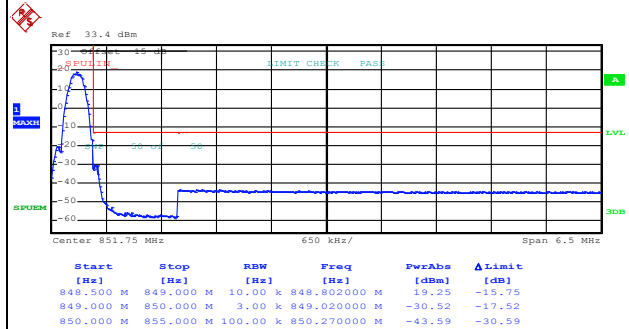

Date: 7.MAR.2018 17:44:15

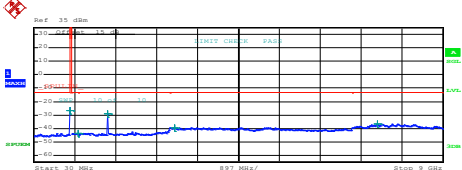
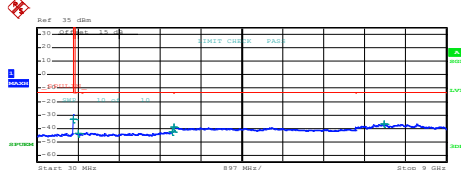
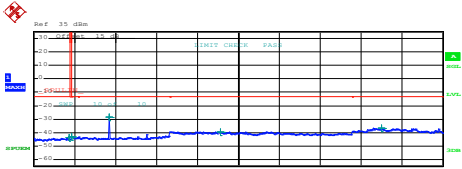
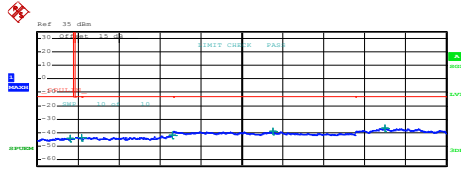
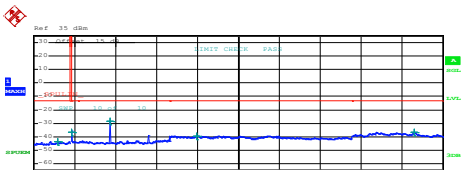
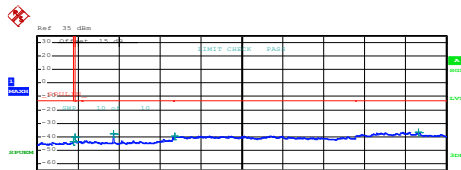

Conducted Spurious Emission

GSM850 (GPRS class 8)	GSM850 (EDGE class 8)																																																																																				
Lowest Channel	Lowest Channel																																																																																				
 <table border="1" data-bbox="239 660 654 739"> <thead> <tr> <th>Start</th> <th>Stop</th> <th>RW</th> <th>Freq</th> <th>PwrAbs</th> <th>ΔLimit</th> </tr> <tr> <th>[Hz]</th> <th>[Hz]</th> <th>[Hz]</th> <th>[Hz]</th> <th>[dBm]</th> <th>[dB]</th> </tr> </thead> <tbody> <tr> <td>30.000 M</td> <td>820.000 M</td> <td>1.00 M</td> <td>819.802500 M</td> <td>-26.97</td> <td>-33.97</td> </tr> <tr> <td>855.000 M</td> <td>1.000 G</td> <td>1.00 M</td> <td>993.185010 M</td> <td>-43.44</td> <td>-30.44</td> </tr> <tr> <td>1.000 G</td> <td>3.000 G</td> <td>1.00 M</td> <td>1.1648000 G</td> <td>-29.26</td> <td>-26.26</td> </tr> <tr> <td>3.000 G</td> <td>7.000 G</td> <td>1.00 M</td> <td>3.114000 G</td> <td>-39.35</td> <td>-26.35</td> </tr> <tr> <td>7.000 G</td> <td>9.000 G</td> <td>1.00 M</td> <td>7.588500 G</td> <td>-36.82</td> <td>-23.82</td> </tr> </tbody> </table> <p>Date: 7.MAR.2018 17:57:18</p>	Start	Stop	RW	Freq	PwrAbs	ΔLimit	[Hz]	[Hz]	[Hz]	[Hz]	[dBm]	[dB]	30.000 M	820.000 M	1.00 M	819.802500 M	-26.97	-33.97	855.000 M	1.000 G	1.00 M	993.185010 M	-43.44	-30.44	1.000 G	3.000 G	1.00 M	1.1648000 G	-29.26	-26.26	3.000 G	7.000 G	1.00 M	3.114000 G	-39.35	-26.35	7.000 G	9.000 G	1.00 M	7.588500 G	-36.82	-23.82	 <table border="1" data-bbox="885 660 1300 739"> <thead> <tr> <th>Start</th> <th>Stop</th> <th>RW</th> <th>Freq</th> <th>PwrAbs</th> <th>ΔLimit</th> </tr> <tr> <th>[Hz]</th> <th>[Hz]</th> <th>[Hz]</th> <th>[Hz]</th> <th>[dBm]</th> <th>[dB]</th> </tr> </thead> <tbody> <tr> <td>30.000 M</td> <td>820.000 M</td> <td>1.00 M</td> <td>819.605000 M</td> <td>-33.06</td> <td>-30.06</td> </tr> <tr> <td>855.000 M</td> <td>1.000 G</td> <td>1.00 M</td> <td>922.570005 M</td> <td>-43.39</td> <td>-30.39</td> </tr> <tr> <td>1.000 G</td> <td>3.000 G</td> <td>1.00 M</td> <td>2.999000 G</td> <td>-42.25</td> <td>-29.25</td> </tr> <tr> <td>3.000 G</td> <td>7.000 G</td> <td>1.00 M</td> <td>3.024000 G</td> <td>-39.04</td> <td>-26.04</td> </tr> <tr> <td>7.000 G</td> <td>9.000 G</td> <td>1.00 M</td> <td>7.633000 G</td> <td>-36.73</td> <td>-23.73</td> </tr> </tbody> </table> <p>Date: 7.MAR.2018 17:45:10</p>	Start	Stop	RW	Freq	PwrAbs	ΔLimit	[Hz]	[Hz]	[Hz]	[Hz]	[dBm]	[dB]	30.000 M	820.000 M	1.00 M	819.605000 M	-33.06	-30.06	855.000 M	1.000 G	1.00 M	922.570005 M	-43.39	-30.39	1.000 G	3.000 G	1.00 M	2.999000 G	-42.25	-29.25	3.000 G	7.000 G	1.00 M	3.024000 G	-39.04	-26.04	7.000 G	9.000 G	1.00 M	7.633000 G	-36.73	-23.73
Start	Stop	RW	Freq	PwrAbs	ΔLimit																																																																																
[Hz]	[Hz]	[Hz]	[Hz]	[dBm]	[dB]																																																																																
30.000 M	820.000 M	1.00 M	819.802500 M	-26.97	-33.97																																																																																
855.000 M	1.000 G	1.00 M	993.185010 M	-43.44	-30.44																																																																																
1.000 G	3.000 G	1.00 M	1.1648000 G	-29.26	-26.26																																																																																
3.000 G	7.000 G	1.00 M	3.114000 G	-39.35	-26.35																																																																																
7.000 G	9.000 G	1.00 M	7.588500 G	-36.82	-23.82																																																																																
Start	Stop	RW	Freq	PwrAbs	ΔLimit																																																																																
[Hz]	[Hz]	[Hz]	[Hz]	[dBm]	[dB]																																																																																
30.000 M	820.000 M	1.00 M	819.605000 M	-33.06	-30.06																																																																																
855.000 M	1.000 G	1.00 M	922.570005 M	-43.39	-30.39																																																																																
1.000 G	3.000 G	1.00 M	2.999000 G	-42.25	-29.25																																																																																
3.000 G	7.000 G	1.00 M	3.024000 G	-39.04	-26.04																																																																																
7.000 G	9.000 G	1.00 M	7.633000 G	-36.73	-23.73																																																																																
Middle Channel	Middle Channel																																																																																				
 <table border="1" data-bbox="239 1176 654 1254"> <thead> <tr> <th>Start</th> <th>Stop</th> <th>RW</th> <th>Freq</th> <th>PwrAbs</th> <th>ΔLimit</th> </tr> <tr> <th>[Hz]</th> <th>[Hz]</th> <th>[Hz]</th> <th>[Hz]</th> <th>[dBm]</th> <th>[dB]</th> </tr> </thead> <tbody> <tr> <td>30.000 M</td> <td>820.000 M</td> <td>1.00 M</td> <td>806.767500 M</td> <td>-43.45</td> <td>-30.45</td> </tr> <tr> <td>855.000 M</td> <td>1.000 G</td> <td>1.00 M</td> <td>860.800000 M</td> <td>-43.23</td> <td>-30.23</td> </tr> <tr> <td>1.000 G</td> <td>3.000 G</td> <td>1.00 M</td> <td>1.473000 G</td> <td>-28.68</td> <td>-15.68</td> </tr> <tr> <td>3.000 G</td> <td>7.000 G</td> <td>1.00 M</td> <td>4.112000 G</td> <td>-39.35</td> <td>-26.35</td> </tr> <tr> <td>7.000 G</td> <td>9.000 G</td> <td>1.00 M</td> <td>7.660500 G</td> <td>-36.78</td> <td>-23.78</td> </tr> </tbody> </table> <p>Date: 7.MAR.2018 17:58:10</p>	Start	Stop	RW	Freq	PwrAbs	ΔLimit	[Hz]	[Hz]	[Hz]	[Hz]	[dBm]	[dB]	30.000 M	820.000 M	1.00 M	806.767500 M	-43.45	-30.45	855.000 M	1.000 G	1.00 M	860.800000 M	-43.23	-30.23	1.000 G	3.000 G	1.00 M	1.473000 G	-28.68	-15.68	3.000 G	7.000 G	1.00 M	4.112000 G	-39.35	-26.35	7.000 G	9.000 G	1.00 M	7.660500 G	-36.78	-23.78	 <table border="1" data-bbox="885 1176 1300 1254"> <thead> <tr> <th>Start</th> <th>Stop</th> <th>RW</th> <th>Freq</th> <th>PwrAbs</th> <th>ΔLimit</th> </tr> <tr> <th>[Hz]</th> <th>[Hz]</th> <th>[Hz]</th> <th>[Hz]</th> <th>[dBm]</th> <th>[dB]</th> </tr> </thead> <tbody> <tr> <td>30.000 M</td> <td>820.000 M</td> <td>1.00 M</td> <td>749.740000 M</td> <td>-43.98</td> <td>-30.98</td> </tr> <tr> <td>855.000 M</td> <td>1.000 G</td> <td>1.00 M</td> <td>939.603200 M</td> <td>-43.44</td> <td>-30.44</td> </tr> <tr> <td>1.000 G</td> <td>3.000 G</td> <td>1.00 M</td> <td>2.991000 G</td> <td>-42.04</td> <td>-29.04</td> </tr> <tr> <td>3.000 G</td> <td>7.000 G</td> <td>1.00 M</td> <td>3.197000 G</td> <td>-39.24</td> <td>-26.24</td> </tr> <tr> <td>7.000 G</td> <td>9.000 G</td> <td>1.00 M</td> <td>7.650500 G</td> <td>-36.64</td> <td>-23.64</td> </tr> </tbody> </table> <p>Date: 7.MAR.2018 17:46:02</p>	Start	Stop	RW	Freq	PwrAbs	ΔLimit	[Hz]	[Hz]	[Hz]	[Hz]	[dBm]	[dB]	30.000 M	820.000 M	1.00 M	749.740000 M	-43.98	-30.98	855.000 M	1.000 G	1.00 M	939.603200 M	-43.44	-30.44	1.000 G	3.000 G	1.00 M	2.991000 G	-42.04	-29.04	3.000 G	7.000 G	1.00 M	3.197000 G	-39.24	-26.24	7.000 G	9.000 G	1.00 M	7.650500 G	-36.64	-23.64
Start	Stop	RW	Freq	PwrAbs	ΔLimit																																																																																
[Hz]	[Hz]	[Hz]	[Hz]	[dBm]	[dB]																																																																																
30.000 M	820.000 M	1.00 M	806.767500 M	-43.45	-30.45																																																																																
855.000 M	1.000 G	1.00 M	860.800000 M	-43.23	-30.23																																																																																
1.000 G	3.000 G	1.00 M	1.473000 G	-28.68	-15.68																																																																																
3.000 G	7.000 G	1.00 M	4.112000 G	-39.35	-26.35																																																																																
7.000 G	9.000 G	1.00 M	7.660500 G	-36.78	-23.78																																																																																
Start	Stop	RW	Freq	PwrAbs	ΔLimit																																																																																
[Hz]	[Hz]	[Hz]	[Hz]	[dBm]	[dB]																																																																																
30.000 M	820.000 M	1.00 M	749.740000 M	-43.98	-30.98																																																																																
855.000 M	1.000 G	1.00 M	939.603200 M	-43.44	-30.44																																																																																
1.000 G	3.000 G	1.00 M	2.991000 G	-42.04	-29.04																																																																																
3.000 G	7.000 G	1.00 M	3.197000 G	-39.24	-26.24																																																																																
7.000 G	9.000 G	1.00 M	7.650500 G	-36.64	-23.64																																																																																
Highest Channel	Highest Channel																																																																																				
 <table border="1" data-bbox="239 1691 654 1769"> <thead> <tr> <th>Start</th> <th>Stop</th> <th>RW</th> <th>Freq</th> <th>PwrAbs</th> <th>ΔLimit</th> </tr> <tr> <th>[Hz]</th> <th>[Hz]</th> <th>[Hz]</th> <th>[Hz]</th> <th>[dBm]</th> <th>[dB]</th> </tr> </thead> <tbody> <tr> <td>30.000 M</td> <td>820.000 M</td> <td>1.00 M</td> <td>541.302500 M</td> <td>-43.48</td> <td>-30.48</td> </tr> <tr> <td>855.000 M</td> <td>1.000 G</td> <td>1.00 M</td> <td>855.036250 M</td> <td>-36.66</td> <td>-23.66</td> </tr> <tr> <td>1.000 G</td> <td>3.000 G</td> <td>1.00 M</td> <td>1.697000 G</td> <td>-28.49</td> <td>-15.49</td> </tr> <tr> <td>3.000 G</td> <td>7.000 G</td> <td>1.00 M</td> <td>3.593000 G</td> <td>-39.31</td> <td>-26.31</td> </tr> <tr> <td>7.000 G</td> <td>9.000 G</td> <td>1.00 M</td> <td>8.369000 G</td> <td>-36.78</td> <td>-23.78</td> </tr> </tbody> </table> <p>Date: 7.MAR.2018 17:59:00</p>	Start	Stop	RW	Freq	PwrAbs	ΔLimit	[Hz]	[Hz]	[Hz]	[Hz]	[dBm]	[dB]	30.000 M	820.000 M	1.00 M	541.302500 M	-43.48	-30.48	855.000 M	1.000 G	1.00 M	855.036250 M	-36.66	-23.66	1.000 G	3.000 G	1.00 M	1.697000 G	-28.49	-15.49	3.000 G	7.000 G	1.00 M	3.593000 G	-39.31	-26.31	7.000 G	9.000 G	1.00 M	8.369000 G	-36.78	-23.78	 <table border="1" data-bbox="885 1691 1300 1769"> <thead> <tr> <th>Start</th> <th>Stop</th> <th>RW</th> <th>Freq</th> <th>PwrAbs</th> <th>ΔLimit</th> </tr> <tr> <th>[Hz]</th> <th>[Hz]</th> <th>[Hz]</th> <th>[Hz]</th> <th>[dBm]</th> <th>[dB]</th> </tr> </thead> <tbody> <tr> <td>30.000 M</td> <td>820.000 M</td> <td>1.00 M</td> <td>818.025000 M</td> <td>-43.48</td> <td>-30.48</td> </tr> <tr> <td>855.000 M</td> <td>1.000 G</td> <td>1.00 M</td> <td>855.036250 M</td> <td>-40.02</td> <td>-27.02</td> </tr> <tr> <td>1.000 G</td> <td>3.000 G</td> <td>1.00 M</td> <td>1.697000 G</td> <td>-27.97</td> <td>-14.97</td> </tr> <tr> <td>3.000 G</td> <td>7.000 G</td> <td>1.00 M</td> <td>3.038000 G</td> <td>-39.36</td> <td>-26.36</td> </tr> <tr> <td>7.000 G</td> <td>9.000 G</td> <td>1.00 M</td> <td>8.389000 G</td> <td>-36.56</td> <td>-23.56</td> </tr> </tbody> </table> <p>Date: 7.MAR.2018 17:46:52</p>	Start	Stop	RW	Freq	PwrAbs	ΔLimit	[Hz]	[Hz]	[Hz]	[Hz]	[dBm]	[dB]	30.000 M	820.000 M	1.00 M	818.025000 M	-43.48	-30.48	855.000 M	1.000 G	1.00 M	855.036250 M	-40.02	-27.02	1.000 G	3.000 G	1.00 M	1.697000 G	-27.97	-14.97	3.000 G	7.000 G	1.00 M	3.038000 G	-39.36	-26.36	7.000 G	9.000 G	1.00 M	8.389000 G	-36.56	-23.56
Start	Stop	RW	Freq	PwrAbs	ΔLimit																																																																																
[Hz]	[Hz]	[Hz]	[Hz]	[dBm]	[dB]																																																																																
30.000 M	820.000 M	1.00 M	541.302500 M	-43.48	-30.48																																																																																
855.000 M	1.000 G	1.00 M	855.036250 M	-36.66	-23.66																																																																																
1.000 G	3.000 G	1.00 M	1.697000 G	-28.49	-15.49																																																																																
3.000 G	7.000 G	1.00 M	3.593000 G	-39.31	-26.31																																																																																
7.000 G	9.000 G	1.00 M	8.369000 G	-36.78	-23.78																																																																																
Start	Stop	RW	Freq	PwrAbs	ΔLimit																																																																																
[Hz]	[Hz]	[Hz]	[Hz]	[dBm]	[dB]																																																																																
30.000 M	820.000 M	1.00 M	818.025000 M	-43.48	-30.48																																																																																
855.000 M	1.000 G	1.00 M	855.036250 M	-40.02	-27.02																																																																																
1.000 G	3.000 G	1.00 M	1.697000 G	-27.97	-14.97																																																																																
3.000 G	7.000 G	1.00 M	3.038000 G	-39.36	-26.36																																																																																
7.000 G	9.000 G	1.00 M	8.389000 G	-36.56	-23.56																																																																																



Frequency Stability

Test Conditions	Middle Channel	GSM850 (GPRS class 8)	GSM850 (EDGE class 8)	Limit 2.5ppm
Temperature (°C)	Voltage (Volt)	Deviation (ppm)		Result
50	Normal Voltage	0.0048	0.0096	PASS
40	Normal Voltage	0.0024	0.0060	
30	Normal Voltage	0.0060	0.0048	
20(Ref.)	Normal Voltage	0.0000	0.0000	
10	Normal Voltage	0.0036	0.0012	
0	Normal Voltage	0.0072	0.0012	
-10	Normal Voltage	0.0072	0.0036	
-20	Normal Voltage	0.0108	0.0060	
-30	Normal Voltage	0.0120	0.0048	
20	Maximum Voltage	0.0012	0.0048	
20	Normal Voltage	0.0000	0.0000	
20	Battery End Point	0.0024	0.0012	

Note:

- 1. Normal Voltage = 3.8 V. ; Battery End Point (BEP) = 3.6 V. ; Maximum Voltage =4.4 V
- 2. The frequency fundamental emissions stay within the authorized frequency block



Appendix B. Test Results of ERP/EIRP and Radiated Test

ERP/EIRP

Channel	Mode	Conducted		ERP	
		Power (dBm)	Power (Watts)	ERP(dBm)	ERP(W)
Lowest	GSM850 GSM (GT - LC = -5.6 dB)	31.81	1.5171	24.06	0.2547
Middle		32.34	1.7140	24.59	0.2877
Highest		32.69	1.8578	24.94	0.3119
Lowest	GSM850 EDGE class 8 (GT - LC = -5.6 dB)	25.70	0.3715	17.95	0.0624
Middle		25.92	0.3908	18.17	0.0656
Highest		26.10	0.4074	18.35	0.0684
Lowest	WCDMA Band V RMC 12.2Kbps (GT - LC = -5.6 dB)	22.59	0.1816	14.84	0.0305
Middle		22.44	0.1754	14.69	0.0294
Highest		22.48	0.1770	14.73	0.0297
Limit	ERP < 7W	Result		PASS	

Channel	Mode	Conducted		EIRP	
		Power (dBm)	Power (Watts)	EIRP(dBm)	EIRP(W)
Lowest	GSM1900 GSM (GT - LC = -2.1 dB)	29.37	0.8650	27.27	0.5333
Middle		29.29	0.8492	27.19	0.5236
Highest		29.10	0.8128	27.00	0.5012
Lowest	GSM1900 EDGE class 8 (GT - LC = -2.1 dB)	25.52	0.3565	23.42	0.2198
Middle		25.23	0.3334	23.13	0.2056
Highest		25.23	0.3334	23.13	0.2056
Lowest	WCDMA Band II RMC 12.2Kbps (GT - LC = -2.1 dB)	22.62	0.1828	20.52	0.1127
Middle		22.67	0.1849	20.57	0.1140
Highest		22.67	0.1849	20.57	0.1140
Limit	EIRP < 2W	Result		PASS	

Channel	Mode	Conducted		EIRP	
		Power (dBm)	Power (Watts)	EIRP(dBm)	EIRP(W)
Lowest	WCDMA Band IV RMC 12.2Kbps (GT - LC = -2 dB)	22.29	0.1694	20.29	0.1069
Middle		22.35	0.1718	20.35	0.1084
Highest		22.70	0.1862	20.70	0.1175
Limit	EIRP < 1W	Result		PASS	



Radiated Spurious Emission

Part22H GPRS850

WCDMA 1900									
Channel	Frequency (MHz)	EIRP (dBm)	Limit (dBm)	Over Limit (dB)	SPA Reading (dBm)	S.G. Power (dBm)	TX Cable loss (dB)	TX Antenna Gain (dBi)	Polarization (H/V)
Lowest	1648	-42.60	-13	-29.60	-57.21	-47.99	1.23	8.76	H
	2472	-57.79	-13	-44.79	-75.51	-64.68	1.44	10.48	H
	3296	-55.15	-13	-42.15	-76.18	-63.09	1.70	11.79	H
									H
									H
									H
	1648	-48.14	-13	-35.14	-62.75	-53.53	1.23	8.76	V
	2472	-58.12	-13	-45.12	-75.84	-65.01	1.44	10.48	V
	3296	-55.71	-13	-42.71	-76.74	-63.65	1.70	11.79	V
									V
									V
									V
Middle	1672	-41.93	-13	-28.93	-56.61	-47.40	1.24	8.85	H
	2508	-58.10	-13	-45.10	-75.99	-65.02	1.44	10.51	H
	3344	-55.26	-13	-42.26	-76.42	-63.30	1.74	11.93	H
									H
									H
									H
	1672	-48.32	-13	-35.32	-63	-53.79	1.24	8.85	V
	2508	-58.17	-13	-45.17	-76.06	-65.09	1.44	10.51	V
	3344	-55.23	-13	-42.23	-76.39	-63.27	1.74	11.93	V
									V
									V
									V



Highest	1696	-42.82	-13	-29.82	-57.56	-48.37	1.24	8.94	H
	2544	-58.06	-13	-45.06	-76.11	-65.00	1.44	10.54	H
	4248	-53.41	-13	-40.41	-76.69	-61.31	2.05	12.10	H
									H
									H
									H
									H
	1696	-49.53	-13	-36.53	-64.27	-55.08	1.24	8.94	V
	2544	-58.09	-13	-45.09	-76.14	-65.03	1.44	10.54	V
	4248	-53.42	-13	-40.42	-76.7	-61.32	2.05	12.10	V
									V
									V
									V
									V

Remark: Spurious emissions within 30-1000MHz were found more than 20dB below limit line.



Part22H EDGE850

WCDMA 1900									
Channel	Frequency (MHz)	EIRP (dBm)	Limit (dBm)	Over Limit (dB)	SPA Reading (dBm)	S.G. Power (dBm)	TX Cable loss (dB)	TX Antenna Gain (dBi)	Polarization (H/V)
Lowest	1648	-46.10	-13	-33.10	-60.71	-51.49	1.23	8.76	H
	2472	-58.28	-13	-45.28	-76	-65.17	1.44	10.48	H
	3296	-54.79	-13	-41.79	-75.82	-62.73	1.70	11.79	H
									H
									H
									H
									H
	1648	-47.75	-13	-34.75	-62.36	-53.14	1.23	8.76	V
	2472	-58.21	-13	-45.21	-75.93	-65.10	1.44	10.48	V
	3296	-55.45	-13	-42.45	-76.48	-63.39	1.70	11.79	V
									V
									V
									V
									V
Middle	1672	-44.75	-13	-31.75	-59.43	-50.22	1.24	8.85	H
	2512	-58.09	-13	-45.09	-75.98	-65.01	1.44	10.51	H
	3344	-55.53	-13	-42.53	-76.69	-63.57	1.74	11.93	H
									H
									H
									H
									H
	1672	-49.42	-13	-36.42	-64.1	-54.89	1.24	8.85	V
	2512	-58.13	-13	-45.13	-76.02	-65.05	1.44	10.51	V
	3344	-55.10	-13	-42.10	-76.26	-63.14	1.74	11.93	V
									V
									V
									V
									V



Highest	1696	-46.14	-13	-33.14	-60.88	-51.69	1.24	8.94	H
	2544	-88.02	-13	-75.02	-76.07	-94.96	1.44	10.54	H
	3392	-55.04	-13	-42.04	-76.34	-63.18	1.78	12.08	H
									H
									H
									H
									H
	1696	-48.21	-13	-35.21	-62.95	-53.76	1.24	8.94	V
	2544	-58.24	-13	-45.24	-76.29	-65.18	1.44	10.54	V
	3392	-55.15	-13	-42.15	-76.45	-63.29	1.78	12.08	V
									V
									V
									V
									V

Remark: Spurious emissions within 30-1000MHz were found more than 20dB below limit line.



Part22H WCDMA850

WCDMA 1900									
Channel	Frequency (MHz)	EIRP (dBm)	Limit (dBm)	Over Limit (dB)	SPA Reading (dBm)	S.G. Power (dBm)	TX Cable loss (dB)	TX Antenna Gain (dBi)	Polarization (H/V)
Lowest	1652	-60.67	-13	-47.67	-75.31	-66.07	1.23	8.78	H
	2480	-57.81	-13	-44.81	-75.53	-64.71	1.44	10.48	H
	3306	-55.37	-13	-42.37	-76.44	-63.33	1.71	11.82	H
									H
									H
									H
									H
	1652	-61.16	-13	-48.16	-75.8	-66.56	1.23	8.78	V
	2480	-58.08	-13	-45.08	-75.8	-64.98	1.44	10.48	V
	3306	-55.63	-13	-42.63	-76.7	-63.59	1.71	11.82	V
									V
									V
									V
									V
Middle	1672	-60.43	-13	-47.43	-75.11	-65.90	1.24	8.85	H
	2509	-57.52	-13	-44.52	-75.41	-64.44	1.44	10.51	H
	3346	-55.30	-13	-42.30	-76.46	-63.34	1.74	11.94	H
									H
									H
									H
									H
	1672	-60.55	-13	-47.55	-75.23	-66.02	1.24	8.85	V
	2509	-58.01	-13	-45.01	-75.9	-64.93	1.44	10.51	V
	3346	-54.93	-13	-41.93	-76.09	-62.97	1.74	11.94	V
									V
									V
									V
									V
								V	



Highest	1693	-60.90	-13	-47.90	-75.64	-66.44	1.24	8.93	H
	2540	-57.95	-13	-44.95	-76	-64.89	1.44	10.53	H
	3386	-55.35	-13	-42.35	-76.61	-63.48	1.78	12.06	H
									H
									H
									H
									H
	1693	-60.78	-13	-47.78	-75.52	-66.32	1.24	8.93	V
	2540	-58.12	-13	-45.12	-76.17	-65.06	1.44	10.53	V
	3386	-54.99	-13	-41.99	-76.25	-63.12	1.78	12.06	V
									V
									V
									V
									V

Remark: Spurious emissions within 30-1000MHz were found more than 20dB below limit line.



Part24E GPRS1900

WCDMA 1900									
Channel	Frequency (MHz)	EIRP (dBm)	Limit (dBm)	Over Limit (dB)	SPA Reading (dBm)	S.G. Power (dBm)	TX Cable loss (dB)	TX Antenna Gain (dBi)	Polarization (H/V)
Lowest	3700	-38.92	-13	-25.92	-60.78	-49.23	1.97	12.28	H
	5548	-33.66	-13	-20.66	-61.65	-43.78	2.14	12.27	H
	7400	-41.84	-13	-28.84	-76.34	-49.84	2.18	10.18	H
									H
									H
									H
									H
	3700	-40.08	-13	-27.08	-61.94	-50.39	1.97	12.28	V
	5548	-33.64	-13	-20.64	-61.63	-43.76	2.14	12.27	V
	7400	-41.80	-13	-28.80	-76.3	-49.80	2.18	10.18	V
									V
									V
									V
									V
Middle	3763	-36.16	-13	-23.16	-58.11	-46.40	2.01	12.24	H
	5639	-33.13	-13	-20.13	-6137	-43.40	2.12	12.39	H
	7518	-41.82	-13	-28.82	-76.54	-49.77	2.11	10.06	H
									H
									H
									H
									H
	3763	-41.88	-13	-28.88	-63.83	-52.12	2.01	12.24	V
	5639	-32.42	-13	-19.42	-60.66	-42.69	2.12	12.39	V
	7518	-42.03	-13	-29.03	-76.75	-49.98	2.11	10.06	V
									V
									V
									V
									V



Highest	3819	-40.23	-13	-27.23	-61.89	-50.40	2.04	12.21	H
	5730	-31.48	-13	-18.48	-59.99	-41.90	2.10	12.52	H
	7634	-41.21	-13	-28.21	-76.11	-49.58	2.11	10.48	H
									H
									H
									H
									H
	3819	-40.23	-13	-27.23	-62.25	-50.40	2.04	12.21	V
	5730	-32.71	-13	-19.71	-61.22	-43.13	2.10	12.52	V
	7634	-41.30	-13	-28.30	-76.2	-49.67	2.11	10.48	V
									V
									V
									V
									V

Remark: Spurious emissions within 30-1000MHz were found more than 20dB below limit line.



Part24E EDGE1900

WCDMA 1900									
Channel	Frequency (MHz)	EIRP (dBm)	Limit (dBm)	Over Limit (dB)	SPA Reading (dBm)	S.G. Power (dBm)	TX Cable loss (dB)	TX Antenna Gain (dBi)	Polarization (H/V)
Lowest	3700	-47.25	-13	-34.25	-69.11	-57.56	1.97	12.28	H
	5548	-46.15	-13	-33.15	-74.14	-56.27	2.14	12.27	H
	7400	-41.93	-13	-28.93	-76.47	-49.93	2.18	10.18	H
									H
									H
									H
									H
	3700	-51.02	-13	-38.02	-72.88	-61.33	1.97	12.28	V
	5550	-48.94	-13	-35.94	-76.93	-59.07	2.14	12.27	V
	7400	-41.71	-13	-28.71	-76.25	-49.71	2.18	10.18	V
									V
									V
									V
									V
Middle	3763	-47.63	-13	-34.63	-69.58	-57.87	2.01	12.24	H
	5639	-48.28	-13	-35.28	-76.52	-58.55	2.12	12.39	H
	7520	-41.83	-13	-28.83	-76.58	-49.79	2.11	10.07	H
									H
									H
									H
									H
	3763	-47.24	-13	-34.24	-69.19	-57.48	2.01	12.24	V
	5639	-47.35	-13	-34.35	-75.59	-57.62	2.12	12.39	V
	7520	-41.40	-13	-28.40	-76.15	-49.36	2.11	10.07	V
									V
									V
									V
									V



Highest	3819	-48.71	-13	-35.71	-70.73	-58.88	2.04	12.21	H
	5730	-46.98	-13	-33.98	-75.49	-57.40	2.10	12.52	H
	7639	-41.11	-13	-28.11	-76.04	-49.50	2.11	10.50	H
									H
									H
									H
									H
	3819	-51.10	-13	-38.10	-73.12	-61.27	2.04	12.21	V
	5730	-47.06	-13	-34.06	-78.57	-57.48	2.10	12.52	V
	7639	-41.12	-13	-28.12	-76.05	-49.51	2.11	10.50	V
									V
									V
									V
									V

Remark: Spurious emissions within 30-1000MHz were found more than 20dB below limit line.



Part24E WCDMA1900

WCDMA 1900									
Channel	Frequency (MHz)	EIRP (dBm)	Limit (dBm)	Over Limit (dB)	SPA Reading (dBm)	S.G. Power (dBm)	TX Cable loss (dB)	TX Antenna Gain (dBi)	Polarization (H/V)
Lowest	3700	-54.42	-13	-41.42	-76.28	-64.73	1.97	12.28	H
	5555	-48.29	-13	-35.29	-76.27	-58.42	2.14	12.28	H
	7400	-41.07	-13	-28.07	-75.57	-49.07	2.18	10.18	H
									H
									H
									H
									H
	3700	-54.42	-13	-41.42	-76.28	-64.73	1.97	12.28	V
	5555	-49.13	-13	-36.13	-77.11	-59.26	2.14	12.28	V
	7400	-41.39	-13	-28.39	-75.89	-49.39	2.18	10.18	V
									V
									V
									V
									V
Middle	3760	-53.17	-13	-40.17	-75.1	-63.41	2.01	12.24	H
	5640	-47.85	-13	-34.85	-76.09	-58.12	2.12	12.40	H
	7520	-40.96	-13	-27.96	-75.71	-48.92	2.11	10.07	H
									H
									H
									H
									H
	3760	-53.71	-13	-40.71	-75.64	-63.95	2.01	12.24	V
	5640	-48.51	-13	-35.51	-76.75	-58.78	2.12	12.40	V
	7520	-40.74	-13	-27.74	-75.49	-48.70	2.11	10.07	V
									V
									V
									V
									V



Highest	3812	-54.40	-13	-41.40	-76.39	-64.58	2.03	12.21	H
	5723	-48.46	-13	-35.46	-76.97	-58.87	2.10	12.51	H
	7630	-41.29	-13	-28.29	-76.19	-49.64	2.11	10.47	H
									H
									H
									H
									H
	3812	-54.14	-13	-41.14	-76.13	-64.32	2.03	12.21	V
	5723	-48.51	-13	-35.51	-77.02	-58.92	2.10	12.51	V
	7630	-41.43	-13	-28.43	-76.33	-49.78	2.11	10.47	V
									V
									V
									V
									V

Remark: Spurious emissions within 30-1000MHz were found more than 20dB below limit line.



Part27L WCDMA 1700

WCDMA 1900									
Channel	Frequency (MHz)	EIRP (dBm)	Limit (dBm)	Over Limit (dB)	SPA Reading (dBm)	S.G. Power (dBm)	TX Cable loss (dB)	TX Antenna Gain (dBi)	Polarization (H/V)
Highest	3504	-48.13	-13	-35.13	-69.7	-58.66	1.87	12.40	H
	5261	-47.11	-13	-34.11	-74.34	-57.01	2.25	12.15	H
	7011	-42.42	-13	-29.42	-76.21	-50.89	2.41	10.88	H
									H
									H
									H
									H
	3504	-42.36	-13	-29.36	-63.93	-52.89	1.87	12.40	V
	5261	-47.57	-13	-34.57	-74.76	-57.47	2.25	12.15	V
	7011	-42.47	-13	-29.47	-76.26	-50.94	2.41	10.88	V
									V
									V
									V
									V

Remark: Spurious emissions within 30-1000MHz were found more than 20dB below limit line.