

System Check_Head_750MHz

DUT: D750V3-1012

Communication System: CW; Frequency: 750 MHz; Duty Cycle: 1:1
Medium: HSL_750_180222 Medium parameters used: $f = 750 \text{ MHz}$; $\sigma = 0.9 \text{ S/m}$; $\epsilon_r = 42.79$; $\rho = 1000 \text{ kg/m}^3$
Ambient Temperature : $23.4 \text{ }^\circ\text{C}$; Liquid Temperature : $22.4 \text{ }^\circ\text{C}$

DASY5 Configuration:

- Probe: ES3DV3 - SN3270; ConvF(6.34, 6.34, 6.34); Calibrated: 2017/9/25;
- Sensor-Surface: 3mm (Mechanical Surface Detection)
- Electronics: DAE4 Sn778; Calibrated: 2017/5/22
- Phantom: SAM_Left; Type: QD000P40CD; Serial: TP:1431
- Measurement SW: DASY52, Version 52.8 (8); SEMCAD X Version 14.6.10 (7373)

Pin=250mW/Area Scan (61x61x1): Interpolated grid: $dx=1.500 \text{ mm}$, $dy=1.500 \text{ mm}$
Maximum value of SAR (interpolated) = 2.42 W/kg

Pin=250mW/Zoom Scan (5x5x7)/Cube 0: Measurement grid: $dx=8\text{mm}$, $dy=8\text{mm}$, $dz=5\text{mm}$
Reference Value = 51.27 V/m ; Power Drift = 0.01 dB
Peak SAR (extrapolated) = 3.04 W/kg
SAR(1 g) = 2.09 W/kg ; SAR(10 g) = 1.42 W/kg
Maximum value of SAR (measured) = 2.43 W/kg

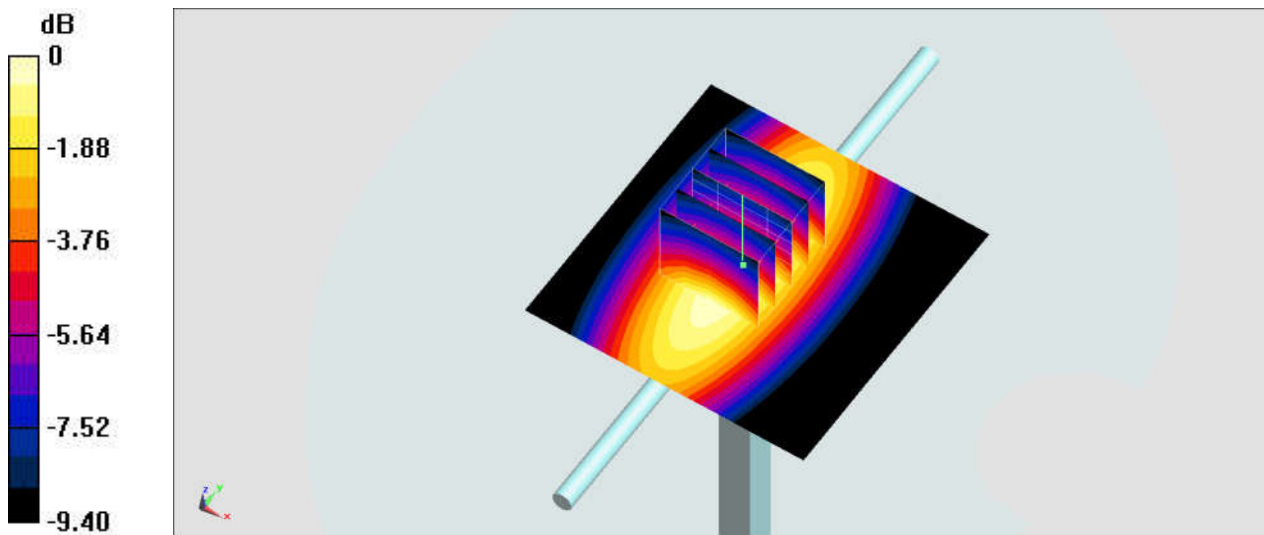

0 dB = $2.43 \text{ W/kg} = 3.86 \text{ dBW/kg}$

System Check_Body_750MHz

DUT: D750V3-1012

Communication System: CW; Frequency: 750 MHz; Duty Cycle: 1:1

Medium: MSL_750_180227 Medium parameters used: $f = 750$ MHz; $\sigma = 0.974$ S/m; $\epsilon_r = 53.911$; $\rho = 1000$ kg/m³

Ambient Temperature : 23.2 °C; Liquid Temperature : 22.2 °C

DASY5 Configuration:

- Probe: EX3DV4 - SN3931; ConvF(10.34, 10.34, 10.34); Calibrated: 2017/9/29;
- Sensor-Surface: 1.4mm (Mechanical Surface Detection)
- Electronics: DAE4 Sn1399; Calibrated: 2017/11/16
- Phantom: SAM_Left; Type: QD000P40CD; Serial: TP:1815
- Measurement SW: DASY52, Version 52.8 (8); SEMCAD X Version 14.6.10 (7373)

Pin=250mW/Area Scan (61x61x1): Interpolated grid: dx=1.500 mm, dy=1.500 mm
Maximum value of SAR (interpolated) = 2.57 W/kg

Pin=250mW/Zoom Scan (5x5x7)/Cube 0: Measurement grid: dx=8mm, dy=8mm, dz=5mm
Reference Value = 52.10 V/m; Power Drift = 0.02 dB
Peak SAR (extrapolated) = 2.99 W/kg
SAR(1 g) = 2.06 W/kg; SAR(10 g) = 1.4 W/kg
Maximum value of SAR (measured) = 2.57 W/kg

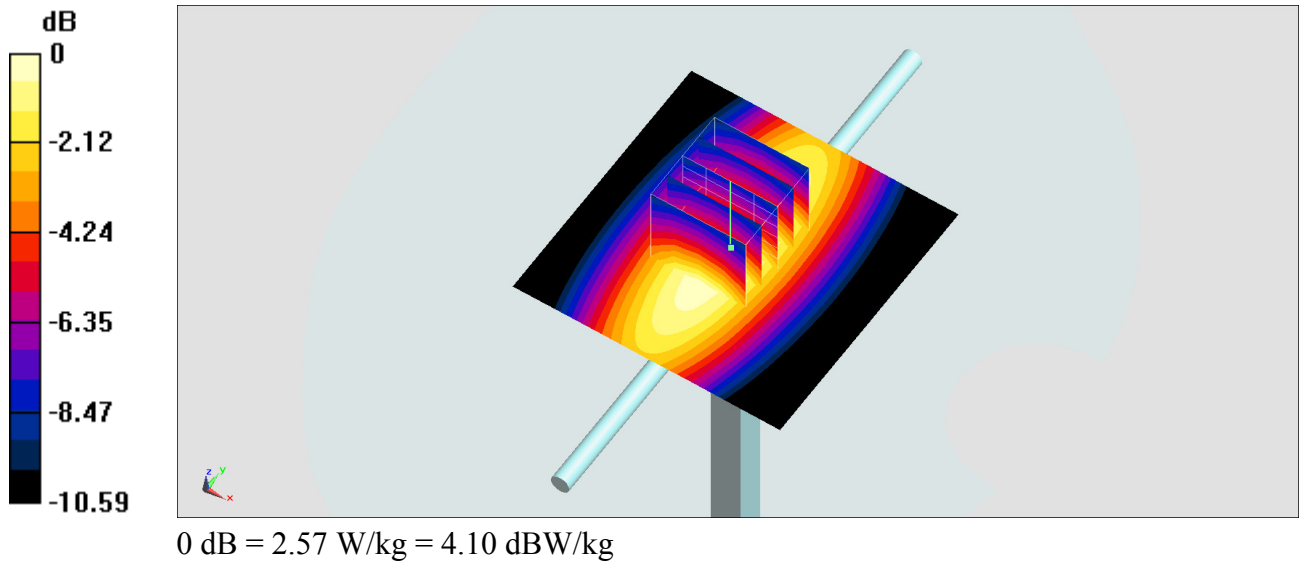

System Check_Head_835MHz

DUT: D835V2-499

Communication System: CW; Frequency: 835 MHz; Duty Cycle: 1:1

Medium: HSL_850_180221 Medium parameters used: $f = 835 \text{ MHz}$; $\sigma = 0.886 \text{ S/m}$; $\epsilon_r = 41.678$; $\rho = 1000 \text{ kg/m}^3$

Ambient Temperature : $23.3 \text{ }^\circ\text{C}$; Liquid Temperature : $22.3 \text{ }^\circ\text{C}$

DASY5 Configuration:

- Probe: EX3DV4 - SN3925; ConvF(10.41, 10.41, 10.41); Calibrated: 2017/5/24;
- Sensor-Surface: 1.4mm (Mechanical Surface Detection)
- Electronics: DAE4 Sn853; Calibrated: 2017/7/19
- Phantom: SAM_Left; Type: QD000P40CD; Serial: TP:1431
- Measurement SW: DASY52, Version 52.8 (8); SEMCAD X Version 14.6.10 (7373)

Pin=250mW/Area Scan (61x61x1): Interpolated grid: $dx=1.500 \text{ mm}$, $dy=1.500 \text{ mm}$

Maximum value of SAR (interpolated) = 3.26 W/kg

Pin=250mW/Zoom Scan (5x5x7)/Cube 0: Measurement grid: $dx=8\text{mm}$, $dy=8\text{mm}$, $dz=5\text{mm}$

Reference Value = 63.82 V/m ; Power Drift = -0.03 dB

Peak SAR (extrapolated) = 3.56 W/kg

SAR(1 g) = 2.42 W/kg ; SAR(10 g) = 1.6 W/kg

Maximum value of SAR (measured) = 3.19 W/kg

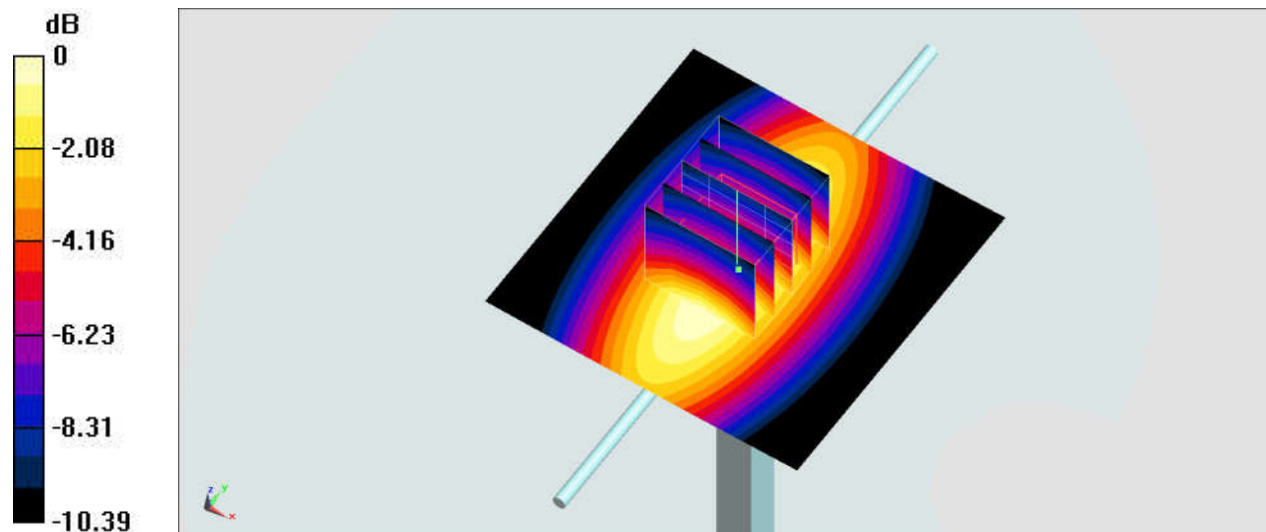

0 dB = $3.19 \text{ W/kg} = 5.04 \text{ dBW/kg}$

System Check_Head_835MHz

DUT: D835V2-499

Communication System: CW; Frequency: 835 MHz; Duty Cycle: 1:1
Medium: HSL_850_180221 Medium parameters used: $f = 835 \text{ MHz}$; $\sigma = 0.886 \text{ S/m}$; $\epsilon_r = 41.678$; $\rho = 1000 \text{ kg/m}^3$
Ambient Temperature : $23.3 \text{ }^\circ\text{C}$; Liquid Temperature : $22.3 \text{ }^\circ\text{C}$

DASY5 Configuration:

- Probe: ES3DV3 - SN3270; ConvF(6.18, 6.18, 6.18); Calibrated: 2017/9/25;
- Sensor-Surface: 3mm (Mechanical Surface Detection)
- Electronics: DAE4 Sn778; Calibrated: 2017/5/22
- Phantom: SAM_Left; Type: QD000P40CD; Serial: TP:1431
- Measurement SW: DASY52, Version 52.8 (8); SEMCAD X Version 14.6.10 (7373)

Pin=250mW/Area Scan (61x61x1): Interpolated grid: $dx=1.500 \text{ mm}$, $dy=1.500 \text{ mm}$
Maximum value of SAR (interpolated) = 2.69 W/kg

Pin=250mW/Zoom Scan (5x5x7)/Cube 0: Measurement grid: $dx=8\text{mm}$, $dy=8\text{mm}$, $dz=5\text{mm}$
Reference Value = 56.45 V/m ; Power Drift = 0.01 dB
Peak SAR (extrapolated) = 3.39 W/kg
SAR(1 g) = 2.29 W/kg ; SAR(10 g) = 1.51 W/kg
Maximum value of SAR (measured) = 2.66 W/kg

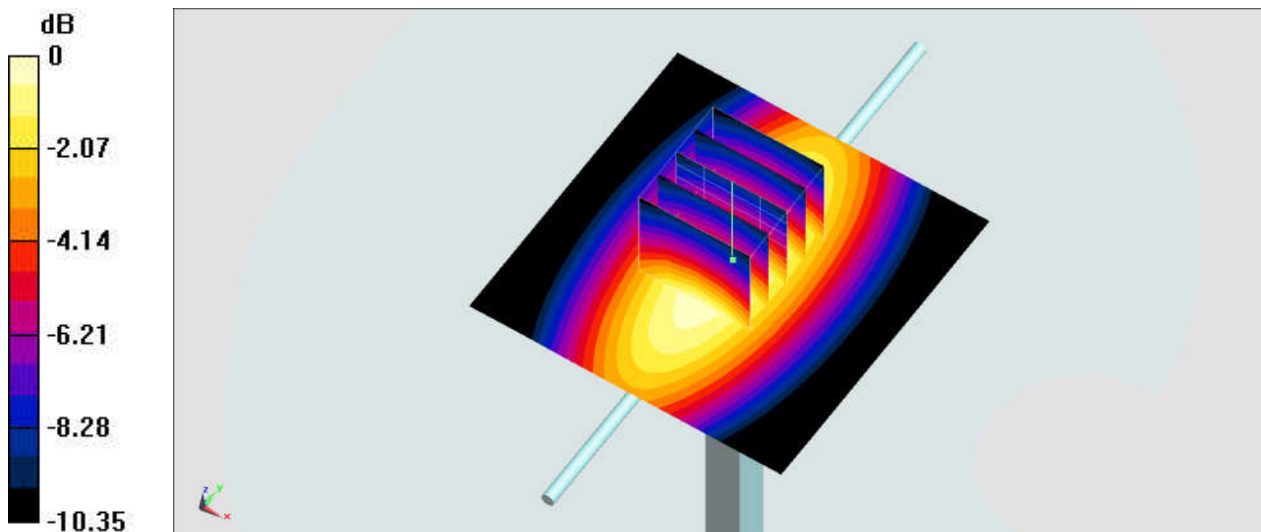

0 dB = $2.66 \text{ W/kg} = 4.25 \text{ dBW/kg}$

System Check_Body_835MHz

DUT: D835V2-499

Communication System: CW; Frequency: 835 MHz; Duty Cycle: 1:1

Medium: MSL_850_180227 Medium parameters used: $f = 835$ MHz; $\sigma = 0.964$ S/m; $\epsilon_r = 56.848$; $\rho = 1000$ kg/m³

Ambient Temperature : 23.2 °C ; Liquid Temperature : 22.2 °C

DASY5 Configuration:

- Probe: EX3DV4 - SN3931; ConvF(10.09, 10.09, 10.09); Calibrated: 2017/9/29;
- Sensor-Surface: 1.4mm (Mechanical Surface Detection)
- Electronics: DAE4 Sn1399; Calibrated: 2017/11/16
- Phantom: SAM_Left; Type: QD000P40CD; Serial: TP:1815
- Measurement SW: DASY52, Version 52.8 (8); SEMCAD X Version 14.6.10 (7373)

Pin=250mW/Area Scan (61x61x1): Interpolated grid: dx=1.500 mm, dy=1.500 mm

Maximum value of SAR (interpolated) = 3.38 W/kg

Pin=250mW/Zoom Scan (5x5x7)/Cube 0: Measurement grid: dx=8mm, dy=8mm, dz=5mm

Reference Value = 61.84 V/m; Power Drift = -0.03 dB

Peak SAR (extrapolated) = 3.75 W/kg

SAR(1 g) = 2.53 W/kg; SAR(10 g) = 1.68 W/kg

Maximum value of SAR (measured) = 3.34 W/kg

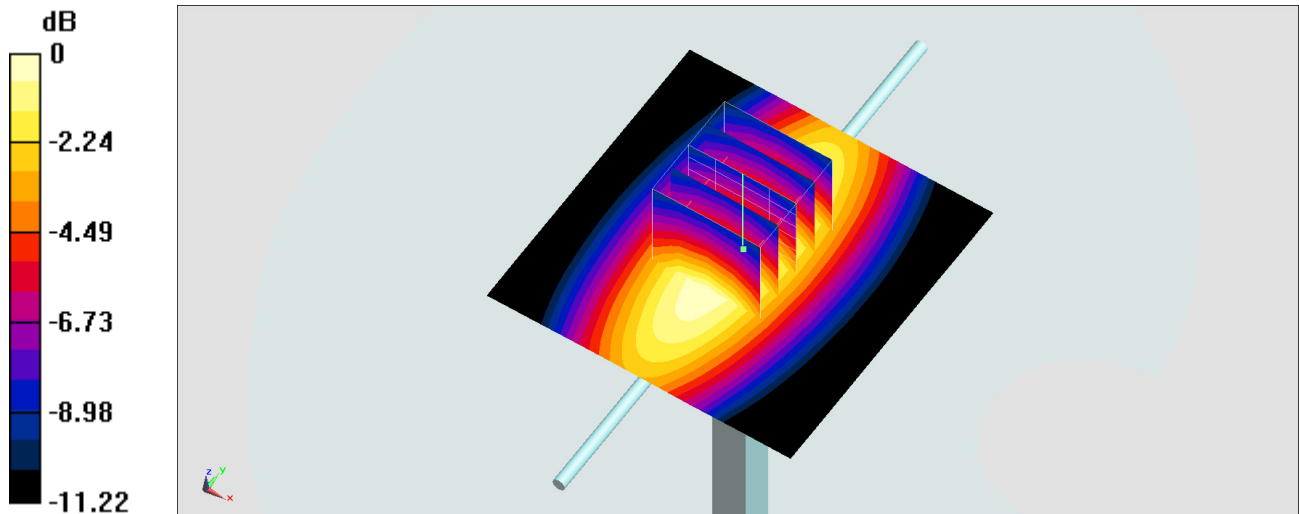

0 dB = 3.34 W/kg = 5.24 dBW/kg

System Check_Head_1750MHz

DUT: D1750V2-1068

Communication System: CW; Frequency: 1750 MHz; Duty Cycle: 1:1
Medium: HSL_1750_180302 Medium parameters used: $f = 1750 \text{ MHz}$; $\sigma = 1.402 \text{ S/m}$; $\epsilon_r = 40.688$;
 $\rho = 1000 \text{ kg/m}^3$
Ambient Temperature : $23.3 \text{ }^\circ\text{C}$; Liquid Temperature : $22.3 \text{ }^\circ\text{C}$

DASY5 Configuration:

- Probe: ES3DV3 - SN3270; ConvF(5.24, 5.24, 5.24); Calibrated: 2017/9/25;
- Sensor-Surface: 3mm (Mechanical Surface Detection)
- Electronics: DAE4 Sn778; Calibrated: 2017/5/22
- Phantom: SAM_Left; Type: QD000P40CD; Serial: TP:1431
- Measurement SW: DASY52, Version 52.8 (8); SEMCAD X Version 14.6.10 (7373)

Pin=250mW/Area Scan (61x61x1): Interpolated grid: $dx=1.500 \text{ mm}$, $dy=1.500 \text{ mm}$
Maximum value of SAR (interpolated) = 12.0 W/kg

Pin=250mW/Zoom Scan (5x5x7)/Cube 0: Measurement grid: $dx=8\text{mm}$, $dy=8\text{mm}$, $dz=5\text{mm}$
Reference Value = 94.27 V/m ; Power Drift = -0.04 dB
Peak SAR (extrapolated) = 16.2 W/kg
SAR(1 g) = 9.38 W/kg ; SAR(10 g) = 5.12 W/kg
Maximum value of SAR (measured) = 11.4 W/kg

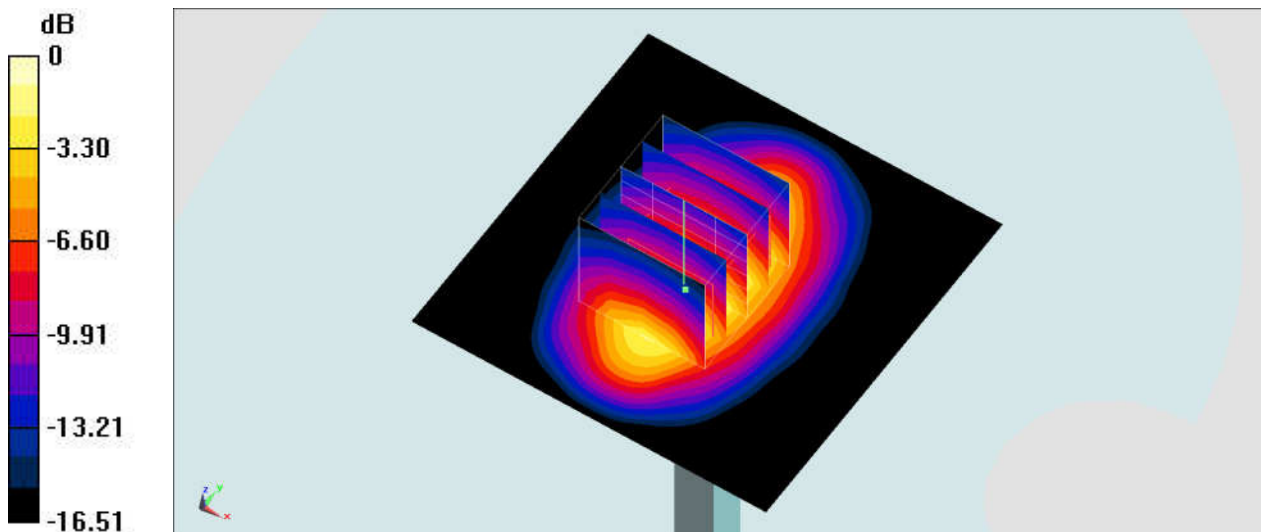

0 dB = $11.4 \text{ W/kg} = 10.57 \text{ dBW/kg}$

System Check_Body_1750MHz

DUT: D1750V2-1068

Communication System: CW; Frequency: 1750 MHz; Duty Cycle: 1:1

Medium: MSL_1750_180301 Medium parameters used: $f = 1750$ MHz; $\sigma = 1.46$ S/m; $\epsilon_r = 55.233$; $\rho = 1000$ kg/m³

Ambient Temperature : 23.5 °C ; Liquid Temperature : 22.5 °C

DASY5 Configuration:

- Probe: ES3DV3 - SN3169; ConvF(4.95, 4.95, 4.95); Calibrated: 2017/5/11;
- Sensor-Surface: 3mm (Mechanical Surface Detection)
- Electronics: DAE4 Sn1399; Calibrated: 2017/11/16
- Phantom: SAM_Right; Type: QD000P40CD; Serial: 1719
- Measurement SW: DASY52, Version 52.8 (8); SEMCAD X Version 14.6.10 (7373)

Pin=250mW/Area Scan (61x61x1): Interpolated grid: dx=1.500 mm, dy=1.500 mm

Maximum value of SAR (interpolated) = 12.3 W/kg

Pin=250mW/Zoom Scan (5x5x7)/Cube 0: Measurement grid: dx=8mm, dy=8mm, dz=5mm

Reference Value = 90.31 V/m; Power Drift = 0.06 dB

Peak SAR (extrapolated) = 15.9 W/kg

SAR(1 g) = 9.36 W/kg; SAR(10 g) = 5.12 W/kg

Maximum value of SAR (measured) = 11.4 W/kg

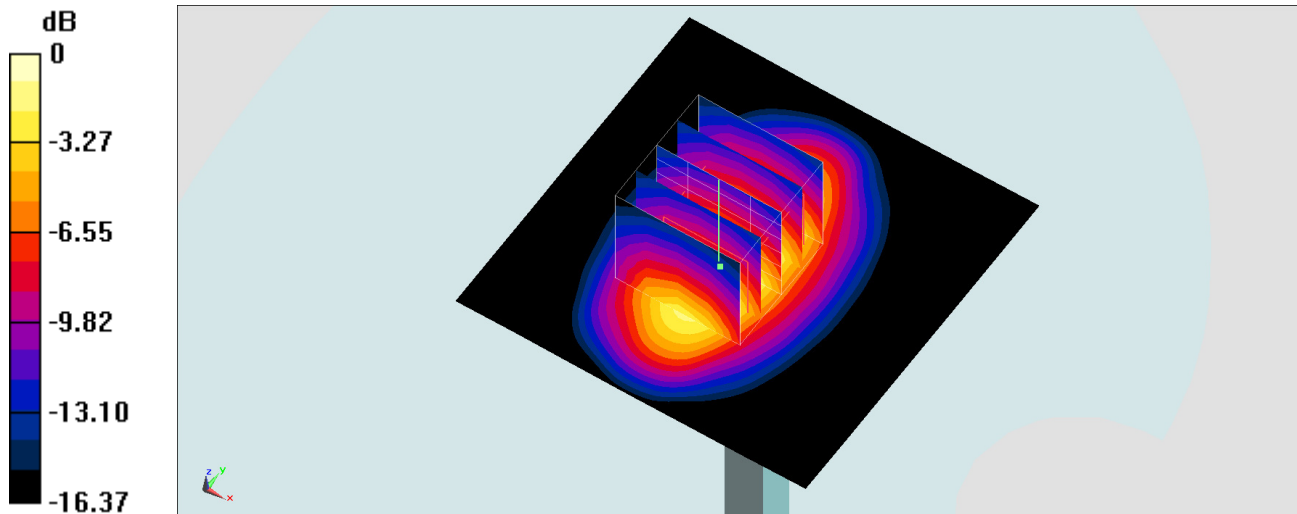

0 dB = 11.4 W/kg = 10.57 dBW/kg

System Check_Body_1750MHz

DUT: D1750V2-1068

Communication System: CW; Frequency: 1750 MHz; Duty Cycle: 1:1

Medium: MSL_1750_180306 Medium parameters used: $f = 1750$ MHz; $\sigma = 1.488$ S/m; $\epsilon_r = 54.987$; $\rho = 1000$ kg/m³

Ambient Temperature : 23.4 °C; Liquid Temperature : 22.4 °C

DASY5 Configuration:

- Probe: ES3DV3 - SN3270; ConvF(5, 5, 5); Calibrated: 2017/9/25;
- Sensor-Surface: 3mm (Mechanical Surface Detection)
- Electronics: DAE4 Sn778; Calibrated: 2017/5/22
- Phantom: SAM_Left; Type: QD000P40CD; Serial: TP:1477
- Measurement SW: DASY52, Version 52.8 (8); SEMCAD X Version 14.6.10 (7373)

Pin=250mW/Area Scan (61x61x1): Interpolated grid: dx=1.500 mm, dy=1.500 mm

Maximum value of SAR (interpolated) = 11.5 W/kg

Pin=250mW/Zoom Scan (5x5x7)/Cube 0: Measurement grid: dx=8mm, dy=8mm, dz=5mm

Reference Value = 87.92 V/m; Power Drift = 0.18 dB

Peak SAR (extrapolated) = 16.1 W/kg

SAR(1 g) = 9.39 W/kg; SAR(10 g) = 5.07 W/kg

Maximum value of SAR (measured) = 11.7 W/kg

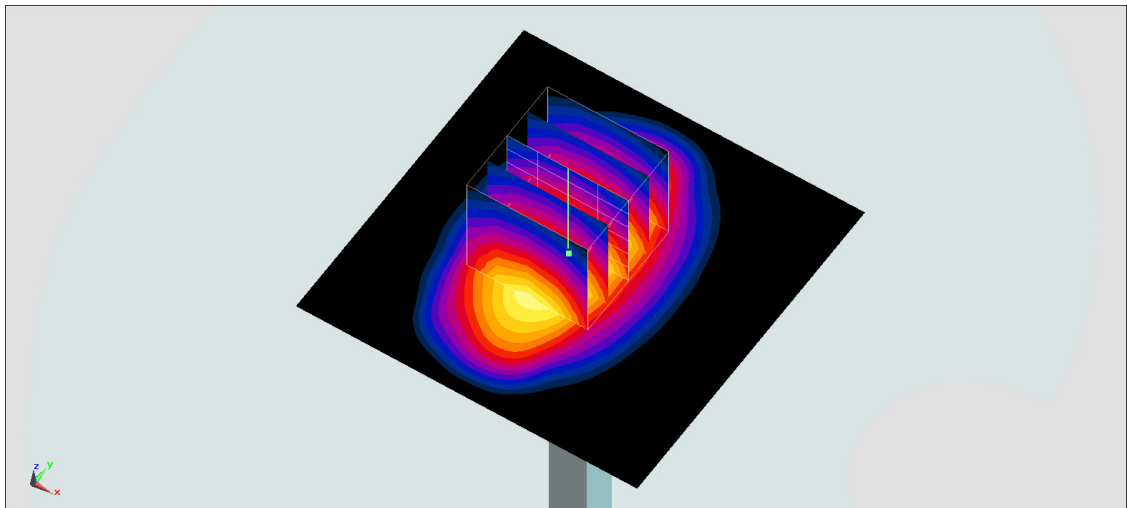
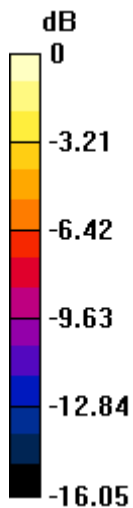

0 dB = 11.7 W/kg = 10.68 dBW/kg

System Check_Body_1750MHz

DUT: D1750V2-1068

Communication System: CW; Frequency: 1750 MHz; Duty Cycle: 1:1

Medium: MSL_1750_180308 Medium parameters used: $f = 1750$ MHz; $\sigma = 1.508$ S/m; $\epsilon_r = 54.719$; $\rho = 1000$ kg/m³

Ambient Temperature : 23.5 °C; Liquid Temperature : 22.5 °C

DASY5 Configuration:

- Probe: EX3DV4 - SN3976; ConvF(8.36, 8.36, 8.36); Calibrated: 2018/1/23;
- Sensor-Surface: 1.4mm (Mechanical Surface Detection)
- Electronics: DAE3 Sn495; Calibrated: 2017/5/22
- Phantom: SAM_Right; Type: QD000P40CD; Serial: 1719
- Measurement SW: DASY52, Version 52.8 (8); SEMCAD X Version 14.6.10 (7373)

Pin=250mW/Area Scan (61x61x1): Interpolated grid: dx=1.500 mm, dy=1.500 mm

Maximum value of SAR (interpolated) = 13.8 W/kg

Pin=250mW/Zoom Scan (5x5x7)/Cube 0: Measurement grid: dx=8mm, dy=8mm, dz=5mm

Reference Value = 99.57 V/m; Power Drift = -0.17 dB

Peak SAR (extrapolated) = 16.0 W/kg

SAR(1 g) = 9.34 W/kg; SAR(10 g) = 5.07 W/kg

Maximum value of SAR (measured) = 13.8 W/kg

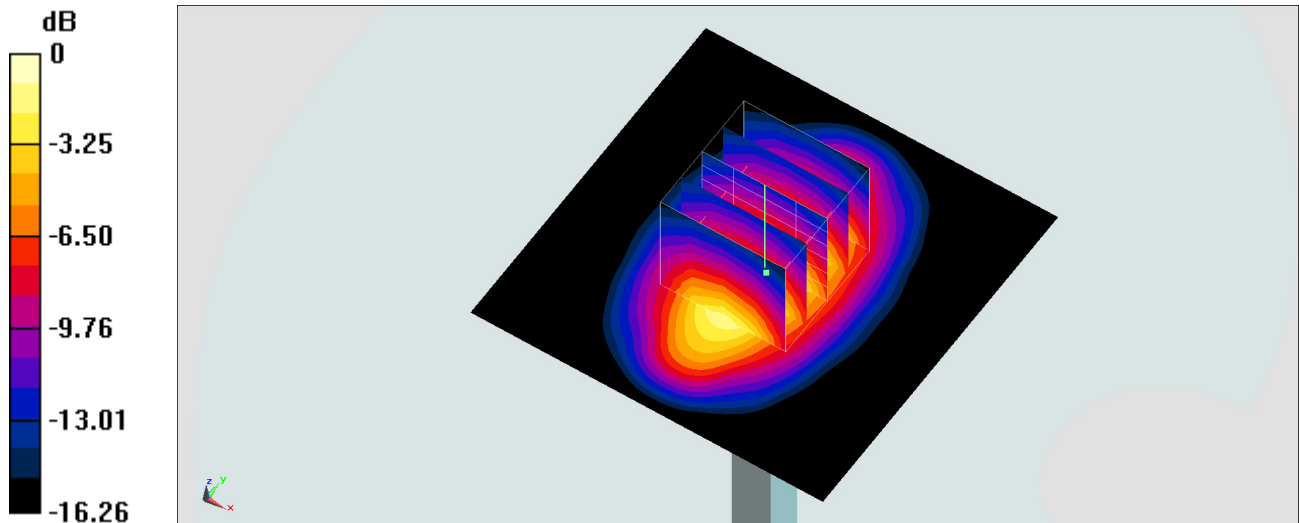

0 dB = 13.8 W/kg = 11.40 dBW/kg

System Check_Head_1900MHz

DUT: D1900V2-5d041

Communication System: CW; Frequency: 1900 MHz; Duty Cycle: 1:1
Medium: HSL_1900_180302 Medium parameters used: $f = 1900 \text{ MHz}$; $\sigma = 1.442 \text{ S/m}$; $\epsilon_r = 39.497$;
 $\rho = 1000 \text{ kg/m}^3$
Ambient Temperature : $23.3 \text{ }^\circ\text{C}$; Liquid Temperature : $22.3 \text{ }^\circ\text{C}$

DASY5 Configuration:

- Probe: ES3DV3 - SN3270; ConvF(5.2, 5.2, 5.2); Calibrated: 2017/9/25;
- Sensor-Surface: 3mm (Mechanical Surface Detection)
- Electronics: DAE4 Sn778; Calibrated: 2017/5/22
- Phantom: SAM_Left; Type: QD000P40CD; Serial: TP:1431
- Measurement SW: DASY52, Version 52.8 (8); SEMCAD X Version 14.6.10 (7373)

Pin=250mW/Area Scan (61x61x1): Interpolated grid: $dx=1.500 \text{ mm}$, $dy=1.500 \text{ mm}$
Maximum value of SAR (interpolated) = 12.7 W/kg

Pin=250mW/Zoom Scan (5x5x7)/Cube 0: Measurement grid: $dx=8\text{mm}$, $dy=8\text{mm}$, $dz=5\text{mm}$
Reference Value = 95.33 V/m ; Power Drift = 0.04 dB
Peak SAR (extrapolated) = 18.1 W/kg
SAR(1 g) = 9.92 W/kg ; SAR(10 g) = 5.19 W/kg
Maximum value of SAR (measured) = 12.2 W/kg

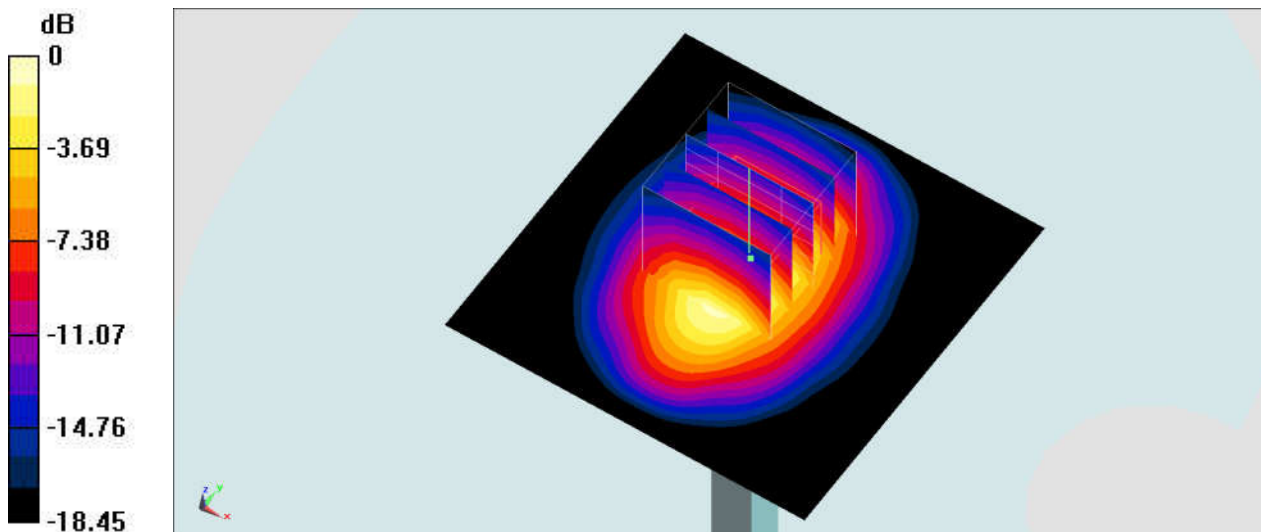

0 dB = $12.2 \text{ W/kg} = 10.86 \text{ dBW/kg}$

System Check_Body_1900MHz

DUT: D1900V2-5d041

Communication System: CW; Frequency: 1900 MHz; Duty Cycle: 1:1

Medium: MSL_1900_180301 Medium parameters used: $f = 1900$ MHz; $\sigma = 1.557$ S/m; $\epsilon_r = 51.87$; $\rho = 1000$ kg/m³

Ambient Temperature : 23.5 °C ; Liquid Temperature : 22.5 °C

DASY5 Configuration:

- Probe: EX3DV4 - SN3931; ConvF(8.12, 8.12, 8.12); Calibrated: 2017/9/29;
- Sensor-Surface: 1.4mm (Mechanical Surface Detection)
- Electronics: DAE4 Sn1399; Calibrated: 2017/11/16
- Phantom: SAM_Right; Type: QD000P40CD; Serial: 1719
- Measurement SW: DASY52, Version 52.8 (8); SEMCAD X Version 14.6.10 (7373)

Pin=250mW/Area Scan (61x61x1): Interpolated grid: dx=1.500 mm, dy=1.500 mm
Maximum value of SAR (interpolated) = 15.9 W/kg

Pin=250mW/Zoom Scan (5x5x7)/Cube 0: Measurement grid: dx=8mm, dy=8mm, dz=5mm
Reference Value = 102.4 V/m; Power Drift = -0.02 dB
Peak SAR (extrapolated) = 18.4 W/kg
SAR(1 g) = 10.5 W/kg; SAR(10 g) = 5.53 W/kg
Maximum value of SAR (measured) = 15.8 W/kg

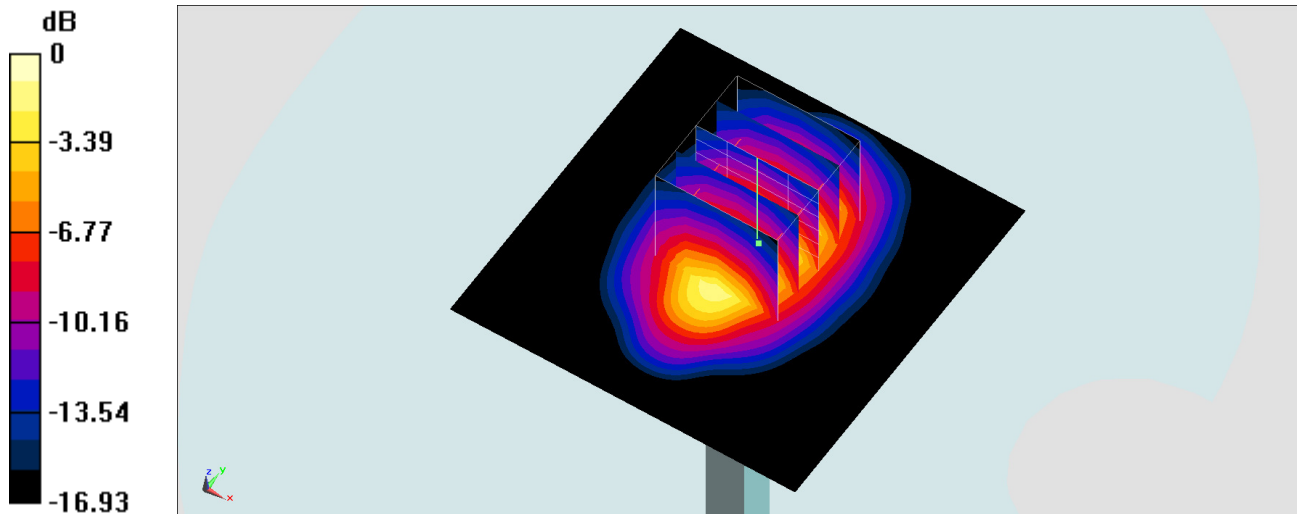

0 dB = 15.8 W/kg = 11.99 dBW/kg

System Check_Body_1900MHz

DUT: D1900V2-5d041

Communication System: CW; Frequency: 1900 MHz; Duty Cycle: 1:1

Medium: MSL_1900_180301 Medium parameters used: $f = 1900$ MHz; $\sigma = 1.557$ S/m; $\epsilon_r = 51.87$; $\rho = 1000$ kg/m³

Ambient Temperature : 23.5 °C; Liquid Temperature : 22.5 °C

DASY5 Configuration:

- Probe: ES3DV3 - SN3169; ConvF(4.72, 4.72, 4.72); Calibrated: 2017/5/11;
- Sensor-Surface: 3mm (Mechanical Surface Detection)
- Electronics: DAE4 Sn1399; Calibrated: 2017/11/16
- Phantom: SAM_Right; Type: QD000P40CD; Serial: 1719
- Measurement SW: DASY52, Version 52.8 (8); SEMCAD X Version 14.6.10 (7373)

Pin=250mW/Area Scan (61x61x1): Interpolated grid: dx=1.500 mm, dy=1.500 mm

Maximum value of SAR (interpolated) = 13.4 W/kg

Pin=250mW/Zoom Scan (5x5x7)/Cube 0: Measurement grid: dx=8mm, dy=8mm, dz=5mm

Reference Value = 87.77 V/m; Power Drift = 0.02 dB

Peak SAR (extrapolated) = 17.5 W/kg

SAR(1 g) = 9.93 W/kg; SAR(10 g) = 5.22 W/kg

Maximum value of SAR (measured) = 12.1 W/kg

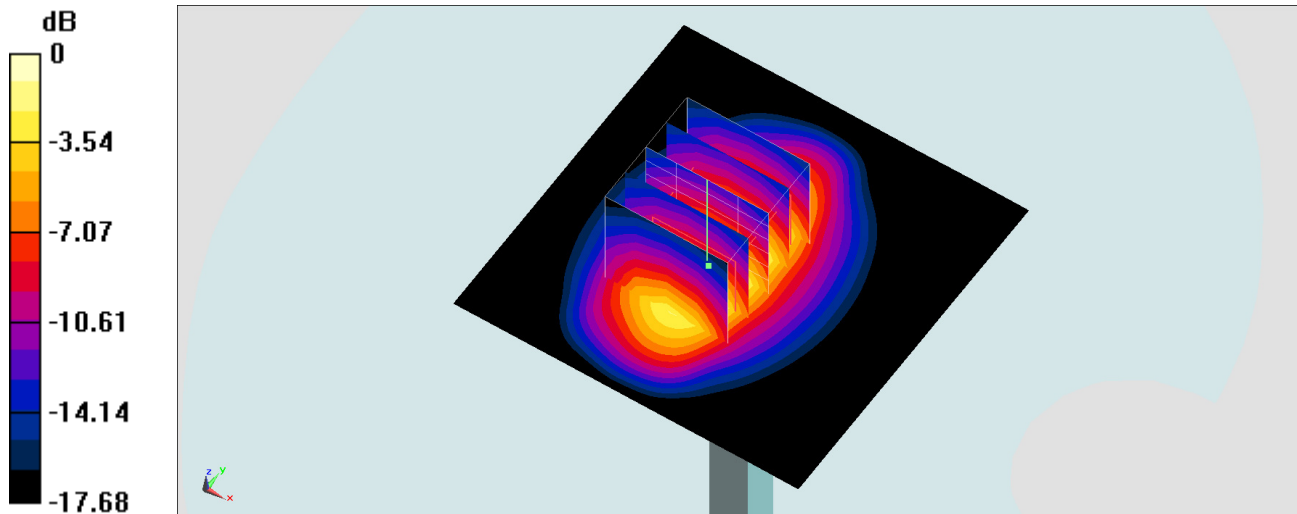

0 dB = 12.1 W/kg = 10.83 dBW/kg

System Check_Body_1900MHz

DUT: D1900V2-5d041

Communication System: CW; Frequency: 1900 MHz; Duty Cycle: 1:1

Medium: MSL_1900_180307 Medium parameters used: $f = 1900$ MHz; $\sigma = 1.555$ S/m; $\epsilon_r = 54.164$; $\rho = 1000$ kg/m³

Ambient Temperature : 23.3 °C; Liquid Temperature : 22.3 °C

DASY5 Configuration:

- Probe: ES3DV3 - SN3270; ConvF(4.9, 4.9, 4.9); Calibrated: 2017/9/25;
- Sensor-Surface: 3mm (Mechanical Surface Detection)
- Electronics: DAE4 Sn778; Calibrated: 2017/5/22
- Phantom: SAM_Left; Type: QD000P40CD; Serial: TP:1477
- Measurement SW: DASY52, Version 52.8 (8); SEMCAD X Version 14.6.10 (7373)

Pin=250mW/Area Scan (61x61x1): Interpolated grid: dx=1.500 mm, dy=1.500 mm

Maximum value of SAR (interpolated) = 12.7 W/kg

Pin=250mW/Zoom Scan (5x5x7)/Cube 0: Measurement grid: dx=8mm, dy=8mm, dz=5mm

Reference Value = 90.81 V/m; Power Drift = 0.01 dB

Peak SAR (extrapolated) = 17.4 W/kg

SAR(1 g) = 9.68 W/kg; SAR(10 g) = 5.11 W/kg

Maximum value of SAR (measured) = 12.1 W/kg

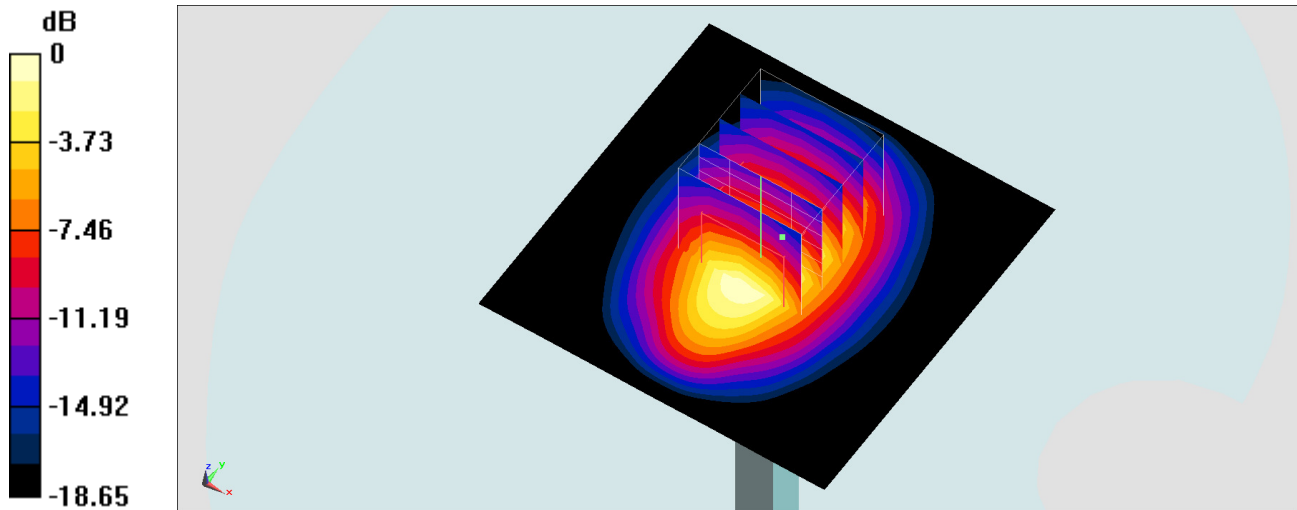

0 dB = 12.1 W/kg = 10.83 dBW/kg

System Check_Body_1900MHz

DUT: D1900V2-5d041

Communication System: CW; Frequency: 1900 MHz; Duty Cycle: 1:1

Medium: MSL_1900_180308 Medium parameters used: $f = 1900$ MHz; $\sigma = 1.552$ S/m; $\epsilon_r = 54.953$; $\rho = 1000$ kg/m³

Ambient Temperature : 23.5 °C ; Liquid Temperature : 22.5 °C

DASY5 Configuration:

- Probe: EX3DV4 - SN3976; ConvF(8.09, 8.09, 8.09); Calibrated: 2018/1/23;
- Sensor-Surface: 1.4mm (Mechanical Surface Detection)
- Electronics: DAE3 Sn495; Calibrated: 2017/5/22
- Phantom: SAM_Right; Type: QD000P40CD; Serial: 1719
- Measurement SW: DASY52, Version 52.8 (8); SEMCAD X Version 14.6.10 (7373)

Pin=250mW/Area Scan (61x61x1): Interpolated grid: dx=1.500 mm, dy=1.500 mm

Maximum value of SAR (interpolated) = 15.3 W/kg

Pin=250mW/Zoom Scan (5x5x7)/Cube 0: Measurement grid: dx=8mm, dy=8mm, dz=5mm

Reference Value = 102.3 V/m; Power Drift = -0.10 dB

Peak SAR (extrapolated) = 18.7 W/kg

SAR(1 g) = 10.4 W/kg; SAR(10 g) = 5.41 W/kg

Maximum value of SAR (measured) = 15.9 W/kg

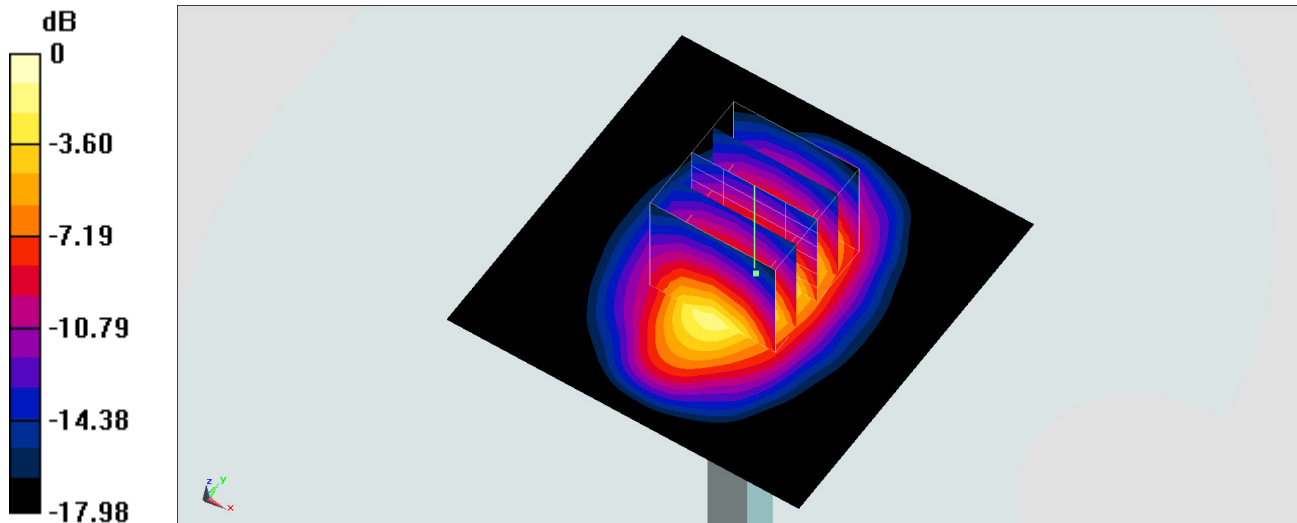

0 dB = 15.9 W/kg = 12.01 dBW/kg

System Check_Head_2600MHz

DUT: D2600V2-1008

Communication System: CW; Frequency: 2600 MHz; Duty Cycle: 1:1

Medium: HSL_2600_180303 Medium parameters used: $f = 2600$ MHz; $\sigma = 2.003$ S/m; $\epsilon_r = 39.579$;
 $\rho = 1000$ kg/m³

Ambient Temperature : 23.3 °C ; Liquid Temperature : 22.3 °C

DASY5 Configuration:

- Probe: ES3DV3 - SN3270; ConvF(4.45, 4.45, 4.45); Calibrated: 2017/9/25;
- Sensor-Surface: 3mm (Mechanical Surface Detection)
- Electronics: DAE4 Sn778; Calibrated: 2017/5/22
- Phantom: SAM_Left; Type: QD000P40CD; Serial: TP:1431
- Measurement SW: DASY52, Version 52.8 (8); SEMCAD X Version 14.6.10 (7373)

Pin=250mW/Area Scan (81x81x1): Interpolated grid: dx=1.200 mm, dy=1.200 mm

Maximum value of SAR (interpolated) = 19.4 W/kg

Pin=250mW/Zoom Scan (7x7x7)/Cube 0: Measurement grid: dx=5mm, dy=5mm, dz=5mm

Reference Value = 98.68 V/m; Power Drift = 0.07 dB

Peak SAR (extrapolated) = 30.8 W/kg

SAR(1 g) = 14.6 W/kg; SAR(10 g) = 6.54 W/kg

Maximum value of SAR (measured) = 19.5 W/kg

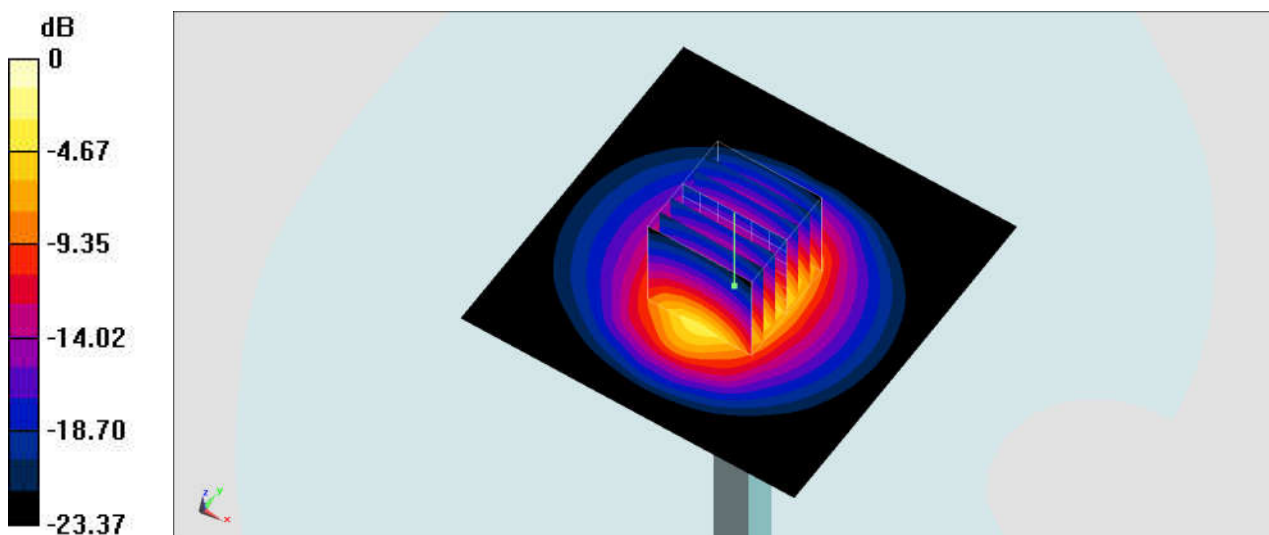

0 dB = 19.5 W/kg = 12.90 dBW/kg

System Check_Head_2600MHz

DUT: D2600V2-1008

Communication System: CW; Frequency: 2600 MHz; Duty Cycle: 1:1

Medium: HSL_2600_180305 Medium parameters used: $f = 2600$ MHz; $\sigma = 1.973$ S/m; $\epsilon_r = 39.844$; $\rho = 1000$ kg/m³

Ambient Temperature : 23.4 °C; Liquid Temperature : 22.4 °C

DASY5 Configuration:

- Probe: ES3DV3 - SN3270; ConvF(4.45, 4.45, 4.45); Calibrated: 2017/9/25;
- Sensor-Surface: 3mm (Mechanical Surface Detection)
- Electronics: DAE4 Sn778; Calibrated: 2017/5/22
- Phantom: SAM_Left; Type: QD000P40CD; Serial: TP:1477
- Measurement SW: DASY52, Version 52.8 (8); SEMCAD X Version 14.6.10 (7373)

Pin=250mW/Area Scan (81x81x1): Interpolated grid: dx=1.200 mm, dy=1.200 mm
Maximum value of SAR (interpolated) = 19.1 W/kg

Pin=250mW/Zoom Scan (7x7x7)/Cube 0: Measurement grid: dx=5mm, dy=5mm, dz=5mm
Reference Value = 98.68 V/m; Power Drift = 0.07 dB
Peak SAR (extrapolated) = 30.3 W/kg
SAR(1 g) = 14.3 W/kg; SAR(10 g) = 6.45 W/kg
Maximum value of SAR (measured) = 19.2 W/kg

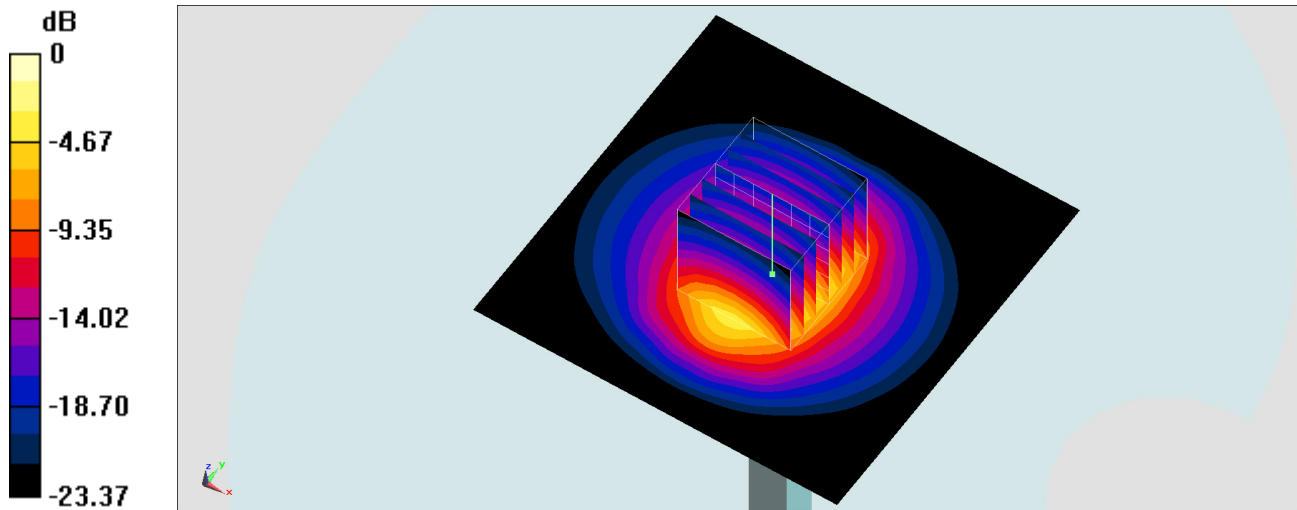

0 dB = 19.2 W/kg = 12.83 dBW/kg

System Check_Body_2600MHz

DUT: D2600V2-1008

Communication System: CW; Frequency: 2600 MHz; Duty Cycle: 1:1

Medium: MSL_2600_180302 Medium parameters used: $f = 2600$ MHz; $\sigma = 2.197$ S/m; $\epsilon_r = 53.248$; $\rho = 1000$ kg/m³

Ambient Temperature : 23.2 °C; Liquid Temperature : 22.2 °C

DASY5 Configuration:

- Probe: ES3DV3 - SN3169; ConvF(4.17, 4.17, 4.17); Calibrated: 2017/5/11;
- Sensor-Surface: 3mm (Mechanical Surface Detection)
- Electronics: DAE4 Sn1399; Calibrated: 2017/11/16
- Phantom: SAM_Left; Type: QD000P40CD; Serial: TP:1815
- Measurement SW: DASY52, Version 52.8 (8); SEMCAD X Version 14.6.10 (7373)

Pin=250mW/Area Scan (61x61x1): Interpolated grid: dx=1.200 mm, dy=1.200 mm

Maximum value of SAR (interpolated) = 19.7 W/kg

Pin=250mW/Zoom Scan (7x7x7)/Cube 0: Measurement grid: dx=5mm, dy=5mm, dz=5mm

Reference Value = 92.76 V/m; Power Drift = 0.06 dB

Peak SAR (extrapolated) = 28.5 W/kg

SAR(1 g) = 13.9 W/kg; SAR(10 g) = 6.24 W/kg

Maximum value of SAR (measured) = 18.2 W/kg

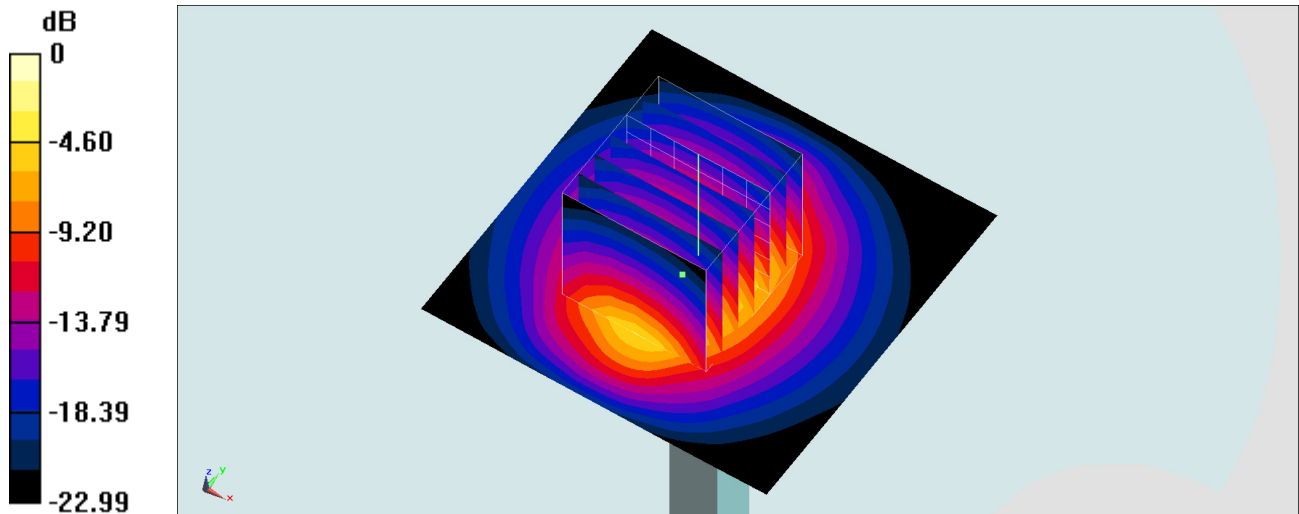

0 dB = 19.7 W/kg = 12.94 dBW/kg

System Check_Body_2600MHz

DUT: D2600V2-1008

Communication System: CW; Frequency: 2600 MHz; Duty Cycle: 1:1

Medium: MSL_2600_180307 Medium parameters used: $f = 2600$ MHz; $\sigma = 2.175$ S/m; $\epsilon_r = 52.06$; $\rho = 1000$ kg/m³

Ambient Temperature : 23.6 °C ; Liquid Temperature : 22.6 °C

DASY5 Configuration:

- Probe: ES3DV3 - SN3270; ConvF(4.19, 4.19, 4.19); Calibrated: 2017/9/25;
- Sensor-Surface: 3mm (Mechanical Surface Detection)
- Electronics: DAE4 Sn778; Calibrated: 2017/5/22
- Phantom: SAM_Right; Type: SAM; Serial: TP:1479
- Measurement SW: DASY52, Version 52.8 (8); SEMCAD X Version 14.6.10 (7373)

Pin=250mW/Area Scan (71x71x1): Interpolated grid: dx=1.200 mm, dy=1.200 mm

Maximum value of SAR (interpolated) = 19.3 W/kg

Pin=250mW/Zoom Scan (7x7x7)/Cube 0: Measurement grid: dx=5mm, dy=5mm, dz=5mm

Reference Value = 95.54 V/m; Power Drift = -0.05 dB

Peak SAR (extrapolated) = 29.5 W/kg

SAR(1 g) = 13.9 W/kg; SAR(10 g) = 6.19 W/kg

Maximum value of SAR (measured) = 18.5 W/kg

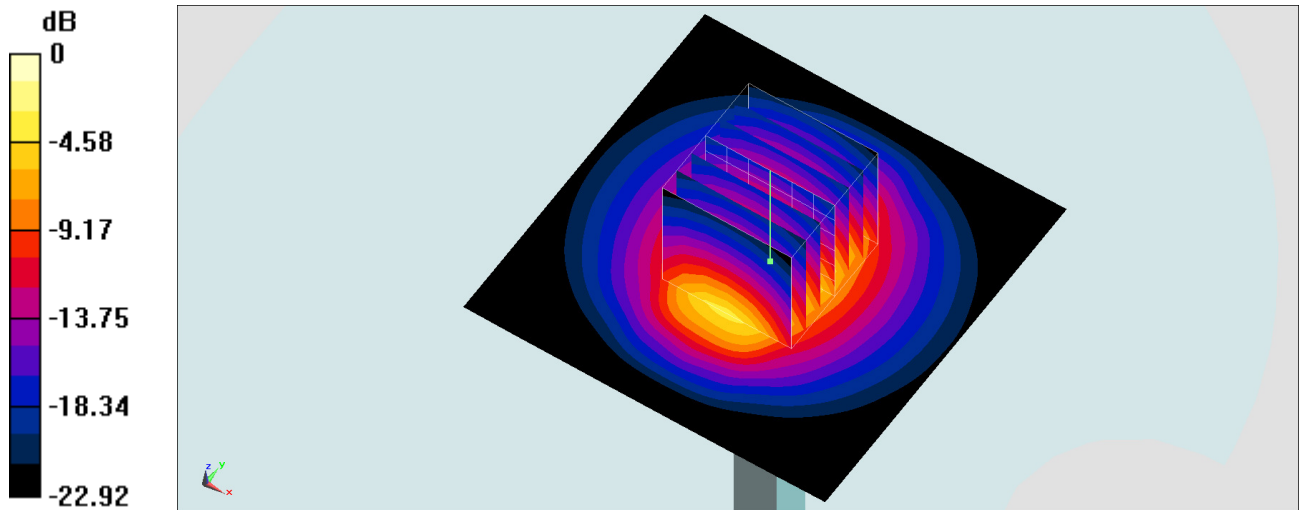

0 dB = 18.5 W/kg = 12.67 dBW/kg

System Check_Body_2600MHz

DUT: D2600V2-1008

Communication System: CW; Frequency: 2600 MHz; Duty Cycle: 1:1

Medium: MSL_2600_180308 Medium parameters used: $f = 2600$ MHz; $\sigma = 2.206$ S/m; $\epsilon_r = 53.322$; $\rho = 1000$ kg/m³

Ambient Temperature : 23.5 °C ; Liquid Temperature : 22.5 °C

DASY5 Configuration:

- Probe: EX3DV4 - SN3976; ConvF(7.37, 7.37, 7.37); Calibrated: 2018/1/23;
- Sensor-Surface: 1.4mm (Mechanical Surface Detection)
- Electronics: DAE3 Sn495; Calibrated: 2017/5/22
- Phantom: SAM_Right; Type: QD000P40CD; Serial: 1719
- Measurement SW: DASY52, Version 52.8 (8); SEMCAD X Version 14.6.10 (7373)

Pin=250mW/Area Scan (61x61x1): Interpolated grid: dx=1.200 mm, dy=1.200 mm

Maximum value of SAR (interpolated) = 26.1 W/kg

Pin=250mW/Zoom Scan (7x7x7)/Cube 0: Measurement grid: dx=5mm, dy=5mm, dz=5mm

Reference Value = 113.4 V/m; Power Drift = -0.13 dB

Peak SAR (extrapolated) = 30.2 W/kg

SAR(1 g) = 14.4 W/kg; SAR(10 g) = 6.63 W/kg

Maximum value of SAR (measured) = 24.2 W/kg

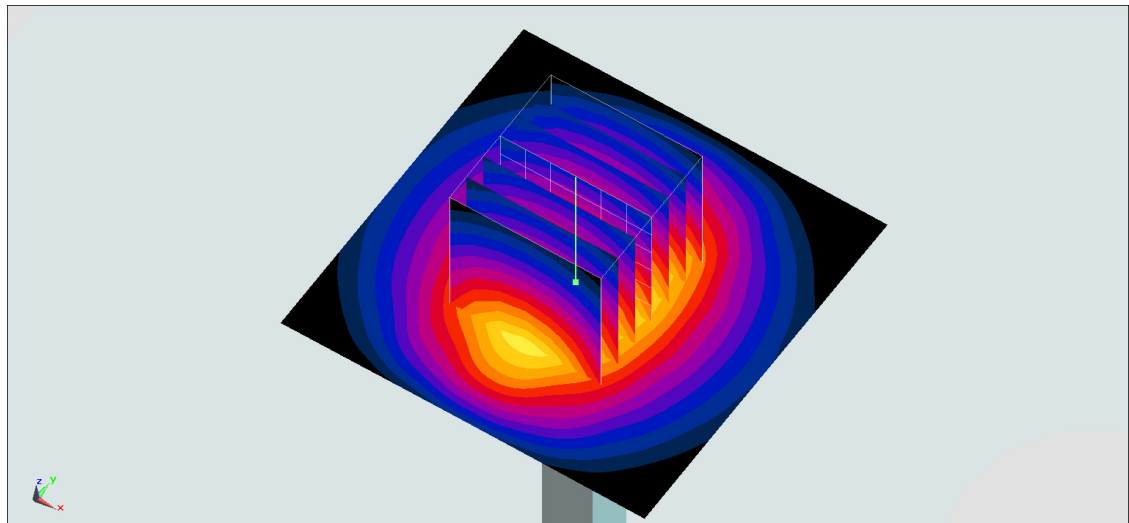
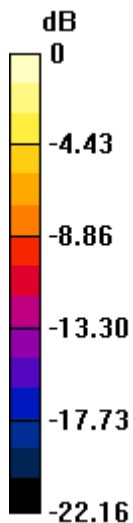

0 dB = 24.2 W/kg = 13.84 dBW/kg