



# FCC RF Test Report

**APPLICANT** : Motorola Mobility LLC  
**EQUIPMENT** : Mobile Cellular Phone  
**BRAND NAME** : Motorola  
**MODEL NAME** : XT1929-8  
**FCC ID** : IHDT56XE3  
**STANDARD** : FCC Part 15 Subpart C §15.247  
**CLASSIFICATION** : (DTS) Digital Transmission System

This is a variant report. The product was received on Jan. 18, 2018 and testing was completed on Mar. 14, 2018. We, SPORTON INTERNATIONAL INC., would like to declare that the tested sample has been evaluated in accordance with the test procedures and has been in compliance with the applicable technical standards.

The test results in this report apply exclusively to the tested model / sample. Without written approval of SPORTON INTERNATIONAL INC., the test report shall not be reproduced except in full.

Reviewed by: Joseph Lin / Supervisor

Approved by: Jones Tsai / Manager



## **SPORTON INTERNATIONAL INC.**

**No. 52, Hwa Ya 1<sup>st</sup> Rd., Hwa Ya Technology Park, Kwei-Shan District, Tao Yuan City, Taiwan, R.O.C.**

**SPORTON INTERNATIONAL INC.**

TEL : 886-3-327-3456

FAX : 886-3-328-4978

FCC ID: IHDT56XE3

Page Number : 1 of 19

Report Issued Date : Mar. 16, 2018

Report Version : Rev. 01

Report Template No.: BU5-FR15CBT4.0 Version 2.0



# TABLE OF CONTENTS

**REVISION HISTORY..... 3**

**SUMMARY OF TEST RESULT ..... 4**

**1 GENERAL DESCRIPTION..... 5**

    1.1 Applicant ..... 5

    1.2 Manufacturer ..... 5

    1.3 Product Feature of Equipment Under Test..... 5

    1.4 Product Specification of Equipment Under Test..... 7

    1.5 Modification of EUT ..... 7

    1.6 Testing Location ..... 7

    1.7 Applicable Standards ..... 8

**2 TEST CONFIGURATION OF EQUIPMENT UNDER TEST..... 9**

    2.1 Carrier Frequency Channel ..... 9

    2.2 Test Mode ..... 10

    2.3 Connection Diagram of Test System ..... 11

    2.4 Support Unit used in test configuration and system ..... 11

    2.5 EUT Operation Test Setup ..... 11

**3 TEST RESULT ..... 12**

    3.1 Output Power Measurement..... 12

    3.2 Radiated Band Edges and Spurious Emission Measurement ..... 13

    3.3 Antenna Requirements ..... 17

**4 LIST OF MEASURING EQUIPMENT ..... 18**

**5 UNCERTAINTY OF EVALUATION..... 19**

**APPENDIX A. CONDUCTED TEST RESULTS**

**APPENDIX B. RADIATED SPURIOUS EMISSION**

**APPENDIX C. RADIATED SPURIOUS EMISSION PLOTS**

**APPENDIX D. DUTY CYCLE PLOTS**



### REVISION HISTORY

REPORT NO.	VERSION	DESCRIPTION	ISSUED DATE
FR811821-07B	Rev. 01	Initial issue of report	Mar. 16, 2018



### SUMMARY OF TEST RESULT

Report Section	FCC Rule	Description	Limit	Result	Remark
-	15.247(a)(2)	6dB Bandwidth	$\geq 0.5\text{MHz}$	Not Required	-
-	-	99% Bandwidth	-	Not Required	-
3.1	15.247(b)(3)	Peak Output Power	$\leq 30\text{dBm}$	Pass	-
-	15.247(e)	Power Spectral Density	$\leq 8\text{dBm}/3\text{kHz}$	Not Required	-
-	15.247(d)	Conducted Band Edges and Spurious Emission	$\leq 20\text{dBc}$	Not Required	-
3.2	15.247(d)	Radiated Band Edges and Spurious Emission	15.209(a) & 15.247(d)	Pass	Under limit 5.14 dB at 171.750 MHz
-	15.207	AC Conducted Emission	15.207(a)	Not Required	-
3.3	15.203 & 15.247(b)	Antenna Requirement	N/A	Pass	-

**Remark:** Not required means after assessing, test items are not necessary to carry out.



# 1 General Description

## 1.1 Applicant

Motorola Mobility LLC  
222 W,Merchandise Mart Plaza, Chicago IL 60654 USA

## 1.2 Manufacturer

Motorola Mobility LLC  
222 W,Merchandise Mart Plaza, Chicago IL 60654 USA

## 1.3 Product Feature of Equipment Under Test

Product Feature	
Equipment	Mobile Cellular Phone
Brand Name	Motorola
Model Name	XT1929-8
FCC ID	IHDT56XE3
Sample 1	EUT with Dual SIM
Sample 2	EUT with Single SIM
IMEI Code	<b>Conducted</b> IMEI 1: 354105090012138 IMEI 2: 354105090012146
	<b>Radiation:</b> IMEI 1: 354105090023036 IMEI 2: 354105090023044
EUT supports Radios application	GSM/EGPRS/WCDMA/HSPA/LTE/GNSS/NFC WLAN 11b/g/n HT20 WLAN 11a/n HT20/HT40 WLAN 11ac VHT20/VHT40/VHT80 Bluetooth BR/EDR/LE
HW Version	DVT2
EUT Stage	Identical Prototype

**Remark:**

1. The above EUT's information was declared by manufacturer. Please refer to the specifications or user's manual for more detailed description.
2. This is a variant report. All the test cases were performed on original report which can be referred to Sporton Report Number FR811821-02B.



Accessory List	
AC Adapter 1	Brand Name : Motorola
	Model Name : SC-23 SPN5971A
	Manufacturer : Salom
AC Adapter 2	Brand Name : Motorola
	Model Name : SC-23 SPN5989A
	Manufacturer : Chenyang
AC Adapter 3	Brand Name : Motorola
	Model Name : SC-24 SPN5972A
	Manufacturer : Salom
AC Adapter 4	Brand Name : Motorola
	Model Name : SC-24 SPN5990A
	Manufacturer : Chenyang
Battery	Brand Name : Motorola
	Model Name : JS40
	Manufacturer : SUNWODA
Earphone	Brand Name : Motorola
	Model Name : SH38C16618
C2Audio Cable 1	Brand Name : Motorola
	Model Name : SC18C27844
	Manufacturer : Luxshare
C2Audio Cable 2	Brand Name : Motorola
	Model Name : SC18C27845
	Manufacturer : Cabletech
USB Cable 1	Brand Name : Cabletech
	Model Name : SKN6473A
USB Cable 2	Brand Name : FOXLINK
	Model Name : SKN6473A 17195-C 0403532
USB Cable 3	Brand Name : SAIBAO
	Model Name : SKN6473A 17214-C 1127044
USB Cable 4	Brand Name : Luxshare
	Model Name : SKN6473A 17227-C 1126538



### 1.4 Product Specification of Equipment Under Test

Standards-related Product Specification	
<b>Tx/Rx Frequency Range</b>	2402 MHz ~ 2480 MHz
<b>Number of Channels</b>	40
<b>Carrier Frequency of Each Channel</b>	40 Channel(37 hopping + 3 advertising channel)
<b>Maximum Output Power to Antenna</b>	Bluetooth LE (1Mbps) : 12.85 dBm (0.0193 W) Bluetooth LE (2Mbps) : 12.77 dBm (0.0189 W)
<b>Antenna Type / Gain</b>	Internal Antenna with gain -5.00 dBi
<b>Type of Modulation</b>	Bluetooth LE : GFSK

### 1.5 Modification of EUT

No modifications are made to the EUT during all test items.

### 1.6 Testing Location

Sporton Lab is accredited to ISO 17025 by Taiwan Accreditation Foundation (TAF code : 1190) and the FCC designation No. TW1190 and TW0007 under the FCC 2.948(e) by Mutual Recognition Agreement (MRA) in FCC Test.

<b>Test Site</b>	SPORTON INTERNATIONAL INC.
<b>Test Site Location</b>	No. 52, Hwa Ya 1 <sup>st</sup> Rd., Hwa Ya Technology Park, Kwei-Shan District, Tao Yuan City, Taiwan, R.O.C. TEL: +886-3-327-3456 FAX: +886-3-328-4978
<b>Test Site No.</b>	<b>Sporton Site No.</b> TH05-HY

**Note:** The test site complies with ANSI C63.4 2014 requirement.

<b>Test Site</b>	SPORTON INTERNATIONAL INC.
<b>Test Site Location</b>	No.58, Aly. 75, Ln. 564, Wenhua 3rd Rd. Guishan Dist, Taoyuan City, Taiwan (R.O.C.) TEL: +886-3-327-3456 FAX: +886-3-328-4978
<b>Test Site No.</b>	<b>Sporton Site No.</b> 03CH12-HY

**Note:** The test site complies with ANSI C63.4 2014 requirement.



## **1.7 Applicable Standards**

According to the specifications of the manufacturer, the EUT must comply with the requirements of the following standards:

- ♦ FCC Part 15 Subpart C §15.247
- ♦ FCC KDB Publication No. 558074 D01 DTS Meas. Guidance v04
- ♦ ANSI C63.10-2013

### **Remark:**

1. All test items were verified and recorded according to the standards and without any deviation during the test.
2. This EUT has also been tested and complied with the requirements of FCC Part 15, Subpart B, recorded in a separate test report.





## 2 Test Configuration of Equipment Under Test

### 2.1 Carrier Frequency Channel

Frequency Band	Channel	Freq. (MHz)	Channel	Freq. (MHz)
2400-2483.5 MHz	0	2402	21	2444
	1	2404	22	2446
	2	2406	23	2448
	3	2408	24	2450
	4	2410	25	2452
	5	2412	26	2454
	6	2414	27	2456
	7	2416	28	2458
	8	2418	29	2460
	9	2420	30	2462
	10	2422	31	2464
	11	2424	32	2466
	12	2426	33	2468
	13	2428	34	2470
	14	2430	35	2472
	15	2432	36	2474
	16	2434	37	2476
	17	2436	38	2478
	18	2438	39	2480
	19	2440	-	-
20	2442	-	-	



## 2.2 Test Mode

- a. The EUT has been associated with peripherals and configuration operated in a manner tended to maximize its emission characteristics in a typical application. Frequency range investigated: radiation emission (9 kHz to the 10th harmonic of the highest fundamental frequency or to 40 GHz, whichever is lower). For radiated measurement, pre-scanned in three orthogonal panels, X, Y, Z. The worst cases (Z plane) were recorded in this report.

The following summary table is showing all test modes to demonstrate in compliance with the standard.

Summary table of Test Cases	
Test Item	Data Rate / Modulation
	Bluetooth – LE / GFSK
Conducted TCs	Mode 1: Bluetooth Tx CH00_2402 MHz_1Mbps
	Mode 2: Bluetooth Tx CH19_2440 MHz_1Mbps
	Mode 3: Bluetooth Tx CH39_2480 MHz_1Mbps
Radiated TCs	Mode 1: Bluetooth Tx CH39_2480 MHz_2Mbps
<b>Remark:</b> For Radiated Test Cases, The tests were performance with USB Cable 1 Type C and Sample 1.	

## 2.3 Connection Diagram of Test System

<Bluetooth – LE Tx Mode>

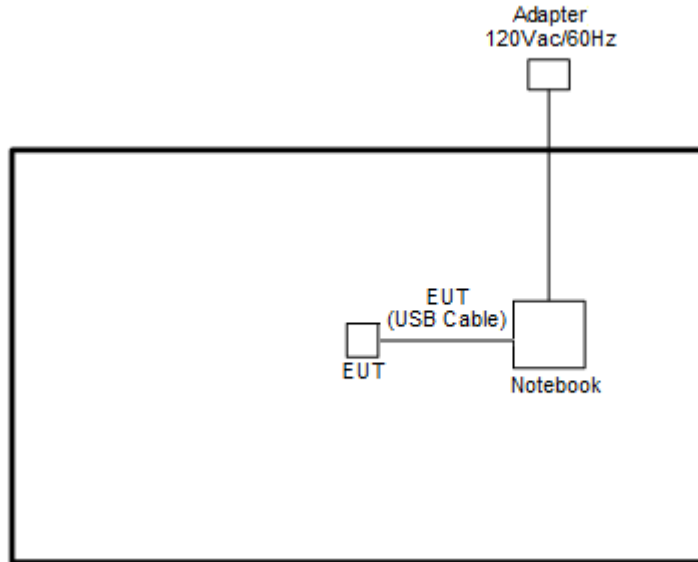

## 2.4 Support Unit used in test configuration and system

Item	Equipment	Trade Name	Model Name	FCC ID	Data Cable	Power Cord
1.	Notebook	Lenovo	E335	FCC DoC	N/A	AC I/P: Unshielded, 1.2 m DC O/P: Shielded, 1.8 m

## 2.5 EUT Operation Test Setup

The RF test items, utility “QRCT” was installed in Notebook which was programmed in order to make the EUT get into the engineering modes to provide channel selection, power level, data rate and the application type and for continuous transmitting signals.

### 3 Test Result

#### 3.1 Output Power Measurement

##### 3.1.1 Limit of Output Power

For systems using digital modulation in the 2400-2483.5MHz, the limit for peak output power is 30dBm. If transmitting antenna of directional gain greater than 6dBi is used, the peak output power from the intentional radiator shall be reduced below the above stated value by the amount in dB that the directional gain of the antenna exceeds 6 dBi. In case of point-to-point operation, the limit has to be reduced by 1dB for every 3dB that the directional gain of the antenna exceeds 6dBi.

##### 3.1.2 Measuring Instruments

The section 4.0 of List of Measuring Equipment of this test report is used for test.

##### 3.1.3 Test Procedures

1. The testing follows the Measurement Procedure of FCC KDB No. 558074 DTS D01 Meas. Guidance v04 section 9.1.3 PKPM1 Peak power meter method.
2. The RF output of EUT was connected to the power meter by RF cable and attenuator. The path loss was compensated to the results for each measurement.
3. Set to the maximum power setting and enable the EUT transmit continuously.
4. Measure the conducted output power and record the results in the test report.

##### 3.1.4 Test Setup

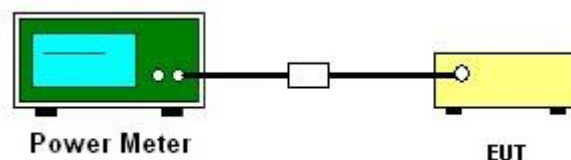

##### 3.1.5 Test Result of Peak Output Power

Please refer to Appendix A.

##### 3.1.6 Test Result of Average Output Power (Reporting Only)

Please refer to Appendix A.



### 3.2 Radiated Band Edges and Spurious Emission Measurement

#### 3.2.1 Limit of Radiated Band Edges and Spurious Emission

In any 100 kHz bandwidth outside the intentional radiator frequency band, all harmonics/spurious must be at least 20 dB below the highest emission level within the authorized band. If the output power of this device was measured by spectrum analyzer, the attenuation under this paragraph shall be 30 dB instead of 20 dB. In addition, radiated emissions which fall in the restricted bands must also comply with the limits as below.

Frequency (MHz)	Field Strength (microvolts/meter)	Measurement Distance (meters)
0.009 – 0.490	2400/F(kHz)	300
0.490 – 1.705	24000/F(kHz)	30
1.705 – 30.0	30	30
30 – 88	100	3
88 – 216	150	3
216 - 960	200	3
Above 960	500	3

#### 3.2.2 Measuring Instruments

The section 4.0 of List of Measuring Equipment of this test report is used for test.



### 3.2.3 Test Procedures

1. The testing follows FCC KDB Publication No. 558074 D01 DTS Meas. Guidance v04.
2. The EUT was arranged to its worst case and then tune the antenna tower (from 1 m to 4 m) and turntable (from 0 degree to 360 degrees) to find the maximum reading. A pre-amp and a high pass filter are used for the test in order to get better signal level.
3. The EUT was placed on a turntable with 0.8 meter for frequency below 1GHz and 1.5 meter for frequency above 1GHz respectively above ground.
4. The EUT was set 3 meters from the interference receiving antenna, which was mounted on the top of a variable height antenna tower.
5. Corrected Reading: Antenna Factor + Cable Loss + Read Level - Preamp Factor = Level
6. For testing below 1GHz, if the emission level of the EUT in peak mode was 3 dB lower than the limit specified, then peak values of EUT will be reported, otherwise, the emissions will be repeated one by one using the CISPR quasi-peak method and reported.
7. For testing above 1GHz, the emission level of the EUT in peak mode was 20dB lower than average limit (that means the emission level in average mode also complies with the limit in average mode), then peak values of EUT will be reported, otherwise, the emissions will be measured in average mode again and reported.
8. Use the following spectrum analyzer settings:
  - (1) Span shall wide enough to fully capture the emission being measured;
  - (2) Set RBW=100 kHz for  $f < 1$  GHz;  $VBW \geq RBW$ ; Sweep = auto; Detector function = peak; Trace = max hold;
  - (3) Set RBW = 1 MHz, VBW= 3MHz for  $f \geq 1$  GHz for peak measurement.  
For average measurement:
    - $VBW = 10$  Hz, when duty cycle is no less than 98 percent.
    - $VBW \geq 1/T$ , when duty cycle is less than 98 percent where T is the minimum transmission duration over which the transmitter is on and is transmitting at its maximum power control level for the tested mode of operation.

### 3.2.4 Test Setup

For radiated emissions below 30MHz

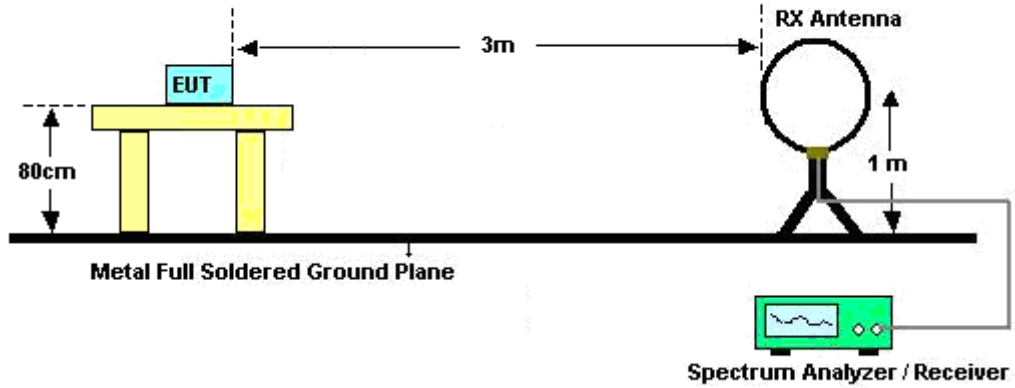

For radiated emissions from 30MHz to 1GHz

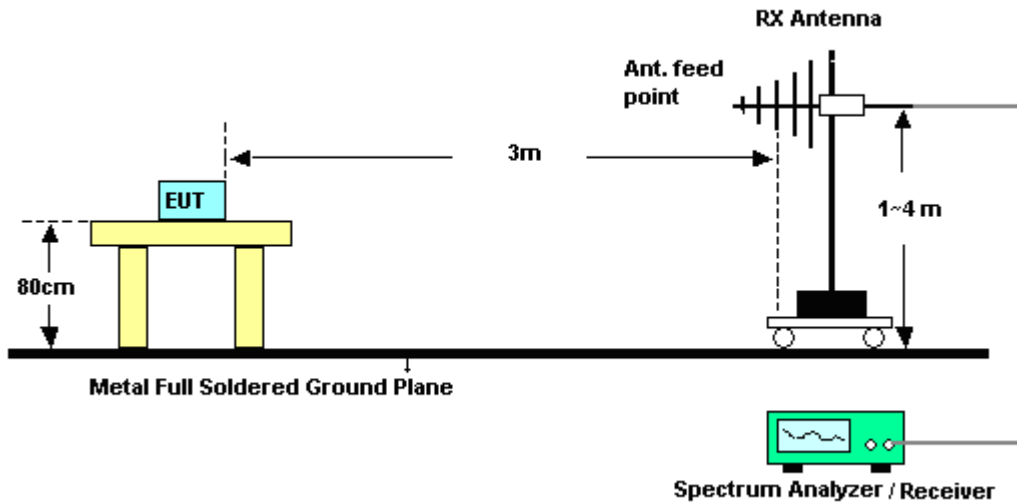

For radiated emissions above 1GHz

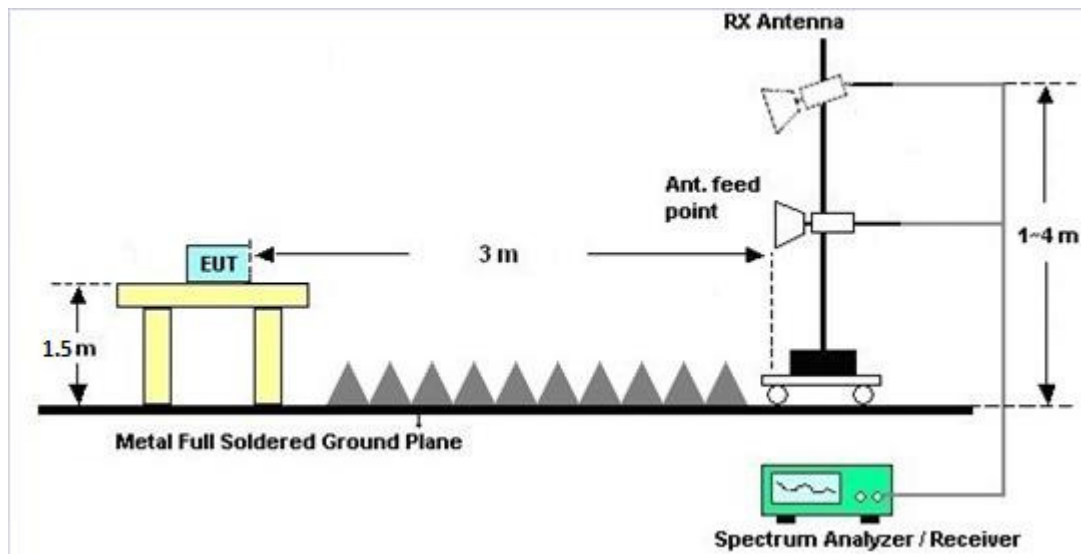

### 3.2.5 Test Results of Radiated Spurious Emissions (9 kHz ~ 30 MHz)

The low frequency, which started from 9 kHz to 30MHz, was pre-scanned and the result which was 20dB lower than the limit line was not reported.

There is a comparison data of both open-field test site and semi-Anechoic chamber, and the result came out very similar.

### 3.2.6 Test Result of Radiated Spurious at Band Edges

Please refer to Appendix B and C.

### 3.2.7 Duty Cycle

Please refer to Appendix D.

### 3.2.8 Test Result of Radiated Spurious Emission (30MHz ~ 10th Harmonic)

Please refer to Appendix B and C.





### **3.3 Antenna Requirements**

#### **3.3.1 Standard Applicable**

If directional gain of transmitting antennas is greater than 6dBi, the power shall be reduced by the same level in dB comparing to gain minus 6dBi. The use of a permanently attached antenna or of an antenna that uses a unique coupling to the intentional radiator shall be considered sufficient to comply with the rule.

#### **3.3.2 Antenna Anti-Replacement Construction**

An embedded-in antenna design is used.

#### **3.3.3 Antenna Gain**

The antenna peak gain of EUT is less than 6 dBi. Therefore, it is not necessary to reduce maximum peak output power limit.



## 4 List of Measuring Equipment

Instrument	Manufacturer	Model No.	Serial No.	Characteristics	Calibration Date	Test Date	Due Date	Remark
Power Meter	Anritsu	ML2495A	0932001	N/A	Sep. 26, 2017	Feb. 07, 2018~ Feb. 26, 2018	Sep. 25, 2018	Conducted (TH05-HY)
Power Sensor	Anritsu	MA2411B	0846202	300MHz~40GHz z	Sep. 26, 2017	Feb. 07, 2018~ Feb. 26, 2018	Sep. 25, 2018	Conducted (TH05-HY)
Spectrum Analyzer	Rohde & Schwarz	FSP30	101067	9kHz ~ 30GHz	Nov. 13, 2017	Feb. 07, 2018~ Feb. 26, 2018	Nov. 12, 2018	Conducted (TH05-HY)
Amplifier	MITEQ	TTA1840-35-HG	1871923	18GHz~40GHz, VSWR : 2.5:1 max	Jul. 18, 2017	Mar. 08, 2018~ Mar. 14, 2018	Jul. 17, 2018	Radiation (03CH12-HY)
Bilog Antenna	TESEQ	CBL 6111D&N-6-0 6	35414&AT- N0602	30MHz~1GHz	Oct. 14, 2017	Mar. 08, 2018~ Mar. 14, 2018	Oct. 13, 2018	Radiation (03CH12-HY)
Loop Antenna	Rohde & Schwarz	HFH2-Z2	100488	9 kHz~30 MHz	Nov. 23, 2017	Mar. 08, 2018~ Mar. 14, 2018	Nov. 22, 2019	Radiation (03CH12-HY)
EMI Test Receiver	Rohde & Schwarz	ESU26	100390	20Hz~26.5GHz	Dec. 25, 2017	Mar. 08, 2018~ Mar. 14, 2018	Dec. 24, 2018	Radiation (03CH12-HY)
Horn Antenna	SCHWARZBECK	BBHA 9120D	9120D-132 8	1GHz ~ 18GHz	Oct. 20, 2017	Mar. 08, 2018~ Mar. 14, 2018	Oct. 19, 2018	Radiation (03CH12-HY)
Preamplifier	COM-POWER	PA-103	161075	10MHz~1GHz	Mar. 23, 2017	Mar. 08, 2018~ Mar. 14, 2018	Mar. 22, 2018	Radiation (03CH12-HY)
Preamplifier	Keysight	83017A	MY532701 48	1GHz~26.5GHz	Jan. 15, 2018	Mar. 08, 2018~ Mar. 14, 2018	Jan. 14, 2019	Radiation (03CH12-HY)
Preamplifier	MITEQ	AMF-7D-0010 1800	2025787	1GHZ~18GHZ	Feb. 13, 2017	Mar. 08, 2018~ Mar. 14, 2018	Feb. 12, 2019	Radiation (03CH12-HY)
Antenna Mast	EMEC	AM-BS-4500- B	N/A	1m~4m	N/A	Mar. 08, 2018~ Mar. 14, 2018	N/A	Radiation (03CH12-HY)
Turn Table	EMEC	TT2000	N/A	0~360 Degree	N/A	Mar. 08, 2018~ Mar. 14, 2018	N/A	Radiation (03CH12-HY)
Attenuator	Fairview Microwave	SA18S5W-10	n/a	10db	Mar. 24, 2017	Mar. 08, 2018~ Mar. 14, 2018	Mar. 23, 2018	Radiation (03CH12-HY)
Spectrum Analyzer	Keysight	N9010A	MY542004 86	10Hz~44GHz	Oct. 19, 2017	Mar. 08, 2018~ Mar. 14, 2018	Oct. 18, 2018	Radiation (03CH12-HY)



## 5 Uncertainty of Evaluation

### Uncertainty of Radiated Emission Measurement (30 MHz ~ 1000 MHz)

Measuring Uncertainty for a Level of Confidence of 95% ( $U = 2Uc(y)$ )	5.10
---	------

### Uncertainty of Radiated Emission Measurement (1000 MHz ~ 18000 MHz)

Measuring Uncertainty for a Level of Confidence of 95% ( $U = 2Uc(y)$ )	5.20
---	------

### Uncertainty of Radiated Emission Measurement (18000 MHz ~ 40000 MHz)

Measuring Uncertainty for a Level of Confidence of 95% ( $U = 2Uc(y)$ )	4.70
---	------

### Appendix A. Test Result of Conducted Test Items

Test Engineer:	Luffy Lin /Shiming Liu	Temperature:	21~25	°C
Test Date:	2018/2/7~2018/2/27	Relative Humidity:	51~54	%

<For 1Mbps>

**TEST RESULTS DATA**

**Peak Power Table**

Mod.	Data Rate	N <sub>TX</sub>	CH.	Freq. (MHz)	Peak Conducted Power (dBm)	Conducted Power Limit (dBm)
BLE	1Mbps	1	0	2402	12.85	30.00
BLE	1Mbps	1	19	2440	11.62	30.00
BLE	1Mbps	1	39	2480	11.47	30.00

**TEST RESULTS DATA**

**Average Power Table**

**(Reporting Only)**

Mod.	Data Rate	N <sub>TX</sub>	CH.	Freq. (MHz)	Duty Factor (dB)	Average Conducted Power (dBm)
BLE	1Mbps	1	0	2402	2.09	12.74
BLE	1Mbps	1	19	2440	2.09	11.55
BLE	1Mbps	1	39	2480	2.09	11.41

&lt;For 2Mbps&gt;

**TEST RESULTS DATA**  
**Peak Power Table**

Mod.	Data Rate	N <sub>TX</sub>	CH.	Freq. (MHz)	Peak Conducted Power (dBm)	Conducted Power Limit (dBm)
BLE5.0	2Mbps	1	0	2402	12.77	30.00
BLE5.0	2Mbps	1	19	2440	11.63	30.00
BLE5.0	2Mbps	1	39	2480	11.61	30.00

**TEST RESULTS DATA**  
**Average Power Table**  
**(Reporting Only)**

Mod.	Data Rate	N <sub>TX</sub>	CH.	Freq. (MHz)	Duty Factor (dB)	Average Conducted Power (dBm)
BLE5.0	2Mbps	1	0	2402	4.62	12.32
BLE5.0	2Mbps	1	19	2440	4.62	11.08
BLE5.0	2Mbps	1	39	2480	4.62	10.91



## Appendix B. Radiated Spurious Emission

Test Engineer :	Watt Tseng, Karl Hou, and Nick Yu	Temperature :	22~23°C
		Relative Humidity :	59~61%

<For 2Mbps>

2.4GHz 2400~2483.5MHz

BLE (Band Edge @ 3m)

BLE	Note	Frequency ( MHz )	Level ( dBμV/m )	Over Limit ( dB )	Limit Line ( dBμV/m )	Read Level ( dBμV )	Antenna Factor ( dB/m )	Path Loss ( dB )	Preamp Factor ( dB )	Ant Pos ( cm )	Table Pos ( deg )	Peak Avg. ( P/A )	Pol. ( H/V )
BLE CH 39 2480MHz	*	2480	103.07	-	-	93.15	27.36	14.12	31.56	298	53	P	H
	*	2480	101.81	-	-	91.89	27.36	14.12	31.56	298	53	A	H
		2483.88	57.13	-16.87	74	47.19	27.36	14.14	31.56	298	53	P	H
		2483.52	45.54	-8.46	54	35.6	27.36	14.14	31.56	298	53	A	H
													H
													H
	*	2480	104.49	-	-	94.57	27.36	14.12	31.56	212	86	P	V
	*	2480	102.78	-	-	92.86	27.36	14.12	31.56	212	86	A	V
		2483.52	57.56	-16.44	74	47.62	27.36	14.14	31.56	212	86	P	V
		2483.52	45.43	-8.57	54	35.49	27.36	14.14	31.56	212	86	A	V
													V
													V
Remark	1. No other spurious found. 2. All results are PASS against Peak and Average limit line.												



2.4GHz 2400~2483.5MHz  
BLE (Harmonic @ 3m)

BLE	Note	Frequency ( MHz )	Level ( dB $\mu$ V/m )	Over Limit ( dB )	Limit Line ( dB $\mu$ V/m )	Read Level ( dB $\mu$ V )	Antenna Factor ( dB/m )	Path Loss ( dB )	Preamp Factor ( dB )	Ant Pos ( cm )	Table Pos ( deg )	Peak Avg. ( P/A )	Pol. ( H/V )	
BLE CH 39 2480MHz		4960	40.1	-33.9	74	66.35	31.63	6.75	64.63	100	0	P	H	
		7440	44.75	-29.25	74	65.09	36.47	8.07	64.88	100	0	P	H	
													H	
													H	
		4960	39.33	-34.67	74	65.58	31.63	6.75	64.63	100	0	P	V	
		7440	43.73	-30.27	74	64.07	36.47	8.07	64.88	100	0	P	V	
														V
														V
Remark	1. No other spurious found. 2. All results are PASS against Peak and Average limit line.													



Emission below 1GHz

2.4GHz BLE (LF)

BLE	Note	Frequency	Level	Over	Limit	Read	Antenna	Path	Preamp	Ant	Table	Peak	Pol.	
		( MHz )	( dBμV/m )	( dB )	( dBμV/m )	( dBμV )	( dB/m )	( dB )	( dB )	( cm )	( deg )	( P/A )	( H/V )	
2.4GHz BLE LF		65.1	32.19	-7.81	40	50.11	11.79	0.72	30.43	-	-	P	H	
		71.58	32	-8	40	49.54	12.16	0.73	30.43	-	-	P	H	
		171.75	38.36	-5.14	43.5	52.19	15.22	1.26	30.31	100	0	P	H	
		347.6	31.86	-14.14	46	40.22	20.12	1.58	30.06	-	-	P	H	
		374.9	30.53	-15.47	46	38.14	20.81	1.6	30.02	-	-	P	H	
		723.5	29.57	-16.43	46	29.75	27.02	2.28	29.48	-	-	P	H	
													H	
													H	
													H	
													H	
													H	
													H	
			32.16	31.9	-8.1	40	38.43	23.24	0.44	30.21	-	-	P	V
			67.53	33.65	-6.35	40	51.45	11.9	0.73	30.43	-	-	P	V
			118.56	37.34	-6.16	43.5	49.59	17.21	0.92	30.38	100	0	P	V
			409.2	26.58	-19.42	46	32.8	22.08	1.66	29.96	-	-	P	V
			482	27.46	-18.54	46	31.98	23.47	1.83	29.82	-	-	P	V
			565.3	28.56	-17.44	46	30.35	25.89	2.03	29.71	-	-	P	V
														V
														V
													V	
													V	
													V	
													V	
<b>Remark</b>	1. No other spurious found. 2. All results are PASS against limit line.													





**Note symbol**

*	<b>Fundamental Frequency</b> which can be ignored. However, the level of any unwanted emissions shall not exceed the level of the fundamental frequency.
!	Test result is <b>over limit</b> line.
P/A	<b>Peak</b> or <b>Average</b>
H/V	<b>Horizontal</b> or <b>Vertical</b>



A calculation example for radiated spurious emission is shown as below:

BLE	Note	Frequency	Level	Over	Limit	Read	Antenna	Path	Preamp	Ant	Table	Peak	Pol.
		( MHz )	( dBμV/m )	( dB )	( dBμV/m )	( dBμV )	( dB/m )	( dB )	( dB )	( cm )	( deg )	( P/A )	( H/V )
BLE CH 00 2402MHz		2390	55.45	-18.55	74	54.51	32.22	4.58	35.86	103	308	P	H
		2390	43.54	-10.46	54	42.6	32.22	4.58	35.86	103	308	A	H

1. Path Loss(dB) = Cable loss(dB) + Filter loss(dB) + Attenuator loss(dB)
2. Level(dBμV/m) =  
Antenna Factor(dB/m) + Path Loss(dB) + Read Level(dBμV) - Preamp Factor(dB)
3. Over Limit(dB) = Level(dBμV/m) – Limit Line(dBμV/m)

**For Peak Limit @ 2390MHz:**

1. Level(dBμV/m)  
= Antenna Factor(dB/m) + Path Loss(dB) + Read Level(dBμV) - Preamp Factor(dB)  
= 32.22(dB/m) + 4.58(dB) + 54.51(dBμV) – 35.86 (dB)  
= 55.45 (dBμV/m)
2. Over Limit(dB)  
= Level(dBμV/m) – Limit Line(dBμV/m)  
= 55.45(dBμV/m) – 74(dBμV/m)  
= -18.55(dB)

**For Average Limit @ 2390MHz:**

1. Level(dBμV/m)  
= Antenna Factor(dB/m) + Path Loss(dB) + Read Level(dBμV) - Preamp Factor(dB)  
= 32.22(dB/m) + 4.58(dB) + 42.6(dBμV) – 35.86 (dB)  
= 43.54 (dBμV/m)
2. Over Limit(dB)  
= Level(dBμV/m) – Limit Line(dBμV/m)  
= 43.54(dBμV/m) – 54(dBμV/m)  
= -10.46(dB)

Both peak and average measured complies with the limit line, so test result is “PASS”.



## Appendix C. Radiated Spurious Emission Plots

Test Engineer :	Watt Tseng, Karl Hou, and Nick Yu	Temperature :	22~23°C
		Relative Humidity :	59~61%

### Note symbol

-L	Low channel location
-R	High channel location



2.4GHz 2400~2483.5MHz

BLE (Band Edge @ 3m)

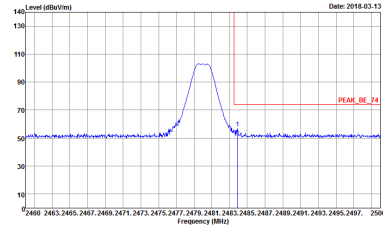
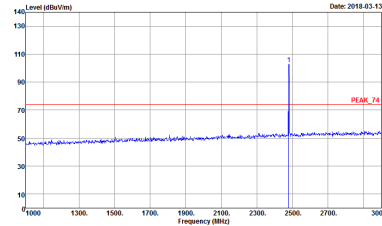
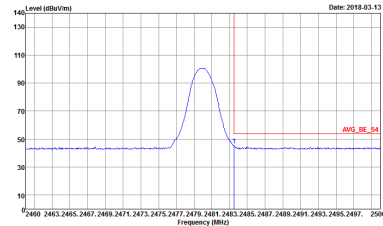
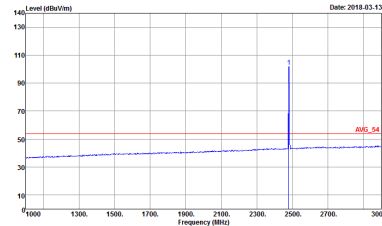
BLE	2.4GHz 2400~2483.5MHz Band Edge @ 3m	
ANT	BLE CH39 2480MHz	
1	Horizontal	Fundamental
Peak	 <p>Site : 03CH12-HY Condition : PEAK_BE_74 3m HORN_9120D_1328 HORIZONTAL : RBW:1000.000KHz VBW:3000.000KHz SWT:Auto</p>	 <p>Site : 03CH12-HY Condition : PEAK_74 3m HORN_9120D_1328 HORIZONTAL : RBW:1000.000KHz VBW:3000.000KHz SWT:Auto</p>
Avg.	 <p>Site : 03CH12-HY Condition : AVG_BE_54 3m HORN_9120D_1328 HORIZONTAL : RBW:1000.000KHz VBW:10.000KHz SWT:Auto</p>	 <p>Site : 03CH12-HY Condition : AVG_54 3m HORN_9120D_1328 HORIZONTAL : RBW:1000.000KHz VBW:10.000KHz SWT:Auto</p>

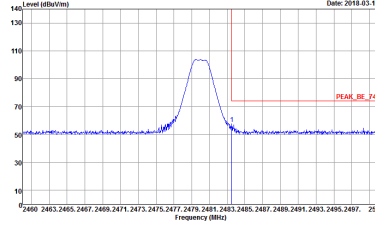
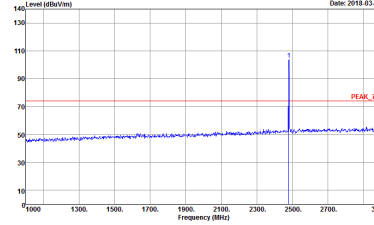
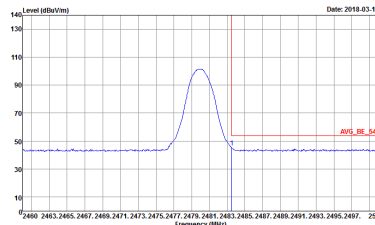
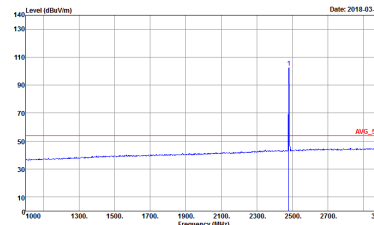

BLE	2.4GHz 2400~2483.5MHz Band Edge @ 3m	
ANT	BLE CH39 2480MHz	
1	Vertical	Fundamental
Peak	 <p>Site : 03CH12-HY Condition : PEAK_BE_74 3m HORN_9120D_1328 VERTICAL : RBW:1000.000KHz VBW:3000.000KHz SWT:Auto</p>	 <p>Site : 03CH12-HY Condition : PEAK_74 3m HORN_9120D_1328 VERTICAL : RBW:1000.000KHz VBW:3000.000KHz SWT:Auto</p>
Avg.	 <p>Site : 03CH12-HY Condition : AVG_BE_54 3m HORN_9120D_1328 VERTICAL : RBW:1000.000KHz VBW:10.000KHz SWT:Auto</p>	 <p>Site : 03CH12-HY Condition : AVG_54 3m HORN_9120D_1328 VERTICAL : RBW:1000.000KHz VBW:10.000KHz SWT:Auto</p>



2.4GHz 2400~2483.5MHz

BLE (Harmonic @ 3m)

<b>BLE</b>	<b>2.4GHz 2400~2483.5MHz Harmonic @ 3m</b>	
<b>ANT</b>	<b>BLE CH39 2480MHz</b>	
<b>1</b>	<b>Horizontal</b>	<b>Vertical</b>
<b>Peak</b>	<p>Site : 03CH12-HY Condition : PEAK_74 3m HORN_91200_1328 HORIZONTAL Detector : Peak</p>	<p>Site : 03CH12-HY Condition : PEAK_74 3m HORN_91200_1328 VERTICAL Detector : Peak</p>

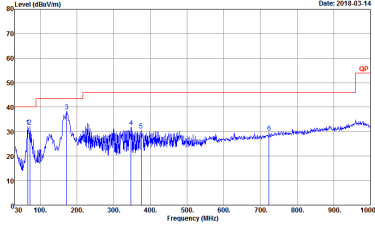
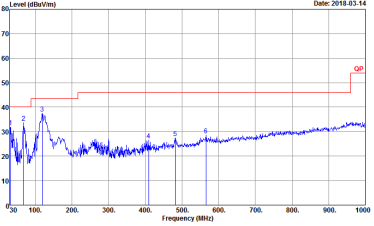

Emission below 1GHz  
2.4GHz BLE (LF)

BLE	2.4GHz 2400~2483.5MHz	
ANT	BLE LF	
1	Horizontal	Vertical
QP / Peak	 <p>Site : 03GH2-HY Condition : QP 3m BIL06_6111D_35414 HORIZONTAL Detector : Peak</p>	 <p>Site : 03GH2-HY Condition : QP 3m BIL06_6111D_35414 VERTICAL Detector : Peak</p>



## Appendix D. Duty Cycle Plots

Band	Duty Cycle(%)	T(us)	1/T(kHz)	VBW Setting	Duty Factor(dB)
Bluetooth -LE 1Mbps	61.78	388	2.58	3kHz	2.09
Bluetooth -LE 2Mbps	34.48	204	4.90	10kHz	4.62





### Bluetooth – LE 1Mbps

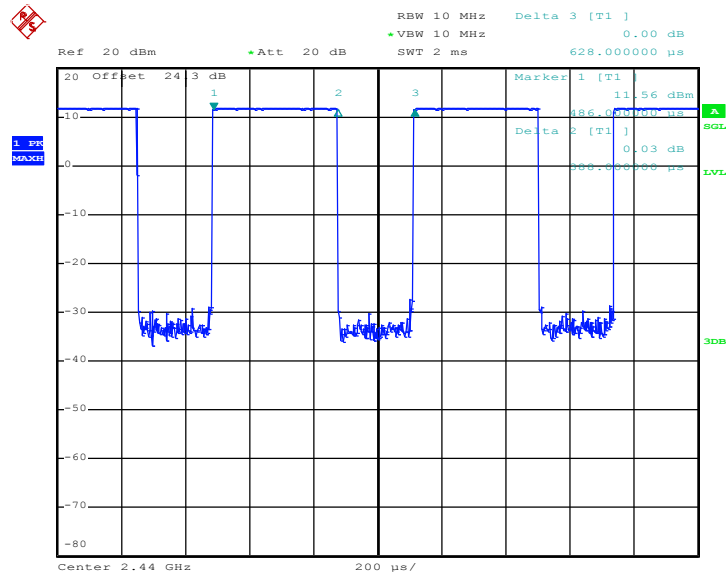

Date: 27.FEB.2018 00:26:04

### Bluetooth – LE 2Mbps

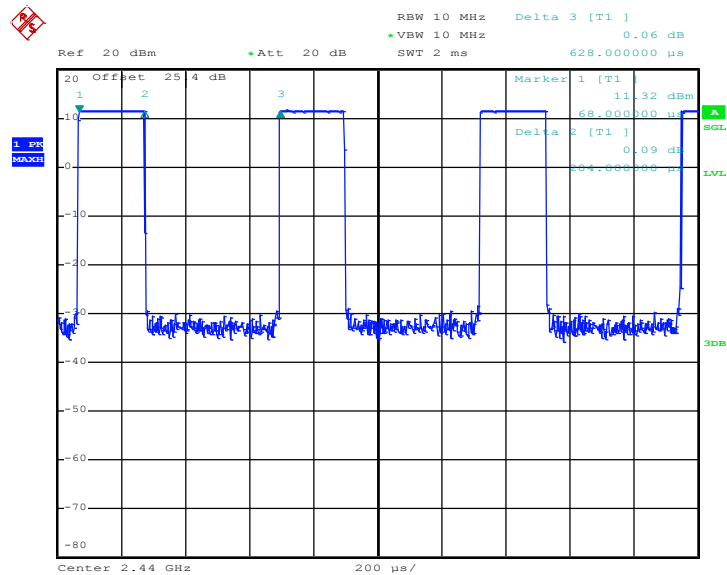

Date: 8.FEB.2018 01:06:37