



FCC RF Test Report

APPLICANT : Motorola Mobility LLC
EQUIPMENT : Mobile Cellular Phone
BRAND NAME : Motorola
MODEL NAME : XT1929-1(SS)
FCC ID : IHDT56XE2
STANDARD : FCC Part 15 Subpart E §15.407
CLASSIFICATION : (NII) Unlicensed National Information Infrastructure

The product was received on Jan. 18, 2018 and testing was completed on Mar. 05, 2018. We, SPORTON INTERNATIONAL INC., would like to declare that the tested sample has been evaluated in accordance with the test procedures and has been in compliance with the applicable technical standards.

The test results in this report apply exclusively to the tested model / sample. Without written approval of SPORTON INTERNATIONAL INC., the test report shall not be reproduced except in full.

Reviewed by: Joseph Lin / Supervisor

Approved by: Jones Tsai / Manager



SPORTON INTERNATIONAL INC.

No. 52, Hwa Ya 1st Rd., Hwa Ya Technology Park, Kwei-Shan District, Tao Yuan City, Taiwan, R.O.C.

SPORTON INTERNATIONAL INC.

TEL : 886-3-327-3456

FAX : 886-3-328-4978

FCC ID: IHDT56XE2

Page Number : 1 of 32

Report Issued Date : Mar. 09, 2018

Report Version : Rev. 01

Report Template No.: BU5-FR15EWLAC MA Version 2.0



TABLE OF CONTENTS

REVISION HISTORY..... 3

SUMMARY OF TEST RESULT 4

1 GENERAL DESCRIPTION 5

 1.1 Applicant 5

 1.2 Manufacturer 5

 1.3 Product Feature of Equipment Under Test 5

 1.4 Product Specification of Equipment Under Test 7

 1.5 Modification of EUT 7

 1.6 Testing Location 8

 1.7 Applicable Standards 8

2 TEST CONFIGURATION OF EQUIPMENT UNDER TEST 9

 2.1 Carrier Frequency and Channel 9

 2.2 Test Mode 10

 2.3 Connection Diagram of Test System 12

 2.4 Support Unit used in test configuration and system 13

 2.5 EUT Operation Test Setup 13

 2.6 Measurement Results Explanation Example 13

3 TEST RESULT 14

 3.1 26dB & 99% Occupied Bandwidth Measurement 14

 3.2 Maximum Conducted Output Power Measurement 16

 3.3 Power Spectral Density Measurement 18

 3.4 Unwanted Emissions Measurement 21

 3.5 AC Conducted Emission Measurement 27

 3.6 Automatically Discontinue Transmission 29

 3.7 Antenna Requirements 30

4 LIST OF MEASURING EQUIPMENT 31

5 UNCERTAINTY OF EVALUATION 32

APPENDIX A. CONDUCTED TEST RESULTS

APPENDIX B. AC CONDUCTED EMISSION TEST RESULT

APPENDIX C. RADIATED SPURIOUS EMISSION

APPENDIX D. RADIATED SPURIOUS EMISSION PLOTS

APPENDIX E. DUTY CYCLE PLOTS



REVISION HISTORY

REPORT NO.	VERSION	DESCRIPTION	ISSUED DATE
FR811821-02E	Rev. 01	Initial issue of report	Mar. 09, 2018



SUMMARY OF TEST RESULT

Report Section	FCC Rule	Description	Limit	Result	Remark
3.1	2.1049 & 15.403(i)	26dB & 99% Bandwidth	-	Pass	-
3.2	15.407(a)	Maximum Conducted Output Power	≤ 24 dBm	Pass	-
3.3	15.407(a)	Power Spectral Density	≤ 11 dBm	Pass	-
3.4	15.407(b)	Unwanted Emissions	15.407(b) & 15.209(a)	Pass	Under limit 3.09 dB at 16500.000 MHz
3.5	15.207	AC Conducted Emission	15.207(a)	Pass	Under limit 15.86 dB at 0.751 MHz
3.6	15.407(c)	Automatically Discontinue Transmission	Discontinue Transmission	Pass	-
3.7	15.203 & 15.407(a)	Antenna Requirement	N/A	Pass	-



1 General Description

1.1 Applicant

Motorola Mobility LLC
222 W,Merchandise Mart Plaza, Chicago IL 60654 USA

1.2 Manufacturer

Motorola Mobility LLC
222 W,Merchandise Mart Plaza, Chicago IL 60654 USA

1.3 Product Feature of Equipment Under Test

Product Feature	
Equipment	Mobile Cellular Phone
Brand Name	Motorola
Model Name	XT1929-1(SS)
FCC ID	IHDT56XE2
IMEI Code	Conducted : IMEI: 351885090004200 Conduction : IMEI: 351885090010991 Radiation : IMEI: 351885090010702
EUT supports Radios application	CDMA/EV-DO/GSM/EGPRS/WCDMA/HSPA/LTE/GNSS/NFC WLAN 11b/g/n HT20 WLAN 11a/n HT20/HT40 WLAN 11ac VHT20/VHT40/VHT80 Bluetooth BR/EDR/LE
HW Version	DVT2
EUT Stage	Identical Prototype

Remark: The above EUT's information was declared by manufacturer. Please refer to the specifications or user's manual for more detailed description.



Accessory List	
AC Adapter 1	Brand Name : Motorola
	Model Name : SC-22 SPN5970A
	Manufacturer : Salom
AC Adapter 2	Brand Name : Motorola
	Model Name : SC-22 SPN5993A
	Manufacturer : Chenyang
Battery	Brand Name : Motorola
	Model Name : JS40
	Manufacturer : SUNWODA
C2Audio Cable 1	Brand Name : Motorola
	Model Name : SC18C27844
	Manufacturer : Luxshare
C2Audio Cable 2	Brand Name : Motorola
	Model Name : SC18C27845
	Manufacturer : Cabletech
USB Cable 1	Brand Name : Cabletech
	Model Name : SKN6473A
USB Cable 2	Brand Name : FOXLINK
	Model Name : SKN6473A 17195-C 0403532
USB Cable 3	Brand Name : SAIBAO
	Model Name : SKN6473A 17214-C 1127044
USB Cable 4	Brand Name : Luxshare
	Model Name : SKN6473A 17227-C 1126538



1.4 Product Specification of Equipment Under Test

Standards-related Product Specification	
Tx/Rx Channel Frequency Range	5180 MHz ~ 5240 MHz 5260 MHz ~ 5320 MHz 5500 MHz ~ 5700 MHz
Maximum Output Power	<5180 MHz ~ 5240 MHz> 802.11a : 16.95 dBm / 0.0495 W 802.11n HT20 : 16.80 dBm / 0.0479 W 802.11n HT40 : 15.85 dBm / 0.0385 W 802.11ac VHT20 : 15.97 dBm / 0.0395 W 802.11ac VHT40 : 14.74 dBm / 0.0298 W 802.11ac VHT80 : 14.60 dBm / 0.0288 W <5260 MHz ~ 5320 MHz> 802.11a : 16.88 dBm / 0.0488 W 802.11n HT20 : 16.81 dBm / 0.0480 W 802.11n HT40 : 15.79 dBm / 0.0379 W 802.11ac VHT20 : 15.91 dBm / 0.0390 W 802.11ac VHT40 : 14.59 dBm / 0.0288 W 802.11ac VHT80 : 14.56 dBm / 0.0286 W <5500 MHz ~ 5700 MHz> 802.11a : 16.71 dBm / 0.0469 W 802.11n HT20 : 16.66 dBm / 0.0463 W 802.11n HT40 : 15.88 dBm / 0.0387 W 802.11ac VHT20 : 15.88 dBm / 0.0387 W 802.11ac VHT40 : 14.80 dBm / 0.0302 W 802.11ac VHT80 : 14.84 dBm / 0.0305 W
99% Occupied Bandwidth	802.11a : 17.70 MHz 802.11n HT20 : 18.70 MHz 802.11n HT40 : 36.70 MHz 802.11ac VHT80 : 75.84 MHz
Antenna Type / Gain	<5150 MHz ~ 5250 MHz> Loop Antenna with gain -6.50 dBi <5250 MHz ~ 5350 MHz> Loop Antenna with gain -6.50 dBi <5470 MHz ~ 5725 MHz> Loop Antenna with gain -7.00 dBi
Type of Modulation	802.11a/n : OFDM (BPSK / QPSK / 16QAM / 64QAM) 802.11ac : OFDM (BPSK / QPSK / 16QAM / 64QAM / 256QAM)

Note: The WLAN operation in 5600 MHz ~ 5650 MHz is notched.

1.5 Modification of EUT

No modifications are made to the EUT during all test items.



1.6 Testing Location

Sporton Lab is accredited to ISO 17025 by Taiwan Accreditation Foundation (TAF code : 1190) and the FCC designation No. TW1190 and TW0007 under the FCC 2.948(e) by Mutual Recognition Agreement (MRA) in FCC Test.

Test Site	SPORTON INTERNATIONAL INC.	
Test Site Location	No. 52, Hwa Ya 1st Rd., Hwa Ya Technology Park, Kwei-Shan District, Tao Yuan City, Taiwan, R.O.C. TEL: +886-3-327-3456 FAX: +886-3-328-4978	
Test Site No.	Sporton Site No.	
	TH05-HY	CO05-HY

Note: The test site complies with ANSI C63.4 2014 requirement.

Test Site	SPORTON INTERNATIONAL INC.	
Test Site Location	No.58, Aly. 75, Ln. 564, Wenhua 3rd Rd. Guishan Dist, Taoyuan City, Taiwan (R.O.C.) TEL: +886-3-327-3456 FAX: +886-3-328-4978	
Test Site No.	Sporton Site No.	
	03CH12-HY	

Note: The test site complies with ANSI C63.4 2014 requirement.

1.7 Applicable Standards

According to the specifications of the manufacturer, the EUT must comply with the requirements of the following standards:

- FCC Part 15 Subpart E
- FCC KDB 789033 D02 General UNII Test Procedures New Rules v02r01.
- ANSI C63.10-2013

Remark:

1. All test items were verified and recorded according to the standards and without any deviation during the test.
2. This EUT has also been tested and complied with the requirements of FCC Part 15, Subpart B, recorded in a separate test report.



2 Test Configuration of Equipment Under Test

- a. The EUT has been associated with peripherals and configuration operated in a manner tended to maximize its emission characteristics in a typical application. Frequency range investigated: conduction emission (150 kHz to 30 MHz), radiation emission (9 kHz to the 10th harmonic of the highest fundamental frequency or to 40 GHz, whichever is lower). For radiated measurement, pre-scanned in three orthogonal panels, X, Y, Z. The worst cases (X plane) were recorded in this report.
- b. AC power line Conducted Emission was tested under maximum output power.

2.1 Carrier Frequency and Channel

Frequency Band	Channel	Freq. (MHz)	Channel	Freq. (MHz)
5150-5250 MHz Band 1 (U-NII-1)	36	5180	44	5220
	38*	5190	46*	5230
	40	5200	48	5240
	42 [#]	5210		

Frequency Band	Channel	Freq. (MHz)	Channel	Freq. (MHz)
5250-5350 MHz Band 2 (U-NII-2A)	52	5260	60	5300
	54*	5270	62*	5310
	56	5280	64	5320
	58 [#]	5290		

Frequency Band	Channel	Freq. (MHz)	Channel	Freq. (MHz)
5470-5725 MHz Band 3 (U-NII-2C)	100	5500	112	5560
	102*	5510	116	5580
	104	5520	132	5660
	106 [#]	5530	134*	5670
	108	5540	136	5680
	110*	5550	140	5700

Note:

- 1. The above Frequency and Channel in "*" were 802.11n HT40 and 802.11ac VHT40.
- 2. The above Frequency and Channel in "[#]" were 802.11ac VHT80.



2.2 Test Mode

Final test modes are considering the modulation and worse data rates as below table.

Modulation	Data Rate
802.11a	6 Mbps
802.11n HT20	MCS0
802.11n HT40	MCS0
802.11ac VHT20 (Covered by HT20)	MCS0
802.11ac VHT40 (Covered by HT40)	MCS0
802.11ac VHT80	MCS0

Test Cases	
AC Conducted Emission	Mode 1 : GSM1900 Idle + Bluetooth Link + WLAN (5GHz) Link + MP3 + Battery + USB Cable 1 Type C (Charging from Adapter 1)
Remark: For Radiated Test Cases, The tests were performance with Adapter 1, and USB Cable 1 Type C.	



Ch. #		Band I : 5150-5250 MHz	Band II : 5250-5350 MHz	Band III : 5470-5725MHz
		802.11a	802.11a	802.11a
L	Low	36	52	100
M	Middle	44	60	116
H	High	48	64	140

Ch. #		Band I : 5150-5250 MHz	Band II : 5250-5350 MHz	Band III : 5470-5725MHz
		802.11n HT20	802.11n HT20	802.11n HT20
L	Low	36	52	100
M	Middle	44	60	116
H	High	48	64	140

Ch. #		Band I : 5150-5250 MHz	Band II : 5250-5350 MHz	Band III : 5470-5725MHz
		802.11n HT40	802.11n HT40	802.11n HT40
L	Low	38	54	102
M	Middle	-	-	110
H	High	46	62	134

Ch. #		Band I : 5150-5250 MHz	Band II : 5250-5350 MHz	Band III : 5470-5725MHz
		802.11ac VHT80	802.11ac VHT80	802.11ac VHT80
L	Low	-	-	106
M	Middle	42	58	-
H	High	-	-	-

2.3 Connection Diagram of Test System

<EUT with Adapter>

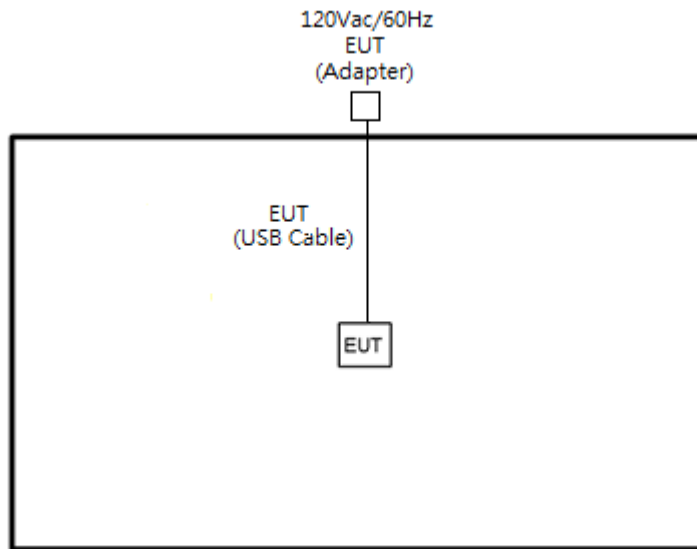

<AC Conducted Emission Mode>

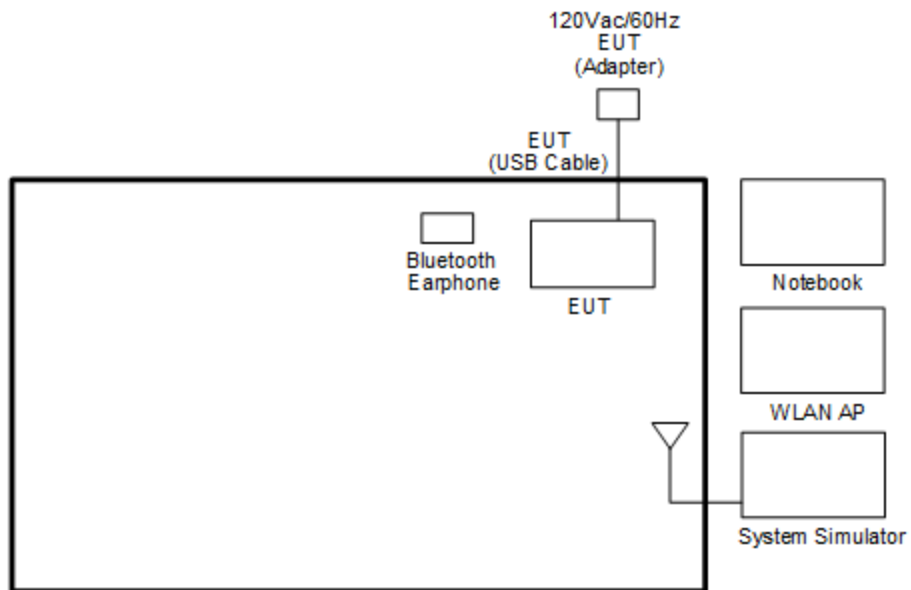



2.4 Support Unit used in test configuration and system

Item	Equipment	Trade Name	Model Name	FCC ID	Data Cable	Power Cord
1.	System Simulator	Anritsu	MT8820C	N/A	N/A	Unshielded, 1.8 m
2.	WLAN AP	ASUS	RT-AC66U	KA2DIR628A2	N/A	Unshielded, 1.8 m
3.	Notebook	DELL	Latitude E6320	FCC DoC/ Contains FCC ID: QDS-BRCM1054	N/A	AC I/P: Unshielded, 1.2 m DC O/P: Shielded, 1.8 m
4.	SD Card	SanDisk	MicroSD HC	FCC DoC	N/A	N/A
5.	Bluetooth Earphone	Lenovo	LBH 301	PYAHS-107W	N/A	N/A

2.5 EUT Operation Test Setup

The RF test items, utility “QRCT” was installed in Notebook which was programmed in order to make the EUT get into the engineering modes to provide channel selection, power level, data rate and the application type and for continuous transmitting signals.

2.6 Measurement Results Explanation Example

For all conducted test items:

The offset level is set in the spectrum analyzer to compensate the RF cable loss and attenuator factor between EUT conducted output port and spectrum analyzer. With the offset compensation, the spectrum analyzer reading level is exactly the EUT RF output level.

Example :

The spectrum analyzer offset is derived from RF cable loss and attenuator factor.

Offset = RF cable loss + attenuator factor.

Following shows an offset computation example with cable loss 4.2 dB and 10dB attenuator.

$$\begin{aligned} \text{Offset(dB)} &= \text{RF cable loss(dB)} + \text{attenuator factor(dB)}. \\ &= 4.2 + 10 = 14.2 \text{ (dB)} \end{aligned}$$

3 Test Result

3.1 26dB & 99% Occupied Bandwidth Measurement

3.1.1 Description of 26dB & 99% Occupied Bandwidth

This section is for reporting purpose only.

There is no restriction limits for bandwidth.

3.1.2 Measuring Instruments

The measuring equipment is listed in the section 4 of this test report.

3.1.3 Test Procedures

1. The testing follows FCC KDB 789033 D02 General UNII Test Procedures New Rules v02r01. Section C) Emission bandwidth
2. Set RBW = approximately 1% of the emission bandwidth.
3. Set the VBW > RBW.
4. Detector = Peak.
5. Trace mode = max hold
6. Measure the maximum width of the emission that is 26 dB down from the peak of the emission. Compare this with the RBW setting of the analyzer. Readjust RBW and repeat measurement as needed until the RBW/EBW ratio is approximately 1%.
7. For 99% Bandwidth Measurement, the spectrum analyzer's resolution bandwidth (RBW) is set 1MHz and set the Video bandwidth (VBW) $\geq 3 * RBW$.
8. Measure and record the results in the test report.

3.1.4 Test Setup

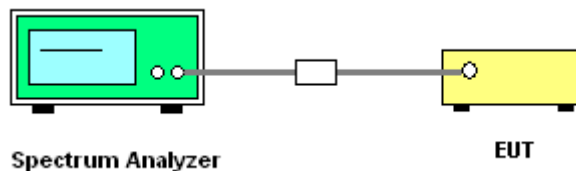

3.1.5 Test Result of 26dB & 99% Occupied Bandwidth

Please refer to Appendix A.

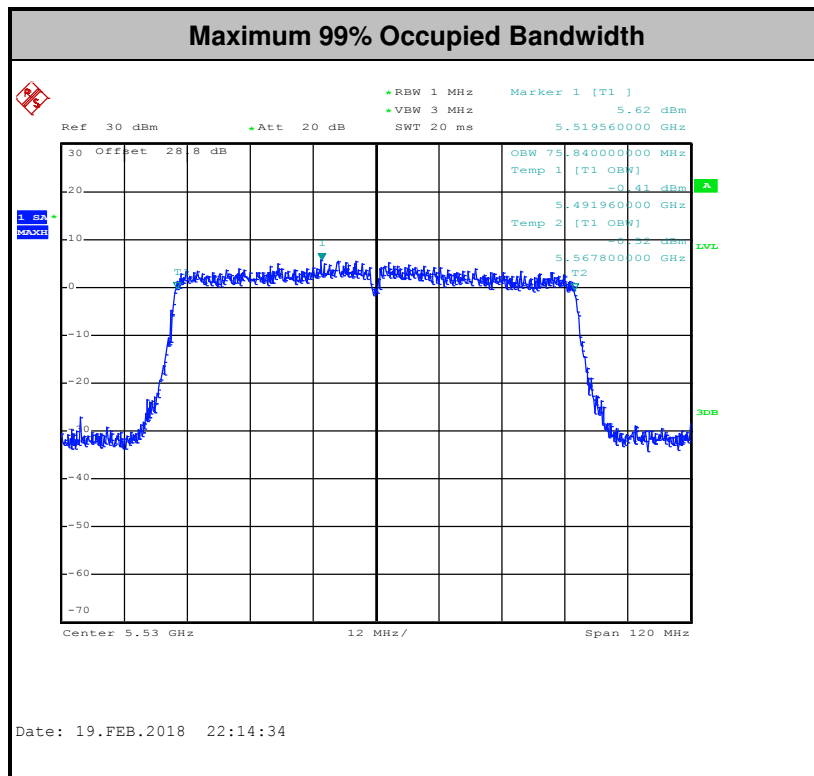
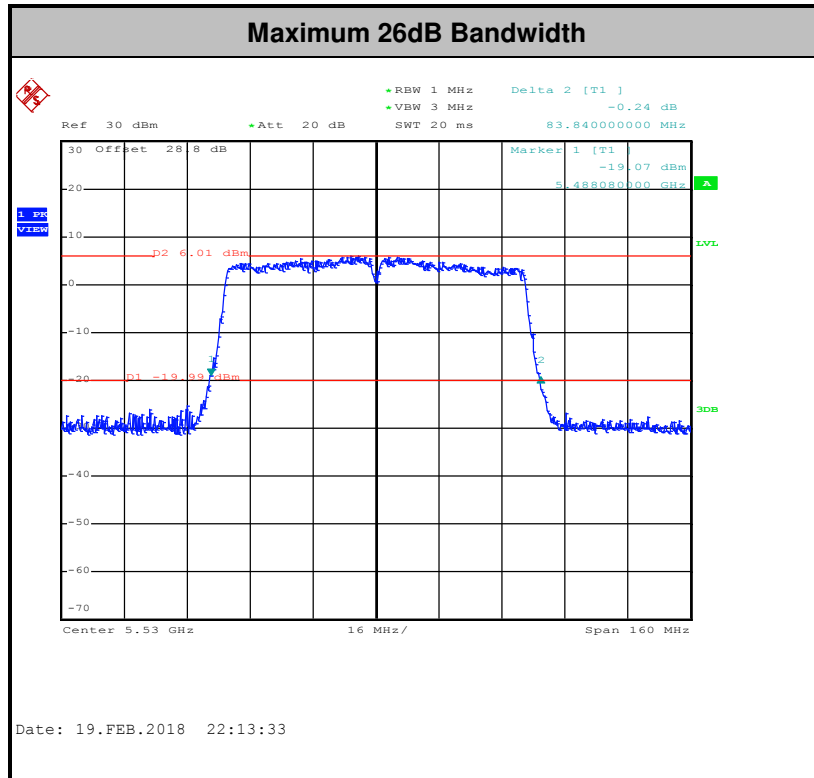

Note: The occupied channel bandwidth is maintained within the band of operation for all of the modulations.



3.2 Maximum Conducted Output Power Measurement

3.2.1 Limit of Maximum Conducted Output Power

<FCC 14-30 CFR 15.407>

For mobile and portable client devices in the 5.15–5.25 GHz band, the maximum conducted output power over the frequency band of operation shall not exceed 250 mW.

For the 5.25–5.725 GHz bands, the maximum conducted output power over the frequency bands of operation shall not exceed the lesser of 250 mW or 11 dBm $10 \log B$, where B is the 26 dB emission bandwidth in megahertz.

If transmitting antennas of directional gain greater than 6 dBi are used, the peak output power shall be reduced by the amount in dB that the directional gain of the antenna exceeds 6 dBi.

Note that U-NII-2 band, devices with a maximum e.i.r.p. greater than 500 mW shall implement TPC in order to have the capability to operate at least 6 dB below the maximum permitted e.i.r.p. of 1 W.

3.2.2 Measuring Instruments

The measuring equipment is listed in the section 4 of this test report.

3.2.3 Test Procedures

The testing follows Method PM of FCC KDB 789033 D02 General UNII Test Procedures New Rules v02r01.

Method PM (Measurement using an RF average power meter):

1. Measurement is performed using a wideband RF power meter.
2. The EUT is configured to transmit continuously with a consistent duty cycle at its maximum power control level.
3. Measure the average power of the transmitter, and the average power is corrected with duty factor, $10 \log(1/x)$, where x is the duty cycle.

3.2.4 Test Setup

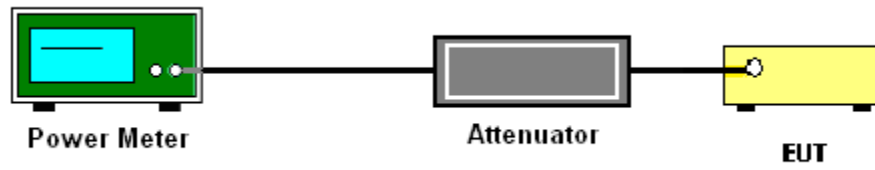

3.2.5 Test Result of Maximum Conducted Output Power

Please refer to Appendix A.



3.3 Power Spectral Density Measurement

3.3.1 Limit of Power Spectral Density

<FCC 14-30 CFR 15.407>

For an indoor access point operating in the band 5.15-5.25 GHz, the maximum power spectral density shall not exceed 17 dBm in any 1 megahertz band.

For the 5.25–5.725 GHz bands, the maximum power spectral density shall not exceed 11 dBm in any 1 megahertz band.

If transmitting antennas of directional gain greater than 6 dBi are used, the peak output power shall be reduced by the amount in dB that the directional gain of the antenna exceeds 6 dBi.

3.3.2 Measuring Instruments

The measuring equipment is listed in the section 4 of this test report.

3.3.3 Test Procedures

The testing follows FCC KDB 789033 D02 General UNII Test Procedures New Rules v02r01. Section F) Maximum power spectral density.

Method SA-2

(trace averaging across on and off times of the EUT transmissions, followed by duty cycle correction).

- Measure the duty cycle.
 - Set span to encompass the entire emission bandwidth (EBW) of the signal.
 - Set RBW = 1 MHz.
 - Set VBW \geq 3 MHz.
 - Number of points in sweep \geq 2 Span / RBW.
 - Sweep time = auto.
 - Detector = RMS
 - Trace average at least 100 traces in power averaging mode.
 - Add $10 \log(1/x)$, where x is the duty cycle, to the measured power in order to compute the average power during the actual transmission times. For example, add $10 \log(1/0.25) = 6$ dB if the duty cycle is 25 percent.
1. The RF output of EUT was connected to the spectrum analyzer by a low loss cable.
 2. Each plot has already offset with cable loss, and attenuator loss. Measure the PPSD and record it.

3.3.4 Test Setup

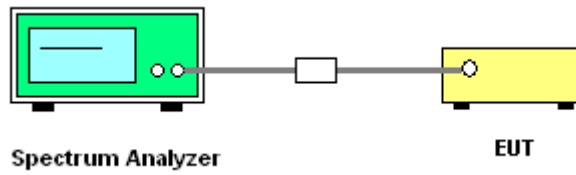

3.3.5 Test Result of Power Spectral Density

Please refer to Appendix A.

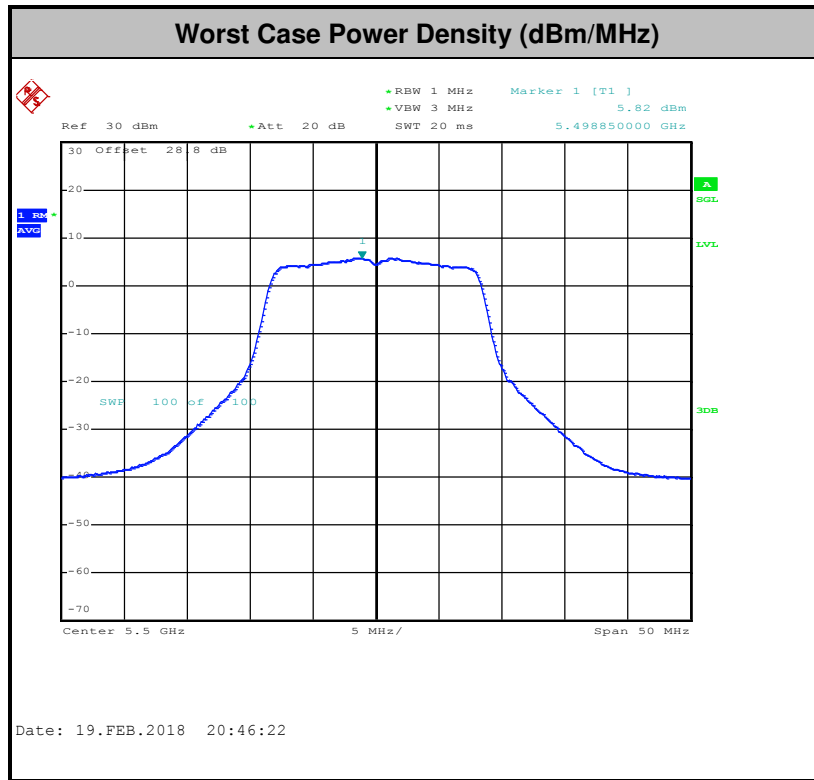

Note: Average Power Density (dB) = Measured value+ Duty Factor



3.4 Unwanted Emissions Measurement

This section is to measure unwanted emissions through radiated measurement for band edge spurious emissions and out of band emissions measurement.

3.4.1 Limit of Unwanted Emissions

- (1) For transmitters operating in the 5150-5250 MHz band: all emissions outside of the 5150-5350 MHz band shall not exceed an EIRP of -27dBm/MHz.

For transmitters operating in the 5250-5350 MHz band: all emissions outside of the 5150-5350 MHz band shall not exceed an EIRP of -27 dBm/MHz. Devices operating in the 5250-5350 MHz band that generate emissions in the 5150-5250 MHz band must meet all applicable technical requirements for operation in the 5150-5250 MHz band (including indoor use) or alternatively meet an out-of-band emission EIRP limit of -27 dBm/MHz in the 5150-5250 MHz band.

For transmitters operating in the 5470-5600 MHz and 5650-5725MHz band: all emissions outside of the 5470-5600 MHz and 5650-5725MHz band shall not exceed an EIRP of -27 dBm/MHz.

- (2) Unwanted spurious emissions fallen in restricted bands shall comply with the general field strength limits as below table,

Frequency (MHz)	Field Strength (microvolts/meter)	Measurement Distance (meters)
0.009 – 0.490	2400/F(kHz)	300
0.490 – 1.705	24000/F(kHz)	30
1.705 – 30.0	30	30
30 – 88	100	3
88 – 216	150	3
216 - 960	200	3
Above 960	500	3

Note: The following formula is used to convert the EIRP to field strength.

$$E = \frac{1000000\sqrt{30P}}{3} \mu\text{V/m, where P is the eirp (Watts)}$$



EIRP (dBm)	Field Strength at 3m (dBµV/m)
-17	78.3
- 27	68.3

(3) KDB789033 D02 v02r01 G)2)c)

- (i) Section 15.407(b)(1) to (b)(3) specify the unwanted emission limits for the U-NII-1 and U-NII-2 bands. As specified, emissions above 1000 MHz that are outside of the restricted bands are subject to a peak emission limit of -27 dBm/MHz.³
- (ii) Section 15.407(b)(4) specifies the unwanted emission limit for the U-NII-3 band. A band emissions mask is specified in Section 15.407(b)(4)(i). The emission limits are in terms of a Peak detector. An alternative to the band emissions mask is specified in Section 15.407(b)(4)(ii). The alternative limits are based on the highest antenna gain specified in the filing. There are also marketing and importation restrictions for the devices using the alternative limit.⁴

Note 3: An out-of-band emission that complies with both the average and peak limits of Section 15.209 is not required to satisfy the -27 dBm/MHz peak emission limit.

Note 4: Only devices with antenna gains of 10 dBi or less may be approved using the emission limits specified in Section 15.247(d) till March 2, 2018; all other devices operating in this band must use the mask specified in Section 15.407(b)(4)(i).



3.4.2 Measuring Instruments

The measuring equipment is listed in the section 4 of this test report.

3.4.3 Test Procedures

1. The testing follows FCC KDB 789033 D02 General UNII Test Procedures New Rules v02r01. Section G) Unwanted emissions measurement.

(1) Procedure for Unwanted Emissions Measurements Below 1000MHz

- RBW = 120 kHz
- VBW = 300 kHz
- Detector = Peak
- Trace mode = max hold

(2) Procedure for Peak Unwanted Emissions Measurements Above 1000 MHz

- RBW = 1 MHz
- VBW \geq 3 MHz
- Detector = Peak
- Sweep time = auto
- Trace mode = max hold

(3) Procedures for Average Unwanted Emissions Measurements Above 1000MHz

- RBW = 1 MHz
- VBW = 10 Hz, when duty cycle is no less than 98 percent.
- VBW \geq 1/T, when duty cycle is less than 98 percent where T is the minimum transmission duration over which the transmitter is on and is transmitting at its maximum power control level for the tested mode of operation.



2. The EUT was placed on a turntable with 0.8 meter for frequency below 1GHz and 1.5 meter for frequency above 1GHz respectively above ground.
3. The EUT was set 3 meters from the interference receiving antenna which was mounted on the top of a variable height antenna tower.
4. The antenna is a broadband antenna and its height is adjusted between one meter and four meters above ground to find the maximum value of the field strength for both horizontal polarization and vertical polarization of the antenna.
5. For each suspected emission, the EUT was arranged to its worst case and then adjust the antenna tower (from 1 m to 4 m) and turntable (from 0 degree to 360 degrees) to find the maximum reading.
6. For testing below 1GHz, if the emission level of the EUT in peak mode was 3 dB lower than the limit specified, then peak values of EUT will be reported, otherwise, the emissions will be repeated one by one using the CISPR quasi-peak method and reported.
7. For testing above 1GHz, the emission level of the EUT in peak mode was 20dB lower than average limit (that means the emission level in average mode also complies with the limit in average mode), then peak values of EUT will be reported, otherwise, the emissions will be measured in average mode again and reported.

3.4.4 Test Setup

For radiated emissions below 30MHz

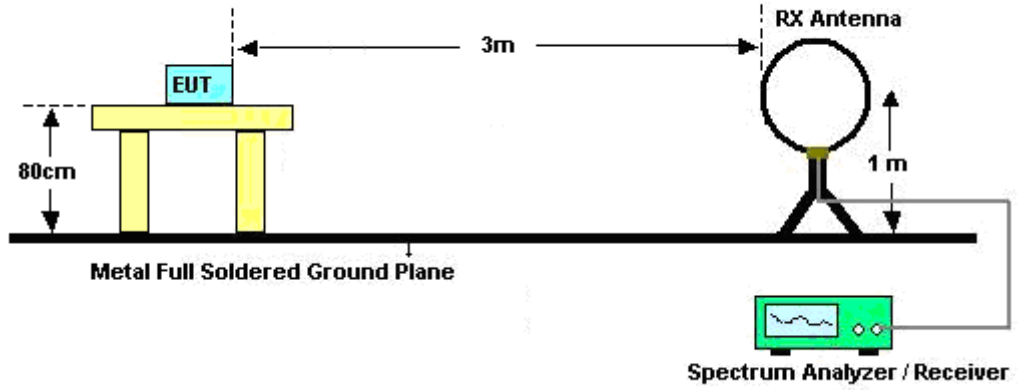

For radiated emissions from 30MHz to 1GHz

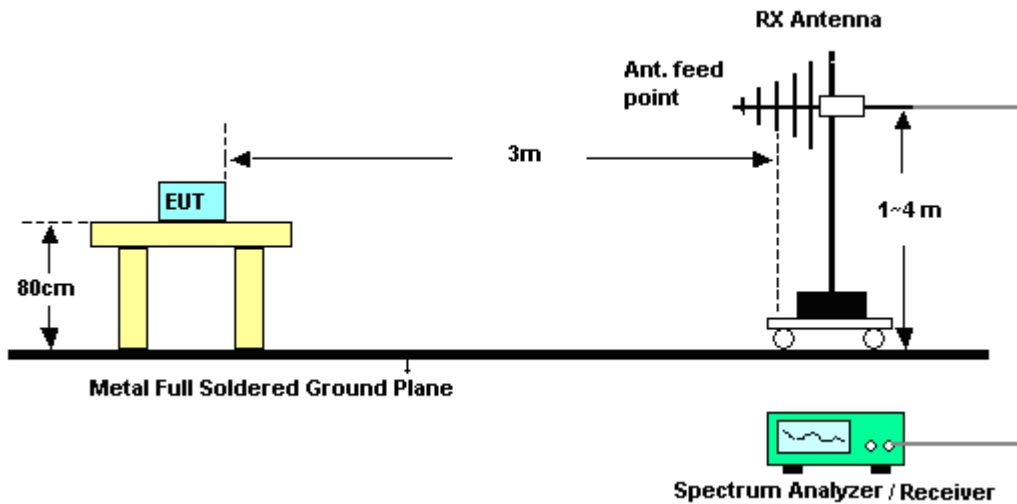

For radiated emissions above 1GHz

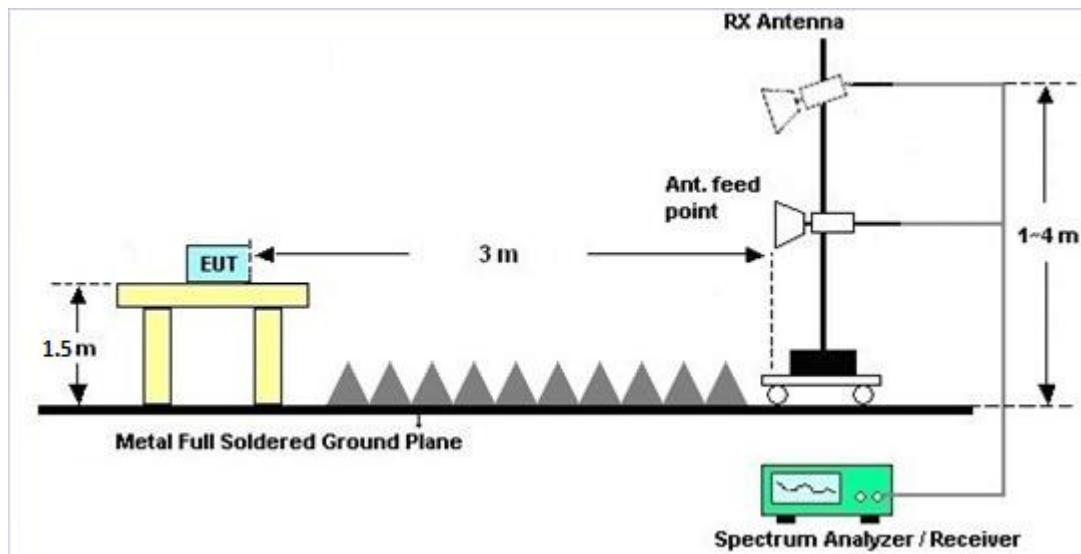

3.4.5 Test Results of Radiated Spurious Emissions (9 kHz ~ 30 MHz)

The low frequency, which started from 9 kHz to 30MHz, was pre-scanned and the result which was 20dB lower than the limit line was not reported.

There is a comparison data of both open-field test site and semi-Anechoic chamber, and the result came out very similar.

3.4.6 Test Result of Radiated Spurious at Band Edges

Please refer to Appendix C and D.

3.4.7 Duty Cycle

Please refer to Appendix E.

3.4.8 Test Result of Radiated Spurious Emissions (30MHz ~ 10th Harmonic)

Please refer to Appendix C and D.



3.5 AC Conducted Emission Measurement

3.5.1 Limit of AC Conducted Emission

For equipment that is designed to be connected to the public utility (AC) power line, the radio frequency voltage that is conducted back onto the AC power line on any frequency or frequencies within the band 150 kHz to 30 MHz shall not exceed the limits in the following table.

Frequency of emission (MHz)	Conducted limit (dB μ V)	
	Quasi-peak	Average
0.15-0.5	66 to 56*	56 to 46*
0.5-5	56	46
5-30	60	50

*Decreases with the logarithm of the frequency.

3.5.2 Measuring Instruments

The measuring equipment is listed in the section 4 of this test report.

3.5.3 Test Procedures

1. The EUT was placed 0.4 meter from the conducting wall of the shielding room was kept at least 80 centimeters from any other grounded conducting surface.
2. Connect EUT to the power mains through a line impedance stabilization network (LISN).
3. All the support units are connecting to the other LISN.
4. The LISN provides 50 ohm coupling impedance for the measuring instrument.
5. The FCC states that a 50 ohm, 50 microhenry LISN should be used.
6. Both sides of AC line were checked for maximum conducted interference.
7. The frequency range from 150 kHz to 30 MHz was searched.
8. Set the test-receiver system to Peak Detect Function and specified bandwidth with Maximum Hold Mode.

3.5.4 Test Setup

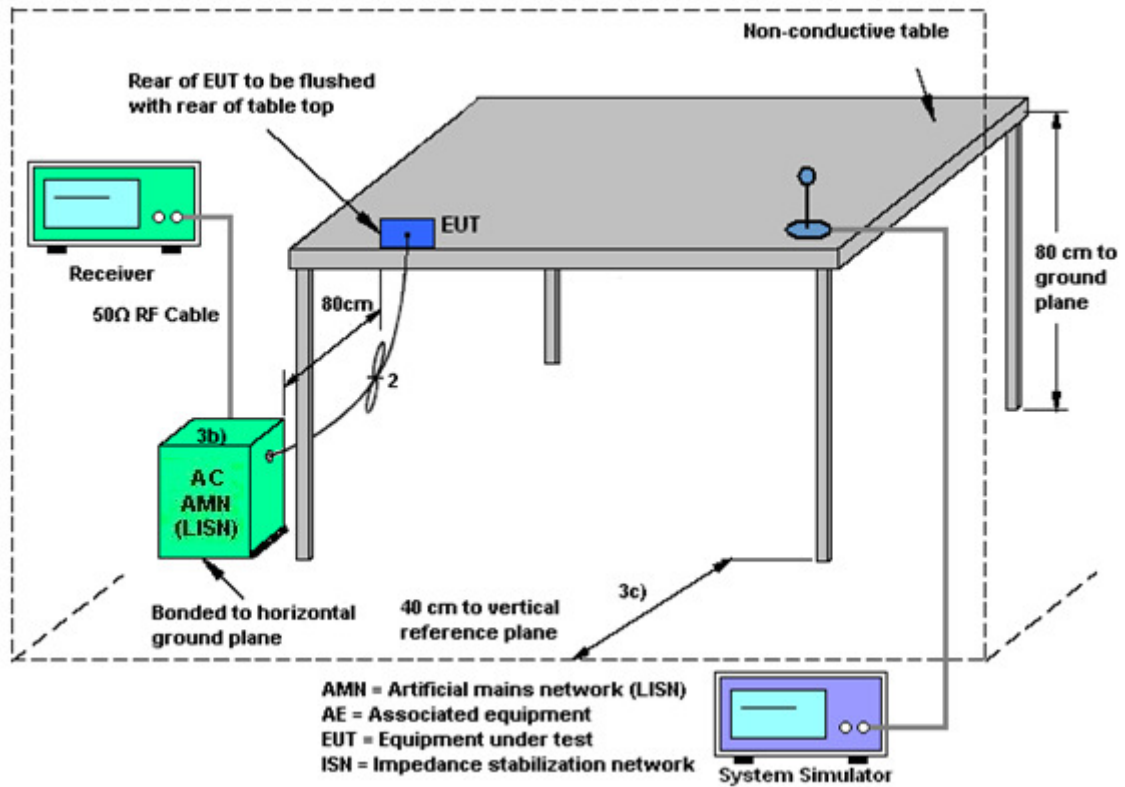

3.5.5 Test Result of AC Conducted Emission

Please refer to Appendix B.



3.6 Automatically Discontinue Transmission

3.6.1 Limit of Automatically Discontinue Transmission

The device shall automatically discontinue transmission in case of either absence of information to transmit or operational failure. These provisions are not intended to preclude the transmission of control or signaling information or the use of repetitive codes used by certain digital technologies to complete frame or burst intervals. Applicants shall include in their application for equipment authorization to describe how this requirement is met.

3.6.2 Measuring Instruments

The measuring equipment is listed in the section 4 of this test report.

3.6.3 Test Result of Automatically Discontinue Transmission

While the EUT is not transmitting any information, the EUT can automatically discontinue transmission and become standby mode for power saving. The EUT can detect the controlling signal of ACK message transmitting from remote device and verify whether it shall resend or discontinue transmission.



3.7 Antenna Requirements

3.7.1 Standard Applicable

If transmitting antenna directional gain is greater than 6 dBi, both the peak transmit power and the peak power spectral density shall be reduced by the amount in dB that the directional gain of the antenna exceeds 6 dBi.

3.7.2 Antenna Anti-Replacement Construction

An embedded-in antenna design is used.

3.7.3 Antenna Gain

The antenna peak gain of EUT is less than 6 dBi. Therefore, it is not necessary to reduce maximum peak output power limit.



4 List of Measuring Equipment

Instrument	Manufacturer	Model No.	Serial No.	Characteristics	Calibration Date	Test Date	Due Date	Remark
Power Meter	Anritsu	ML2495A	0932001	N/A	Sep. 26, 2017	Feb. 12, 2018~ Feb. 19, 2018	Sep. 25, 2018	Conducted (TH05-HY)
Power Sensor	Anritsu	MA2411B	0846202	300MHz~40GHz z	Sep. 26, 2017	Feb. 12, 2018~ Feb. 19, 2018	Sep. 25, 2018	Conducted (TH05-HY)
Spectrum Analyzer	Rohde & Schwarz	FSP30	101067	9kHz ~ 30GHz	Nov. 13, 2017	Feb. 12, 2018~ Feb. 19, 2018	Nov. 12, 2018	Conducted (TH05-HY)
AC Power Source	ChainTek	APC-1000W	N/A	N/A	N/A	Feb. 28, 2018	N/A	Conduction (CO05-HY)
EMI Test Receiver	Rohde & Schwarz	ESR3	102388	3.6GHz	Dec. 08, 2017	Feb. 28, 2018	Dec. 07, 2018	Conduction (CO05-HY)
LISN	Rohde & Schwarz	ENV216	100080	9kHz~30MHz	Nov. 30, 2017	Feb. 28, 2018	Nov. 29, 2018	Conduction (CO05-HY)
Amplifier	MITEQ	TTA1840-35-HG	1871923	18GHz~40GHz, VSWR : 2.5:1 max	Jul. 18, 2017	Feb. 27, 2018~ Mar. 05, 2018	Jul. 17, 2018	Radiation (03CH12-HY)
Bilog Antenna	TESEQ	CBL 6111D&00800 N1D01N-06	40103&07	30MHz~1GHz	Jan. 10, 2018	Feb. 27, 2018~ Mar. 05, 2018	Jan. 09, 2019	Radiation (03CH12-HY)
Loop Antenna	Rohde & Schwarz	HFH2-Z2	100488	9 kHz~30 MHz	Nov. 23, 2017	Feb. 27, 2018~ Mar. 05, 2018	Nov. 22, 2019	Radiation (03CH12-HY)
EMI Test Receiver	Rohde & Schwarz	ESU26	100390	20Hz~26.5GHz	Dec. 25, 2017	Feb. 27, 2018~ Mar. 05, 2018	Dec. 24, 2018	Radiation (03CH12-HY)
Horn Antenna	SCHWARZBECK	BBHA 9120D	9120D-132 8	1GHz ~ 18GHz	Oct. 20, 2017	Feb. 27, 2018~ Mar. 05, 2018	Oct. 19, 2018	Radiation (03CH12-HY)
Preamplifier	COM-POWER	PA-103	161075	10MHz~1GHz	Mar. 23, 2017	Feb. 27, 2018~ Mar. 05, 2018	Mar. 22, 2018	Radiation (03CH12-HY)
Preamplifier	Keysight	83017A	MY532701 48	1GHz~26.5GHz	Jan. 15, 2018	Feb. 27, 2018~ Mar. 05, 2018	Jan. 14, 2019	Radiation (03CH12-HY)
Preamplifier	MITEQ	AMF-7D-0010 1800	2025787	1GHz~18GHz	Feb. 13, 2017	Feb. 27, 2018~ Mar. 05, 2018	Feb. 12, 2019	Radiation (03CH12-HY)
Antenna Mast	EMEC	AM-BS-4500-B	N/A	1m~4m	N/A	Feb. 27, 2018~ Mar. 05, 2018	N/A	Radiation (03CH12-HY)
Turn Table	EMEC	TT2000	N/A	0~360 Degree	N/A	Feb. 27, 2018~ Mar. 05, 2018	N/A	Radiation (03CH12-HY)
Attenuator	Fairview Microwave	SA18S5W-10	n/a	10db	Mar. 24, 2017	Feb. 27, 2018~ Mar. 05, 2018	Mar. 23, 2018	Radiation (03CH12-HY)
SHF-EHF Horn Antenna	SCHWARZBECK	BBHA 9170	BBHA9170 576	18GHz ~ 40GHz	Apr. 27, 2017	Feb. 27, 2018~ Mar. 05, 2018	Apr. 26, 2018	Radiation (03CH12-HY)
Spectrum Analyzer	Keysight	N9010A	MY553705 26	10Hz~44GHz	Mar. 15, 2017	Feb. 27, 2018~ Mar. 05, 2018	Mar. 14, 2018	Radiation (03CH12-HY)



5 Uncertainty of Evaluation

Uncertainty of Conducted Emission Measurement (150kHz ~ 30MHz)

Measuring Uncertainty for a Level of Confidence of 95% ($U = 2Uc(y)$)	2.70
---	------

Uncertainty of Radiated Emission Measurement (30 MHz ~ 1000 MHz)

Measuring Uncertainty for a Level of Confidence of 95% ($U = 2Uc(y)$)	5.10
---	------

Uncertainty of Radiated Emission Measurement (1000 MHz ~ 18000 MHz)

Measuring Uncertainty for a Level of Confidence of 95% ($U = 2Uc(y)$)	5.20
---	------

Uncertainty of Radiated Emission Measurement (18000 MHz ~ 40000 MHz)

Measuring Uncertainty for a Level of Confidence of 95% ($U = 2Uc(y)$)	4.70
---	------

Appendix A. Test Result of Conducted Test Items

Test Engineer:	White Lin / Luffy Lin	Temperature:	21~25	°C
Test Date:	2018/2/12 ~ 2018/02/19	Relative Humidity:	51~54	%

TEST RESULTS DATA
26dB and 99% OBW

Band I										
Mod.	Data Rate	NTX	CH.	Freq. (MHz)	99% Bandwidth (MHz)	26 dB Bandwidth (MHz)	IC 99% Bandwidth Power Limit (dBm)	IC 99% Bandwidth EIRP Limit (dBm)		
11a	6Mbps	1	36	5180	17.70	24.96	-	22.48		
11a	6Mbps	1	44	5220	17.50	24.07	-	22.43		
11a	6Mbps	1	48	5240	17.45	23.70	-	22.42		
HT20	MCS0	1	36	5180	18.50	24.90	-	22.67		
HT20	MCS0	1	44	5220	18.50	25.00	-	22.67		
HT20	MCS0	1	48	5240	18.55	26.03	-	22.68		
HT40	MCS0	1	38	5190	36.50	42.12	-	23.01		
HT40	MCS0	1	46	5230	36.50	42.12	-	23.01		
VHT80	MCS0	1	42	5210	75.84	83.52	-	23.01		

TEST RESULTS DATA
Average Power Table

FCC Band I										
Mod.	Data Rate	NTX	CH.	Freq. (MHz)	Duty Factor (dB)	Average Conducted Power (dBm)	FCC Conducted Power Limit (dBm)	DG (dBi)		Pass/Fail
11a	6Mbps	1	36	5180	0.22	16.95	24.00	-6.50		Pass
11a	6Mbps	1	44	5220	0.22	16.85	24.00	-6.50		Pass
11a	6Mbps	1	48	5240	0.22	16.87	24.00	-6.50		Pass
HT20	MCS0	1	36	5180	0.25	16.80	24.00	-6.50		Pass
HT20	MCS0	1	44	5220	0.25	16.79	24.00	-6.50		Pass
HT20	MCS0	1	48	5240	0.25	16.78	24.00	-6.50		Pass
HT40	MCS0	1	38	5190	0.43	15.85	24.00	-6.50		Pass
HT40	MCS0	1	46	5230	0.43	15.75	24.00	-6.50		Pass
VHT20	MCS0	1	36	5180	0.26	15.97	24.00	-6.50		Pass
VHT20	MCS0	1	44	5220	0.26	15.92	24.00	-6.50		Pass
VHT20	MCS0	1	48	5240	0.26	15.93	24.00	-6.50		Pass
VHT40	MCS0	1	38	5190	0.43	14.74	24.00	-6.50		Pass
VHT40	MCS0	1	46	5230	0.43	14.60	24.00	-6.50		Pass
VHT80	MCS0	1	42	5210	0.65	14.60	24.00	-6.50		Pass

TEST RESULTS DATA
Power Spectral Density

FCC Band I										
Mod.	Data Rate	NTX	CH.	Freq. (MHz)	Duty Factor (dB)	Average Power Density (dBm/MHz)	Average PSD Limit (dBm/MHz)	DG (dBi)	-	Pass/Fail
11a	6Mbps	1	36	5180	0.22	4.84	11.00	-6.50		Pass
11a	6Mbps	1	44	5220	0.22	5.16	11.00	-6.50		Pass
11a	6Mbps	1	48	5240	0.22	5.28	11.00	-6.50		Pass
HT20	MCS0	1	36	5180	0.25	4.36	11.00	-6.50		Pass
HT20	MCS0	1	44	5220	0.25	4.65	11.00	-6.50		Pass
HT20	MCS0	1	48	5240	0.25	4.82	11.00	-6.50		Pass
HT40	MCS0	1	38	5190	0.43	0.47	11.00	-6.50		Pass
HT40	MCS0	1	46	5230	0.43	0.49	11.00	-6.50		Pass
VHT80	MCS0	1	42	5210	0.65	-3.83	11.00	-6.50		Pass

TEST RESULTS DATA
26dB and 99% OBW

Band II										
Mod.	Data Rate	NTX	CH.	Freq. (MHz)	99% Bandwidth (MHz)	26 dB Bandwidth (MHz)	IC 99% Bandwidth Power Limit (dBm)	IC 99% Bandwidth EIRP Limit (dBm)	FCC 26dB Bandwidth Power Limit (dBm)	Note
11a	6M bps	1	52	5260	17.55	24.23	23.44	29.44	23.98	
11a	6M bps	1	60	5300	17.70	23.80	23.48	29.48	23.98	
11a	6M bps	1	64	5320	17.55	24.17	23.44	29.44	23.98	
HT20	MCS 0	1	52	5260	18.50	24.73	23.67	29.67	23.98	
HT20	MCS 0	1	60	5300	18.70	25.40	23.72	29.72	23.98	
HT20	MCS 0	1	64	5320	18.55	25.46	23.68	29.68	23.98	
HT40	MCS 0	1	54	5270	36.50	41.58	23.98	30.00	23.98	
HT40	MCS 0	1	62	5310	36.60	42.66	23.98	30.00	23.98	
VHT80	MCS 0	1	58	5290	75.84	83.52	23.98	30.00	23.98	

TEST RESULTS DATA
Average Power Table

FCC Band II										
Mod.	Data Rate	NTX	CH.	Freq. (MHz)	Duty Factor (dB)	Average Conducted Power (dBm)	FCC Conducted Power Limit (dBm)	DG (dBi)	EIRP Power Limit (dBm)	Pass/Fail
11a	6M bps	1	52	5260	0.22	16.88	23.98	-6.50	26.99	Pass
11a	6M bps	1	60	5300	0.22	16.77	23.98	-6.50	26.99	Pass
11a	6M bps	1	64	5320	0.22	16.63	23.98	-6.50	26.99	Pass
HT20	MCS 0	1	52	5260	0.25	16.81	23.98	-6.50	26.99	Pass
HT20	MCS 0	1	60	5300	0.25	16.72	23.98	-6.50	26.99	Pass
HT20	MCS 0	1	64	5320	0.25	16.61	23.98	-6.50	26.99	Pass
HT40	MCS 0	1	54	5270	0.43	15.79	23.98	-6.50	26.99	Pass
HT40	MCS 0	1	62	5310	0.43	15.77	23.98	-6.50	26.99	Pass
VHT20	MCS 0	1	52	5260	0.26	15.91	23.98	-6.50	26.99	Pass
VHT20	MCS 0	1	60	5300	0.26	15.77	23.98	-6.50	26.99	Pass
VHT20	MCS 0	1	64	5320	0.26	15.67	23.98	-6.50	26.99	Pass
VHT40	MCS 0	1	54	5270	0.43	14.59	23.98	-6.50	26.99	Pass
VHT40	MCS 0	1	62	5310	0.43	14.51	23.98	-6.50	26.99	Pass
VHT80	MCS 0	1	58	5290	0.65	14.56	23.98	-6.50	26.99	Pass

TEST RESULTS DATA
Power Spectral Density

Band II										
Mod.	Data Rate	NTX	CH.	Freq. (MHz)	Duty Factor (dB)	Average Power Density (dBm/MHz)	Average PSD Limit (dBm/MHz)	DG (dBi)		Pass/Fail
11a	6M bps	1	52	5260	0.22	5.27	11.00	-6.50		Pass
11a	6M bps	1	60	5300	0.22	5.01	11.00	-6.50		Pass
11a	6M bps	1	64	5320	0.22	4.73	11.00	-6.50		Pass
HT20	MCS 0	1	52	5260	0.25	4.81	11.00	-6.50		Pass
HT20	MCS 0	1	60	5300	0.25	4.71	11.00	-6.50		Pass
HT20	MCS 0	1	64	5320	0.25	4.41	11.00	-6.50		Pass
HT40	MCS 0	1	54	5270	0.43	0.90	11.00	-6.50		Pass
HT40	MCS 0	1	62	5310	0.43	0.87	11.00	-6.50		Pass
VHT80	MCS 0	1	58	5290	0.65	-3.57	11.00	-6.50		Pass

TEST RESULTS DATA
26dB and 99% OBW

Band III										
Mod.	Data Rate	NTX	CH.	Freq. (MHz)	99% Bandwidth In UNII-2C (MHz)	26 dB Bandwidth In UNII-2C (MHz)	IC 99% Bandwidth Power Limit (dBm)	IC 99% Bandwidth EIRP Limit (dBm)	FCC 26dB Bandwidth Power Limit (dBm)	6dB Bandwidth for Straddle Channel (MHz)
11a	6M bps	1	100	5500	17.50	24.40	23.43	29.43	23.98	----
11a	6M bps	1	116	5580	17.50	25.00	23.43	29.43	23.98	----
11a	6M bps	1	140	5700	17.50	24.10	23.43	29.43	23.98	----
HT20	MCS 0	1	100	5500	18.50	25.10	23.67	29.67	23.98	----
HT20	MCS 0	1	116	5580	18.70	25.00	23.72	29.72	23.98	----
HT20	MCS 0	1	140	5700	18.55	25.26	23.68	29.68	23.98	----
HT40	MCS 0	1	102	5510	36.40	42.12	23.98	30.00	23.98	----
HT40	MCS 0	1	110	5550	36.60	41.76	23.98	30.00	23.98	----
HT40	MCS 0	1	134	5670	36.70	41.94	23.98	30.00	23.98	----
VHT80	MCS 0	1	106	5530	75.84	83.84	23.98	30.00	23.98	----

TEST RESULTS DATA
Average Power Table

FCC Band III										
Mod.	Data Rate	NTX	CH.	Freq. (MHz)	Duty Factor (dB)	Average Conducted Power (dBm)	FCC Conducted Power Limit (dBm)	DG (dBi)	EIRP Power Limit (dBm)	Pass/Fail
11a	6M bps	1	100	5500	0.22	16.71	23.98	-7.00	26.99	Pass
11a	6M bps	1	116	5580	0.22	16.58	23.98	-7.00	26.99	Pass
11a	6M bps	1	140	5700	0.22	16.61	23.98	-7.00	26.99	Pass
HT20	MCS 0	1	100	5500	0.25	16.66	23.98	-7.00	26.99	Pass
HT20	MCS 0	1	116	5580	0.25	16.53	23.98	-7.00	26.99	Pass
HT20	MCS 0	1	140	5700	0.25	16.56	23.98	-7.00	26.99	Pass
HT40	MCS 0	1	102	5510	0.43	15.88	23.98	-7.00	26.99	Pass
HT40	MCS 0	1	110	5550	0.43	15.75	23.98	-7.00	26.99	Pass
HT40	MCS 0	1	134	5670	0.43	15.79	23.98	-7.00	26.99	Pass
VHT20	MCS 0	1	100	5500	0.26	15.88	23.98	-7.00	26.99	Pass
VHT20	MCS 0	1	116	5580	0.26	15.80	23.98	-7.00	26.99	Pass
VHT20	MCS 0	1	140	5700	0.26	15.84	23.98	-7.00	26.99	Pass
VHT40	MCS 0	1	102	5510	0.43	14.80	23.98	-7.00	26.99	Pass
VHT40	MCS 0	1	110	5550	0.43	14.76	23.98	-7.00	26.99	Pass
VHT40	MCS 0	1	134	5670	0.43	14.68	23.98	-7.00	26.99	Pass
VHT80	MCS 0	1	106	5530	0.65	14.84	23.98	-7.00	26.99	Pass

TEST RESULTS DATA
Power Spectral Density

Band III										
Mod.	Data Rate	NTX	CH.	Freq. (MHz)	Duty Factor (dB)	Average Power Density (dBm/MHz)	Average PSD Limit (dBm/MHz)	DG (dBi)		Pass/Fail
11a	6M bps	1	100	5500	0.22	6.04	11.00	-7.00		Pass
11a	6M bps	1	116	5580	0.22	5.34	11.00	-7.00		Pass
11a	6M bps	1	140	5700	0.22	4.16	11.00	-7.00		Pass
HT20	MCS 0	1	100	5500	0.25	5.64	11.00	-7.00		Pass
HT20	MCS 0	1	116	5580	0.25	4.77	11.00	-7.00		Pass
HT20	MCS 0	1	140	5700	0.25	3.74	11.00	-7.00		Pass
HT40	MCS 0	1	102	5510	0.43	1.57	11.00	-7.00		Pass
HT40	MCS 0	1	110	5550	0.43	1.40	11.00	-7.00		Pass
HT40	MCS 0	1	134	5670	0.43	0.58	11.00	-7.00		Pass
VHT80	MCS 0	1	106	5530	0.65	-2.70	11.00	-7.00		Pass



Appendix B. AC Conducted Emission Test Results

Test Engineer :	Shareef Yu	Temperature :	22~23°C
		Relative Humidity :	58~62%

EUT Information

Report NO : 811821-02
 Test Mode : Mode 1
 Test Voltage : 120Vac/60Hz
 Phase : Line

Full Spectrum

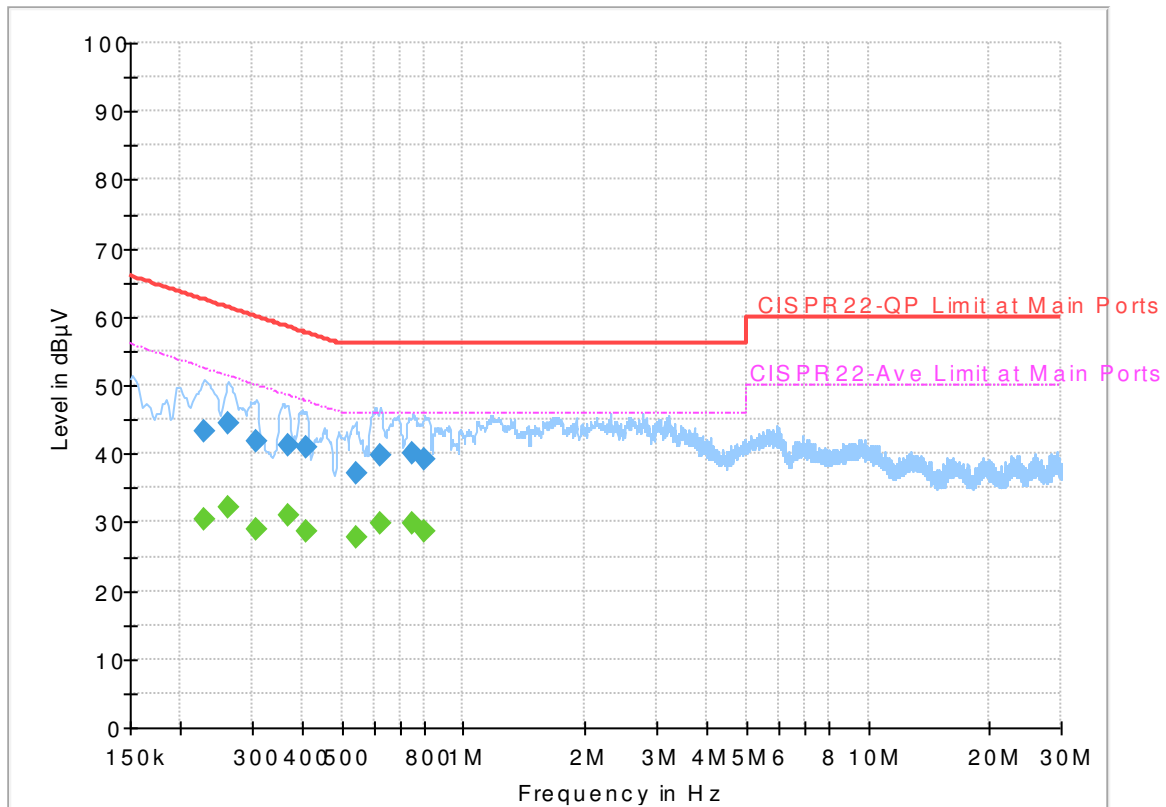

Final Result

Frequency (MHz)	QuasiPeak (dBµV)	Average (dBµV)	Limit (dBµV)	Margin (dB)	Line	Filter	Corr. (dB)
0.228750	---	30.45	52.50	22.05	L1	OFF	19.5
0.228750	43.21	---	62.50	19.29	L1	OFF	19.5
0.262500	---	32.03	51.35	19.32	L1	OFF	19.5
0.262500	44.42	---	61.35	16.93	L1	OFF	19.5
0.307500	---	28.95	50.04	21.09	L1	OFF	19.5
0.307500	41.86	---	60.04	18.18	L1	OFF	19.5
0.368250	---	30.94	48.54	17.60	L1	OFF	19.5
0.368250	41.29	---	58.54	17.25	L1	OFF	19.5
0.408750	---	28.74	47.67	18.93	L1	OFF	19.5
0.408750	40.82	---	57.67	16.85	L1	OFF	19.5
0.541500	---	27.74	46.00	18.26	L1	OFF	19.5
0.541500	37.02	---	56.00	18.98	L1	OFF	19.5
0.620250	---	29.75	46.00	16.25	L1	OFF	19.5
0.620250	39.84	---	56.00	16.16	L1	OFF	19.5
0.750750	---	29.70	46.00	16.30	L1	OFF	19.5
0.750750	40.14	---	56.00	15.86	L1	OFF	19.5
0.804750	---	28.58	46.00	17.42	L1	OFF	19.5
0.804750	39.16	---	56.00	16.84	L1	OFF	19.5

EUT Information

Report NO : 811821-02
 Test Mode : Mode 1
 Test Voltage : 120Vac/60Hz
 Phase : Neutral

Full Spectrum

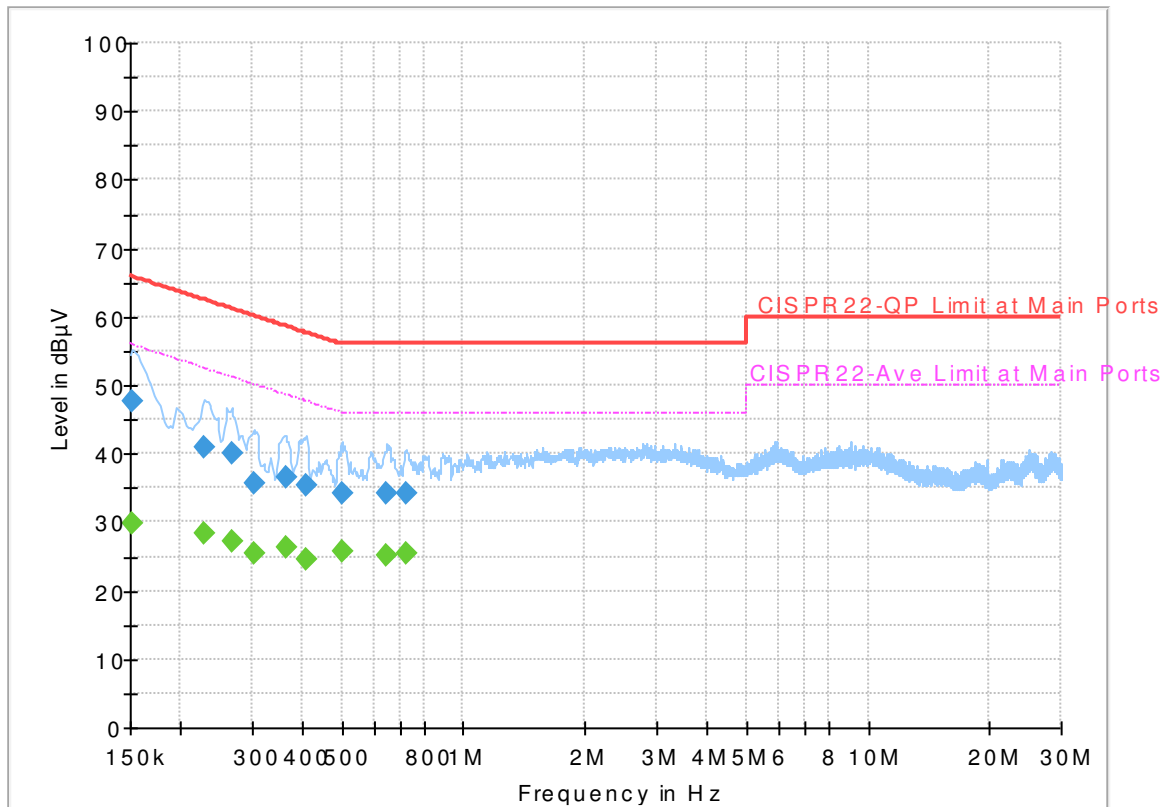

Final Result

Frequency (MHz)	QuasiPeak (dBµV)	Average (dBµV)	Limit (dBµV)	Margin (dB)	Line	Filter	Corr. (dB)
0.152250	---	29.69	55.88	26.19	N	OFF	19.5
0.152250	47.80	---	65.88	18.08	N	OFF	19.5
0.228750	---	28.38	52.50	24.12	N	OFF	19.5
0.228750	40.96	---	62.50	21.54	N	OFF	19.5
0.267000	---	27.30	51.21	23.91	N	OFF	19.5
0.267000	40.01	---	61.21	21.20	N	OFF	19.5
0.303000	---	25.48	50.16	24.68	N	OFF	19.5
0.303000	35.72	---	60.16	24.44	N	OFF	19.5
0.363750	---	26.41	48.64	22.23	N	OFF	19.5
0.363750	36.44	---	58.64	22.20	N	OFF	19.5
0.411000	---	24.54	47.63	23.09	N	OFF	19.5
0.411000	35.40	---	57.63	22.23	N	OFF	19.5
0.501000	---	25.74	46.00	20.26	N	OFF	19.5
0.501000	34.22	---	56.00	21.78	N	OFF	19.5
0.647250	---	25.10	46.00	20.90	N	OFF	19.5
0.647250	34.18	---	56.00	21.82	N	OFF	19.5
0.719250	---	25.50	46.00	20.50	N	OFF	19.5
0.719250	34.16	---	56.00	21.84	N	OFF	19.5



Appendix C. Radiated Spurious Emission

Test Engineer :	Watt Tseng, Karl Hou, and Nick Yu	Temperature :	21~23°C
		Relative Humidity :	57~60%

Band 1 - 5150~5250MHz
WIFI 802.11a (Band Edge @ 3m)

WIFI Ant.	Note	Frequency (MHz)	Level (dBμV/m)	Over Limit (dB)	Limit Line (dBμV/m)	Read Level (dBμV)	Antenna Factor (dB/m)	Path Loss (dB)	Preamp Factor (dB)	Ant Pos (cm)	Table Pos (deg)	Peak Avg. (P/A)	Pol. (H/V)	
802.11a CH 36 5180MHz		5141.44	61	-13	74	54.37	31.79	5.98	31.14	262	60	P	H	
		5149.5	44.25	-9.75	54	37.61	31.79	5.99	31.14	262	60	A	H	
	*	5180	110.64	-	-	103.95	31.81	6.02	31.14	262	60	P	H	
	*	5180	99.98	-	-	93.29	31.81	6.02	31.14	262	60	A	H	
													H	
			5144.3	57.53	-16.47	74	50.89	31.79	5.99	31.14	330	104	P	V
			5150	41.98	-12.02	54	35.34	31.79	5.99	31.14	330	104	A	V
	*		5180	109.12	-	-	102.43	31.81	6.02	31.14	330	104	P	V
	*		5180	98.34	-	-	91.65	31.81	6.02	31.14	330	104	A	V
														V
802.11a CH 44 5220MHz		5143.26	53.35	-20.65	74	46.71	31.79	5.99	31.14	260	61	P	H	
		5149.76	40.69	-13.31	54	34.05	31.79	5.99	31.14	260	61	A	H	
	*	5220	110.07	-	-	103.34	31.83	6.04	31.14	260	61	P	H	
	*	5220	99.46	-	-	92.73	31.83	6.04	31.14	260	61	A	H	
			5442.08	48.84	-25.16	74	41.84	31.96	6.19	31.15	260	61	P	H
			5423.04	37.78	-16.22	54	30.8	31.95	6.18	31.15	260	61	A	H
			5141.96	50.49	-23.51	74	43.86	31.79	5.98	31.14	345	102	P	V
			5148.2	39.07	-14.93	54	32.43	31.79	5.99	31.14	345	102	A	V
	*		5220	109.01	-	-	102.28	31.83	6.04	31.14	345	102	P	V
	*		5220	98.34	-	-	91.61	31.83	6.04	31.14	345	102	A	V
			5381.04	49.6	-24.4	74	42.67	31.93	6.15	31.15	345	102	P	V
			5415.76	37.67	-16.33	54	30.69	31.95	6.18	31.15	345	102	A	V



802.11a CH 48 5240MHz		5136.5	49.79	-24.21	74	43.17	31.78	5.98	31.14	259	59	P	H
		5147.94	38.93	-15.07	54	32.29	31.79	5.99	31.14	259	59	A	H
	*	5240	109.88	-	-	103.13	31.84	6.05	31.14	259	59	P	H
	*	5240	99.22	-	-	92.47	31.84	6.05	31.14	259	59	A	H
		5432	49.64	-24.36	74	42.64	31.96	6.19	31.15	259	59	P	H
		5395.32	37.76	-16.24	54	30.81	31.94	6.16	31.15	259	59	A	H
		5146.38	49.81	-24.19	74	43.17	31.79	5.99	31.14	383	107	P	V
		5143.78	38.14	-15.86	54	31.5	31.79	5.99	31.14	383	107	A	V
	*	5240	109.18	-	-	102.43	31.84	6.05	31.14	383	107	P	V
	*	5240	98.66	-	-	91.91	31.84	6.05	31.14	383	107	A	V
		5456.08	49.14	-24.86	74	42.11	31.97	6.21	31.15	383	107	P	V
		5428.36	37.88	-16.12	54	30.9	31.95	6.18	31.15	383	107	A	V
Remark	1. No other spurious found. 2. All results are PASS against Peak and Average limit line.												



Band 1 5150~5250MHz
WIFI 802.11a (Harmonic @ 3m)

WIFI Ant. 1	Note	Frequency (MHz)	Level (dBμV/m)	Over Limit (dB)	Limit Line (dBμV/m)	Read Level (dBμV)	Antenna Factor (dB/m)	Path Loss (dB)	Preamp Factor (dB)	Ant Pos (cm)	Table Pos (deg)	Peak Avg. (P/A)	Pol. (H/V)
802.11a CH 36 5180MHz		10360	47.91	-26.09	74	63.46	39.86	9.79	65.2	100	0	P	H
		15540	60.76	-13.24	74	73.98	38.53	12.23	63.98	131	301	P	H
		15540	44.89	-9.11	54	58.11	38.53	12.23	63.98	131	301	A	H
													H
		10360	48.31	-25.69	74	63.86	39.86	9.79	65.2	100	0	P	V
		15540	65.51	-8.49	74	78.73	38.53	12.23	63.98	118	338	P	V
		15540	49.17	-4.83	54	62.39	38.53	12.23	63.98	118	338	A	V
													V
802.11a CH 44 5220MHz		10440	47.53	-26.47	74	62.93	39.98	9.82	65.2	100	0	P	H
		15660	61.46	-12.54	74	75.13	38.29	12.28	64.24	134	302	P	H
		15660	46.18	-7.82	54	59.85	38.29	12.28	64.24	134	302	A	H
													H
		10440	47.05	-26.95	74	62.45	39.98	9.82	65.2	100	0	P	V
		15660	67.09	-6.91	74	80.76	38.29	12.28	64.24	122	333	P	V
		15660	50.45	-3.55	54	64.12	38.29	12.28	64.24	122	333	A	V
													V
802.11a CH 48 5240MHz		10480	47.83	-26.17	74	63.11	40.07	9.85	65.2	100	0	P	H
		15720	61.69	-12.31	74	75.63	38.15	12.3	64.39	133	302	P	H
		15720	45.86	-8.14	54	59.8	38.15	12.3	64.39	133	302	A	H
													H
		10480	47.19	-26.81	74	62.47	40.07	9.85	65.2	100	0	P	V
		15720	66.42	-7.58	74	80.36	38.15	12.3	64.39	117	326	P	V
		15720	49.89	-4.11	54	63.83	38.15	12.3	64.39	117	326	A	V
													V
Remark	1. No other spurious found. 2. All results are PASS against Peak and Average limit line.												



Band 1 5150~5250MHz
WIFI 802.11n HT20 (Band Edge @ 3m)

WIFI Ant. 1	Note	Frequency (MHz)	Level (dBμV/m)	Over Limit (dB)	Limit Line (dBμV/m)	Read Level (dBμV)	Antenna Factor (dB/m)	Path Loss (dB)	Preamp Factor (dB)	Ant Pos (cm)	Table Pos (deg)	Peak Avg. (P/A)	Pol. (H/V)	
802.11n HT20 CH 36 5180MHz		5141.18	61.4	-12.6	74	54.77	31.79	5.98	31.14	260	61	P	H	
		5150	44.26	-9.74	54	37.62	31.79	5.99	31.14	260	61	A	H	
	*	5180	110.2	-	-	103.51	31.81	6.02	31.14	260	61	P	H	
	*	5180	99.23	-	-	92.54	31.81	6.02	31.14	260	61	A	H	
													H	
														H
			5139.62	59.43	-14.57	74	52.8	31.79	5.98	31.14	370	109	P	V
			5147.42	43.21	-10.79	54	36.57	31.79	5.99	31.14	370	109	A	V
		*	5180	108.83	-	-	102.14	31.81	6.02	31.14	370	109	P	V
		*	5180	97.65	-	-	90.96	31.81	6.02	31.14	370	109	A	V
													V	
													V	
802.11n HT20 CH 44 5220MHz		5146.9	55.08	-18.92	74	48.44	31.79	5.99	31.14	255	60	P	H	
		5149.76	40.85	-13.15	54	34.21	31.79	5.99	31.14	255	60	A	H	
		*	5220	110.04	-	-	103.31	31.83	6.04	31.14	255	60	P	H
		*	5220	98.9	-	-	92.17	31.83	6.04	31.14	255	60	A	H
			5404	49.41	-24.59	74	42.46	31.94	6.16	31.15	255	60	P	H
			5416.32	37.78	-16.22	54	30.8	31.95	6.18	31.15	255	60	A	H
			5146.64	50.39	-23.61	74	43.75	31.79	5.99	31.14	346	103	P	V
			5149.76	39.06	-14.94	54	32.42	31.79	5.99	31.14	346	103	A	V
		*	5220	108.7	-	-	101.97	31.83	6.04	31.14	346	103	P	V
		*	5220	97.58	-	-	90.85	31.83	6.04	31.14	346	103	A	V
		5412.96	49.48	-24.52	74	42.5	31.95	6.18	31.15	346	103	P	V	
		5365.36	37.6	-16.4	54	30.69	31.92	6.14	31.15	346	103	A	V	



802.11n HT20 CH 48 5240MHz		5143.78	50.67	-23.33	74	44.03	31.79	5.99	31.14	252	60	P	H
		5145.34	39.12	-14.88	54	32.48	31.79	5.99	31.14	252	60	A	H
	*	5240	109.59	-	-	102.84	31.84	6.05	31.14	252	60	P	H
	*	5240	98.56	-	-	91.81	31.84	6.05	31.14	252	60	A	H
		5393.64	48.92	-25.08	74	41.99	31.93	6.15	31.15	252	60	P	H
		5391.4	37.97	-16.03	54	31.04	31.93	6.15	31.15	252	60	A	H
		5134.94	49.68	-24.32	74	43.06	31.78	5.98	31.14	345	102	P	V
		5150	38.03	-15.97	54	31.39	31.79	5.99	31.14	345	102	A	V
	*	5240	108.51	-	-	101.76	31.84	6.05	31.14	345	102	P	V
	*	5240	97.38	-	-	90.63	31.84	6.05	31.14	345	102	A	V
		5370.4	49.2	-24.8	74	42.29	31.92	6.14	31.15	345	102	P	V
		5416.32	37.67	-16.33	54	30.69	31.95	6.18	31.15	345	102	A	V
Remark	1. No other spurious found. 2. All results are PASS against Peak and Average limit line.												



Band 1 5150~5250MHz
WIFI 802.11n HT20 (Harmonic @ 3m)

WIFI Ant. 1	Note	Frequency (MHz)	Level (dBμV/m)	Over Limit (dB)	Limit Line (dBμV/m)	Read Level (dBμV)	Antenna Factor (dB/m)	Path Loss (dB)	Preamp Factor (dB)	Ant Pos (cm)	Table Pos (deg)	Peak Avg. (P/A)	Pol. (H/V)	
802.11n HT20 CH 36 5180MHz		10360	48.5	-25.5	74	64.05	39.86	9.79	65.2	100	0	P	H	
		15540	62.11	-11.89	74	75.33	38.53	12.23	63.98	133	300	P	H	
		15540	43.69	-10.31	54	56.91	38.53	12.23	63.98	133	300	A	H	
													H	
			10360	48.32	-25.68	74	63.87	39.86	9.79	65.2	100	0	P	V
			15540	66.71	-7.29	74	79.93	38.53	12.23	63.98	125	107	P	V
			15540	48.44	-5.56	54	61.66	38.53	12.23	63.98	125	107	A	V
													V	
802.11n HT20 CH 44 5220MHz		10440	47.48	-26.52	74	62.88	39.98	9.82	65.2	100	0	P	H	
		15660	63.19	-10.81	74	76.86	38.29	12.28	64.24	133	357	P	H	
		15660	45.07	-8.93	54	58.74	38.29	12.28	64.24	133	357	A	H	
													H	
			10440	47.78	-26.22	74	63.18	39.98	9.82	65.2	100	0	P	V
			15660	68.48	-5.52	74	82.15	38.29	12.28	64.24	120	337	P	V
			15660	49.8	-4.2	54	63.47	38.29	12.28	64.24	120	337	A	V
													V	
802.11n HT20 CH 48 5240MHz		10480	47.76	-26.24	74	63.04	40.07	9.85	65.2	100	0	P	H	
		15720	59.08	-14.92	74	73.02	38.15	12.3	64.39	120	30	P	H	
		15720	41.19	-12.81	54	55.13	38.15	12.3	64.39	120	30	A	H	
													H	
			10480	47.08	-26.92	74	62.36	40.07	9.85	65.2	100	0	P	V
			15720	67.23	-6.77	74	81.17	38.15	12.3	64.39	114	332	P	V
			15720	48.94	-5.06	54	62.88	38.15	12.3	64.39	114	332	A	V
													V	
Remark	1. No other spurious found. 2. All results are PASS against Peak and Average limit line.													



Band 1 5150~5250MHz
WIFI 802.11n HT40 (Band Edge @ 3m)

WIFI Ant. 1	Note	Frequency (MHz)	Level (dBμV/m)	Over Limit (dB)	Limit Line (dBμV/m)	Read Level (dBμV)	Antenna Factor (dB/m)	Path Loss (dB)	Preamp Factor (dB)	Ant Pos (cm)	Table Pos (deg)	Peak Avg. (P/A)	Pol. (H/V)	
802.11n HT40 CH 38 5190MHz		5150	65.46	-8.54	74	58.82	31.79	5.99	31.14	255	61	P	H	
		5150	46.66	-7.34	54	40.02	31.79	5.99	31.14	255	61	A	H	
	*	5190	106.6	-	-	99.91	31.81	6.02	31.14	255	61	P	H	
	*	5190	96	-	-	89.31	31.81	6.02	31.14	255	61	A	H	
		5366.48	49.58	-24.42	74	42.67	31.92	6.14	31.15	255	61	P	H	
		5432.28	38.49	-15.51	54	31.49	31.96	6.19	31.15	255	61	A	H	
		5147.94	62.32	-11.68	74	55.68	31.79	5.99	31.14	351	103	P	V	
		5149.5	44.62	-9.38	54	37.98	31.79	5.99	31.14	351	103	A	V	
	*	5190	104.43	-	-	97.74	31.81	6.02	31.14	351	103	P	V	
	*	5190	93.87	-	-	87.18	31.81	6.02	31.14	351	103	A	V	
		5446.28	48.6	-25.4	74	41.59	31.97	6.19	31.15	351	103	P	V	
		5445.44	38.7	-15.3	54	31.7	31.96	6.19	31.15	351	103	A	V	
	802.11n HT40 CH 46 5230MHz		5147.42	58.47	-15.53	74	51.83	31.79	5.99	31.14	255	61	P	H
			5148.98	42.62	-11.38	54	35.98	31.79	5.99	31.14	255	61	A	H
*		5230	106.01	-	-	99.27	31.84	6.04	31.14	255	61	P	H	
*		5230	95.59	-	-	88.85	31.84	6.04	31.14	255	61	A	H	
		5356.68	49.4	-24.6	74	42.52	31.91	6.12	31.15	255	61	P	H	
		5388.88	38.91	-15.09	54	31.98	31.93	6.15	31.15	255	61	A	H	
		5145.34	54.52	-19.48	74	47.88	31.79	5.99	31.14	343	103	P	V	
		5148.98	40.66	-13.34	54	34.02	31.79	5.99	31.14	343	103	A	V	
*		5230	104.89	-	-	98.15	31.84	6.04	31.14	343	103	P	V	
*		5230	94.26	-	-	87.52	31.84	6.04	31.14	343	103	A	V	
	5389.44	49.43	-24.57	74	42.5	31.93	6.15	31.15	343	103	P	V		
	5384.12	38.87	-15.13	54	31.94	31.93	6.15	31.15	343	103	A	V		
Remark	1. No other spurious found. 2. All results are PASS against Peak and Average limit line.													



Band 1 5150~5250MHz
WIFI 802.11n HT40 (Harmonic @ 3m)

WIFI Ant. 1	Note	Frequency (MHz)	Level (dBμV/m)	Over Limit (dB)	Limit Line (dBμV/m)	Read Level (dBμV)	Antenna Factor (dB/m)	Path Loss (dB)	Preamp Factor (dB)	Ant Pos (cm)	Table Pos (deg)	Peak Avg. (P/A)	Pol. (H/V)
802.11n HT40 CH 38 5190MHz		10380	49.78	-24.22	74	65.29	39.89	9.8	65.2	100	0	P	H
		15570	46.91	-27.09	74	60.26	38.46	12.24	64.05	100	0	P	H
													H
													H
		10380	48.22	-25.78	74	63.73	39.89	9.8	65.2	100	0	P	V
		15570	58.06	-15.94	74	71.41	38.46	12.24	64.05	119	336	P	V
		15570	45.08	-8.92	54	58.43	38.46	12.24	64.05	119	336	A	V
													V
802.11n HT40 CH 46 5230MHz		10460	47.68	-26.32	74	63.04	40.01	9.83	65.2	100	0	P	H
		15690	47.45	-26.55	74	61.27	38.22	12.28	64.32	100	0	P	H
													H
													H
		10460	47.42	-26.58	74	62.78	40.01	9.83	65.2	100	0	P	V
		15690	58.44	-15.56	74	72.26	38.22	12.28	64.32	114	328	P	V
		15690	45.37	-8.63	54	59.19	38.22	12.28	64.32	114	328	A	V
													V
Remark	1. No other spurious found. 2. All results are PASS against Peak and Average limit line.												



Band 1 5150~5250MHz
WIFI 802.11ac VHT80 (Band Edge @ 3m)

WIFI Ant. 1	Note	Frequency (MHz)	Level (dBμV/m)	Over Limit (dB)	Limit Line (dBμV/m)	Read Level (dBμV)	Antenna Factor (dB/m)	Path Loss (dB)	Preamp Factor (dB)	Ant Pos (cm)	Table Pos (deg)	Peak Avg. (P/A)	Pol. (H/V)
802.11ac VHT80 CH 42 5210MHz		5150	63.44	-10.56	74	56.8	31.79	5.99	31.14	258	61	P	H
		5145.08	47.13	-6.87	54	40.49	31.79	5.99	31.14	258	61	A	H
	*	5210	101.85	-	-	95.13	31.83	6.03	31.14	258	61	P	H
	*	5210	91.5	-	-	84.78	31.83	6.03	31.14	258	61	A	H
		5364.8	49.62	-24.38	74	42.71	31.92	6.14	31.15	258	61	P	H
		5362.56	38.69	-15.31	54	31.78	31.92	6.14	31.15	258	61	A	H
		5150	59.53	-14.47	74	52.89	31.79	5.99	31.14	346	102	P	V
		5137.54	44.35	-9.65	54	37.73	31.78	5.98	31.14	346	102	A	V
	*	5210	100.05	-	-	93.33	31.83	6.03	31.14	346	102	P	V
	*	5210	90.02	-	-	83.3	31.83	6.03	31.14	346	102	A	V
		5403.16	49.71	-24.29	74	42.76	31.94	6.16	31.15	346	102	P	V
		5351.64	38.71	-15.29	54	31.83	31.91	6.12	31.15	346	102	A	V
Remark	1. No other spurious found. 2. All results are PASS against Peak and Average limit line.												



Band 1 5150~5250MHz
WIFI 802.11ac VHT80 (Harmonic @ 3m)

WIFI Ant. 1	Note	Frequency (MHz)	Level (dBμV/m)	Over Limit (dB)	Limit Line (dBμV/m)	Read Level (dBμV)	Antenna Factor (dB/m)	Path Loss (dB)	Preamp Factor (dB)	Ant Pos (cm)	Table Pos (deg)	Peak Avg. (P/A)	Pol. (H/V)	
802.11ac VHT80 CH 42 5210MHz		10420	47.17	-26.83	74	62.61	39.95	9.81	65.2	100	0	P	H	
		15630	46.76	-27.24	74	60.38	38.32	12.26	64.2	100	0	P	H	
													H	
													H	
			10420	47.58	-26.42	74	63.02	39.95	9.81	65.2	100	0	P	V
			15630	49.86	-24.14	74	63.48	38.32	12.26	64.2	100	0	P	V
														V
													V	
Remark	1. No other spurious found. 2. All results are PASS against Peak and Average limit line.													



Band 2 - 5250~5350MHz
WIFI 802.11a (Band Edge @ 3m)

WIFI	Note	Frequency	Level	Over	Limit	Read	Antenna	Path	Preamp	Ant	Table	Peak	Pol.
Ant.				Limit	Line	Level	Factor	Loss	Factor	Pos	Pos	Avg.	
1		(MHz)	(dBμV/m)	(dB)	(dBμV/m)	(dBμV)	(dB/m)	(dB)	(dB)	(cm)	(deg)	(P/A)	(H/V)
802.11a CH 52 5260MHz		5142.12	48.89	-25.11	74	42.26	31.79	5.98	31.14	256	60	P	H
		5147.56	38.18	-15.82	54	31.54	31.79	5.99	31.14	256	60	A	H
	*	5260	109.7	-	-	102.92	31.86	6.07	31.15	256	60	P	H
	*	5260	99.19	-	-	92.41	31.86	6.07	31.15	256	60	A	H
		5434.08	49.17	-24.83	74	42.17	31.96	6.19	31.15	256	60	P	H
		5351.04	38.38	-15.62	54	31.5	31.91	6.12	31.15	256	60	A	H
		5149.94	49.15	-24.85	74	42.51	31.79	5.99	31.14	381	108	P	V
		5145.18	38.05	-15.95	54	31.41	31.79	5.99	31.14	381	108	A	V
	*	5260	108.82	-	-	102.04	31.86	6.07	31.15	381	108	P	V
	*	5260	98.25	-	-	91.47	31.86	6.07	31.15	381	108	A	V
		5365.44	48.84	-25.16	74	41.93	31.92	6.14	31.15	381	108	P	V
		5360.88	38.06	-15.94	54	31.15	31.92	6.14	31.15	381	108	A	V
802.11a CH 60 5300MHz		5123.42	48.69	-25.31	74	42.08	31.78	5.97	31.14	257	62	P	H
		5144.5	37.78	-16.22	54	31.14	31.79	5.99	31.14	257	62	A	H
	*	5300	109.34	-	-	102.52	31.88	6.09	31.15	257	62	P	H
	*	5300	98.62	-	-	91.8	31.88	6.09	31.15	257	62	A	H
		5353.2	58.06	-15.94	74	51.18	31.91	6.12	31.15	257	62	P	H
		5350.56	41.43	-12.57	54	34.55	31.91	6.12	31.15	257	62	A	H
		5149.26	48.12	-25.88	74	41.48	31.79	5.99	31.14	372	108	P	V
		5140.76	37.61	-16.39	54	30.98	31.79	5.98	31.14	372	108	A	V
	*	5300	108.61	-	-	101.79	31.88	6.09	31.15	372	108	P	V
	*	5300	97.85	-	-	91.03	31.88	6.09	31.15	372	108	A	V
		5350.32	56.89	-17.11	74	50.01	31.91	6.12	31.15	372	108	P	V
		5352.24	40.85	-13.15	54	33.97	31.91	6.12	31.15	372	108	A	V



802.11a CH 64 5320MHz	*	5320	108.57	-	-	101.73	31.89	6.1	31.15	256	62	P	H
	*	5320	98.1	-	-	91.26	31.89	6.1	31.15	256	62	A	H
		5356.8	59.74	-14.26	74	52.86	31.91	6.12	31.15	256	62	P	H
		5350.4	42.3	-11.7	54	35.42	31.91	6.12	31.15	256	62	A	H
													H
													H
	*	5320	108.43	-	-	101.59	31.89	6.1	31.15	350	109	P	V
	*	5320	97.71	-	-	90.87	31.89	6.1	31.15	350	109	A	V
		5357.44	60.16	-13.84	74	53.28	31.91	6.12	31.15	350	109	P	V
		5350.4	42.45	-11.55	54	35.57	31.91	6.12	31.15	350	109	A	V
													V
													V
Remark	1. No other spurious found. 2. All results are PASS against Peak and Average limit line.												



Band 2 5250~5350MHz
WIFI 802.11a (Harmonic @ 3m)

WIFI Ant. 1	Note	Frequency (MHz)	Level (dBμV/m)	Over Limit (dB)	Limit Line (dBμV/m)	Read Level (dBμV)	Antenna Factor (dB/m)	Path Loss (dB)	Preamp Factor (dB)	Ant Pos (cm)	Table Pos (deg)	Peak Avg. (P/A)	Pol. (H/V)
802.11a CH 52 5260MHz		10520	48.85	-25.15	74	64.07	40.11	9.87	65.2	100	0	P	H
		15780	61.83	-12.17	74	75.97	38.05	12.32	64.51	132	302	P	H
		15780	45.96	-8.04	54	60.1	38.05	12.32	64.51	132	302	A	H
													H
		10520	48.2	-25.8	74	63.42	40.11	9.87	65.2	100	0	P	V
		15780	65.26	-8.74	74	79.4	38.05	12.32	64.51	120	324	P	V
		15780	50.13	-3.87	54	64.27	38.05	12.32	64.51	120	324	A	V
802.11a CH 60 5300MHz		10600	47.51	-26.49	74	62.61	40.18	9.9	65.18	100	0	P	H
		15900	60.81	-13.19	74	75.4	37.81	12.37	64.77	137	300	P	H
		15900	45.24	-8.76	54	59.83	37.81	12.37	64.77	137	300	A	H
													H
		10600	47.48	-26.52	74	62.58	40.18	9.9	65.18	100	0	P	V
		15900	64.49	-9.51	74	79.08	37.81	12.37	64.77	118	133	P	V
		15900	49.26	-4.74	54	63.85	37.81	12.37	64.77	118	133	A	V
802.11a CH 64 5320MHz		10640	47.38	-26.62	74	62.43	40.21	9.91	65.17	100	0	P	H
		15960	59.37	-14.63	74	74.24	37.67	12.38	64.92	136	300	P	H
		15960	44.23	-9.77	54	59.1	37.67	12.38	64.92	136	300	A	H
													H
		10640	48.06	-25.94	74	63.11	40.21	9.91	65.17	100	0	P	V
		15960	63.66	-10.34	74	78.53	37.67	12.38	64.92	117	135	P	V
		15960	47.72	-6.28	54	62.59	37.67	12.38	64.92	117	135	A	V
Remark	1. No other spurious found. 2. All results are PASS against Peak and Average limit line.												



Band 2 5250~5350MHz
WIFI 802.11n HT20 (Band Edge @ 3m)

WIFI Ant. 1	Note	Frequency (MHz)	Level (dBμV/m)	Over Limit (dB)	Limit Line (dBμV/m)	Read Level (dBμV)	Antenna Factor (dB/m)	Path Loss (dB)	Preamp Factor (dB)	Ant Pos (cm)	Table Pos (deg)	Peak Avg. (P/A)	Pol. (H/V)
802.11n HT20 CH 52 5260MHz		5003.4	48.62	-25.38	74	42.17	31.7	5.89	31.14	255	61	P	H
		5145.86	38.18	-15.82	54	31.54	31.79	5.99	31.14	255	61	A	H
	*	5260	109.23	-	-	102.45	31.86	6.07	31.15	255	61	P	H
	*	5260	98.39	-	-	91.61	31.86	6.07	31.15	255	61	A	H
		5355.12	49.25	-24.75	74	42.37	31.91	6.12	31.15	255	61	P	H
		5352.72	38.1	-15.9	54	31.22	31.91	6.12	31.15	255	61	A	H
		5140.42	48.56	-25.44	74	41.93	31.79	5.98	31.14	382	106	P	V
		5148.24	37.85	-16.15	54	31.21	31.79	5.99	31.14	382	106	A	V
	*	5260	108.38	-	-	101.6	31.86	6.07	31.15	382	106	P	V
	*	5260	97.36	-	-	90.58	31.86	6.07	31.15	382	106	A	V
		5428.8	49.4	-24.6	74	42.41	31.96	6.18	31.15	382	106	P	V
		5354.4	38	-16	54	31.12	31.91	6.12	31.15	382	106	A	V
802.11n HT20 CH 60 5300MHz		5141.1	50.14	-23.86	74	43.51	31.79	5.98	31.14	131	59	P	H
		5148.58	37.88	-16.12	54	31.24	31.79	5.99	31.14	131	59	A	H
	*	5300	109.97	-	-	103.15	31.88	6.09	31.15	131	59	P	H
	*	5300	98.93	-	-	92.11	31.88	6.09	31.15	131	59	A	H
		5355.84	57.91	-16.09	74	51.03	31.91	6.12	31.15	131	59	P	H
		5350.08	41.73	-12.27	54	34.85	31.91	6.12	31.15	131	59	A	H
		5110.5	49.4	-24.6	74	42.8	31.77	5.97	31.14	354	106	P	V
		5130.9	37.87	-16.13	54	31.25	31.78	5.98	31.14	354	106	A	V
	*	5300	107.14	-	-	100.32	31.88	6.09	31.15	354	106	P	V
	*	5300	97.52	-	-	90.7	31.88	6.09	31.15	354	106	A	V
	5350.08	54.55	-19.45	74	47.67	31.91	6.12	31.15	354	106	P	V	
	5352.96	39.84	-14.16	54	32.96	31.91	6.12	31.15	354	106	A	V	



802.11n HT20 CH 64 5320MHz	*	5320	109.61	-	-	102.77	31.89	6.1	31.15	100	61	P	H
	*	5320	98.5	-	-	91.66	31.89	6.1	31.15	100	61	A	H
		5354.56	59.97	-14.03	74	53.09	31.91	6.12	31.15	100	61	P	H
		5350.88	43.17	-10.83	54	36.29	31.91	6.12	31.15	100	61	A	H
													H
													H
	*	5320	108.18	-	-	101.34	31.89	6.1	31.15	391	102	P	V
	*	5320	97.15	-	-	90.31	31.89	6.1	31.15	391	102	A	V
		5354.4	58.52	-15.48	74	51.64	31.91	6.12	31.15	391	102	P	V
		5350.56	41.83	-12.17	54	34.95	31.91	6.12	31.15	391	102	A	V
													V
													V
Remark	1. No other spurious found. 2. All results are PASS against Peak and Average limit line.												



Band 2 5250~5350MHz
WIFI 802.11n HT20 (Harmonic @ 3m)

WIFI Ant. 1	Note	Frequency (MHz)	Level (dBμV/m)	Over Limit (dB)	Limit Line (dBμV/m)	Read Level (dBμV)	Antenna Factor (dB/m)	Path Loss (dB)	Preamp Factor (dB)	Ant Pos (cm)	Table Pos (deg)	Peak Avg. (P/A)	Pol. (H/V)	
802.11n HT20 CH 52 5260MHz		10520	47.68	-26.32	74	62.9	40.11	9.87	65.2	100	0	P	H	
		15780	62.95	-11.05	74	77.09	38.05	12.32	64.51	132	300	P	H	
		15780	44.42	-9.58	54	58.56	38.05	12.32	64.51	132	300	A	H	
													H	
			10520	48.29	-25.71	74	63.51	40.11	9.87	65.2	100	0	P	V
			15780	66.85	-7.15	74	80.99	38.05	12.32	64.51	115	332	P	V
			15780	48.89	-5.11	54	63.03	38.05	12.32	64.51	115	332	A	V
													V	
802.11n HT20 CH 60 5300MHz		10600	47.54	-26.46	74	62.64	40.18	9.9	65.18	100	0	P	H	
		15900	62.54	-11.46	74	77.13	37.81	12.37	64.77	134	300	P	H	
		15900	44.44	-9.56	54	59.03	37.81	12.37	64.77	134	300	A	H	
													H	
			10600	47.83	-26.17	74	62.93	40.18	9.9	65.18	100	0	P	V
			15900	66.23	-7.77	74	80.82	37.81	12.37	64.77	120	332	P	V
			15900	48.12	-5.88	54	62.71	37.81	12.37	64.77	120	332	A	V
													V	
802.11n HT20 CH 64 5320MHz		10640	47.78	-26.22	74	62.83	40.21	9.91	65.17	100	0	P	H	
		15960	61.42	-12.58	74	76.29	37.67	12.38	64.92	136	300	P	H	
		15960	43.56	-10.44	54	58.43	37.67	12.38	64.92	136	300	A	H	
													H	
			10640	47.88	-26.12	74	62.93	40.21	9.91	65.17	100	0	P	V
			15960	64.44	-9.56	74	79.31	37.67	12.38	64.92	109	334	P	V
			15960	46.31	-7.69	54	61.18	37.67	12.38	64.92	109	334	A	V
													V	
Remark	1. No other spurious found. 2. All results are PASS against Peak and Average limit line.													



Band 2 5250~5350MHz
WIFI 802.11n HT40 (Band Edge @ 3m)

WIFI Ant. 1	Note	Frequency (MHz)	Level (dBμV/m)	Over Limit (dB)	Limit Line (dBμV/m)	Read Level (dBμV)	Antenna Factor (dB/m)	Path Loss (dB)	Preamp Factor (dB)	Ant Pos (cm)	Table Pos (deg)	Peak Avg. (P/A)	Pol. (H/V)
802.11n HT40 CH 54 5270MHz		5149.94	50.07	-23.93	74	43.43	31.79	5.99	31.14	124	59	P	H
		5139.06	39.64	-14.36	54	33.02	31.78	5.98	31.14	124	59	A	H
	*	5270	106.52	-	-	99.73	31.86	6.08	31.15	124	59	P	H
	*	5270	96.05	-	-	89.26	31.86	6.08	31.15	124	59	A	H
		5352.48	55.76	-18.24	74	48.88	31.91	6.12	31.15	124	59	P	H
		5350.32	41.52	-12.48	54	34.64	31.91	6.12	31.15	124	59	A	H
		5132.26	48.85	-25.15	74	42.23	31.78	5.98	31.14	379	105	P	V
		5140.42	38.96	-15.04	54	32.33	31.79	5.98	31.14	379	105	A	V
	*	5270	105.11	-	-	98.32	31.86	6.08	31.15	379	105	P	V
	*	5270	94.43	-	-	87.64	31.86	6.08	31.15	379	105	A	V
		5353.44	54.86	-19.14	74	47.98	31.91	6.12	31.15	379	105	P	V
		5350.08	39.98	-14.02	54	33.1	31.91	6.12	31.15	379	105	A	V
802.11n HT40 CH 62 5310MHz		5059.5	49.2	-24.8	74	42.67	31.74	5.93	31.14	118	60	P	H
		5149.94	39.03	-14.97	54	32.39	31.79	5.99	31.14	118	60	A	H
	*	5310	106.46	-	-	99.62	31.89	6.1	31.15	118	60	P	H
	*	5310	95.86	-	-	89.02	31.89	6.1	31.15	118	60	A	H
		5353.2	62.64	-11.36	74	55.76	31.91	6.12	31.15	118	60	P	H
		5350.8	50.67	-3.33	54	43.79	31.91	6.12	31.15	118	60	A	H
		5137.36	48.78	-25.22	74	42.16	31.78	5.98	31.14	353	107	P	V
		5147.56	38.47	-15.53	54	31.83	31.79	5.99	31.14	353	107	A	V
	*	5310	104.74	-	-	97.9	31.89	6.1	31.15	353	107	P	V
	*	5310	94.03	-	-	87.19	31.89	6.1	31.15	353	107	A	V
	5353.2	58.81	-15.19	74	51.93	31.91	6.12	31.15	353	107	P	V	
	5350.08	47.98	-6.02	54	41.1	31.91	6.12	31.15	353	107	A	V	
Remark	1. No other spurious found. 2. All results are PASS against Peak and Average limit line.												



Band 2 5250~5350MHz
WIFI 802.11n HT40 (Harmonic @ 3m)

WIFI Ant. 1	Note	Frequency (MHz)	Level (dBμV/m)	Over Limit (dB)	Limit Line (dBμV/m)	Read Level (dBμV)	Antenna Factor (dB/m)	Path Loss (dB)	Preamp Factor (dB)	Ant Pos (cm)	Table Pos (deg)	Peak Avg. (P/A)	Pol. (H/V)
802.11n HT40 CH 54		10540	48.09	-25.91	74	63.27	40.13	9.88	65.19	100	0	P	H
		15810	49.52	-24.48	74	63.78	37.98	12.34	64.58	100	0	P	H
													H
													H
5270MHz		10540	49.03	-24.97	74	64.21	40.13	9.88	65.19	100	0	P	V
		15810	57.87	-16.13	74	72.13	37.98	12.34	64.58	119	331	P	V
		15810	45.43	-8.57	54	59.69	37.98	12.34	64.58	119	331	A	V
													V
802.11n HT40 CH 62		10620	46.91	-27.09	74	61.99	40.2	9.9	65.18	100	0	P	H
		15930	49.37	-24.63	74	64.09	37.74	12.39	64.85	100	0	P	H
													H
													H
5310MHz		10620	47.18	-26.82	74	62.26	40.2	9.9	65.18	100	0	P	V
		15930	57.93	-16.07	74	72.65	37.74	12.39	64.85	119	335	P	V
		15930	44.06	-9.94	54	58.78	37.74	12.39	64.85	119	335	A	V
													V
Remark	1. No other spurious found. 2. All results are PASS against Peak and Average limit line.												



Band 2 5250~5350MHz
WIFI 802.11ac VHT80 (Band Edge @ 3m)

WIFI Ant. 1	Note	Frequency (MHz)	Level (dBμV/m)	Over Limit (dB)	Limit Line (dBμV/m)	Read Level (dBμV)	Antenna Factor (dB/m)	Path Loss (dB)	Preamp Factor (dB)	Ant Pos (cm)	Table Pos (deg)	Peak Avg. (P/A)	Pol. (H/V)
802.11ac VHT80 CH 58 5290MHz		5148.24	48.82	-25.18	74	42.18	31.79	5.99	31.14	100	59	P	H
		5143.14	38.61	-15.39	54	31.97	31.79	5.99	31.14	100	59	A	H
	*	5290	100.19	-	-	93.38	31.87	6.09	31.15	100	59	P	H
	*	5290	89.8	-	-	82.99	31.87	6.09	31.15	100	59	A	H
		5355.12	57.92	-16.08	74	51.04	31.91	6.12	31.15	100	59	P	H
		5350.56	48.28	-5.72	54	41.4	31.91	6.12	31.15	100	59	A	H
		5122.4	48.2	-25.8	74	41.6	31.77	5.97	31.14	357	106	P	V
		5125.8	37.99	-16.01	54	31.37	31.78	5.98	31.14	357	106	A	V
	*	5290	97.09	-	-	90.28	31.87	6.09	31.15	357	106	P	V
	*	5290	86.79	-	-	79.98	31.87	6.09	31.15	357	106	A	V
		5355.12	53.34	-20.66	74	46.46	31.91	6.12	31.15	357	106	P	V
	5350.08	43.3	-10.7	54	36.42	31.91	6.12	31.15	357	106	A	V	
Remark	1. No other spurious found. 2. All results are PASS against Peak and Average limit line.												



Band 2 5250~5350MHz
WIFI 802.11ac VHT80 (Harmonic @ 3m)

WIFI Ant. 1	Note	Frequency (MHz)	Level (dBμV/m)	Over Limit (dB)	Limit Line (dBμV/m)	Read Level (dBμV)	Antenna Factor (dB/m)	Path Loss (dB)	Preamp Factor (dB)	Ant Pos (cm)	Table Pos (deg)	Peak Avg. (P/A)	Pol. (H/V)	
802.11ac VHT80 CH 58 5290MHz		10580	48.26	-25.74	74	63.37	40.17	9.9	65.18	100	0	P	H	
		15870	42.58	-31.42	74	57.12	37.84	12.35	64.73	100	0	P	H	
													H	
													H	
			10580	48.09	-25.91	74	63.2	40.17	9.9	65.18	100	0	P	V
			15870	43	-31	74	57.54	37.84	12.35	64.73	100	0	P	V
														V
													V	
Remark	1. No other spurious found. 2. All results are PASS against Peak and Average limit line.													



Band 3 - 5470~5725MHz
WIFI 802.11a (Band Edge @ 3m)

WIFI	Note	Frequency	Level	Over	Limit	Read	Antenna	Path	Preamp	Ant	Table	Peak	Pol.	
Ant.				Limit	Line	Level	Factor	Loss	Factor	Pos	Pos	Avg.		
1		(MHz)	(dBμV/m)	(dB)	(dBμV/m)	(dBμV)	(dB/m)	(dB)	(dB)	(cm)	(deg)	(P/A)	(H/V)	
802.11a CH 100 5500MHz		5452.08	53.45	-20.55	74	46.42	31.97	6.21	31.15	100	59	P	H	
		5467.76	55.01	-13.19	68.2	47.95	31.98	6.23	31.15	100	59	P	H	
		5458.8	41.99	-12.01	54	34.96	31.97	6.21	31.15	100	59	A	H	
	*	5500	108.78	-	-	101.69	32	6.24	31.15	100	59	P	H	
	*	5500	98.01	-	-	90.92	32	6.24	31.15	100	59	A	H	
														H
			5458.16	50.88	-23.12	74	43.85	31.97	6.21	31.15	400	92	P	V
			5469.68	52.06	-16.14	68.2	45	31.98	6.23	31.15	400	92	P	V
			5459.92	39.2	-14.8	54	32.17	31.97	6.21	31.15	400	92	A	V
	*		5500	107.17	-	-	100.08	32	6.24	31.15	400	92	P	V
	*		5500	96.17	-	-	89.08	32	6.24	31.15	400	92	A	V
														V
802.11a CH 116 5580MHz		5423.44	49.45	-24.55	74	42.47	31.95	6.18	31.15	100	65	P	H	
		5469.04	48.73	-19.47	68.2	41.67	31.98	6.23	31.15	100	65	P	H	
		5458.48	37.93	-16.07	54	30.9	31.97	6.21	31.15	100	65	A	H	
	*	5580	109.43	-	-	102.21	32.1	6.32	31.2	100	65	P	H	
	*	5580	98.99	-	-	91.77	32.1	6.32	31.2	100	65	A	H	
			5760.275	48.71	-19.49	68.2	41.26	32.36	6.37	31.28	100	65	P	H
			5450.08	49.06	-24.94	74	42.03	31.97	6.21	31.15	354	105	P	V
			5463.52	48.26	-19.94	68.2	41.22	31.98	6.21	31.15	354	105	P	V
			5445.04	38.08	-15.92	54	31.08	31.96	6.19	31.15	354	105	A	V
	*		5580	109.15	-	-	101.93	32.1	6.32	31.2	354	105	P	V
	*		5580	98.23	-	-	91.01	32.1	6.32	31.2	354	105	A	V
			5727.2	48.6	-19.6	68.2	41.18	32.31	6.37	31.26	354	105	P	V



802.11a CH 140 5700MHz	*	5700	109.03	-	-	101.65	32.27	6.36	31.25	113	60	P	H
	*	5700	98.3	-	-	90.92	32.27	6.36	31.25	113	60	A	H
		5725.64	59.59	-8.61	68.2	52.17	32.31	6.37	31.26	113	60	P	H
													H
													H
													H
	*	5700	107.08	-	-	99.7	32.27	6.36	31.25	373	109	P	V
	*	5700	96.31	-	-	88.93	32.27	6.36	31.25	373	109	A	V
		5725.64	57.01	-11.19	68.2	49.59	32.31	6.37	31.26	373	109	P	V
													V
													V
													V
Remark	1. No other spurious found. 2. All results are PASS against Peak and Average limit line.												



Band 3 - 5470~5725MHz
WIFI 802.11a (Harmonic @ 3m)

WIFI Ant. 1	Note	Frequency (MHz)	Level (dBμV/m)	Over Limit (dB)	Limit Line (dBμV/m)	Read Level (dBμV)	Antenna Factor (dB/m)	Path Loss (dB)	Preamp Factor (dB)	Ant Pos (cm)	Table Pos (deg)	Peak Avg. (P/A)	Pol. (H/V)
802.11a CH 100 5500MHz		11000	48.74	-25.26	74	63.26	40.5	10.08	65.1	100	0	P	H
		16500	43.45	-24.75	68.2	56.46	39.6	12.49	65.1	100	0	P	H
													H
													H
		11000	48.54	-25.46	74	63.06	40.5	10.08	65.1	100	0	P	V
		16500	43.19	-25.01	68.2	56.2	39.6	12.49	65.1	100	0	P	V
													V
													V
802.11a CH 116 5580MHz		11160	49.55	-24.45	74	64.22	40.37	10.16	65.2	100	0	P	H
		16740	51.02	-17.18	68.2	63.23	40.13	12.52	64.86	100	0	P	H
													H
													H
		11160	48.81	-25.19	74	63.48	40.37	10.16	65.2	100	0	P	V
		16740	55.55	-12.65	68.2	67.76	40.13	12.52	64.86	100	0	P	V
													V
													V
802.11a CH 140 5700MHz		11400	45.73	-28.27	74	60.6	40.18	10.29	65.34	100	0	P	H
		17100	48.28	-19.92	68.2	59.04	41.06	12.64	64.46	100	0	P	H
													H
													H
		11400	45	-29	74	59.87	40.18	10.29	65.34	100	0	P	V
		17100	47.17	-21.03	68.2	57.93	41.06	12.64	64.46	100	0	P	V
													V
													V
Remark	1. No other spurious found. 2. All results are PASS against Peak and Average limit line.												



Band 3 - 5470~5725MHz
WIFI 802.11n HT20 (Band Edge @ 3m)

WIFI Ant. 1	Note	Frequency (MHz)	Level (dBμV/m)	Over Limit (dB)	Limit Line (dBμV/m)	Read Level (dBμV)	Antenna Factor (dB/m)	Path Loss (dB)	Preamp Factor (dB)	Ant Pos (cm)	Table Pos (deg)	Peak Avg. (P/A)	Pol. (H/V)	
802.11n HT20 CH 100 5500MHz		5463.6	62.2	-11.8	74	55.16	31.98	6.21	31.15	105	62	P	H	
		5467.76	44.83	-9.17	54	37.77	31.98	6.23	31.15	105	62	A	H	
	*	5500	110.35	-	-	103.26	32	6.24	31.15	105	62	P	H	
	*	5500	99.46	-	-	92.37	32	6.24	31.15	105	62	A	H	
													H	
													H	
			5460.24	59.08	-14.92	74	52.05	31.97	6.21	31.15	386	105	P	V
			5470	42.66	-11.34	54	35.6	31.98	6.23	31.15	386	105	A	V
		*	5500	109.01	-	-	101.92	32	6.24	31.15	386	105	P	V
		*	5500	97.51	-	-	90.42	32	6.24	31.15	386	105	A	V
													V	
													V	
802.11n HT20 CH 116 5580MHz		5382.64	49.65	-24.35	74	42.72	31.93	6.15	31.15	103	63	P	H	
		5466.88	49.28	-18.92	68.2	42.22	31.98	6.23	31.15	103	63	P	H	
		5451.76	38.23	-15.77	54	31.2	31.97	6.21	31.15	103	63	A	H	
	*	5580	110.28	-	-	103.06	32.1	6.32	31.2	103	63	P	H	
	*	5580	99.12	-	-	91.9	32.1	6.32	31.2	103	63	A	H	
			5745.155	49.57	-18.63	68.2	42.13	32.34	6.37	31.27	103	63	P	H
			5437.12	49	-25	74	42	31.96	6.19	31.15	356	116	P	V
			5460.88	48.69	-19.51	68.2	41.66	31.97	6.21	31.15	356	116	P	V
			5416.96	37.92	-16.08	54	30.94	31.95	6.18	31.15	356	116	A	V
		*	5580	108.32	-	-	101.1	32.1	6.32	31.2	356	116	P	V
	*	5580	97.2	-	-	89.98	32.1	6.32	31.2	356	116	A	V	
		5730.665	49.14	-19.06	68.2	41.73	32.31	6.37	31.27	356	116	P	V	



802.11n HT20 CH 140 5700MHz	*	5700	108.96	-	-	101.58	32.27	6.36	31.25	115	63	P	H
	*	5700	97.52	-	-	90.14	32.27	6.36	31.25	115	63	A	H
		5729.08	63.07	-5.13	68.2	55.65	32.31	6.37	31.26	115	63	P	H
													H
													H
													H
	*	5700	106.98	-	-	99.6	32.27	6.36	31.25	392	103	P	V
	*	5700	95.63	-	-	88.25	32.27	6.36	31.25	392	103	A	V
		5728.04	59.57	-8.63	68.2	52.15	32.31	6.37	31.26	392	103	P	V
													V
													V
												V	
Remark	1. No other spurious found. 2. All results are PASS against Peak and Average limit line.												



Band 3 - 5470~5725MHz
WIFI 802.11n HT20 (Harmonic @ 3m)

WIFI Ant. 1	Note	Frequency (MHz)	Level (dBμV/m)	Over Limit (dB)	Limit Line (dBμV/m)	Read Level (dBμV)	Antenna Factor (dB/m)	Path Loss (dB)	Preamp Factor (dB)	Ant Pos (cm)	Table Pos (deg)	Peak Avg. (P/A)	Pol. (H/V)
802.11n HT20 CH 100 5500MHz		11000	49.02	-24.98	74	63.54	40.5	10.08	65.1	100	0	P	H
		16500	64.76	-9.24	74	77.77	39.6	12.49	65.1	134	300	P	H
		16500	46.58	-7.42	54	59.59	39.6	12.49	65.1	134	300	A	H
													H
		11000	48.58	-25.42	74	63.1	40.5	10.08	65.1	100	0	P	V
		16500	69.95	-4.05	74	82.96	39.6	12.49	65.1	132	60	P	V
		16500	50.91	-3.09	54	63.92	39.6	12.49	65.1	132	60	A	V
													V
802.11n HT20 CH 116 5580MHz		11160	47.93	-26.07	74	62.6	40.37	10.16	65.2	100	0	P	H
		16740	55.83	-12.37	68.2	68.04	40.13	12.52	64.86	100	0	P	H
													H
													H
		11160	47.66	-26.34	74	62.33	40.37	10.16	65.2	100	0	P	V
		16740	57.23	-10.97	68.2	69.44	40.13	12.52	64.86	100	0	P	V
													V
802.11n HT20 CH 140 5700MHz		11400	45.82	-28.18	74	60.69	40.18	10.29	65.34	100	0	P	H
		17100	48.22	-19.98	68.2	58.98	41.06	12.64	64.46	100	0	P	H
													H
													H
		11400	45.97	-28.03	74	60.84	40.18	10.29	65.34	100	0	P	V
		17100	47.42	-20.78	68.2	58.18	41.06	12.64	64.46	100	0	P	V
													V
Remark	1. No other spurious found. 2. All results are PASS against Peak and Average limit line.												



Band 3 - 5470~5725MHz
WIFI 802.11n HT40 (Band Edge @ 3m)

WIFI Ant. 1	Note	Frequency (MHz)	Level (dBμV/m)	Over Limit (dB)	Limit Line (dBμV/m)	Read Level (dBμV)	Antenna Factor (dB/m)	Path Loss (dB)	Preamp Factor (dB)	Ant Pos (cm)	Table Pos (deg)	Peak Avg. (P/A)	Pol. (H/V)
802.11n HT40 CH 102 5510MHz		5466.64	65.22	-8.78	74	58.16	31.98	6.23	31.15	107	62	P	H
		5469.04	49.1	-4.9	54	42.04	31.98	6.23	31.15	107	62	A	H
	*	5510	106.96	-	-	99.86	32	6.26	31.16	107	62	P	H
	*	5510	96.3	-	-	89.2	32	6.26	31.16	107	62	A	H
		5755.55	50.29	-23.71	74	42.83	32.36	6.37	31.27	107	62	P	H
		5741.375	39.78	-14.22	54	32.34	32.34	6.37	31.27	107	62	A	H
		5467.36	62.52	-11.48	74	55.46	31.98	6.23	31.15	384	105	P	V
		5470	46.26	-7.74	54	39.2	31.98	6.23	31.15	384	105	A	V
	*	5510	105.36	-	-	98.26	32	6.26	31.16	384	105	P	V
	*	5510	94.49	-	-	87.39	32	6.26	31.16	384	105	A	V
		5737.595	49.87	-24.13	74	42.43	32.34	6.37	31.27	384	105	P	V
		5733.815	38.84	-15.16	54	31.43	32.31	6.37	31.27	384	105	A	V
802.11n HT40 CH 110 5550MHz		5459.44	56.24	-17.76	74	49.21	31.97	6.21	31.15	117	62	P	H
		5468.56	60.12	-8.08	68.2	53.06	31.98	6.23	31.15	117	62	P	H
		5459.2	41.51	-12.49	54	34.48	31.97	6.21	31.15	117	62	A	H
	*	5550	107.18	-	-	99.99	32.07	6.29	31.17	117	62	P	H
	*	5550	96.55	-	-	89.36	32.07	6.29	31.17	117	62	A	H
		5741.06	49.71	-18.49	68.2	42.27	32.34	6.37	31.27	117	62	P	H
		5459.68	54.68	-19.32	74	47.65	31.97	6.21	31.15	358	107	P	V
		5467.84	55.77	-12.43	68.2	48.71	31.98	6.23	31.15	358	107	P	V
		5456.8	40.25	-13.75	54	33.22	31.97	6.21	31.15	358	107	A	V
	*	5550	105.54	-	-	98.35	32.07	6.29	31.17	358	107	P	V
	*	5550	94.66	-	-	87.47	32.07	6.29	31.17	358	107	A	V
		5727.2	49.43	-18.77	68.2	42.01	32.31	6.37	31.26	358	107	P	V



802.11n HT40 CH 134 5670MHz		5390.25	49.41	-24.59	74	42.48	31.93	6.15	31.15	100	63	P	H
		5463.75	48.55	-19.65	68.2	41.51	31.98	6.21	31.15	100	63	P	H
		5448	38.57	-15.43	54	31.54	31.97	6.21	31.15	100	63	A	H
	*	5670	106.53	-	-	99.17	32.24	6.35	31.23	100	63	P	H
	*	5670	95.62	-	-	88.26	32.24	6.35	31.23	100	63	A	H
		5729.125	61.86	-6.34	68.2	54.44	32.31	6.37	31.26	100	63	P	H
		5409.85	48.46	-25.54	74	41.51	31.94	6.16	31.15	382	114	P	V
		5467.6	48.37	-19.83	68.2	41.31	31.98	6.23	31.15	382	114	P	V
		5418.6	38.48	-15.52	54	31.5	31.95	6.18	31.15	382	114	A	V
	*	5670	104.91	-	-	97.55	32.24	6.35	31.23	382	114	P	V
	*	5670	94.38	-	-	87.02	32.24	6.35	31.23	382	114	A	V
		5728.425	58.65	-9.55	68.2	51.23	32.31	6.37	31.26	382	114	P	V
Remark	1. No other spurious found. 2. All results are PASS against Peak and Average limit line.												



Band 3 - 5470~5725MHz
WIFI 802.11n HT40 (Harmonic @ 3m)

WIFI Ant. 1	Note	Frequency (MHz)	Level (dBμV/m)	Over Limit (dB)	Limit Line (dBμV/m)	Read Level (dBμV)	Antenna Factor (dB/m)	Path Loss (dB)	Preamp Factor (dB)	Ant Pos (cm)	Table Pos (deg)	Peak Avg. (P/A)	Pol. (H/V)	
802.11n HT40 CH 102 5510MHz		11020	49.18	-24.82	74	63.7	40.49	10.1	65.11	100	0	P	H	
		16530	48.29	-25.71	74	61.19	39.68	12.49	65.07	100	0	P	H	
													H	
													H	
			11020	48.8	-25.2	74	63.32	40.49	10.1	65.11	100	0	P	V
			16530	60.35	-13.65	74	73.25	39.68	12.49	65.07	123	78	P	V
			16530	48.02	-5.98	54	60.92	39.68	12.49	65.07	123	78	A	V
													V	
802.11n HT40 CH 110 5550MHz		11100	47.76	-26.24	74	62.36	40.42	10.14	65.16	100	0	P	H	
		16650	49.39	-18.81	68.2	61.88	39.94	12.51	64.94	100	0	P	H	
													H	
													H	
			11100	48.88	-25.12	74	63.48	40.42	10.14	65.16	100	0	P	V
			16650	53.77	-14.43	68.2	66.26	39.94	12.51	64.94	100	0	P	V
														V
													V	
802.11n HT40 CH 134 5670MHz		11340	47.63	-26.37	74	62.44	40.23	10.26	65.3	100	0	P	H	
		17010	52.2	-16	68.2	63.46	40.76	12.56	64.58	100	0	P	H	
													H	
													H	
			11340	47.32	-26.68	74	62.13	40.23	10.26	65.3	100	0	P	V
			17010	56.51	-11.69	68.2	67.77	40.76	12.56	64.58	100	0	P	V
														V
													V	
Remark	1. No other spurious found. 2. All results are PASS against Peak and Average limit line.													



Band 3 - 5470~5725MHz
WIFI 802.11ac VHT80 (Band Edge @ 3m)

WIFI Ant. 1	Note	Frequency (MHz)	Level (dBμV/m)	Over Limit (dB)	Limit Line (dBμV/m)	Read Level (dBμV)	Antenna Factor (dB/m)	Path Loss (dB)	Preamp Factor (dB)	Ant Pos (cm)	Table Pos (deg)	Peak Avg. (P/A)	Pol. (H/V)
802.11ac VHT80 CH 106 5530MHz		5469.28	63.99	-10.01	74	56.93	31.98	6.23	31.15	116	61	P	H
		5458	49.51	-4.49	54	42.48	31.97	6.21	31.15	116	61	A	H
	*	5530	102.37	-	-	95.25	32.02	6.27	31.17	116	61	P	H
	*	5530	92.13	-	-	85.01	32.02	6.27	31.17	116	61	A	H
		5741.06	49.39	-24.61	74	41.95	32.34	6.37	31.27	116	61	P	H
		5741.69	39.08	-14.92	54	31.64	32.34	6.37	31.27	116	61	A	H
		5469.76	60.25	-13.75	74	53.19	31.98	6.23	31.15	381	106	P	V
		5445.52	45.95	-8.05	54	38.94	31.97	6.19	31.15	381	106	A	V
	*	5530	101.38	-	-	94.26	32.02	6.27	31.17	381	106	P	V
	*	5530	90.66	-	-	83.54	32.02	6.27	31.17	381	106	A	V
		5745.155	49.53	-24.47	74	42.09	32.34	6.37	31.27	381	106	P	V
		5737.595	39.89	-14.11	54	32.45	32.34	6.37	31.27	381	106	A	V
802.11ac VHT80 CH 122 5610MHz		5458.15	50.06	-23.94	74	43.03	31.97	6.21	31.15	100	64	P	H
		5463.4	50.9	-17.3	68.2	43.86	31.98	6.21	31.15	100	64	P	H
		5437.85	39.25	-14.75	54	32.25	31.96	6.19	31.15	100	64	A	H
	*	5610	102.3	-	-	95.03	32.14	6.34	31.21	100	64	P	H
	*	5610	91.65	-	-	84.38	32.14	6.34	31.21	100	64	A	H
		5733.675	50.73	-17.47	68.2	43.32	32.31	6.37	31.27	100	64	P	H
		5361.9	49.93	-24.07	74	43.02	31.92	6.14	31.15	390	115	P	V
		5469	49.08	-19.12	68.2	42.02	31.98	6.23	31.15	390	115	P	V
		5455	39.03	-14.97	54	32	31.97	6.21	31.15	390	115	A	V
	*	5610	100.91	-	-	93.64	32.14	6.34	31.21	390	115	P	V
	*	5610	90.31	-	-	83.04	32.14	6.34	31.21	390	115	A	V
		5742.95	51.25	-16.95	68.2	43.81	32.34	6.37	31.27	390	115	P	V
Remark	1. No other spurious found. 2. All results are PASS against Peak and Average limit line.												



Band 3 5470~5725MHz
WIFI 802.11ac VHT80 (Harmonic @ 3m)

WIFI Ant. 1	Note	Frequency (MHz)	Level (dBμV/m)	Over Limit (dB)	Limit Line (dBμV/m)	Read Level (dBμV)	Antenna Factor (dB/m)	Path Loss (dB)	Preamp Factor (dB)	Ant Pos (cm)	Table Pos (deg)	Peak Avg. (P/A)	Pol. (H/V)	
802.11ac VHT80 CH 106 5530MHz		11060	47.42	-26.58	74	61.99	40.45	10.12	65.14	100	0	P	H	
		16590	45.45	-28.55	74	58.17	39.79	12.5	65.01	100	0	P	H	
													H	
													H	
			11060	47.13	-26.87	74	61.7	40.45	10.12	65.14	100	0	P	V
			16590	56.32	-17.68	74	69.04	39.79	12.5	65.01	127	58	P	V
			16590	42.66	-11.34	54	55.38	39.79	12.5	65.01	127	58	A	V
802.11ac VHT80 CH 122 5610MHz		11220	46.54	-27.46	74	61.24	40.33	10.2	65.23	100	0	P	H	
		16830	48.57	-19.63	68.2	60.48	40.32	12.54	64.77	100	0	P	H	
													H	
													H	
			11220	46.36	-27.64	74	61.06	40.33	10.2	65.23	100	0	P	V
			16830	49.59	-18.61	68.2	61.5	40.32	12.54	64.77	100	0	P	V
														V
Remark	1. No other spurious found.													
	2. All results are PASS against Peak and Average limit line.													



Emission below 1GHz
WIFI 802.11n HT20 (LF @ 3m)

WIFI	Note	Frequency	Level	Over	Limit	Read	Antenna	Path	Preamp	Ant	Table	Peak	Pol.	
Ant.				Limit	Line	Level	Factor	Loss	Factor	Pos	Pos	Avg.		
1		(MHz)	(dBμV/m)	(dB)	(dBμV/m)	(dBμV)	(dB/m)	(dB)	(dB)	(cm)	(deg)	(P/A)	(H/V)	
802.11n HT20 LF		33.51	33.14	-6.86	40	40.23	22.69	0.45	30.23			P	H	
		93.18	21.42	-22.08	43.5	35.61	15.36	0.86	30.41			P	H	
		194.7	23.48	-20.02	43.5	37.4	15.08	1.28	30.28			P	H	
		746.6	41.2	-4.8	46	40.38	27.95	2.31	29.44	100	0	P	H	
		848.8	35.04	-10.96	46	32.79	29.02	2.48	29.25			P	H	
		962.9	34.58	-19.42	54	29.78	31.09	2.74	29.03			P	H	
													H	
													H	
													H	
													H	
													H	
													H	
			34.59	26.67	-13.33	40	34.21	22.26	0.45	30.25			P	V
			71.31	24.47	-15.53	40	41.42	12.75	0.73	30.43			P	V
			196.05	22.64	-20.86	43.5	36.56	15.08	1.28	30.28			P	V
			559	28.55	-17.45	46	30.33	25.92	2.01	29.71			P	V
			733.3	37.54	-8.46	46	37.13	27.6	2.28	29.47	100	0	P	V
			848.8	35.18	-10.82	46	32.93	29.02	2.48	29.25			P	V
													V	
													V	
												V		
												V		
												V		
												V		
Remark	1. No other spurious found. 2. All results are PASS against limit line.													



Note symbol

*	Fundamental Frequency which can be ignored. However, the level of any unwanted emissions shall not exceed the level of the fundamental frequency.
!	Test result is over limit line.
P/A	P eak or A verage
H/V	H orizontal or V ertical



A calculation example for radiated spurious emission is shown as below:

WIFI	Note	Frequency	Level	Over	Limit	Read	Antenna	Path	Preamp	Ant	Table	Peak	Pol.
Ant.				Limit	Line	Level	Factor	Loss	Factor	Pos	Pos	Avg.	
1		(MHz)	(dBμV/m)	(dB)	(dBμV/m)	(dBμV)	(dB/m)	(dB)	(dB)	(cm)	(deg)	(P/A)	(H/V)
802.11b		2390	55.45	-18.55	74	54.51	32.22	4.58	35.86	103	308	P	H
CH 01													
2412MHz		2390	43.54	-10.46	54	42.6	32.22	4.58	35.86	103	308	A	H

1. Path Loss(dB) = Cable loss(dB) + Filter loss(dB) + Attenuator loss(dB)
2. Level(dBμV/m) = Antenna Factor(dB/m) + Path Loss(dB) + Read Level(dBμV) - Preamp Factor(dB)
3. Over Limit(dB) = Level(dBμV/m) – Limit Line(dBμV/m)

For Peak Limit @ 2390MHz:

1. Level(dBμV/m)
= Antenna Factor(dB/m) + Path Loss(dB) + Read Level(dBμV) - Preamp Factor(dB)
= 32.22(dB/m) + 4.58(dB) + 54.51(dBμV) – 35.86 (dB)
= 55.45 (dBμV/m)
2. Over Limit(dB)
= Level(dBμV/m) – Limit Line(dBμV/m)
= 55.45(dBμV/m) – 74(dBμV/m)
= -18.55(dB)

For Average Limit @ 2390MHz:

1. Level(dBμV/m)
= Antenna Factor(dB/m) + Path Loss(dB) + Read Level(dBμV) - Preamp Factor(dB)
= 32.22(dB/m) + 4.58(dB) + 42.6(dBμV) – 35.86 (dB)
= 43.54 (dBμV/m)
2. Over Limit(dB) = Level(dBμV/m) – Limit Line(dBμV/m)
= 43.54(dBμV/m) – 54(dBμV/m)
= -10.46(dB)

Both peak and average measured complies with the limit line, so test result is “PASS”.



Appendix D. Radiated Spurious Emission

Test Engineer :	Watt Tseng, Karl Hou, and Nick Yu	Temperature :	21~23°C
		Relative Humidity :	57~60%

Note symbol

-L	Low channel location
-R	High channel location



Band 1 - 5150~5250MHz
WIFI 802.11a (Band Edge @ 3m)

Table with 2 columns (Horizontal, Fundamental) and 2 rows (Peak, Avg.). Each cell contains a spectral plot and technical details like Site, Condition, RBW, and VBW.



WIFI	Band 1 5150~5250MHz Band Edge @ 3m	
ANT	802.11a CH36 5180MHz	
1	Vertical	Fundamental
Peak	<p>Site : 03CH12-HY Condition : PEAK_BE_74 3m HORN_9120D_1328 VERTICAL : RBW:1000.000kHz VBW:3000.000kHz SWT:Auto</p>	<p>Site : 03CH12-HY Condition : PEAK_74 3m HORN_9120D_1328 VERTICAL : RBW:1000.000kHz VBW:3000.000kHz SWT:Auto</p>
Avg.	<p>Site : 03CH12-HY Condition : AVG_BE_54 3m HORN_9120D_1328 VERTICAL : RBW:1000.000kHz VBW:1.000kHz SWT:Auto</p>	Left blank



WIFI	Band 1 5150~5250MHz Band Edge @ 3m	
ANT	802.11a CH44 5220MHz - L	
1	Horizontal	Fundamental
Peak	<p>Site : 03CH2-HY Condition : PEAK_BE_74 3m HORN_9120D_1328 HORIZONTAL : RBW:1000.000kHz VBW:3000.000kHz SWT:Auto</p>	<p>Site : 03CH2-HY Condition : PEAK_74 3m HORN_9120D_1328 HORIZONTAL : RBW:1000.000kHz VBW:3000.000kHz SWT:Auto</p>
Avg.	<p>Site : 03CH2-HY Condition : AVG_BE_54 3m HORN_9120D_1328 HORIZONTAL : RBW:1000.000kHz VBW:1.000kHz SWT:Auto</p>	Left blank

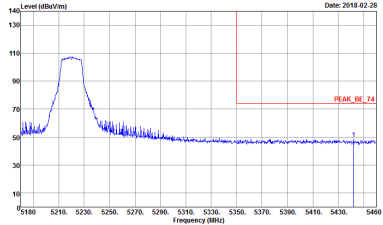
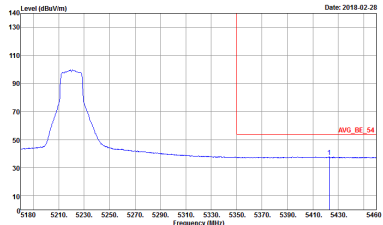

WIFI	Band 1 5150~5250MHz Band Edge @ 3m	
ANT	802.11a CH44 5220MHz - R	
1	Horizontal	Fundamental
Peak	 <p>Site : 03CH12-HY Condition : PEAK_BE_74 3m HORN_9120D_1328 HORIZONTAL : RBW:1000.000KHz VBW:3000.000KHz SWT:Auto</p>	Left blank
Avg.	 <p>Site : 03CH12-HY Condition : AVG_BE_54 3m HORN_9120D_1328 HORIZONTAL : RBW:1000.000KHz VBW:1.000KHz SWT:Auto</p>	Left blank



WIFI	Band 1 5150~5250MHz Band Edge @ 3m	
ANT	802.11a CH44 5220MHz - L	
1	Vertical	Fundamental
Peak	<p>Site : 03CH2-HY Condition : PEAK_BE_74 3m HORN_9120D_1328 VERTICAL : RBW:1000.000KHz VBW:3000.000KHz SWT:Auto</p>	<p>Site : 03CH2-HY Condition : PEAK_74 3m HORN_9120D_1328 VERTICAL : RBW:1000.000KHz VBW:3000.000KHz SWT:Auto</p>
Avg.	<p>Site : 03CH2-HY Condition : AVG_BE_54 3m HORN_9120D_1328 VERTICAL : RBW:1000.000KHz VBW:1.000KHz SWT:Auto</p>	Left blank



WIFI	Band 1 5150~5250MHz Band Edge @ 3m	
ANT	802.11a CH44 5220MHz - R	
1	Vertical	Fundamental
Peak	<p>Site : 03CH12-HY Condition : PEAK_BE_74 3m HORN_9120D_1328 VERTICAL : RBW:1000.000KHz VBW:3000.000KHz SWT:Auto</p>	Left blank
Avg.	<p>Site : 03CH12-HY Condition : AVG_BE_54 3m HORN_9120D_1328 VERTICAL : RBW:1000.000KHz VBW:1.000KHz SWT:Auto</p>	Left blank



WIFI	Band 1 5150~5250MHz Band Edge @ 3m	
ANT	802.11a CH48 5240MHz - L	
1	Horizontal	Fundamental
Peak	<p>Site : 03CH2-HY Condition : PEAK_BE_74 3m HORN_91200_1328 HORIZONTAL : RBW:1000.000kHz VBW:3000.000kHz SWT:Auto</p>	<p>Site : 03CH2-HY Condition : PEAK_74 3m HORN_91200_1328 HORIZONTAL : RBW:1000.000kHz VBW:3000.000kHz SWT:Auto</p>
Avg.	<p>Site : 03CH2-HY Condition : AVG_BE_54 3m HORN_91200_1328 HORIZONTAL : RBW:1000.000kHz VBW:1.000kHz SWT:Auto</p>	Left blank



WIFI	Band 1 5150~5250MHz Band Edge @ 3m	
ANT	802.11a CH48 5240MHz - R	
1	Horizontal	Fundamental
Peak	<p>Site : 03CH2-HY Condition : PEAK_BE_74 3m HORN_9120D_1328 HORIZONTAL : RBW:1000.000KHz VBW:3000.000KHz SWT:Auto</p>	Left blank
Avg.	<p>Site : 03CH2-HY Condition : AVG_BE_54 3m HORN_9120D_1328 HORIZONTAL : RBW:1000.000KHz VBW:1.000KHz SWT:Auto</p>	Left blank



WIFI	Band 1 5150~5250MHz Band Edge @ 3m	
ANT	802.11a CH48 5240MHz - L	
1	Vertical	Fundamental
Peak	<p>Site : 03CH12-HY Condition : PEAK_BE_74 3m HORN_9120D_1328 VERTICAL : RBW:1000.000kHz VBW:3000.000kHz SWT:Auto</p>	<p>Site : 03CH12-HY Condition : PEAK_74 3m HORN_9120D_1328 VERTICAL : RBW:1000.000kHz VBW:3000.000kHz SWT:Auto</p>
Avg.	<p>Site : 03CH12-HY Condition : AVG_BE_54 3m HORN_9120D_1328 VERTICAL : RBW:1000.000kHz VBW:1.000kHz SWT:Auto</p>	Left blank



WIFI	Band 1 5150~5250MHz Band Edge @ 3m	
ANT	802.11a CH48 5240MHz - R	
1	Vertical	Fundamental
Peak	<p>Site : 03CH12-HY Condition : PEAK_BE_74 3m HORN_9120D_1328 VERTICAL : RBW:1000.000KHz VBW:3000.000KHz SWT:Auto</p>	Left blank
Avg.	<p>Site : 03CH12-HY Condition : AVG_BE_54 3m HORN_9120D_1328 VERTICAL : RBW:1000.000KHz VBW:1.000KHz SWT:Auto</p>	Left blank



Band 1 5150~5250MHz
WIFI 802.11n HT20 (Band Edge @ 3m)

WIFI	Band 1 5150~5250MHz Band Edge @ 3m	
ANT	802.11n HT20 CH36 5180MHz	
1	Horizontal	Fundamental
Peak	<p>Site : 03CH2-HY Condition : PEAK_BE_74 3m HORN_9120D_1328 HORIZONTAL : RBW:1000.000kHz VBW:3000.000kHz SWT:Auto</p>	<p>Site : 03CH2-HY Condition : PEAK_74 3m HORN_9120D_1328 HORIZONTAL : RBW:1000.000kHz VBW:3000.000kHz SWT:Auto</p>
Avg.	<p>Site : 03CH2-HY Condition : AVG_BE_54 3m HORN_9120D_1328 HORIZONTAL : RBW:1000.000kHz VBW:1.000kHz SWT:Auto</p>	Left blank



WIFI	Band 1 5150~5250MHz Band Edge @ 3m	
ANT	802.11n HT20 CH36 5180MHz	
1	Vertical	Fundamental
Peak	<p>Site : 03CH12-HY Condition : PEAK_BE_74 3m HORN_9120D_1328 VERTICAL : RBW:1000.000KHz VBW:3000.000KHz SWT:Auto</p>	<p>Site : 03CH12-HY Condition : PEAK_74 3m HORN_9120D_1328 VERTICAL : RBW:1000.000KHz VBW:3000.000KHz SWT:Auto</p>
Avg.	<p>Site : 03CH12-HY Condition : AVG_BE_54 3m HORN_9120D_1328 VERTICAL : RBW:1000.000KHz VBW:1.000KHz SWT:Auto</p>	Left blank



WIFI	Band 1 5150~5250MHz Band Edge @ 3m	
ANT	802.11n HT20 CH44 5220MHz - L	
1	Horizontal	Fundamental
Peak	<p>Site : 03CH12-HY Condition : PEAK_BE_74 3m HORN_9120D_1328 HORIZONTAL : RBW:1000.000KHz VBW:3000.000KHz SWT:Auto</p>	<p>Site : 03CH12-HY Condition : PEAK_74 3m HORN_9120D_1328 HORIZONTAL : RBW:1000.000KHz VBW:3000.000KHz SWT:Auto</p>
Avg.	<p>Site : 03CH12-HY Condition : AVG_BE_54 3m HORN_9120D_1328 HORIZONTAL : RBW:1000.000KHz VBW:1.000KHz SWT:Auto</p>	Left blank



WIFI	Band 1 5150~5250MHz Band Edge @ 3m	
ANT	802.11n HT20 CH44 5220MHz - R	
1	Horizontal	Fundamental
Peak		Left blank
Avg.		Left blank



WIFI	Band 1 5150~5250MHz Band Edge @ 3m	
ANT	802.11n HT20 CH44 5220MHz - L	
1	Vertical	Fundamental
Peak	<p>Site : 03CH12-HY Condition : PEAK_BE_74 3m HORN_9120D_1328 VERTICAL : RBW:1000.000KHz VBW:3000.000KHz SWT:Auto</p>	<p>Site : 03CH12-HY Condition : PEAK_74 3m HORN_9120D_1328 VERTICAL : RBW:1000.000KHz VBW:3000.000KHz SWT:Auto</p>
Avg.	<p>Site : 03CH12-HY Condition : AVG_BE_54 3m HORN_9120D_1328 VERTICAL : RBW:1000.000KHz VBW:1.000KHz SWT:Auto</p>	Left blank



WIFI	Band 1 5150~5250MHz Band Edge @ 3m	
ANT	802.11n HT20 CH44 5220MHz - R	
1	Vertical	Fundamental
Peak	<p>Site : 03CH2-HY Condition : PEAK_BE_74 3m HORN_9120D_1328 VERTICAL : RBW:1000.000KHz VBW:3000.000KHz SWT:Auto</p>	Left blank
Avg.	<p>Site : 03CH2-HY Condition : AVG_BE_54 3m HORN_9120D_1328 VERTICAL : RBW:1000.000KHz VBW:1.000KHz SWT:Auto</p>	Left blank



WIFI	Band 1 5150~5250MHz Band Edge @ 3m	
ANT	802.11n HT20 CH48 5240MHz - L	
1	Horizontal	Fundamental
Peak	<p>Site : 03CH12-HY Condition : PEAK_BE_74 3m HORN_9120D_1328 HORIZONTAL : RBW:1000.000kHz VBW:3000.000kHz SWT:Auto</p>	<p>Site : 03CH12-HY Condition : PEAK_74 3m HORN_9120D_1328 HORIZONTAL : RBW:1000.000kHz VBW:3000.000kHz SWT:Auto</p>
Avg.	<p>Site : 03CH12-HY Condition : AVG_BE_54 3m HORN_9120D_1328 HORIZONTAL : RBW:1000.000kHz VBW:1.000kHz SWT:Auto</p>	Left blank

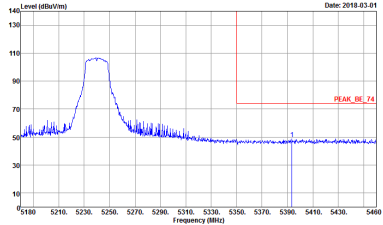
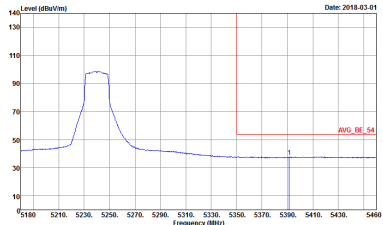

WIFI	Band 1 5150~5250MHz Band Edge @ 3m	
ANT	802.11n HT20 CH48 5240MHz - R	
1	Horizontal	Fundamental
<p>Peak</p>	 <p>Site : 03CH2-HY Condition : PEAK_BE_74 3m HORN_9120D_1328 HORIZONTAL : RBW:1000.000KHz VBW:3000.000KHz SWT:Auto</p>	<p>Left blank</p>
<p>Avg.</p>	 <p>Site : 03CH2-HY Condition : AVG_BE_54 3m HORN_9120D_1328 HORIZONTAL : RBW:1000.000KHz VBW:1.000KHz SWT:Auto</p>	<p>Left blank</p>

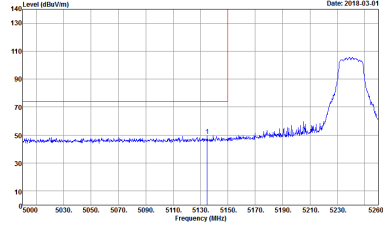
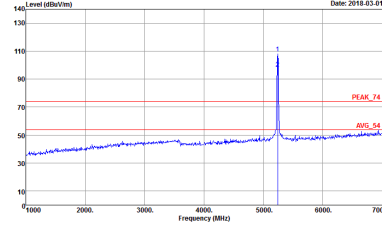
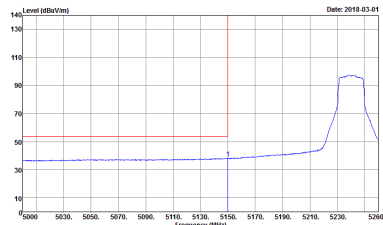

WIFI	Band 1 5150~5250MHz Band Edge @ 3m	
ANT	802.11n HT20 CH48 5240MHz - L	
1	Vertical	Fundamental
Peak	 <p>Site : 03CH12-HY Condition : PEAK_BE_74 3m HORN_9120D_1328 VERTICAL : RBW:1000.000kHz VBW:3000.000kHz SWT:Auto</p>	 <p>Site : 03CH12-HY Condition : PEAK_74 3m HORN_9120D_1328 VERTICAL : RBW:1000.000kHz VBW:3000.000kHz SWT:Auto</p>
Avg.	 <p>Site : 03CH12-HY Condition : AVG_BE_54 3m HORN_9120D_1328 VERTICAL : RBW:1000.000kHz VBW:1.000kHz SWT:Auto</p>	Left blank

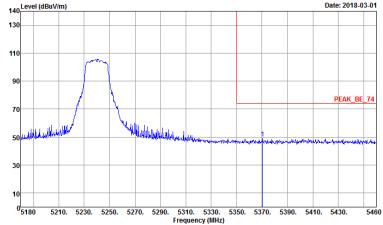
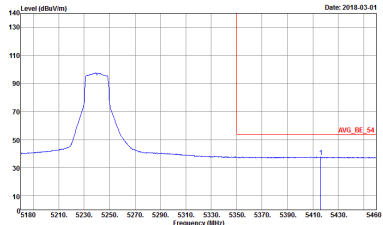

WIFI	Band 1 5150~5250MHz Band Edge @ 3m	
ANT	802.11n HT20 CH48 5240MHz - R	
1	Vertical	Fundamental
<p>Peak</p>	 <p>Site : 03CH2-HY Condition : PEAK_BE_74 3m HORN_9120D_1328 VERTICAL : RBW:1000.000KHz VBW:3000.000KHz SWT:Auto</p>	<p>Left blank</p>
<p>Avg.</p>	 <p>Site : 03CH2-HY Condition : AVG_BE_54 3m HORN_9120D_1328 VERTICAL : RBW:1000.000KHz VBW:1.000KHz SWT:Auto</p>	<p>Left blank</p>



**Band 1 5150~5250MHz
WIFI 802.11n HT40 (Band Edge @ 3m)**

WIFI	Band 1 5150~5250MHz Band Edge @ 3m	
ANT	802.11n HT40 CH38 5190MHz - L	
1	Horizontal	Fundamental
Peak	<p>Site : 03CH2-HY Condition : PEAK_BE_74 3m HORN_9120D_1328 HORIZONTAL : RBW:1000.000kHz VBW:3000.000kHz SWT:Auto</p>	<p>Site : 03CH2-HY Condition : PEAK_74 3m HORN_9120D_1328 HORIZONTAL : RBW:1000.000kHz VBW:3000.000kHz SWT:Auto</p>
Avg.	<p>Site : 03CH2-HY Condition : AVG_BE_54 3m HORN_9120D_1328 HORIZONTAL : RBW:1000.000kHz VBW:3000.000kHz SWT:Auto</p>	Left blank



WIFI	Band 1 5150~5250MHz Band Edge @ 3m	
ANT	802.11n HT40 CH38 5190MHz - R	
1	Horizontal	Fundamental
Peak	<p>Site : 03CH12-HY Condition : PEAK_BE_74 3m HORN_9120D_1328 HORIZONTAL : RBW:1000.000kHz VBW:3000.000Hz SWT:Auto</p>	Left blank
Avg.	<p>Site : 03CH12-HY Condition : AVG_BE_54 3m HORN_9120D_1328 HORIZONTAL : RBW:1000.000kHz VBW:3.000kHz SWT:Auto</p>	Left blank



WIFI	Band 1 5150~5250MHz Band Edge @ 3m	
ANT	802.11n HT40 CH38 5190MHz - L	
1	Vertical	Fundamental
Peak	<p>Site : 03CH12-HY Condition : PEAK_BE_74 3m HORN_9120D_1328 VERTICAL : RBW:1000.000kHz VBW:3000.000kHz SWT:Auto</p>	<p>Site : 03CH12-HY Condition : PEAK_74 3m HORN_9120D_1328 VERTICAL : RBW:1000.000kHz VBW:3000.000kHz SWT:Auto</p>
Avg.	<p>Site : 03CH12-HY Condition : AVG_BE_54 3m HORN_9120D_1328 VERTICAL : RBW:1000.000kHz VBW:3000.000kHz SWT:Auto</p>	Left blank



WIFI	Band 1 5150~5250MHz Band Edge @ 3m	
ANT	802.11n HT40 CH38 5190MHz - R	
1	Vertical	Fundamental
<p>Peak</p>		<p>Left blank</p>
<p>Avg.</p>		<p>Left blank</p>



WIFI	Band 1 5150~5250MHz Band Edge @ 3m	
ANT	802.11n HT40 CH46 5230MHz - L	
1	Horizontal	Fundamental
Peak	<p>Site : 03CH12-HY Condition : PEAK_BE_74 3m HORN_9120D_1328 HORIZONTAL : RBW:1000.000kHz VBW:3000.000kHz SWT:Auto</p>	<p>Site : 03CH12-HY Condition : PEAK_74 3m HORN_9120D_1328 HORIZONTAL : RBW:1000.000kHz VBW:3000.000kHz SWT:Auto</p>
Avg.	<p>Site : 03CH12-HY Condition : AVG_BE_54 3m HORN_9120D_1328 HORIZONTAL : RBW:1000.000kHz VBW:3000.000kHz SWT:Auto</p>	Left blank



WIFI	Band 1 5150~5250MHz Band Edge @ 3m	
ANT	802.11n HT40 CH46 5230MHz - R	
1	Horizontal	Fundamental
<p>Peak</p>	<p>Site : 03CH2-HY Condition : PEAK_BE_74 3m HORN_9120D_1328 HORIZONTAL : RBW:1000.000kHz VBW:3000.000Hz SWT:Auto</p>	<p>Left blank</p>
<p>Avg.</p>	<p>Site : 03CH2-HY Condition : AVG_BE_54 3m HORN_9120D_1328 HORIZONTAL : RBW:1000.000kHz VBW:3.000kHz SWT:Auto</p>	<p>Left blank</p>



WIFI	Band 1 5150~5250MHz Band Edge @ 3m	
ANT	802.11n HT40 CH46 5230MHz - L	
1	Vertical	Fundamental
Peak	<p>Site : 03CH12-HY Condition : PEAK_BE_74 3m HORN_9120D_1328 VERTICAL : RBW:1000.000kHz VBW:3000.000kHz SWT:Auto</p>	<p>Site : 03CH12-HY Condition : PEAK_74 3m HORN_9120D_1328 VERTICAL : RBW:1000.000kHz VBW:3000.000kHz SWT:Auto</p>
Avg.	<p>Site : 03CH12-HY Condition : AVG_BE_54 3m HORN_9120D_1328 VERTICAL : RBW:1000.000kHz VBW:3000.000kHz SWT:Auto</p>	Left blank



WIFI	Band 1 5150~5250MHz Band Edge @ 3m	
ANT	802.11n HT40 CH46 5230MHz - R	
1	Vertical	Fundamental
Peak	<p>Site : 03CH2-HY Condition : PEAK_BE_74 3m HORN_9120D_1328 VERTICAL : RBW:1000.000kHz VBW:3000.000kHz SWT:Auto</p>	Left blank
Avg.	<p>Site : 03CH2-HY Condition : AVG_BE_54 3m HORN_9120D_1328 VERTICAL : RBW:1000.000kHz VBW:3000.000kHz SWT:Auto</p>	Left blank



**Band 1 5150~5250MHz
WIFI 802.11ac VHT80 (Band Edge @ 3m)**

WIFI	Band 1 5150~5250MHz Band Edge @ 3m	
ANT	802.11ac VHT80 CH42 5210MHz - L	
1	Horizontal	Fundamental
Peak	<p>Site Condition : 03CH2-HY : PEAK_BE_74 3m HORN_9120D_1328 HORIZONTAL : RBW:1000.000kHz VBW:3000.000kHz SWT:Auto</p>	<p>Site Condition : 03CH2-HY : PEAK_74 3m HORN_9120D_1328 HORIZONTAL : RBW:1000.000kHz VBW:3000.000kHz SWT:Auto</p>
Avg.	<p>Site Condition : 03CH2-HY : AVG_BE_54 3m HORN_9120D_1328 HORIZONTAL : RBW:1000.000kHz VBW:3000.000kHz SWT:Auto</p>	Left blank



WIFI	Band 1 5150~5250MHz Band Edge @ 3m	
ANT	802.11ac VHT80 CH42 5210MHz - R	
1	Horizontal	Fundamental
Peak	<p>Site : 03CH2-HY Condition : PEAK_BE_74 3m HORN_9120D_1328 HORIZONTAL : RBW:1000.000kHz VBW:3000.000Hz SWT:Auto</p>	Left blank
Avg.	<p>Site : 03CH2-HY Condition : AVG_BE_54 3m HORN_9120D_1328 HORIZONTAL : RBW:1000.000kHz VBW:3.000kHz SWT:Auto</p>	Left blank



WIFI	Band 1 5150~5250MHz Band Edge @ 3m	
ANT	802.11ac VHT80 CH42 5210MHz - L	
1	Vertical	Fundamental
Peak	<p>Site : 03CH12-HY Condition : PEAK_BE_74 3m HORN_9120D_1328 VERTICAL : RBW:1000.000kHz VBW:3000.000kHz SWT:Auto</p>	<p>Site : 03CH12-HY Condition : PEAK_74 3m HORN_9120D_1328 VERTICAL : RBW:1000.000kHz VBW:3000.000kHz SWT:Auto</p>
Avg.	<p>Site : 03CH12-HY Condition : AVG_BE_54 3m HORN_9120D_1328 VERTICAL : RBW:1000.000kHz VBW:3000.000kHz SWT:Auto</p>	Left blank

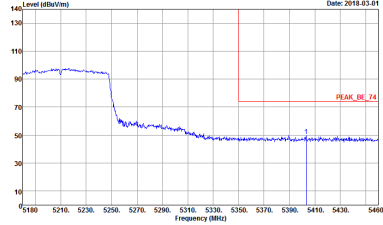
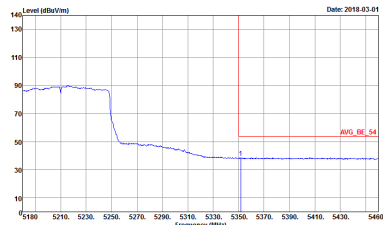

WIFI	Band 1 5150~5250MHz Band Edge @ 3m	
ANT	802.11ac VHT80 CH42 5210MHz - R	
1	Vertical	Fundamental
<p>Peak</p>	 <p>Site : 03CH2-HY Condition : PEAK_BE_74 3m HORN_9120D_1328 VERTICAL : RBW:1000.000kHz VBW:3000.000kHz SWT:Auto</p>	<p>Left blank</p>
<p>Avg.</p>	 <p>Site : 03CH2-HY Condition : AVG_BE_54 3m HORN_9120D_1328 VERTICAL : RBW:1000.000kHz VBW:3000.000kHz SWT:Auto</p>	<p>Left blank</p>



Band 1 - 5150~5250MHz
WIFI 802.11a (Harmonic @ 3m)

WIFI	Band 1 5150~5250MHz Harmonic @ 3m	
ANT	802.11a CH36 5180MHz	
1	Horizontal	Vertical
Peak Avg.	<p>Site : 03CH12-HY Condition : PEAK_74 3m HORN_91200_1328 HORIZONTAL Detector : Peak</p>	<p>Site : 03CH12-HY Condition : PEAK_74 3m HORN_91200_1328 VERTICAL Detector : Peak</p>



WIFI	Band 1 5150~5250MHz Harmonic @ 3m	
ANT	802.11a CH44 5220MHz	
1	Horizontal	Vertical
Peak Avg.	<p>Site : 03CH12-HY Condition : PEAK_74 3m HORN_9120D_1328 HORIZONTAL Detector : Peak</p>	<p>Site : 03CH12-HY Condition : PEAK_74 3m HORN_9120D_1328 VERTICAL Detector : Peak</p>

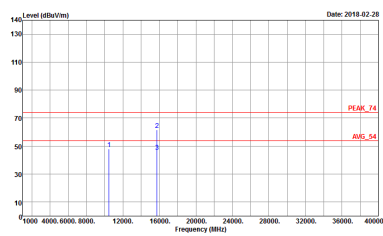
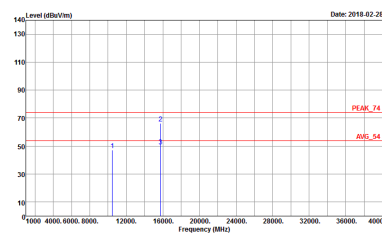

WIFI	Band 1 5150~5250MHz Harmonic @ 3m	
ANT	802.11a CH48 5240MHz	
1	Horizontal	Vertical
<p>Peak Avg.</p>	 <p>Site : 03CH12-HY Condition : PEAK_74 3m HORN_9120D_1328 HORIZONTAL Detector : Peak</p>	 <p>Site : 03CH12-HY Condition : PEAK_74 3m HORN_9120D_1328 VERTICAL Detector : Peak</p>



**Band 1 5150~5250MHz
WIFI 802.11n HT20 (Harmonic @ 3m)**

WIFI	Band 1 5150~5250MHz Harmonic @ 3m	
ANT	802.11n HT20 CH36 5180MHz	
1	Horizontal	Vertical
Peak Avg.	<p>Site : 03CH12-HY Condition : PEAK_74 3m HORN_91200_1328 HORIZONTAL Detector : Peak</p>	<p>Site : 03CH12-HY Condition : PEAK_74 3m HORN_91200_1328 VERTICAL Detector : Peak</p>



WIFI	Band 1 5150~5250MHz Harmonic @ 3m	
ANT	802.11n HT20 CH44 5220MHz	
1	Horizontal	Vertical
Peak Avg.	<p>Site : 03CH12-HY Condition : PEAK_74 3m HORN_9120D_1328 HORIZONTAL Detector : Peak</p>	<p>Site : 03CH12-HY Condition : PEAK_74 3m HORN_9120D_1328 VERTICAL Detector : Peak</p>



WIFI	Band 1 5150~5250MHz Harmonic @ 3m	
ANT	802.11n HT20 CH48 5240MHz	
1	Horizontal	Vertical
Peak Avg.	<p>Site : 03CH12-HY Condition : PEAK_74 3m HORN_9120D_1328 HORIZONTAL Detector : Peak</p>	<p>Site : 03CH12-HY Condition : PEAK_74 3m HORN_9120D_1328 VERTICAL Detector : Peak</p>



**Band 1 5150~5250MHz
WIFI 802.11n HT40 (Harmonic @ 3m)**

WIFI	Band 1 5150~5250MHz Harmonic @ 3m	
ANT	802.11n HT40 CH38 5190MHz	
1	Horizontal	Vertical
Peak Avg.	<p>Site : 03CH12-HY Condition : PEAK_74 3m HORN_91200_1328 HORIZONTAL Detector : Peak</p>	<p>Site : 03CH12-HY Condition : PEAK_74 3m HORN_91200_1328 VERTICAL Detector : Peak</p>



WIFI	Band 1 5150~5250MHz Harmonic @ 3m	
ANT	802.11n HT40 CH46 5230MHz	
1	Horizontal	Vertical
Peak Avg.	<p>Site : 03CH12-HY Condition : PEAK_74 3m HORN_9120D_1328 HORIZONTAL Detector : Peak</p>	<p>Site : 03CH12-HY Condition : PEAK_74 3m HORN_9120D_1328 VERTICAL Detector : Peak</p>



Band 1 5150~5250MHz
WIFI 802.11ac VHT80 (Harmonic @ 3m)

WIFI	Band 1 5150~5250MHz Harmonic @ 3m	
ANT	802.11ac VHT80 CH42 5210MHz	
1	Horizontal	Vertical
Peak Avg.	<p>Site : 03CH12-HY Condition : PEAK_74 3m HORN_91200_1328 HORIZONTAL Detector : Peak</p>	<p>Site : 03CH12-HY Condition : PEAK_74 3m HORN_91200_1328 VERTICAL Detector : Peak</p>



Band 2 - 5250~5350MHz
WIFI 802.11a (Band Edge @ 3m)

WIFI	Band 2 5250~5350MHz Band Edge @ 3m	
ANT	802.11a CH52 5260MHz - L	
1	Horizontal	Fundamental
Peak	<p>Site : 03CH2-HY Condition : PEAK_BE_74 3m HORN_9120D_1328 HORIZONTAL : RBW:1000.000kHz VBW:3000.000kHz SWT:Auto</p>	<p>Site : 03CH2-HY Condition : PEAK_74 3m HORN_9120D_1328 HORIZONTAL : RBW:1000.000kHz VBW:3000.000kHz SWT:Auto</p>
Avg.	<p>Site : 03CH2-HY Condition : AVG_BE_54 3m HORN_9120D_1328 HORIZONTAL : RBW:1000.000kHz VBW:1.000kHz SWT:Auto</p>	Left blank

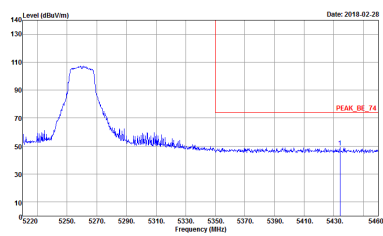
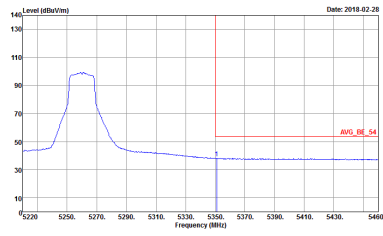

WIFI	Band 2 5250~5350MHz Band Edge @ 3m	
ANT	802.11a CH52 5260MHz - R	
1	Horizontal	Fundamental
Peak	 <p>Site : 03CH2-HY Condition : PEAK_BE_74 3m HORN_91200_1328 HORIZONTAL : RBW:1000.000kHz VBW:3000.000kHz SWT:Auto</p>	Left blank
Avg.	 <p>Site : 03CH2-HY Condition : AVG_BE_54 3m HORN_91200_1328 HORIZONTAL : RBW:1000.000kHz VBW:1.000kHz SWT:Auto</p>	Left blank



WIFI	Band 2 5250~5350MHz Band Edge @ 3m	
ANT	802.11a CH52 5260MHz - L	
1	Vertical	Fundamental
Peak	<p>Site : 03CH12-HY Condition : PEAK_BE_74 3m HORN_9120D_1328 VERTICAL : RBW:1000.000KHz VBW:3000.000KHz SWT:Auto</p>	<p>Site : 03CH12-HY Condition : PEAK_74 3m HORN_9120D_1328 VERTICAL : RBW:1000.000KHz VBW:3000.000KHz SWT:Auto</p>
Avg.	<p>Site : 03CH12-HY Condition : AVG_BE_54 3m HORN_9120D_1328 VERTICAL : RBW:1000.000KHz VBW:1.000KHz SWT:Auto</p>	Left blank



WIFI	Band 2 5250~5350MHz Band Edge @ 3m	
ANT	802.11a CH52 5260MHz - R	
1	Vertical	Fundamental
Peak	<p>Site : 03CH2-HY Condition : PEAK_BE_74 3m HORN_9120D_1328 VERTICAL : RBW:1000.000KHz VBW:3000.000KHz SWT:Auto</p>	Left blank
Avg.	<p>Site : 03CH2-HY Condition : AVG_BE_54 3m HORN_9120D_1328 VERTICAL : RBW:1000.000KHz VBW:1.000KHz SWT:Auto</p>	Left blank



WIFI	Band 2 5250~5350MHz Band Edge @ 3m	
ANT	802.11a CH60 5300MHz - L	
1	Horizontal	Fundamental
Peak	<p>Site : 03CH12-HY Condition : PEAK_BE_74 3m HORN_9120D_1328 HORIZONTAL : RBW:1000.000kHz VBW:3000.000kHz SWT:Auto</p>	<p>Site : 03CH12-HY Condition : PEAK_74 3m HORN_9120D_1328 HORIZONTAL : RBW:1000.000kHz VBW:3000.000kHz SWT:Auto</p>
Avg.	<p>Site : 03CH12-HY Condition : AVG_BE_54 3m HORN_9120D_1328 HORIZONTAL : RBW:1000.000kHz VBW:1.000kHz SWT:Auto</p>	Left blank



WIFI	Band 2 5250~5350MHz Band Edge @ 3m	
ANT	802.11a CH60 5300MHz - R	
1	Horizontal	Fundamental
<p>Peak</p>		<p>Left blank</p>
<p>Avg.</p>		<p>Left blank</p>



WIFI	Band 2 5250~5350MHz Band Edge @ 3m	
ANT	802.11a CH60 5300MHz - L	
1	Vertical	Fundamental
Peak	<p>Site : 03CH12-HY Condition : PEAK_BE_74 3m HORN_9120D_1328 VERTICAL : RBW:1000.000KHz VBW:3000.000KHz SWT:Auto</p>	<p>Site : 03CH12-HY Condition : PEAK_74 3m HORN_9120D_1328 VERTICAL : RBW:1000.000KHz VBW:3000.000KHz SWT:Auto</p>
Avg.	<p>Site : 03CH12-HY Condition : AVG_BE_54 3m HORN_9120D_1328 VERTICAL : RBW:1000.000KHz VBW:1.000KHz SWT:Auto</p>	Left blank



WIFI	Band 2 5250~5350MHz Band Edge @ 3m	
ANT	802.11a CH60 5300MHz - R	
1	Vertical	Fundamental
Peak	<p>Site : 03CH2-HY Condition : PEAK_BE_74 3m HORN_91200_1328 VERTICAL : RBW:1000.000KHz VBW:3000.000KHz SWT:Auto</p>	Left blank
Avg.	<p>Site : 03CH2-HY Condition : AVG_BE_54 3m HORN_91200_1328 VERTICAL : RBW:1000.000KHz VBW:1.000KHz SWT:Auto</p>	Left blank



WIFI	Band 2 5250~5350MHz Band Edge @ 3m	
ANT	802.11a CH64 5320MHz	
1	Horizontal	Fundamental
Peak	<p>Site : 03CH12-HY Condition : PEAK_BE_74 3m HORN_91200_1328 HORIZONTAL : RBW:1000.000kHz VBW:3000.000kHz SWT:Auto</p>	<p>Site : 03CH12-HY Condition : PEAK_74 3m HORN_91200_1328 HORIZONTAL : RBW:1000.000kHz VBW:3000.000kHz SWT:Auto</p>
Avg.	<p>Site : 03CH12-HY Condition : AVG_BE_54 3m HORN_91200_1328 HORIZONTAL : RBW:1000.000kHz VBW:1.000kHz SWT:Auto</p>	Left blank



WIFI	Band 2 5250~5350MHz Band Edge @ 3m	
ANT	802.11a CH64 5320MHz	
1	Vertical	Fundamental
Peak	<p>Site : 03CH12-HY Condition : PEAK_BE_74 3m HORN_91200_1328 VERTICAL : RBW:1000.000kHz VBW:3000.000kHz SWT:Auto</p>	<p>Site : 03CH12-HY Condition : PEAK_74 3m HORN_91200_1328 VERTICAL : RBW:1000.000kHz VBW:3000.000kHz SWT:Auto</p>
Avg.	<p>Site : 03CH12-HY Condition : AVG_BE_54 3m HORN_91200_1328 VERTICAL : RBW:1000.000kHz VBW:1.000kHz SWT:Auto</p>	Left blank



Band 2 5250~5350MHz
WIFI 802.11n HT20 (Band Edge @ 3m)

WIFI	Band 2 5250~5350MHz Band Edge @ 3m	
ANT	802.11n HT20 CH52 5260MHz - L	
1	Horizontal	Fundamental
Peak		
Avg.		Left blank



WIFI	Band 2 5250~5350MHz Band Edge @ 3m	
ANT	802.11n HT20 CH52 5260MHz - R	
1	Horizontal	Fundamental
Peak	<p>Site : 03CH2-HY Condition : PEAK_BE_74 3m HORN_9120D_1328 HORIZONTAL : RBW:1000.000KHz VBW:3000.000KHz SWT:Auto</p>	Left blank
Avg.	<p>Site : 03CH2-HY Condition : AVG_BE_54 3m HORN_9120D_1328 HORIZONTAL : RBW:1000.000KHz VBW:1.000KHz SWT:Auto</p>	Left blank



WIFI	Band 2 5250~5350MHz Band Edge @ 3m	
ANT	802.11n HT20 CH52 5260MHz - L	
1	Vertical	Fundamental
Peak	<p>Site : 03CH12-HY Condition : PEAK_BE_74 3m HORN_9120D_1328 VERTICAL : RBW:1000.000KHz VBW:3000.000KHz SWT:Auto</p>	<p>Site : 03CH12-HY Condition : PEAK_74 3m HORN_9120D_1328 VERTICAL : RBW:1000.000KHz VBW:3000.000KHz SWT:Auto</p>
Avg.	<p>Site : 03CH12-HY Condition : AVG_BE_54 3m HORN_9120D_1328 VERTICAL : RBW:1000.000KHz VBW:1.000KHz SWT:Auto</p>	Left blank



WIFI	Band 2 5250~5350MHz Band Edge @ 3m	
ANT	802.11n HT20 CH52 5260MHz - R	
1	Vertical	Fundamental
Peak	<p>Site : 03CH2-HY Condition : PEAK_BE_74 3m HORN_9120D_1328 VERTICAL : RBW:1000.000KHz VBW:3000.000KHz SWT:Auto</p>	Left blank
Avg.	<p>Site : 03CH2-HY Condition : AVG_BE_54 3m HORN_9120D_1328 VERTICAL : RBW:1000.000KHz VBW:1.000KHz SWT:Auto</p>	Left blank



WIFI	Band 2 5250~5350MHz Band Edge @ 3m	
ANT	802.11n HT20 CH60 5300MHz - L	
1	Horizontal	Fundamental
Peak	<p>Site : 03CH12-HY Condition : PEAK_BE_74 3m HORN_9120D_1328 HORIZONTAL : RBW:1000.000kHz VBW:3000.000kHz SWT:Auto</p>	<p>Site : 03CH12-HY Condition : PEAK_74 3m HORN_9120D_1328 HORIZONTAL : RBW:1000.000kHz VBW:3000.000kHz SWT:Auto</p>
Avg.	<p>Site : 03CH12-HY Condition : AVG_BE_54 3m HORN_9120D_1328 HORIZONTAL : RBW:1000.000kHz VBW:1.000kHz SWT:Auto</p>	Left blank



WIFI	Band 2 5250~5350MHz Band Edge @ 3m	
ANT	802.11n HT20 CH60 5300MHz - R	
1	Horizontal	Vertical
Peak	<p>Site : 03CH12-HY Condition : PEAK_BE_74 3m HORN_9120D_1328 HORIZONTAL : RBW:1000.000kHz VBW:3000.000kHz SWT:Auto</p>	Left blank
Avg.	<p>Site : 03CH12-HY Condition : AVG_BE_54 3m HORN_9120D_1328 HORIZONTAL : RBW:1000.000kHz VBW:1.000kHz SWT:Auto</p>	Left blank



WIFI	Band 2 5250~5350MHz Band Edge @ 3m	
ANT	802.11n HT20 CH60 5300MHz - L	
1	Vertical	Fundamental
Peak	<p>Site : 03CH12-HY Condition : PEAK_BE_74 3m HORN_9120D_1328 VERTICAL : RBW:1000.000KHz VBW:3000.000KHz SWT:Auto</p>	<p>Site : 03CH12-HY Condition : PEAK_74 3m HORN_9120D_1328 VERTICAL : RBW:1000.000KHz VBW:3000.000KHz SWT:Auto</p>
Avg.	<p>Site : 03CH12-HY Condition : AVG_BE_54 3m HORN_9120D_1328 VERTICAL : RBW:1000.000KHz VBW:1.000KHz SWT:Auto</p>	Left blank



WIFI	Band 2 5250~5350MHz Band Edge @ 3m	
ANT	802.11n HT20 CH60 5300MHz - R	
1	Vertical	Fundamental
<p>Peak</p>	<p>Site : 03CH2-HY Condition : PEAK_BE_74 3m HORN_9120D_1328 VERTICAL : RBW:1000.000KHz VBW:3000.000KHz SWT:Auto</p>	<p>Left blank</p>
<p>Avg.</p>	<p>Site : 03CH2-HY Condition : AVG_BE_54 3m HORN_9120D_1328 VERTICAL : RBW:1000.000KHz VBW:1.000KHz SWT:Auto</p>	<p>Left blank</p>

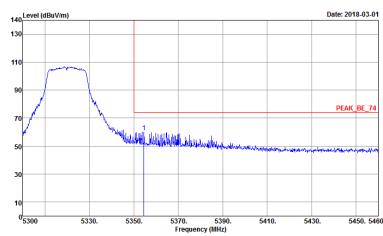
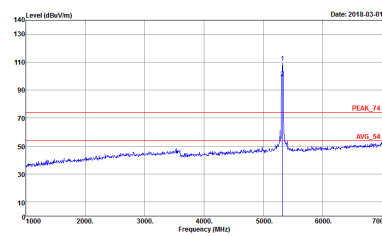
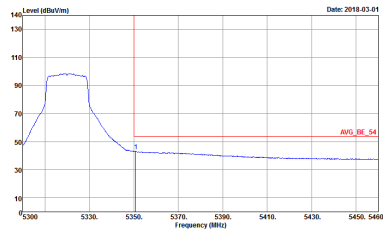

WIFI	Band 2 5250~5350MHz Band Edge @ 3m	
ANT	802.11n HT20 CH64 5320MHz	
1	Horizontal	Fundamental
Peak	 <p>Site : 03CH12-HY Condition : PEAK_BE_74 3m HORN_9120D_1328 HORIZONTAL : RBW:1000.000kHz VBW:3000.000kHz SWT:Auto</p>	 <p>Site : 03CH12-HY Condition : PEAK_74 3m HORN_9120D_1328 HORIZONTAL : RBW:1000.000kHz VBW:3000.000kHz SWT:Auto</p>
Avg.	 <p>Site : 03CH12-HY Condition : AVG_BE_54 3m HORN_9120D_1328 HORIZONTAL : RBW:1000.000kHz VBW:1.000kHz SWT:Auto</p>	Left blank



WIFI	Band 2 5250~5350MHz Band Edge @ 3m	
ANT	802.11n HT20 CH64 5320MHz	
1	Vertical	Fundamental
Peak	<p>Site : 03CH12-HY Condition : PEAK_BE_74 3m HORN_9120D_1328 VERTICAL : RBW:1000.000KHz VBW:3000.000KHz SWT:Auto</p>	<p>Site : 03CH12-HY Condition : PEAK_74 3m HORN_9120D_1328 VERTICAL : RBW:1000.000KHz VBW:3000.000KHz SWT:Auto</p>
Avg.	<p>Site : 03CH12-HY Condition : AVG_BE_54 3m HORN_9120D_1328 VERTICAL : RBW:1000.000KHz VBW:1.000KHz SWT:Auto</p>	Left blank



Band 2 5250~5350MHz
WIFI 802.11n HT40 (Band Edge @ 3m)

WIFI	Band 2 5250~5350MHz Band Edge @ 3m	
ANT	802.11n HT40 CH54 5270 MHz - L	
1	Horizontal	Fundamental
Peak	<p>Site : 03CH2-HY Condition : PEAK_BE_74 3m HORN_91200_1328 HORIZONTAL : RBW:1000.000kHz VBW:3000.000kHz SWT:Auto</p>	<p>Site : 03CH2-HY Condition : PEAK_74 3m HORN_91200_1328 HORIZONTAL : RBW:1000.000kHz VBW:3000.000kHz SWT:Auto</p>
Avg.	<p>Site : 03CH2-HY Condition : AVG_BE_54 3m HORN_91200_1328 HORIZONTAL : RBW:1000.000kHz VBW:3.000kHz SWT:Auto</p>	Left blank



WIFI	Band 2 5250~5350MHz Band Edge @ 3m	
ANT	802.11n HT40 CH54 5270 MHz - R	
1	Horizontal	Fundamental
<p>Peak</p>	<p>Site : 03CH2-HY Condition : PEAK_BE_74 3m HORN_9120D_1328 HORIZONTAL : RBW:1000.000kHz VBW:3000.000Hz SWT:Auto</p>	<p>Left blank</p>
<p>Avg.</p>	<p>Site : 03CH2-HY Condition : AVG_BE_54 3m HORN_9120D_1328 HORIZONTAL : RBW:1000.000kHz VBW:3.0000Hz SWT:Auto</p>	<p>Left blank</p>



WIFI	Band 2 5250~5350MHz Band Edge @ 3m	
ANT	802.11n HT40 CH54 5270 MHz - L	
1	Vertical	Vertical
Peak	<p>Site : 03CH12-HY Condition : PEAK_BE_74 3m HORN_9120D_1328 VERTICAL : RBW:1000.000kHz VBW:3000.000kHz SWT:Auto</p>	<p>Site : 03CH12-HY Condition : PEAK_74 3m HORN_9120D_1328 VERTICAL : RBW:1000.000kHz VBW:3000.000kHz SWT:Auto</p>
Avg.	<p>Site : 03CH12-HY Condition : AVG_BE_54 3m HORN_9120D_1328 VERTICAL : RBW:1000.000kHz VBW:3.000kHz SWT:Auto</p>	Left blank



WIFI	Band 2 5250~5350MHz Band Edge @ 3m	
ANT	802.11n HT40 CH54 5270 MHz - R	
1	Vertical	Vertical
<p>Peak</p>	<p>Site : 03CH2-HY Condition : PEAK_BE_74 3m HORN_9120D_1328 VERTICAL : RBW:1000.000kHz VBW:3000.000kHz SWT:Auto</p>	<p>Left blank</p>
<p>Avg.</p>	<p>Site : 03CH2-HY Condition : AVG_BE_54 3m HORN_9120D_1328 VERTICAL : RBW:1000.000kHz VBW:3.000kHz SWT:Auto</p>	<p>Left blank</p>



WIFI	Band 2 5250~5350MHz Band Edge @ 3m	
ANT	802.11n HT40 CH62 5310 MHz - L	
1	Horizontal	Fundamental
Peak	<p>Site : 03CH12-HY Condition : PEAK_BE_74 3m HORN_9120D_1328 HORIZONTAL : RBW:1000.000kHz VBW:3000.000kHz SWT:Auto</p>	<p>Site : 03CH12-HY Condition : PEAK_74 3m HORN_9120D_1328 HORIZONTAL : RBW:1000.000kHz VBW:3000.000kHz SWT:Auto</p>
Avg.	<p>Site : 03CH12-HY Condition : AVG_BE_54 3m HORN_9120D_1328 HORIZONTAL : RBW:1000.000kHz VBW:3000.000kHz SWT:Auto</p>	Left blank



WIFI	Band 2 5250~5350MHz Band Edge @ 3m	
ANT	802.11n HT40 CH62 5310 MHz - R	
1	Horizontal	Fundamental
<p>Peak</p>	<p>Site : 03CH2-HY Condition : PEAK_BE_74 3m HORN_9120D_1328 HORIZONTAL : RBW:1000.000kHz VBW:3000.000Hz SWT:Auto</p>	<p>Left blank</p>
<p>Avg.</p>	<p>Site : 03CH2-HY Condition : AVG_BE_54 3m HORN_9120D_1328 HORIZONTAL : RBW:1000.000kHz VBW:3.0000Hz SWT:Auto</p>	<p>Left blank</p>

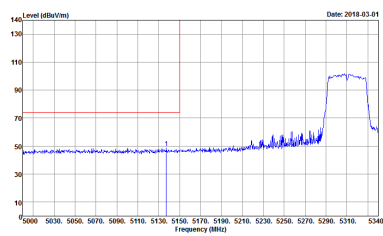
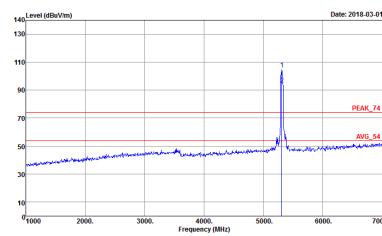
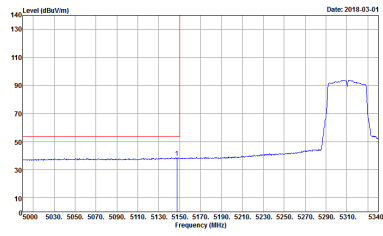

WIFI	Band 2 5250~5350MHz Band Edge @ 3m	
ANT	802.11n HT40 CH62 5310 MHz - L	
1	Vertical	Fundamental
Peak	 <p>Site : 03CH12-HY Condition : PEAK_BE_74 3m HORN_9120D_1328 VERTICAL : RBW:1000.000kHz VBW:3000.000kHz SWT:Auto</p>	 <p>Site : 03CH12-HY Condition : PEAK_74 3m HORN_9120D_1328 VERTICAL : RBW:1000.000kHz VBW:3000.000kHz SWT:Auto</p>
Avg.	 <p>Site : 03CH12-HY Condition : AVG_BE_54 3m HORN_9120D_1328 VERTICAL : RBW:1000.000kHz VBW:3000.000kHz SWT:Auto</p>	Left blank



WIFI	Band 2 5250~5350MHz Band Edge @ 3m	
ANT	802.11n HT40 CH62 5310 MHz - R	
1	Vertical	Fundamental
<p>Peak</p>	<p>Site : 03CH12-HY Condition : PEAK_BE_74 3m HORN_9120D_1328 VERTICAL : RBW:1000.000kHz VBW:3000.000kHz SWT:Auto</p>	<p>Left blank</p>
<p>Avg.</p>	<p>Site : 03CH12-HY Condition : AVG_BE_54 3m HORN_9120D_1328 VERTICAL : RBW:1000.000kHz VBW:3.000kHz SWT:Auto</p>	<p>Left blank</p>



Band 2 5250~5350MHz
WIFI 802.11ac VHT80 (Band Edge @ 3m)

WIFI	Band 2 5250~5350MHz Band Edge @ 3m	
ANT	802.11ac VHT80 CH58 5290MHz - L	
1	Horizontal	Fundamental
Peak	<p>Site : 03CH2-HY Condition : PEAK_BE_74 3m HORN_9120D_1328 HORIZONTAL : RBW:1000.000kHz VBW:3000.000kHz SWT:Auto</p>	<p>Site : 03CH2-HY Condition : PEAK_74 3m HORN_9120D_1328 HORIZONTAL : RBW:1000.000kHz VBW:3000.000kHz SWT:Auto</p>
Avg.	<p>Site : 03CH2-HY Condition : AVG_BE_54 3m HORN_9120D_1328 HORIZONTAL : RBW:1000.000kHz VBW:3.000kHz SWT:Auto</p>	Left blank



WIFI	Band 2 5250~5350MHz Band Edge @ 3m	
ANT	802.11ac VHT80 CH58 5290MHz - R	
1	Horizontal	Fundamental
<p>Peak</p>		<p>Left blank</p>
<p>Avg.</p>		<p>Left blank</p>



WIFI	Band 2 5250~5350MHz Band Edge @ 3m	
ANT	802.11ac VHT80 CH58 5290MHz - L	
1	Vertical	Fundamental
Peak	<p>Site : 03CH2-HY Condition : PEAK_BE_74 3m HORN_9120D_1328 VERTICAL : RBW:1000.000kHz VBW:3000.000kHz SWT:Auto</p>	<p>Site : 03CH2-HY Condition : PEAK_74 3m HORN_9120D_1328 VERTICAL : RBW:1000.000kHz VBW:3000.000kHz SWT:Auto</p>
Avg.	<p>Site : 03CH2-HY Condition : AVG_BE_54 3m HORN_9120D_1328 VERTICAL : RBW:1000.000kHz VBW:3000.000kHz SWT:Auto</p>	Left blank



WIFI	Band 2 5250~5350MHz Band Edge @ 3m	
ANT	802.11ac VHT80 CH58 5290MHz - R	
1	Vertical	Fundamental
Peak	<p>Site : 03CH12-HY Condition : PEAK_BE_74 3m HORN_91200_1328 VERTICAL : RBW:1000.000kHz VBW:3000.000kHz SWT:Auto</p>	Left blank
Avg.	<p>Site : 03CH12-HY Condition : AVG_BE_54 3m HORN_91200_1328 VERTICAL : RBW:1000.000kHz VBW:3.0000kHz SWT:Auto</p>	Left blank



Band 2 - 5250~5350MHz
WIFI 802.11a (Harmonic @ 3m)

Table with 2 columns: Horizontal and Vertical. Each column contains a spectral plot showing Level (dBuV/m) vs Frequency (MHz) with peak and average values indicated. Includes site and condition details for both orientations.



WIFI	Band 2 5250~5350MHz Harmonic @ 3m	
ANT	802.11a CH60 5300MHz	
1	Horizontal	Vertical
Peak Avg.	<p>Site : 03CH12-HY Condition : PEAK_74 3m HORN_9120D_1328 HORIZONTAL Detector : Peak</p>	<p>Site : 03CH12-HY Condition : PEAK_74 3m HORN_9120D_1328 VERTICAL Detector : Peak</p>



WIFI	Band 2 5250~5350MHz Harmonic @ 3m	
ANT	802.11a CH64 5320MHz	
1	Horizontal	Vertical
Peak Avg.	<p>Site : 03CH12-HY Condition : PEAK_74 3m HORN_9120D_1328 HORIZONTAL Detector : Peak</p>	<p>Site : 03CH12-HY Condition : PEAK_74 3m HORN_9120D_1328 VERTICAL Detector : Peak</p>



Band 2 5250~5350MHz
WIFI 802.11n HT20 (Harmonic @ 3m)

WIFI	Band 2 5250~5350MHz Harmonic @ 3m	
ANT	802.11n HT20 CH52 5260MHz	
1	Horizontal	Vertical
Peak Avg.	<p>Site : 03CH12-IY Condition : PEAK_74 3m HORN_91200_1328 HORIZONTAL Detector : Peak</p>	<p>Site : 03CH12-IY Condition : PEAK_74 3m HORN_91200_1328 VERTICAL Detector : Peak</p>



WIFI	Band 2 5250~5350MHz Harmonic @ 3m	
ANT	802.11n HT20 CH60 5300MHz	
1	Horizontal	Vertical
Peak Avg.	<p>Site : 03CH12-HY Condition : PEAK_74 3m HORN_9120D_1328 HORIZONTAL Detector : Peak</p>	<p>Site : 03CH12-HY Condition : PEAK_74 3m HORN_9120D_1328 VERTICAL Detector : Peak</p>



WIFI	Band 2 5250~5350MHz Harmonic @ 3m	
ANT	802.11n HT20 CH64 5320MHz	
1	Horizontal	Vertical
Peak Avg.	<p>Site : 03CH12-HY Condition : PEAK_74 3m HORN_9120D_1328 HORIZONTAL Detector : Peak</p>	<p>Site : 03CH12-HY Condition : PEAK_74 3m HORN_9120D_1328 VERTICAL Detector : Peak</p>



Band 2 5250~5350MHz
WIFI 802.11n HT40 (Harmonic @ 3m)

WIFI	Band 2 5250~5350MHz Harmonic @ 3m	
ANT	802.11n HT40 CH54 5270MHz	
1	Horizontal	Vertical
Peak Avg.	<p>Site : 03CH12-IY Condition : PEAK_74 3m HORN_9120D_1328 HORIZONTAL Detector : Peak</p>	<p>Site : 03CH12-IY Condition : PEAK_74 3m HORN_9120D_1328 VERTICAL Detector : Peak</p>

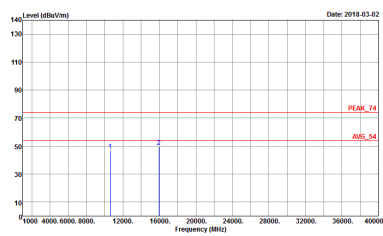
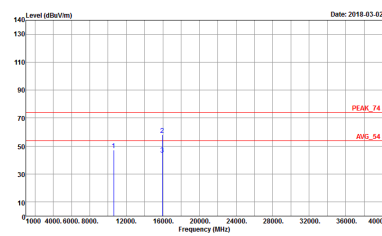

WIFI	Band 2 5250~5350MHz Harmonic @ 3m	
ANT	802.11n HT40 CH62 5310 MHz	
1	Horizontal	Vertical
<p>Peak Avg.</p>	 <p>Site : 03CH12-HY Condition : PEAK_74 3m HORN_9120D_1328 HORIZONTAL Detector : Peak</p>	 <p>Site : 03CH12-HY Condition : PEAK_74 3m HORN_9120D_1328 VERTICAL Detector : Peak</p>



Band 2 5250~5350MHz
WIFI 802.11ac VHT80 (Harmonic @ 3m)

WIFI	Band 2 5250~5350MHz Harmonic @ 3m	
ANT	802.11ac VHT80 CH58 5290MHz	
1	Horizontal	Vertical
Peak Avg.	<p>Site : 03CH12-HY Condition : PEAK_74 3m HORN_9120D_1328 HORIZONTAL Detector : Peak</p>	<p>Site : 03CH12-HY Condition : PEAK_74 3m HORN_9120D_1328 VERTICAL Detector : Peak</p>



Band 3 - 5470~5725MHz
WIFI 802.11a (Band Edge @ 3m)

WIFI	Band 3 5470~5725MHz Band Edge @ 3m	
ANT	802.11a CH100 5500MHz	
1	Horizontal	Fundamental
Peak	<p>Site : 03CH12-HY Condition : PEAK_BE(UNIT)_B3 3m HORN_9120D_1328 HORIZONTAL : RBW:1000.000KHz VBW:3000.000KHz SWT:Auto</p>	<p>Site : 03CH12-HY Condition : PEAK(UNIT) 3m HORN_9120D_1328 HORIZONTAL : RBW:1000.000KHz VBW:3000.000KHz SWT:Auto</p>
Avg.	<p>Site : 03CH12-HY Condition : AVG_BE(UNIT)_B3 3m HORN_9120D_1328 HORIZONTAL : RBW:1000.000KHz VBW:1.000KHz SWT:Auto</p>	Left blank



WIFI	Band 3 5470~5725MHz Band Edge @ 3m	
ANT	802.11a CH100 5500MHz	
1	Vertical	Fundamental
Peak	<p>Site : 03CH12-HY Condition : PEAK_BE(UNIT)_B3 3m HORN_9120D_1328 VERTICAL : RBW:1000.000kHz VBW:3000.000kHz SWT:Auto</p>	<p>Site : 03CH12-HY Condition : PEAK(UNIT) 3m HORN_9120D_1328 VERTICAL : RBW:1000.000kHz VBW:3000.000kHz SWT:Auto</p>
Avg.	<p>Site : 03CH12-HY Condition : AVG_BE(UNIT)_B3 3m HORN_9120D_1328 VERTICAL : RBW:1000.000kHz VBW:1.000kHz SWT:Auto</p>	Left blank



WIFI	Band 3 5470~5725MHz Band Edge @ 3m	
ANT	802.11a CH116 5580MHz - L	
1	Horizontal	Fundamental
Peak	<p>Site : 03CH12-HY Condition : PEAK_BE(UNIT)_B3 3m HORN_9120D_1328 HORIZONTAL : RBW:1000.000kHz VBW:3000.000kHz SWT:Auto</p>	<p>Site : 03CH12-HY Condition : PEAK(UNIT) 3m HORN_9120D_1328 HORIZONTAL : RBW:1000.000kHz VBW:3000.000kHz SWT:Auto</p>
Avg.	<p>Site : 03CH12-HY Condition : AVG_BE(UNIT)_B3 3m HORN_9120D_1328 HORIZONTAL : RBW:1000.000kHz VBW:1.000kHz SWT:Auto</p>	Left blank

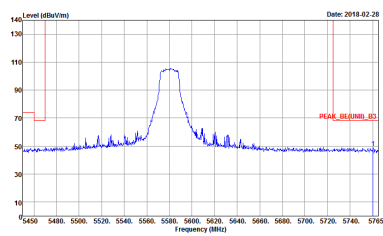

WIFI	Band 3 5470~5725MHz Band Edge @ 3m	
ANT	802.11a CH116 5580MHz - R	
1	Horizontal	Fundamental
Peak	 <p>Site : 03CH2-HV Condition : PEAK_SECUNITE], 33 3m HORN_9120D_1328 HORIZONTAL : RBW:1000.000kHz VBW:3000.000kHz SWT:Auto</p>	Left blank



WIFI	Band 3 5470~5725MHz Band Edge @ 3m	
ANT	802.11a CH116 5580MHz - L	
1	Vertical	Fundamental
Peak	<p>Site : 03CH12-HY Condition : PEAK_BE(UNIT)_B3 3m HORN_91200_1328 VERTICAL : RBW:1000.000kHz VBW:3000.000kHz SWT:Auto</p>	<p>Site : 03CH12-HY Condition : PEAK(UNIT) 3m HORN_91200_1328 VERTICAL : RBW:1000.000kHz VBW:3000.000kHz SWT:Auto</p>
Avg.	<p>Site : 03CH12-HY Condition : AVG_BE(UNIT)_B3 3m HORN_91200_1328 VERTICAL : RBW:1000.000kHz VBW:1.000kHz SWT:Auto</p>	Left blank



WIFI	Band 3 5470~5725MHz Band Edge @ 3m	
ANT	802.11a CH116 5580MHz - R	
1	Vertical	Fundamental
Peak	<p>Site : 03CH2-HY Condition : PEAK_SECUNITE], 33 3m HORN_9120D_1328 VERTICAL : RBW:1000.000kHz VBW:3000.000Hz SWT:Auto</p>	Left blank



WIFI	Band 3 5470~5725MHz Band Edge @ 3m	
ANT	802.11a CH140 5700MHz	
1	Horizontal	Fundamental
Peak	<p>Site : 03CH2-HY Condition : PEAK_B3(UMI)_B3 3m HORN_9120D_1338 HORIZONTAL : RBW:1000.000kHz VBW:3000.000kHz SWT:Auto</p>	<p>Site : 03CH2-HY Condition : PEAK(UMI)_AUG_54 3m HORN_9120D_1338 HORIZONTAL : RBW:1000.000kHz VBW:3000.000kHz SWT:Auto</p>



WIFI	Band 3 5470~5725MHz Band Edge @ 3m	
ANT	802.11a CH140 5700MHz	
1	Vertical	Fundamental
Peak	<p>Site : 03CH2-HY Condition : PEAK_B3(UMI)_B3 3m HORN_91200_1338 VERTICAL : RBW:1000.000kHz VBW:3000.000kHz SWT:Auto</p>	<p>Site : 03CH2-HY Condition : PEAK(UMI)_AUG_54 3m HORN_91200_1338 VERTICAL : RBW:1000.000kHz VBW:3000.000kHz SWT:Auto</p>

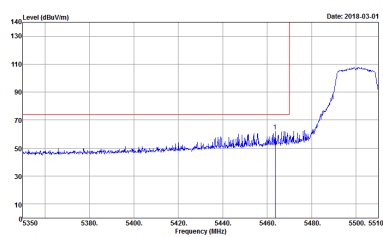
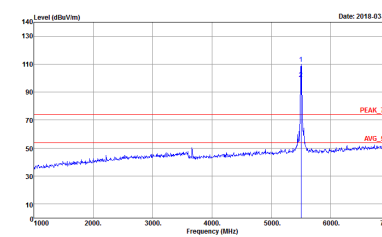
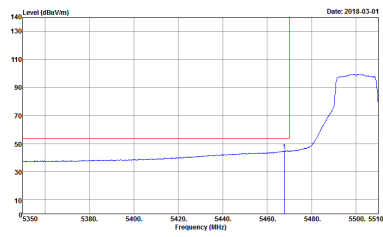

Band 3 5470~5725MHz
WIFI 802.11n HT20 (Band Edge @ 3m)

WIFI	Band 3 5470~5725MHz Band Edge @ 3m	
ANT	802.11n HT20 CH100 5500MHz	
1	Horizontal	Fundamental
Peak	 <p>Site : 03CH12-HY Condition : PEAK_BE_74 3m HORN_9120D_1328 HORIZONTAL : RBW:1000.000kHz VBW:3000.000kHz SWT:Auto</p>	 <p>Site : 03CH12-HY Condition : PEAK_74 3m HORN_9120D_1328 HORIZONTAL : RBW:1000.000kHz VBW:3000.000kHz SWT:Auto</p>
Avg.	 <p>Site : 03CH12-HY Condition : AVG_BE_54 3m HORN_9120D_1328 HORIZONTAL : RBW:1000.000kHz VBW:1.000kHz SWT:Auto</p>	Left blank



WIFI	Band 3 5470~5725MHz Band Edge @ 3m	
ANT	802.11n HT20 CH100 5500MHz	
1	Vertical	Fundamental
Peak	<p>Site : 03CH12-HY Condition : PEAK_BE_74 3m HORN_9120D_1328 VERTICAL : RBW:1000.000kHz VBW:3000.000kHz SWT:Auto</p>	<p>Site : 03CH12-HY Condition : PEAK_74 3m HORN_9120D_1328 VERTICAL : RBW:1000.000kHz VBW:3000.000kHz SWT:Auto</p>
Avg.	<p>Site : 03CH12-HY Condition : AVG_BE_54 3m HORN_9120D_1328 VERTICAL : RBW:1000.000kHz VBW:1.000kHz SWT:Auto</p>	Left blank



WIFI	Band 3 5470~5725MHz Band Edge @ 3m	
ANT	802.11n HT20 CH116 5580MHz - L	
1	Horizontal	Fundamental
Peak	<p>Site : 03CH12-HY Condition : PEAK_BE(UNIT)_B3 3m HORN_9120D_1328 HORIZONTAL : RBW:1000.000kHz VBW:3000.000kHz SWT:Auto</p>	<p>Site : 03CH12-HY Condition : PEAK(UNIT) 3m HORN_9120D_1328 HORIZONTAL : RBW:1000.000kHz VBW:3000.000kHz SWT:Auto</p>
Avg.	<p>Site : 03CH12-HY Condition : AVG_BE(UNIT)_B3 3m HORN_9120D_1328 HORIZONTAL : RBW:1000.000kHz VBW:1.000kHz SWT:Auto</p>	Left blank



WIFI	Band 3 5470~5725MHz Band Edge @ 3m	
ANT	802.11n HT20 CH116 5580MHz - R	
1	Horizontal	Fundamental
Peak	<p>Site : 03CH2-HV Condition : PEAK_SECUNITE], 33 3m HORN_9120D_1328 HORIZONTAL : RBW:1000.000kHz VBW:3000.000kHz SWT:Auto</p>	Left blank



WIFI	Band 3 5470~5725MHz Band Edge @ 3m	
ANT	802.11n HT20 CH116 5580MHz - L	
1	Vertical	Fundamental
Peak	<p>Site : 03CH12-HY Condition : PEAK_BE(UNIT)_B3 3m HORN_9120D_1328 VERTICAL : RBW:1000.000kHz VBW:3000.000kHz SWT:Auto</p>	<p>Site : 03CH12-HY Condition : PEAK(UNIT) 3m HORN_9120D_1328 VERTICAL : RBW:1000.000kHz VBW:3000.000kHz SWT:Auto</p>
Avg.	<p>Site : 03CH12-HY Condition : AVG_BE(UNIT)_B3 3m HORN_9120D_1328 VERTICAL : RBW:1000.000kHz VBW:1.000kHz SWT:Auto</p>	Left blank



WIFI	Band 3 5470~5725MHz Band Edge @ 3m	
ANT	802.11n HT20 CH116 5580MHz - R	
1	Vertical	Fundamental
Peak	<p>Site : 03CH2-HV Condition : PEAK_SECUNITE], 33 3m HORN_9120D_1328 VERTICAL : RBW:1000.000kHz VBW:3000.000GHz SWT:Auto</p>	Left blank



WIFI	Band 3 5470~5725MHz Band Edge @ 3m	
ANT	802.11n HT20 CH140 5700MHz	
1	Horizontal	Fundamental
Peak	<p>Site : 03CH12-HY Condition : PEAK_B3(UMI)_B3 3m HORN_9120D_1338 HORIZONTAL : RBW:1000.000kHz VBW:3000.000kHz SWT:Auto</p>	<p>Site : 03CH12-HY Condition : PEAK(UMI)_AUG_54 3m HORN_9120D_1338 HORIZONTAL : RBW:1000.000kHz VBW:3000.000kHz SWT:Auto</p>



WIFI	Band 3 5470~5725MHz Band Edge @ 3m	
ANT	802.11n HT20 CH140 5700MHz	
1	Vertical	Fundamental
Peak.	<p>Site : 03CH12-HY Condition : PEAK_06(UMI)_B3 3m HORN_91200_1338 VERTICAL : RBW:1000.000kHz VBW:3000.000kHz SWT:Auto</p>	<p>Site : 03CH12-HY Condition : PEAK_06(UMI)_B3 3m HORN_91200_1338 VERTICAL : RBW:1000.000kHz VBW:3000.000kHz SWT:Auto</p>



Band 3 5470~5725MHz
WIFI 802.11n HT40 (Band Edge @ 3m)

Table with 2 columns (WIFI, ANT) and 2 rows (Peak, Avg.). The 'Peak' row contains 'Horizontal' and 'Fundamental' plots. The 'Avg.' row contains a 'Horizontal' plot and 'Left blank' text.

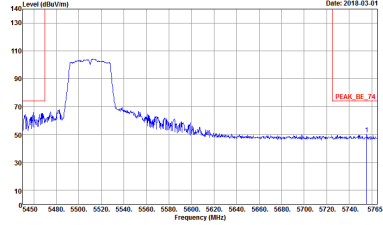
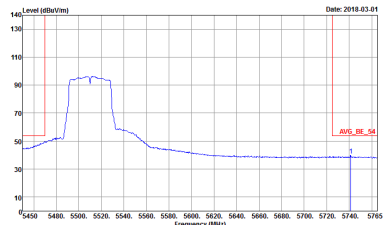

WIFI	Band 3 5470~5725MHz Band Edge @ 3m	
ANT	802.11n HT40 CH102 5510MHz - R	
1	Horizontal	Fundamental
<p>Peak</p>	 <p>Site : 03CH12-HY Condition : PEAK_BE_74 3m HORN_9120D_1328 HORIZONTAL RBW:1000.000KHz VBW:3000.000KHz SWT:Auto</p>	<p>Left blank</p>
<p>Avg.</p>	 <p>Site : 03CH12-HY Condition : AVG_BE_54 3m HORN_9120D_1328 HORIZONTAL RBW:1000.000KHz VBW:3.000KHz SWT:Auto</p>	<p>Left blank</p>



WIFI	Band 3 5470~5725MHz Band Edge @ 3m	
ANT	802.11n HT40 CH102 5510MHz - L	
1	Vertical	Fundamental
Peak		
Avg.		Left blank

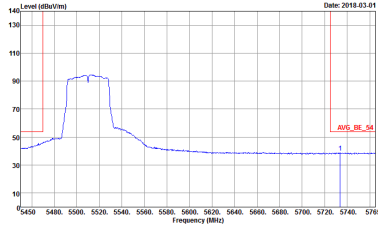

WIFI	Band 3 5470~5725MHz Band Edge @ 3m	
ANT	802.11n HT40 CH102 5510MHz - R	
1	Vertical	Fundamental
Peak	 <p>Site : 03CH12-HY Condition : PEAK_BE_74 3m HORN_9120D_1328 VERTICAL RBW:1000.000KHz VBW:3000.000KHz SWT:Auto</p>	Left blank
Avg.	 <p>Site : 03CH12-HY Condition : AVG_BE_54 3m HORN_9120D_1328 VERTICAL RBW:1000.000KHz VBW:3.000KHz SWT:Auto</p>	Left blank



WIFI	Band 3 5470~5725MHz Band Edge @ 3m	
ANT	802.11n HT40 CH110 5550MHz - L	
1	Horizontal	Fundamental
Peak	<p>Site : 03CH12-HY Condition : PEAK_BE(UNIT)_B3 3m HORN_91200_1328 HORIZONTAL : RBW:1000.000kHz VBW:3000.000kHz SWT:Auto</p>	<p>Site : 03CH12-HY Condition : PEAK(UNIT) 3m HORN_91200_1328 HORIZONTAL : RBW:1000.000kHz VBW:3000.000kHz SWT:Auto</p>
Avg.	<p>Site : 03CH12-HY Condition : AVG_BE(UNIT)_B3 3m HORN_91200_1328 HORIZONTAL : RBW:1000.000kHz VBW:3000.000kHz SWT:Auto</p>	Left blank

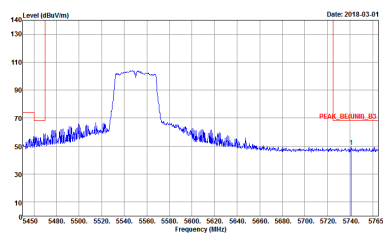

WIFI	Band 3 5470~5725MHz Band Edge @ 3m	
ANT	802.11n HT40 CH110 5550MHz - R	
1	Horizontal	Fundamental
Peak	 <p>Site : 03CH2-HV Condition : PEAK_SECUNITE], 33 3m HORN_9120D_1328 HORIZONTAL : RBW:1000.000kHz VBW:3000.000GHz SWT:Auto</p>	Left blank



WIFI	Band 3 5470~5725MHz Band Edge @ 3m	
ANT	802.11n HT40 CH110 5550MHz - L	
1	Vertical	Fundamental
Peak	<p>Site : 03CH12-HY Condition : PEAK_BE(UNIT)_B3 3m HORN_91200_1328 VERTICAL : RBW:1000.000kHz VBW:3000.000kHz SWT:Auto</p>	<p>Site : 03CH12-HY Condition : PEAK(UNIT) 3m HORN_91200_1328 VERTICAL : RBW:1000.000kHz VBW:3000.000kHz SWT:Auto</p>
Avg.	<p>Site : 03CH12-HY Condition : AVG_BE(UNIT)_B3 3m HORN_91200_1328 VERTICAL : RBW:1000.000kHz VBW:3.000kHz SWT:Auto</p>	Left blank

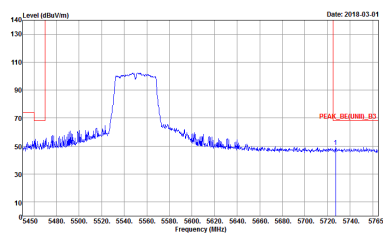

WIFI	Band 3 5470~5725MHz Band Edge @ 3m	
ANT	802.11n HT40 CH110 5550MHz - R	
1	Vertical	Fundamental
Peak	 <p>Site : 03CH2-HV Condition : PEAK_SECUNITE], 33 3m HORN_9120D_1328 VERTICAL : RBW:1000.000kHz VBW:3000.000GHz SWT:Auto</p>	Left blank



WIFI	Band 3 5470~5725MHz Band Edge @ 3m	
ANT	802.11n HT40 CH134 5670MHz - L	
1	Horizontal	Fundamental
Peak	<p>Site : 03CH12-HY Condition : PEAK_BE(UNIT)_B3 3m HORN_9120D_1328 HORIZONTAL : RBW:1000.000kHz VBW:3000.000kHz SWT:Auto</p>	<p>Site : 03CH12-HY Condition : PEAK(UNIT) 3m HORN_9120D_1328 HORIZONTAL : RBW:1000.000kHz VBW:3000.000kHz SWT:Auto</p>
Avg.	<p>Site : 03CH12-HY Condition : AVG_BE(UNIT)_B3 3m HORN_9120D_1328 HORIZONTAL : RBW:1000.000kHz VBW:3.000kHz SWT:Auto</p>	Left blank

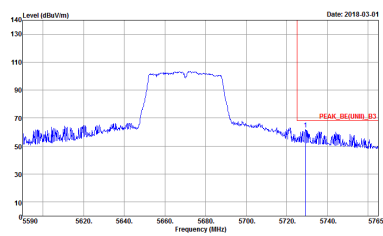

WIFI	Band 3 5470~5725MHz Band Edge @ 3m	
ANT	802.11n HT40 CH134 5670MHz - R	
1	Horizontal	Fundamental
Peak	 <p>Site : 03CH2-HY Condition : PEAK_SECUMI1, 33 3m HORN_9120D_1328 HORIZONTAL RBW:1000.000kHz VBW:3000.000kHz SWT:Auto</p>	Left blank



WIFI	Band 3 5470~5725MHz Band Edge @ 3m	
ANT	802.11n HT40 CH134 5670MHz - L	
1	Vertical	Fundamental
Peak	<p>Site : 03CH12-HY Condition : PEAK_BE(UNIT)_B3 3m HORN_9120D_1328 VERTICAL : RBW:1000.000kHz VBW:3000.000kHz SWT:Auto</p>	<p>Site : 03CH12-HY Condition : PEAK(UNIT) 3m HORN_9120D_1328 VERTICAL : RBW:1000.000kHz VBW:3000.000kHz SWT:Auto</p>
Avg.	<p>Site : 03CH12-HY Condition : AVG_BE(UNIT)_B3 3m HORN_9120D_1328 VERTICAL : RBW:1000.000kHz VBW:3.000kHz SWT:Auto</p>	Left blank



WIFI	Band 3 5470~5725MHz Band Edge @ 3m	
ANT	802.11n HT40 CH134 5670MHz - R	
1	Vertical	Fundamental
Peak	<p>Site : 03CH2-HY Condition : PEAK_RELINB_B3 3m HORN_9120D_1328 VERTICAL : RBW:1000.000kHz VBW:3000.000GHz SWT:Auto</p>	Left blank

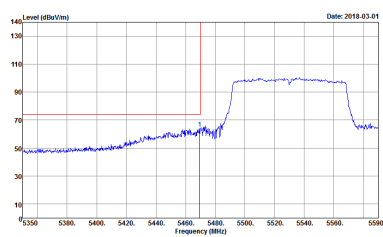
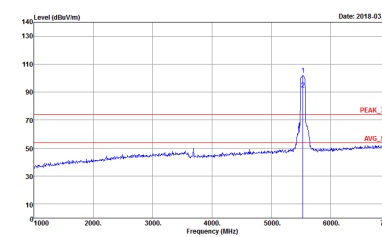
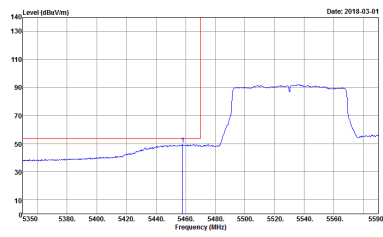

Band 3 5470~5725MHz
WIFI 802.11ac VHT80 (Band Edge @ 3m)

WIFI	Band 3 5470~5725MHz Band Edge @ 3m	
ANT	802.11ac VHT80 CH106 5530MHz - L	
1	Horizontal	Fundamental
Peak	 <p>Site : 03CH12-HY Condition : PEAK_BE_74 3m HORN_91200_1328 HORIZONTAL : RBW:1000.000kHz VBW:3000.000kHz SWT:Auto</p>	 <p>Site : 03CH12-HY Condition : PEAK_74 3m HORN_91200_1328 HORIZONTAL : RBW:1000.000kHz VBW:3000.000kHz SWT:Auto</p>
Avg.	 <p>Site : 03CH12-HY Condition : AVG_BE_54 3m HORN_91200_1328 HORIZONTAL : RBW:1000.000kHz VBW:3.000kHz SWT:Auto</p>	Left blank



WIFI	Band 3 5470~5725MHz Band Edge @ 3m	
ANT	802.11ac VHT80 CH106 5530MHz - R	
1	Horizontal	Fundamental
Peak	<p>Site : 03CH12-HY Condition : PEAK_BE_74 3m HORN_9120D_1328 HORIZONTAL RBW:1000.000KHz VBW:3000.000KHz SWT:Auto</p>	Left blank
Avg.	<p>Site : 03CH12-HY Condition : AVG_BE_54 3m HORN_9120D_1328 HORIZONTAL RBW:1000.000KHz VBW:3.000KHz SWT:Auto</p>	Left blank



WIFI	Band 3 5470~5725MHz Band Edge @ 3m	
ANT	802.11ac VHT80 CH106 5530MHz - L	
1	Vertical	Fundamental
Peak	<p>Site : 03CH12-HY Condition : PEAK_BE_74 3m HORN_9120D_1328 VERTICAL : RBW:1000.000KHz VBW:3000.000KHz SWT:Auto</p>	<p>Site : 03CH12-HY Condition : PEAK_74 3m HORN_9120D_1328 VERTICAL : RBW:1000.000KHz VBW:3000.000KHz SWT:Auto</p>
Avg.	<p>Site : 03CH12-HY Condition : AVG_BE_54 3m HORN_9120D_1328 VERTICAL : RBW:1000.000KHz VBW:3.000KHz SWT:Auto</p>	Left blank



WIFI	Band 3 5470~5725MHz Band Edge @ 3m	
ANT	802.11ac VHT80 CH106 5530MHz - R	
1	Vertical	Fundamental
Peak	<p>Site : 03CH12-HY Condition : PEAK_BE_74 3m HORN_9120D_1328 VERTICAL RBW:1000.000KHz VBW:3000.000KHz SWT:Auto</p>	Left blank
Avg.	<p>Site : 03CH12-HY Condition : AVG_BE_54 3m HORN_9120D_1328 VERTICAL RBW:1000.000KHz VBW:3.000KHz SWT:Auto</p>	Left blank



WIFI	Band 3 5470~5725MHz Band Edge @ 3m	
ANT	802.11ac VHT80 CH122 5610MHz - L	
1	Horizontal	Fundamental
Peak	<p>Site : 03CH12-HY Condition : PEAK_BE(UNIT)_B3 3m HORN_9120D_1328 HORIZONTAL : RBW:1000.000kHz VBW:3000.000kHz SWT:Auto</p>	<p>Site : 03CH12-HY Condition : PEAK(UNIT) 3m HORN_9120D_1328 HORIZONTAL : RBW:1000.000kHz VBW:3000.000kHz SWT:Auto</p>
Avg.	<p>Site : 03CH12-HY Condition : AVG_BE(UNIT)_B3 3m HORN_9120D_1328 HORIZONTAL : RBW:1000.000kHz VBW:3.000kHz SWT:Auto</p>	Left blank



WIFI	Band 3 5470~5725MHz Band Edge @ 3m	
ANT	802.11ac VHT80 CH122 5610MHz - R	
1	Horizontal	Fundamental
Peak	<p>Site : 03CH2-HY Condition : PEAK_SECUNITE], 33 3m HORN_9120D_1328 HORIZONTAL : RBW:1000.000kHz VBW:3000.000GHz SWT:Auto</p>	Left blank



WIFI	Band 3 5470~5725MHz Band Edge @ 3m	
ANT	802.11ac VHT80 CH122 5610MHz - L	
1	Vertical	Fundamental
Peak	<p>Site : 03CH12-HY Condition : PEAK_BE(UNIT)_B3 3m HORN_9120D_1328 VERTICAL : RBW:1000.000kHz VBW:3000.000kHz SWT:Auto</p>	<p>Site : 03CH12-HY Condition : PEAK(UNIT) 3m HORN_9120D_1328 VERTICAL : RBW:1000.000kHz VBW:3000.000kHz SWT:Auto</p>
Avg.	<p>Site : 03CH12-HY Condition : AVG_BE(UNIT)_B3 3m HORN_9120D_1328 VERTICAL : RBW:1000.000kHz VBW:3.000kHz SWT:Auto</p>	Left blank



WIFI	Band 3 5470~5725MHz Band Edge @ 3m	
ANT	802.11ac VHT80 CH122 5610MHz - R	
1	Vertical	Fundamental
Peak	<p>Site : 03CHZ-11Y Condition : PEAK_RE(UMI)_B3 3m HORN_9120D_1328 VERTICAL RBW:1000.0000kHz VBW:3000.0000kHz SWT:Auto Detector : Peak Project : 811821-02 Mode : 29</p>	Left blank



Band 3 - 5470~5725MHz
WIFI 802.11a (Harmonic @ 3m)

WIFI	Band 3 5470~5725MHz Harmonic @ 3m	
ANT	802.11a CH100 5500MHz	
1	Horizontal	Vertical
Peak Avg.	<p>Site : 03CH12-HY Condition : PEAK(UNIT) 3m HORN_9120D_1328 HORIZONTAL Detector : Peak</p>	<p>Site : 03CH12-HY Condition : PEAK(UNIT) 3m HORN_9120D_1328 VERTICAL Detector : Peak</p>



WIFI	Band 3 5470~5725MHz Harmonic @ 3m	
ANT	802.11a CH116 5580MHz	
1	Horizontal	Vertical
Peak Avg.	<p>Site : 03CH12-HY Condition : PEAK(UNIT) 3m HORN_9120D_1328 HORIZONTAL Detector : Peak</p>	<p>Site : 03CH12-HY Condition : PEAK(UNIT) 3m HORN_9120D_1328 VERTICAL Detector : Peak</p>



WIFI	Band 3 5470~5725MHz Harmonic @ 3m	
ANT	802.11a CH140 5700MHz	
1	Horizontal	Vertical
Peak Avg.	<p>Site : 03CH12-HY Condition : PEAK(UNIT) 3m HORN_9120D_1328 HORIZONTAL Detector : Peak</p>	<p>Site : 03CH12-HY Condition : PEAK(UNIT) 3m HORN_9120D_1328 VERTICAL Detector : Peak</p>



**Band 3 5470~5725MHz
WIFI 802.11n HT20 (Harmonic @ 3m)**

WIFI	Band 3 5470~5725MHz Harmonic @ 3m	
ANT	802.11n HT20 CH100 5500MHz	
1	Horizontal	Vertical
Peak Avg.	<p>Site : 03CH12-HY Condition : PEAK_74 3m HORN_91200_1328 HORIZONTAL Detector : Peak</p>	<p>Site : 03CH12-HY Condition : PEAK_74 3m HORN_91200_1328 VERTICAL Detector : Peak</p>



WIFI	Band 3 5470~5725MHz Harmonic @ 3m	
ANT	802.11n HT20 CH116 5580MHz	
1	Horizontal	Vertical
Peak Avg.	<p>Site : 03CH12-HY Condition : PEAK(UNIT) 3m HORN_9120D_1328 HORIZONTAL Detector : Peak</p>	<p>Site : 03CH12-HY Condition : PEAK(UNIT) 3m HORN_9120D_1328 VERTICAL Detector : Peak</p>



WIFI	Band 3 5470~5725MHz Harmonic @ 3m	
ANT	802.11n HT20 CH140 5700MHz	
1	Horizontal	Vertical
Peak Avg.	<p>Site : 03CH12-HY Condition : PEAK(UNIT) 3m HORN_9120D_1328 HORIZONTAL Detector : Peak</p>	<p>Site : 03CH12-HY Condition : PEAK(UNIT) 3m HORN_9120D_1328 VERTICAL Detector : Peak</p>



Band 3 5470~5725MHz
WIFI 802.11n HT40 (Harmonic @ 3m)

WIFI	Band 3 5470~5725MHz Harmonic @ 3m	
ANT	802.11n HT40 CH102 5510MHz	
1	Horizontal	Vertical
Peak Avg.	<p>Site : 03CH12-IY Condition : PEAK_74 3m HORN_9120D_1328 HORIZONTAL Detector : Peak</p>	<p>Site : 03CH12-IY Condition : PEAK_74 3m HORN_9120D_1328 VERTICAL Detector : Peak</p>



WIFI	Band 3 5470~5725MHz Harmonic @ 3m	
ANT	802.11n HT40 CH110 5550MHz	
1	Horizontal	Vertical
Peak Avg.	<p>Site : 03CH12-HY Condition : PEAK(UNIT) 3m HORN_9120D_1328 HORIZONTAL Detector : Peak</p>	<p>Site : 03CH12-HY Condition : PEAK(UNIT) 3m HORN_9120D_1328 VERTICAL Detector : Peak</p>

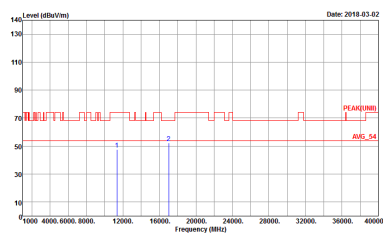
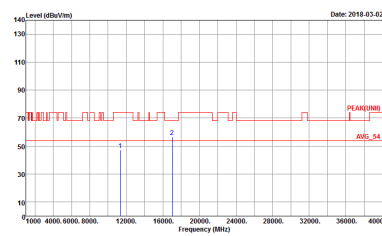

WIFI	Band 3 5470~5725MHz Harmonic @ 3m	
ANT	802.11n HT40 CH134 5670MHz	
1	Horizontal	Vertical
<p>Peak Avg.</p>	 <p>Site : 03CH12-HY Condition : PEAK(UNIT) 3m HORN_9120D_1328 HORIZONTAL Detector : Peak</p>	 <p>Site : 03CH12-HY Condition : PEAK(UNIT) 3m HORN_9120D_1328 VERTICAL Detector : Peak</p>



Band 3 5470~5725MHz
WIFI 802.11ac VHT80 (Harmonic @ 3m)

WIFI	Band 3 5470~5725MHz Harmonic @ 3m	
ANT	802.11ac VHT80 CH106 5530MHz	
1	Horizontal	Vertical
Peak Avg.	<p>Site : 03CH12-IY Condition : PEAK_74 3m HORN_91200_1328 HORIZONTAL Detector : Peak</p>	<p>Site : 03CH12-IY Condition : PEAK_74 3m HORN_91200_1328 VERTICAL Detector : Peak</p>



WIFI	Band 3 5470~5725MHz Harmonic @ 3m	
ANT	802.11ac VHT80 CH122 5610MHz	
1	Horizontal	Vertical
Peak Avg.	<p>Site : 03CH12-HY Condition : PEAK(UNIT) 3m HORN_9120D_1328 HORIZONTAL Detector : Peak</p>	<p>Site : 03CH12-HY Condition : PEAK(UNIT) 3m HORN_9120D_1328 VERTICAL Detector : Peak</p>



Emission below 1GHz
5GHz WIFI 802.11n HT20 (LF)

WIFI	5GHz WIFI	
ANT	802.11n HT20 LF	
1	Horizontal	Vertical
QP / Peak	<p>Site : 03CH12-HY Condition : QP 3m BIL06_6111D_40103 HORIZONTAL Detector : Peak</p>	<p>Site : 03CH12-HY Condition : QP 3m BIL06_6111D_40103 VERTICAL Detector : Peak</p>



Appendix E. Duty Cycle Plots

Band	Duty Cycle (%)	T(us)	1/T(kHz)	VBW Setting	Duty Factor(dB)
802.11a	94.98	2.080	0.48	1KHz	0.22
5GHz 802.11n HT20	94.38	1.930	0.52	1KHz	0.25
5GHz 802.11n HT40	90.48	950	1.05	3KHz	0.43
5GHz 802.11ac VHT20	94.15	1930	0.52	1KHz	0.26
5GHz 802.11ac VHT40	90.48	950	1.05	3KHz	0.43
5GHz 802.11ac VHT80	86.05	740	1.35	3KHz	0.65



802.11a

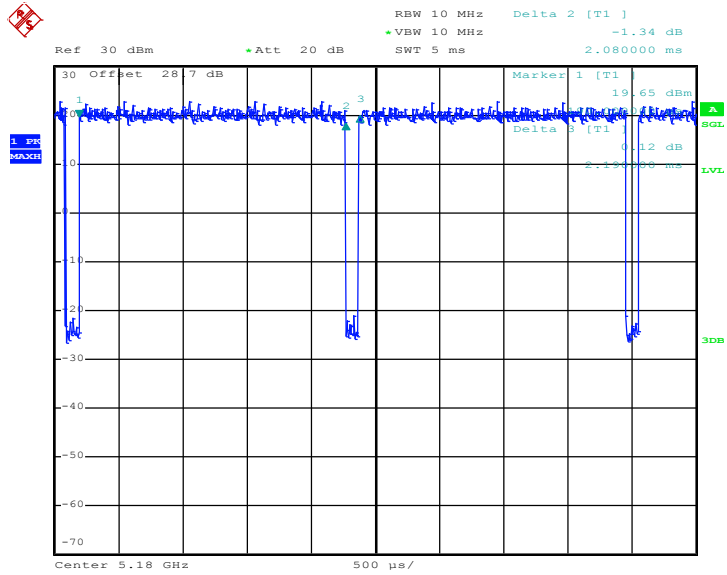

Date: 12.FEB.2018 13:51:57

802.11n HT20

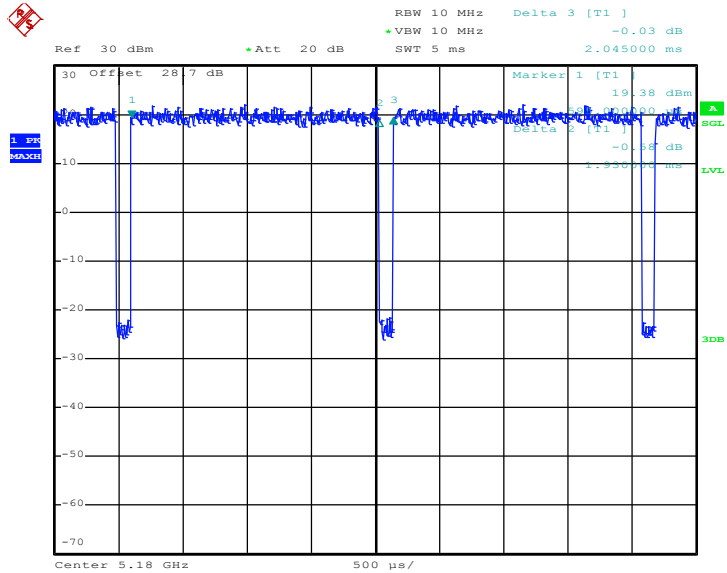

Date: 12.FEB.2018 14:14:42



802.11n HT40

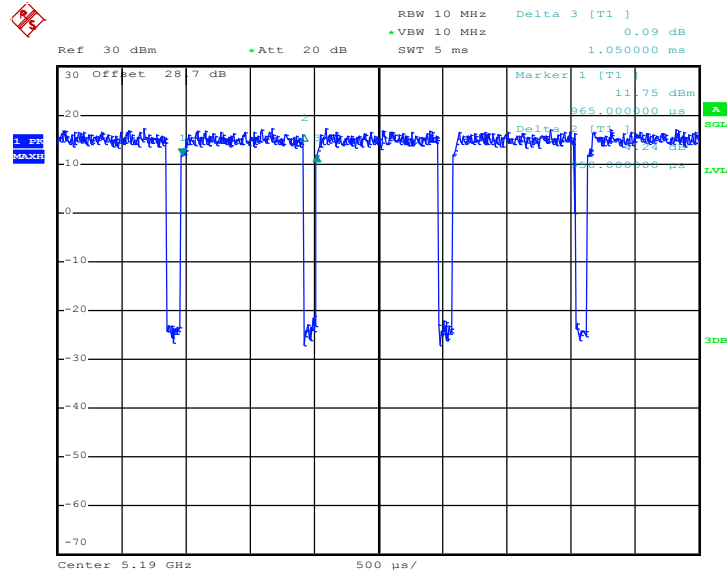

Date: 12.FEB.2018 14:22:34

802.11ac VHT20

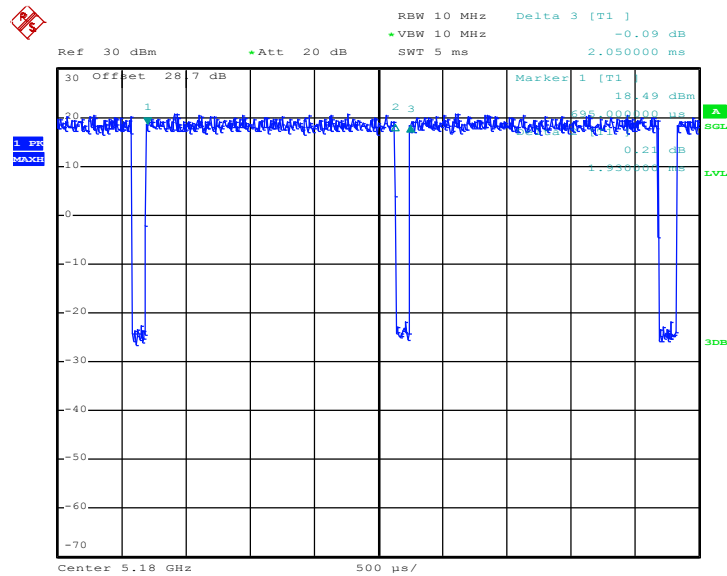

Date: 12.FEB.2018 14:35:27



802.11ac VHT40

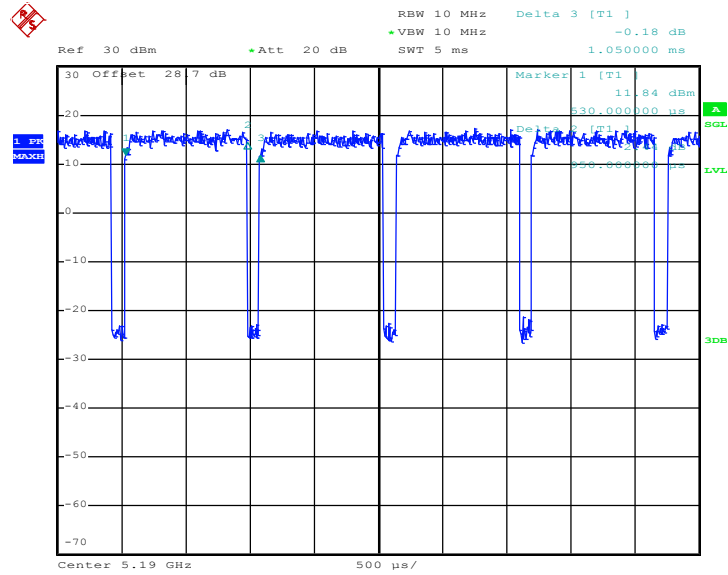

Date: 12.FEB.2018 14:46:14

802.11ac VHT80

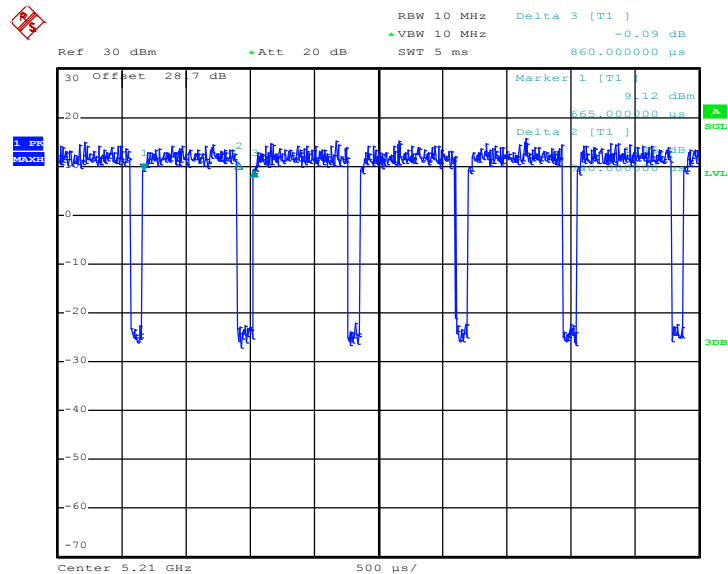

Date: 12.FEB.2018 15:10:11