



FCC RF Test Report

APPLICANT : Motorola Mobility LLC
EQUIPMENT : Mobile Cellular Phone
BRAND NAME : Motorola
MODEL NAME : XT1929-1(SS)
FCC ID : IHDT56XE2
STANDARD : FCC Part 15 Subpart C §15.225
CLASSIFICATION : (DXX) Low Power Communication Device Transmitter

The product was received on Jan. 18, 2018 and testing was completed on Mar. 02, 2018. We, SPORTON INTERNATIONAL INC., would like to declare that the tested sample has been evaluated in accordance with the test procedures and has been in compliance with the applicable technical standards.

The test results in this report apply exclusively to the tested model / sample. Without written approval of SPORTON INTERNATIONAL INC., the test report shall not be reproduced except in full.

Reviewed by: Joseph Lin / Supervisor

Approved by: Jones Tsai / Manager



SPORTON INTERNATIONAL INC.

No. 52, Hwa Ya 1st Rd., Hwa Ya Technology Park, Kwei-Shan District, Tao Yuan City, Taiwan, R.O.C.



TABLE OF CONTENTS

REVISION HISTORY.....3

SUMMARY OF THE TEST RESULT4

1. GENERAL DESCRIPTION5

 1.1 Applicant..... 5

 1.2 Manufacturer 5

 1.3 Product Feature of Equipment Under Test 5

 1.4 Product Specification of Equipment Under Test 6

 1.5 Modification of EUT 7

 1.6 Testing Location 7

 1.7 Applicable Standards..... 7

2. TEST CONFIGURATION OF EQUIPMENT UNDER TEST8

 2.1 Descriptions of Test Mode 8

 2.2 Connection Diagram of Test System 9

 2.3 Table for Supporting Units 10

 2.4 EUT Operation Test Setup 10

3. TEST RESULTS.....11

 3.1 AC Power Line Conducted Emissions Measurement 11

 3.2 20dB and 99% OBW Spectrum Bandwidth Measurement..... 13

 3.3 Frequency Stability Measurement 14

 3.4 Field Strength of Fundamental Emissions and Mask Measurement..... 15

 3.5 Radiated Emissions Measurement 17

 3.6 Antenna Requirements..... 20

4. LIST OF MEASURING EQUIPMENT21

5. UNCERTAINTY OF EVALUATION22

APPENDIX A. TEST RESULTS OF CONDUCTED EMISSION TEST

APPENDIX B. TEST RESULTS OF CONDUCTED TEST ITEMS

 B1. Test Result of 20dB Spectrum Bandwidth

 B2. Test Result of Frequency Stability

APPENDIX C. TEST RESULTS OF RADIATED TEST ITEMS

 C1. Test Result of Field Strength of Fundamental Emissions

 C2. Results of Radiated Emissions (9 kHz~30MHz)

 C3. Results of Radiated Emissions (30MHz~1GHz)



SUMMARY OF THE TEST RESULT

Applied Standard: 47 CFR FCC Part 15 Subpart C §15.225				
Part	FCC Rule	Description of Test	Result	Remark
3.1	15.207	AC Power Line Conducted Emissions	Complies	Under limit 7.73 dB at 13.560MHz
3.2	15.215(c)	20dB Spectrum Bandwidth	Complies	-
	-	99% OBW Spectrum Bandwidth	Complies	-
3.3	15.225(e)	Frequency Stability	Complies	-
3.4	15.225(a)(b)(c)	Field Strength of Fundamental Emissions	Complies	Max level 69.95 dB μ V/m at 13.560 MHz
3.5	15.225(d) & 15.209	Radiated Spurious Emissions	Complies	Under limit 3.32 dB at 40.800MHz
3.6	15.203	Antenna Requirements	Complies	-



1. General Description

1.1 Applicant

Motorola Mobility LLC
222 W,Merchandise Mart Plaza, Chicago IL 60654 USA

1.2 Manufacturer

Motorola Mobility LLC
222 W,Merchandise Mart Plaza, Chicago IL 60654 USA

1.3 Product Feature of Equipment Under Test

Product FeatureI	
Equipment	Mobile Cellular Phone
Brand Name	Motorola
Model Name	XT1929-1(SS)
FCC ID	IHDT56XE2
IMEI Code	Conducted : IMEI: 351885090004549 Conduction : IMEI: 351885090010991 Radiation : IMEI: 351885090010710
EUT supports Radios application	CDMA/EV-DO/GSM/EGPRS/WCDMA/HSPA/LTE/GNSS/NFC WLAN 11b/g/n HT20 WLAN 11a/n HT20/HT40 WLAN 11ac VHT20/VHT40/VHT80 Bluetooth BR/EDR/LE
HW Version	DVT2
EUT Stage	Identical Prototype

Remark: The above EUT's information was declared by manufacturer. Please refer to the specifications or user's manual for more detailed description.

Accessory List	
AC Adapter 1	Brand Name : Motorola
	Model Name : SC-22 SPN5970A
	Manufacturer : Salom
AC Adapter 2	Brand Name : Motorola
	Model Name : SC-22 SPN5993A
	Manufacturer : Chenyang
Battery	Brand Name : Motorola
	Model Name : JS40
	Manufacturer : SUNWODA
C2Audio Cable 1	Brand Name : Motorola
	Model Name : SC18C27844
	Manufacturer : Luxshare
C2Audio Cable 2	Brand Name : Motorola
	Model Name : SC18C27845
	Manufacturer : Cabletech
USB Cable 1	Brand Name : Cabletech
	Model Name : SKN6473A
USB Cable 2	Brand Name : FOXLINK
	Model Name : SKN6473A 17195-C 0403532
USB Cable 3	Brand Name : SAIBAO
	Model Name : SKN6473A 17214-C 1127044
USB Cable 4	Brand Name : Luxshare
	Model Name : SKN6473A 17227-C 1126538

1.4 Product Specification of Equipment Under Test

Standards-related Product Specification	
Tx/Rx Frequency Range	13.553 ~ 13.567MHz
Channel Number	1
20dBW	2.64 KHz
99%OBW	2.24 KHz
Antenna Type	Loop Antenna
Type of Modulation	ASK

Remark: The above EUT's information was declared by manufacturer. Please refer to the specifications or user's manual for more detailed description.



1.5 Modification of EUT

No modifications are made to the EUT during all test items.

1.6 Testing Location

Sporton Lab is accredited to ISO 17025 by Taiwan Accreditation Foundation (TAF code : 1190) and the FCC designation No. TW1190 and TW0007 under the FCC 2.948(e) by Mutual Recognition Agreement (MRA) in FCC Test.

Test Site	SPORTON INTERNATIONAL INC.	
Test Site Location	No. 52, Hwa Ya 1 st Rd., Hwa Ya Technology Park, Kwei-Shan District, Tao Yuan City, Taiwan, R.O.C. TEL: +886-3-3273456 / FAX: +886-3-3284978	
Test Site No.	Sporton Site No.	
	TH03HY	CO05-HY
Test Engineer	J.H. Liao	Shareef Yu
Temperature	22~24°C	23~24°C
Relative Humidity	53~55%	58~62%

Note: The test site complies with ANSI C63.4 2014 requirement.

Test Site	SPORTON INTERNATIONAL INC.	
Test Site Location	No.58, Aly. 75, Ln. 564, Wenhua 3rd Rd. Guishan Dist, Taoyuan City, Taiwan (R.O.C.) TEL: +886-3-3273456 / FAX: +886-3-3284978	
Test Site No.	Sporton Site No.	
	03CH11-HY	
Test Engineer	Jacky Hung	
Temperature	22~24°C	
Relative Humidity	53~58%	

Note: The test site complies with ANSI C63.4 2014 requirement.

1.7 Applicable Standards

According to the specifications of the manufacturer, the EUT must comply with the requirements of the following standards:

- ♦ FCC Part 15 Subpart C §15.225
- ♦ ANSI C63.10-2013



2. Test Configuration of Equipment Under Test

2.1 Descriptions of Test Mode

Investigation has been done on all the possible configurations.

The following table is a list of the test modes shown in this test report.

Test Items	
AC Power Line Conducted Emissions	Field Strength of Fundamental Emissions
20dB Spectrum Bandwidth	Frequency Stability
Radiated Emissions 9kHz~30MHz	Radiated Emissions 30MHz~1GHz

The EUT pre-scanned in four NFC type, A, B, F, V. The worst type (type A) was recorded in this report. Pre-scanned tests, X, Y, Z in three orthogonal panels to determine the final configuration (Y plane as worst plane) from all possible combinations.

Test Cases	
AC Conducted Emission	Mode 1 : WLAN (2.4GHz) Link + Bluetooth Link + NFC Tx
Remark: For Radiated Test Cases, The tests were performance with AC Adapter 1, Battery, and USB Cable 1.	

2.2 Connection Diagram of Test System

<AC Conducted Emissions>

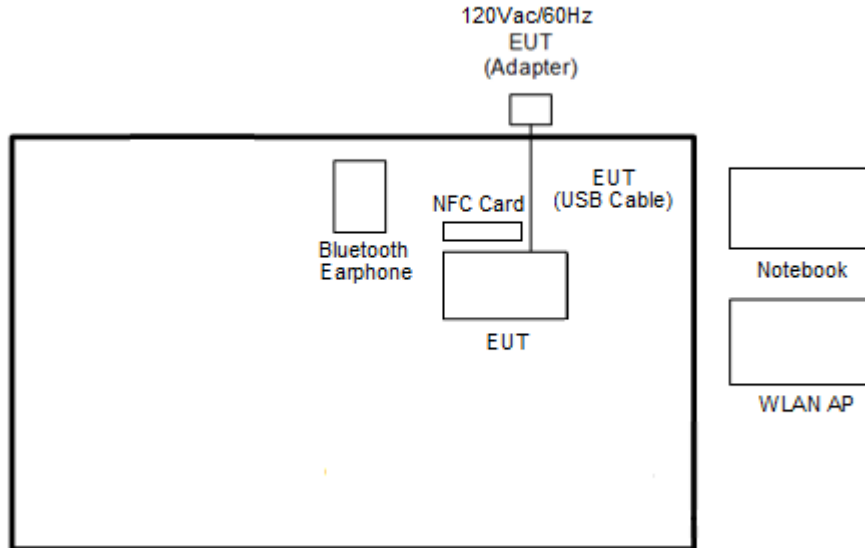

< For Fundamental Emissions and Mask and Radiated Emissions Measurement >

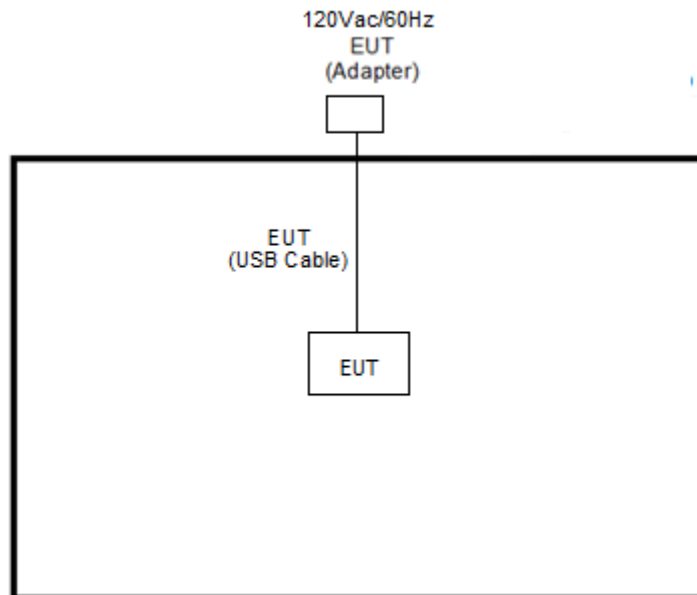

2.3 Table for Supporting Units

Item	Equipment	Trade Name	Model Name	FCC ID	Data Cable	Power Cord
1.	WLAN AP	ASUS	RT-AC66U	MSQ-RTAC66U	N/A	Unshielded, 1.8 m
2.	Notebook	DELL	Latitude E6320	FCC DoC/ Contains FCC ID: QDS-BRCM1054	N/A	AC I/P: Unshielded, 1.2 m DC O/P: Shielded, 1.8 m
3.	SD Card	SanDisk	MicroSD HC	FCC DoC	N/A	N/A
4.	NFC Card	Metro Taipei	Easy Card	N/A	N/A	N/A
5.	Bluetooth Earphone	Lenovo	LBH 301	FCC DoC	N/A	N/A

2.4 EUT Operation Test Setup

The EUT was programmed to be in continuously transmitting mode.

The ancillary equipment, NFC card, is used to make the EUT (NFC) continuously transmit at 13.56MHz and is placed around 2 cm gap to the EUT.

3. Test Results

3.1 AC Power Line Conducted Emissions Measurement

3.1.1 Limit of AC Conducted Emission

For equipment that is designed to be connected to the public utility (AC) power line, the radio frequency voltage that is conducted back onto the AC power line on any frequency or frequencies within the band 150 kHz to 30 MHz shall not exceed the limits in the following table.

Frequency of Emission (MHz)	Conducted Limit (dB μ V)	
	Quasi-Peak	Average
0.15-0.5	66 to 56*	56 to 46*
0.5-5	56	46
5-30	60	50

*Decreases with the logarithm of the frequency.

For terminal test result, the testing follows FCC KDB 174176.

3.1.2 Measuring Instruments

See list of measuring instruments of this test report.

3.1.3 Test Procedures

1. The EUT was placed 0.4 meter from the conducting wall of the shielding room, and it was kept at least 80 centimeters from any other grounded conducting surface.
2. Connect EUT to the power mains through a line impedance stabilization network (LISN).
3. All the support units are connecting to the other LISN.
4. The LISN provides 50 ohm coupling impedance for the measuring instrument.
5. The FCC states that a 50 ohm, 50 microhenry LISN should be used.
6. Both sides of AC line were checked for maximum conducted interference.
7. The frequency range from 150 kHz to 30 MHz was searched.
8. Set the test-receiver system to Peak Detect Function and specified bandwidth (IF Bandwidth = 9kHz) with Maximum Hold Mode. Then measurement is also conducted by Average Detector and Quasi-Peak Detector Function respectively.

3.1.4 Test setup

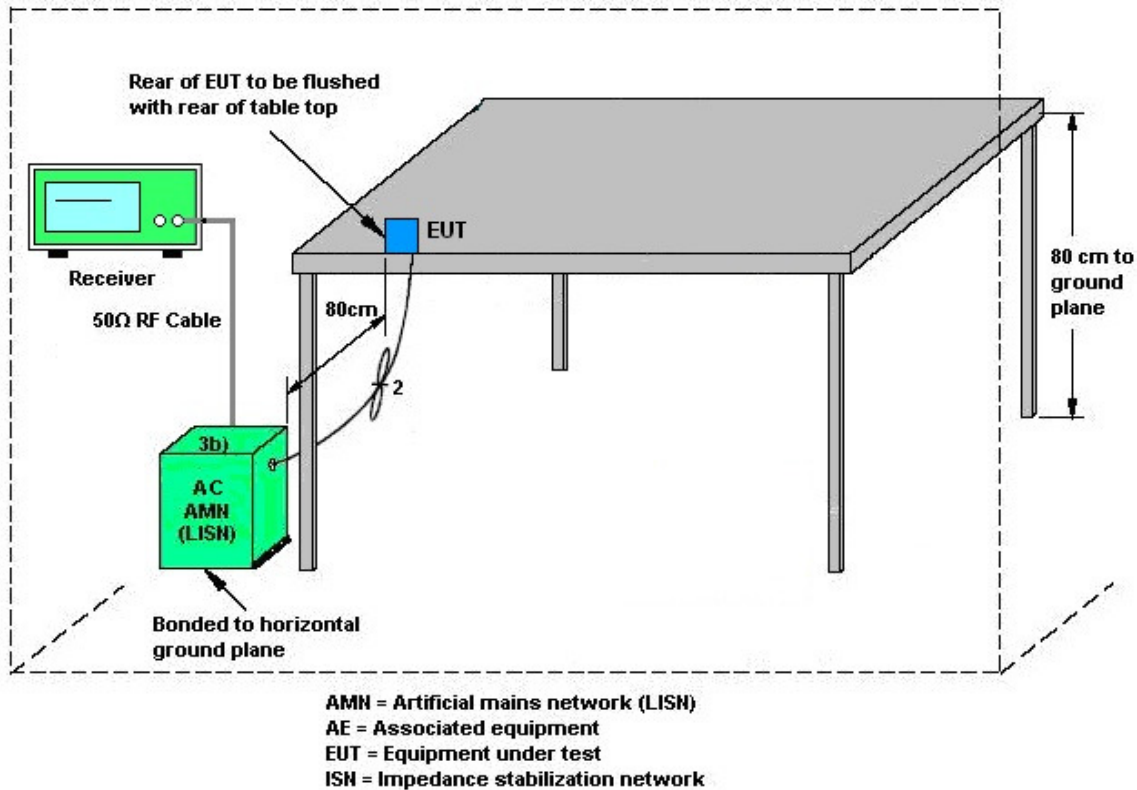

3.1.5 Test Result of AC Conducted Emission

Please refer to Appendix A.

Note:

(1) with antenna

Remark: 13.560MHz is the NFC RF fundamental signal.

(2) with dummy load

Remark: Only the fundamental NFC signal needs to be retested per C63.4.

3.2 20dB and 99% OBW Spectrum Bandwidth Measurement

3.2.1 Limit

Intentional radiators must be designed to ensure that the 20dB and 99% emission bandwidth in the specific band 13.553~13.567MHz.

3.2.2 Measuring Instruments

See list of measuring instruments of this test report.

3.2.3 Test Procedures

1. The spectrum analyzer connected via a receive antenna placed near the EUT in peak Max hold mode.
2. The resolution bandwidth of 1 kHz and the video bandwidth of 3 kHz were used.
3. Measured the spectrum width with power higher than 20dB below carrier.
4. Measured the 99% OBW.

3.2.4 Test Setup

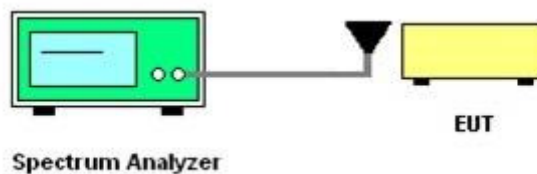

3.2.5 Test Result of Conducted Test Items

Please refer to Appendix B.

3.3 Frequency Stability Measurement

3.3.1 Limit

The frequency tolerance of the carrier signal shall be maintained within +/- 0.01% (100ppm) of the operating frequency over a temperature variation of -20 degrees to +50 degrees C at normal supply voltage, and for a variation in the primary supply voltage from 85% to 115% of the rated supply voltage at a temperature of 20 degrees C. For battery operated equipment, the equipment tests shall be performed using a new battery.

3.3.2 Measuring Instruments

See list of measuring instruments of this test report.

3.3.3 Test Procedures

1. The spectrum analyzer connected via a receive antenna placed near the EUT.
2. EUT have transmitted signal and fixed channelize.
3. Set the spectrum analyzer span to view the entire emissions bandwidth.
4. Set RBW = 1 kHz, VBW = 3 kHz with peak detector and maxhold settings.
5. The f_c is declaring of channel frequency. Then the frequency error formula is $(f_c - f) / f_c \times 10^6$ ppm and the limit is less than ± 100 ppm.
6. Extreme temperature rule is -20°C~50°C.

3.3.4 Test Setup

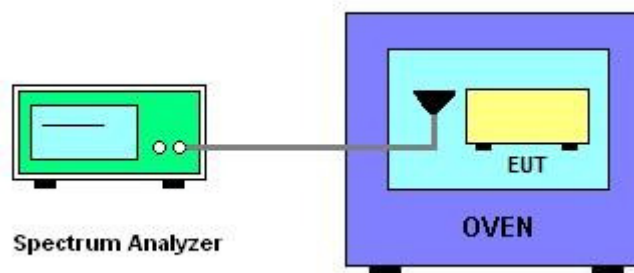

3.3.5 Test Result of Conducted Test Items

Please refer to Appendix B.



3.4 Field Strength of Fundamental Emissions and Mask Measurement

3.4.1 Limit

Rules and specifications	FCC CFR 47 Part 15 section 15.225			
Description	Compliance with the spectrum mask is tested with RBW set to 9kHz.			
Freq. of Emission (MHz)	Field Strength ($\mu\text{V/m}$) at 30m	Field Strength ($\text{dB}\mu\text{V/m}$) at 30m	Field Strength ($\text{dB}\mu\text{V/m}$) at 10m	Field Strength ($\text{dB}\mu\text{V/m}$) at 3m
1.705~13.110	30	29.5	48.58	69.5
13.110~13.410	106	40.5	59.58	80.5
13.410~13.553	334	50.5	69.58	90.5
13.553~13.567	15848	84.0	103.08	124.0
13.567~13.710	334	50.5	69.58	90.5
13.710~14.010	106	40.5	59.58	80.5
14.010~30.000	30	29.5	48.58	69.5

3.4.2 Measuring Instruments

See list of measuring instruments of this test report.

3.4.3 Test Procedures

1. Configure the EUT according to ANSI C63.10. The EUT was placed on the top of the turntable 0.8 meter above ground. The phase center of the loop receiving antenna mounted antenna tower was placed 3 meters far away from the turntable.
2. Power on the EUT and all the supporting units. The turntable was rotated by 360 degrees to determine the position of the highest radiation.
3. The height of the receiving antenna was fixed at one meter above ground to find the maximum emissions field strength.
4. For Fundamental emissions, use the receiver to measure QP reading.
5. When the radiated emissions limits are expressed in terms of the average value of the emissions, and pulsed operation is employed, the measurement field strength shall be determined by averaging over one complete pulse train, including blanking intervals, as long as the pulse train does not exceed 0.1 seconds. As an alternative (provided the transmitter operates for longer than 0.1 seconds) or in cases where the pulse train exceeds 0.1 seconds, the measured field strength shall be determined from the average absolute voltage during a 0.1 second interval during which the field strength is at its maximum value.
6. Compliance with the spectrum mask is tested with RBW set to 9kHz.

Note: Emission level (dB μ V/m) = 20 log Emission level (μ V/m).

3.4.4 Test Setup

For radiated emissions below 30MHz

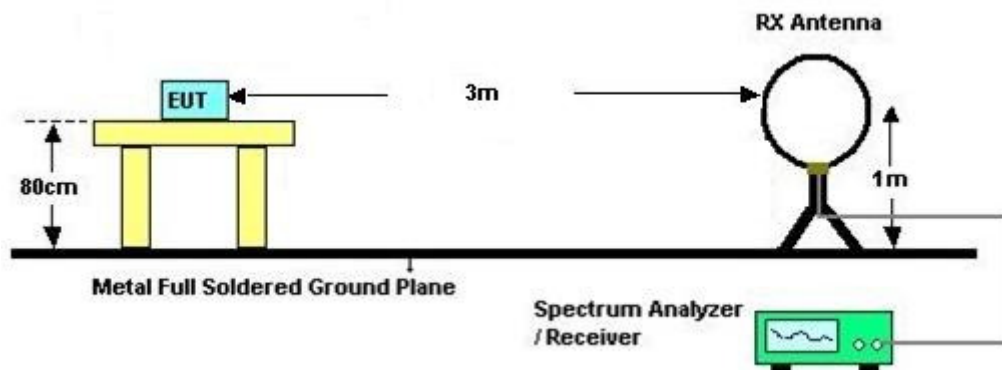

3.4.5 Test Result of Field Strength of Fundamental Emissions and Mask

Please refer to Appendix C.

3.5 Radiated Emissions Measurement

3.5.1 Limit

The field strength of any emissions which appear outside of 13.110 ~14.010MHz band shall not exceed the general radiated emissions limits.

Frequencies (MHz)	Field Strength ($\mu\text{V/m}$)	Measurement Distance (meters)
0.009~0.490	2400/F(kHz)	300
0.490~1.705	24000/F(kHz)	30
1.705~30.0	30	30
30~88	100	3
88~216	150	3
216~960	200	3
Above 960	500	3

3.5.2 Measuring Instruments

See list of measuring instruments of this test report.

3.5.3 Measuring Instrument Setting

The following table is the setting of receiver.

Receiver Parameter	Setting
Attenuation	Auto
Frequency Range: 9kHz~150kHz	RBW 200Hz for QP
Frequency Range: 150kHz~30MHz	RBW 9kHz for QP
Frequency Range: 30MHz~1000MHz	RBW 120kHz for Peak

Note: The emission limits shown in the above table are based on measurements employing a CISPR quasi-peak detector except for the frequency bands 9-90 kHz, 110-490 kHz. Radiated emission limits in these two bands are based on measurements employing an average detector.



3.5.4 Test Procedures

1. Configure the EUT according to ANSI C63.10. The EUT was placed on the top of the turntable 0.8 meter above ground. The phase center of the receiving antenna mounted on the top of a height-variable antenna tower was placed 3 meters far away from the turntable.
2. Power on the EUT and all the supporting units. The turntable was rotated by 360 degrees to determine the position of the highest radiation.
3. The height of the broadband receiving antenna was varied between one meter and four meters above ground to find the maximum emissions field strength of both horizontal and vertical polarization.
4. For each suspected emissions, the antenna tower was scan (from 1 M to 4 M) and then the turntable was rotated (from 0 degree to 360 degrees) to find the maximum reading.
5. Set the test-receiver system to Peak or CISPR quasi-peak Detect Function with specified bandwidth under Maximum Hold Mode.
6. When the radiated emissions limits are expressed in terms of the average value of the emissions, and pulsed operation is employed, the measurement field strength shall be determined by averaging over one complete pulse train, including blanking intervals, as long as the pulse train does not exceed 0.1 seconds. As an alternative (provided the transmitter operates for longer than 0.1 seconds) or in cases where the pulse train exceeds 0.1 seconds, the measured field strength shall be determined from the average absolute voltage during a 0.1 second interval during which the field strength is at its maximum value.
7. In case the emission is lower than 30MHz, loop antenna has to be used for measurement and the recorded data should be QP measured by receiver. Antenna Requirements

3.5.5 Test Setup

For radiated emissions below 30MHz

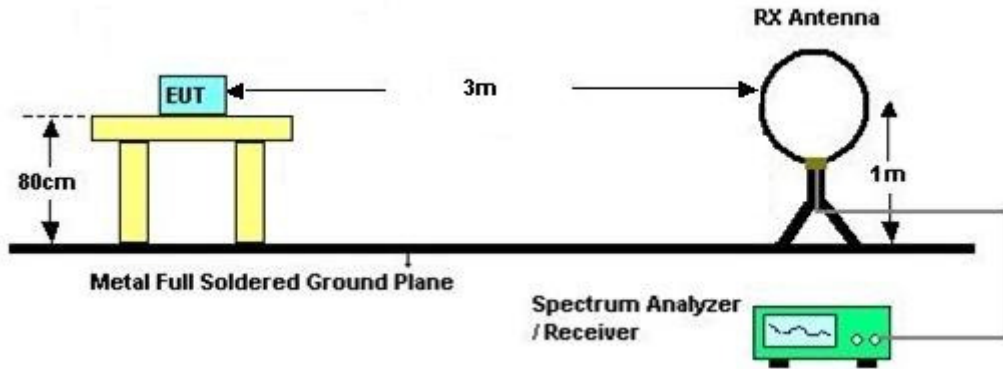

For radiated emissions above 30MHz

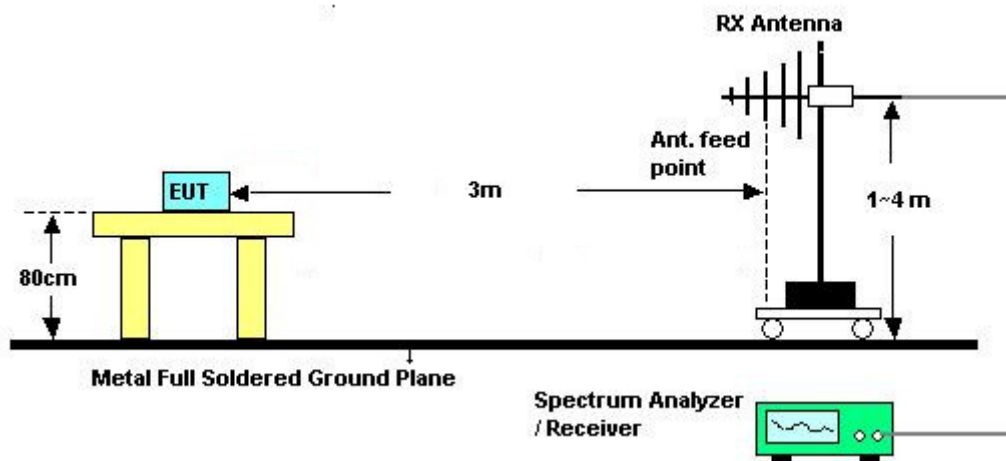

3.5.6 Test Result of Radiated Emissions Measurement

Please refer to Appendix C.

Remark: There is a comparison data of both open-field test site and semi-Anechoic chamber, and the result came out very similar.



3.6 Antenna Requirements

3.6.1 Standard Applicable

Except for special regulations, the Low-power Radio-frequency Devices must not be equipped with any jacket for installing an antenna with extension cable. An intentional radiator shall be designed to ensure that no antenna other than that furnished by the responsible party shall be used with the device. The use of a permanently attached antenna or of an antenna that uses a unique coupling to the intentional radiator shall be considered sufficient to comply with the provisions of this Section. The manufacturer may design the unit so that the user can replace a broken antenna, but the use of a standard antenna jack or electrical connector is prohibited.

The use of a permanently attached antenna or of an antenna that uses a unique coupling to the intentional radiator shall be considered sufficient to comply with the rule.

3.6.2 Antenna Anti-Replacement Construction

An embedded-in antenna design is used.



4. List of Measuring Equipment

Instrument	Manufacturer	Model No.	Serial No.	Characteristics	Calibration Date	Test Date	Due Date	Remark
AC Power Source	AC POWER	AFC-500W	F10407001 1	50Hz~60Hz	Dec. 01, 2016	Feb. 19, 2018	Nov. 30, 2018	Conducted (TH03-HY)
Spectrum Analyzer	Rohde & Schwarz	FSP30	101329	9kHz~30GHz	Jun. 26, 2017	Feb. 19, 2018	Jun. 25, 2018	Conducted (TH03-HY)
Temperature Chamber	ESPEC	SU-641	92013721	-30°C ~70°C	Nov. 16, 2016	Feb. 19, 2018	Nov. 15, 2018	Conducted (TH03-HY)
AC Power Source	ChainTek	APC-1000W	N/A	N/A	N/A	Feb. 28, 2018	N/A	Conduction (CO05-HY)
EMI Test Receiver	Rohde & Schwarz	ESR3	102388	3.6GHz	Dec. 08, 2017	Feb. 28, 2018	Dec. 07, 2018	Conduction (CO05-HY)
LISN	Rohde & Schwarz	ENV216	100080	9kHz~30MHz	Nov. 30, 2017	Feb. 28, 2018	Nov. 29, 2018	Conduction (CO05-HY)
Amplifier	SONOMA	310N	187312	9kHz~1GHz	Nov. 10, 2016	Mar. 01, 2018~ Mar. 02, 2018	Nov. 09, 2018	Radiation (03CH11-HY)
Bilog Antenna	TESEQ	CBL 6111D&N-6-0 6	35414&AT- N0602	30MHz~1GHz	Oct. 14, 2017	Mar. 01, 2018~ Mar. 02, 2018	Oct. 13, 2018	Radiation (03CH11-HY)
Loop Antenna	Rohde & Schwarz	HFH2-Z2	100488	9 kHz~30 MHz	Nov. 23, 2017	Mar. 01, 2018~ Mar. 02, 2018	Nov. 22, 2019	Radiation (03CH11-HY)
Spectrum Analyzer	Keysight	N9010A	MY542004 86	10Hz ~ 44GHz	Oct. 19, 2017	Mar. 01, 2018~ Mar. 02, 2018	Oct. 18, 2018	Radiation (03CH11-HY)
Antenna Mast	EMEC	AM-BS-4500- B	N/A	1~4m	N/A	Mar. 01, 2018~ Mar. 02, 2018	N/A	Radiation (03CH11-HY)
EMI Test Receiver	Agilent Technologies	N9038A(MXE)	MY532900 45	20MHz~8.4GHz	Jan. 18, 2018	Mar. 01, 2018~ Mar. 02, 2018	Jan. 17, 2019	Radiation (03CH11-HY)
Turn Table	EMEC	TT 2000	N/A	0~360 Degree	N/A	Mar. 01, 2018~ Mar. 02, 2018	N/A	Radiation (03CH11-HY)



5. Uncertainty of Evaluation

Uncertainty of Conducted Emission Measurement (150 kHz ~ 30 MHz)

Measuring Uncertainty for a Level of Confidence of 95% ($U = 2Uc(y)$)	2.70
---	------

Uncertainty of Radiated Emission Measurement (9 kHz ~ 30 MHz)

Measuring Uncertainty for a Level of Confidence of 95% ($U = 2Uc(y)$)	3.45
---	------

Uncertainty of Radiated Emission Measurement (30 MHz ~ 1000 MHz)

Measuring Uncertainty for a Level of Confidence of 95% ($U = 2Uc(y)$)	5.20
---	------



Appendix A. Test Results of Conducted Emission Test

Test Engineer :	Shareef Yu	Temperature :	23~24°C
		Relative Humidity :	58~62%

EUT Information

Report NO : 811821-02
 Test Mode : Mode 1
 Test Voltage : 120Vac/60Hz
 Phase : Line
 Original Mode

Full Spectrum

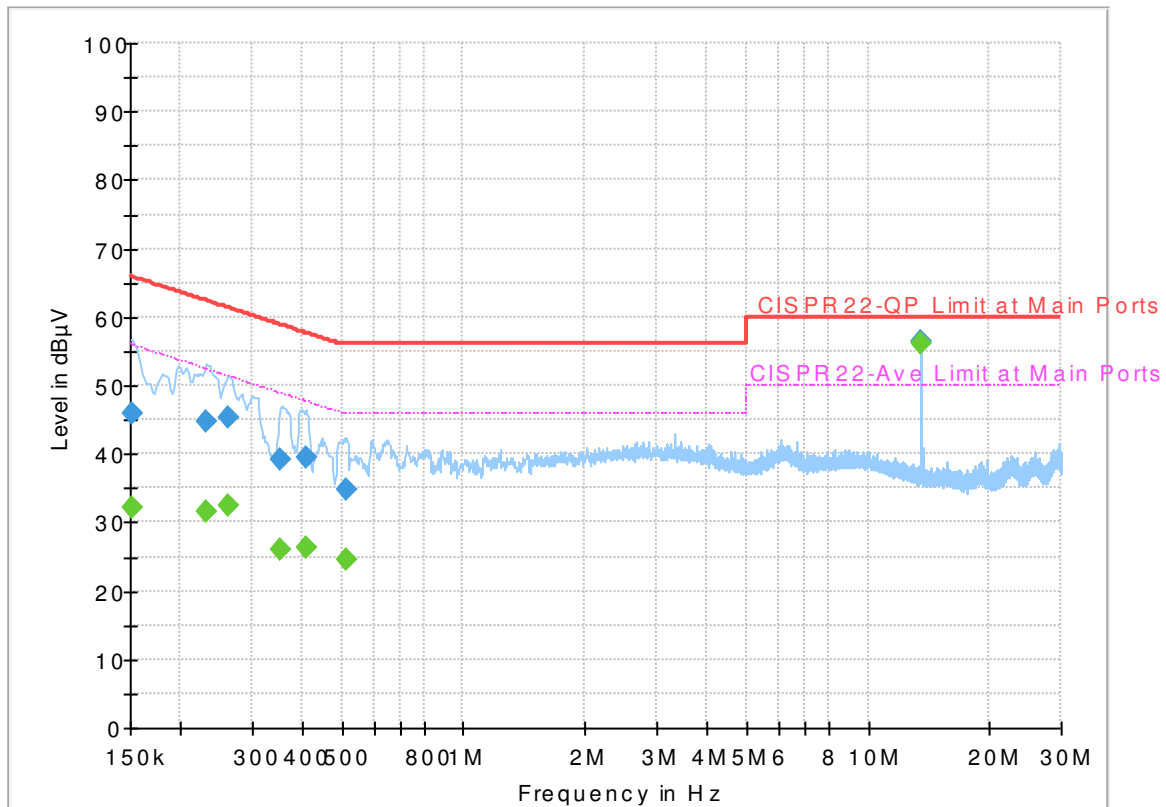

Final_Result

Frequency (MHz)	QuasiPeak (dBµV)	Average (dBµV)	Limit (dBµV)	Margin (dB)	Line	Filter	Corr. (dB)
0.152250	---	32.12	55.88	23.76	L1	OFF	19.5
0.152250	45.78	---	65.88	20.10	L1	OFF	19.5
0.231000	---	31.52	52.41	20.89	L1	OFF	19.5
0.231000	44.69	---	62.41	17.72	L1	OFF	19.5
0.262500	---	32.44	51.35	18.91	L1	OFF	19.5
0.262500	45.38	---	61.35	15.97	L1	OFF	19.5
0.352500	---	26.10	48.90	22.80	L1	OFF	19.5
0.352500	39.20	---	58.90	19.70	L1	OFF	19.5
0.408750	---	26.23	47.67	21.44	L1	OFF	19.5
0.408750	39.56	---	57.67	18.11	L1	OFF	19.5
0.512250	---	24.47	46.00	21.53	L1	OFF	19.5
0.512250	34.78	---	56.00	21.22	L1	OFF	19.5
13.560000	---	56.08	50.00	-6.08	L1	OFF	19.7
13.560000	56.53	---	60.00	3.47	L1	OFF	19.7

EUT Information

Report NO : 811821-02
 Test Mode : Mode 1
 Test Voltage : 120Vac/60Hz
 Phase : Neutral
 Original Mode

Full Spectrum

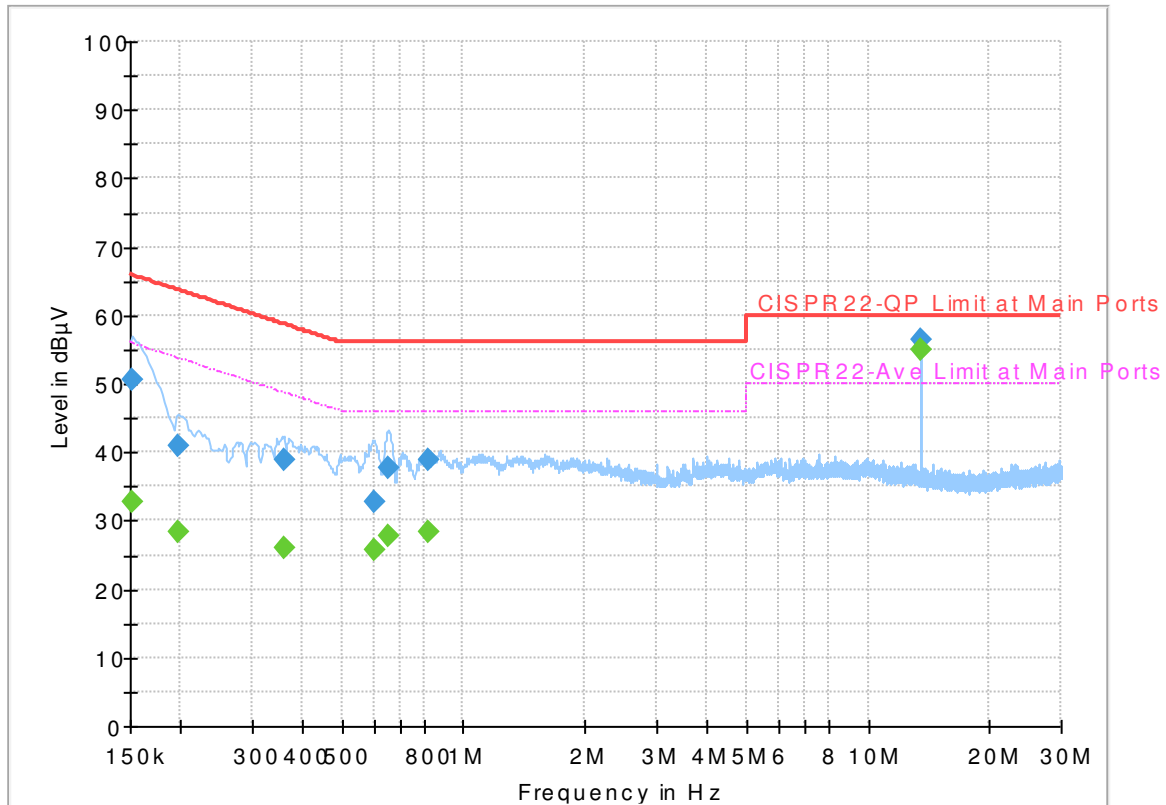

Final_Result

Frequency (MHz)	QuasiPeak (dBµV)	Average (dBµV)	Limit (dBµV)	Margin (dB)	Line	Filter	Corr. (dB)
0.152250	---	32.88	55.88	23.00	N	OFF	19.5
0.152250	50.48	---	65.88	15.40	N	OFF	19.5
0.197250	---	28.31	53.73	25.42	N	OFF	19.5
0.197250	41.03	---	63.73	22.70	N	OFF	19.5
0.359250	---	26.10	48.75	22.65	N	OFF	19.5
0.359250	39.02	---	58.75	19.73	N	OFF	19.5
0.600000	---	25.60	46.00	20.40	N	OFF	19.5
0.600000	32.80	---	56.00	23.20	N	OFF	19.5
0.654000	---	27.89	46.00	18.11	N	OFF	19.5
0.654000	37.74	---	56.00	18.26	N	OFF	19.5
0.820500	---	28.40	46.00	17.60	N	OFF	19.5
0.820500	39.02	---	56.00	16.98	N	OFF	19.5
13.560000	---	55.08	50.00	-5.08	N	OFF	19.8
13.560000	56.57	---	60.00	3.43	N	OFF	19.8

EUT Information

Report NO : 811821-02
 Test Mode : Mode 2
 Test Voltage : 120Vac/60Hz
 Phase : Line
 Terminal Mode

Full Spectrum

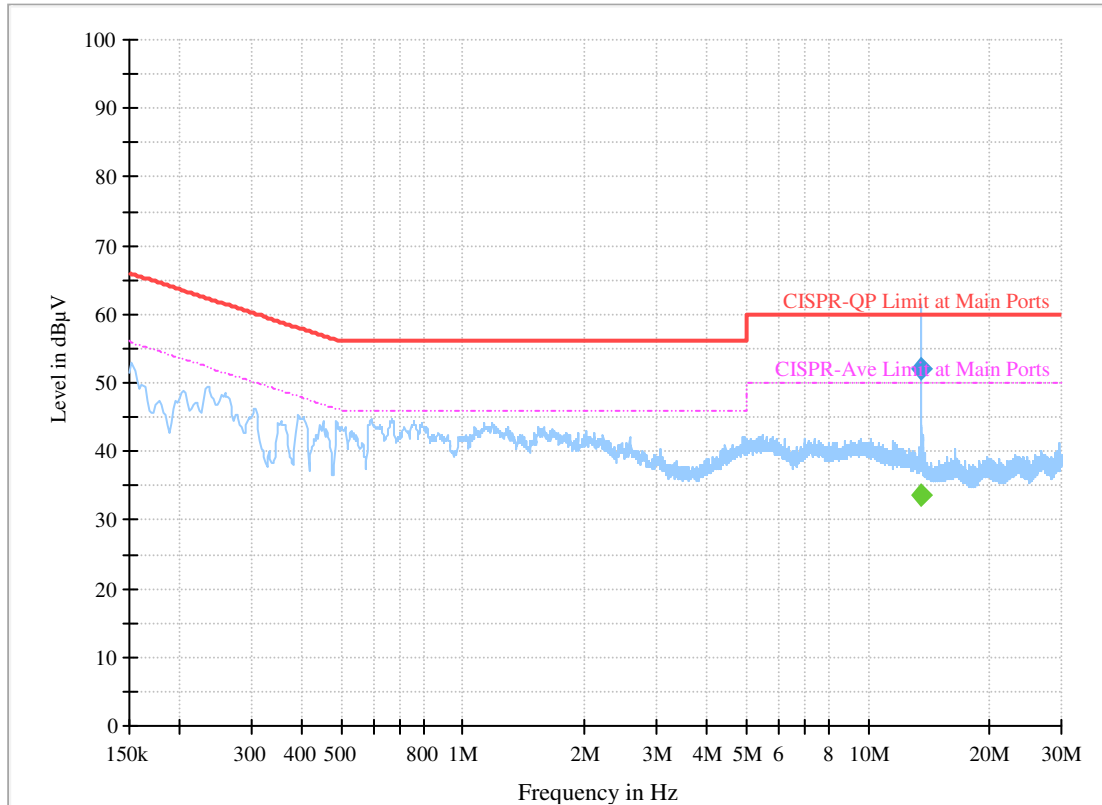

Final Result

Frequency (MHz)	QuasiPeak (dBµV)	Average (dBµV)	Limit (dBµV)	Margin (dB)	Line	Filter	Corr. (dB)
13.560000	---	33.76	50.00	16.24	L1	OFF	19.7
13.560000	51.94	---	60.00	8.06	L1	OFF	19.7

EUT Information

Report NO : 811821-02
 Test Mode : Mode 2
 Test Voltage : 120Vac/60Hz
 Phase : Neutral
 Terminal Mode

Full Spectrum

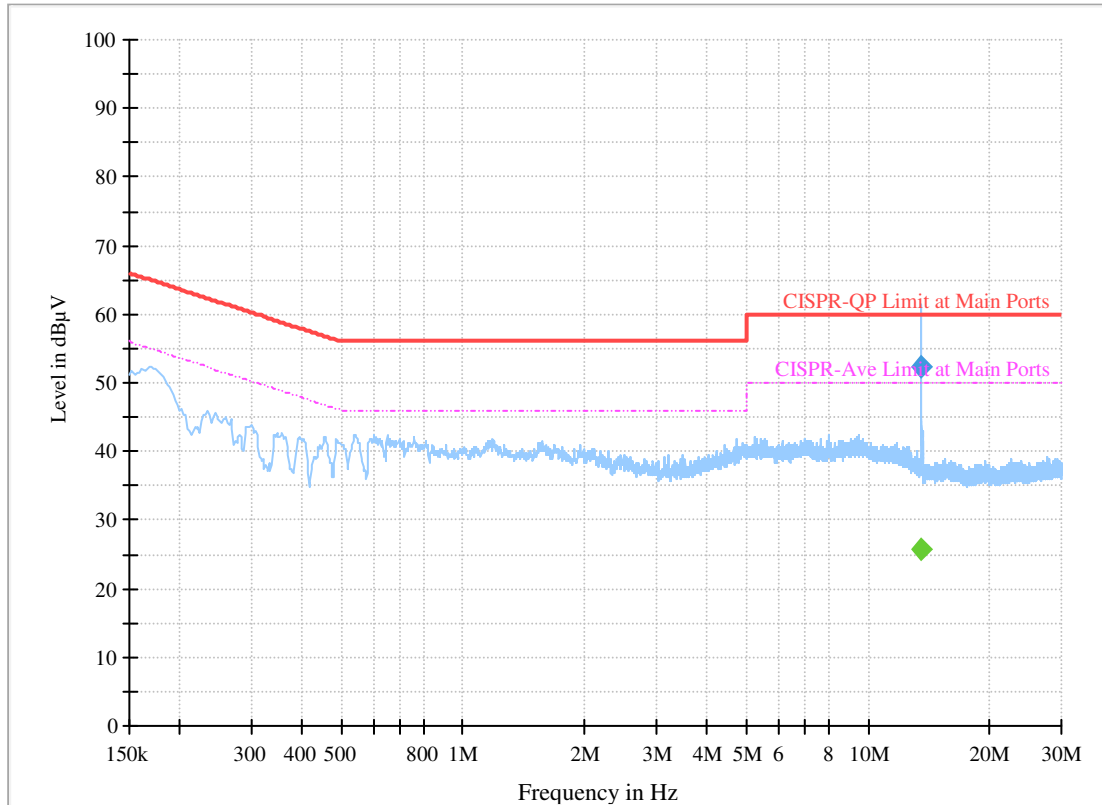

Final Result

Frequency (MHz)	QuasiPeak (dBµV)	Average (dBµV)	Limit (dBµV)	Margin (dB)	Line	Filter	Corr. (dB)
13.560000	---	25.77	50.00	24.23	N	OFF	19.8
13.560000	52.27	---	60.00	7.73	N	OFF	19.8



Appendix B. Test Results of Conducted Test Items

B1. Test Result of 20dB Spectrum Bandwidth

Test mode	NFC Tx	Test Frequency (MHz)	13.56
20dB Bandwidth (kHz)	2.64	99% OccupiedBW(kHz)	2.24
Frequency range (MHz)	$f_L > 13.553$	13.55924	Test Result
	$f_H < 13.567$	13.56188	Complies

Remark: Because the measured signal is CW adjusting the RBW per C63.10 would not be practical since measured bandwidth will always follow the RBW and the result will be approximately twice the RBW.



B2. Test Result of Frequency Stability

B3. Voltage vs. Frequency Stability		Temperature vs. Frequency Stability		
Voltage (Vac)	Measurement Frequency (MHz)	Temperature (°C)	Time	Measurement Frequency (MHz)
120	13.560560	-20	0	13.560620
102	13.560560		2	13.560600
138	13.560560		5	13.560600
			10	13.560600
		-10	0	13.560620
			2	13.560620
			5	13.560620
			10	13.560620
		0	0	13.560600
			2	13.560600
			5	13.560600
			10	13.560620
		10	0	13.560580
			2	13.560580
			5	13.560590
			10	13.560600
		20	0	13.560560
			2	13.560550
			5	13.560540
			10	13.560540
		30	0	13.560580
			2	13.560550
			5	13.560560
			10	13.560540
		40	0	13.560520
			2	13.560520
			5	13.560520
			10	13.560520



Voltage vs. Frequency Stability		Temperature vs. Frequency Stability		
Voltage (Vac)	Measurement Frequency (MHz)	Temperature (°C)	Time	Measurement Frequency (MHz)
		50	0	13.560520
			2	13.560520
			5	13.560520
			10	13.560520
Max.Deviation (MHz)	0.000560	Max.Deviation (MHz)		0.000620
Max.Deviation (ppm)	41.2979	Max.Deviation (ppm)		45.7227
Limit	FS < ±100 ppm	Limit		FS < ±100 ppm
Test Result	PASS	Test Result		PASS



Appendix C. Test Results of Radiated Test Items

C1. Test Result of Field Strength of Fundamental Emissions

Test Mode :	NFC Tx	Test Frequency (MHz)	13.56
-------------	--------	----------------------	-------

Date: 2018-03-01

Site : 03CH11-HY
 Condition : 15.225 3m LOOP_ANT(H) HORIZONTAL
 : RBW:9.000KHz VBW:9.000KHz SWT:Auto
 Project : 811821-02

Freq	Level	Over Limit	Limit Line	ReadAntenna Level	Cable Factor	A/Pos	T/Pos	Remark	
MHz	dBuV/m	dB	dBuV/m	dBuV	dB/m	dB	cm	deg	
1	13.56	69.95	-54.05	124.00	48.67	21.02	0.26	100	171 QP

Date: 2018-03-01

Site : 03CH11-HY
 Condition : 15.225 3m LOOP_ANT(V) VERTICAL
 : RBW:9.000KHz VBW:9.000KHz SWT:Auto
 Project : 811821-02

Freq	Level	Over Limit	Limit Line	ReadAntenna Level	Cable Factor	A/Pos	T/Pos	Remark	
MHz	dBuV/m	dB	dBuV/m	dBuV	dB/m	dB	cm	deg	
1	13.56	66.91	-57.09	124.00	45.63	21.02	0.26	100	73 QP

C2. Results of Radiated Spurious Emissions (9 kHz~30MHz)

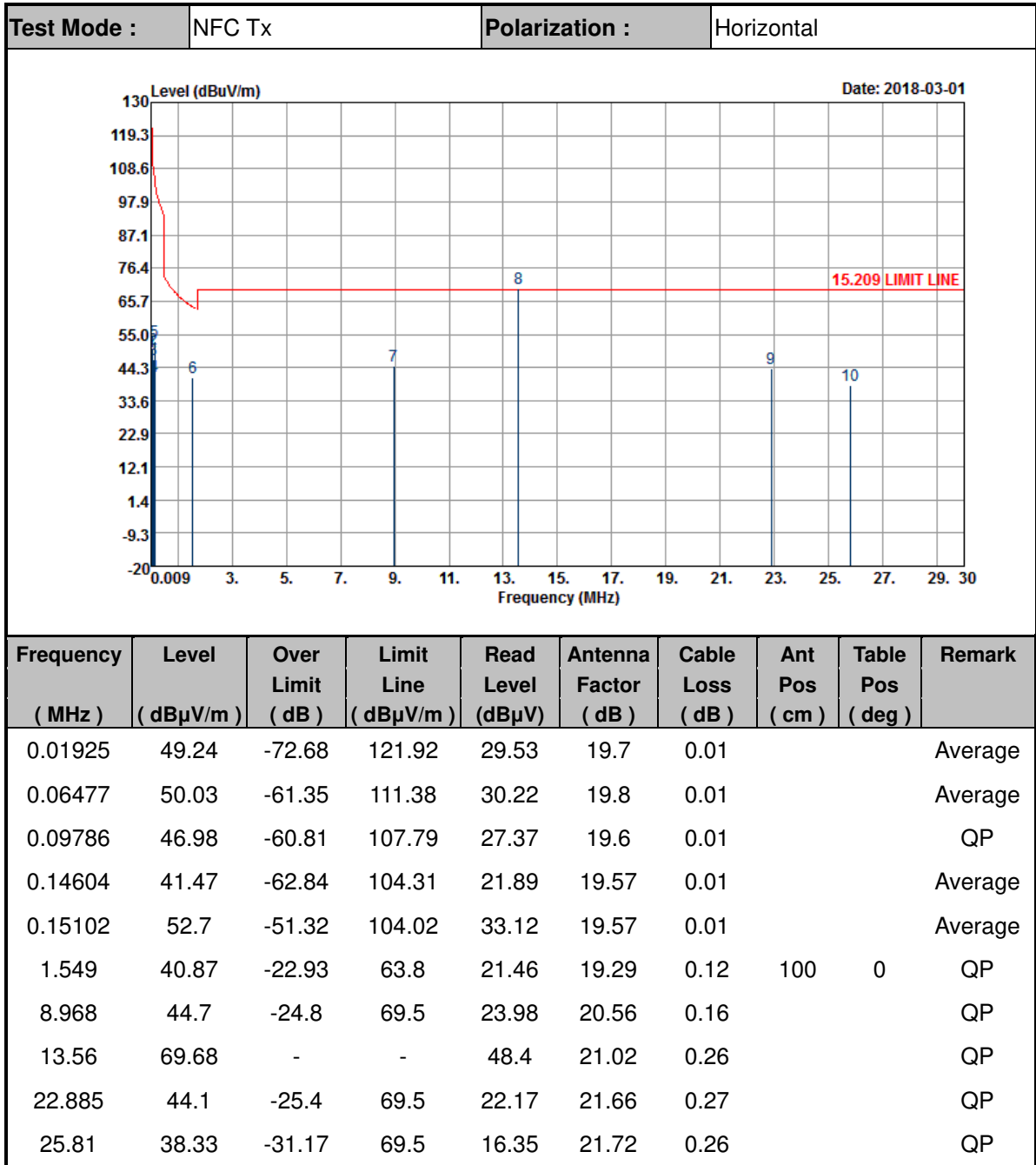

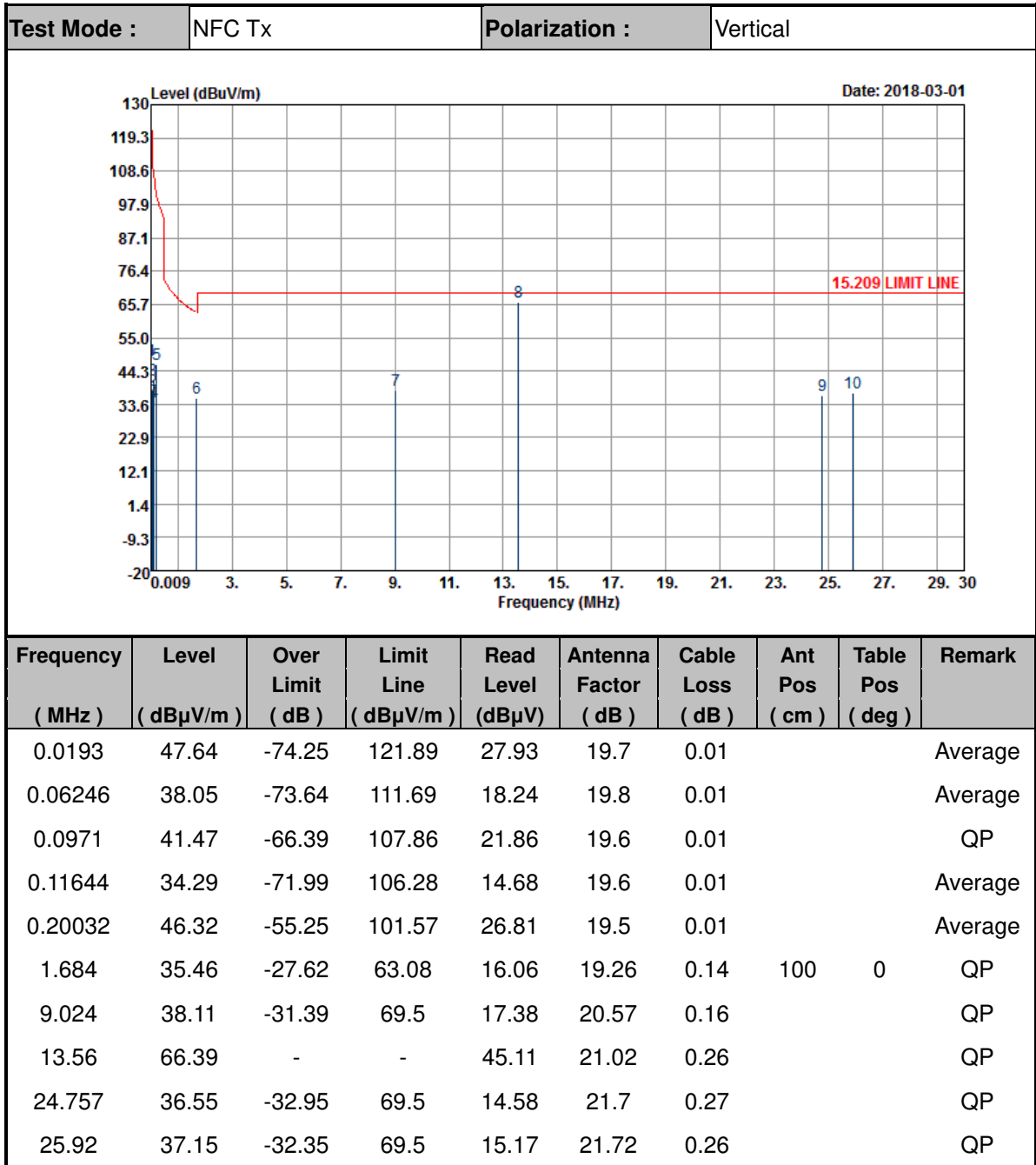

Note:

1. 13.56 MHz is fundamental signal which can be ignored.
2. The amplitude of spurious emissions which are attenuated by more than 20dB below the permissible value has no need to be reported.
3. Distance extrapolation factor = 40 log (specific distance / test distance) (dB);
4. Limit line = specific limits (dBμV) + distance extrapolation factor.



C3. Results of Radiated Spurious Emissions (30MHz~1GHz)

Test Mode :	NFC Tx	Polarization :	Horizontal
-------------	--------	----------------	------------

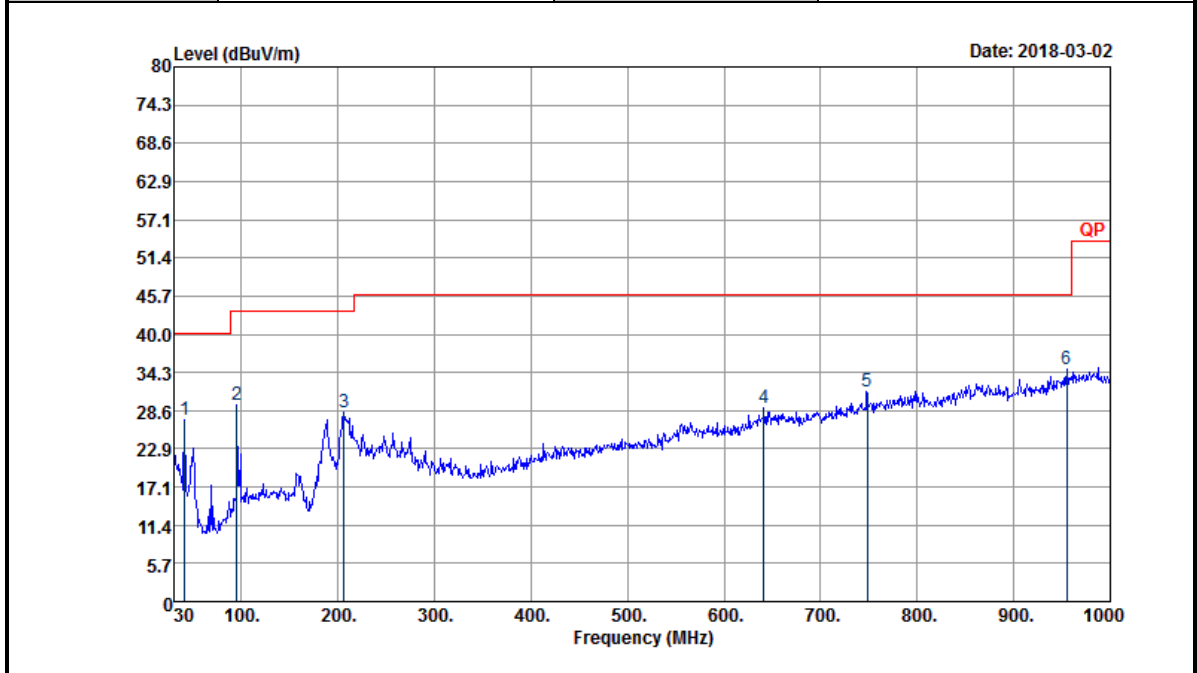

Frequency (MHz)	Level (dB μ V/m)	Over Limit (dB)	Limit Line (dB μ V/m)	Read Level (dB μ V)	Antenna Factor (dB)	Cable Loss (dB)	Preamp Factor (dB)	Ant Pos (cm)	Table Pos (deg)	Remark
40.8	27.25	-12.75	40	40.03	18.68	0.82	32.49			Peak
94.8	29.36	-14.14	43.5	45.42	15.15	1.22	32.48			Peak
206.31	28.39	-15.11	43.5	43.97	14.94	1.72	32.39			Peak
640.9	28.99	-17.01	46	31.01	26.33	3.2	32.46			Peak
748	31.41	-14.59	46	31.92	27.79	3.44	32.33			Peak
955.2	34.66	-11.34	46	30.1	30.87	3.9	31.15	100	0	Peak

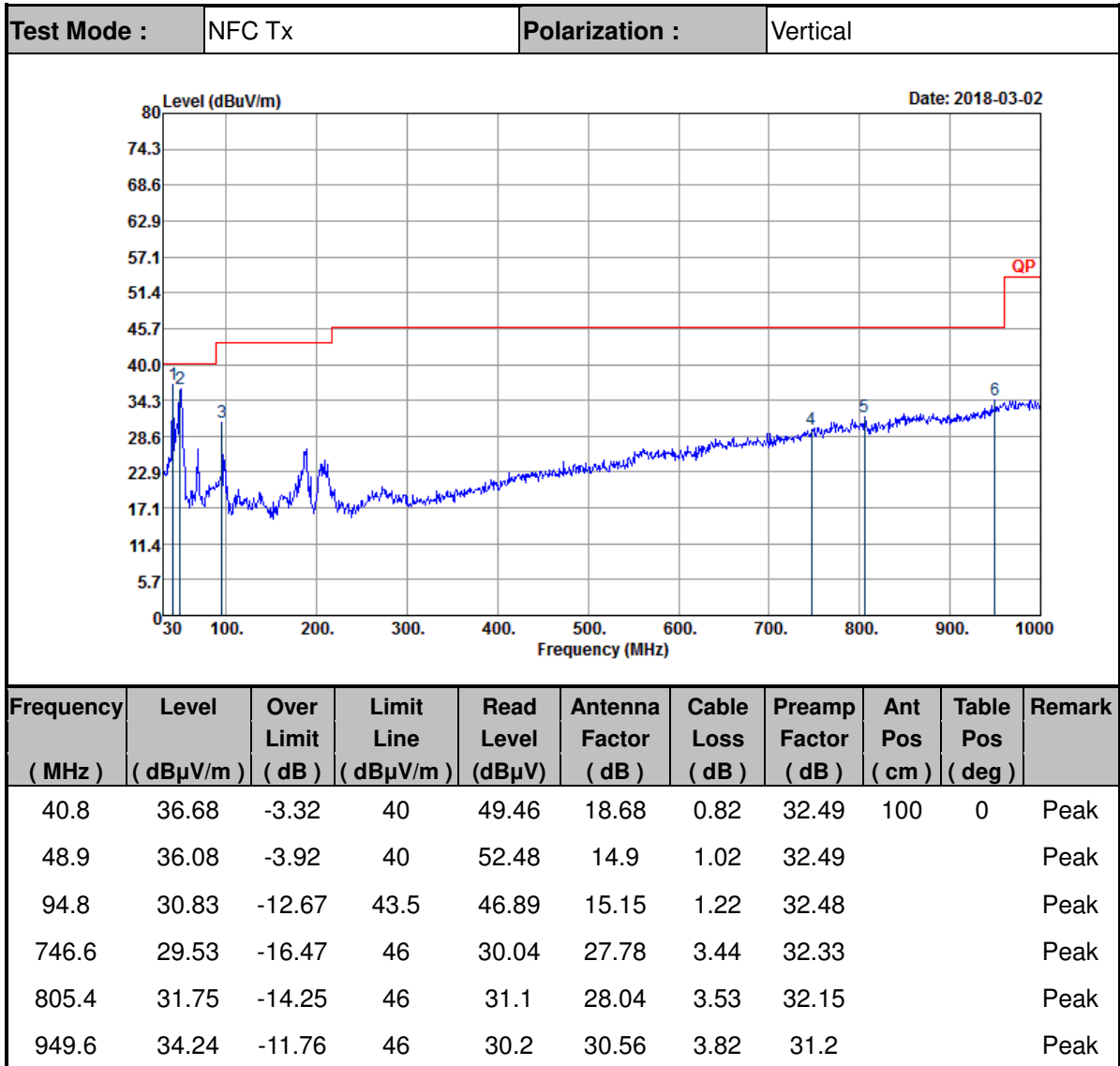

Note:

1. The amplitude of spurious emissions which are attenuated by more than 20dB below the permissible value has no need to be reported.
2. Emission level (dBμV/m) = 20 log Emission level (μV/m).
3. Corrected Reading: Antenna Factor + Cable Loss + Read Level - Preamp Factor= Level.