



FCC RF Test Report

APPLICANT : Motorola Mobility LLC
EQUIPMENT : Mobile Cellular Phone
BRAND NAME : Motorola
MODEL NAME : XT1929-1(SS)
FCC ID : IHDT56XE2
STANDARD : 47 CFR Part 2, 22(H), 24(E), 27
CLASSIFICATION : PCS Licensed Transmitter Held to Ear (PCE)

This is a variant report. The product was received on Jan. 18, 2018 and completely tested on Mar. 02, 2018. We, SPORTON INTERNATIONAL Inc., would like to declare that the tested sample has been evaluated in accordance with the test procedures given in ANSI / TIA-603-E and the testing has shown the tested sample to be in compliance with the applicable technical standards.

The test results in this report apply exclusively to the tested model / sample. Without written approval of SPORTON INTERNATIONAL INC., the test report shall not be reproduced except in full.

Reviewed by: Joseph Lin / Supervisor

Approved by: Jones Tsai / Manager



SPORTON INTERNATIONAL INC.

No. 52, Hwa Ya 1st Rd., Hwa Ya Technology Park, Kwei-Shan District, Tao Yuan City, Taiwan, R.O.C.

SPORTON INTERNATIONAL INC.

TEL : 886-3-327-3456

FAX : 886-3-328-4978

FCC ID: IHDT56XE2

Page Number : 1 of 30

Report Issued Date : Mar. 09, 2018

Report Version : Rev. 01

Report Template No.: BU5-FGLTE Version 2.0



TABLE OF CONTENTS

REVISION HISTORY..... 3

SUMMARY OF TEST RESULT 4

1 GENERAL DESCRIPTION 6

 1.1 Applicant 6

 1.2 Manufacturer 6

 1.3 Product Feature of Equipment Under Test..... 6

 1.4 Product Specification of Equipment Under Test..... 8

 1.5 Modification of EUT 8

 1.6 Emission Designator 9

 1.7 Testing Location 11

 1.8 Applicable Standards..... 11

2 TEST CONFIGURATION OF EQUIPMENT UNDER TEST 12

 2.1 Test Mode 12

 2.2 Connection Diagram of Test System 14

 2.3 Support Unit used in test configuration and system 15

 2.4 Measurement Results Explanation Example 15

 2.5 Frequency List of Low/Middle/High Channels 16

3 CONDUCTED TEST ITEMS 19

 3.1 Measuring Instruments 19

 3.2 Test Setup 19

 3.3 Test Result of Conducted Test 19

 3.4 Conducted Output Power and ERP/EIRP 20

 3.5 Peak-to-Average Ratio 21

 3.6 Occupied Bandwidth 22

 3.7 Conducted Band Edge 23

 3.8 Conducted Spurious Emission 25

 3.9 Frequency Stability 26

4 RADIATED TEST ITEMS 27

 4.1 Measuring Instruments 27

 4.2 Test Setup 27

 4.3 Test Result of Radiated Test 27

 4.4 Radiated Spurious Emission 28

5 LIST OF MEASURING EQUIPMENT 29

6 UNCERTAINTY OF EVALUATION 30

APPENDIX A. TEST RESULTS OF CONDUCTED TEST

APPENDIX B. TEST RESULTS OF ERP/EIRP AND RADIATED TEST



SUMMARY OF TEST RESULT

Report Section	FCC Rule	Description	Limit	Result	Remark
3.4	§2.1046	Conducted Output Power	Reporting Only	PASS	-
	§22.913(a)(2)	Effective Radiated Power (Band 5)	ERP < 7 Watt		
	§27.50(b)(10)	Effective Radiated Power (Band 13)	ERP < 3 Watt		
	§24.232(c) §27.50(h)(2)	Equivalent Isotropic Radiated Power (Band 2)(Band 7)	EIRP < 2Watt		
	§27.50(d)(4)	Equivalent Isotropic Radiated Power (Band 4) (Band 66)	EIRP < 1Watt		
3.5	§24.232(d)	Peak-to-Average Ratio	<13 dB	PASS	-
3.6	§2.1049	Occupied Bandwidth	Reporting Only	PASS	-
3.7	§2.1051 §22.917(a) §24.238(a) §27.53(c)(2)(4) §27.53(h)	Conducted Band Edge Measurement (Band 2) (Band 4) (Band 5) (Band 13) (Band 66)	< 43+10log ₁₀ (P[Watts])	PASS	-
	§27.53(m)(4)	Conducted Band Edge Measurement (Band 7)	§27.53(m)(4)		
3.8	§2.1051 §22.917(a) §24.238(a) §27.53(c)(2) §27.53(h)	Conducted Spurious Emission (Band 2) (Band 4) (Band 5) (Band 13) (Band 66)	< 43+10log ₁₀ (P[Watts])	PASS	-
	§2.1051 §27.53(m)(4)	Conducted Spurious Emission (Band 7)	< 55+10log ₁₀ (P[Watts])		
3.9	§2.1055 §22.355	Frequency Stability Temperature & Voltage	< 2.5 ppm for Part 22	PASS	-
	§2.1055 §24.235 §27.54		Within Authorized Band		



Report Section	FCC Rule	Description	Limit	Result	Remark
4.4	§2.1053 §22.917(a) §24.238(a) §27.53(c)(2) §27.53(f) §27.53(h)	Radiated Spurious Emission (Band 2) (Band 4) (Band 5) (Band 13) (Band 66)	$< 43+10\log_{10}(P[\text{Watts}])$	PASS	Under limit 12.42 dB at 5004.000 MHz
	§2.1053 §27.53(m)(4)	Radiated Spurious Emission (Band 7) (Band 41)	$< 55+10\log_{10}(P[\text{Watts}])$		



1 General Description

1.1 Applicant

Motorola Mobility LLC
222 W,Merchandise Mart Plaza, Chicago IL 60654 USA

1.2 Manufacturer

Motorola Mobility LLC
222 W,Merchandise Mart Plaza, Chicago IL 60654 USA

1.3 Product Feature of Equipment Under Test

Product Feature	
Equipment	Mobile Cellular Phone
Brand Name	Motorola
Model Name	XT1929-1(SS)
FCC ID	IHDT56XE2
IMEI Code	Conducted : IMEI: 351885090004549 Radiation : IMEI: 351885090010710
EUT supports Radios application	CDMA/EV-DO/GSM/EGPRS/WCDMA/HSPA/LTE/GNSS/NFC WLAN 11b/g/n HT20 WLAN 11a/n HT20/HT40 WLAN 11ac VHT20/VHT40/VHT80 Bluetooth BR/EDR/LE
HW Version	DVT2
EUT Stage	Identical Prototype

Remark:

1. The above EUT's information was declared by manufacturer. Please refer to the specifications or user's manual for more detailed description.
2. This is a variant report. Except Coneucted test item for LTE Band 2 and Band 5, Conducted Output Power, Equivalent Isotropic Radiated Power, Effective Radiated Power, Radiated Spurious Emission, FG811821-02B report reuses test data from the FG811821B report.



Accessory List	
AC Adapter 1	Brand Name : Motorola
	Model Name : SC-22 SPN5970A
	Manufacturer : Salom
AC Adapter 2	Brand Name : Motorola
	Model Name : SC-22 SPN5993A
	Manufacturer : Chenyang
Battery	Brand Name : Motorola
	Model Name : JS40
	Manufacturer : SUNWODA
C2Audio Cable 1	Brand Name : Motorola
	Model Name : SC18C27844
	Manufacturer : Luxshare
C2Audio Cable 2	Brand Name : Motorola
	Model Name : SC18C27845
	Manufacturer : Cabletech
USB Cable 1	Brand Name : Cabletech
	Model Name : SKN6473A
USB Cable 2	Brand Name : FOXLINK
	Model Name : SKN6473A 17195-C 0403532
USB Cable 3	Brand Name : SAIBAO
	Model Name : SKN6473A 17214-C 1127044
USB Cable 4	Brand Name : Luxshare
	Model Name : SKN6473A 17227-C 1126538



1.4 Product Specification of Equipment Under Test

Standards-related Product Specification	
Tx Frequency	LTE Band 2: 1850.7 MHz ~ 1909.3 MHz LTE Band 4: 1710.7 MHz ~ 1754.3 MHz LTE Band 5: 824.7 MHz ~ 848.3 MHz LTE Band 7: 2502.5 MHz ~ 2567.5 MHz LTE Band 13: 779.5 MHz ~ 784.5 MHz LTE Band 66: 1710.7 MHz ~ 1779.3 MHz
Rx Frequency	LTE Band 2: 1930.7 MHz ~ 1989.3 MHz LTE Band 4: 2110.7 MHz ~ 2154.3 MHz LTE Band 5: 869.7 MHz ~ 893.3 MHz LTE Band 7: 2622.5 MHz ~ 2687.5 MHz LTE Band 13: 748.5 MHz ~ 753.5 MHz LTE Band 66: 2110.7 MHz ~ 2199.3 MHz
Bandwidth	LTE Band 2: 1.4MHz / 3MHz / 5MHz / 10MHz / 15MHz / 20MHz LTE Band 4: 1.4MHz / 3MHz / 5MHz / 10MHz / 15MHz / 20MHz LTE Band 5: 1.4MHz / 3MHz / 5MHz / 10MHz LTE Band 7: 5MHz / 10MHz / 15MHz / 20MHz LTE Band 13: 5MHz / 10MHz LTE Band 66: 1.4MHz / 3MHz / 5MHz / 10MHz / 15MHz / 20MHz
Maximum Output Power to Antenna	LTE Band 2: 23.50 dBm LTE Band 4: 22.96 dBm LTE Band 5: 22.93 dBm LTE Band 7: 23.03 dBm LTE Band 13: 22.62 dBm LTE Band 66: 22.94 dBm
Antenna Type	Fixed Internal Antenna
Antenna Gain	<Main Antenna> LTE Band 2: -2.1 dBi LTE Band 4: -2.0 dBi LTE Band 5: -5.6 dBi LTE Band 7: 0.3 dBi LTE Band 13: -5.9 dBi LTE Band 66: -2.0 dBi <Aux. Antenna> LTE Band 7: -4.7 dBi
Type of Modulation	QPSK / 16QAM / 64QAM

1.5 Modification of EUT

No modifications are made to the EUT during all test items.



1.6 Emission Designator

<For Main Antenna>

LTE Band 2		QPSK			16QAM			64QAM		
BW (MHz)	Frequency Range (MHz)	Emission Designator (99%OBW)	Frequency Tolerance (ppm)	Maximum EIRP(W)	Emission Designator (99%OBW)	Frequency Tolerance (ppm)	Maximum EIRP(W)	Emission Designator (99%OBW)	Frequency Tolerance (ppm)	Maximum EIRP(W)
1.4	1850.7 ~ 1909.3	1M09G7D	-	0.1288	1M09W7D	-	0.1091	1M09W7D	-	0.0796
3	1851.5 ~ 1908.5	2M75G7D	-	0.1303	2M73W7D	-	0.1094	2M72W7D	-	0.0791
5	1852.5 ~ 1907.5	4M51G7D	-	0.1309	4M50W7D	-	0.1096	4M50W7D	-	0.0807
10	1855.0 ~ 1905.0	9M07G7D	0.0082	0.1352	9M03W7D	-	0.1094	9M03W7D	-	0.0839
15	1857.5 ~ 1902.5	13M5G7D	-	0.1327	13M5W7D	-	0.1094	13M5W7D	-	0.0828
20	1860.0 ~ 1900.0	18M6G7D	-	0.1380	18M4W7D	-	0.1096	18M5W7D	-	0.0839
LTE Band 4		QPSK			16QAM			64QAM		
BW (MHz)	Frequency Range (MHz)	Emission Designator (99%OBW)	Frequency Tolerance (ppm)	Maximum EIRP(W)	Emission Designator (99%OBW)	Frequency Tolerance (ppm)	Maximum EIRP(W)	Emission Designator (99%OBW)	Frequency Tolerance (ppm)	Maximum EIRP(W)
1.4	1710.7 ~ 1754.3	-	-	0.1213	-	-	0.1019	-	-	0.0745
3	1711.5 ~ 1753.5	-	-	0.1219	-	-	0.1009	-	-	0.0746
5	1712.5 ~ 1752.5	-	-	0.1219	-	-	0.1030	-	-	0.0746
10	1715.0 ~ 1750.0	-	-	0.1230	-	-	0.1057	-	-	0.0755
15	1717.5 ~ 1747.5	-	-	0.1245	-	-	0.1076	-	-	0.0774
20	1720.0 ~ 1745.0	-	-	0.1247	-	-	0.1119	-	-	0.0780
LTE Band 5		QPSK			16QAM			64QAM		
BW (MHz)	Frequency Range (MHz)	Emission Designator (99%OBW)	Frequency Tolerance (ppm)	Maximum ERP(W)	Emission Designator (99%OBW)	Frequency Tolerance (ppm)	Maximum ERP(W)	Emission Designator (99%OBW)	Frequency Tolerance (ppm)	Maximum EIRP(W)
1.4	824.7 ~ 848.3	1M10G7D	-	0.0327	1M09W7D	-	0.0283	1M09W7D	-	0.0200
3	825.5 ~ 847.5	2M73G7D	-	0.0329	2M73W7D	-	0.0282	2M75W7D	-	0.0200
5	826.5 ~ 846.5	4M52G7D	-	0.0329	4M50W7D	-	0.0282	4M50W7D	-	0.0202
10	829.0 ~ 844.0	9M05G7D	0.0132	0.0330	9M01W7D	-	0.0287	9M05W7D	-	0.0202
LTE Band 7		QPSK			16QAM			64QAM		
BW (MHz)	Frequency Range (MHz)	Emission Designator (99%OBW)	Frequency Tolerance (ppm)	Maximum EIRP(W)	Emission Designator (99%OBW)	Frequency Tolerance (ppm)	Maximum EIRP(W)	Emission Designator (99%OBW)	Frequency Tolerance (ppm)	Maximum EIRP(W)
5	2502.5 ~ 2567.5	-	-	0.2143	-	-	0.1837	-	-	0.1340
10	2505.0 ~ 2565.0	-	-	0.2143	-	-	0.1854	-	-	0.1337
15	2507.5 ~ 2562.5	-	-	0.2133	-	-	0.1832	-	-	0.1334
20	2510.0 ~ 2560.0	-	-	0.2153	-	-	0.1824	-	-	0.1327



LTE Band 13		QPSK			16QAM			64QAM		
BW (MHz)	Frequency Range (MHz)	Emission Designator (99%OBW)	Frequency Tolerance (ppm)	Maximum ERP(W)	Emission Designator (99%OBW)	Frequency Tolerance (ppm)	Maximum ERP(W)	Emission Designator (99%OBW)	Frequency Tolerance (ppm)	Maximum EIRP(W)
5	779.5 ~ 784.5	-	-	0.0285	-	-	0.0274	-	-	0.0191
10	782.0	-	-	0.0286	-	-	0.0272	-	-	0.0189
LTE Band 66		QPSK			16QAM			64QAM		
BW (MHz)	Frequency Range (MHz)	Emission Designator (99%OBW)	Frequency Tolerance (ppm)	Maximum EIRP(W)	Emission Designator (99%OBW)	Frequency Tolerance (ppm)	Maximum EIRP(W)	Emission Designator (99%OBW)	Frequency Tolerance (ppm)	Maximum EIRP(W)
1.4	1710.7 ~ 1779.3	-	-	0.1199	-	-	0.1007	-	-	0.0743
3	1711.5 ~ 1778.5	-	-	0.1199	-	-	0.1040	-	-	0.0741
5	1712.5 ~ 1777.5	-	-	0.1211	-	-	0.1035	-	-	0.0753
10	1715.0 ~ 1775.0	-	-	0.1222	-	-	0.1033	-	-	0.0759
15	1717.5 ~ 1772.5	-	-	0.1239	-	-	0.1050	-	-	0.0776
20	1720.0 ~ 1770.0	-	-	0.1242	-	-	0.1074	-	-	0.0773

<For Aux. Antenna>

LTE Band 7		QPSK	16QAM	64QAM
BW (MHz)	Frequency Range (MHz)	Maximum EIRP(W)	Maximum EIRP(W)	Maximum EIRP(W)
5	2502.5 ~ 2567.5	0.0678	0.0581	0.0424
10	2505.0 ~ 2565.0	0.0678	0.0586	0.0423
15	2507.5 ~ 2562.5	0.0675	0.0579	0.0422
20	2510.0 ~ 2560.0	0.0681	0.0577	0.0420



1.7 Testing Location

Sporton Lab is accredited to ISO 17025 by Taiwan Accreditation Foundation (TAF code : 1190) and the FCC designation No. TW1190 and TW0007 under the FCC 2.948(e) by Mutual Recognition Agreement (MRA) in FCC Test.

Test Site	SPORTON INTERNATIONAL INC.
Test Site Location	No. 52, Hwa Ya 1 st Rd., Hwa Ya Technology Park, Kwei-Shan District, Tao Yuan City, Taiwan, R.O.C. TEL: +886-3-327-3456 FAX: +886-3-328-4978
Test Site No.	Sporton Site No. TH05HY

Note: The test site complies with ANSI C63.4 2014 requirement.

Test Site	SPORTON INTERNATIONAL INC.
Test Site Location	No.58, Aly. 75, Ln. 564, Wenhua 3rd Rd. Guishan Dist, Taoyuan City, Taiwan (R.O.C.) TEL: +886-3-327-0868 FAX: +886-3-327-0855
Test Site No.	Sporton Site No. 03CH11-HY

Note: The test site complies with ANSI C63.4 2014 requirement.

1.8 Applicable Standards

According to the specifications of the manufacturer, the EUT must comply with the requirements of the following standards:

- 47 CFR Part 2, 22(H), 24(E), 27
- ANSI / TIA-603-E
- FCC KDB 971168 D01 Power Meas. License Digital Systems v03
- FCC KDB 412172 D01 Determining ERP and EIRP v01r01

Remark:

1. All test items were verified and recorded according to the standards and without any deviation during the test.
2. This EUT has also been tested and complied with the requirements of FCC Part 15, Subpart B, recorded in a separate test report.



2 Test Configuration of Equipment Under Test

2.1 Test Mode

Antenna port conducted and radiated test items listed below are performed according to KDB 971168 D01 Power Meas. License Digital Systems v03 with maximum output power.

Radiated measurements are performed by rotating the EUT in three different orthogonal test planes to find the maximum emission.

Test Items	Band	Bandwidth (MHz)						Modulation			RB #			Test Channel		
		1.4	3	5	10	15	20	QPSK	16QAM	64QAM	1	Half	Full	L	M	H
Max. Output Power	2	v	v	v	v	v	v	v	v	v	v	v	v	v	v	v
	4	v	v	v	v	v	v	v	v	v	v	v	v	v	v	v
	5	v	v	v	v	-	-	v	v	v	v	v	v	v	v	v
	7	-	-	v	v	v	v	v	v	v	v	v	v	v	v	v
	13	-	-	v	v	-	-	v	v	v	v	v	v	v	v	v
	66	v	v	v	v	v	v	v	v	v	v	v	v	v	v	v
Peak-to-Average Ratio	2						v	v	v	v	v		v	v	v	v
	5				v	-	-	v	v	v	v		v	v	v	v
26dB and 99% Bandwidth	2	v	v	v	v	v	v	v	v	v			v	v	v	v
	5	v	v	v	v	-	-	v	v	v			v	v	v	v
Conducted Band Edge	2	v	v	v	v	v	v	v	v	v	v		v	v		v
	5	v	v	v	v	-	-	v	v	v	v		v	v		v
Conducted Spurious Emission	2	v	v	v	v	v	v	v	v	v	v			v	v	v
	5	v	v	v	v	-	-	v	v	v	v			v	v	v
Frequency Stability	2				v			v						v	v	
	5				v	-	-	v						v	v	



Test Items	Band	Bandwidth (MHz)						Modulation			RB #			Test Channel		
		1.4	3	5	10	15	20	QPSK	16QAM	64QAM	1	Half	Full	L	M	H
E.R.P / E.I.R.P	2	v	v	v	v	v	v	v	v	v	v	v	v	v	v	v
	4	v	v	v	v	v	v	v	v	v	v	v	v	v	v	v
	5	v	v	v	v	-	-	v	v	v	v	v	v	v	v	v
	7	-	-	v	v	v	v	v	v	v	v	v		v	v	v
	13	-	-	v	v	-	-	v	v	v	v	v		v	v	v
	66	v	v	v	v	v	v	v	v	v	v	v		v	v	v
Radiated Spurious Emission	2	Worst Case											v	v	v	
	4	Worst Case											v	v	v	
	5	Worst Case											v	v	v	
	7	Worst Case											v	v	v	
	13	Worst Case											v	v	v	
	66	Worst Case											v	v	v	
Note	<ol style="list-style-type: none"> 1. The mark "v " means that this configuration is chosen for testing 2. The mark "- " means that this bandwidth is not supported. 3. The device is investigated from 30MHz to 10 times of fundamental signal for radiated spurious emission test under different RB size/offset and modulations in exploratory test. Subsequently, only the worst case emissions are reported. 															

2.2 Connection Diagram of Test System

<EUT with Standalone>

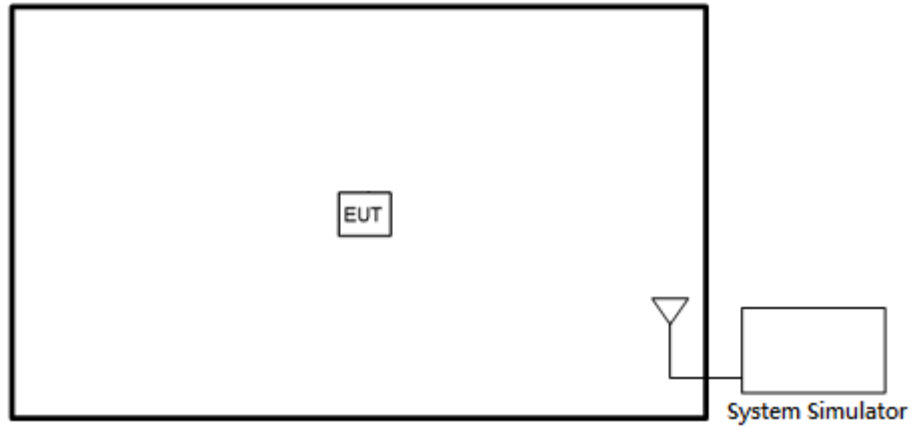

<EUT with Adapter>

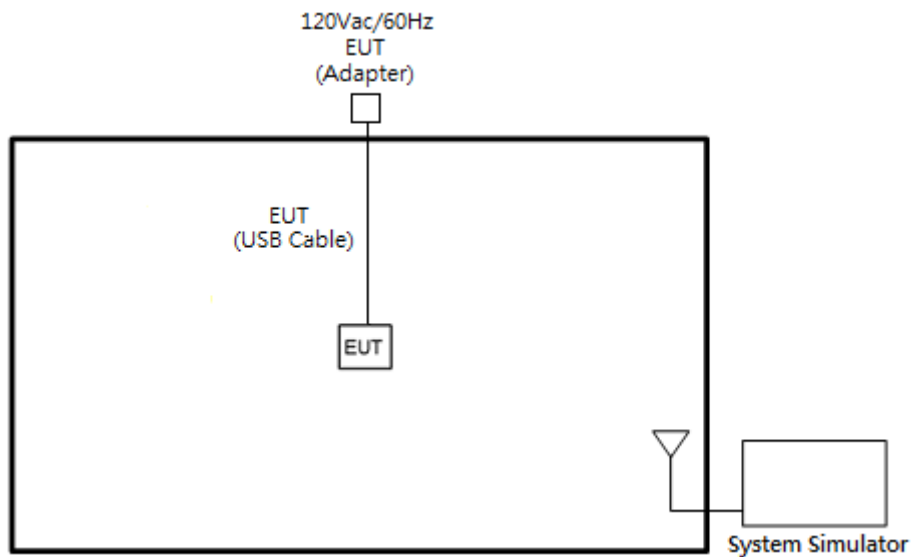



2.3 Support Unit used in test configuration and system

Item	Equipment	Trade Name	Model No.	FCC ID	Data Cable	Power Cord
1.	LTE Base Station	Anritsu	MT8821C	N/A	N/A	Unshielded, 1.8 m

2.4 Measurement Results Explanation Example

For all conducted test items:

The offset level is set in the spectrum analyzer to compensate the RF cable loss and attenuator factor between EUT conducted output port and spectrum analyzer. With the offset compensation, the spectrum analyzer reading level is exactly the EUT RF output level.

The spectrum analyzer offset is derived from RF cable loss and attenuator factor.

$$\text{Offset} = \text{RF cable loss} + \text{attenuator factor}.$$

Following shows an offset computation example with cable loss 4.2 dB and 10dB attenuator.

Example :

$$\begin{aligned} \text{Offset(dB)} &= \text{RF cable loss(dB)} + \text{attenuator factor(dB)}. \\ &= 4.2 + 10 = 14.2 \text{ (dB)} \end{aligned}$$



2.5 Frequency List of Low/Middle/High Channels

LTE Band 2 Channel and Frequency List				
BW [MHz]	Channel/Frequency(MHz)	Lowest	Middle	Highest
20	Channel	18700	18900	19100
	Frequency	1860	1880	1900
15	Channel	18675	18900	19125
	Frequency	1857.5	1880	1902.5
10	Channel	18650	18900	19150
	Frequency	1855	1880	1905
5	Channel	18625	18900	19175
	Frequency	1852.5	1880	1907.5
3	Channel	18615	18900	19185
	Frequency	1851.5	1880	1908.5
1.4	Channel	18607	18900	19193
	Frequency	1850.7	1880	1909.3

LTE Band 4 Channel and Frequency List				
BW [MHz]	Channel/Frequency(MHz)	Lowest	Middle	Highest
20	Channel	20050	20175	20300
	Frequency	1720	1732.5	1745
15	Channel	20025	20175	20325
	Frequency	1717.5	1732.5	1747.5
10	Channel	20000	20175	20350
	Frequency	1715	1732.5	1750
5	Channel	19975	20175	20375
	Frequency	1712.5	1732.5	1752.5
3	Channel	19965	20175	20385
	Frequency	1711.5	1732.5	1753.5
1.4	Channel	19957	20175	20393
	Frequency	1710.7	1732.5	1754.3



LTE Band 5 Channel and Frequency List				
BW [MHz]	Channel/Frequency(MHz)	Lowest	Middle	Highest
10	Channel	20450	20525	20600
	Frequency	829	836.5	844
5	Channel	20425	20525	20625
	Frequency	826.5	836.5	846.5
3	Channel	20415	20525	20635
	Frequency	825.5	836.5	847.5
1.4	Channel	20407	20525	20643
	Frequency	824.7	836.5	848.3

LTE Band 7 Channel and Frequency List				
BW [MHz]	Channel/Frequency(MHz)	Lowest	Middle	Highest
20	Channel	20850	21100	21350
	Frequency	2510	2535	2560
15	Channel	20825	21100	21375
	Frequency	2507.5	2535	2562.5
10	Channel	20800	21100	21400
	Frequency	2505	2535	2565
5	Channel	20775	21100	21425
	Frequency	2502.5	2535	2567.5

LTE Band 13 Channel and Frequency List				
BW [MHz]	Channel/Frequency(MHz)	Lowest	Middle	Highest
10	Channel	-	23230	-
	Frequency	-	782	-
5	Channel	23205	23230	23255
	Frequency	779.5	782	784.5



LTE Band 66 Channel and Frequency List				
BW [MHz]	Channel/Frequency(MHz)	Lowest	Middle	Highest
20	Channel	132072	132322	132572
	Frequency	1720	1745	1770
15	Channel	132047	132322	132597
	Frequency	1717.5	1745	1772.5
10	Channel	132022	132322	132622
	Frequency	1715	1745	1775
5	Channel	131997	132322	132647
	Frequency	1712.5	1745	1777.5
3	Channel	131987	132322	132657
	Frequency	1711.5	1745	1778.5
1.4	Channel	131979	132322	132665
	Frequency	1710.7	1745	1779.3

3 Conducted Test Items

3.1 Measuring Instruments

See list of measuring instruments of this test report.

3.2 Test Setup

3.2.1 Conducted Output Power

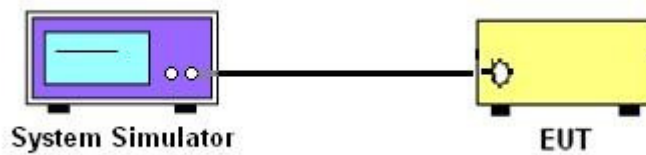

3.2.2 Peak-to-Average Ratio, Occupied Bandwidth ,Conducted Band-Edge and Conducted Spurious Emission

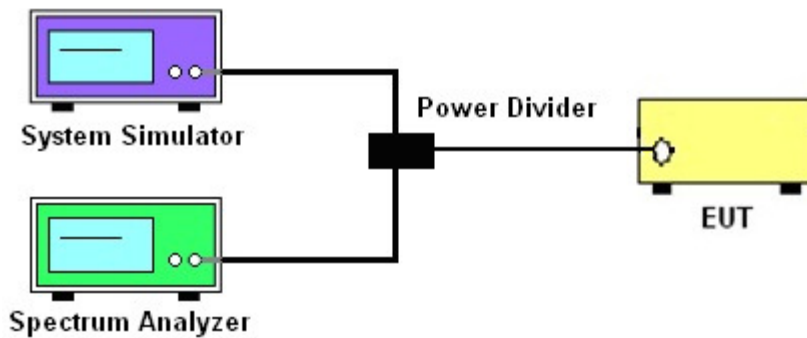

3.2.3 Frequency Stability

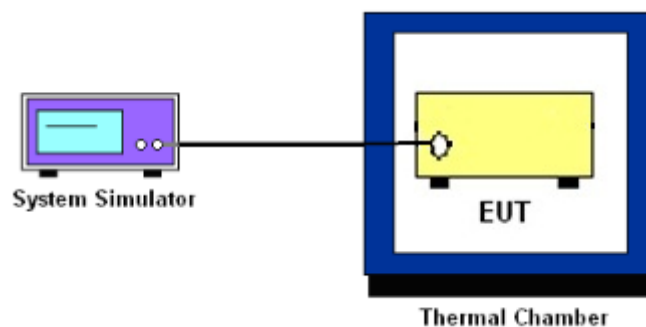

3.3 Test Result of Conducted Test

Please refer to Appendix A.



3.4 Conducted Output Power and ERP/EIRP

3.4.1 Description of the Conducted Output Power Measurement and ERP/EIRP Measurement

A system simulator was used to establish communication with the EUT. Its parameters were set to force the EUT transmitting at maximum output power. The measured power in the radio frequency on the transmitter output terminals shall be reported.

The ERP of mobile transmitters must not exceed 7 Watts for LTE Band 5.

The ERP of mobile transmitters must not exceed 3 Watts for LTE Band 13.

The EIRP of mobile transmitters must not exceed 2 Watts for LTE Band 2 and Band 7.

The EIRP of mobile transmitters must not exceed 1 Watts for LTE Band 4 and Band 66.

According to KDB 412172 D01 Power Approach,

$EIRP = P_T + G_T - L_C$, $ERP = EIRP - 2.15$, where

P_T = transmitter output power in dBm

G_T = gain of the transmitting antenna in dBi

L_C = signal attenuation in the connecting cable between the transmitter and antenna in dB

3.4.2 Test Procedures

1. The transmitter output port was connected to the system simulator.
2. Set EUT at maximum power through the system simulator.
3. Select lowest, middle, and highest channels for each band and different modulation.
4. Measure and record the power level from the system simulator.



3.5 Peak-to-Average Ratio

3.5.1 Description of the PAR Measurement

Power Complementary Cumulative Distribution Function (CCDF) curves provide a means for characterizing the power peaks of a digitally modulated signal on a statistical basis. A CCDF curve depicts the probability of the peak signal amplitude exceeding the average power level. Most contemporary measurement instrumentation include the capability to produce CCDF curves for an input signal provided that the instrument's resolution bandwidth can be set wide enough to accommodate the entire input signal bandwidth. In measuring transmissions in this band using an average power technique, the peak-to-average ratio (PAR) of the transmission may not exceed 13 dB.

3.5.2 Test Procedures

The testing follows FCC KDB 971168 v03 Section 5.7.1

1. The EUT was connected to spectrum and system simulator via a power divider.
2. Set the CCDF (Complementary Cumulative Distribution Function) option in spectrum analyzer.
3. The highest RF powers were measured and recorded the maximum PAPR level associated with a probability of 0.1 %.
4. Record the deviation as Peak to Average Ratio.



3.6 Occupied Bandwidth

3.6.1 Description of Occupied Bandwidth Measurement

The occupied bandwidth is the width of a frequency band such that, below the lower and above the upper frequency limits, the mean powers emitted are each equal to a specified percentage 0.5% of the total mean transmitted power.

The 26 dB emission bandwidth is defined as the frequency range between two points, one above and one below the carrier frequency, at which the spectral density of the emission is attenuated 26 dB below the maximum in-band spectral density of the modulated signal. Spectral density (power per unit bandwidth) is to be measured with a detector of resolution bandwidth equal to approximately 1.0% of the emission bandwidth.

3.6.2 Test Procedures

The testing follows FCC KDB 971168 v03 Section 4.2

1. The EUT was connected to spectrum analyzer and system simulator via a power divider.
2. The spectrum analyzer center frequency is set to the nominal EUT channel center frequency. The span range for the spectrum analyzer shall be between two and five times the anticipated OBW.
3. The nominal resolution bandwidth (RBW) shall be in the range of 1 to 5 % of the anticipated OBW, and the VBW shall be at least 3 times the RBW.
4. Set the detection mode to peak, and the trace mode to max hold.
5. Determine the reference value: Set the EUT to transmit a modulated signal. Allow the trace to stabilize. Set the spectrum analyzer marker to the highest level of the displayed trace.
(this is the reference value)
6. Determine the “-26 dB down amplitude” as equal to (Reference Value – X).
7. Place two markers, one at the lowest and the other at the highest frequency of the envelope of the spectral display such that each marker is at or slightly below the “-X dB down amplitude” determined in step 6. If a marker is below this “-X dB down amplitude” value it shall be placed as close as possible to this value. The OBW is the positive frequency difference between the two markers.
8. Use the 99 % power bandwidth function of the spectrum analyzer and report the measured bandwidth.



3.7 Conducted Band Edge

3.7.1 Description of Conducted Band Edge Measurement

22.917(a)

For operations in the 824 – 849 MHz band, the FCC limit is $43 + 10\log_{10}(P[\text{Watts}])$ dB below the transmitter power $P(\text{Watts})$ in a 100kHz bandwidth. However, in the 1MHz bands immediately outside and adjacent to the licensee's frequency block, a resolution bandwidth of at least one percent of the emission bandwidth of the fundamental emission of the transmitter may be employed.

24.238 (a)

For operations in the 1850-1910 and 1930-1990 MHz band, the FCC limit is $43 + 10\log_{10}(P[\text{Watts}])$ dB below the transmitter power $P(\text{Watts})$ in a 1MHz bandwidth. However, in the 1 MHz bands immediately outside and adjacent to the frequency block a resolution bandwidth of at least one percent of the emission bandwidth of the fundamental emission of the transmitter may be employed.

27.53 (c)

For operations in the 776-788 MHz band, the FCC limit is $43 + 10\log_{10}(P[\text{Watts}])$ dB below the transmitter power $P(\text{Watts})$ in a 100 kHz bandwidth. However, in the 100 kHz bands immediately outside and adjacent to the frequency block, a resolution bandwidth of at least 30 kHz may be employed. In addition, the power of any unwanted emissions in any 6.25 kHz bandwidth for all frequencies between 763-775 MHz and 793-806 MHz shall be attenuated below the transmitter power, P (dBW), by at least $65 + 10 \log_{10} p(\text{watts})$, dB, for mobile and portable equipment.

27.53 (h)

For operations in the 1710 – 1755 MHz band, the FCC limit is $43 + 10\log_{10}(P[\text{Watts}])$ dB below the transmitter power $P(\text{Watts})$ in a 1 MHz bandwidth. However, in the 1MHz bands immediately outside and adjacent to the licensee's frequency block, a resolution bandwidth of at least one percent of the emission bandwidth of the fundamental emission of the transmitter may be employed.



3.7.2 Test Procedures

The testing follows FCC KDB 971168 v03 Section 6.0.

1. The EUT was connected to spectrum analyzer and system simulator via a power divider.
2. The band edges of low and high channels for the highest RF powers were measured.
3. Set RBW \geq 1% EBW in the 1MHz band immediately outside and adjacent to the band edge.
4. Beyond the 1 MHz band from the band edge, RBW=1MHz was used.
5. Set spectrum analyzer with RMS detector.
6. The RF fundamental frequency should be excluded against the limit line in the operating frequency band.
7. Checked that all the results comply with the emission limit line.

The limit line is derived from $43 + 10\log(P)$ dB below the transmitter power P(Watts)



3.8 Conducted Spurious Emission

3.8.1 Description of Conducted Spurious Emission Measurement

The power of any emission outside of the authorized operating frequency ranges must be lower than the transmitter power (P) by a factor of at least $43 + 10 \log (P)$ dB.

It is measured by means of a calibrated spectrum analyzer and scanned from 30 MHz up to a frequency including its 10th harmonic.

3.8.2 Test Procedures

The testing follows FCC KDB 971168 v03 Section 6.0.

1. The EUT was connected to spectrum analyzer and system simulator via a power divider.
2. The RF output of EUT was connected to the spectrum analyzer by RF cable and attenuator. The path loss was compensated to the results for each measurement.
3. The middle channel for the highest RF power within the transmitting frequency was measured.
4. The conducted spurious emission for the whole frequency range was taken.
5. Make the measurement with the spectrum analyzer's RBW = 1MHz, VBW = 3MHz.
6. Set spectrum analyzer with RMS detector.
7. Taking the record of maximum spurious emission.
8. The RF fundamental frequency should be excluded against the limit line in the operating frequency band.
9. The limit line is derived from $43 + 10\log(P)$ dB below the transmitter power P(Watts)



3.9 Frequency Stability

3.9.1 Description of Frequency Stability Measurement

The frequency stability shall be measured by variation of ambient temperature and variation of primary supply voltage to ensure that the fundamental emission stays within the authorized frequency block. The frequency stability of the transmitter shall be maintained within $\pm 0.00025\%$ ($\pm 2.5\text{ppm}$) of the center frequency.

3.9.2 Test Procedures for Temperature Variation

The testing follows FCC KDB 971168 v03 Section 9.0.

1. The EUT was set up in the thermal chamber and connected with the system simulator.
2. With power OFF, the temperature was decreased to -30°C and the EUT was stabilized before testing. Power was applied and the maximum change in frequency was recorded within one minute.
3. With power OFF, the temperature was raised in 10°C step up to 50°C . The EUT was stabilized at each step for at least half an hour. Power was applied and the maximum frequency change was recorded within one minute.

3.9.3 Test Procedures for Voltage Variation

The testing follows FCC KDB 971168 v03 Section 9.0.

1. The EUT was placed in a temperature chamber at $20\pm 5^{\circ}\text{C}$ and connected with the system simulator.
2. The power supply voltage to the EUT was varied from 85% to 115% of the nominal value measured at the input to the EUT.
3. The variation in frequency was measured for the worst case.

4 Radiated Test Items

4.1 Measuring Instruments

See list of measuring instruments of this test report.

4.2 Test Setup

4.2.1 For radiated test from 30MHz to 1GHz

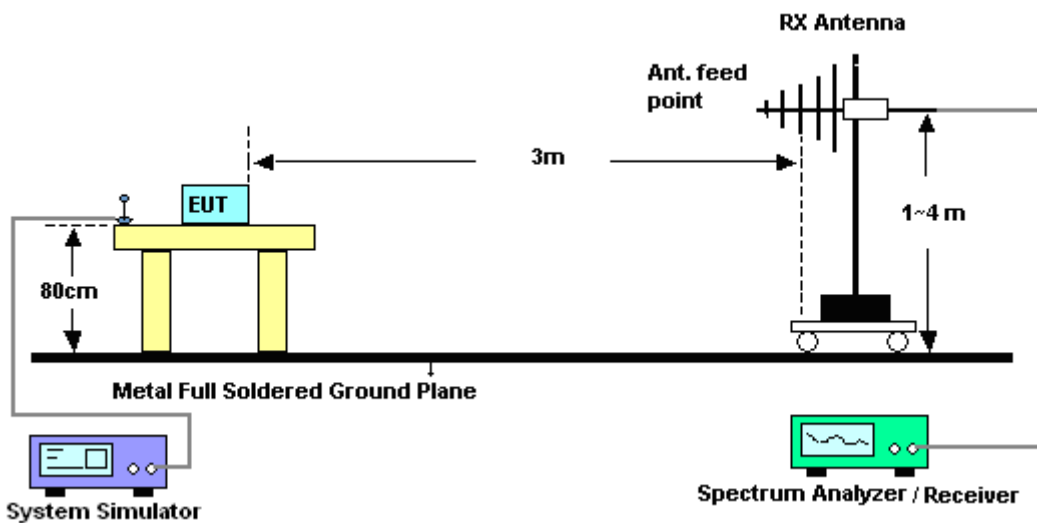

4.2.2 For radiated test above 1GHz

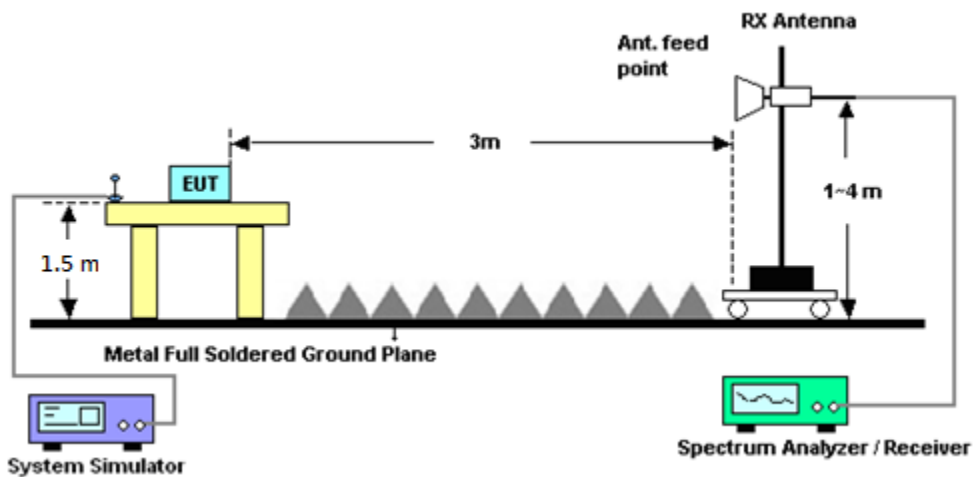

4.3 Test Result of Radiated Test

Please refer to Appendix B.



4.4 Radiated Spurious Emission

4.4.1 Description of Radiated Spurious Emission

The radiated spurious emission was measured by substitution method according to ANSI / TIA-603-E. The power of any emission outside of the authorized operating frequency ranges must be attenuated below the transmitter power (P) by a factor of at least $43 + 10 \log (P)$ dB.

For LTE Band 13

For operations in the 746-758 MHz, 775-788 MHz, and 805-806 MHz bands, emissions in the band 1559-1610 MHz shall be limited to -70 dBW/MHz equivalent isotropically radiated power (EIRP) for wideband signals, and -80 dBW EIRP for discrete emissions of less than 700 Hz bandwidth.

The spectrum is scanned from 30 MHz up to a frequency including its 10th harmonic.

4.4.2 Test Procedures

The testing follows FCC KDB 971168 v03 Section 5.8 and ANSI / TIA-603-E Section 2.2.12.

1. The EUT was placed on a turntable with 0.8 meter for frequency below 1GHz and 1.5 meter for frequency above 1GHz respectively above ground.
2. The EUT was set 3 meters from the receiving antenna, which was mounted on the antenna tower.
3. The table was rotated 360 degrees to determine the position of the highest spurious emission.
4. The height of the receiving antenna is varied between one meter and four meters to search the maximum spurious emission for both horizontal and vertical polarizations.
5. Make the measurement with the spectrum analyzer's RBW = 1MHz, VBW = 3MHz, taking the record of maximum spurious emission.
6. A horn antenna was substituted in place of the EUT and was driven by a signal generator.
7. Tune the output power of signal generator to the same emission level with EUT maximum spurious emission.
8. Taking the record of output power at antenna port.
9. Repeat step 7 to step 8 for another polarization.
10. The RF fundamental frequency should be excluded against the limit line in the operating frequency band.

The limit line is derived from $43 + 10\log(P)$ dB below the transmitter power P(Watts)



5 List of Measuring Equipment

Instrument	Manufacturer	Model No.	Serial No.	Characteristics	Calibration Date	Test Date	Due Date	Remark
LTE Base Station	Anritsu	MT8820C	620143282 1	GSM/GPRS /WCDMA/LTE	Oct. 13, 2017	Jan. 18, 2018 ~ Feb. 27, 2018	Oct. 12, 2018	Conducted (TH05-HY)
Spectrum Analyzer	Rohde & Schwarz	FSV40	101397	10Hz~40GHz	Nov. 09, 2017	Jan. 18, 2018 ~ Feb. 27, 2018	Nov. 08, 2018	Conducted (TH05-HY)
Temperature Chamber	ESPEC	SH-641	92013720	-30°C~70°C	Aug. 28, 2017	Jan. 18, 2018 ~ Feb. 27, 2018	Aug. 27, 2018	Conducted (TH05-HY)
Programmable Power Supply	GW Instek	PSS-2005	EL890001	1V~20V 0.5A~5A	Oct. 06, 2017	Jan. 18, 2018 ~ Feb. 27, 2018	Oct. 05, 2018	Conducted (TH05-HY)
Amplifier	MITEQ	TTA1840-35-HG	1871923	18GHz~40GHz, VSWR : 2.5:1 max	Jul. 18, 2017	Feb. 26, 2018 ~ Mar. 02, 2018	Jul. 17, 2018	Radiation (03CH11-HY)
Amplifier	SONOMA	310N	187312	9kHz~1GHz	Nov. 10, 2016	Feb. 26, 2018 ~ Mar. 02, 2018	Nov. 09, 2018	Radiation (03CH11-HY)
Bilog Antenna	TESEQ	CBL 6111D&N-6-0 6	35414&AT- N0602	30MHz~1GHz	Oct. 14, 2017	Feb. 26, 2018 ~ Mar. 02, 2018	Oct. 13, 2018	Radiation (03CH11-HY)
Horn Antenna	SCHWARZBE CK	BBHA 9120 D	9120D-132 6	1GHz ~ 18GHz	Oct. 16, 2017	Feb. 26, 2018 ~ Mar. 02, 2018	Oct. 15, 2018	Radiation (03CH11-HY)
Horn Antenna	SCHWARZBE CK	BBHA 9120 D	9120D-152 2	1GHz ~ 18GHz	Mar. 17, 2017	Feb. 26, 2018 ~ Mar. 02, 2018	Mar. 16, 2018	Radiation (03CH11-HY)
Preamplifier	Keysight	83017A	MY532700 80	1GHz~26.5GHz	Nov. 10, 2016	Feb. 26, 2018 ~ Mar. 02, 2018	Nov. 09, 2018	Radiation (03CH11-HY)
Spectrum Analyzer	Keysight	N9010A	MY542004 86	10Hz ~ 44GHz	Oct. 19, 2017	Feb. 26, 2018 ~ Mar. 02, 2018	Oct. 18, 2018	Radiation (03CH11-HY)
Antenna Mast	EMEC	AM-BS-4500- B	N/A	1~4m	N/A	Feb. 26, 2018 ~ Mar. 02, 2018	N/A	Radiation (03CH11-HY)
Turn Table	EMEC	TT 2000	N/A	0~360 Degree	N/A	Feb. 26, 2018 ~ Mar. 02, 2018	N/A	Radiation (03CH11-HY)
EMI Test Receiver	Keysight	N9038A (MXE)	MY572901 11	3Hz~26.5GHz	Nov. 02, 2017	Feb. 26, 2018 ~ Mar. 02, 2018	Nov. 01, 2018	Radiation (03CH11-HY)
SHF-EHF Horn Antenna	SCHWARZBE CK	BBHA 9170	BBHA9170 576	18GHz- 40GHz	Apr. 27, 2017	Feb. 26, 2018 ~ Mar. 02, 2018	Apr. 26, 2018	Radiation (03CH11-HY)
SHF-EHF Horn Antenna	SCHWARZBE CK	BBHA 9170	BBHA9170 584	18GHz- 40GHz	Nov. 27, 2017	Feb. 26, 2018 ~ Mar. 02, 2018	Nov. 26, 2018	Radiation (03CH11-HY)
Signal Generator	Rohde & Schwarz	SMF100A	101107	100kHz~40GHz	May 22, 2017	Feb. 26, 2018 ~ Mar. 02, 2018	May 21, 2018	Radiation (03CH11-HY)



6 Uncertainty of Evaluation

Uncertainty of Radiated Emission Measurement (30 MHz ~ 1000 MHz)

Measuring Uncertainty for a Level of Confidence of 95% ($U = 2Uc(y)$)	5.20
---	------

Uncertainty of Radiated Emission Measurement (1 GHz ~ 40 GHz)

Measuring Uncertainty for a Level of Confidence of 95% ($U = 2Uc(y)$)	5.50
---	------

Uncertainty of Radiated Emission Measurement (18 GHz ~ 40 GHz)

Measuring Uncertainty for a Level of Confidence of 95% ($U = 2Uc(y)$)	5.20
---	------



Appendix A. Test Results of Conducted Test

Conducted Output Power(Average power)

LTE Band 2 Maximum Average Power [dBm]						
BW [MHz]	RB Size	RB Offset	Mod	Lowest	Middle	Highest
20	1	0	QPSK	23.50	23.22	23.01
20	1	49		23.17	22.93	22.94
20	1	99		23.25	23.08	22.96
20	50	0		22.29	22.06	22.03
20	50	24		22.21	22.02	21.95
20	50	50		22.10	22.03	21.97
20	100	0		22.17	22.06	21.93
20	1	0	16-QAM	22.50	22.49	22.38
20	1	49		22.45	22.22	22.30
20	1	99		22.49	22.44	22.25
20	50	0		21.39	21.18	21.09
20	50	24		21.38	21.15	21.11
20	50	50		21.24	21.13	21.08
20	100	0		21.26	21.11	20.98
20	1	0	64-QAM	21.34	21.25	21.06
20	1	49		21.04	20.94	21.03
20	1	99		21.03	21.04	20.95
20	50	0		20.09	19.94	19.91
20	50	24		20.09	19.92	19.92
20	50	50		19.87	19.85	19.87
20	100	0		19.95	19.91	19.81
15	1	0	QPSK	23.33	23.08	23.08
15	1	37		23.15	22.92	22.91
15	1	74		23.21	22.93	22.96
15	36	0		22.27	22.06	22.04
15	36	20		22.26	22.00	22.01
15	36	39		22.21	21.99	21.96
15	75	0		22.25	22.02	22.00
15	1	0	16-QAM	22.45	22.39	22.35
15	1	37		22.46	22.24	22.28
15	1	74		22.49	22.26	22.30
15	36	0		21.35	21.19	21.10
15	36	20		21.37	21.13	21.07
15	36	39		21.33	21.08	21.06
15	75	0		21.33	21.12	21.08
15	1	0	64-QAM	21.28	21.08	21.15
15	1	37		21.12	20.94	21.01
15	1	74		21.08	20.93	20.96
15	36	0		20.08	19.95	19.97
15	36	20		20.04	19.92	19.93
15	36	39		20.01	19.87	19.89
15	75	0		20.05	19.88	19.89



LTE Band 2 Maximum Average Power [dBm]						
BW [MHz]	RB Size	RB Offset	Mod	Lowest	Middle	Highest
10	1	0	QPSK	23.41	23.22	22.98
10	1	25		23.17	22.95	22.91
10	1	49		23.38	23.13	22.92
10	25	0		22.21	22.05	21.94
10	25	12		22.25	22.01	21.96
10	25	25		22.19	21.98	21.94
10	50	0		22.21	21.99	21.92
10	1	0	16-QAM	22.49	22.47	22.40
10	1	25		22.46	22.19	22.27
10	1	49		22.49	22.38	22.27
10	25	0		21.35	21.14	21.07
10	25	12		21.33	21.12	21.05
10	25	25		21.32	21.10	21.02
10	50	0		21.31	21.12	21.07
10	1	0	64-QAM	21.34	21.17	21.03
10	1	25		21.09	20.93	20.97
10	1	49		21.25	21.10	20.90
10	25	0		20.07	19.90	19.90
10	25	12		20.04	19.91	19.88
10	25	25		19.99	19.86	19.85
10	50	0		20.03	19.86	19.86
5	1	0	QPSK	23.27	22.99	22.91
5	1	12		23.19	22.93	22.90
5	1	24		23.21	22.95	22.90
5	12	0		22.22	21.95	21.97
5	12	7		22.21	21.99	21.97
5	12	13		22.20	21.93	21.95
5	25	0		22.18	21.94	21.92
5	1	0	16-QAM	22.46	22.35	22.26
5	1	12		22.47	22.32	22.26
5	1	24		22.50	22.29	22.16
5	12	0		21.31	21.12	21.04
5	12	7		21.32	21.11	21.05
5	12	13		21.35	21.07	21.01
5	25	0		21.30	21.10	21.00
5	1	0	64-QAM	21.17	20.97	21.01
5	1	12		21.11	20.91	20.95
5	1	24		21.10	20.91	20.90
5	12	0		20.05	19.88	19.89
5	12	7		20.02	19.90	19.92
5	12	13		20.00	19.87	19.87
5	25	0		19.98	19.83	19.84



LTE Band 2 Maximum Average Power [dBm]						
BW [MHz]	RB Size	RB Offset	Mod	Lowest	Middle	Highest
3	1	0	QPSK	23.25	22.94	22.90
3	1	8		23.20	22.89	22.87
3	1	14		23.15	22.90	22.87
3	8	0		22.19	21.94	21.91
3	8	4		22.25	22.00	21.96
3	8	7		22.17	21.94	21.90
3	15	0		22.21	21.95	21.88
3	1	0	16-QAM	22.49	22.23	22.24
3	1	8		22.44	22.17	22.26
3	1	14		22.42	22.15	22.21
3	8	0		21.32	21.09	21.05
3	8	4		21.35	21.10	21.10
3	8	7		21.39	21.12	21.05
3	15	0		21.30	21.07	20.99
3	1	0	64-QAM	21.08	20.93	20.96
3	1	8		21.08	20.93	20.94
3	1	14		21.06	20.92	20.92
3	8	0		20.00	19.86	19.88
3	8	4		20.04	19.88	19.89
3	8	7		20.00	19.84	19.86
3	15	0		19.96	19.81	19.83
1.4	1	0	QPSK	23.07	22.85	22.80
1.4	1	3		23.18	22.94	22.89
1.4	1	5		23.15	22.84	22.79
1.4	3	0		23.15	22.88	22.86
1.4	3	1		23.20	22.94	22.90
1.4	3	3		23.13	22.86	22.85
1.4	6	0		22.13	21.89	21.87
1.4	1	0	16-QAM	22.38	22.21	22.20
1.4	1	3		22.45	22.21	22.12
1.4	1	5		22.48	22.20	22.11
1.4	3	0		22.13	21.97	21.90
1.4	3	1		22.29	21.99	21.98
1.4	3	3		22.19	21.90	21.90
1.4	6	0		21.26	21.05	21.01
1.4	1	0	64-QAM	21.03	20.88	20.89
1.4	1	3		21.11	20.95	20.96
1.4	1	5		21.03	20.88	20.90
1.4	3	0		21.03	20.86	20.87
1.4	3	1		21.05	20.91	20.91
1.4	3	3		21.01	20.84	20.83
1.4	6	0		19.89	19.77	19.74



LTE Band 4 Maximum Average Power [dBm]						
BW [MHz]	RB Size	RB Offset	Mod	Lowest	Middle	Highest
20	1	0	QPSK	22.96	22.79	22.88
20	1	49		22.79	22.60	22.63
20	1	99		22.65	22.60	22.75
20	50	0		21.92	21.77	22.05
20	50	24		21.77	21.70	22.04
20	50	50		21.73	21.66	22.02
20	100	0		21.76	21.69	22.03
20	1	0	16-QAM	22.30	22.14	22.48
20	1	49		22.08	21.99	22.15
20	1	99		22.00	21.98	22.49
20	50	0		21.01	20.84	21.20
20	50	24		20.86	20.79	21.14
20	50	50		20.80	20.73	21.11
20	100	0		20.83	20.77	21.11
20	1	0	64-QAM	20.92	20.84	20.80
20	1	49		20.75	20.64	20.71
20	1	99		20.60	20.56	20.57
20	50	0		19.77	19.63	19.60
20	50	24		19.57	19.55	19.51
20	50	50		19.51	19.48	19.54
20	100	0		19.58	19.55	19.52
15	1	0	QPSK	22.95	22.78	22.69
15	1	37		22.80	22.62	22.60
15	1	74		22.73	22.62	22.66
15	36	0		21.92	21.70	21.63
15	36	20		21.78	21.65	21.70
15	36	39		21.73	21.62	21.65
15	75	0		21.77	21.66	21.58
15	1	0	16-QAM	22.32	22.11	22.02
15	1	37		22.07	21.97	21.99
15	1	74		22.07	21.95	21.91
15	36	0		20.99	20.82	20.70
15	36	20		20.85	20.78	20.79
15	36	39		20.82	20.74	20.74
15	75	0		20.84	20.78	20.65
15	1	0	64-QAM	20.89	20.83	20.79
15	1	37		20.74	20.63	20.70
15	1	74		20.62	20.58	20.61
15	36	0		19.75	19.62	19.57
15	36	20		19.59	19.56	19.62
15	36	39		19.50	19.50	19.52
15	75	0		19.55	19.54	19.48



LTE Band 4 Maximum Average Power [dBm]						
BW [MHz]	RB Size	RB Offset	Mod	Lowest	Middle	Highest
10	1	0	QPSK	22.90	22.71	22.72
10	1	25		22.82	22.63	22.65
10	1	49		22.83	22.58	22.60
10	25	0		21.87	21.68	21.68
10	25	12		21.83	21.70	21.66
10	25	25		21.84	21.60	21.64
10	50	0		21.84	21.68	21.66
10	1	0	16-QAM	22.24	22.05	21.98
10	1	25		22.06	21.96	21.87
10	1	49		22.18	21.85	21.88
10	25	0		20.96	20.79	20.82
10	25	12		20.95	20.76	20.78
10	25	25		20.91	20.69	20.73
10	50	0		20.92	20.74	20.80
10	1	0	64-QAM	20.78	20.72	20.78
10	1	25		20.74	20.63	20.65
10	1	49		20.68	20.58	20.59
10	25	0		19.71	19.53	19.62
10	25	12		19.67	19.53	19.56
10	25	25		19.62	19.47	19.50
10	50	0		19.64	19.55	19.56
5	1	0	QPSK	22.86	22.67	22.67
5	1	12		22.82	22.63	22.60
5	1	24		22.84	22.63	22.58
5	12	0		21.86	21.65	21.63
5	12	7		21.84	21.64	21.63
5	12	13		21.80	21.62	21.62
5	25	0		21.86	21.64	21.62
5	1	0	16-QAM	22.09	21.95	21.90
5	1	12		22.12	21.92	21.87
5	1	24		22.13	21.85	21.89
5	12	0		20.92	20.72	20.73
5	12	7		20.91	20.74	20.71
5	12	13		20.93	20.72	20.73
5	25	0		20.94	20.73	20.72
5	1	0	64-QAM	20.73	20.65	20.65
5	1	12		20.67	20.61	20.59
5	1	24		20.68	20.59	20.58
5	12	0		19.69	19.56	19.61
5	12	7		19.70	19.55	19.59
5	12	13		19.65	19.52	19.55
5	25	0		19.64	19.50	19.49



LTE Band 4 Maximum Average Power [dBm]						
BW [MHz]	RB Size	RB Offset	Mod	Lowest	Middle	Highest
3	1	0	QPSK	22.86	22.64	22.66
3	1	8		22.83	22.60	22.59
3	1	14		22.86	22.63	22.58
3	8	0		21.85	21.63	21.59
3	8	4		21.88	21.64	21.64
3	8	7		21.86	21.63	21.60
3	15	0		21.84	21.62	21.62
3	1	0	16-QAM	22.03	21.94	21.96
3	1	8		21.97	21.91	21.93
3	1	14		22.04	21.83	21.87
3	8	0		20.96	20.76	20.78
3	8	4		20.96	20.82	20.75
3	8	7		20.93	20.74	20.76
3	15	0		20.93	20.71	20.69
3	1	0	64-QAM	20.73	20.61	20.58
3	1	8		20.72	20.60	20.58
3	1	14		20.68	20.56	20.55
3	8	0		19.67	19.50	19.53
3	8	4		19.65	19.54	19.54
3	8	7		19.64	19.47	19.52
3	15	0		19.64	19.48	19.48
1.4	1	0	QPSK	22.75	22.54	22.47
1.4	1	3		22.80	22.62	22.60
1.4	1	5		22.75	22.53	22.51
1.4	3	0		22.79	22.58	22.55
1.4	3	1		22.84	22.61	22.59
1.4	3	3		22.81	22.60	22.54
1.4	6	0		21.78	21.51	21.53
1.4	1	0	16-QAM	21.97	21.86	21.72
1.4	1	3		22.08	21.84	21.90
1.4	1	5		21.93	21.79	21.81
1.4	3	0		21.75	21.61	21.61
1.4	3	1		21.82	21.68	21.69
1.4	3	3		21.78	21.64	21.61
1.4	6	0		20.88	20.70	20.70
1.4	1	0	64-QAM	20.63	20.52	20.56
1.4	1	3		20.72	20.62	20.61
1.4	1	5		20.65	20.53	20.53
1.4	3	0		20.64	20.52	20.53
1.4	3	1		20.69	20.57	20.59
1.4	3	3		20.66	20.53	20.52
1.4	6	0		19.54	19.39	19.42



LTE Band 5 Maximum Average Power [dBm]						
BW [MHz]	RB Size	RB Offset	Mod	Lowest	Middle	Highest
10	1	0	QPSK	22.93	22.79	22.79
10	1	25		22.85	22.76	22.75
10	1	49		22.78	22.71	22.75
10	25	0		21.95	21.80	21.80
10	25	12		21.88	21.78	21.74
10	25	25		21.85	21.72	21.78
10	50	0		21.91	21.78	21.73
10	1	0	16-QAM	22.33	22.22	22.01
10	1	25		22.25	22.12	22.12
10	1	49		22.09	22.02	22.10
10	25	0		21.03	20.94	20.82
10	25	12		21.00	20.90	20.92
10	25	25		20.95	20.87	20.86
10	50	0		21.01	20.90	20.84
10	1	0	64-QAM	20.81	20.71	20.65
10	1	25		20.72	20.65	20.68
10	1	49		20.63	20.55	20.62
10	25	0		19.63	19.53	19.47
10	25	12		19.63	19.55	19.59
10	25	25		19.54	19.44	19.51
10	50	0		19.59	19.52	19.47
5	1	0	QPSK	22.92	22.80	22.82
5	1	12		22.91	22.75	22.84
5	1	24		22.85	22.73	22.78
5	12	0		21.91	21.82	21.80
5	12	7		21.96	21.80	21.84
5	12	13		21.88	21.79	21.79
5	25	0		21.90	21.81	21.77
5	1	0	16-QAM	22.25	22.10	22.08
5	1	12		22.17	22.08	22.12
5	1	24		22.11	22.03	22.10
5	12	0		21.00	20.90	20.90
5	12	7		20.98	20.92	20.89
5	12	13		20.95	20.84	20.94
5	25	0		20.97	20.89	20.93
5	1	0	64-QAM	20.80	20.65	20.71
5	1	12		20.73	20.61	20.68
5	1	24		20.70	20.59	20.65
5	12	0		19.68	19.58	19.56
5	12	7		19.68	19.54	19.59
5	12	13		19.64	19.52	19.52
5	25	0		19.64	19.48	19.48



LTE Band 5 Maximum Average Power [dBm]						
BW [MHz]	RB Size	RB Offset	Mod	Lowest	Middle	Highest
3	1	0	QPSK	22.92	22.74	22.83
3	1	8		22.90	22.71	22.81
3	1	14		22.88	22.76	22.77
3	8	0		21.93	21.76	21.81
3	8	4		21.94	21.79	21.80
3	8	7		21.90	21.79	21.81
3	15	0		21.90	21.78	21.80
3	1	0	16-QAM	22.23	22.13	22.10
3	1	8		22.24	22.08	22.20
3	1	14		22.26	22.12	22.09
3	8	0		21.08	20.92	20.93
3	8	4		21.08	20.96	20.99
3	8	7		21.05	20.90	20.92
3	15	0		21.00	20.87	20.89
3	1	0	64-QAM	20.74	20.65	20.67
3	1	8		20.76	20.43	20.65
3	1	14		20.72	20.59	20.66
3	8	0		19.67	19.53	19.54
3	8	4		19.68	19.53	19.57
3	8	7		19.64	19.49	19.50
3	15	0		19.62	19.46	19.47
1.4	1	0	QPSK	22.79	22.68	22.67
1.4	1	3		22.87	22.72	22.76
1.4	1	5		22.80	22.66	22.70
1.4	3	0		22.88	22.74	22.74
1.4	3	1		22.89	22.74	22.77
1.4	3	3		22.85	22.70	22.71
1.4	6	0		21.88	21.71	21.71
1.4	1	0	16-QAM	22.06	21.98	22.09
1.4	1	3		22.27	22.15	22.10
1.4	1	5		22.16	22.06	21.95
1.4	3	0		21.97	21.82	21.83
1.4	3	1		22.00	21.84	21.84
1.4	3	3		21.98	21.79	21.82
1.4	6	0		20.99	20.87	20.87
1.4	1	0	64-QAM	20.69	20.55	20.60
1.4	1	3		20.75	20.64	20.65
1.4	1	5		20.69	20.56	20.59
1.4	3	0		20.68	20.55	20.55
1.4	3	1		20.72	20.59	20.60
1.4	3	3		20.67	20.54	20.56
1.4	6	0		19.55	19.42	19.42



LTE Band 7 Maximum Average Power [dBm]						
BW [MHz]	RB Size	RB Offset	Mod	Lowest	Middle	Highest
20	1	0	QPSK	23.03	22.69	22.81
20	1	49		22.92	22.62	22.72
20	1	99		22.78	22.60	22.58
20	50	0		21.93	21.70	21.75
20	50	24		21.90	21.65	21.71
20	50	50		21.86	21.65	21.63
20	100	0		21.87	21.65	21.70
20	1	0	16-QAM	22.27	22.00	21.86
20	1	49		22.31	21.86	22.03
20	1	99		22.12	21.99	22.19
20	50	0		21.03	20.72	20.67
20	50	24		21.04	20.76	20.78
20	50	50		20.94	20.73	20.85
20	100	0		20.95	20.72	20.81
20	1	0	64-QAM	20.56	20.46	20.50
20	1	49		20.71	20.58	20.76
20	1	99		20.62	20.65	20.93
20	50	0		19.51	19.38	19.52
20	50	24		19.53	19.51	19.67
20	50	50		19.48	19.55	19.74
20	100	0		19.50	19.46	19.62
15	1	0	QPSK	22.99	22.67	22.62
15	1	37		22.99	22.61	22.77
15	1	74		22.93	22.62	22.89
15	36	0		21.96	21.64	21.66
15	36	20		21.91	21.68	21.80
15	36	39		21.93	21.63	21.79
15	75	0		21.89	21.66	21.73
15	1	0	16-QAM	22.33	22.02	21.96
15	1	37		22.30	21.94	22.03
15	1	74		22.15	21.91	22.12
15	36	0		21.01	20.70	20.74
15	36	20		21.00	20.76	20.84
15	36	39		20.98	20.75	20.85
15	75	0		20.96	20.73	20.79
15	1	0	64-QAM	20.64	20.55	20.64
15	1	37		20.72	20.64	20.86
15	1	74		20.68	20.65	20.95
15	36	0		19.51	19.42	19.58
15	36	20		19.55	19.57	19.75
15	36	39		19.55	19.56	19.77
15	75	0		19.46	19.50	19.64



LTE Band 7 Maximum Average Power [dBm]						
BW [MHz]	RB Size	RB Offset	Mod	Lowest	Middle	Highest
10	1	0	QPSK	22.94	22.69	22.70
10	1	25		22.96	22.63	22.84
10	1	49		23.01	22.60	22.82
10	25	0		21.94	21.63	21.77
10	25	12		22.02	21.68	21.81
10	25	25		22.02	21.65	21.81
10	50	0		21.95	21.64	21.76
10	1	0	16-QAM	22.30	21.89	21.99
10	1	25		22.21	21.92	22.09
10	1	49		22.38	21.85	22.21
10	25	0		21.02	20.72	20.80
10	25	12		21.10	20.76	20.90
10	25	25		21.09	20.75	20.94
10	50	0		21.03	20.73	20.86
10	1	0	64-QAM	20.65	20.57	20.72
10	1	25		20.71	20.61	20.88
10	1	49		20.73	20.61	20.96
10	25	0		19.53	19.47	19.68
10	25	12		19.57	19.54	19.78
10	25	25		19.62	19.52	19.76
10	50	0		19.53	19.52	19.70
5	1	0	QPSK	22.99	22.59	22.77
5	1	12		23.01	22.66	22.83
5	1	24		22.98	22.58	22.88
5	12	0		22.10	21.68	21.84
5	12	7		21.97	21.68	21.86
5	12	13		21.98	21.68	21.88
5	25	0		21.97	21.68	21.82
5	1	0	16-QAM	22.29	21.89	22.14
5	1	12		22.34	21.89	22.18
5	1	24		22.25	21.96	22.24
5	12	0		21.20	20.74	20.86
5	12	7		21.11	20.76	20.90
5	12	13		21.05	20.78	20.93
5	25	0		21.06	20.76	20.90
5	1	0	64-QAM	20.69	20.55	20.82
5	1	12		20.75	20.59	20.91
5	1	24		20.67	20.59	20.97
5	12	0		19.72	19.48	19.75
5	12	7		19.61	19.57	19.84
5	12	13		19.60	19.57	19.85
5	25	0		19.53	19.50	19.77



LTE Band 13 Maximum Average Power [dBm]						
BW [MHz]	RB Size	RB Offset	Mod	Lowest	Middle	Highest
10	1	0	QPSK		22.62	
10	1	25			22.56	
10	1	49			22.50	
10	25	0			22.17	
10	25	12			22.15	
10	25	25			22.12	
10	50	0			22.15	
10	1	0	16-QAM		22.33	
10	1	25			22.40	
10	1	49			22.36	
10	25	0			20.71	
10	25	12			20.74	
10	25	25			20.67	
10	50	0			20.70	
10	1	0	64-QAM		20.77	
10	1	25			20.81	
10	1	49			20.78	
10	25	0			19.74	
10	25	12			19.71	
10	25	25			19.71	
10	50	0			19.71	
5	1	0	QPSK	22.55	22.60	22.56
5	1	12		22.51	22.57	22.54
5	1	24		22.60	22.55	22.52
5	12	0		22.08	22.11	22.12
5	12	7		22.19	22.13	22.13
5	12	13		22.16	22.08	22.11
5	25	0		22.16	22.11	22.08
5	1	0	16-QAM	22.34	22.40	22.38
5	1	12		22.33	22.39	22.37
5	1	24		22.42	22.37	22.26
5	12	0		20.65	20.71	20.68
5	12	7		20.78	20.72	20.68
5	12	13		20.72	20.72	20.64
5	25	0		20.74	20.70	20.68
5	1	0	64-QAM	20.82	20.87	20.79
5	1	12		20.77	20.80	20.76
5	1	24		20.86	20.76	20.80
5	12	0		19.70	19.79	19.71
5	12	7		19.79	19.78	19.73
5	12	13		19.79	19.76	19.69
5	25	0		19.72	19.72	19.70



LTE Band 66 Maximum Average Power [dBm]						
BW [MHz]	RB Size	RB Offset	Mod	Lowest	Middle	Highest
20	1	0	QPSK	22.94	22.80	22.80
20	1	49		22.74	22.60	22.62
20	1	99		22.74	22.58	22.70
20	50	0		21.89	21.76	21.76
20	50	24		21.84	21.68	21.73
20	50	50		21.78	21.64	21.70
20	100	0		21.84	21.70	21.73
20	1	0	16-QAM	22.31	22.17	22.10
20	1	49		22.00	22.00	21.93
20	1	99		22.10	21.91	22.06
20	50	0		20.99	20.86	20.87
20	50	24		20.93	20.82	20.82
20	50	50		20.89	20.73	20.83
20	100	0		20.94	20.77	20.84
20	1	0	64-QAM	20.88	20.88	20.87
20	1	49		20.69	20.68	20.64
20	1	99		20.66	20.55	20.67
20	50	0		19.71	19.67	19.69
20	50	24		19.65	19.59	19.61
20	50	50		19.58	19.50	19.58
20	100	0		19.67	19.60	19.63
15	1	0	QPSK	22.93	22.79	22.78
15	1	37		22.75	22.58	22.64
15	1	74		22.79	22.60	22.73
15	36	0		21.88	21.73	21.75
15	36	20		21.84	21.69	21.74
15	36	39		21.79	21.61	21.71
15	75	0		21.83	21.69	21.72
15	1	0	16-QAM	22.21	22.12	22.11
15	1	37		22.06	21.98	22.00
15	1	74		22.17	21.92	22.09
15	36	0		20.98	20.81	20.84
15	36	20		20.96	20.76	20.80
15	36	39		20.87	20.70	20.81
15	75	0		20.92	20.78	20.80
15	1	0	64-QAM	20.90	20.87	20.87
15	1	37		20.71	20.71	20.68
15	1	74		20.71	20.60	20.71
15	36	0		19.69	19.68	19.67
15	36	20		19.66	19.59	19.60
15	36	39		19.60	19.55	19.54
15	75	0		19.64	19.57	19.60



LTE Band 66 Maximum Average Power [dBm]						
BW [MHz]	RB Size	RB Offset	Mod	Lowest	Middle	Highest
10	1	0	QPSK	22.87	22.68	22.70
10	1	25		22.75	22.60	22.65
10	1	49		22.74	22.56	22.67
10	25	0		21.85	21.70	21.70
10	25	12		21.86	21.68	21.70
10	25	25		21.78	21.62	21.69
10	50	0		21.84	21.65	21.66
10	1	0	16-QAM	22.11	22.08	22.06
10	1	25		22.14	21.96	21.97
10	1	49		21.99	21.84	22.02
10	25	0		20.94	20.75	20.80
10	25	12		20.93	20.77	20.79
10	25	25		20.92	20.72	20.77
10	50	0		20.96	20.74	20.78
10	1	0	64-QAM	20.80	20.73	20.77
10	1	25		20.72	20.69	20.67
10	1	49		20.67	20.55	20.63
10	25	0		19.66	19.58	19.59
10	25	12		19.64	19.56	19.56
10	25	25		19.59	19.49	19.54
10	50	0		19.66	19.53	19.56
5	1	0	QPSK	22.83	22.65	22.68
5	1	12		22.79	22.61	22.62
5	1	24		22.78	22.63	22.62
5	12	0		21.85	21.68	21.65
5	12	7		21.85	21.65	21.69
5	12	13		21.84	21.63	21.63
5	25	0		21.84	21.61	21.68
5	1	0	16-QAM	22.15	21.92	21.94
5	1	12		22.12	21.98	22.05
5	1	24		22.06	21.91	22.00
5	12	0		20.91	20.77	20.77
5	12	7		20.94	20.74	20.82
5	12	13		20.92	20.73	20.76
5	25	0		20.90	20.71	20.78
5	1	0	64-QAM	20.77	20.67	20.72
5	1	12		20.70	20.64	20.72
5	1	24		20.71	20.61	20.70
5	12	0		19.67	19.56	19.61
5	12	7		19.66	19.58	19.60
5	12	13		19.63	19.54	19.59
5	25	0		19.62	19.52	19.55



LTE Band 66 Maximum Average Power [dBm]						
BW [MHz]	RB Size	RB Offset	Mod	Lowest	Middle	Highest
3	1	0	QPSK	22.79	22.61	22.62
3	1	8		22.78	22.57	22.62
3	1	14		22.78	22.58	22.63
3	8	0		21.82	21.64	21.64
3	8	4		21.86	21.65	21.69
3	8	7		21.82	21.61	21.66
3	15	0		21.80	21.64	21.68
3	1	0	16-QAM	22.04	21.84	21.98
3	1	8		22.17	21.89	21.95
3	1	14		22.00	21.85	21.98
3	8	0		20.98	20.75	20.81
3	8	4		20.95	20.77	20.82
3	8	7		20.94	20.74	20.80
3	15	0		20.88	20.72	20.77
3	1	0	64-QAM	20.70	20.59	20.68
3	1	8		20.70	20.64	20.52
3	1	14		20.67	20.57	20.66
3	8	0		19.62	19.54	19.60
3	8	4		19.64	19.57	19.60
3	8	7		19.61	19.52	19.56
3	15	0		19.59	19.49	19.52
1.4	1	0	QPSK	22.72	22.52	22.54
1.4	1	3		22.77	22.62	22.69
1.4	1	5		22.72	22.49	22.55
1.4	3	0		22.79	22.56	22.59
1.4	3	1		22.77	22.62	22.67
1.4	3	3		22.76	22.57	22.62
1.4	6	0		21.74	21.57	21.58
1.4	1	0	16-QAM	22.03	21.78	21.92
1.4	1	3		22.01	21.78	21.98
1.4	1	5		21.98	21.87	21.84
1.4	3	0		21.78	21.61	21.67
1.4	3	1		21.86	21.59	21.76
1.4	3	3		21.76	21.57	21.73
1.4	6	0		20.90	20.70	20.70
1.4	1	0	64-QAM	20.64	20.53	20.64
1.4	1	3		20.71	20.59	20.69
1.4	1	5		20.61	20.50	20.62
1.4	3	0		20.62	20.51	20.61
1.4	3	1		20.67	20.57	20.65
1.4	3	3		20.63	20.56	20.61
1.4	6	0		19.53	19.43	19.49



LTE Band 2

Peak-to-Average Ratio

Mode	LTE Band 2 / 20MHz				
Mod.	QPSK		16QAM		Limit: 13dB
RB Size	1RB	Full RB	1RB	Full RB	Result
Lowest CH	3.54	4.61	5.04	5.97	PASS
Middle CH	3.54	4.58	4.38	5.91	
Highest CH	3.57	4.55	4.96	5.86	
Mode	LTE Band 2 / 20MHz				
Mod.	64QAM				Limit: 13dB
RB Size	1RB	Full RB			Result
Lowest CH	6.14	6.55			PASS
Middle CH	5.71	6.49			
Highest CH	6.09	6.49			



LTE Band 2 / 20MHz / QPSK

Lowest Channel / 1RB

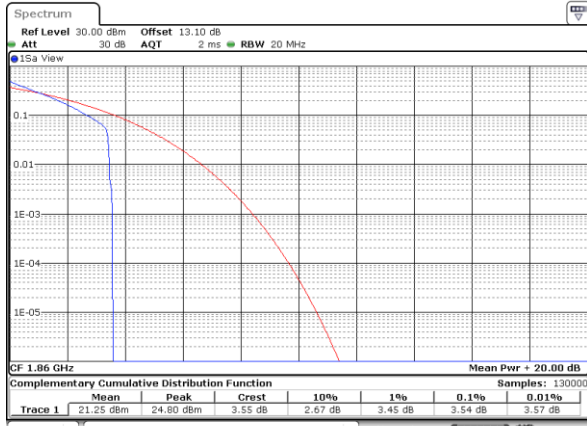

Date: 27 FEB 2018 10:40:48

Lowest Channel / Full RB

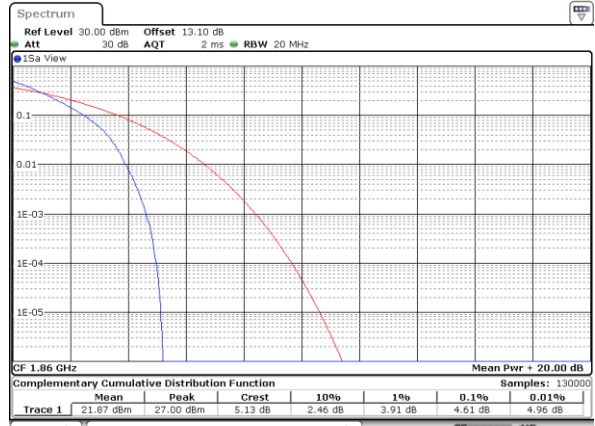

Date: 27 FEB 2018 10:40:59

Middle Channel / 1RB

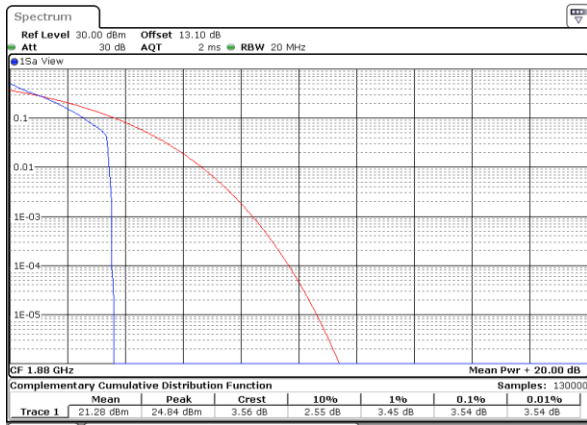

Date: 27 FEB 2018 10:41:08

Middle Channel / Full RB

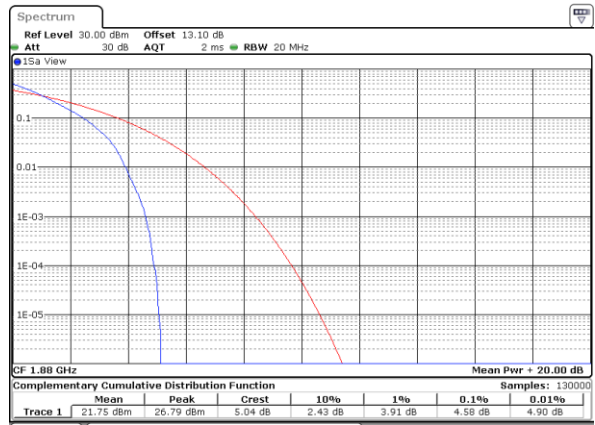

Date: 27 FEB 2018 10:41:18

Highest Channel / 1RB

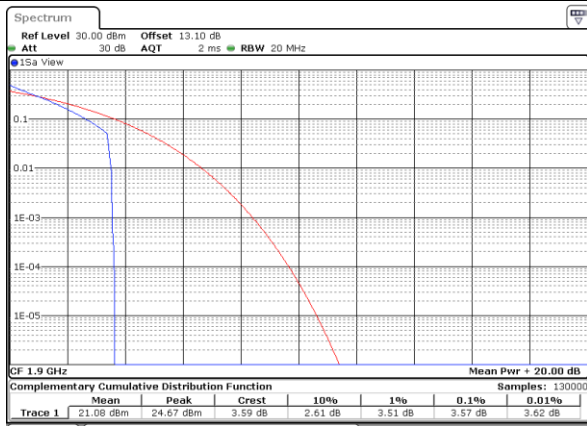

Date: 27 FEB 2018 10:41:28

Highest Channel / Full RB

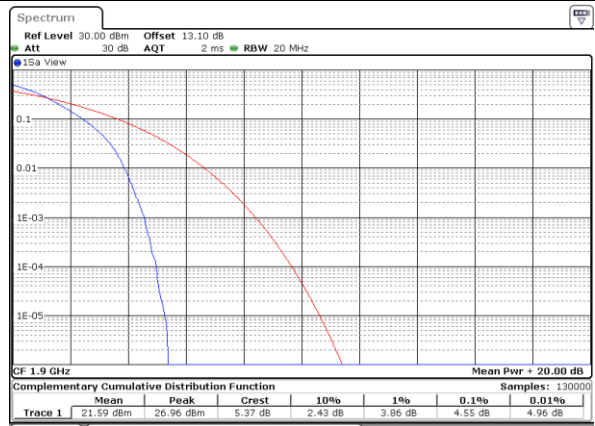

Date: 27 FEB 2018 10:41:38



LTE Band 2 / 20MHz / 16QAM

Lowest Channel / 1RB

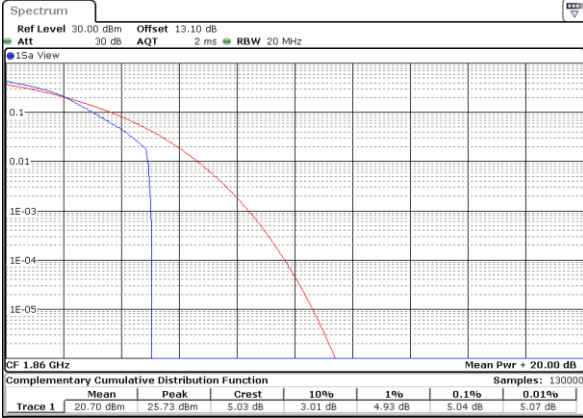

Date: 27 FEB 2018 10:39:27

Lowest Channel / Full RB

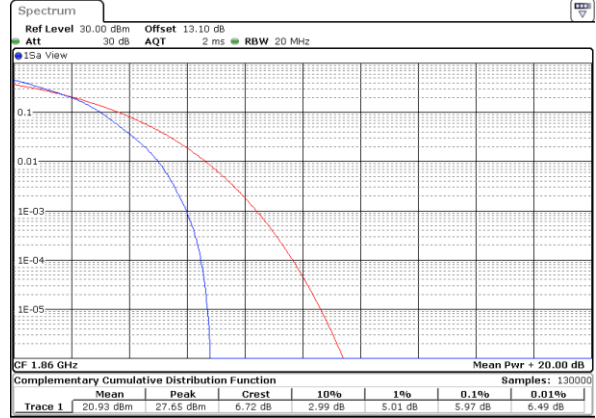

Date: 27 FEB 2018 10:39:37

Middle Channel / 1RB

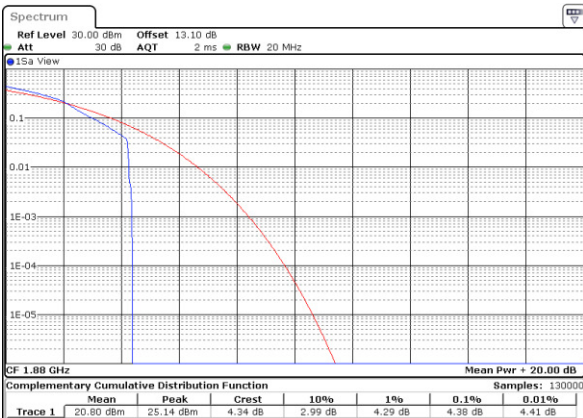

Date: 27 FEB 2018 10:39:46

Middle Channel / Full RB

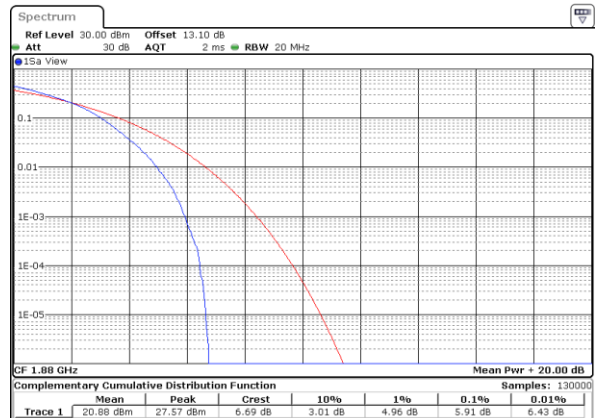

Date: 27 FEB 2018 10:39:56

Highest Channel / 1RB



Date: 27 FEB 2018 10:40:08

Highest Channel / Full RB

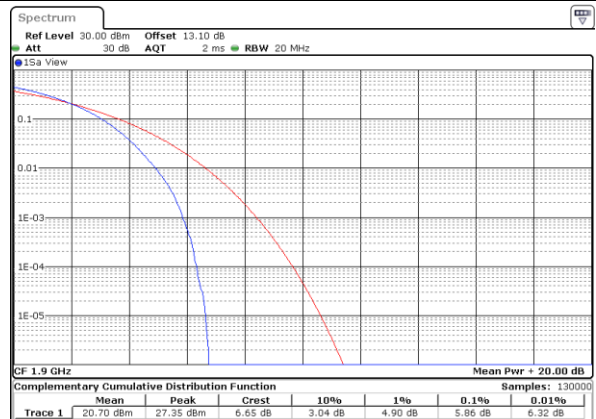

Date: 27 FEB 2018 10:40:38



LTE Band 2 / 20MHz / 64QAM

Lowest Channel / 1RB

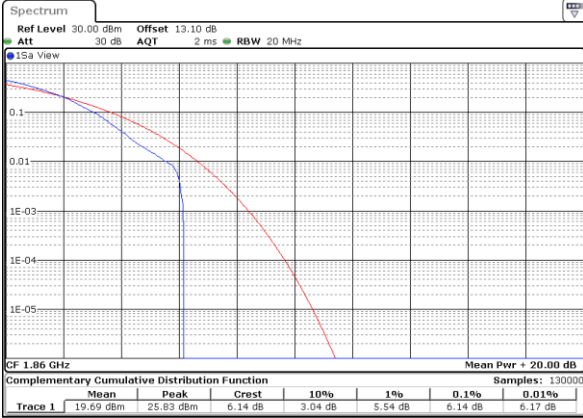

Date: 27 FEB 2018 10:36:40

Lowest Channel / Full RB

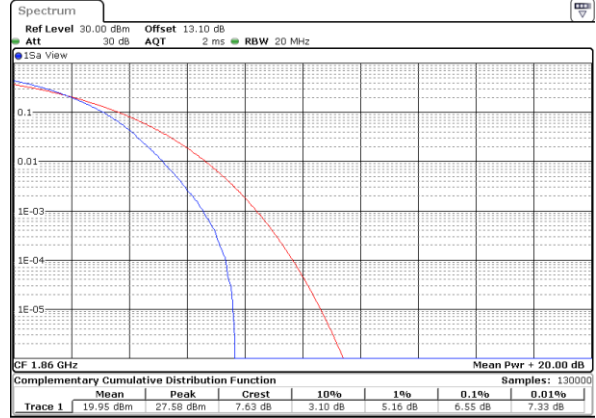

Date: 27 FEB 2018 10:36:50

Middle Channel / 1RB



Date: 27 FEB 2018 10:37:00

Middle Channel / Full RB

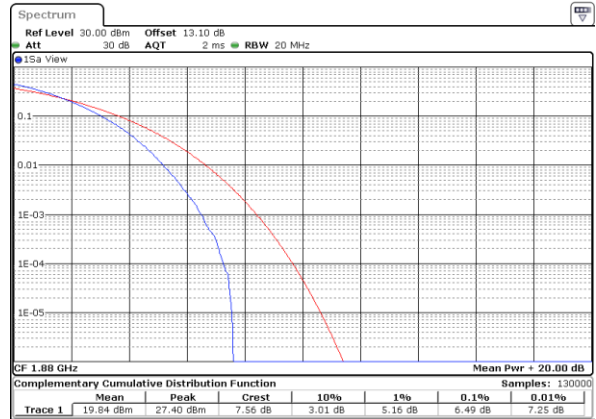

Date: 27 FEB 2018 10:37:11

Highest Channel / 1RB

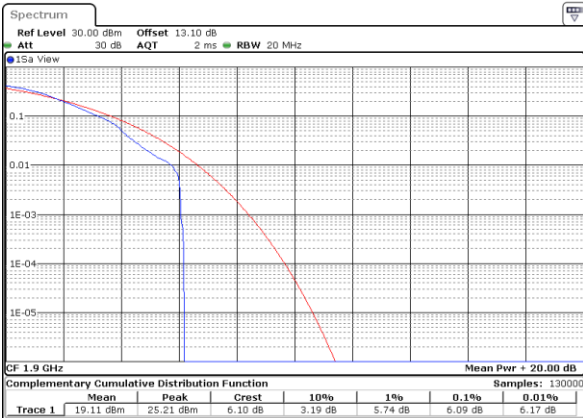

Date: 27 FEB 2018 10:37:21

Highest Channel / Full RB



Date: 27 FEB 2018 10:37:34



26dB Bandwidth

Mode	LTE Band 2 : 26dB BW(MHz)											
BW	1.4MHz		3MHz		5MHz		10MHz		15MHz		20MHz	
Mod.	QPSK	16QAM	QPSK	16QAM	QPSK	16QAM	QPSK	16QAM	QPSK	16QAM	QPSK	16QAM
Lowest CH	1.23	1.22	3.02	3.05	4.90	4.86	9.79	9.83	14.63	14.42	20.18	20.14
Middle CH	1.23	1.21	3.03	3.04	4.89	4.90	9.77	9.85	14.45	14.66	20.22	20.22
Highest CH	1.23	1.23	3.07	3.02	4.94	4.95	9.89	9.69	14.36	14.24	20.18	20.1
Mode	LTE Band 2 : 26dB BW(MHz)											
BW	1.4MHz		3MHz		5MHz		10MHz		15MHz		20MHz	
Mod.	64QAM	-	64QAM	-	64QAM	-	64QAM	-	64QAM	-	64QAM	-
Lowest CH	1.22	-	3.02	-	4.85	-	9.79	-	14.60	-	20.14	-
Middle CH	1.22	-	3.02	-	4.92	-	9.73	-	14.36	-	20.22	-
Highest CH	1.23	-	3.02	-	4.84	-	9.63	-	14.33	-	20.02	-



LTE Band 2

Lowest Channel / 1.4MHz / QPSK

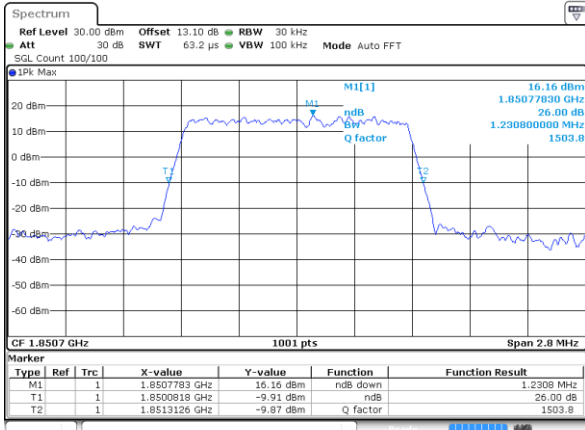

Date: 27 FEB 2018 10:42:26

Lowest Channel / 1.4MHz / 16QAM

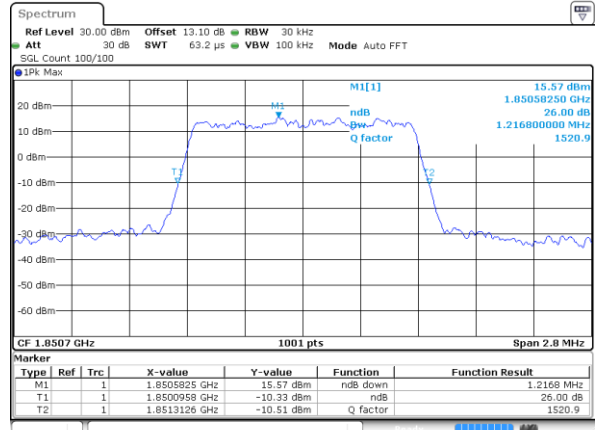

Date: 27 FEB 2018 10:42:36

Middle Channel / 1.4MHz / QPSK

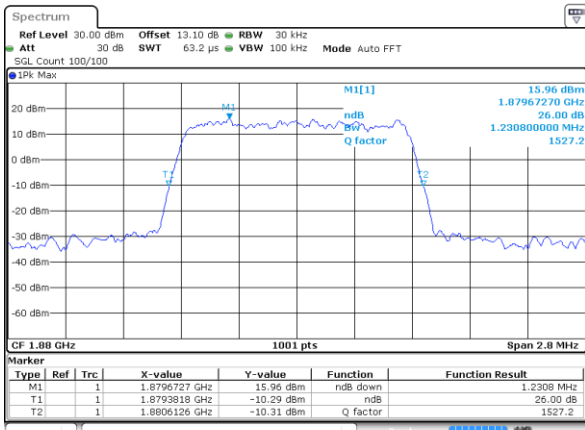

Date: 27 FEB 2018 10:49:22

Middle Channel / 1.4MHz / 16QAM

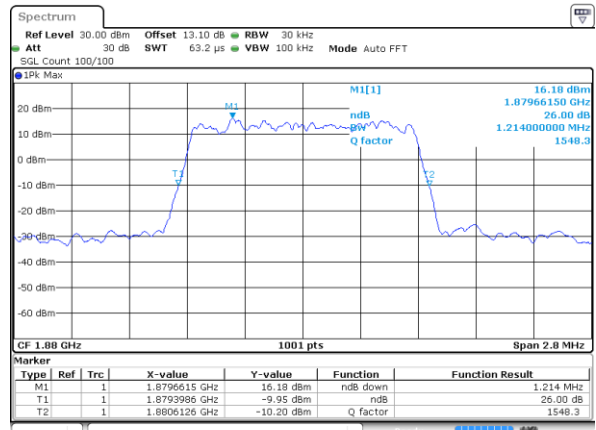

Date: 27 FEB 2018 10:49:32

Highest Channel / 1.4MHz / QPSK

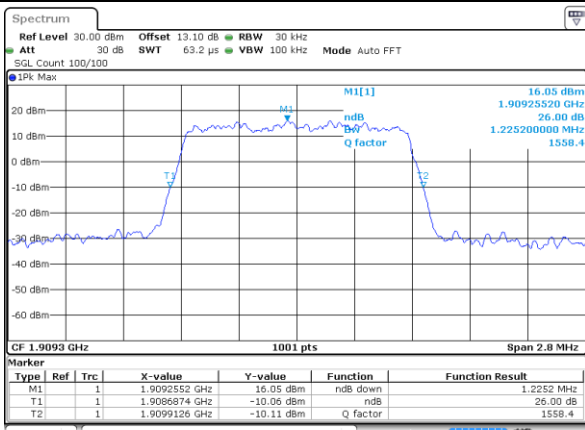

Date: 27 FEB 2018 10:51:49

Highest Channel / 1.4MHz / 16QAM

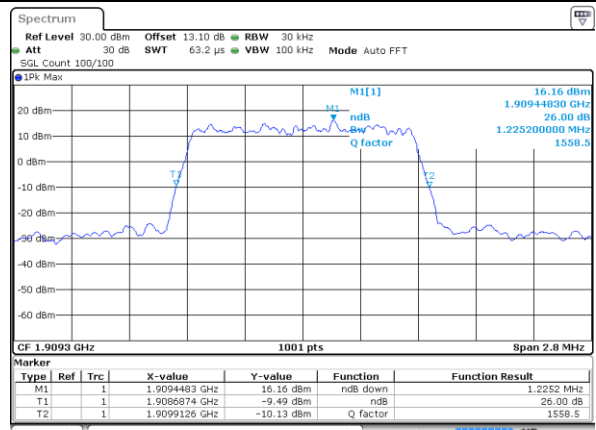

Date: 27 FEB 2018 10:51:59



LTE Band 2

Lowest Channel / 3MHz / QPSK

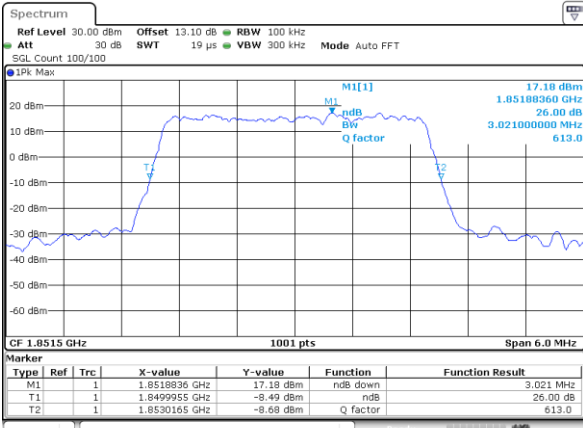

Date: 18.FEB.2018 00:37:01

Lowest Channel / 3MHz / 16QAM

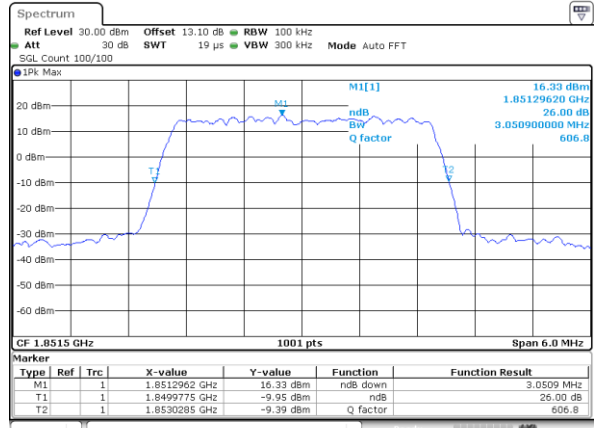

Date: 18.FEB.2018 00:37:12

Middle Channel / 3MHz / QPSK

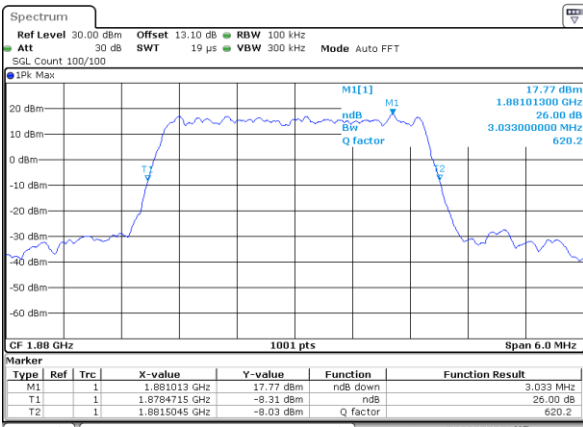

Date: 18.FEB.2018 00:44:17

Middle Channel / 3MHz / 16QAM

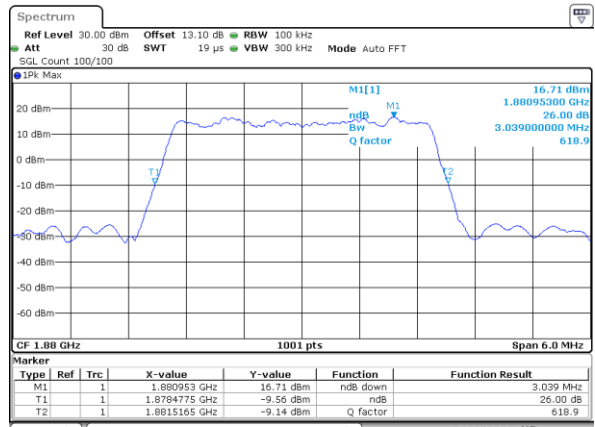

Date: 18.FEB.2018 00:44:28

Highest Channel / 3MHz / QPSK

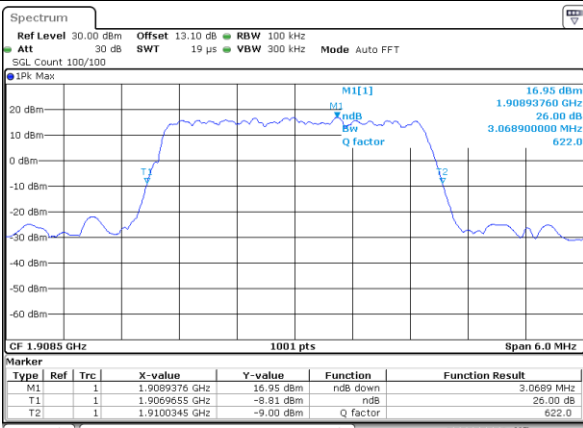

Date: 18.FEB.2018 00:46:58

Highest Channel / 3MHz / 16QAM

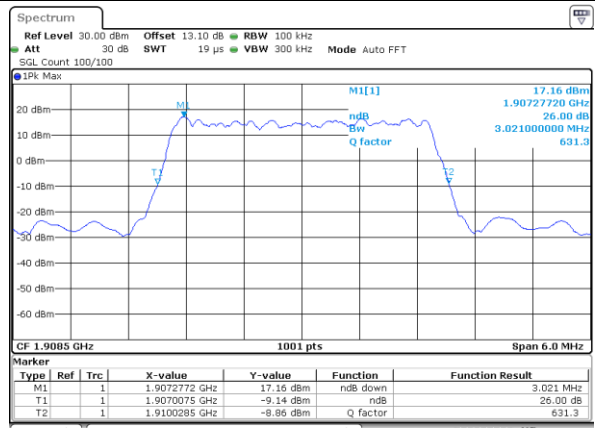

Date: 18.FEB.2018 00:47:10



LTE Band 2

Lowest Channel / 5MHz / QPSK

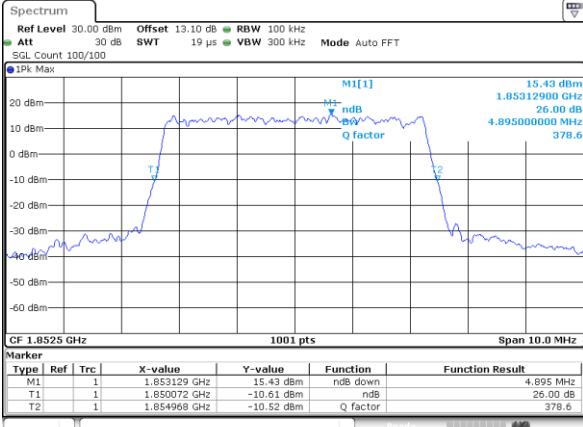

Date: 18.FEB.2018 00:54:15

Lowest Channel / 5MHz / 16QAM

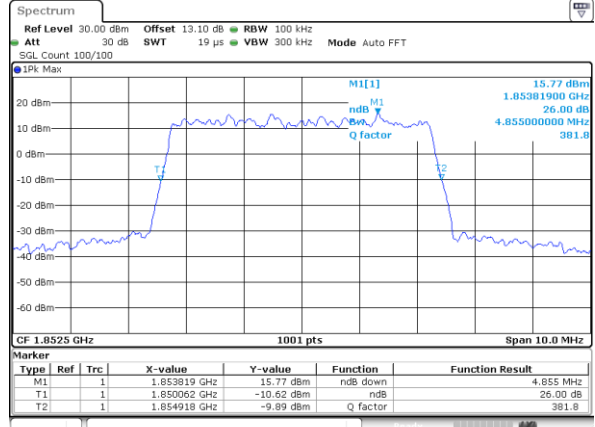

Date: 18.FEB.2018 00:54:26

Middle Channel / 5MHz / QPSK

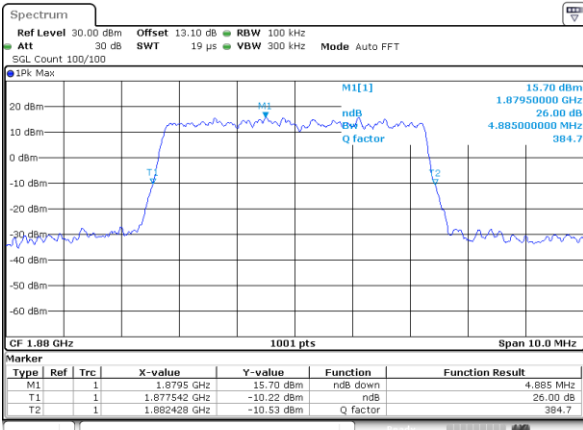

Date: 18.FEB.2018 01:01:30

Middle Channel / 5MHz / 16QAM

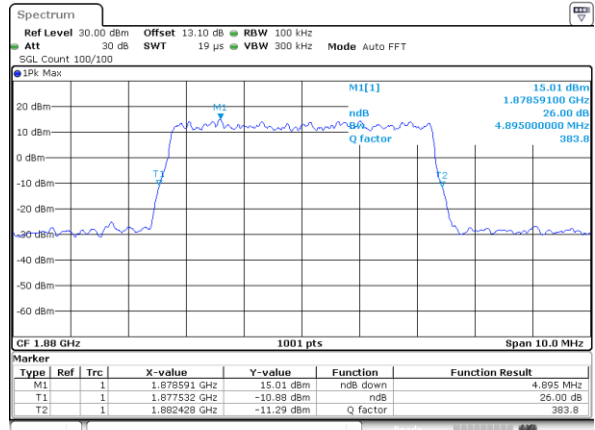

Date: 18.FEB.2018 01:01:41

Highest Channel / 5MHz / QPSK

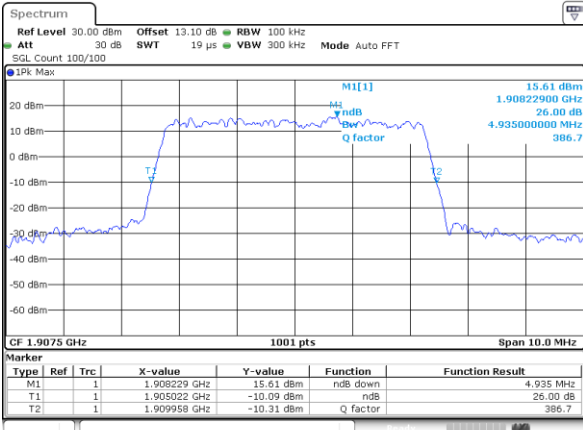

Date: 18.FEB.2018 01:04:11

Highest Channel / 5MHz / 16QAM

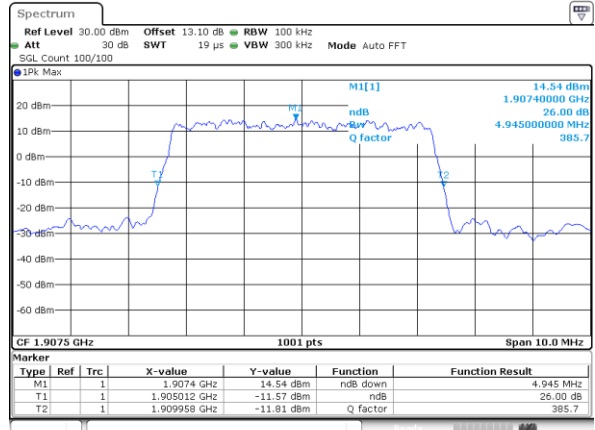

Date: 18.FEB.2018 01:04:22



LTE Band 2

Lowest Channel / 10MHz / QPSK

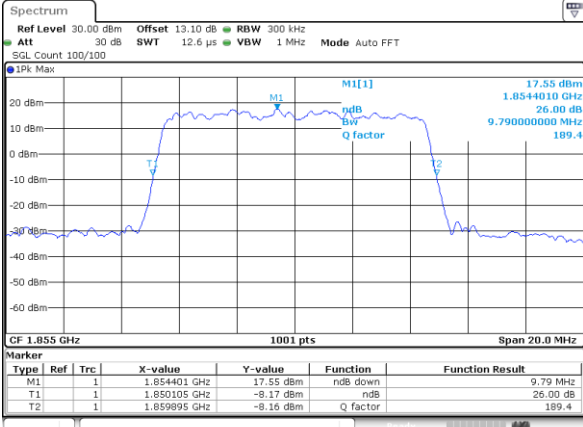

Date: 18.FEB.2018 01:11:27

Lowest Channel / 10MHz / 16QAM

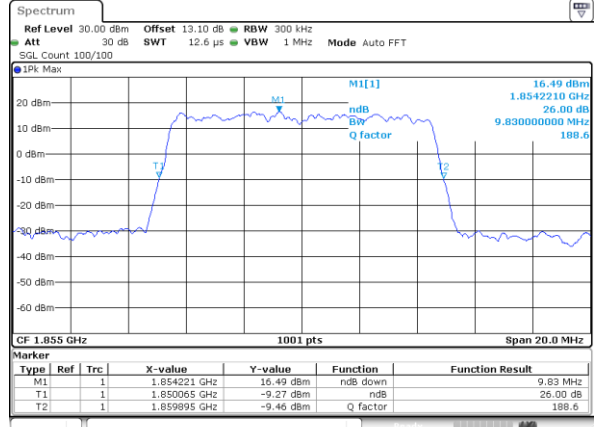

Date: 18.FEB.2018 01:11:38

Middle Channel / 10MHz / QPSK

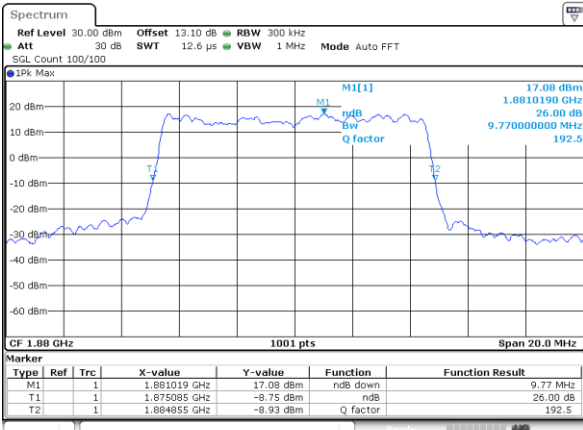

Date: 18.FEB.2018 01:18:42

Middle Channel / 10MHz / 16QAM

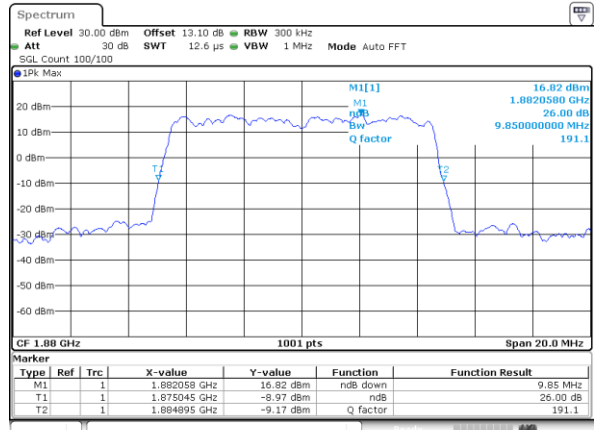

Date: 18.FEB.2018 01:18:53

Highest Channel / 10MHz / QPSK

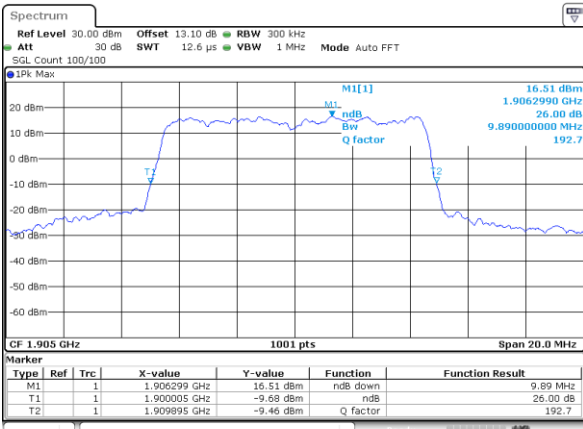

Date: 18.FEB.2018 01:21:23

Highest Channel / 10MHz / 16QAM

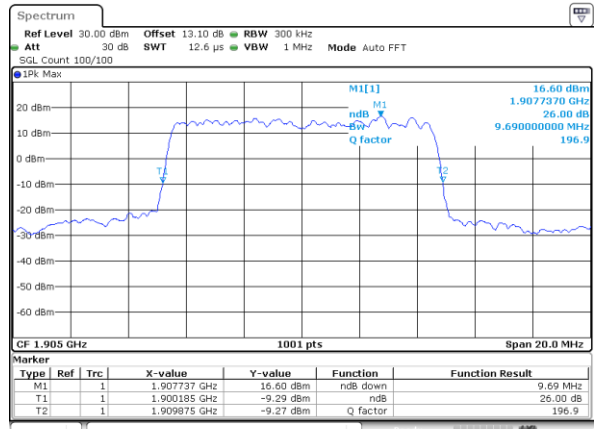

Date: 18.FEB.2018 01:21:34



LTE Band 2

Lowest Channel / 15MHz / QPSK

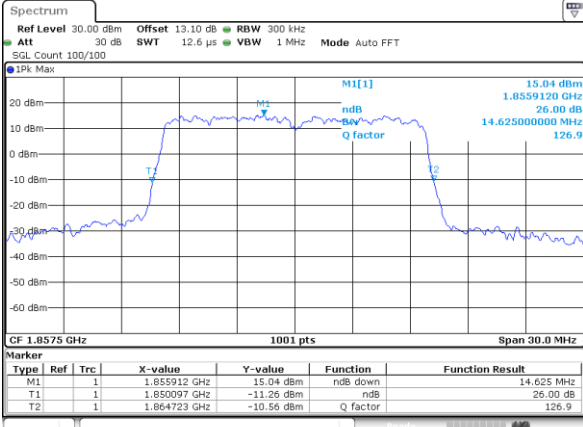

Date: 18.FEB.2018 01:48:54

Lowest Channel / 15MHz / 16QAM

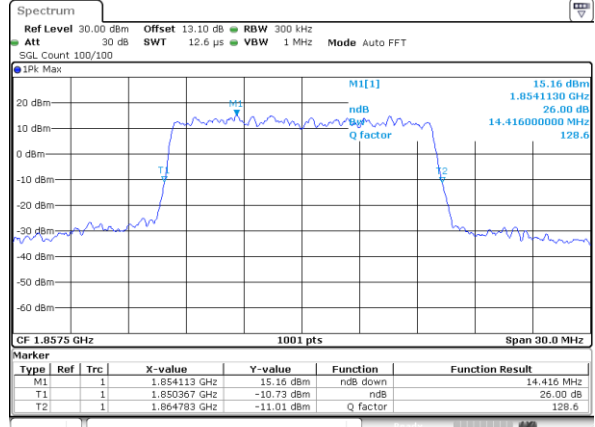

Date: 18.FEB.2018 01:49:05

Middle Channel / 15MHz / QPSK

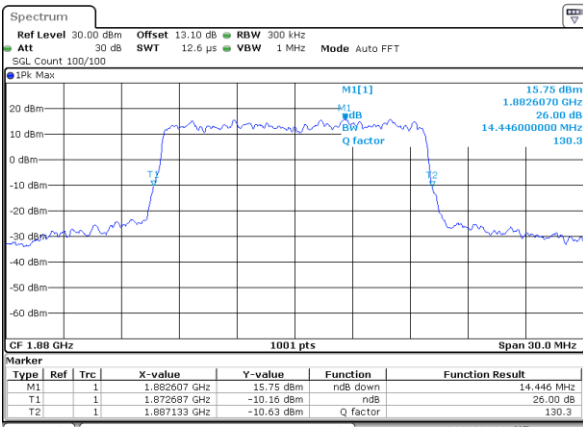

Date: 18.FEB.2018 01:56:10

Middle Channel / 15MHz / 16QAM

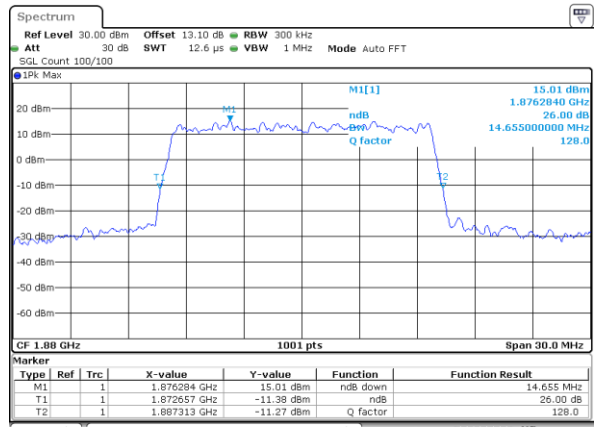

Date: 18.FEB.2018 01:56:21

Highest Channel / 15MHz / QPSK

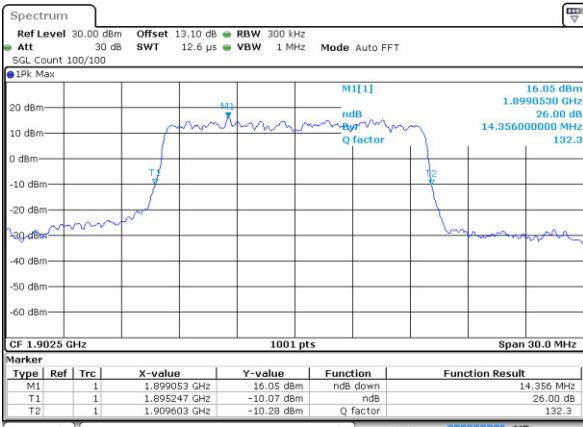

Date: 27.FEB.2018 09:20:20

Highest Channel / 15MHz / 16QAM

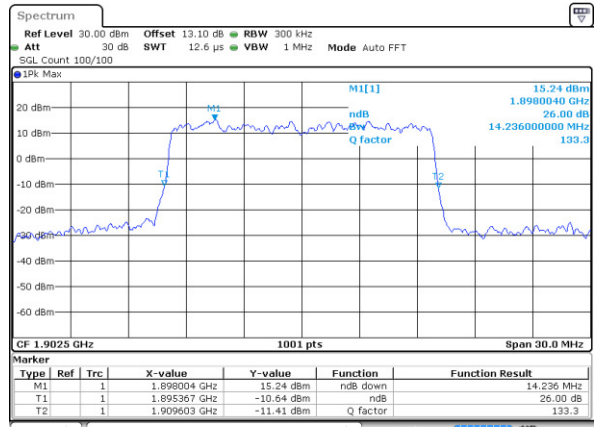

Date: 27.FEB.2018 09:20:30



LTE Band 2

Lowest Channel / 20MHz / QPSK

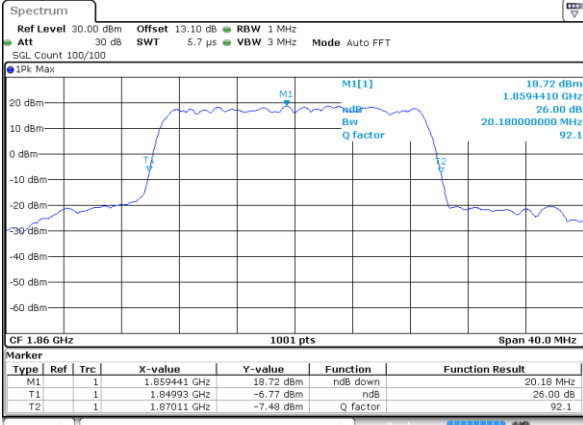

Date: 27 FEB 2018 09:27:16

Lowest Channel / 20MHz / 16QAM

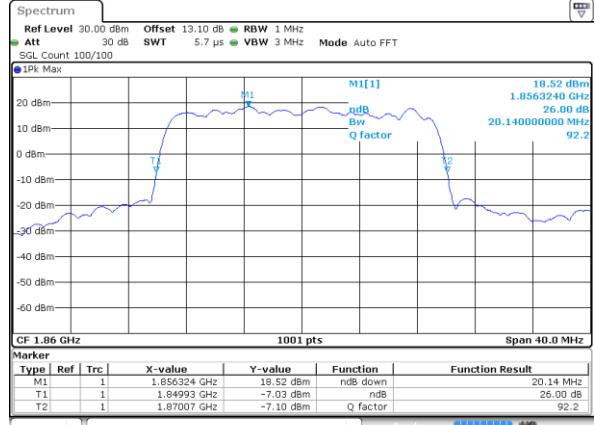

Date: 27 FEB 2018 09:27:25

Middle Channel / 20MHz / QPSK

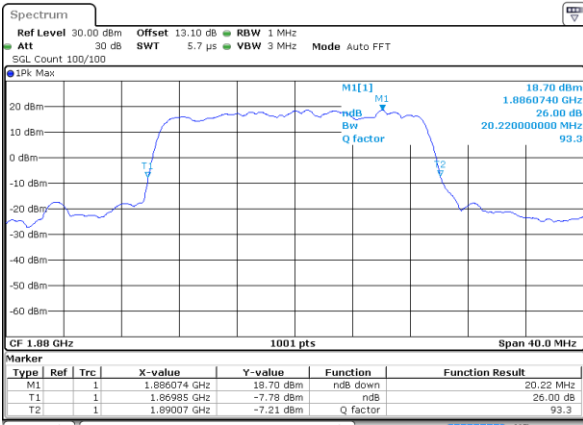

Date: 27 FEB 2018 09:34:11

Middle Channel / 20MHz / 16QAM

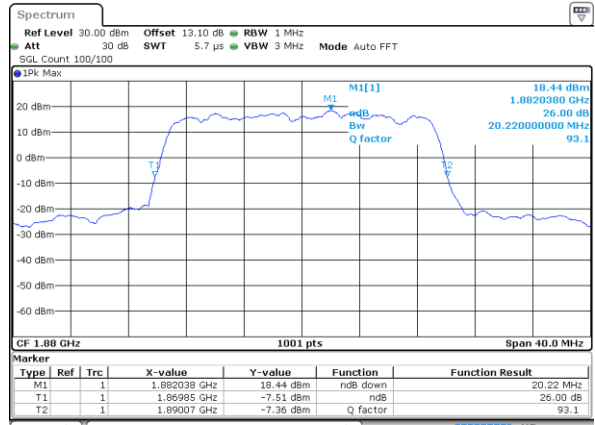

Date: 27 FEB 2018 09:34:21

Highest Channel / 20MHz / QPSK

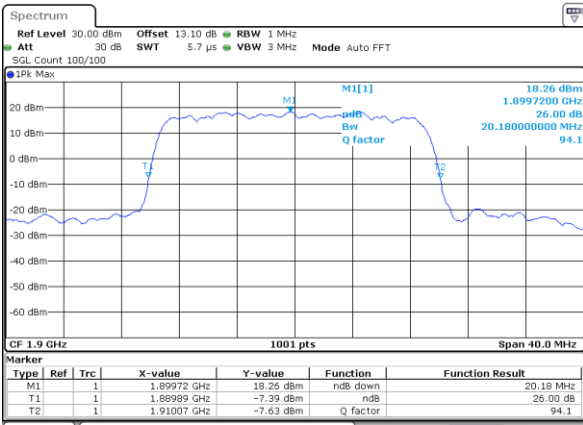

Date: 27 FEB 2018 09:36:38

Highest Channel / 20MHz / 16QAM

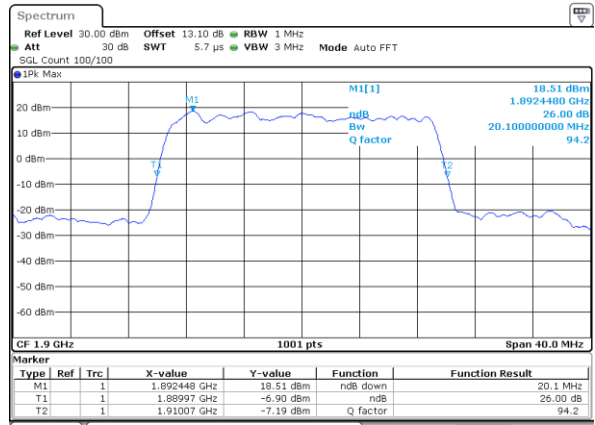

Date: 27 FEB 2018 09:36:48



LTE Band 2

Lowest Channel / 1.4MHz / 64QAM

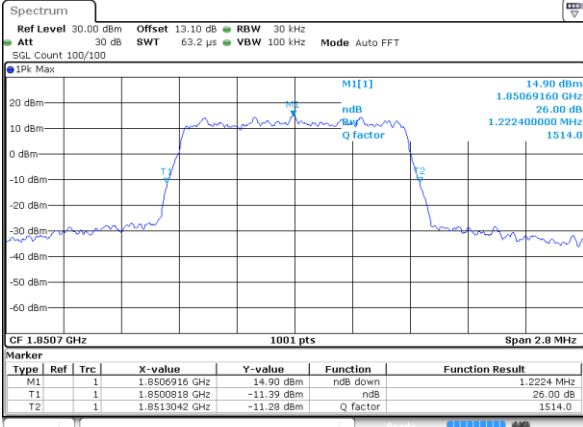

Date: 27 FEB 2018 10:28:25

Lowest Channel / 3MHz / 64QAM

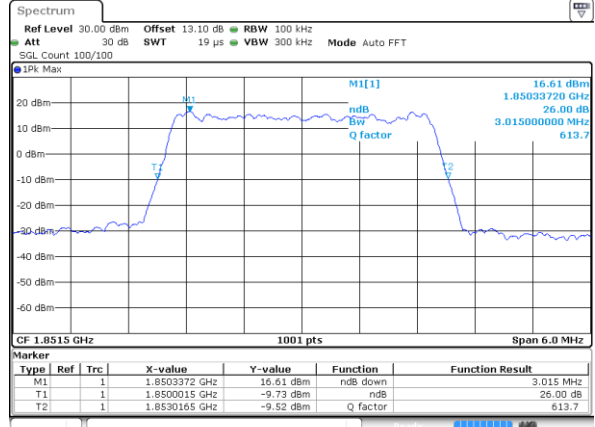

Date: 27 FEB 2018 09:45:55

Middle Channel / 1.4MHz / 64QAM

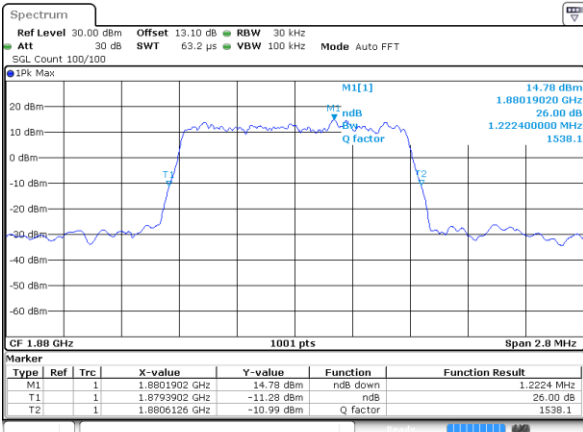

Date: 27 FEB 2018 10:31:53

Middle Channel / 3MHz / 64QAM

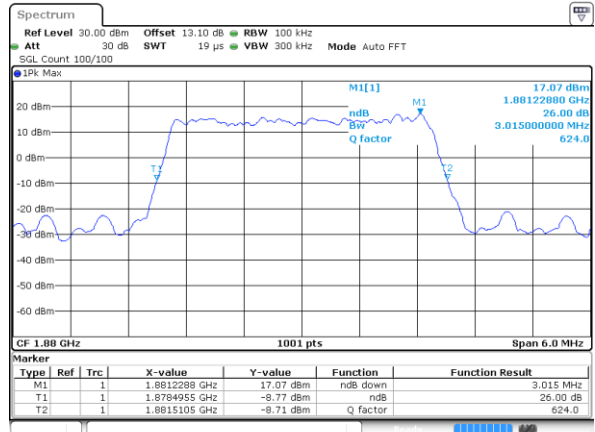

Date: 27 FEB 2018 09:49:23

Highest Channel / 1.4MHz / 64QAM

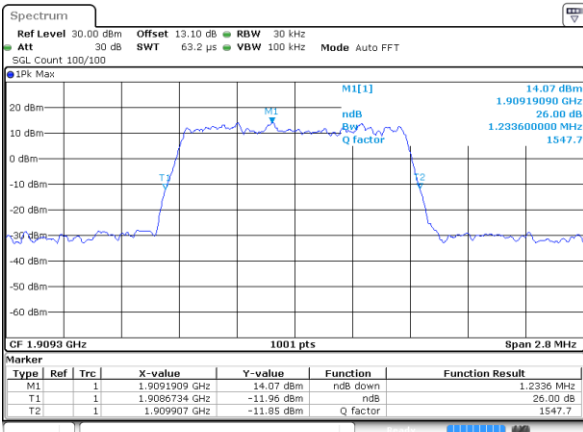

Date: 27 FEB 2018 10:33:07

Highest Channel / 3MHz / 64QAM

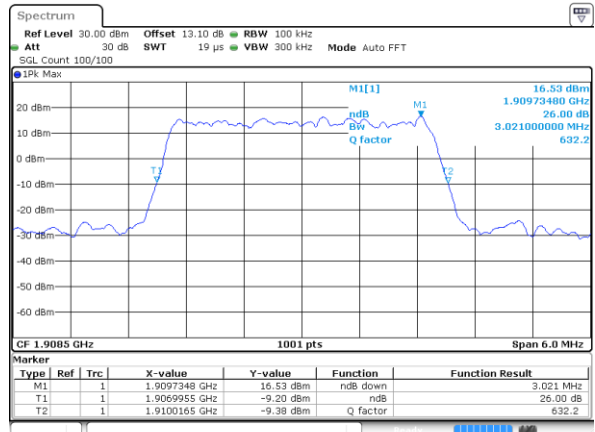

Date: 27 FEB 2018 09:50:36



LTE Band 2

Lowest Channel / 5MHz / 64QAM

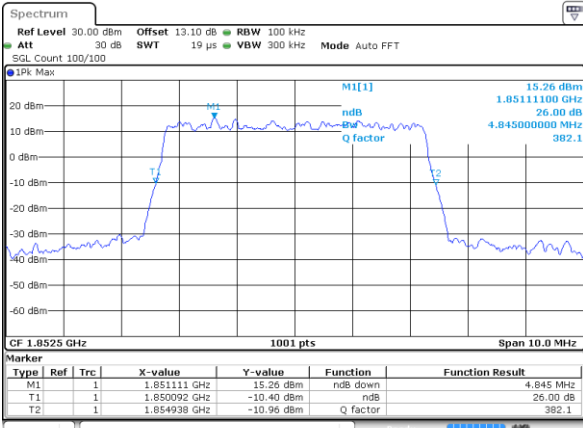

Date: 27 FEB 2018 09:54:04

Lowest Channel / 10MHz / 64QAM

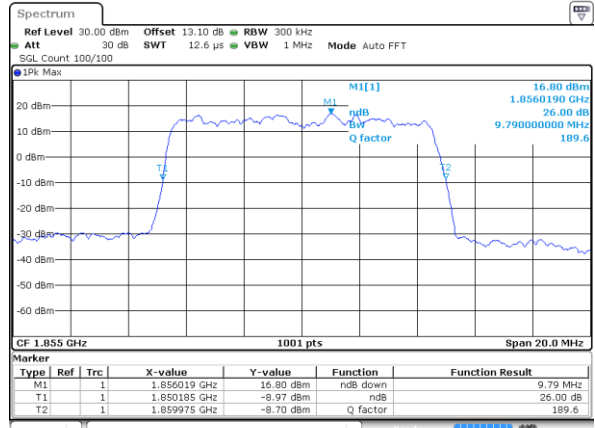

Date: 27 FEB 2018 10:02:13

Middle Channel / 5MHz / 64QAM

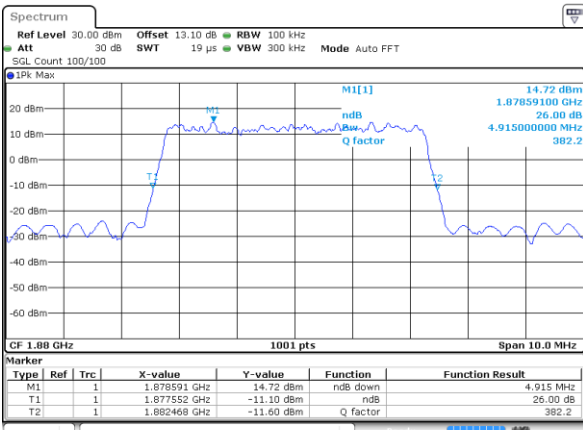

Date: 27 FEB 2018 09:57:32

Middle Channel / 10MHz / 64QAM

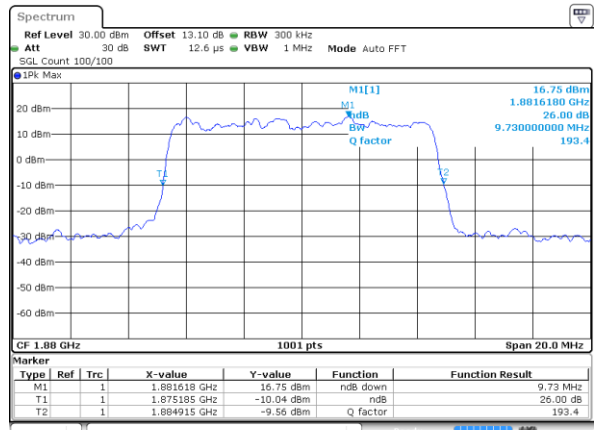

Date: 27 FEB 2018 10:05:41

Highest Channel / 5MHz / 64QAM

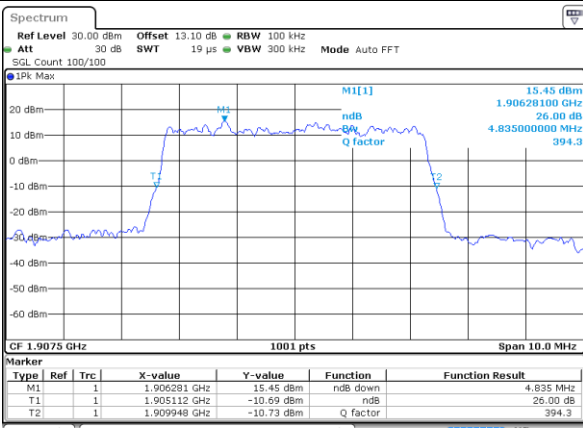

Date: 27 FEB 2018 09:58:45

Highest Channel / 10MHz / 64QAM

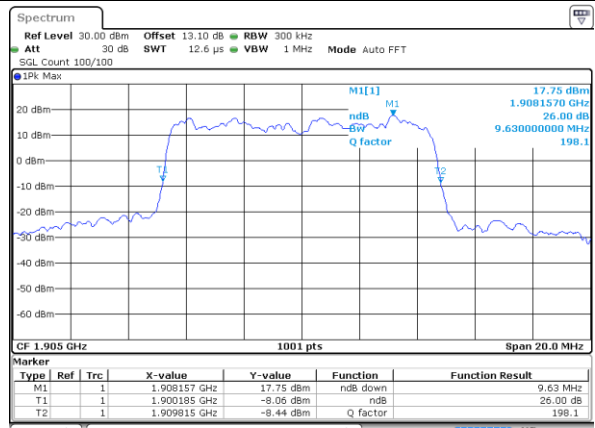

Date: 27 FEB 2018 10:06:54



LTE Band 2

Lowest Channel / 15MHz / 64QAM

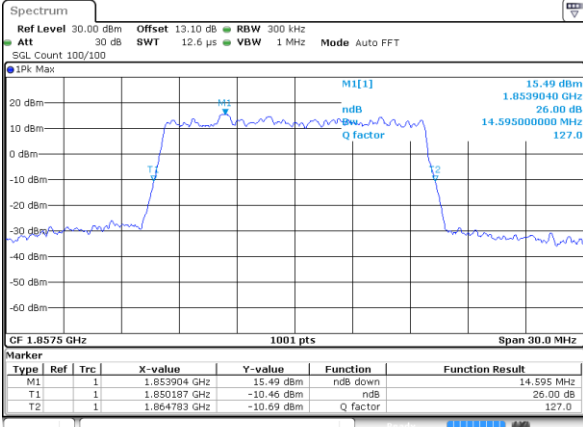

Date: 27 FEB 2018 10:10:22

Lowest Channel / 20MHz / 64QAM

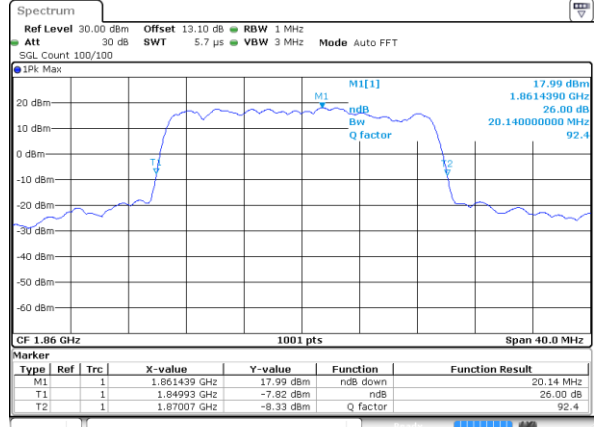

Date: 27 FEB 2018 10:18:31

Middle Channel / 15MHz / 64QAM

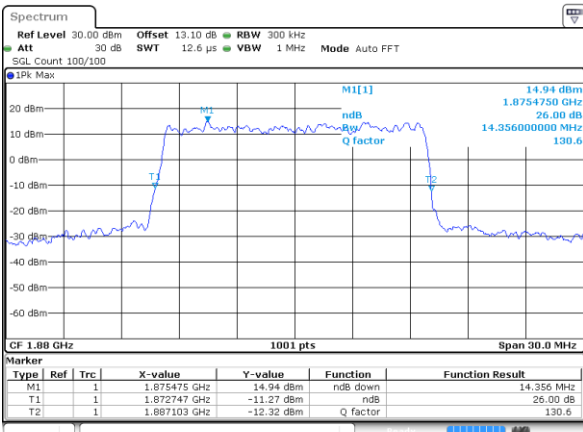

Date: 27 FEB 2018 10:13:50

Middle Channel / 20MHz / 64QAM

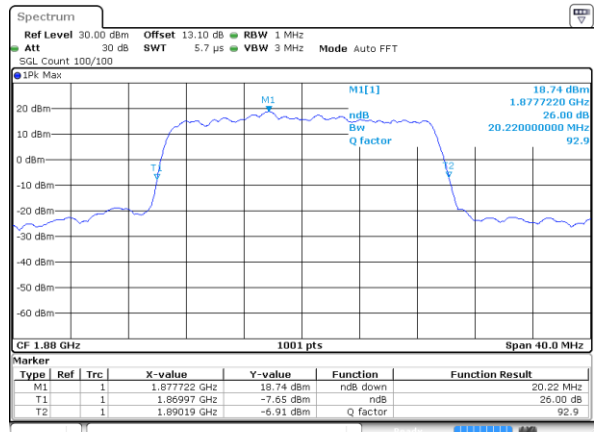

Date: 27 FEB 2018 10:21:59

Highest Channel / 15MHz / 64QAM

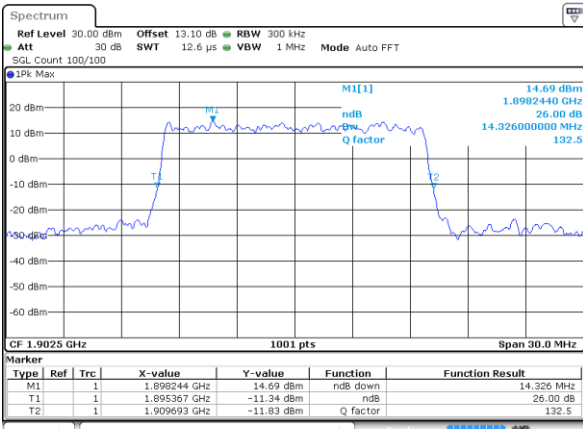

Date: 27 FEB 2018 10:15:03

Highest Channel / 20MHz / 64QAM

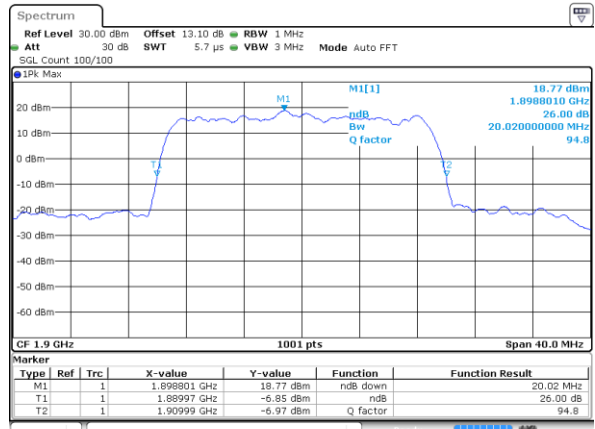

Date: 27 FEB 2018 10:23:12



Occupied Bandwidth

Mode	LTE Band 2 : 99%OBW(MHz)											
BW	1.4MHz		3MHz		5MHz		10MHz		15MHz		20MHz	
Mod.	QPSK	16QAM	QPSK	16QAM	QPSK	16QAM	QPSK	16QAM	QPSK	16QAM	QPSK	16QAM
Lowest CH	1.09	1.09	2.72	2.7	4.48	4.5	9.07	9.03	13.46	13.43	18.18	18.3
Middle CH	1.09	1.09	2.72	2.73	4.51	4.49	9.01	9.01	13.49	13.46	18.26	18.26
Highest CH	1.09	1.09	2.75	2.73	4.48	4.49	9.05	9.03	13.4	13.43	18.58	18.38
Mode	LTE Band 2 : 99%OBW(MHz)											
BW	1.4MHz		3MHz		5MHz		10MHz		15MHz		20MHz	
Mod.	64QAM	-	64QAM	-	64QAM	-	64QAM	-	64QAM	-	64QAM	-
Lowest CH	1.09	-	2.72	-	4.50	-	8.97	-	13.43	-	18.38	-
Middle CH	1.09	-	2.72	-	4.48	-	9.03	-	13.52	-	18.46	-
Highest CH	1.09	-	2.72	-	4.50	-	9.01	-	13.40	-	18.42	-



LTE Band 2

Lowest Channel / 1.4MHz / QPSK

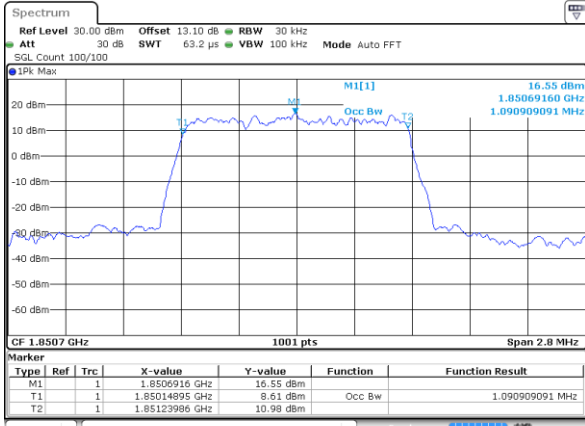

Lowest Channel / 1.4MHz / 16QAM

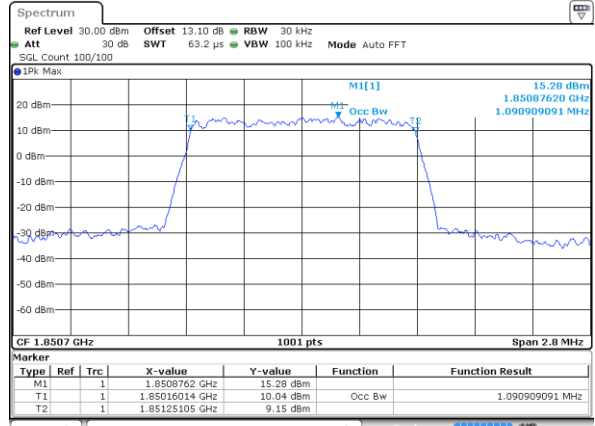

Middle Channel / 1.4MHz / QPSK

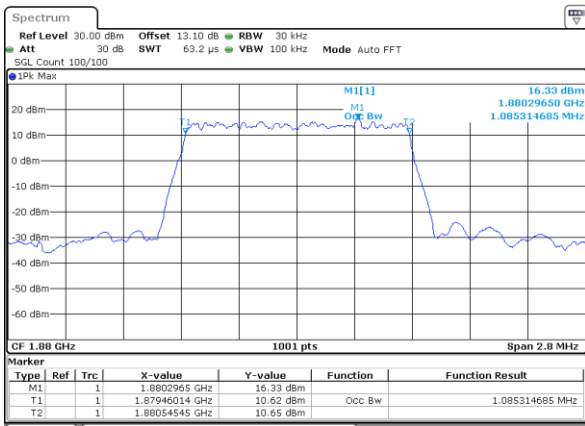

Middle Channel / 1.4MHz / 16QAM

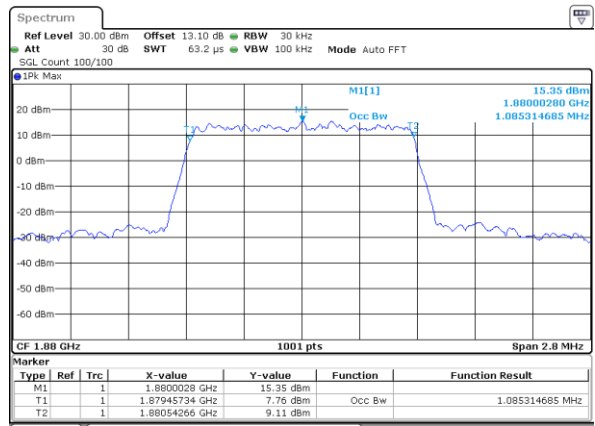

Highest Channel / 1.4MHz / QPSK

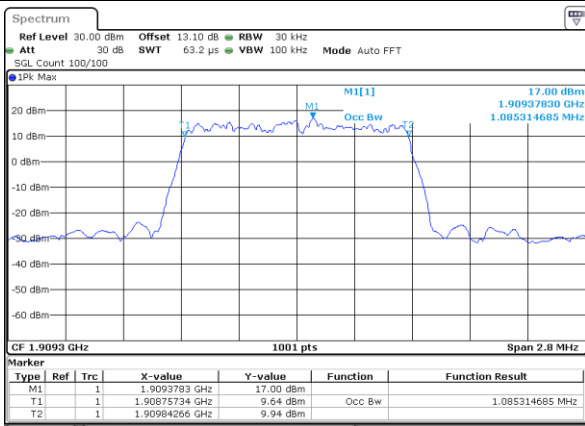

Highest Channel / 1.4MHz / 16QAM

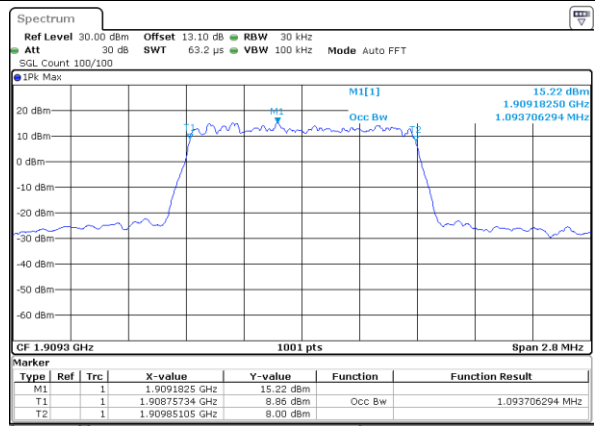



LTE Band 2

Lowest Channel / 3MHz / QPSK

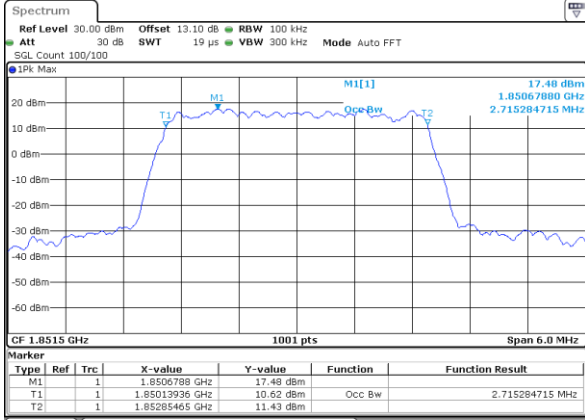

Lowest Channel / 3MHz / 16QAM

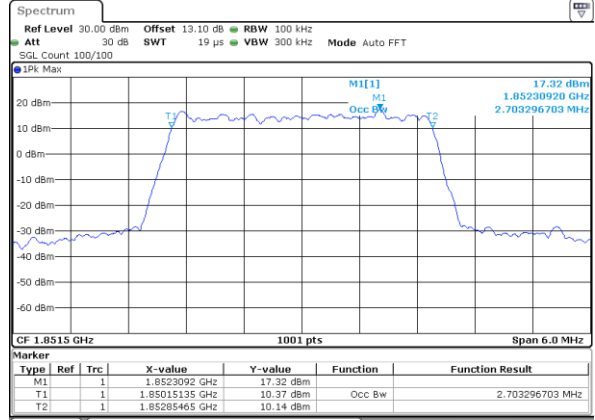

Middle Channel / 3MHz / QPSK

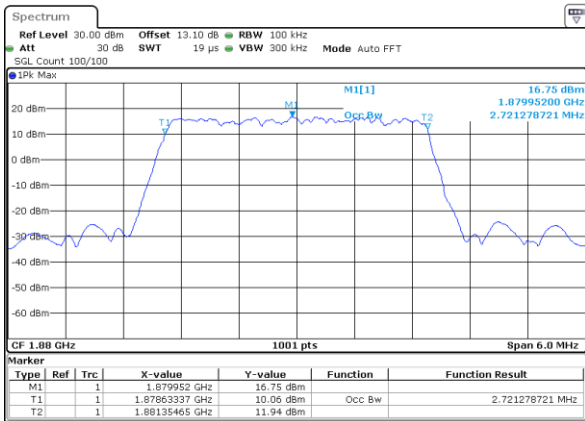

Middle Channel / 3MHz / 16QAM

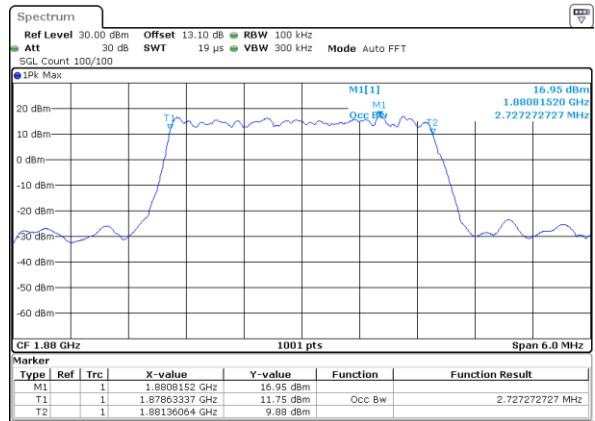

Highest Channel / 3MHz / QPSK

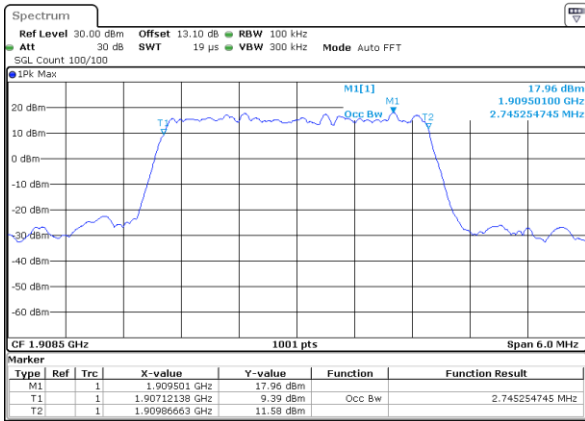

Highest Channel / 3MHz / 16QAM

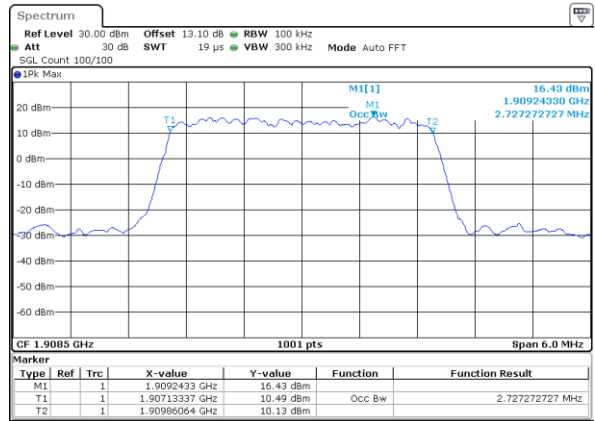



LTE Band 2

Lowest Channel / 5MHz / QPSK

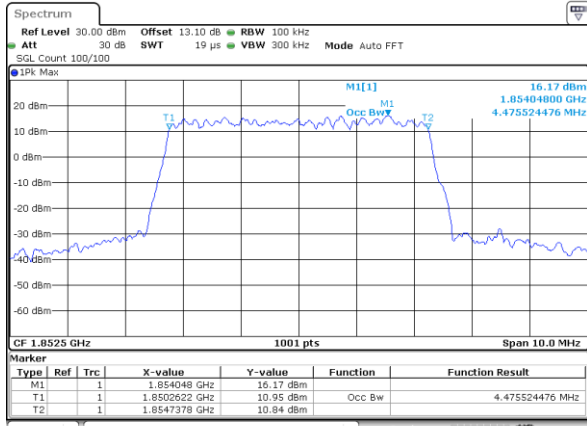

Date: 18.FEB.2018 00:53:52

Lowest Channel / 5MHz / 16QAM

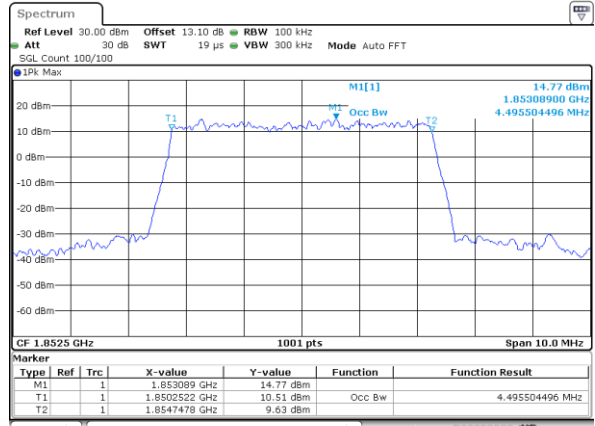

Date: 18.FEB.2018 00:54:03

Middle Channel / 5MHz / QPSK

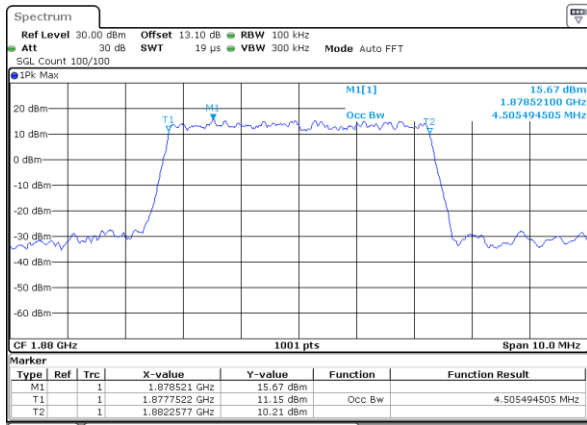

Date: 18.FEB.2018 01:01:07

Middle Channel / 5MHz / 16QAM

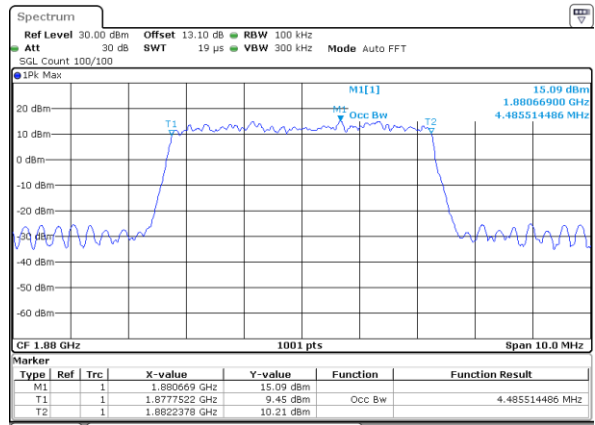

Date: 18.FEB.2018 01:01:19

Highest Channel / 5MHz / QPSK

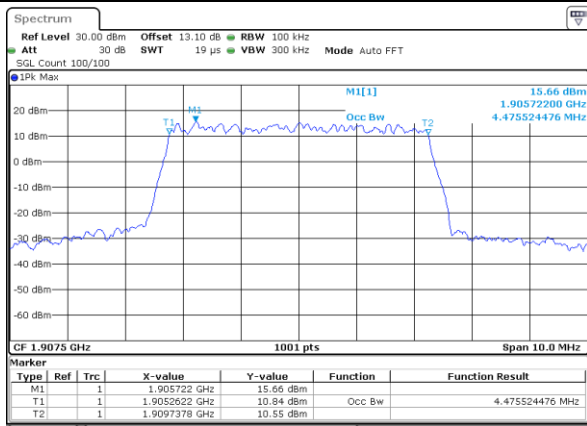

Date: 18.FEB.2018 01:03:49

Highest Channel / 5MHz / 16QAM

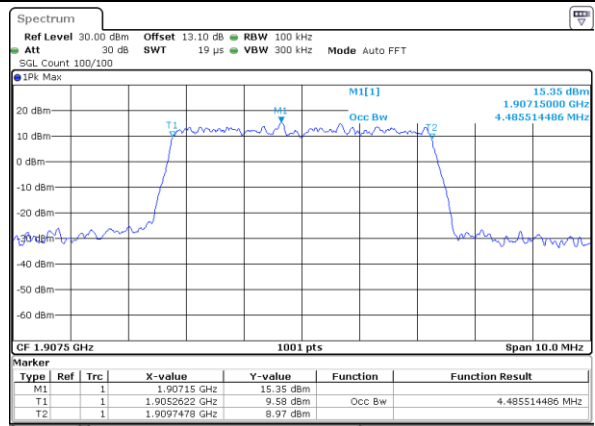

Date: 18.FEB.2018 01:04:00



LTE Band 2

Lowest Channel / 10MHz / QPSK

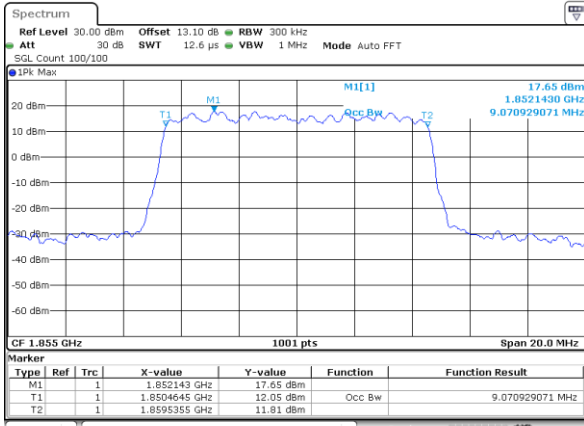

Date: 18.FEB.2018 01:11:04

Lowest Channel / 10MHz / 16QAM

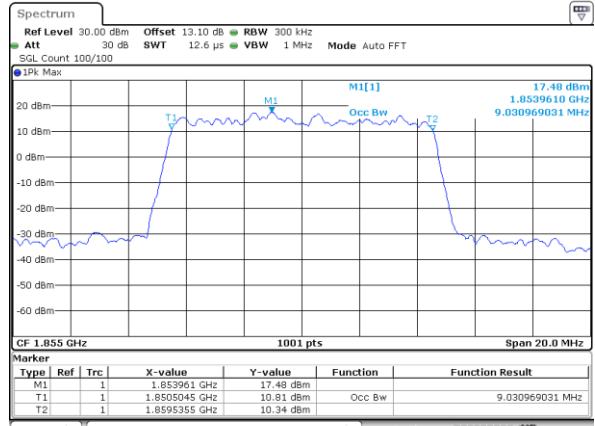

Date: 18.FEB.2018 01:11:16

Middle Channel / 10MHz / QPSK

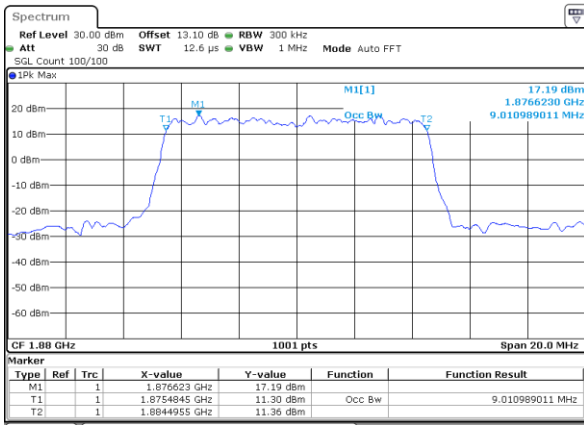

Date: 18.FEB.2018 01:18:19

Middle Channel / 10MHz / 16QAM

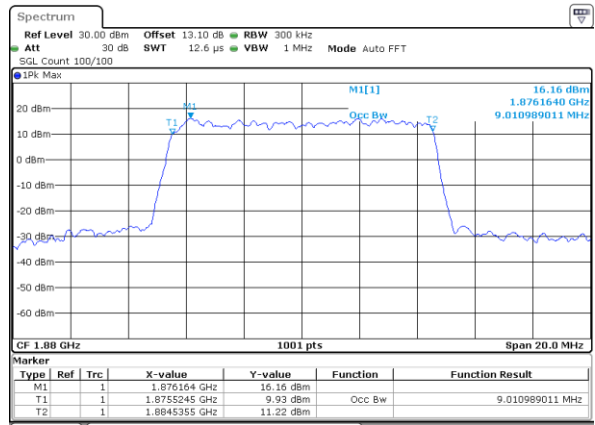

Date: 18.FEB.2018 01:18:31

Highest Channel / 10MHz / QPSK

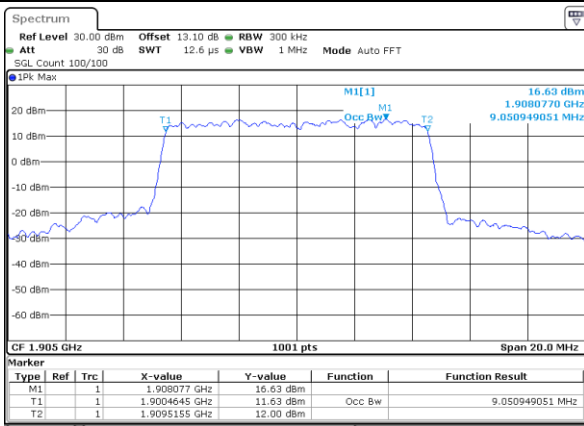

Date: 18.FEB.2018 01:21:00

Highest Channel / 10MHz / 16QAM

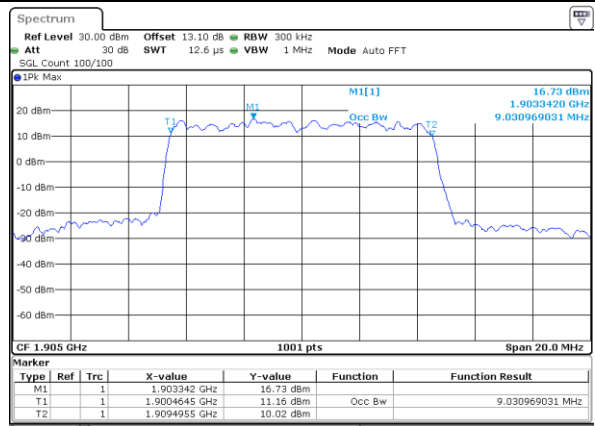

Date: 18.FEB.2018 01:21:12



LTE Band 2

Lowest Channel / 15MHz / QPSK

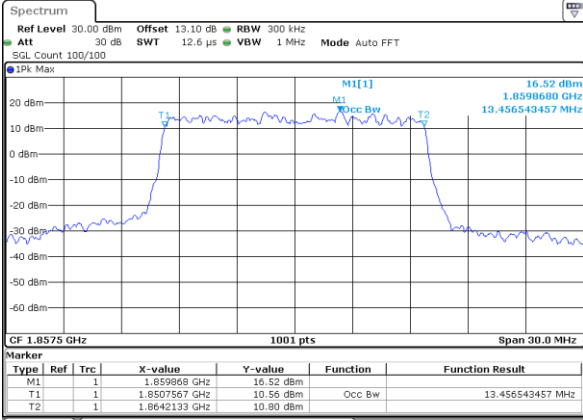

Date: 18.FEB.2018 01:48:31

Lowest Channel / 15MHz / 16QAM

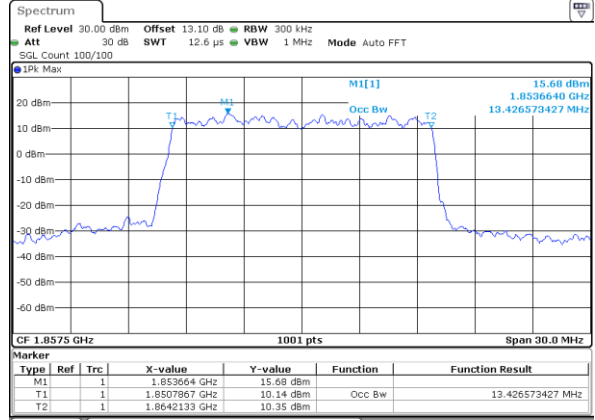

Date: 18.FEB.2018 01:48:42

Middle Channel / 15MHz / QPSK

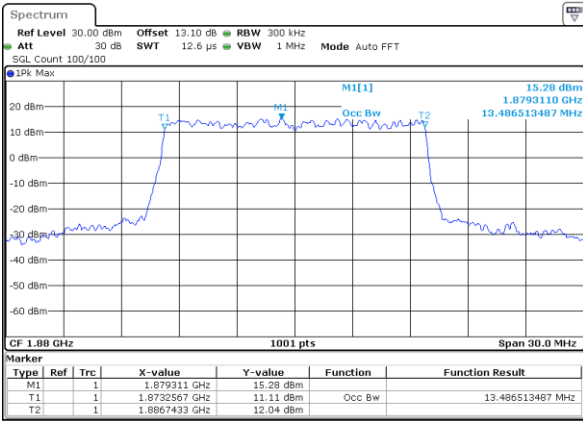

Date: 18.FEB.2018 01:55:47

Middle Channel / 15MHz / 16QAM

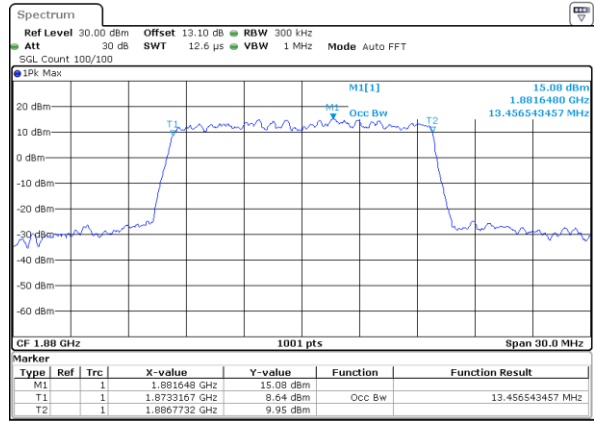

Date: 18.FEB.2018 01:55:58

Highest Channel / 15MHz / QPSK

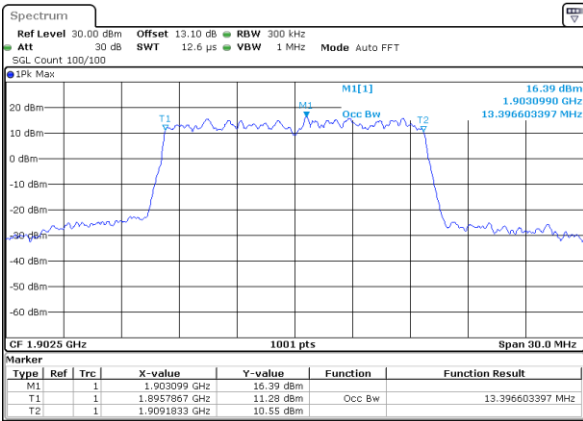

Date: 27.FEB.2018 09:20:00

Highest Channel / 15MHz / 16QAM

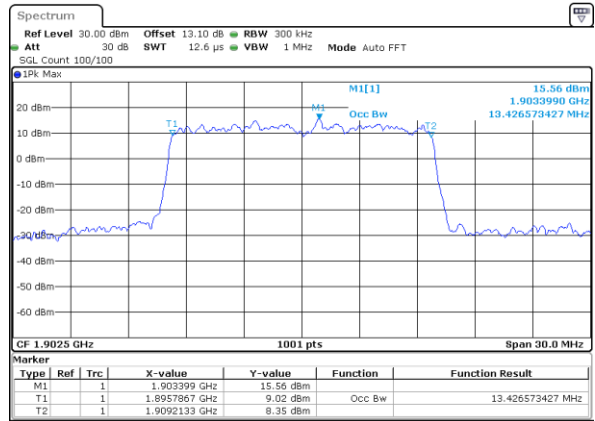

Date: 27.FEB.2018 09:20:10



LTE Band 2

Lowest Channel / 20MHz / QPSK

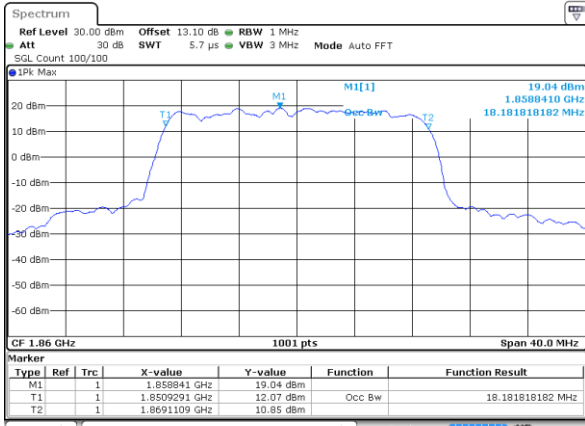

Date: 27 FEB 2018 09:26:56

Lowest Channel / 20MHz / 16QAM

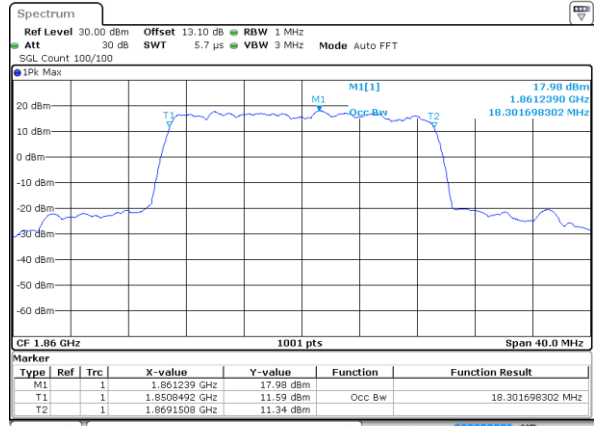

Date: 27 FEB 2018 09:27:06

Middle Channel / 20MHz / QPSK

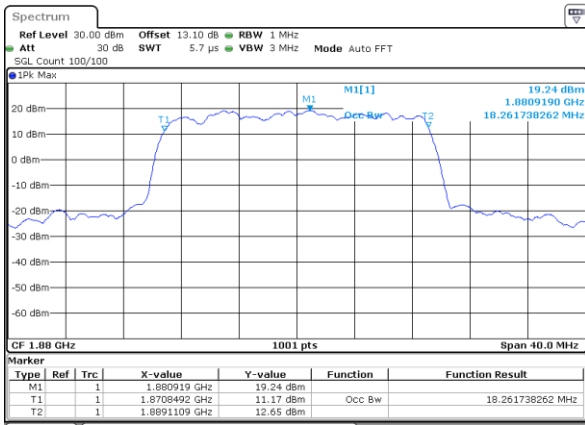

Date: 27 FEB 2018 09:33:52

Middle Channel / 20MHz / 16QAM

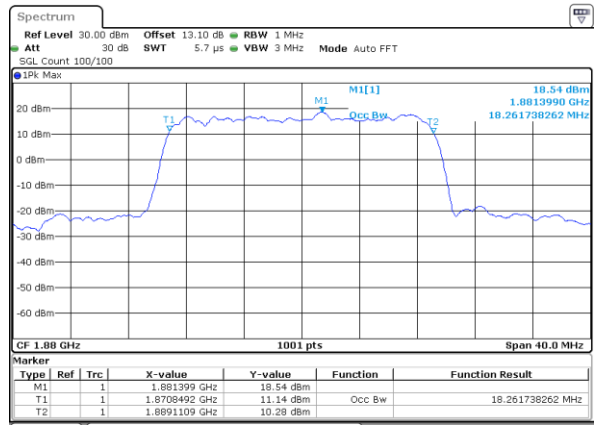

Date: 27 FEB 2018 09:34:01

Highest Channel / 20MHz / QPSK

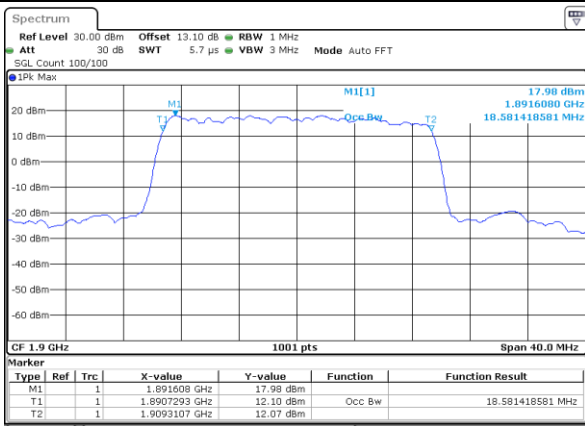

Date: 27 FEB 2018 09:36:18

Highest Channel / 20MHz / 16QAM

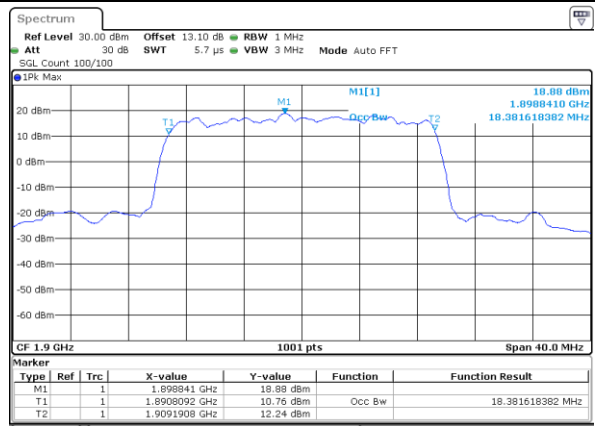

Date: 27 FEB 2018 09:36:28



LTE Band 2

Lowest Channel / 1.4MHz / 64QAM

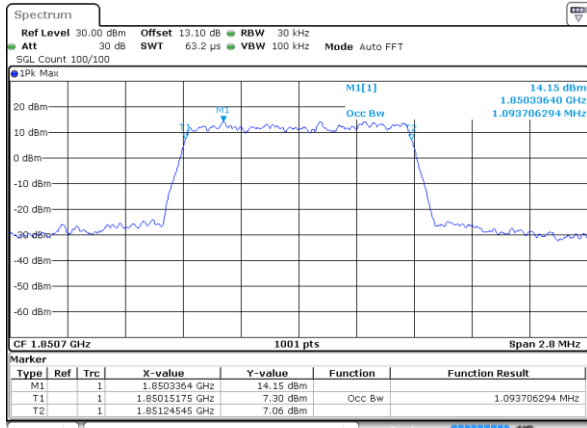

Lowest Channel / 3MHz / 64QAM

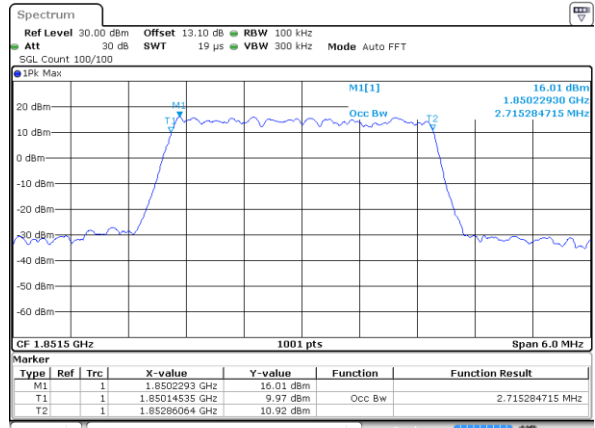

Middle Channel / 1.4MHz / 64QAM

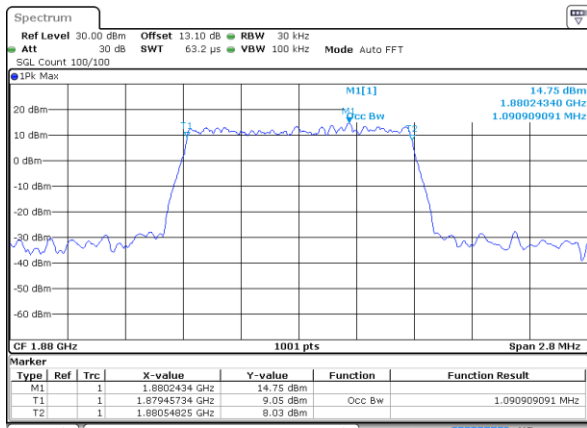

Middle Channel / 3MHz / 64QAM

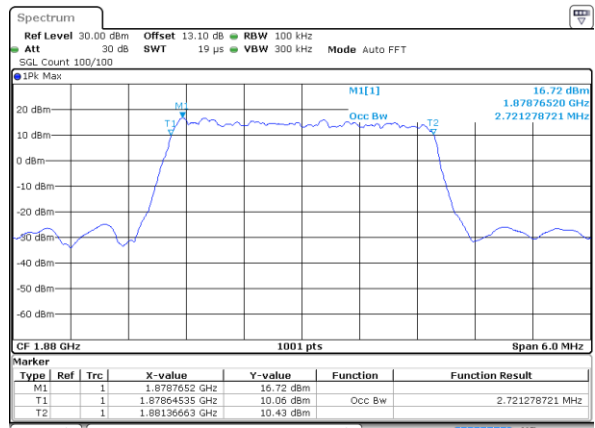

Highest Channel / 1.4MHz / 64QAM

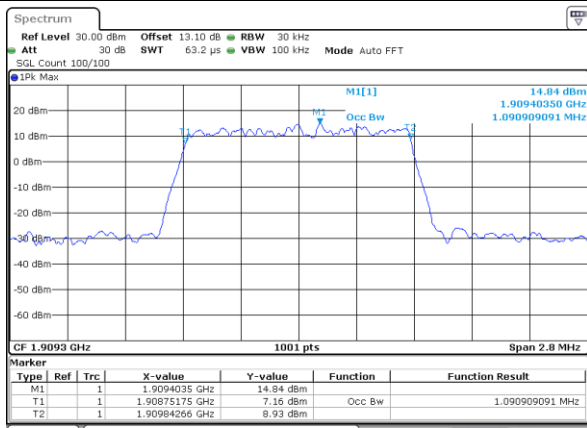

Highest Channel / 3MHz / 64QAM

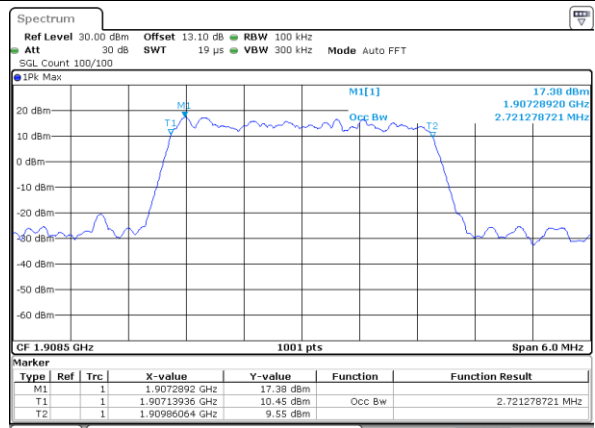



LTE Band 2

Lowest Channel / 5MHz / 64QAM

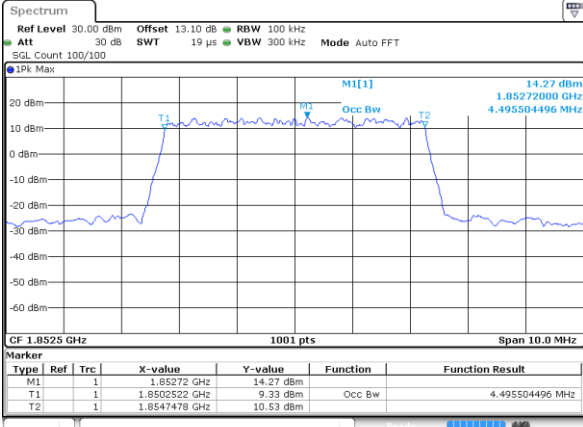

Date: 27 FEB 2018 09:53:54

Lowest Channel / 10MHz / 64QAM

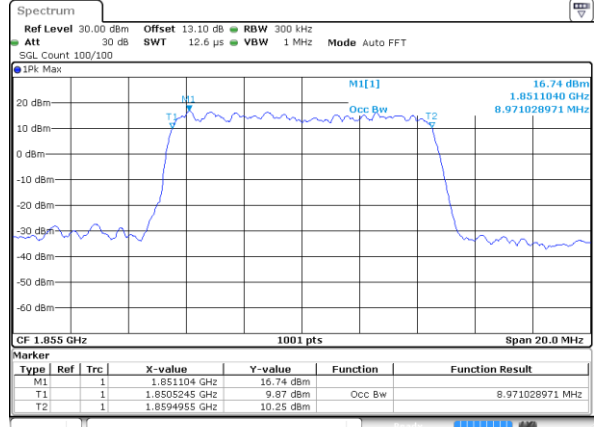

Date: 27 FEB 2018 10:02:03

Middle Channel / 5MHz / 64QAM

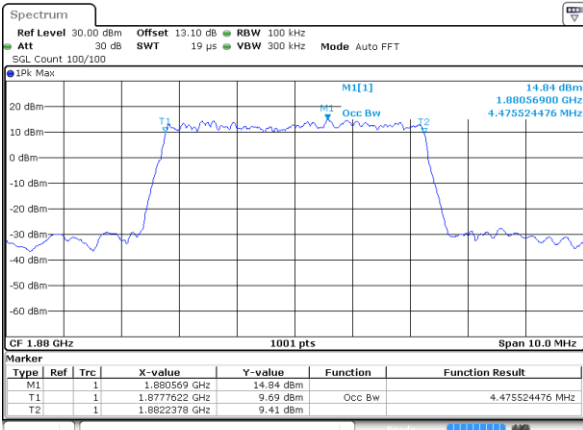

Date: 27 FEB 2018 09:57:22

Middle Channel / 10MHz / 64QAM

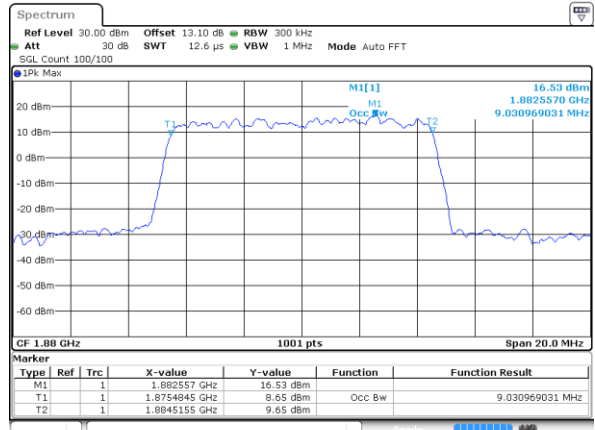

Date: 27 FEB 2018 10:05:31

Highest Channel / 5MHz / 64QAM

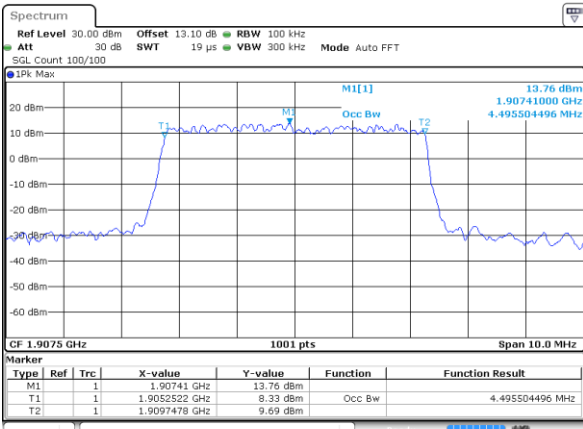

Date: 27 FEB 2018 09:58:35

Highest Channel / 10MHz / 64QAM

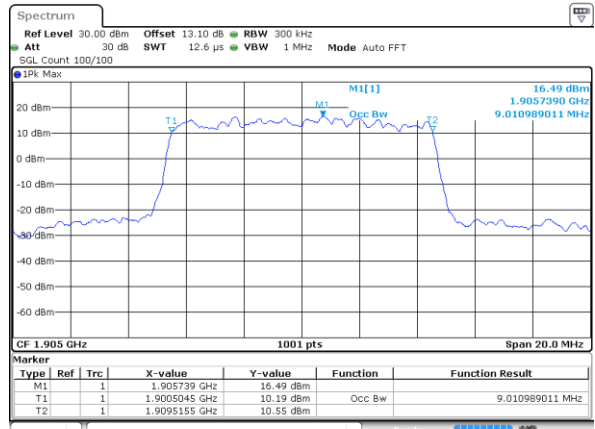

Date: 27 FEB 2018 10:06:44