



FCC RF Test Report

APPLICANT : Motorola Mobility LLC
EQUIPMENT : Mobile Cellular Phone
BRAND NAME : Motorola
MODEL NAME : XT1929-1(SS)
FCC ID : IHDT56XE2
STANDARD : FCC Part 15 Subpart C §15.247
CLASSIFICATION : (DTS) Digital Transmission System

The product was received on Jan. 18, 2018 and testing was completed on Mar. 03, 2018. We, SPORTON INTERNATIONAL INC., would like to declare that the tested sample has been evaluated in accordance with the test procedures and has been in compliance with the applicable technical standards.

The test results in this report apply exclusively to the tested model / sample. Without written approval of SPORTON INTERNATIONAL INC., the test report shall not be reproduced except in full.

Reviewed by: Joseph Lin / Supervisor

Approved by: Jones Tsai / Manager



SPORTON INTERNATIONAL INC.

No. 52, Hwa Ya 1st Rd., Hwa Ya Technology Park, Kwei-Shan District, Tao Yuan City, Taiwan, R.O.C.

SPORTON INTERNATIONAL INC.

TEL : 886-3-327-3456

FAX : 886-3-328-4978

FCC ID: IHDT56XE2

Page Number : 1 of 34

Report Issued Date : Mar. 12, 2018

Report Version : Rev. 01

Report Template No.: BU5-FR15CWLAC MA Version 2.0



TABLE OF CONTENTS

REVISION HISTORY.....3

SUMMARY OF TEST RESULT4

1 GENERAL DESCRIPTION5

 1.1 Applicant5

 1.2 Manufacturer.....5

 1.3 Product Feature of Equipment Under Test.....5

 1.4 Product Specification of Equipment Under Test.....6

 1.5 Modification of EUT6

 1.6 Testing Location7

 1.7 Applicable Standards.....7

2 TEST CONFIGURATION OF EQUIPMENT UNDER TEST8

 2.1 Carrier Frequency and Channel8

 2.2 Test Mode.....8

 2.3 Connection Diagram of Test System.....9

 2.4 Support Unit used in test configuration and system10

 2.5 EUT Operation Test Setup10

 2.6 Measurement Results Explanation Example.....10

3 TEST RESULT.....11

 3.1 6dB and 99% Bandwidth Measurement11

 3.2 Output Power Measurement.....13

 3.3 Power Spectral Density Measurement14

 3.4 Conducted Band Edges and Spurious Emission Measurement16

 3.5 Radiated Band Edges and Spurious Emission Measurement26

 3.6 AC Conducted Emission Measurement.....30

 3.7 Antenna Requirements32

4 LIST OF MEASURING EQUIPMENT33

5 UNCERTAINTY OF EVALUATION34

APPENDIX A. CONDUCTED TEST RESULTS

APPENDIX B. AC CONDUCTED EMISSION TEST RESULT

APPENDIX C. RADIATED SPURIOUS EMISSION

APPENDIX D. RADIATED SPURIOUS EMISSION PLOTS

APPENDIX E. DUTY CYCLE PLOTS



SUMMARY OF TEST RESULT

| Report Section | FCC Rule | Description | Limit | Result | Remark |
|----------------|--------------------|--|--------------------------------|--------|-------------------------------------|
| 3.1 | 15.247(a)(2) | 6dB Bandwidth | $\geq 0.5\text{MHz}$ | Pass | - |
| 3.1 | - | 99% Bandwidth | - | Pass | - |
| 3.2 | 15.247(b) | Power Output Measurement | $\leq 30\text{dBm}$ | Pass | - |
| 3.3 | 15.247(e) | Power Spectral Density | $\leq 8\text{dBm}/3\text{kHz}$ | Pass | - |
| 3.4 | 15.247(d) | Conducted Band Edges | $\leq 20\text{dBc}$ | Pass | - |
| | | Conducted Spurious Emission | | Pass | - |
| 3.5 | 15.247(d) | Radiated Band Edges and Radiated Spurious Emission | 15.209(a) & 15.247(d) | Pass | Under limit 3.11 dB at 7386.000 MHz |
| 3.6 | 15.207 | AC Conducted Emission | 15.207(a) | Pass | Under limit 13.84 dB at 0.263 MHz |
| 3.7 | 15.203 & 15.247(b) | Antenna Requirement | N/A | Pass | - |



1 General Description

1.1 Applicant

Motorola Mobility LLC
222 W,Merchandise Mart Plaza, Chicago IL 60654 USA

1.2 Manufacturer

Motorola Mobility LLC
222 W,Merchandise Mart Plaza, Chicago IL 60654 USA

1.3 Product Feature of Equipment Under Test

| Product Feature | |
|---------------------------------|---|
| Equipment | Mobile Cellular Phone |
| Brand Name | Motorola |
| Model Name | XT1929-1(SS) |
| FCC ID | IHDT56XE2 |
| IMEI Code | Conducted : IMEI: 351885090004200 Conduction : IMEI: 351885090010991 Radiation : IMEI: 351885090010702 |
| EUT supports Radios application | CDMA/EV-DO/GSM/EGPRS/WCDMA/HSPA/LTE/GNSS/NFC WLAN 11b/g/n HT20 WLAN 11a/n HT20/HT40 WLAN 11ac VHT20/VHT40/VHT80 Bluetooth BR/EDR/LE |
| HW Version | DVT2 |
| EUT Stage | Identical Prototype |

Remark: The above EUT's information was declared by manufacturer. Please refer to the specifications or user's manual for more detailed description.



| Accessory List | |
|-----------------|---------------------------------------|
| AC Adapter 1 | Brand Name : Motorola |
| | Model Name : SC-22 SPN5970A |
| | Manufacturer : Salom |
| AC Adapter 2 | Brand Name : Motorola |
| | Model Name : SC-22 SPN5993A |
| | Manufacturer : Chenyang |
| Battery | Brand Name : Motorola |
| | Model Name : JS40 |
| | Manufacturer : SUNWODA |
| C2Audio Cable 1 | Brand Name : Motorola |
| | Model Name : SC18C27844 |
| | Manufacturer : Luxshare |
| C2Audio Cable 2 | Brand Name : Motorola |
| | Model Name : SC18C27845 |
| | Manufacturer : Cabletech |
| USB Cable 1 | Brand Name : Cabletech |
| | Model Name : SKN6473A |
| USB Cable 2 | Brand Name : FOXLINK |
| | Model Name : SKN6473A 17195-C 0403532 |
| USB Cable 3 | Brand Name : SAIBAO |
| | Model Name : SKN6473A 17214-C 1127044 |
| USB Cable 4 | Brand Name : Luxshare |
| | Model Name : SKN6473A 17227-C 1126538 |

1.4 Product Specification of Equipment Under Test

| Standards-related Product Specification | |
|---|---|
| Tx/Rx Channel Frequency Range | 2412 MHz ~ 2462 MHz |
| Maximum (Peak) Output Power to antenna | 802.11b : 21.65 dBm (0.1462 W) 802.11g : 21.76 dBm (0.1500 W) 802.11n HT20 : 21.76 dBm (0.1500 W) |
| Antenna Type / Gain | Loop Antenna with gain -5.0 dBi |
| Type of Modulation | 802.11b : DSSS (DBPSK / DQPSK / CCK) 802.11g/n : OFDM (BPSK / QPSK / 16QAM / 64QAM) |

1.5 Modification of EUT

No modifications are made to the EUT during all test items.



1.6 Testing Location

Sporton Lab is accredited to ISO 17025 by Taiwan Accreditation Foundation (TAF code : 1190) and the FCC designation No. TW1190 and TW0007 under the FCC 2.948(e) by Mutual Recognition Agreement (MRA) in FCC Test.

| | | |
|---------------------------|--|---------|
| Test Site | SPORTON INTERNATIONAL INC. | |
| Test Site Location | No. 52, Hwa Ya 1 st Rd., Hwa Ya Technology Park, Kwei-Shan District, Tao Yuan City, Taiwan, R.O.C. TEL: +886-3-327-3456 FAX: +886-3-328-4978 | |
| Test Site No. | Sporton Site No. | |
| | TH05-HY | CO05-HY |

Note: The test site complies with ANSI C63.4 2014 requirement.

| | | |
|---------------------------|--|--|
| Test Site | SPORTON INTERNATIONAL INC. | |
| Test Site Location | No.58, Aly. 75, Ln. 564, Wenhua 3rd Rd. Guishan Dist, Taoyuan City, Taiwan (R.O.C.) TEL: +886-3-327-3456 FAX: +886-3-328-4978 | |
| Test Site No. | Sporton Site No. | |
| | 03CH12-HY | |

Note: The test site complies with ANSI C63.4 2014 requirement.

1.7 Applicable Standards

According to the specifications of the manufacturer, the EUT must comply with the requirements of the following standards:

- ♦ FCC Part 15 Subpart C §15.247
- ♦ FCC KDB Publication No. 558074 D01 DTS Meas. Guidance v04
- ♦ ANSI C63.10-2013

Remark:

1. All test items were verified and recorded according to the standards and without any deviation during the test.
2. This EUT has also been tested and complied with the requirements of FCC Part 15, Subpart B, recorded in a separate test report.



2 Test Configuration of Equipment Under Test

- a. The EUT has been associated with peripherals and configuration operated in a manner tended to maximize its emission characteristics in a typical application. Frequency range investigated: conduction emission (150 kHz to 30 MHz), radiation emission (9 kHz to the 10th harmonic of the highest fundamental frequency or to 40 GHz, whichever is lower). For radiated measurement, pre-scanned in three orthogonal panels, X, Y, Z. The worst cases (Z plane) were recorded in this report.
- b. AC power line Conducted Emission was tested under maximum output power.

2.1 Carrier Frequency and Channel

| Frequency Band | Channel | Freq. (MHz) | Channel | Freq. (MHz) |
|-----------------|---------|-------------|---------|-------------|
| 2400-2483.5 MHz | 1 | 2412 | 7 | 2442 |
| | 2 | 2417 | 8 | 2447 |
| | 3 | 2422 | 9 | 2452 |
| | 4 | 2427 | 10 | 2457 |
| | 5 | 2432 | 11 | 2462 |
| | 6 | 2437 | | |

2.2 Test Mode

Final test modes are considering the modulation and worse data rates as below table.

| Modulation | Data Rate |
|--------------|-----------|
| 802.11b | 1 Mbps |
| 802.11g | 6 Mbps |
| 802.11n HT20 | MCS0 |

| Test Cases | |
|--|--|
| AC Conducted Emission | Mode 1 :GSM850 Idle + Bluetooth Link + WLAN (2.4GHz) Link + MP3 + Battery + USB Cable 1 Type C (Charging from Adapter 1) |
| Remark: For Radiated Test Cases, The tests were performance with Adapter 1, and USB Cable 1 Type C. | |

2.3 Connection Diagram of Test System

<EUT with Adapter>

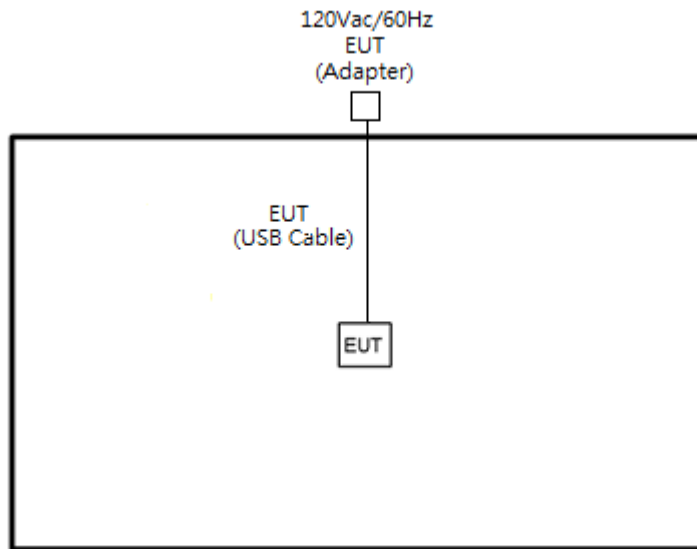

<AC Conducted Emission Mode>

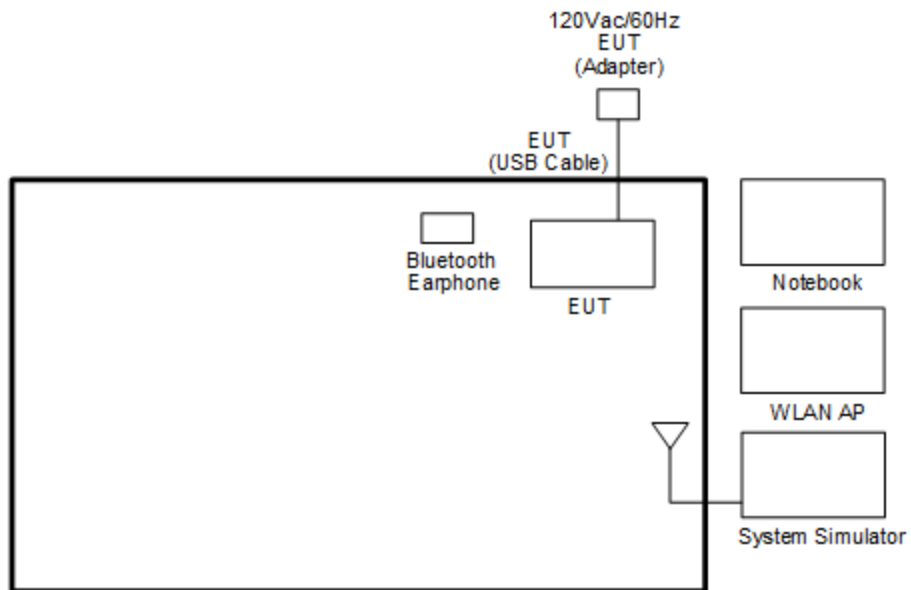

2.4 Support Unit used in test configuration and system

| Item | Equipment | Trade Name | Model Name | FCC ID | Data Cable | Power Cord |
|------|--------------------|------------|----------------|--|------------|--|
| 1. | System Simulator | Anritsu | MT8820C | N/A | N/A | Unshielded, 1.8 m |
| 2. | WLAN AP | ASUS | RT-AC66U | KA2DIR628A2 | N/A | Unshielded, 1.8 m |
| 3. | Notebook | DELL | Latitude E6320 | FCC DoC/ Contains FCC ID: QDS-BRCM1054 | N/A | AC I/P: Unshielded, 1.2 m DC O/P: Shielded, 1.8 m |
| 4. | Notebook | Lenovo | E335 | FCC DoC | N/A | AC I/P: Unshielded, 1.2 m DC O/P: Shielded, 1.8 m |
| 5. | SD Card | SanDisk | MicroSD HC | FCC DoC | N/A | N/A |
| 6. | Bluetooth Earphone | Lenovo | LBH 301 | PYAHS-107W | N/A | N/A |

2.5 EUT Operation Test Setup

The RF test items, utility “QRCT” was installed in Notebook which was programmed in order to make the EUT get into the engineering modes to provide channel selection, power level, data rate and the application type and for continuous transmitting signals.

2.6 Measurement Results Explanation Example

For all conducted test items:

The offset level is set in the spectrum analyzer to compensate the RF cable loss and attenuator factor between EUT conducted output port and spectrum analyzer. With the offset compensation, the spectrum analyzer reading level is exactly the EUT RF output level.

Example:

The spectrum analyzer offset is derived from RF cable loss and attenuator factor.

Offset = RF cable loss + attenuator factor.

Following shows an offset computation example with cable loss 4.2 dB and 10dB attenuator.

Offset(dB) = RF cable loss(dB) + attenuator factor(dB).

= 4.2 + 10 = 14.2 (dB)

3 Test Result

3.1 6dB and 99% Bandwidth Measurement

3.1.1 Limit of 6dB and 99% Bandwidth

The minimum 6 dB bandwidth shall be at least 500 kHz.

3.1.2 Measuring Instruments

The measuring equipment is listed in the section 4 of this test report.

3.1.3 Test Procedures

1. The testing follows FCC KDB Publication No. 558074 DTS D01 Meas. Guidance v04.
2. The RF output of EUT was connected to the spectrum analyzer by RF cable and attenuator. The path loss was compensated to the results for each measurement.
3. Set to the maximum power setting and enable the EUT transmit continuously.
4. Make the measurement with the spectrum analyzer's resolution bandwidth (RBW) = 100 kHz. Set the Video bandwidth (VBW) = 300 kHz. In order to make an accurate measurement. The 6 dB bandwidth must be greater than 500 kHz.
5. For 99% Bandwidth Measurement, the spectrum analyzer's resolution bandwidth (RBW) = 1MHz and set the Video bandwidth (VBW) = 3MHz.
6. Measure and record the results in the test report.

3.1.4 Test Setup

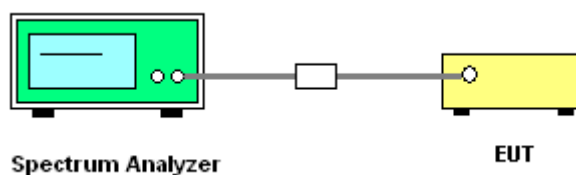



3.1.5 Test Result of 6dB and 99% Occupied Bandwidth

Please refer to Appendix A.

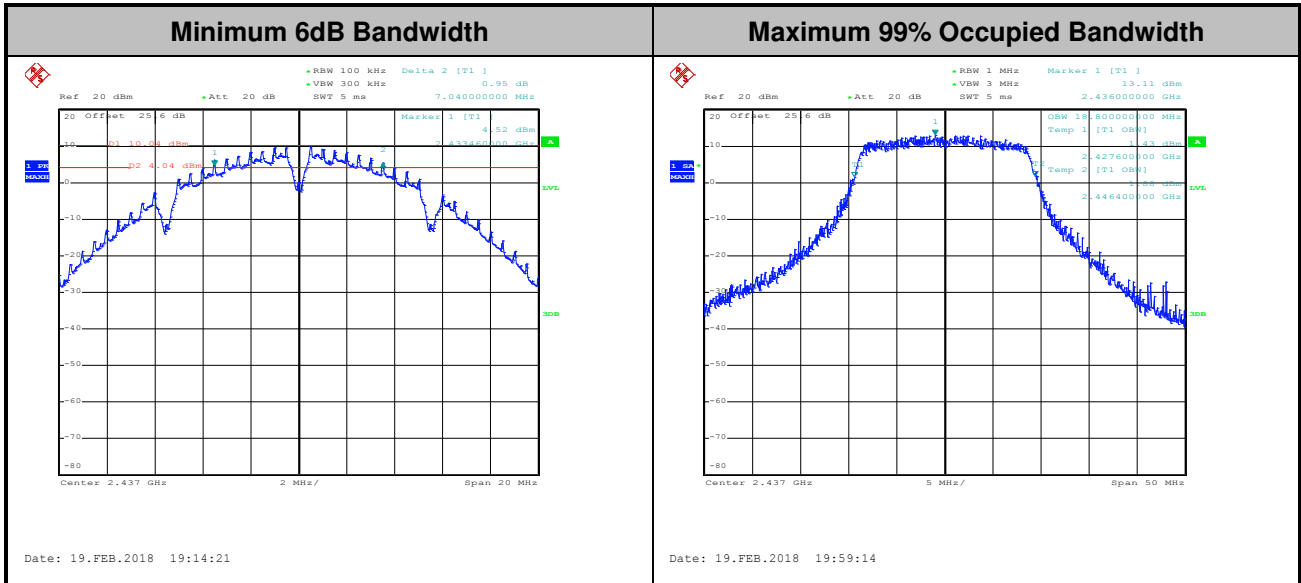

Note : The occupied channel bandwidth is maintained within the band of operation for all of the modulations.

3.2 Output Power Measurement

3.2.1 Limit of Output Power

For systems using digital modulation in the 2400-2483.5MHz, the limit for peak output power is 30dBm. If transmitting antenna with directional gain greater than 6dBi is used, the peak output power from the intentional radiator shall be reduced below the above stated value by the amount in dB that the directional gain of the antenna exceeds 6 dBi. In case of point-to-point operation, the limit has to be reduced by 1dB for every 3dB that the directional gain of the antenna exceeds 6dBi.

3.2.2 Measuring Instruments

The measuring equipment is listed in the section 4 of this test report.

3.2.3 Test Procedures

1. The testing follows the Measurement Procedure of FCC KDB No. 558074 DTS D01 Meas. Guidance v04 section 9.1.3 PKPM1 Peak power meter method.
2. The RF output of EUT was connected to the power meter by RF cable and attenuator. The path loss was compensated to the results for each measurement.
3. Set to the maximum power setting and enable the EUT transmit continuously.
4. Measure the conducted output power and record the results in the test report.

3.2.4 Test Setup

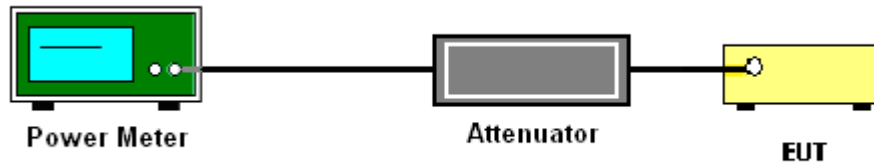

3.2.5 Test Result of Peak Output Power

Please refer to Appendix A.

3.2.6 Test Result of Average output Power (Reporting Only)

Please refer to Appendix A.

3.3 Power Spectral Density Measurement

3.3.1 Limit of Power Spectral Density

The peak power spectral density shall not be greater than 8dBm in any 3kHz band at any time interval of continuous transmission.

3.3.2 Measuring Instruments

The measuring equipment is listed in the section 4 of this test report.

3.3.3 Test Procedures

1. The testing follows Measurement Procedure 10.2 Method PKPSD of FCC KDB Publication No. 558074 D01 DTS Meas. Guidance v04
2. The RF output of EUT was connected to the spectrum analyzer by RF cable and attenuator. The path loss was compensated to the results for each measurement.
3. Set to the maximum power setting and enable the EUT transmit continuously.
4. Make the measurement with the spectrum analyzer's resolution bandwidth (RBW) = 3 kHz. Video bandwidth VBW = 10 kHz In order to make an accurate measurement, set the span to 1.5 times DTS Channel Bandwidth. (6dB BW)
5. Detector = peak, Sweep time = auto couple, Trace mode = max hold, Allow trace to fully stabilize. Use the peak marker function to determine the maximum power level.
6. Measure and record the results in the test report.

3.3.4 Test Setup





3.3.5 Test Result of Power Spectral Density

Please refer to Appendix A.

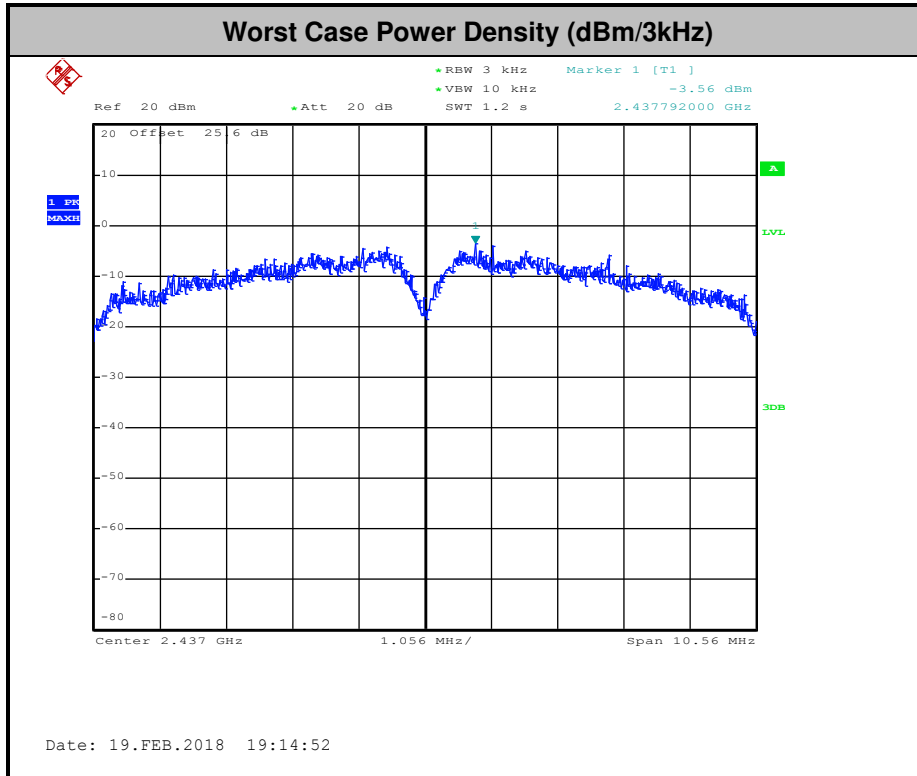

3.4 Conducted Band Edges and Spurious Emission Measurement

3.4.1 Limit of Conducted Band Edges and Spurious Emission Measurement

In any 100 kHz bandwidth outside of the authorized frequency band, the emissions which fall in the non-restricted bands shall be attenuated at least 20 dB / 30dB relative to the maximum PSD level in 100 kHz by RF conducted measurement.

3.4.2 Measuring Instruments

The measuring equipment is listed in the section 4 of this test report.

3.4.3 Test Procedures

1. The testing follows FCC KDB Publication No. 558074 D01 DTS Meas. Guidance v04.
2. The RF output of EUT was connected to the spectrum analyzer by RF cable and attenuator. The path loss was compensated to the results for each measurement.
3. Set to the maximum power setting and enable the EUT transmit continuously.
4. Set RBW = 100 kHz, VBW=300 kHz, Peak Detector. Unwanted Emissions measured in any 100 kHz bandwidth outside of the authorized frequency band shall be attenuated by at least 20 dB relative to the maximum in-band peak PSD level in 100 kHz when maximum peak conducted output power procedure is used. If the transmitter complies with the conducted power limits based on the use of RMS averaging over a time interval, the attenuation required under this paragraph shall be 30 dB instead of 20 dB per 15.247(d).
5. Measure and record the results in the test report.
6. The RF fundamental frequency should be excluded against the limit line in the operating frequency band.

3.4.4 Test Setup

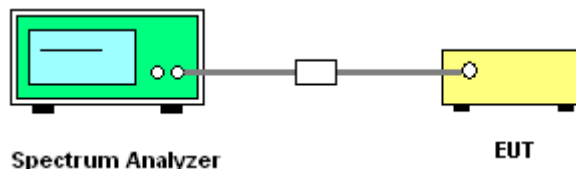



3.4.5 Test Result of Conducted Band Edges and Spurious Emission

| | | |
|---|---------------------|---------|
| Test Engineer : White Lin and Luffy Lin | Temperature : | 21~25°C |
| | Relative Humidity : | 54~51% |

Number of TX = 1, Ant. 1 (Measured)

| | | | |
|-------------|---------|----------------|----|
| Test Mode : | 802.11b | Test Channel : | 01 |
|-------------|---------|----------------|----|

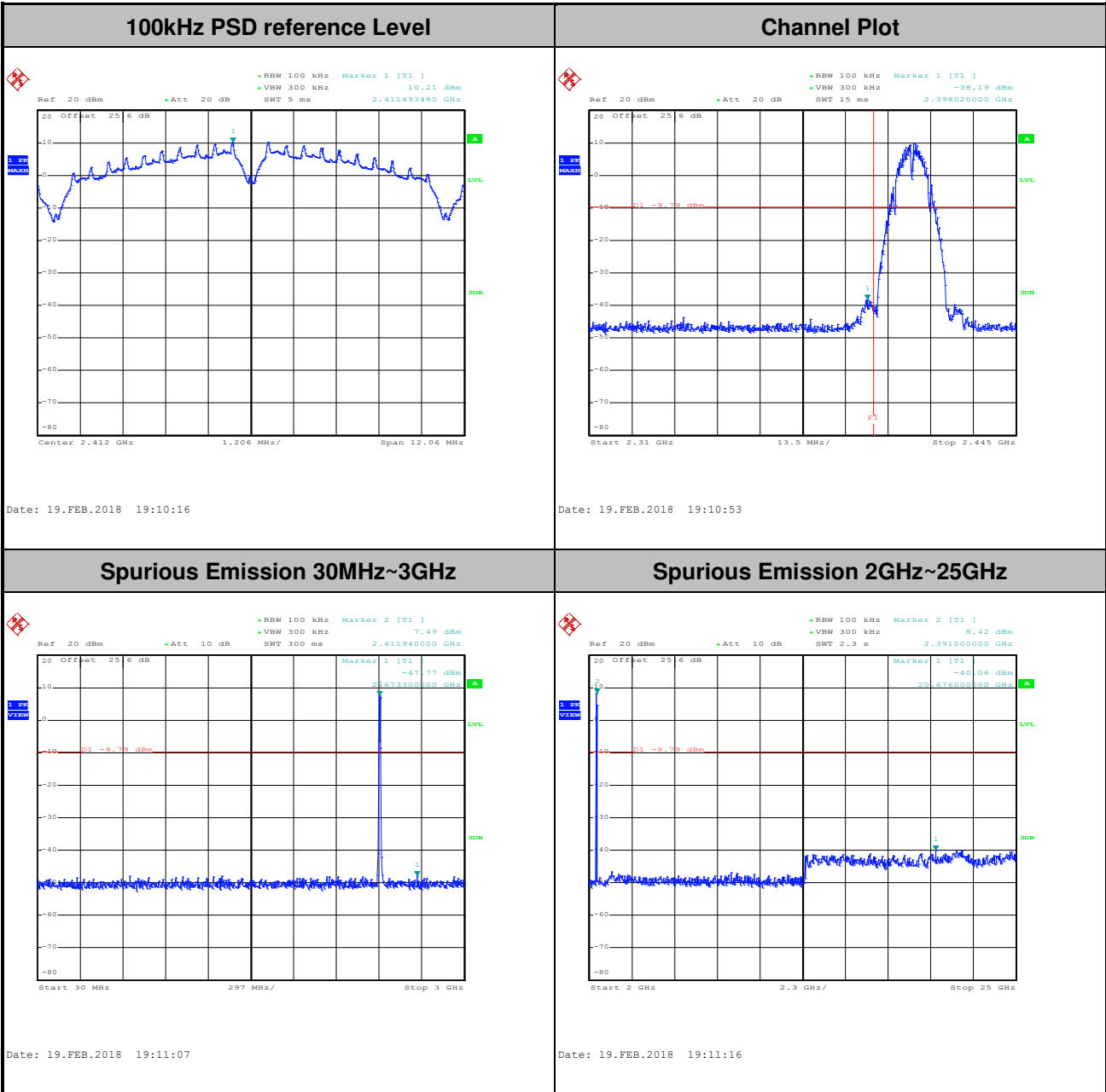



| | | | |
|-------------|---------|----------------|----|
| Test Mode : | 802.11b | Test Channel : | 06 |
|-------------|---------|----------------|----|

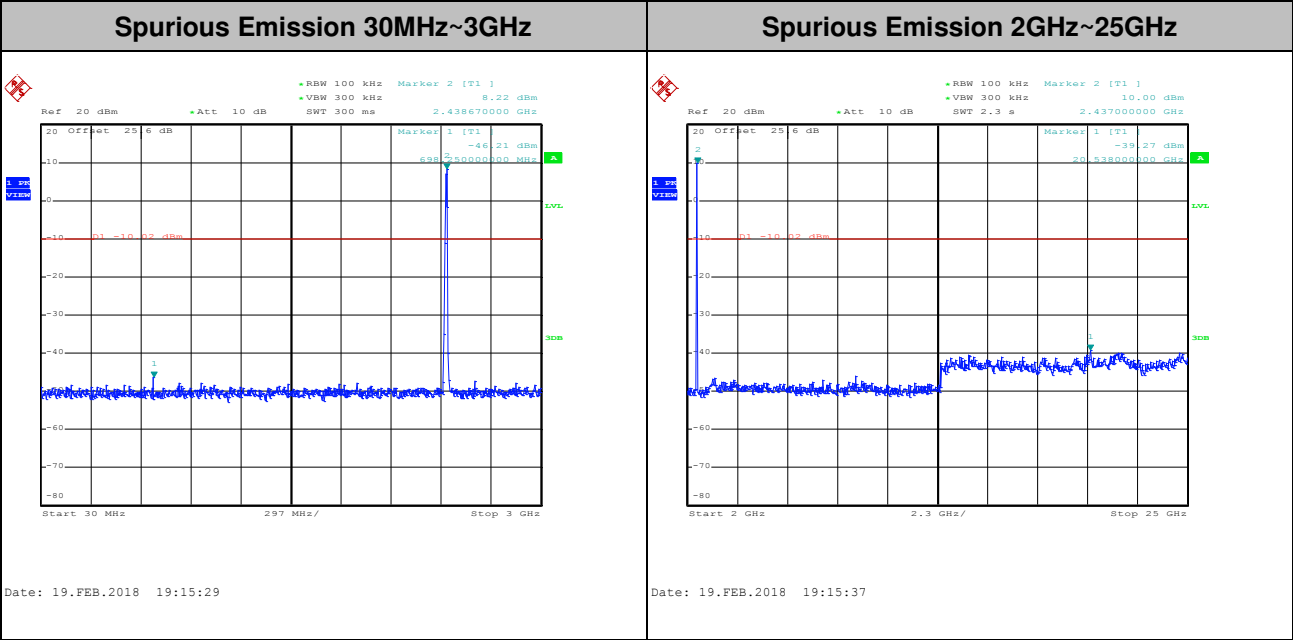
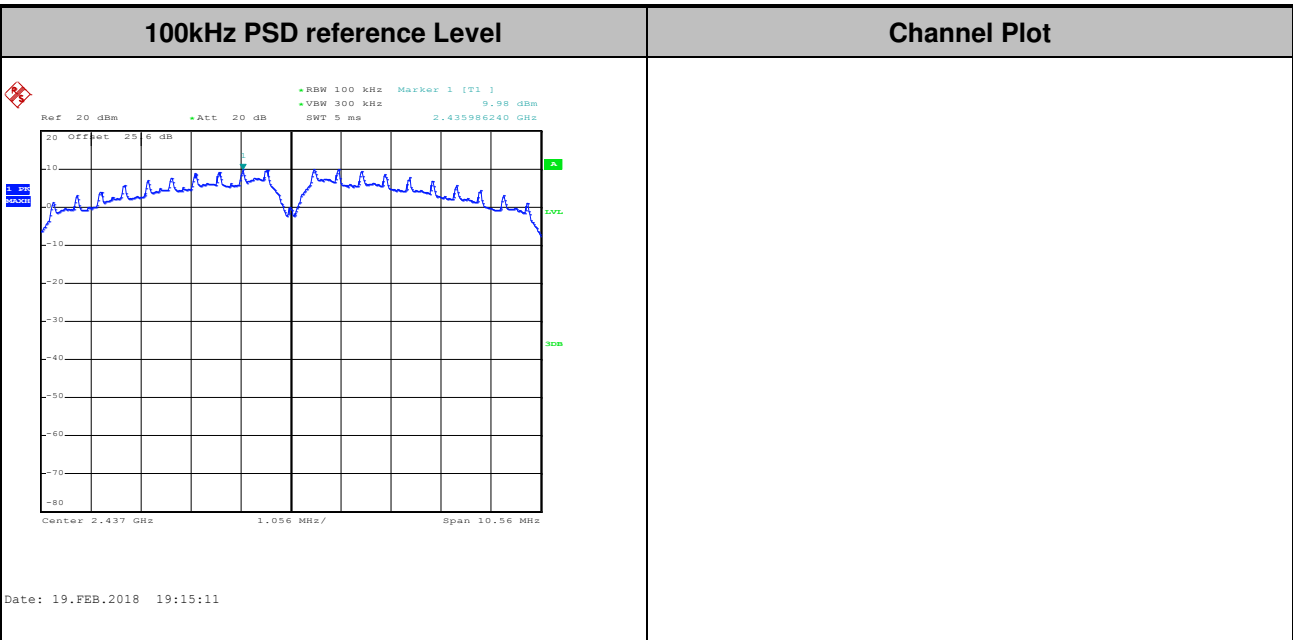



| | | | |
|-------------|---------|----------------|----|
| Test Mode : | 802.11b | Test Channel : | 11 |
|-------------|---------|----------------|----|

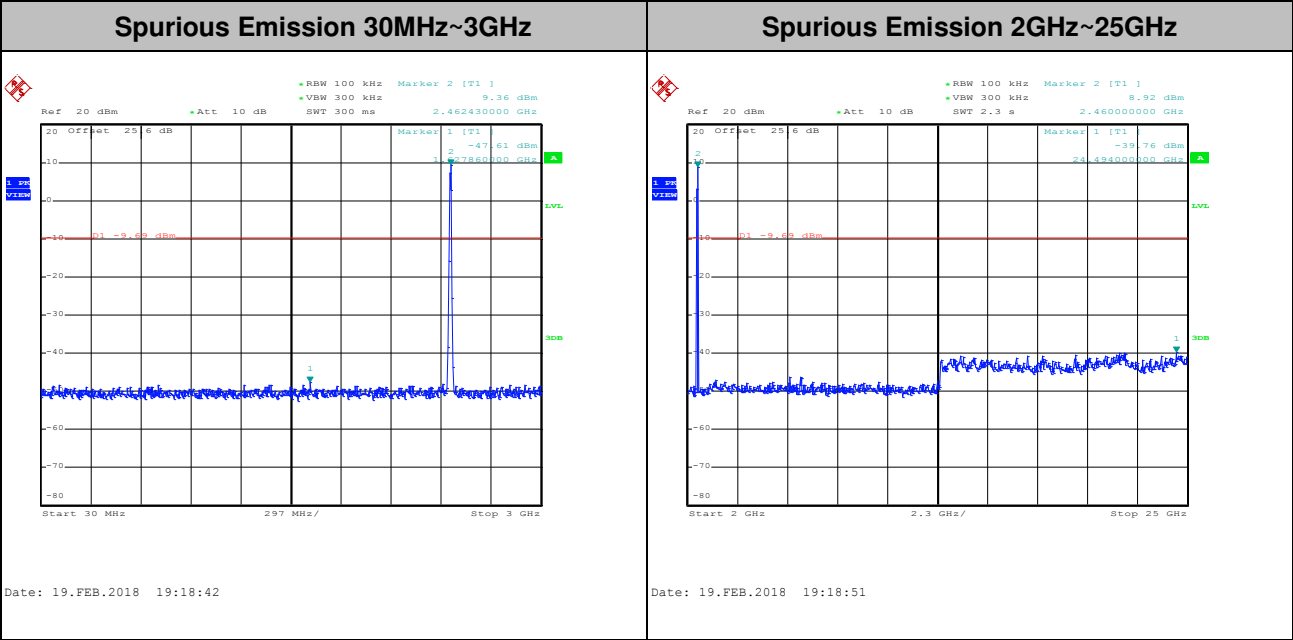
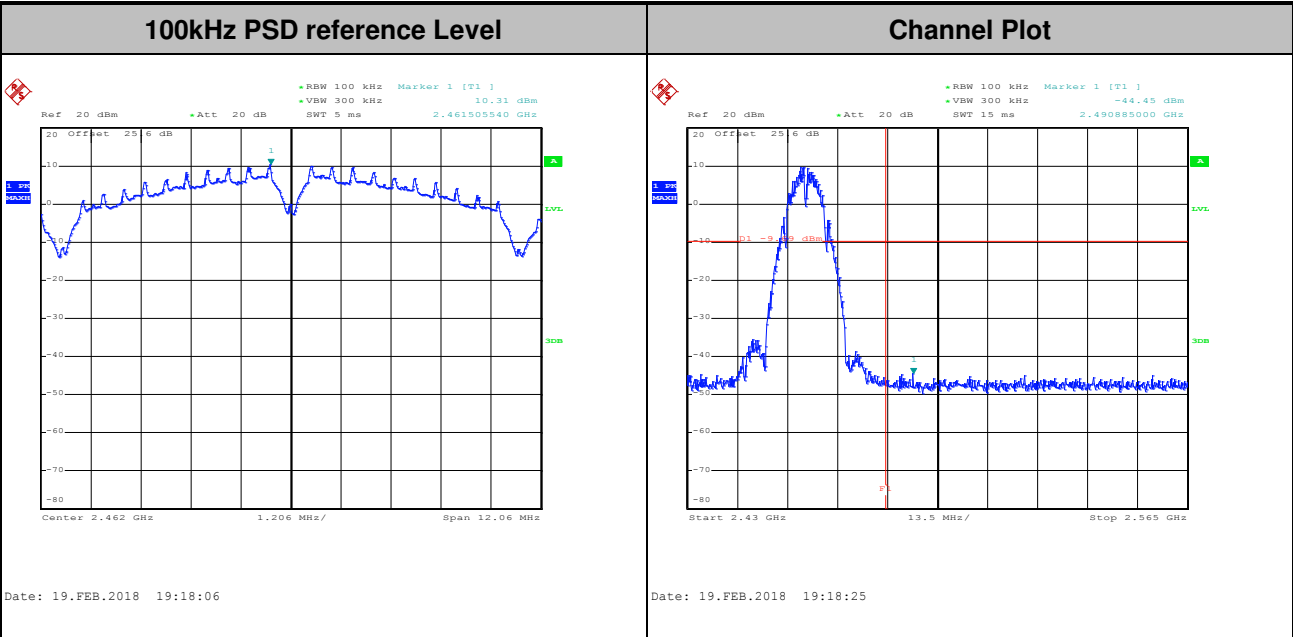



| | | | |
|-------------|---------|----------------|----|
| Test Mode : | 802.11g | Test Channel : | 01 |
|-------------|---------|----------------|----|

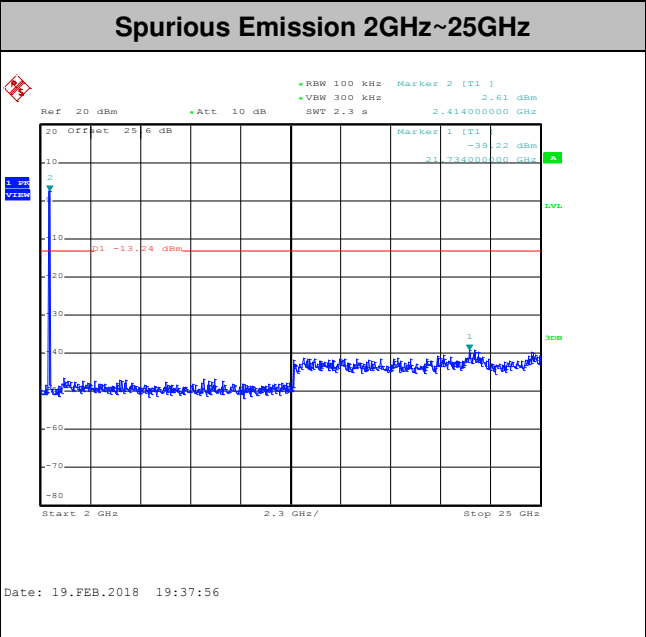
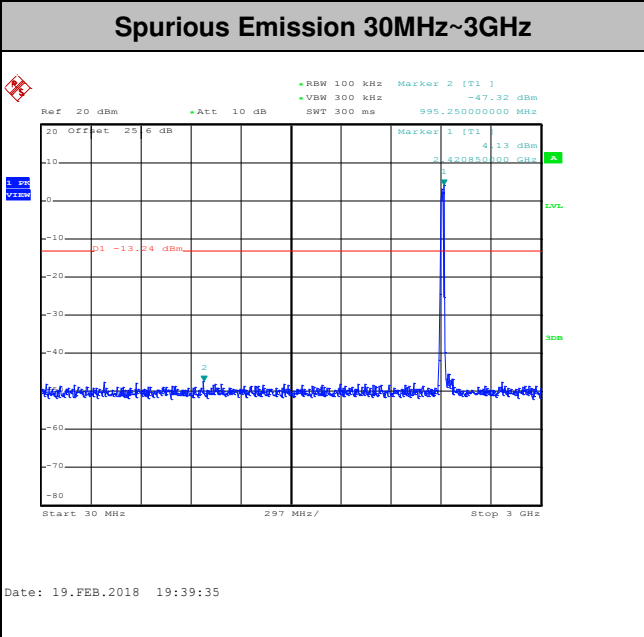
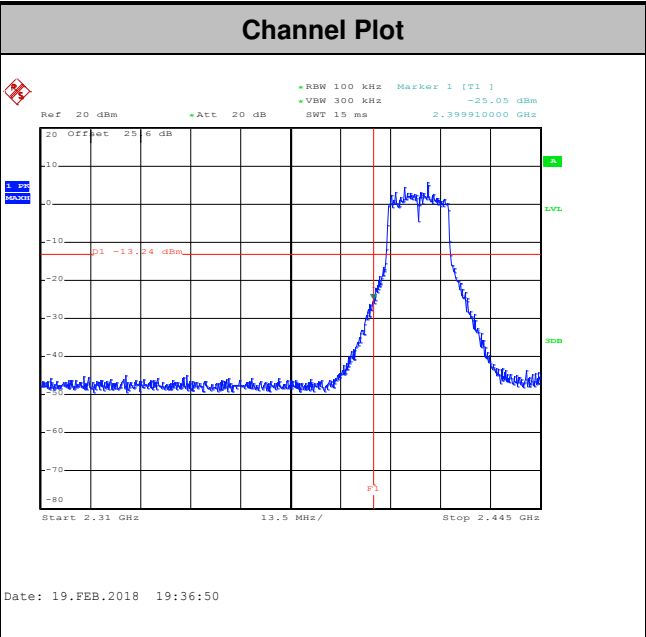
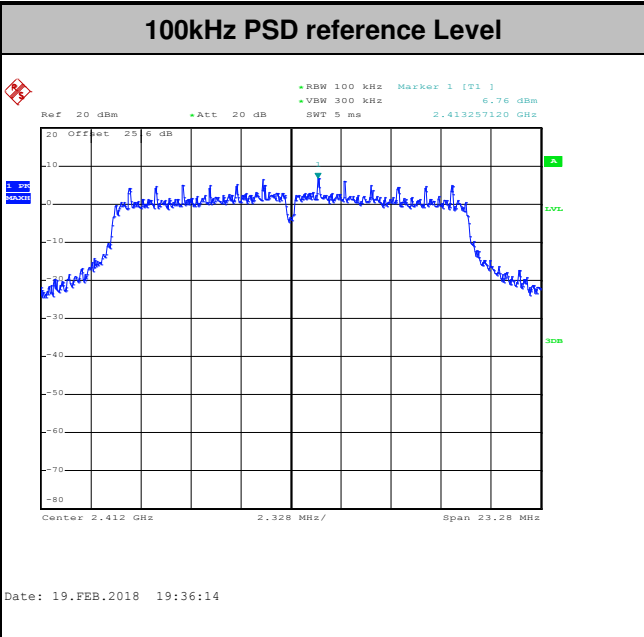



| | | | |
|-------------|---------|----------------|----|
| Test Mode : | 802.11g | Test Channel : | 06 |
|-------------|---------|----------------|----|

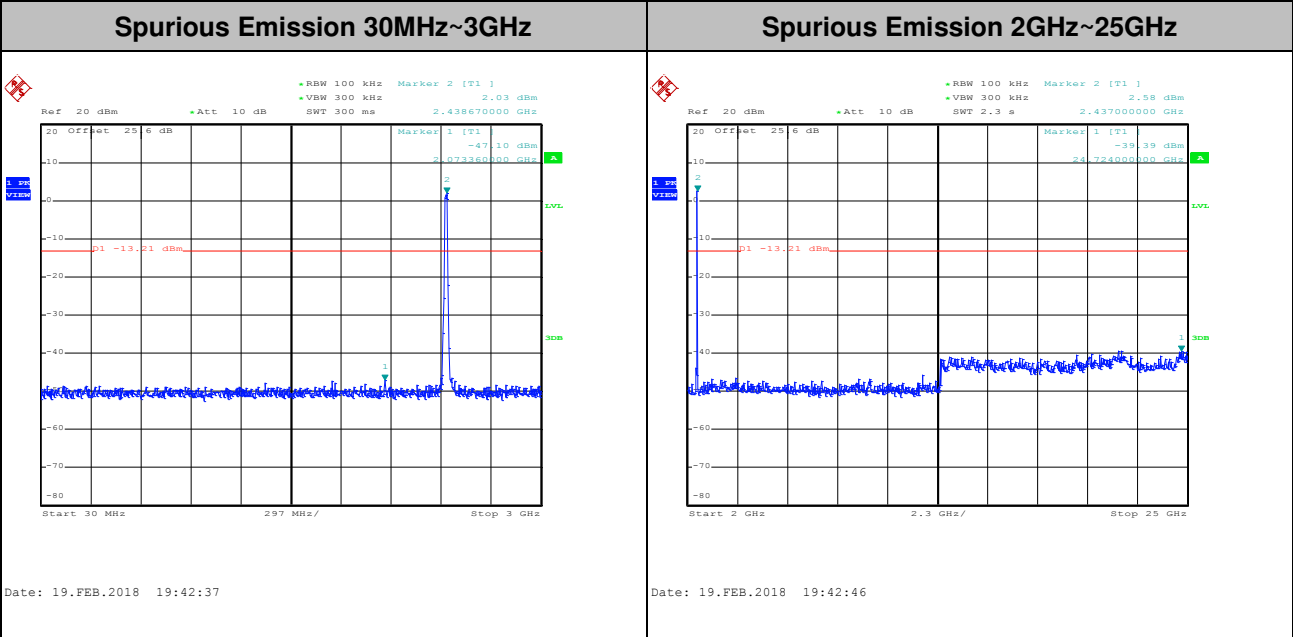
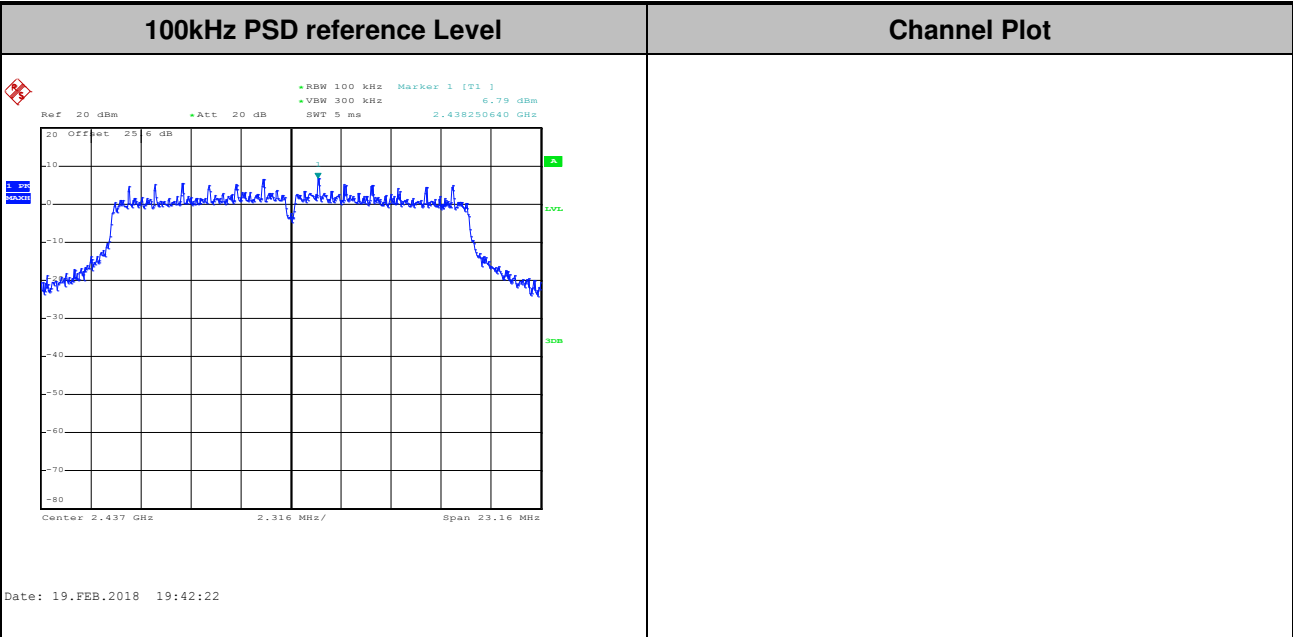



| | | | |
|-------------|---------|----------------|----|
| Test Mode : | 802.11g | Test Channel : | 11 |
|-------------|---------|----------------|----|

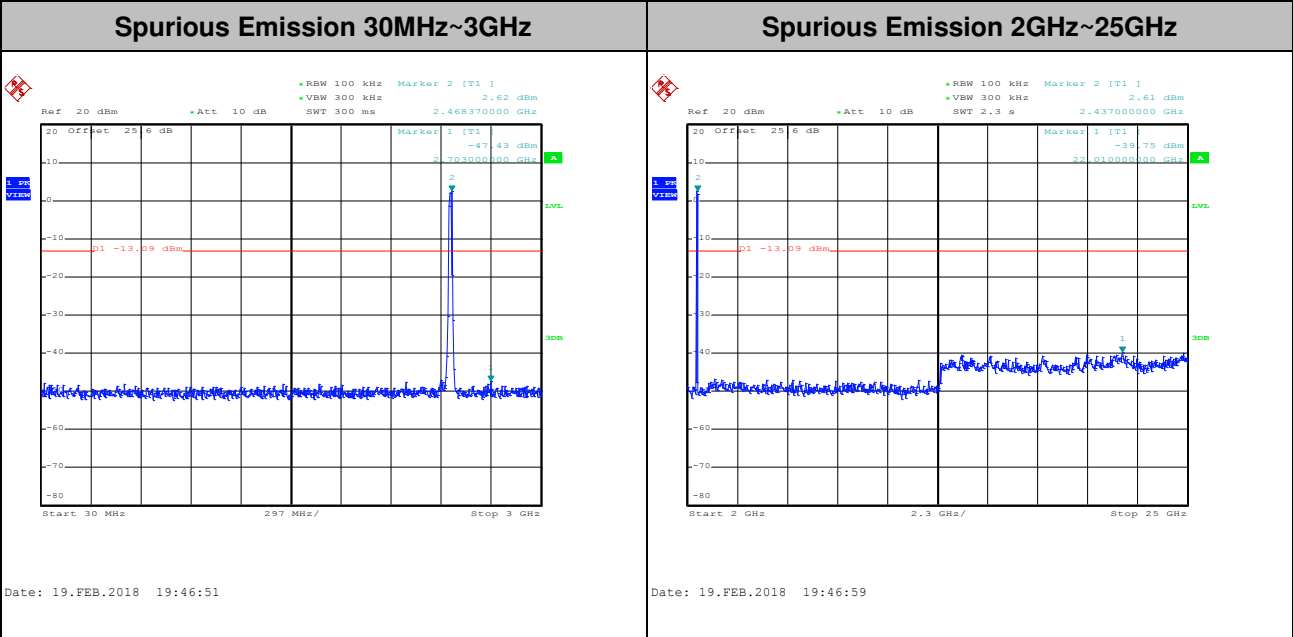
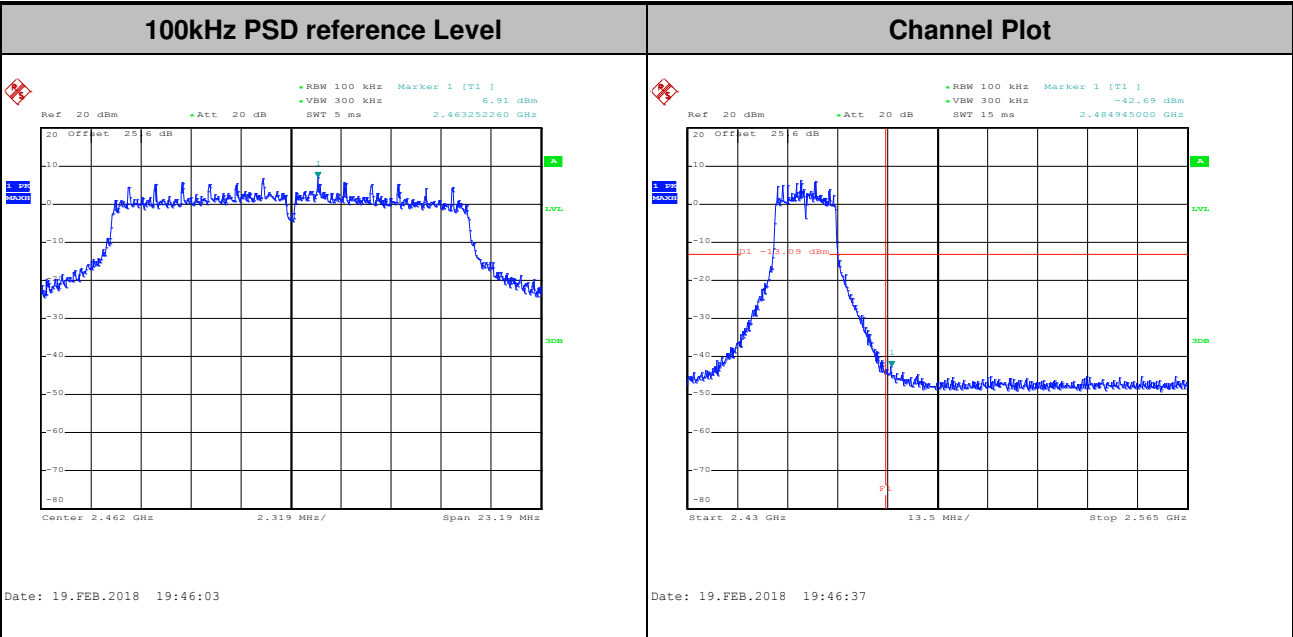



Test Mode : 802.11n HT20 Test Channel : 01

100kHz PSD reference Level

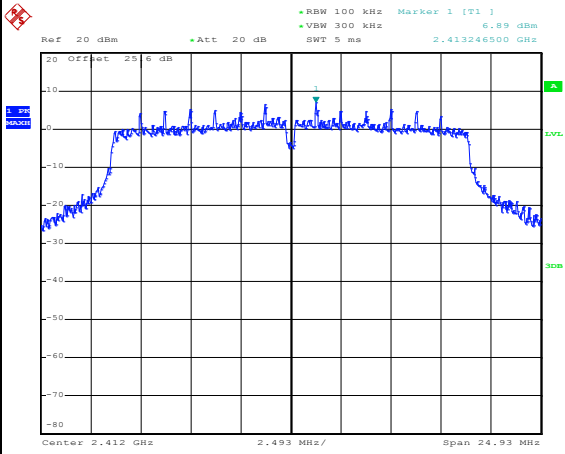

Date: 19.FEB.2018 19:49:59

Channel Plot

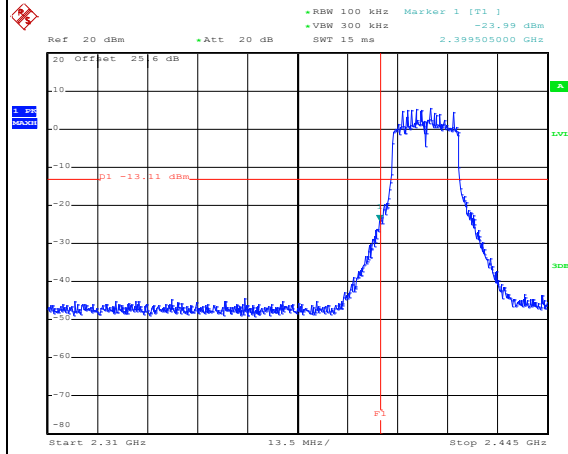

Date: 19.FEB.2018 19:50:22

Spurious Emission 30MHz~3GHz

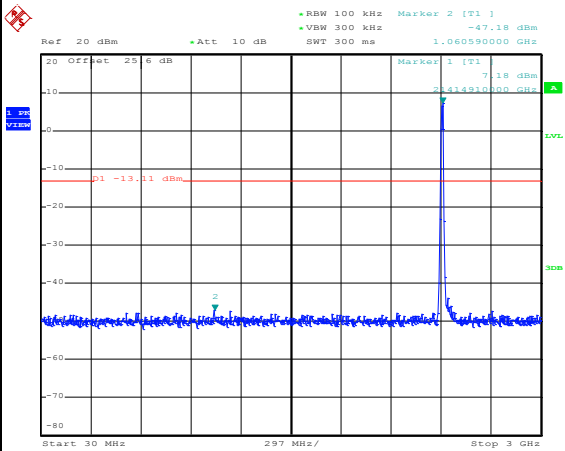

Date: 19.FEB.2018 19:52:56

Spurious Emission 2GHz~25GHz

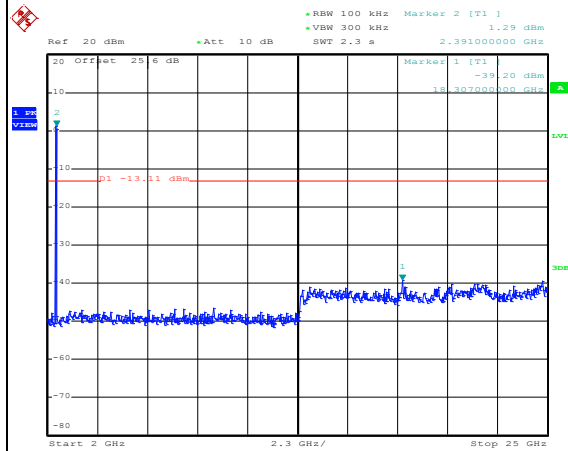

Date: 19.FEB.2018 19:51:25



| | | | |
|-------------|--------------|----------------|----|
| Test Mode : | 802.11n HT20 | Test Channel : | 06 |
|-------------|--------------|----------------|----|

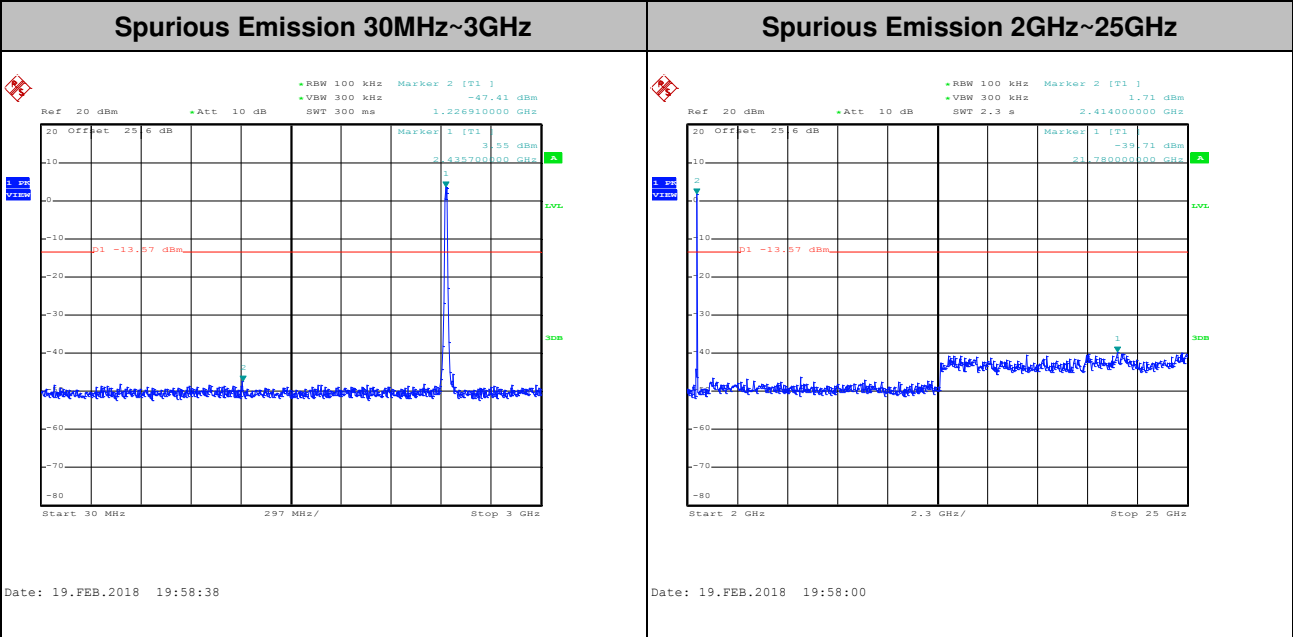
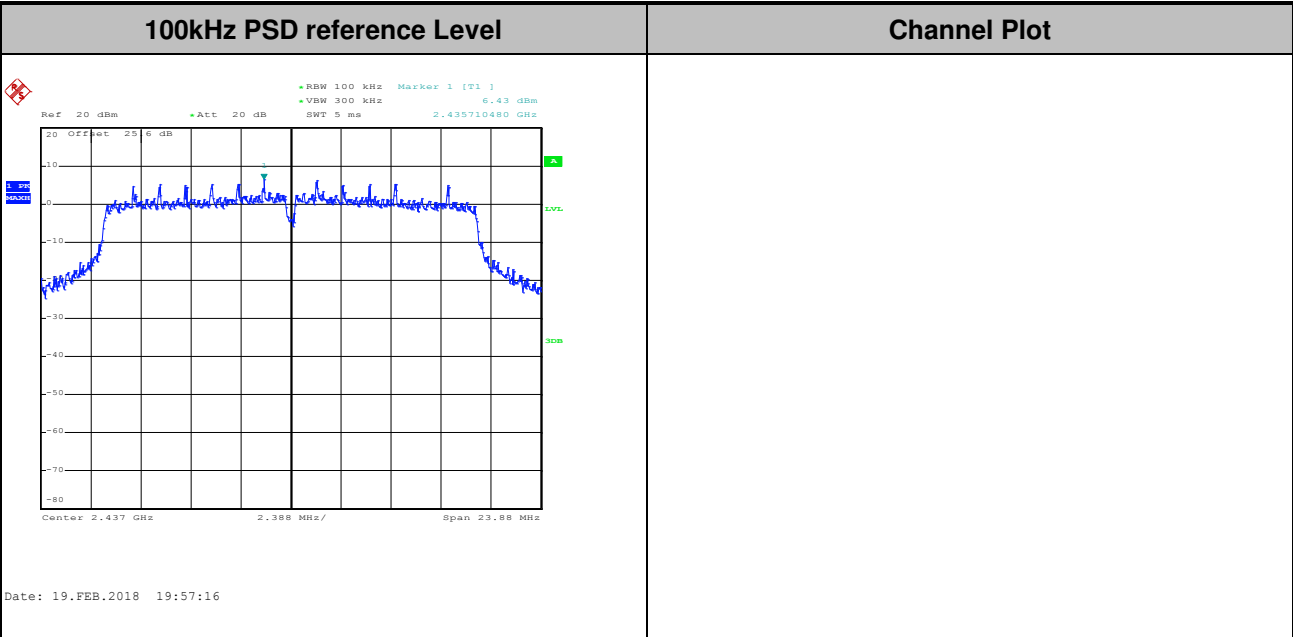



| | | | |
|-------------|--------------|----------------|----|
| Test Mode : | 802.11n HT20 | Test Channel : | 11 |
|-------------|--------------|----------------|----|

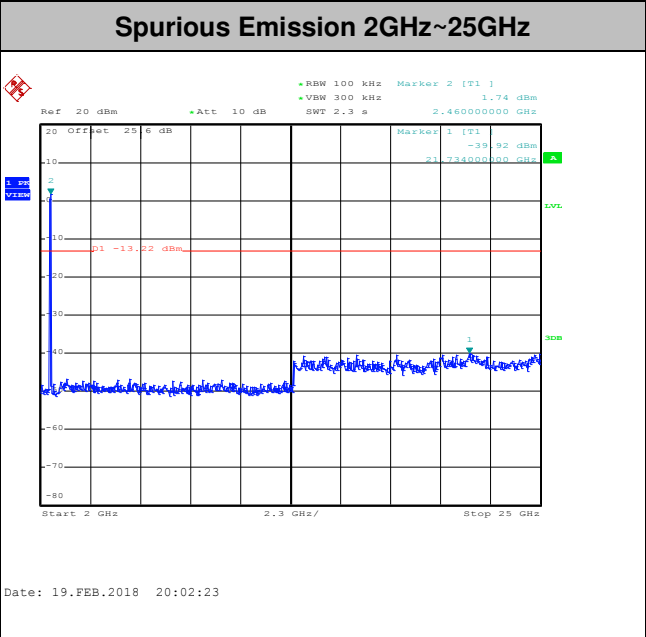
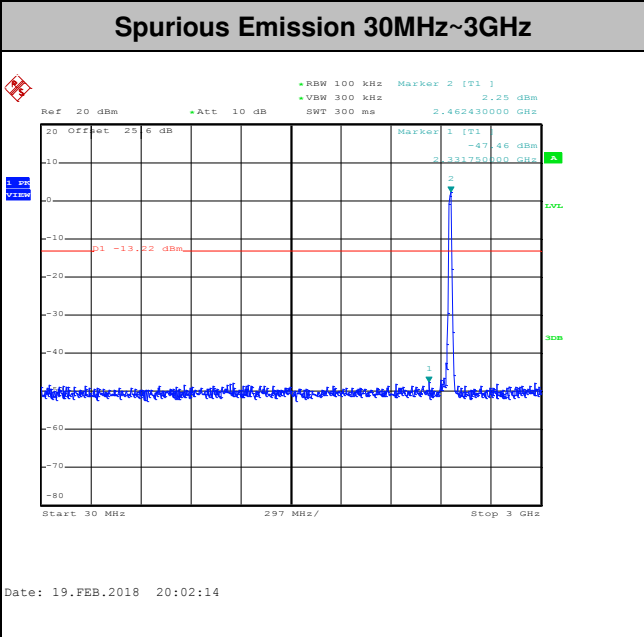
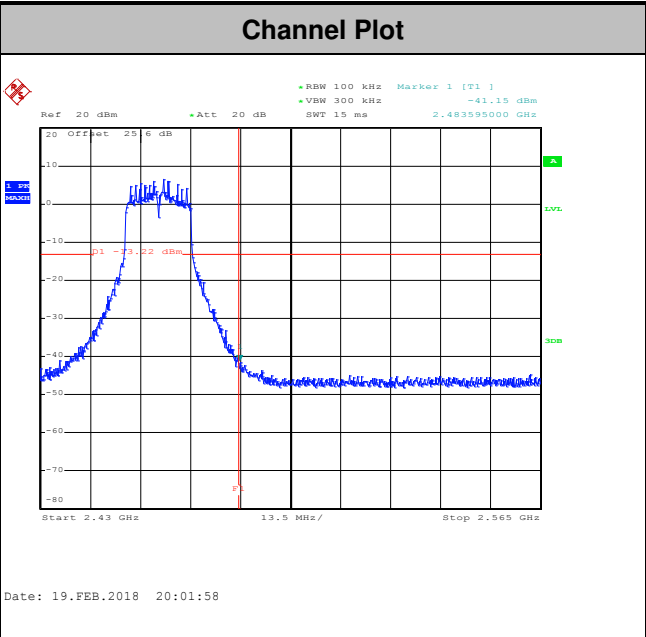
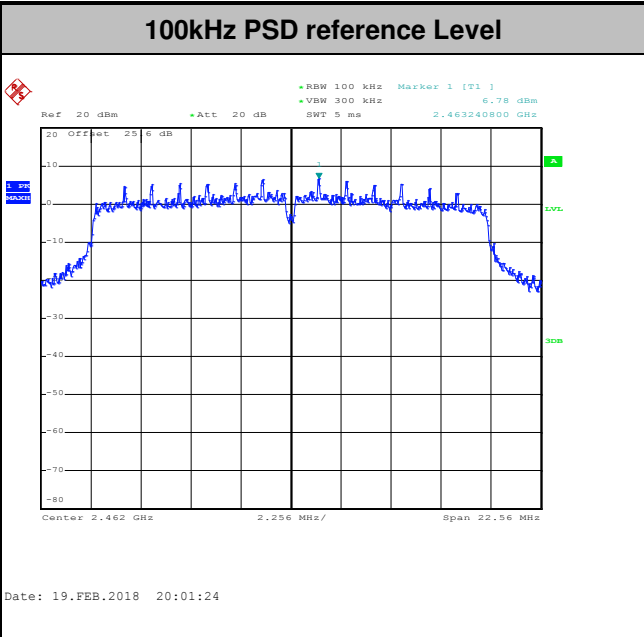



3.5 Radiated Band Edges and Spurious Emission Measurement

3.5.1 Limit of Radiated band edge and Spurious Emission Measurement

In any 100 kHz bandwidth outside the intentional radiator frequency band, all harmonics/spurious must be at least 20 dB below the highest emission level within the authorized band. If the output power of this device was measured by spectrum analyzer, the attenuation under this paragraph shall be 30 dB instead of 20 dB. In addition, radiated emissions which fall in the restricted bands must also comply with the limits as below.

| Frequency (MHz) | Field Strength (microvolts/meter) | Measurement Distance (meters) |
|-----------------|-----------------------------------|-------------------------------|
| 0.009 – 0.490 | 2400/F(kHz) | 300 |
| 0.490 – 1.705 | 24000/F(kHz) | 30 |
| 1.705 – 30.0 | 30 | 30 |
| 30 – 88 | 100 | 3 |
| 88 – 216 | 150 | 3 |
| 216 - 960 | 200 | 3 |
| Above 960 | 500 | 3 |

3.5.2 Measuring Instruments

The measuring equipment is listed in the section 4 of this test report.



3.5.3 Test Procedures

1. The testing follows FCC KDB Publication No. 558074 D01 DTS Meas. Guidance v04.
2. The EUT was arranged to its worst case and then tune the antenna tower (from 1 m to 4 m) and turntable (from 0 degree to 360 degrees) to find the maximum reading. A pre-amp and a high pass filter are used for the test in order to get better signal level.
3. The EUT was placed on a turntable with 0.8 meter for frequency below 1GHz and 1.5 meter for frequency above 1GHz respectively above ground.
4. The EUT was set 3 meters from the interference receiving antenna, which was mounted on the top of a variable height antenna tower.
5. Corrected Reading: Antenna Factor + Cable Loss + Read Level - Preamp Factor = Level
6. For testing below 1GHz, if the emission level of the EUT in peak mode was 3 dB lower than the limit specified, then peak values of EUT will be reported, otherwise, the emissions will be repeated one by one using the CISPR quasi-peak method and reported.
7. For testing above 1GHz, the emission level of the EUT in peak mode was 20dB lower than average limit (that means the emission level in average mode also complies with the limit in average mode), then peak values of EUT will be reported, otherwise, the emissions will be measured in average mode again and reported.
8. Use the following spectrum analyzer settings:
 - (1) Span shall wide enough to fully capture the emission being measured;
 - (2) Set RBW=100 kHz for $f < 1$ GHz; VBW \geq RBW; Sweep = auto; Detector function = peak; Trace = max hold;
 - (3) Set RBW = 1 MHz, VBW= 3MHz for $f \geq 1$ GHz for peak measurement.
For average measurement:
 - VBW = 10 Hz, when duty cycle is no less than 98 percent.
 - VBW $\geq 1/T$, when duty cycle is less than 98 percent where T is the minimum transmission duration over which the transmitter is on and is transmitting at its maximum power control level for the tested mode of operation.

3.5.4 Test Setup

For radiated emissions below 30MHz



For radiated emissions from 30MHz to 1GHz

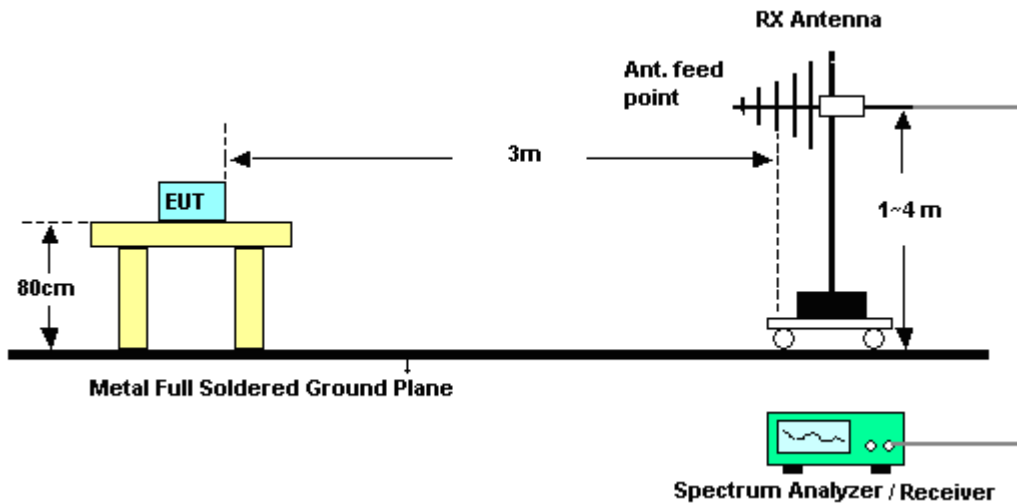

For radiated emissions above 1GHz

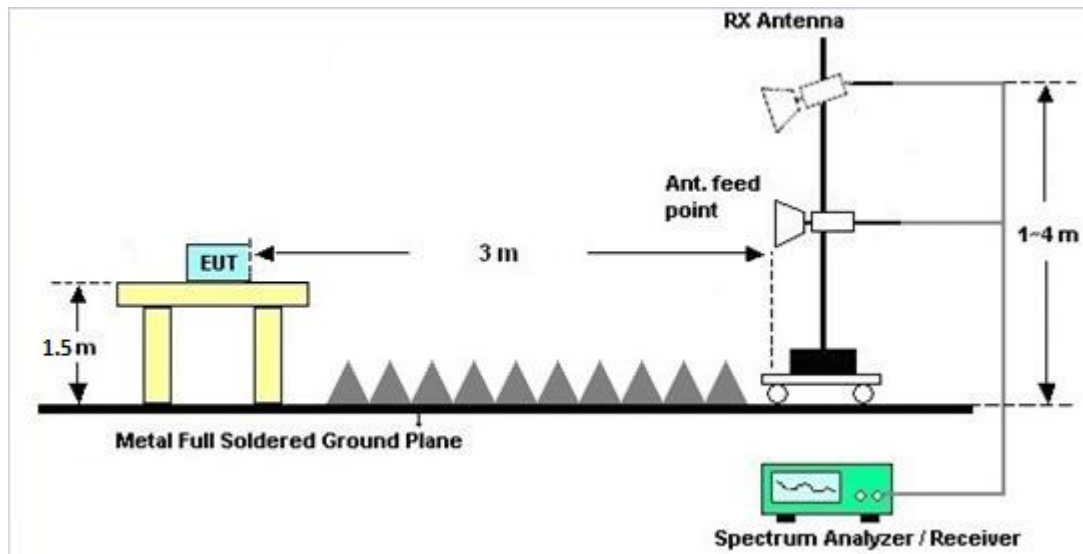

3.5.5 Test Results of Radiated Spurious Emissions (9kHz ~ 30MHz)

The low frequency, which started from 9 kHz to 30MHz, was pre-scanned and the result which was 20dB lower than the limit line was not reported.

There is a comparison data of both open-field test site and semi-Anechoic chamber, and the result came out very similar.

3.5.6 Test Result of Radiated Spurious at Band Edges

Please refer to Appendix C and D.

3.5.7 Duty Cycle

Please refer to Appendix E.

3.5.8 Test Result of Radiated Spurious Emission (30MHz ~ 10th Harmonic)

Please refer to Appendix C and D.



3.6 AC Conducted Emission Measurement

3.6.1 Limit of AC Conducted Emission

For equipment that is designed to be connected to the public utility (AC) power line, the radio frequency voltage that is conducted back onto the AC power line on any frequency or frequencies within the band 150 kHz to 30 MHz shall not exceed the limits in the following table.

| Frequency of Emission (MHz) | Conducted Limit (dBµV) | |
|-----------------------------|------------------------|-----------|
| | Quasi-Peak | Average |
| 0.15-0.5 | 66 to 56* | 56 to 46* |
| 0.5-5 | 56 | 46 |
| 5-30 | 60 | 50 |

*Decreases with the logarithm of the frequency.

3.6.2 Measuring Instruments

The measuring equipment is listed in the section 4 of this test report.

3.6.3 Test Procedures

1. The EUT was placed 0.4 meter from the conducting wall of the shielding room, and it was kept at least 80 centimeters from any other grounded conducting surface.
2. Connect EUT to the power mains through a line impedance stabilization network (LISN).
3. All the support units are connecting to the other LISN.
4. The LISN provides 50 ohm coupling impedance for the measuring instrument.
5. The FCC states that a 50 ohm, 50 microhenry LISN should be used.
6. Both sides of AC line were checked for maximum conducted interference.
7. The frequency range from 150 kHz to 30 MHz was searched.
8. Set the test-receiver system to Peak Detect Function and specified bandwidth (IF bandwidth = 9kHz) with Maximum Hold Mode.

3.6.4 Test Setup

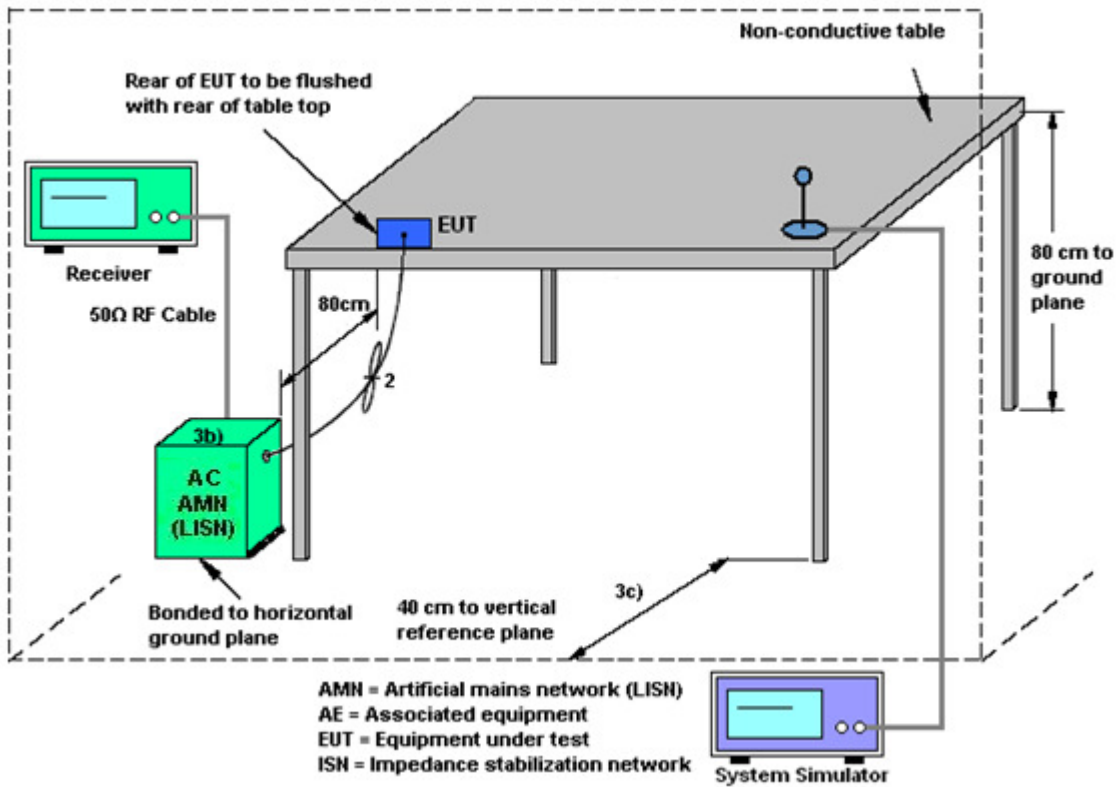

3.6.5 Test Result of AC Conducted Emission

Please refer to Appendix B.



3.7 Antenna Requirements

3.7.1 Standard Applicable

If directional gain of transmitting Antennas is greater than 6dBi, the power shall be reduced by the same level in dB comparing to gain minus 6dBi. The use of a permanently attached Antenna or of an Antenna that uses a unique coupling to the intentional radiator shall be considered sufficient to comply with the rule.

3.7.2 Antenna Anti-Replacement Construction

An embedded-in antenna design is used.

3.7.3 Antenna Gain

The antenna peak gain of EUT is less than 6 dBi. Therefore, it is not necessary to reduce maximum peak output power limit.



4 List of Measuring Equipment

| Instrument | Manufacturer | Model No. | Serial No. | Characteristics | Calibration Date | Test Date | Due Date | Remark |
|----------------------|--------------------|---------------------------------|-----------------|-------------------------------------|------------------|---------------------------------|---------------|--------------------------|
| Power Meter | Anritsu | ML2495A | 0932001 | N/A | Sep. 26, 2017 | Feb. 12, 2018~ Feb. 19, 2018 | Sep. 25, 2018 | Conducted (TH05-HY) |
| Power Sensor | Anritsu | MA2411B | 0846202 | 300MHz~40GHz z | Sep. 26, 2017 | Feb. 12, 2018~ Feb. 19, 2018 | Sep. 25, 2018 | Conducted (TH05-HY) |
| Spectrum Analyzer | Rohde & Schwarz | FSP30 | 101067 | 9kHz ~ 30GHz | Nov. 13, 2017 | Feb. 12, 2018~ Feb. 19, 2018 | Nov. 12, 2018 | Conducted (TH05-HY) |
| AC Power Source | ChainTek | APC-1000W | N/A | N/A | N/A | Feb. 27, 2018 | N/A | Conduction (CO05-HY) |
| EMI Test Receiver | Rohde & Schwarz | ESR3 | 102388 | 3.6GHz | Dec. 08, 2017 | Feb. 27, 2018 | Dec. 07, 2018 | Conduction (CO05-HY) |
| LISN | Rohde & Schwarz | ENV216 | 100080 | 9kHz~30MHz | Nov. 30, 2017 | Feb. 27, 2018 | Nov. 29, 2018 | Conduction (CO05-HY) |
| Amplifier | MITEQ | TTA1840-35-HG | 1871923 | 18GHz~40GHz, VSWR : 2.5:1 max | Jul. 18, 2017 | Feb. 27, 2018~ Mar. 03, 2018 | Jul. 17, 2018 | Radiation (03CH12-HY) |
| Bilog Antenna | TESEQ | CBL 6111D&00800 N1D01N-06 | 40103&07 | 30MHz~1GHz | Jan. 10, 2018 | Feb. 27, 2018~ Mar. 03, 2018 | Jan. 09, 2019 | Radiation (03CH12-HY) |
| Loop Antenna | Rohde & Schwarz | HFH2-Z2 | 100488 | 9 kHz~30 MHz | Nov. 23, 2017 | Feb. 27, 2018~ Mar. 03, 2018 | Nov. 22, 2019 | Radiation (03CH12-HY) |
| EMI Test Receiver | Rohde & Schwarz | ESU26 | 100390 | 20Hz~26.5GHz | Dec. 25, 2017 | Feb. 27, 2018~ Mar. 03, 2018 | Dec. 24, 2018 | Radiation (03CH12-HY) |
| Horn Antenna | SCHWARZBECK | BBHA 9120D | 9120D-132 8 | 1GHz ~ 18GHz | Oct. 20, 2017 | Feb. 27, 2018~ Mar. 03, 2018 | Oct. 19, 2018 | Radiation (03CH12-HY) |
| Preamplifier | COM-POWER | PA-103 | 161075 | 10MHz~1GHz | Mar. 23, 2017 | Feb. 27, 2018~ Mar. 03, 2018 | Mar. 22, 2018 | Radiation (03CH12-HY) |
| Preamplifier | Keysight | 83017A | MY532701 48 | 1GHz~26.5GHz | Jan. 15, 2018 | Feb. 27, 2018~ Mar. 03, 2018 | Jan. 14, 2019 | Radiation (03CH12-HY) |
| Preamplifier | MITEQ | AMF-7D-0010 1800 | 2025787 | 1GHz~18GHz | Feb. 13, 2017 | Feb. 27, 2018~ Mar. 03, 2018 | Feb. 12, 2019 | Radiation (03CH12-HY) |
| Antenna Mast | EMEC | AM-BS-4500-B | N/A | 1m~4m | N/A | Feb. 27, 2018~ Mar. 03, 2018 | N/A | Radiation (03CH12-HY) |
| Turn Table | EMEC | TT2000 | N/A | 0~360 Degree | N/A | Feb. 27, 2018~ Mar. 03, 2018 | N/A | Radiation (03CH12-HY) |
| Attenuator | Fairview Microwave | SA18S5W-10 | n/a | 10db | Mar. 24, 2017 | Feb. 27, 2018~ Mar. 03, 2018 | Mar. 23, 2018 | Radiation (03CH12-HY) |
| SHF-EHF Horn Antenna | SCHWARZBECK | BBHA 9170 | BBHA9170 576 | 18GHz ~ 40GHz | Apr. 27, 2017 | Feb. 27, 2018~ Mar. 03, 2018 | Apr. 26, 2018 | Radiation (03CH12-HY) |
| Spectrum Analyzer | Keysight | N9010A | MY553705 26 | 10Hz~44GHz | Mar. 15, 2017 | Feb. 27, 2018~ Mar. 03, 2018 | Mar. 14, 2018 | Radiation (03CH12-HY) |



5 Uncertainty of Evaluation

Uncertainty of Conducted Emission Measurement (150kHz ~ 30MHz)

| | |
|---|------|
| Measuring Uncertainty for a Level of Confidence of 95% ($U = 2Uc(y)$) | 2.70 |
|---|------|

Uncertainty of Radiated Emission Measurement (30 MHz ~ 1000 MHz)

| | |
|---|------|
| Measuring Uncertainty for a Level of Confidence of 95% ($U = 2Uc(y)$) | 5.10 |
|---|------|

Uncertainty of Radiated Emission Measurement (1000 MHz ~ 18000 MHz)

| | |
|---|------|
| Measuring Uncertainty for a Level of Confidence of 95% ($U = 2Uc(y)$) | 5.20 |
|---|------|

Uncertainty of Radiated Emission Measurement (18000 MHz ~ 40000 MHz)

| | |
|---|------|
| Measuring Uncertainty for a Level of Confidence of 95% ($U = 2Uc(y)$) | 4.70 |
|---|------|

Appendix A. Test Result of Conducted Test Items

| | | | | |
|----------------|------------------------|--------------------|-------|----|
| Test Engineer: | White Lin / Luffy Lin | Temperature: | 21~25 | °C |
| Test Date: | 2018/2/12 ~ 2018/02/19 | Relative Humidity: | 51~54 | % |

TEST RESULTS DATA
6dB and 99% Occupied Bandwidth

| 2.4GHz Band | | | | | | | | |
|-------------|-----------|-----------------|-----|-------------|-----------------------|--------------|--------------------|-----------|
| Mod. | Data Rate | N _{TX} | CH. | Freq. (MHz) | 99% Occupied BW (MHz) | 6dB BW (MHz) | 6dB BW Limit (MHz) | Pass/Fail |
| 11b | 1Mbps | 1 | 1 | 2412 | 12.75 | 8.04 | 0.50 | Pass |
| 11b | 1Mbps | 1 | 6 | 2437 | 12.95 | 7.04 | 0.50 | Pass |
| 11b | 1Mbps | 1 | 11 | 2462 | 12.70 | 8.04 | 0.50 | Pass |
| 11g | 6Mbps | 1 | 1 | 2412 | 17.50 | 15.52 | 0.50 | Pass |
| 11g | 6Mbps | 1 | 6 | 2437 | 17.75 | 15.44 | 0.50 | Pass |
| 11g | 6Mbps | 1 | 11 | 2462 | 17.50 | 15.46 | 0.50 | Pass |
| HT20 | MCS0 | 1 | 1 | 2412 | 18.70 | 16.62 | 0.50 | Pass |
| HT20 | MCS0 | 1 | 6 | 2437 | 18.80 | 15.92 | 0.50 | Pass |
| HT20 | MCS0 | 1 | 11 | 2462 | 18.60 | 15.04 | 0.50 | Pass |

TEST RESULTS DATA
Peak Power Table

| 2.4GHz Band | | | | | | | | | | |
|-------------|-----------|-----------------|-----|-------------|----------------------------|-----------------------------|----------|------------------|------------------------|------------|
| Mod. | Data Rate | N _{TX} | CH. | Freq. (MHz) | Peak Conducted Power (dBm) | Conducted Power Limit (dBm) | DG (dBi) | EIRP Power (dBm) | EIRP Power Limit (dBm) | Pass /Fail |
| 11b | 1Mbps | 1 | 1 | 2412 | 21.33 | 30.00 | -5.00 | 16.33 | 36.00 | Pass |
| 11b | 1Mbps | 1 | 6 | 2437 | 21.65 | 30.00 | -5.00 | 16.65 | 36.00 | Pass |
| 11b | 1Mbps | 1 | 11 | 2462 | 21.48 | 30.00 | -5.00 | 16.48 | 36.00 | Pass |
| 11g | 6Mbps | 1 | 1 | 2412 | 21.52 | 30.00 | -5.00 | 16.52 | 36.00 | Pass |
| 11g | 6Mbps | 1 | 6 | 2437 | 21.76 | 30.00 | -5.00 | 16.76 | 36.00 | Pass |
| 11g | 6Mbps | 1 | 11 | 2462 | 21.66 | 30.00 | -5.00 | 16.66 | 36.00 | Pass |
| HT20 | MCS0 | 1 | 1 | 2412 | 21.55 | 30.00 | -5.00 | 16.55 | 36.00 | Pass |
| HT20 | MCS0 | 1 | 6 | 2437 | 21.76 | 30.00 | -5.00 | 16.76 | 36.00 | Pass |
| HT20 | MCS0 | 1 | 11 | 2462 | 21.46 | 30.00 | -5.00 | 16.46 | 36.00 | Pass |

TEST RESULTS DATA
Average Power Table
(Reporting Only)

| 2.4GHz Band | | | | | | |
|-------------|-----------|-----------------|-----|-------------|------------------|-------------------------------|
| Mod. | Data Rate | N _{TX} | CH. | Freq. (MHz) | Duty Factor (dB) | Average Conducted Power (dBm) |
| 11b | 1Mbps | 1 | 1 | 2412 | 0.05 | 18.66 |
| 11b | 1Mbps | 1 | 6 | 2437 | 0.05 | 18.97 |
| 11b | 1Mbps | 1 | 11 | 2462 | 0.05 | 18.77 |
| 11g | 6Mbps | 1 | 1 | 2412 | 0.25 | 16.83 |
| 11g | 6Mbps | 1 | 6 | 2437 | 0.25 | 16.97 |
| 11g | 6Mbps | 1 | 11 | 2462 | 0.25 | 16.86 |
| HT20 | MCS0 | 1 | 1 | 2412 | 0.26 | 16.68 |
| HT20 | MCS0 | 1 | 6 | 2437 | 0.26 | 16.88 |
| HT20 | MCS0 | 1 | 11 | 2462 | 0.26 | 16.64 |

TEST RESULTS DATA
Peak Power Density

| 2.4GHz Band | | | | | | | | |
|-------------|-----------|-----------------|-----|-------------|----------------------|----------|----------------------------|-----------|
| Mod. | Data Rate | N _{TX} | CH. | Freq. (MHz) | Peak PSD (dBm /3kHz) | DG (dBi) | Peak PSD Limit (dBm /3kHz) | Pass/Fail |
| 11b | 1Mbps | 1 | 1 | 2412 | -4.19 | -5.00 | 8.00 | Pass |
| 11b | 1Mbps | 1 | 6 | 2437 | -3.56 | -5.00 | 8.00 | Pass |
| 11b | 1Mbps | 1 | 11 | 2462 | -4.74 | -5.00 | 8.00 | Pass |
| 11g | 6Mbps | 1 | 1 | 2412 | -8.18 | -5.00 | 8.00 | Pass |
| 11g | 6Mbps | 1 | 6 | 2437 | -9.51 | -5.00 | 8.00 | Pass |
| 11g | 6Mbps | 1 | 11 | 2462 | -8.92 | -5.00 | 8.00 | Pass |
| HT20 | MCS0 | 1 | 1 | 2412 | -9.46 | -5.00 | 8.00 | Pass |
| HT20 | MCS0 | 1 | 6 | 2437 | -9.68 | -5.00 | 8.00 | Pass |
| HT20 | MCS0 | 1 | 11 | 2462 | -9.39 | -5.00 | 8.00 | Pass |



Appendix B. AC Conducted Emission Test Results

| | | | |
|-----------------|------------|---------------------|---------|
| Test Engineer : | Shareef Yu | Temperature : | 22~23°C |
| | | Relative Humidity : | 58~62% |

EUT Information

Report NO : 811821-02
 Test Mode : Mode 1
 Test Voltage : 120Vac/60Hz
 Phase : Line

Full Spectrum

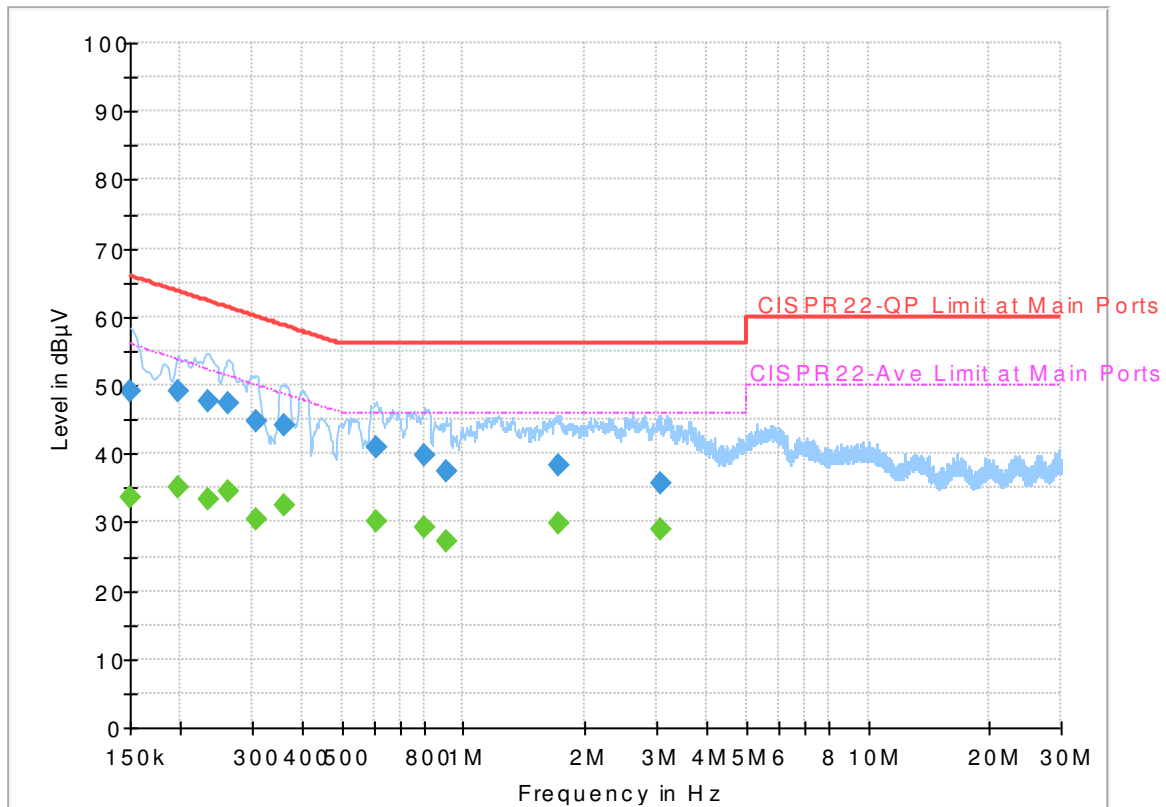

Final Result

| Frequency (MHz) | QuasiPeak (dBµV) | Average (dBµV) | Limit (dBµV) | Margin (dB) | Line | Filter | Corr. (dB) |
|-----------------|------------------|----------------|--------------|-------------|------|--------|------------|
| 0.150000 | --- | 33.62 | 56.00 | 22.38 | L1 | OFF | 19.5 |
| 0.150000 | 48.99 | --- | 66.00 | 17.01 | L1 | OFF | 19.5 |
| 0.197250 | --- | 35.10 | 53.73 | 18.63 | L1 | OFF | 19.5 |
| 0.197250 | 49.05 | --- | 63.73 | 14.68 | L1 | OFF | 19.5 |
| 0.233250 | --- | 33.43 | 52.33 | 18.90 | L1 | OFF | 19.5 |
| 0.233250 | 47.65 | --- | 62.33 | 14.68 | L1 | OFF | 19.5 |
| 0.262500 | --- | 34.39 | 51.35 | 16.96 | L1 | OFF | 19.5 |
| 0.262500 | 47.51 | --- | 61.35 | 13.84 | L1 | OFF | 19.5 |
| 0.307500 | --- | 30.45 | 50.04 | 19.59 | L1 | OFF | 19.5 |
| 0.307500 | 44.80 | --- | 60.04 | 15.24 | L1 | OFF | 19.5 |
| 0.361500 | --- | 32.36 | 48.69 | 16.33 | L1 | OFF | 19.5 |
| 0.361500 | 44.18 | --- | 58.69 | 14.51 | L1 | OFF | 19.5 |
| 0.606750 | --- | 30.19 | 46.00 | 15.81 | L1 | OFF | 19.5 |
| 0.606750 | 40.89 | --- | 56.00 | 15.11 | L1 | OFF | 19.5 |
| 0.802500 | --- | 29.31 | 46.00 | 16.69 | L1 | OFF | 19.5 |
| 0.802500 | 39.85 | --- | 56.00 | 16.15 | L1 | OFF | 19.5 |
| 0.908250 | --- | 27.34 | 46.00 | 18.66 | L1 | OFF | 19.5 |
| 0.908250 | 37.36 | --- | 56.00 | 18.64 | L1 | OFF | 19.5 |
| 1.727250 | --- | 29.79 | 46.00 | 16.21 | L1 | OFF | 19.6 |
| 1.727250 | 38.29 | --- | 56.00 | 17.71 | L1 | OFF | 19.6 |
| 3.054750 | --- | 28.83 | 46.00 | 17.17 | L1 | OFF | 19.6 |

| | | | | | | | |
|----------|-------|-----|-------|-------|----|-----|------|
| 3.054750 | 35.72 | --- | 56.00 | 20.28 | L1 | OFF | 19.6 |
|----------|-------|-----|-------|-------|----|-----|------|

EUT Information

Report NO : 811821-02
 Test Mode : Mode 1
 Test Voltage : 120Vac/60Hz
 Phase : Neutral

Full Spectrum

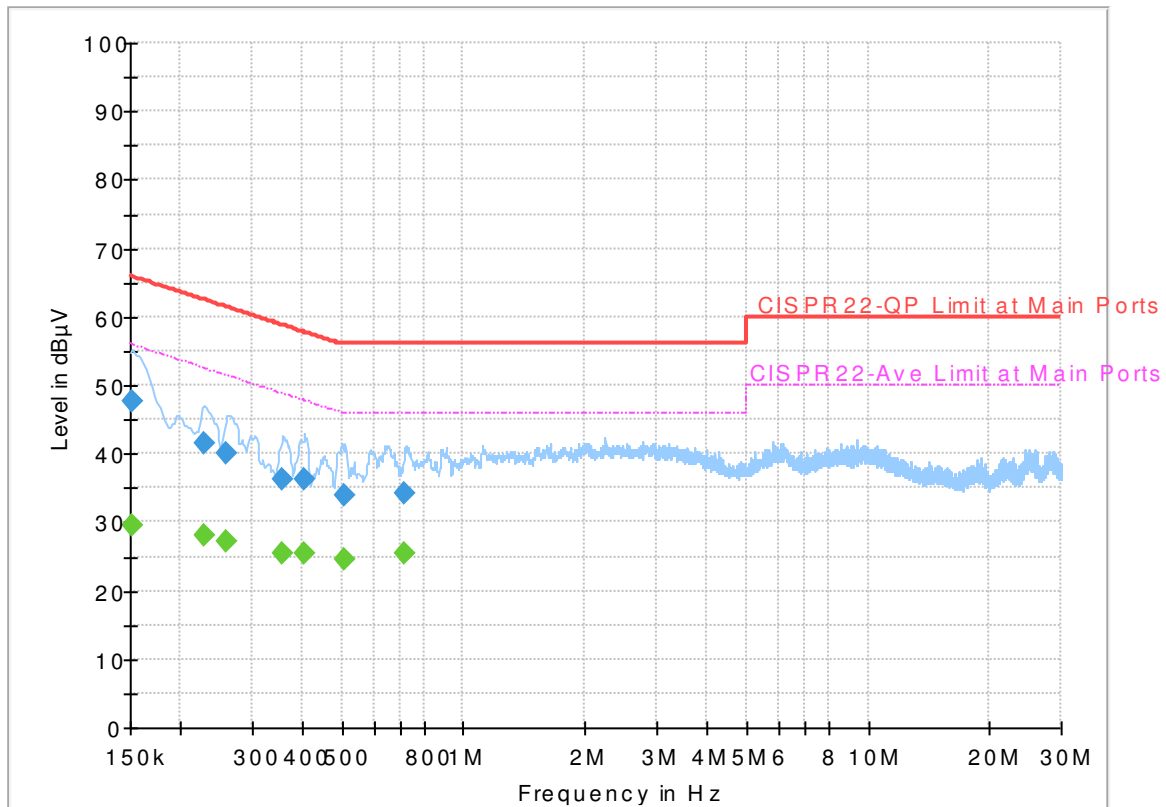

Final Result

| Frequency (MHz) | QuasiPeak (dBµV) | Average (dBµV) | Limit (dBµV) | Margin (dB) | Line | Filter | Corr. (dB) |
|-----------------|------------------|----------------|--------------|-------------|------|--------|------------|
| 0.152250 | --- | 29.43 | 55.88 | 26.45 | N | OFF | 19.5 |
| 0.152250 | 47.78 | --- | 65.88 | 18.10 | N | OFF | 19.5 |
| 0.228750 | --- | 28.17 | 52.50 | 24.33 | N | OFF | 19.5 |
| 0.228750 | 41.40 | --- | 62.50 | 21.10 | N | OFF | 19.5 |
| 0.260250 | --- | 27.12 | 51.42 | 24.30 | N | OFF | 19.5 |
| 0.260250 | 40.19 | --- | 61.42 | 21.23 | N | OFF | 19.5 |
| 0.357000 | --- | 25.51 | 48.80 | 23.29 | N | OFF | 19.5 |
| 0.357000 | 36.31 | --- | 58.80 | 22.49 | N | OFF | 19.5 |
| 0.404250 | --- | 25.55 | 47.77 | 22.22 | N | OFF | 19.5 |
| 0.404250 | 36.19 | --- | 57.77 | 21.58 | N | OFF | 19.5 |
| 0.510000 | --- | 24.63 | 46.00 | 21.37 | N | OFF | 19.5 |
| 0.510000 | 34.06 | --- | 56.00 | 21.94 | N | OFF | 19.5 |
| 0.717000 | --- | 25.42 | 46.00 | 20.58 | N | OFF | 19.5 |
| 0.717000 | 34.14 | --- | 56.00 | 21.86 | N | OFF | 19.5 |



Appendix C. Radiated Spurious Emission

| | | | |
|-----------------|-----------------------------------|---------------------|---------|
| Test Engineer : | Watt Tseng, Karl Hou, and Nick Yu | Temperature : | 21~23°C |
| | | Relative Humidity : | 57~60% |

2.4GHz 2400~2483.5MHz

WIFI 802.11b (Band Edge @ 3m)

| WIFI Ant. | Note | Frequency (MHz) | Level (dBμV/m) | Over Limit (dB) | Limit Line (dBμV/m) | Read Level (dBμV) | Antenna Factor (dB/m) | Path Loss (dB) | Preamp Factor (dB) | Ant Pos (cm) | Table Pos (deg) | Peak Avg. (P/A) | Pol. (H/V) | |
|-----------------------------|------|-------------------|------------------|-------------------|-----------------------|---------------------|-------------------------|------------------|----------------------|----------------|-------------------|-------------------|--------------|---|
| 802.11b CH 01 2412MHz | | 2371.845 | 54.14 | -19.86 | 74 | 44.57 | 27.11 | 14.04 | 31.58 | 316 | 135 | P | H | |
| | | 2389.38 | 41.85 | -12.15 | 54 | 32.22 | 27.15 | 14.06 | 31.58 | 316 | 135 | A | H | |
| | * | 2412 | 107.8 | - | - | 98.1 | 27.19 | 14.08 | 31.57 | 316 | 135 | P | H | |
| | * | 2412 | 103.57 | - | - | 93.87 | 27.19 | 14.08 | 31.57 | 316 | 135 | A | H | |
| | | | | | | | | | | | | | H | |
| | | | 2369.745 | 53.55 | -20.45 | 74 | 43.98 | 27.11 | 14.04 | 31.58 | 188 | 82 | P | V |
| | | | 2389.275 | 42.07 | -11.93 | 54 | 32.44 | 27.15 | 14.06 | 31.58 | 188 | 82 | A | V |
| | * | | 2412 | 109.82 | - | - | 100.12 | 27.19 | 14.08 | 31.57 | 188 | 82 | P | V |
| | * | | 2412 | 105.63 | - | - | 95.93 | 27.19 | 14.08 | 31.57 | 188 | 82 | A | V |
| | | | | | | | | | | | | | | V |
| 802.11b CH 06 2437MHz | | 2370.48 | 53.47 | -20.53 | 74 | 43.9 | 27.11 | 14.04 | 31.58 | 107 | 144 | P | H | |
| | | 2387.98 | 41.31 | -12.69 | 54 | 31.68 | 27.15 | 14.06 | 31.58 | 107 | 144 | A | H | |
| | * | 2437 | 106.44 | - | - | 96.63 | 27.28 | 14.1 | 31.57 | 107 | 144 | P | H | |
| | * | 2437 | 102.22 | - | - | 92.41 | 27.28 | 14.1 | 31.57 | 107 | 144 | A | H | |
| | | | 2492.02 | 53.44 | -20.56 | 74 | 43.45 | 27.4 | 14.14 | 31.55 | 107 | 144 | P | H |
| | | | 2487.33 | 41.65 | -12.35 | 54 | 31.71 | 27.36 | 14.14 | 31.56 | 107 | 144 | A | H |
| | | | 2324.84 | 53.6 | -20.4 | 74 | 44.19 | 26.99 | 14.01 | 31.59 | 137 | 90 | P | V |
| | | | 2389.1 | 41.41 | -12.59 | 54 | 31.78 | 27.15 | 14.06 | 31.58 | 137 | 90 | A | V |
| | * | | 2437 | 109.96 | - | - | 100.15 | 27.28 | 14.1 | 31.57 | 137 | 90 | P | V |
| | * | | 2437 | 105.65 | - | - | 95.84 | 27.28 | 14.1 | 31.57 | 137 | 90 | A | V |
| | | | 2484.95 | 55.81 | -18.19 | 74 | 45.87 | 27.36 | 14.14 | 31.56 | 137 | 90 | P | V |
| | | | 2487.47 | 41.82 | -12.18 | 54 | 31.88 | 27.36 | 14.14 | 31.56 | 137 | 90 | A | V |



| | | | | | | | | | | | | | |
|--|---|---------|--------|--------|----|-------|-------|-------|-------|-----|-----|---|---|
| 802.11b CH 11 2462MHz | * | 2462 | 108.51 | - | - | 98.64 | 27.32 | 14.11 | 31.56 | 302 | 134 | P | H |
| | * | 2462 | 104.29 | - | - | 94.42 | 27.32 | 14.11 | 31.56 | 302 | 134 | A | H |
| | | 2487.44 | 53.79 | -20.21 | 74 | 43.85 | 27.36 | 14.14 | 31.56 | 302 | 134 | P | H |
| | | 2483.52 | 42.27 | -11.73 | 54 | 32.33 | 27.36 | 14.14 | 31.56 | 302 | 134 | A | H |
| | | | | | | | | | | | | | H |
| | | | | | | | | | | | | | H |
| | * | 2462 | 109.33 | - | - | 99.46 | 27.32 | 14.11 | 31.56 | 206 | 80 | P | V |
| | * | 2462 | 105.22 | - | - | 95.35 | 27.32 | 14.11 | 31.56 | 206 | 80 | A | V |
| | | 2489.92 | 54.85 | -19.15 | 74 | 44.87 | 27.4 | 14.14 | 31.56 | 206 | 80 | P | V |
| | | 2483.68 | 42.45 | -11.55 | 54 | 32.51 | 27.36 | 14.14 | 31.56 | 206 | 80 | A | V |
| | | | | | | | | | | | | | V |
| | | | | | | | | | | | | | V |
| Remark | 1. No other spurious found. 2. All results are PASS against Peak and Average limit line. | | | | | | | | | | | | |



**2.4GHz 2400~2483.5MHz
WIFI 802.11b (Harmonic @ 3m)**

| WIFI Ant. 1 | Note | Frequency (MHz) | Level (dBµV/m) | Over Limit (dB) | Limit Line (dBµV/m) | Read Level (dBµV) | Antenna Factor (dB/m) | Path Loss (dB) | Preamp Factor (dB) | Ant Pos (cm) | Table Pos (deg) | Peak Avg. (P/A) | Pol. (H/V) | |
|-----------------------------|---|-------------------|------------------|-------------------|-----------------------|---------------------|-------------------------|------------------|----------------------|----------------|-------------------|-------------------|--------------|---|
| 802.11b CH 01 2412MHz | | 4824 | 44.57 | -29.43 | 74 | 71.25 | 31.36 | 6.7 | 64.74 | 100 | 0 | P | H | |
| | | | | | | | | | | | | | H | |
| | | | | | | | | | | | | | H | |
| | | | | | | | | | | | | | H | |
| | | | 4824 | 42.59 | -31.41 | 74 | 69.27 | 31.36 | 6.7 | 64.74 | 100 | 0 | P | V |
| | | | | | | | | | | | | | | V |
| | | | | | | | | | | | | | | V |
| 802.11b CH 06 2437MHz | | 4874 | 42.39 | -31.61 | 74 | 68.9 | 31.46 | 6.73 | 64.7 | 100 | 0 | P | H | |
| | | 7311 | 44.76 | -29.24 | 74 | 65.4 | 36.11 | 8.07 | 64.82 | 100 | 0 | P | H | |
| | | | | | | | | | | | | | H | |
| | | | | | | | | | | | | | H | |
| | | | 4874 | 42.11 | -31.89 | 74 | 68.62 | 31.46 | 6.73 | 64.7 | 100 | 0 | P | V |
| | | | 7311 | 44.99 | -29.01 | 74 | 65.63 | 36.11 | 8.07 | 64.82 | 100 | 0 | P | V |
| | | | | | | | | | | | | | | V |
| 802.11b CH 11 2462MHz | | 4924 | 45.36 | -28.64 | 74 | 71.73 | 31.56 | 6.73 | 64.66 | 100 | 0 | P | H | |
| | | 7386 | 57.76 | -16.24 | 74 | 78.28 | 36.33 | 8.01 | 64.86 | 241 | 0 | P | H | |
| | | 7386 | 50.89 | -3.11 | 54 | 71.41 | 36.33 | 8.01 | 64.86 | 241 | 0 | A | H | |
| | | | | | | | | | | | | | H | |
| | | | 4924 | 45.32 | -28.68 | 74 | 71.69 | 31.56 | 6.73 | 64.66 | 100 | 0 | P | V |
| | | | 7386 | 55.88 | -18.12 | 74 | 76.4 | 36.33 | 8.01 | 64.86 | 226 | 327 | P | V |
| | | | 7386 | 49.11 | -4.89 | 54 | 69.63 | 36.33 | 8.01 | 64.86 | 226 | 327 | A | V |
| | | | | | | | | | | | | | V | |
| Remark | 1. No other spurious found. 2. All results are PASS against Peak and Average limit line. | | | | | | | | | | | | | |



**2.4GHz 2400~2483.5MHz
WIFI 802.11g (Band Edge @ 3m)**

| WIFI Ant. 1 | Note | Frequency (MHz) | Level (dBμV/m) | Over Limit (dB) | Limit Line (dBμV/m) | Read Level (dBμV) | Antenna Factor (dB/m) | Path Loss (dB) | Preamp Factor (dB) | Ant Pos (cm) | Table Pos (deg) | Peak Avg. (P/A) | Pol. (H/V) | |
|-----------------------------|------|-------------------|------------------|-------------------|-----------------------|---------------------|-------------------------|------------------|----------------------|----------------|-------------------|-------------------|--------------|---|
| 802.11g CH 01 2412MHz | | 2390 | 56.22 | -17.78 | 74 | 46.58 | 27.15 | 14.06 | 31.57 | 315 | 136 | P | H | |
| | | 2390 | 45.83 | -8.17 | 54 | 36.19 | 27.15 | 14.06 | 31.57 | 315 | 136 | A | H | |
| | * | 2412 | 107.17 | - | - | 97.47 | 27.19 | 14.08 | 31.57 | 315 | 136 | P | H | |
| | * | 2412 | 97.34 | - | - | 87.64 | 27.19 | 14.08 | 31.57 | 315 | 136 | A | H | |
| | | | | | | | | | | | | | H | |
| | | | | | | | | | | | | | | H |
| | | | 2389.695 | 58.51 | -15.49 | 74 | 48.88 | 27.15 | 14.06 | 31.58 | 121 | 113 | P | V |
| | | | 2390 | 47.07 | -6.93 | 54 | 37.43 | 27.15 | 14.06 | 31.57 | 121 | 113 | A | V |
| | * | | 2412 | 108.97 | - | - | 99.27 | 27.19 | 14.08 | 31.57 | 121 | 113 | P | V |
| | * | | 2412 | 99.12 | - | - | 89.42 | 27.19 | 14.08 | 31.57 | 121 | 113 | A | V |
| | | | | | | | | | | | | | | V |
| | | | | | | | | | | | | | | V |
| 802.11g CH 06 2437MHz | | 2389.24 | 54.32 | -19.68 | 74 | 44.69 | 27.15 | 14.06 | 31.58 | 307 | 138 | P | H | |
| | | 2389.8 | 42.79 | -11.21 | 54 | 33.15 | 27.15 | 14.06 | 31.57 | 307 | 138 | A | H | |
| | * | 2437 | 108.81 | - | - | 99 | 27.28 | 14.1 | 31.57 | 307 | 138 | P | H | |
| | * | 2437 | 98.78 | - | - | 88.97 | 27.28 | 14.1 | 31.57 | 307 | 138 | A | H | |
| | | | 2484.81 | 60.7 | -13.3 | 74 | 50.76 | 27.36 | 14.14 | 31.56 | 307 | 138 | P | H |
| | | | 2485.16 | 43.49 | -10.51 | 54 | 33.55 | 27.36 | 14.14 | 31.56 | 307 | 138 | A | H |
| | | | 2387.7 | 56.39 | -17.61 | 74 | 46.76 | 27.15 | 14.06 | 31.58 | 212 | 98 | P | V |
| | | | 2389.24 | 43.55 | -10.45 | 54 | 33.92 | 27.15 | 14.06 | 31.58 | 212 | 98 | A | V |
| | * | | 2437 | 109.91 | - | - | 100.1 | 27.28 | 14.1 | 31.57 | 212 | 98 | P | V |
| | * | | 2437 | 100.25 | - | - | 90.44 | 27.28 | 14.1 | 31.57 | 212 | 98 | A | V |
| | | | 2484.04 | 62.08 | -11.92 | 74 | 52.14 | 27.36 | 14.14 | 31.56 | 212 | 98 | P | V |
| | | | 2486.7 | 43.83 | -10.17 | 54 | 33.89 | 27.36 | 14.14 | 31.56 | 212 | 98 | A | V |



| | | | | | | | | | | | | | |
|--|---|---------|--------|--------|----|-------|-------|-------|-------|-----|-----|---|---|
| 802.11g CH 11 2462MHz | * | 2462 | 107.65 | - | - | 97.78 | 27.32 | 14.11 | 31.56 | 301 | 140 | P | H |
| | * | 2462 | 97.9 | - | - | 88.03 | 27.32 | 14.11 | 31.56 | 301 | 140 | A | H |
| | | 2486.68 | 63.35 | -10.65 | 74 | 53.41 | 27.36 | 14.14 | 31.56 | 301 | 140 | P | H |
| | | 2483.56 | 47.23 | -6.77 | 54 | 37.29 | 27.36 | 14.14 | 31.56 | 301 | 140 | A | H |
| | | | | | | | | | | | | | H |
| | | | | | | | | | | | | | H |
| | * | 2462 | 109.12 | - | - | 99.25 | 27.32 | 14.11 | 31.56 | 100 | 111 | P | V |
| | * | 2462 | 98.94 | - | - | 89.07 | 27.32 | 14.11 | 31.56 | 100 | 111 | A | V |
| | | 2488.56 | 63.63 | -10.37 | 74 | 53.65 | 27.4 | 14.14 | 31.56 | 100 | 111 | P | V |
| | | 2483.52 | 47.13 | -6.87 | 54 | 37.19 | 27.36 | 14.14 | 31.56 | 100 | 111 | A | V |
| | | | | | | | | | | | | | V |
| | | | | | | | | | | | | | V |
| Remark | 1. No other spurious found. 2. All results are PASS against Peak and Average limit line. | | | | | | | | | | | | |



**2.4GHz 2400~2483.5MHz
WIFI 802.11g (Harmonic @ 3m)**

| WIFI Ant. 1 | Note | Frequency (MHz) | Level (dBμV/m) | Over Limit (dB) | Limit Line (dBμV/m) | Read Level (dBμV) | Antenna Factor (dB/m) | Path Loss (dB) | Preamp Factor (dB) | Ant Pos (cm) | Table Pos (deg) | Peak Avg. (P/A) | Pol. (H/V) | |
|-----------------------------|---|-------------------|------------------|-------------------|-----------------------|---------------------|-------------------------|------------------|----------------------|----------------|-------------------|-------------------|--------------|---|
| 802.11g CH 01 2412MHz | | 4824 | 41.05 | -32.95 | 74 | 67.73 | 31.36 | 6.7 | 64.74 | 100 | 0 | P | H | |
| | | | | | | | | | | | | | H | |
| | | | | | | | | | | | | | H | |
| | | | | | | | | | | | | | H | |
| | | | 4824 | 40.24 | -33.76 | 74 | 66.92 | 31.36 | 6.7 | 64.74 | 100 | 0 | P | V |
| | | | | | | | | | | | | | | V |
| | | | | | | | | | | | | | | V |
| 802.11g CH 06 2437MHz | | 4874 | 40 | -34 | 74 | 66.51 | 31.46 | 6.73 | 64.7 | 100 | 0 | P | H | |
| | | 7311 | 61.26 | -12.74 | 74 | 81.9 | 36.11 | 8.07 | 64.82 | 244 | 0 | P | H | |
| | | 7311 | 42.96 | -11.04 | 54 | 63.6 | 36.11 | 8.07 | 64.82 | 244 | 0 | A | H | |
| | | | | | | | | | | | | | H | |
| | | | 4874 | 40.17 | -33.83 | 74 | 66.68 | 31.46 | 6.73 | 64.7 | 100 | 0 | P | V |
| | | | 7311 | 59.41 | -14.59 | 74 | 80.05 | 36.11 | 8.07 | 64.82 | 208 | 346 | P | V |
| | | | 7311 | 41.61 | -12.39 | 54 | 62.25 | 36.11 | 8.07 | 64.82 | 208 | 346 | A | V |
| 802.11g CH 11 2462MHz | | 4924 | 41.51 | -32.49 | 74 | 67.88 | 31.56 | 6.73 | 64.66 | 100 | 0 | P | H | |
| | | 7386 | 58.55 | -15.45 | 74 | 79.07 | 36.33 | 8.01 | 64.86 | 239 | 0 | P | H | |
| | | 7386 | 42.04 | -11.96 | 54 | 62.56 | 36.33 | 8.01 | 64.86 | 239 | 0 | A | H | |
| | | | | | | | | | | | | | H | |
| | | | 4924 | 42.18 | -31.82 | 74 | 68.55 | 31.56 | 6.73 | 64.66 | 100 | 0 | P | V |
| | | | 7386 | 55.99 | -18.01 | 74 | 76.51 | 36.33 | 8.01 | 64.86 | 212 | 340 | P | V |
| | | | 7386 | 39.2 | -14.8 | 54 | 59.72 | 36.33 | 8.01 | 64.86 | 212 | 340 | A | V |
| | | | | | | | | | | | | | V | |
| Remark | 1. No other spurious found. 2. All results are PASS against Peak and Average limit line. | | | | | | | | | | | | | |



**2.4GHz 2400~2483.5MHz
WIFI 802.11n HT20 (Band Edge @ 3m)**

| WIFI Ant. 1 | Note | Frequency (MHz) | Level (dBμV/m) | Over Limit (dB) | Limit Line (dBμV/m) | Read Level (dBμV) | Antenna Factor (dB/m) | Path Loss (dB) | Preamp Factor (dB) | Ant Pos (cm) | Table Pos (deg) | Peak Avg. (P/A) | Pol. (H/V) | |
|----------------------------|------|-------------------|------------------|-------------------|-----------------------|---------------------|-------------------------|------------------|----------------------|----------------|-------------------|-------------------|--------------|---|
| 802.11n HT20 CH 01 2412MHz | | 2389.8 | 59.33 | -14.67 | 74 | 49.69 | 27.15 | 14.06 | 31.57 | 314 | 136 | P | H | |
| | | 2390 | 48.48 | -5.52 | 54 | 38.84 | 27.15 | 14.06 | 31.57 | 314 | 136 | A | H | |
| | * | 2412 | 107.18 | - | - | 97.48 | 27.19 | 14.08 | 31.57 | 314 | 136 | P | H | |
| | * | 2412 | 97.38 | - | - | 87.68 | 27.19 | 14.08 | 31.57 | 314 | 136 | A | H | |
| | | | | | | | | | | | | | H | |
| | | | | | | | | | | | | | | H |
| | | | 2388.855 | 61.03 | -12.97 | 74 | 51.4 | 27.15 | 14.06 | 31.58 | 190 | 81 | P | V |
| | | | 2389.905 | 49.86 | -4.14 | 54 | 40.22 | 27.15 | 14.06 | 31.57 | 190 | 81 | A | V |
| | | * | 2412 | 109.15 | - | - | 99.45 | 27.19 | 14.08 | 31.57 | 190 | 81 | P | V |
| | | * | 2412 | 99.15 | - | - | 89.45 | 27.19 | 14.08 | 31.57 | 190 | 81 | A | V |
| | | | | | | | | | | | | | V | |
| | | | | | | | | | | | | | V | |
| 802.11n HT20 CH 06 2437MHz | | 2389.38 | 55.73 | -18.27 | 74 | 46.1 | 27.15 | 14.06 | 31.58 | 308 | 135 | P | H | |
| | | 2388.68 | 42.96 | -11.04 | 54 | 33.33 | 27.15 | 14.06 | 31.58 | 308 | 135 | A | H | |
| | * | 2437 | 108.27 | - | - | 98.46 | 27.28 | 14.1 | 31.57 | 308 | 135 | P | H | |
| | * | 2437 | 98.29 | - | - | 88.48 | 27.28 | 14.1 | 31.57 | 308 | 135 | A | H | |
| | | | 2485.86 | 60.27 | -13.73 | 74 | 50.33 | 27.36 | 14.14 | 31.56 | 308 | 135 | P | H |
| | | | 2484.32 | 43.9 | -10.1 | 54 | 33.96 | 27.36 | 14.14 | 31.56 | 308 | 135 | A | H |
| | | | 2389.52 | 57.27 | -16.73 | 74 | 47.64 | 27.15 | 14.06 | 31.58 | 213 | 82 | P | V |
| | | | 2388.96 | 43.57 | -10.43 | 54 | 33.94 | 27.15 | 14.06 | 31.58 | 213 | 82 | A | V |
| | | * | 2437 | 109.73 | - | - | 99.92 | 27.28 | 14.1 | 31.57 | 213 | 82 | P | V |
| | | * | 2437 | 99.69 | - | - | 89.88 | 27.28 | 14.1 | 31.57 | 213 | 82 | A | V |
| | | 2487.54 | 61.69 | -12.31 | 74 | 51.71 | 27.4 | 14.14 | 31.56 | 213 | 82 | P | V | |
| | | 2483.69 | 44.15 | -9.85 | 54 | 34.21 | 27.36 | 14.14 | 31.56 | 213 | 82 | A | V | |



| | | | | | | | | | | | | | |
|---|---|---------|--------|-------|----|-------|-------|-------|-------|-----|-----|---|---|
| 802.11n HT20 CH 11 2462MHz | * | 2462 | 107.5 | - | - | 97.63 | 27.32 | 14.11 | 31.56 | 302 | 134 | P | H |
| | * | 2462 | 97.63 | - | - | 87.76 | 27.32 | 14.11 | 31.56 | 302 | 134 | A | H |
| | | 2486.32 | 65.59 | -8.41 | 74 | 55.65 | 27.36 | 14.14 | 31.56 | 302 | 134 | P | H |
| | | 2483.6 | 47.77 | -6.23 | 54 | 37.83 | 27.36 | 14.14 | 31.56 | 302 | 134 | A | H |
| | | | | | | | | | | | | | H |
| | | | | | | | | | | | | | H |
| | * | 2462 | 108.68 | - | - | 98.81 | 27.32 | 14.11 | 31.56 | 265 | 82 | P | V |
| | * | 2462 | 99.16 | - | - | 89.29 | 27.32 | 14.11 | 31.56 | 265 | 82 | A | V |
| | | 2485.32 | 65.89 | -8.11 | 74 | 55.95 | 27.36 | 14.14 | 31.56 | 265 | 82 | P | V |
| | | 2483.76 | 48.32 | -5.68 | 54 | 38.38 | 27.36 | 14.14 | 31.56 | 265 | 82 | A | V |
| | | | | | | | | | | | | | V |
| | | | | | | | | | | | | V | |
| Remark | 1. No other spurious found. 2. All results are PASS against Peak and Average limit line. | | | | | | | | | | | | |



**2.4GHz 2400~2483.5MHz
WIFI 802.11n HT20 (Harmonic @ 3m)**

| WIFI Ant. 1 | Note | Frequency (MHz) | Level (dBμV/m) | Over Limit (dB) | Limit Line (dBμV/m) | Read Level (dBμV) | Antenna Factor (dB/m) | Path Loss (dB) | Preamp Factor (dB) | Ant Pos (cm) | Table Pos (deg) | Peak Avg. (P/A) | Pol. (H/V) | |
|-------------------------------|---|-------------------|------------------|-------------------|-----------------------|---------------------|-------------------------|------------------|----------------------|----------------|-------------------|-------------------|--------------|---|
| 802.11n HT20 CH 01 2412MHz | | 4824 | 40.83 | -33.17 | 74 | 67.51 | 31.36 | 6.7 | 64.74 | 100 | 0 | P | H | |
| | | | | | | | | | | | | | H | |
| | | | | | | | | | | | | | H | |
| | | | | | | | | | | | | | H | |
| | | | 4824 | 41.14 | -32.86 | 74 | 67.82 | 31.36 | 6.7 | 64.74 | 100 | 0 | P | V |
| | | | | | | | | | | | | | | V |
| | | | | | | | | | | | | | | V |
| 802.11n HT20 CH 06 2437MHz | | 4874 | 40.82 | -33.18 | 74 | 67.33 | 31.46 | 6.73 | 64.7 | 100 | 0 | P | H | |
| | | 7311 | 63.26 | -10.74 | 74 | 83.9 | 36.11 | 8.07 | 64.82 | 242 | 0 | P | H | |
| | | 7311 | 42.31 | -11.69 | 54 | 62.95 | 36.11 | 8.07 | 64.82 | 242 | 0 | A | H | |
| | | | | | | | | | | | | | H | |
| | | | 4874 | 41.01 | -32.99 | 74 | 67.52 | 31.46 | 6.73 | 64.7 | 100 | 0 | P | V |
| | | | 7311 | 61.04 | -12.96 | 74 | 81.68 | 36.11 | 8.07 | 64.82 | 207 | 345 | P | V |
| | | | 7311 | 40.41 | -13.59 | 54 | 61.05 | 36.11 | 8.07 | 64.82 | 207 | 345 | A | V |
| | | | | | | | | | | | | | V | |
| 802.11n HT20 CH 11 2462MHz | | 4924 | 42.11 | -31.89 | 74 | 68.48 | 31.56 | 6.73 | 64.66 | 100 | 0 | P | H | |
| | | 7386 | 59.97 | -14.03 | 74 | 80.49 | 36.33 | 8.01 | 64.86 | 236 | 0 | P | H | |
| | | 7386 | 41.08 | -12.92 | 54 | 61.6 | 36.33 | 8.01 | 64.86 | 236 | 0 | A | H | |
| | | | | | | | | | | | | | H | |
| | | | 4924 | 41.49 | -32.51 | 74 | 67.86 | 31.56 | 6.73 | 64.66 | 100 | 0 | P | V |
| | | | 7386 | 57.77 | -16.23 | 74 | 78.29 | 36.33 | 8.01 | 64.86 | 209 | 316 | P | V |
| | | | 7386 | 38.55 | -15.45 | 54 | 59.07 | 36.33 | 8.01 | 64.86 | 209 | 316 | A | V |
| | | | | | | | | | | | | | V | |
| Remark | 1. No other spurious found. 2. All results are PASS against Peak and Average limit line. | | | | | | | | | | | | | |



Emission below 1GHz
2.4GHz WIFI 802.11b (LF)

| WIFI | Note | Frequency | Level | Over | Limit | Read | Antenna | Path | Preamp | Ant | Table | Peak | Pol. | |
|-------------------------|--|-----------|------------|--------|------------|----------|----------|--------|--------|--------|---------|-------|-------|---|
| Ant. | | | | Limit | Line | Level | Factor | Loss | Factor | Pos | Pos | Avg. | | |
| 1 | | (MHz) | (dBμV/m) | (dB) | (dBμV/m) | (dBμV) | (dB/m) | (dB) | (dB) | (cm) | (deg) | (P/A) | (H/V) | |
| 2.4GHz 802.11b LF | | 30.27 | 23.75 | -16.25 | 40 | 29.1 | 24.39 | 0.44 | 30.18 | | | P | H | |
| | | 93.45 | 21.37 | -22.13 | 43.5 | 35.56 | 15.36 | 0.86 | 30.41 | | | P | H | |
| | | 254.37 | 23.37 | -22.63 | 46 | 32.89 | 19.24 | 1.44 | 30.2 | | | P | H | |
| | | 560.4 | 28.26 | -17.74 | 46 | 29.96 | 25.98 | 2.03 | 29.71 | | | P | H | |
| | | 747.3 | 31.08 | -14.92 | 46 | 30.26 | 27.95 | 2.31 | 29.44 | 100 | 0 | P | H | |
| | | 971.3 | 34.6 | -19.4 | 54 | 29.99 | 30.89 | 2.74 | 29.02 | | | P | H | |
| | | | | | | | | | | | | | H | |
| | | | | | | | | | | | | | H | |
| | | | | | | | | | | | | | H | |
| | | | | | | | | | | | | | H | |
| | | | | | | | | | | | | | H | |
| | | | | | | | | | | | | | H | |
| | | | 36.75 | 24.99 | -15.01 | 40 | 33.56 | 21.24 | 0.46 | 30.27 | | | P | V |
| | | | 123.96 | 22.42 | -21.08 | 43.5 | 34.33 | 17.53 | 0.93 | 30.37 | | | P | V |
| | | | 263.82 | 21.87 | -24.13 | 46 | 30.81 | 19.79 | 1.46 | 30.19 | | | P | V |
| | | | 478.5 | 25.33 | -20.67 | 46 | 29.7 | 23.63 | 1.83 | 29.83 | | | P | V |
| | | | 742.4 | 40.68 | -5.32 | 46 | 39.93 | 27.89 | 2.31 | 29.45 | 100 | 0 | P | V |
| | | | 965.7 | 35.27 | -18.73 | 54 | 30.54 | 31.02 | 2.74 | 29.03 | | | P | V |
| | | | | | | | | | | | | | V | |
| | | | | | | | | | | | | | V | |
| | | | | | | | | | | | | V | | |
| | | | | | | | | | | | | V | | |
| | | | | | | | | | | | | V | | |
| | | | | | | | | | | | | V | | |
| Remark | 1. No other spurious found. 2. All results are PASS against limit line. | | | | | | | | | | | | | |



Note symbol

| | |
|-----|--|
| * | Fundamental Frequency which can be ignored. However, the level of any unwanted emissions shall not exceed the level of the fundamental frequency. |
| ! | Test result is over limit line. |
| P/A | Peak or Average |
| H/V | Horizontal or Vertical |



A calculation example for radiated spurious emission is shown as below:

| WIFI | Note | Frequency | Level | Over | Limit | Read | Antenna | Path | Preamp | Ant | Table | Peak | Pol. |
|---------|------|-----------|------------|--------|------------|----------|----------|--------|--------|--------|---------|---------|---------|
| Ant. | | | | Limit | Line | Level | Factor | Loss | Factor | Pos | Pos | Avg. | |
| 1 | | (MHz) | (dBμV/m) | (dB) | (dBμV/m) | (dBμV) | (dB/m) | (dB) | (dB) | (cm) | (deg) | (P/A) | (H/V) |
| 802.11b | | 2390 | 55.45 | -18.55 | 74 | 54.51 | 32.22 | 4.58 | 35.86 | 103 | 308 | P | H |
| CH 01 | | | | | | | | | | | | | |
| 2412MHz | | 2390 | 43.54 | -10.46 | 54 | 42.6 | 32.22 | 4.58 | 35.86 | 103 | 308 | A | H |

1. Path Loss(dB) = Cable loss(dB) + Filter loss(dB) + Attenuator loss(dB)
2. Level(dBμV/m) =
Antenna Factor(dB/m) + Path Loss(dB) + Read Level(dBμV) - Preamp Factor(dB)
3. Over Limit(dB) = Level(dBμV/m) – Limit Line(dBμV/m)

For Peak Limit @ 2390MHz:

1. Level(dBμV/m)
= Antenna Factor(dB/m) + Path Loss(dB) + Read Level(dBμV) - Preamp Factor(dB)
= 32.22(dB/m) + 4.58(dB) + 54.51(dBμV) – 35.86 (dB)
= 55.45 (dBμV/m)
2. Over Limit(dB)
= Level(dBμV/m) – Limit Line(dBμV/m)
= 55.45(dBμV/m) – 74(dBμV/m)
= -18.55(dB)

For Average Limit @ 2390MHz:

1. Level(dBμV/m)
= Antenna Factor(dB/m) + Path Loss(dB) + Read Level(dBμV) - Preamp Factor(dB)
= 32.22(dB/m) + 4.58(dB) + 42.6(dBμV) – 35.86 (dB)
= 43.54 (dBμV/m)
2. Over Limit(dB)
= Level(dBμV/m) – Limit Line(dBμV/m)
= 43.54(dBμV/m) – 54(dBμV/m)
= -10.46(dB)

Both peak and average measured complies with the limit line, so test result is “PASS”.



Appendix D. Radiated Spurious Emission Plots

| | | | |
|-----------------|-----------------------------------|---------------------|---------|
| Test Engineer : | Watt Tseng, Karl Hou, and Nick Yu | Temperature : | 21~23°C |
| | | Relative Humidity : | 57~60% |

Note symbol

| | |
|----|-----------------------|
| -L | Low channel location |
| -R | High channel location |



2.4GHz 2400~2483.5MHz
WIFI 802.11b (Band Edge @ 3m)

Table with 4 columns: WIFI, ANT, 1, and two sub-columns for Horizontal and Fundamental. Rows are labeled Peak and Avg. Each cell contains a spectral plot with technical details like Site, Condition, and Date.



| WIFI | 2.4GHz 2400~2483.5MHz Band Edge @ 3m | |
|-------------|---|--|
| ANT | 802.11b CH01 2412MHz | |
| 1 | Vertical | Fundamental |
| Peak | <p>Site : 03CH12-HY Condition : PEAK_BE_74 3m HORN_9120D_1328 VERTICAL : RBW:1000.000kHz VBW:3000.000kHz SWT:Auto</p> | <p>Site : 03CH12-HY Condition : PEAK_74 3m HORN_9120D_1328 VERTICAL : RBW:1000.000kHz VBW:3000.000kHz SWT:Auto</p> |
| Avg. | <p>Site : 03CH12-HY Condition : AVG_BE_54 3m HORN_9120D_1328 VERTICAL : RBW:1000.000kHz VBW:0.010kHz SWT:Auto</p> | <p>Site : 03CH12-HY Condition : AVG_54 3m HORN_9120D_1328 VERTICAL : RBW:1000.000kHz VBW:0.010kHz SWT:Auto</p> |

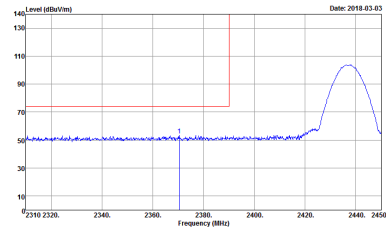
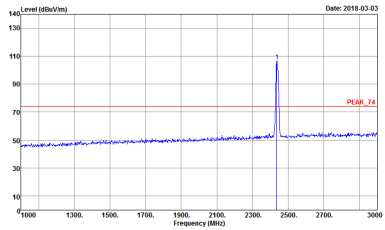
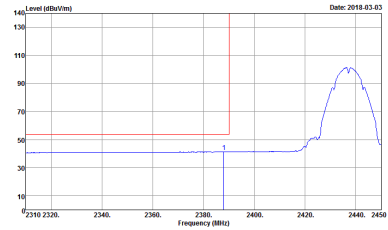
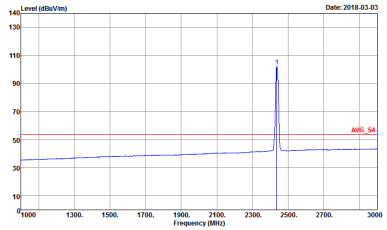

| WIFI | 2.4GHz 2400~2483.5MHz Band Edge @ 3m | |
|-------------|---|---|
| ANT | 802.11b CH06 2437MHz - L | |
| 1 | Horizontal | Fundamental |
| Peak |  <p>Site : 03CH12-HY Condition : PEAK_BE_74 3m HORN_91200_1328 HORIZONTAL : RBW:1000.000kHz VBW:3000.000kHz SWT:Auto</p> |  <p>Site : 03CH12-HY Condition : PEAK_74 3m HORN_91200_1328 HORIZONTAL : RBW:1000.000kHz VBW:3000.000kHz SWT:Auto</p> |
| Avg. |  <p>Site : 03CH12-HY Condition : AVG_BE_54 3m HORN_91200_1328 HORIZONTAL : RBW:1000.000kHz VBW:0.010kHz SWT:Auto</p> |  <p>Site : 03CH12-HY Condition : AVG_54 3m HORN_91200_1328 HORIZONTAL : RBW:1000.000kHz VBW:0.010kHz SWT:Auto</p> |



| WIFI | 2.4GHz 2400~2483.5MHz Band Edge @ 3m | |
|------|---|-------------|
| ANT | 802.11b CH06 2437MHz - R | |
| 1 | Horizontal | Fundamental |
| Peak | <p>Site : 03CH12-HY Condition : PEAK_BE_74 3m HORN_9120D_1328 HORIZONTAL : RBW:1000.000kHz VBW:3000.000kHz SWT:Auto</p> | Left blank |
| Avg. | <p>Site : 03CH12-HY Condition : AVG_BE_54 3m HORN_9120D_1328 HORIZONTAL : RBW:1000.000kHz VBW:0.010kHz SWT:Auto</p> | Left blank |



| WIFI | 2.4GHz 2400~2483.5MHz Band Edge @ 3m | |
|------|---|--|
| ANT | 802.11b CH06 2437MHz - L | |
| 1 | Vertical | Fundamental |
| Peak | <p>Site : 03CH12-HY Condition : PEAK_BE_74 3m HORN_9120D_1328 VERTICAL : RBW:1000.000kHz VBW:3000.000kHz SWT:Auto</p> | <p>Site : 03CH12-HY Condition : PEAK_74 3m HORN_9120D_1328 VERTICAL : RBW:1000.000kHz VBW:3000.000kHz SWT:Auto</p> |
| Avg. | <p>Site : 03CH12-HY Condition : AVG_BE_54 3m HORN_9120D_1328 VERTICAL : RBW:1000.000kHz VBW:0.010kHz SWT:Auto</p> | <p>Site : 03CH12-HY Condition : AVG_54 3m HORN_9120D_1328 VERTICAL : RBW:1000.000kHz VBW:0.010kHz SWT:Auto</p> |



| WIFI | 2.4GHz 2400~2483.5MHz Band Edge @ 3m | |
|------|---|-------------|
| ANT | 802.11b CH06 2437MHz - R | |
| 1 | Vertical | Fundamental |
| Peak | <p>Site : 03CH12-HY Condition : PEAK_BE_74 3m HORN_9120D_1328 VERTICAL : RBW:1000.000kHz VBW:3000.000kHz SWT:Auto</p> | Left blank |
| Avg. | <p>Site : 03CH12-HY Condition : AVG_BE_54 3m HORN_9120D_1328 VERTICAL : RBW:1000.000kHz VBW:0.010kHz SWT:Auto</p> | Left blank |

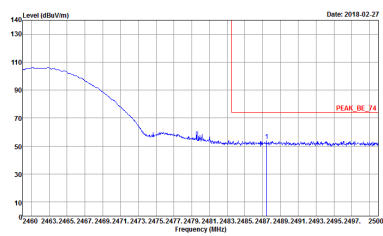
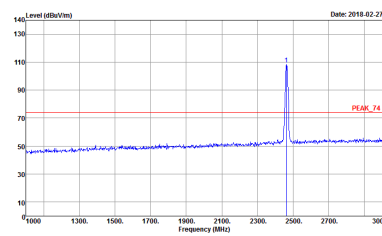
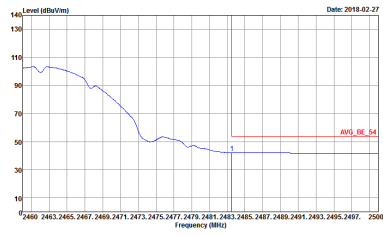
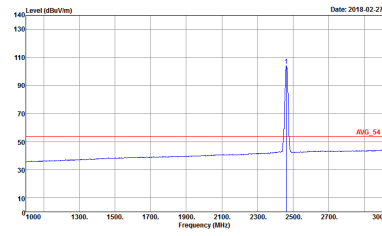

| WIFI | 2.4GHz 2400~2483.5MHz Band Edge @ 3m | |
|------|---|---|
| ANT | 802.11b CH11 2462MHz | |
| 1 | Horizontal | Fundamental |
| Peak |  <p>Site : 03CH12-HY Condition : PEAK_BE_74 3m HORN_9120D_1328 HORIZONTAL : RBW:1000.000kHz VBW:3000.000kHz SWT:Auto</p> |  <p>Site : 03CH12-HY Condition : PEAK_74 3m HORN_9120D_1328 HORIZONTAL : RBW:1000.000kHz VBW:3000.000kHz SWT:Auto</p> |
| Avg. |  <p>Site : 03CH12-HY Condition : AVG_BE_54 3m HORN_9120D_1328 HORIZONTAL : RBW:1000.000kHz VBW:0.010kHz SWT:Auto</p> |  <p>Site : 03CH12-HY Condition : AVG_54 3m HORN_9120D_1328 HORIZONTAL : RBW:1000.000kHz VBW:0.010kHz SWT:Auto</p> |



| WIFI | 2.4GHz 2400~2483.5MHz Band Edge @ 3m | |
|------|---|--|
| ANT | 802.11b CH11 2462MHz | |
| 1 | Vertical | Fundamental |
| Peak | <p>Site : 03CH12-HY Condition : PEAK_BE_74 3m HORN_9120D_1328 VERTICAL : RBW:1000.000KHz VBW:3000.000KHz SWT:Auto</p> | <p>Site : 03CH12-HY Condition : PEAK_74 3m HORN_9120D_1328 VERTICAL : RBW:1000.000KHz VBW:3000.000KHz SWT:Auto</p> |
| Avg. | <p>Site : 03CH12-HY Condition : AVG_BE_54 3m HORN_9120D_1328 VERTICAL : RBW:1000.000KHz VBW:0.010KHz SWT:Auto</p> | <p>Site : 03CH12-HY Condition : AVG_54 3m HORN_9120D_1328 VERTICAL : RBW:1000.000KHz VBW:0.010KHz SWT:Auto</p> |

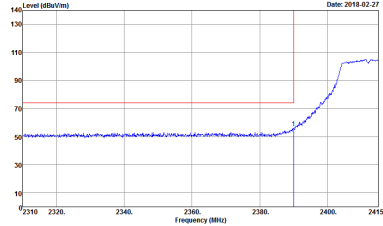
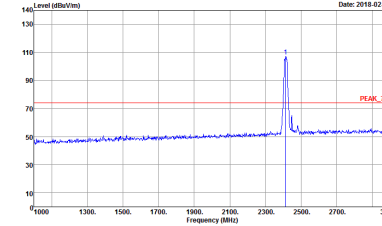
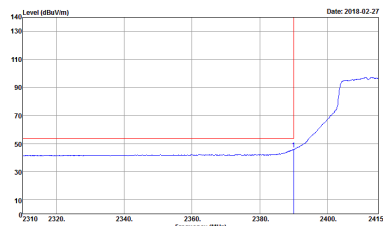
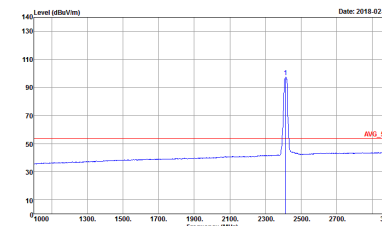

2.4GHz 2400~2483.5MHz
WIFI 802.11g (Band Edge @ 3m)

| WIFI | 2.4GHz 2400~2483.5MHz Band Edge @ 3m | |
|------|---|---|
| ANT | 802.11g CH01 2412MHz | |
| 1 | Horizontal | Fundamental |
| Peak |  <p>Site : 03CH12-HY Condition : PEAK_BE_74 3m HORN_9120D_1328 HORIZONTAL RBW:1000.000kHz VBW:3000.000kHz SWT:Auto</p> |  <p>Site : 03CH12-HY Condition : PEAK_74 3m HORN_9120D_1328 HORIZONTAL RBW:1000.000kHz VBW:3000.000kHz SWT:Auto</p> |
| Avg. |  <p>Site : 03CH12-HY Condition : AVG_BE_54 3m HORN_9120D_1328 HORIZONTAL RBW:1000.000kHz VBW:1.000kHz SWT:Auto</p> |  <p>Site : 03CH12-HY Condition : AVG_54 3m HORN_9120D_1328 HORIZONTAL RBW:1000.000kHz VBW:1.000kHz SWT:Auto</p> |



| WIFI | 2.4GHz 2400~2483.5MHz Band Edge @ 3m | |
|-------------|---|--|
| ANT | 802.11g CH01 2412MHz | |
| 1 | Vertical | Fundamental |
| Peak | <p>Site : 03CH12-HY Condition : PEAK_BE_74 3m HORN_91200_1328 VERTICAL : RBW:1000.000kHz VBW:3000.000kHz SWT:Auto</p> | <p>Site : 03CH12-HY Condition : PEAK_74 3m HORN_91200_1328 VERTICAL : RBW:1000.000kHz VBW:3000.000kHz SWT:Auto</p> |
| Avg. | <p>Site : 03CH12-HY Condition : AVG_BE_54 3m HORN_91200_1328 VERTICAL : RBW:1000.000kHz VBW:1.000kHz SWT:Auto</p> | <p>Site : 03CH12-HY Condition : AVG_54 3m HORN_91200_1328 VERTICAL : RBW:1000.000kHz VBW:1.000kHz SWT:Auto</p> |

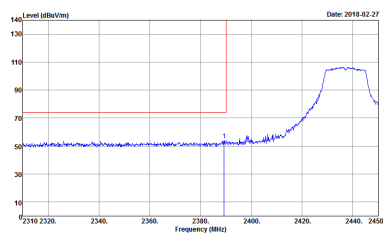
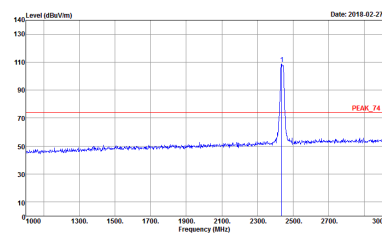
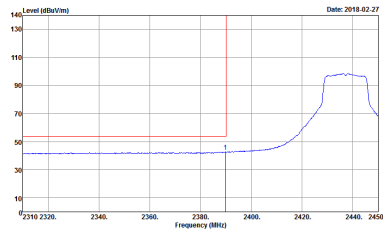
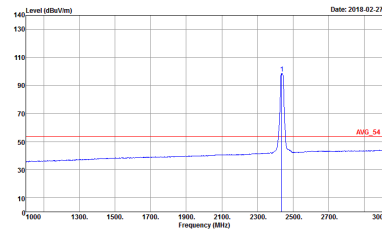

| WIFI | 2.4GHz 2400~2483.5MHz Band Edge @ 3m | |
|-------------|---|---|
| ANT | 802.11g CH06 2437MHz - L | |
| 1 | Horizontal | Fundamental |
| Peak |  <p>Site : 03CH12-HY Condition : PEAK_BE_74 3m HORN_91200_1328 HORIZONTAL : RBW:1000.000kHz VBW:3000.000kHz SWT:Auto</p> |  <p>Site : 03CH12-HY Condition : PEAK_74 3m HORN_91200_1328 HORIZONTAL : RBW:1000.000kHz VBW:3000.000kHz SWT:Auto</p> |
| Avg. |  <p>Site : 03CH12-HY Condition : AVG_BE_54 3m HORN_91200_1328 HORIZONTAL : RBW:1000.000kHz VBW:1.000kHz SWT:Auto</p> |  <p>Site : 03CH12-HY Condition : AVG_54 3m HORN_91200_1328 HORIZONTAL : RBW:1000.000kHz VBW:1.000kHz SWT:Auto</p> |



| WIFI | 2.4GHz 2400~2483.5MHz Band Edge @ 3m | |
|------|---|-------------|
| ANT | 802.11g CH06 2437MHz - R | |
| 1 | Horizontal | Fundamental |
| Peak | <p>Site : 03CH12-HY Condition : PEAK_BE_74 3m HORN_9120D_1328 HORIZONTAL : RBW:1000.000KHz VBW:3000.000KHz SWT:Auto</p> | Left blank |
| Avg. | <p>Site : 03CH12-HY Condition : AVG_BE_54 3m HORN_9120D_1328 HORIZONTAL : RBW:1000.000KHz VBW:1.000KHz SWT:Auto</p> | Left blank |



| WIFI | 2.4GHz 2400~2483.5MHz Band Edge @ 3m | |
|------|---|--|
| ANT | 802.11g CH06 2437MHz - L | |
| 1 | Vertical | Fundamental |
| Peak | <p>Site : 03CH12-HY Condition : PEAK_BE_74 3m HORN_9120D_1328 VERTICAL : RBW:1000.000KHz VBW:3000.000KHz SWT:Auto</p> | <p>Site : 03CH12-HY Condition : PEAK_74 3m HORN_9120D_1328 VERTICAL : RBW:1000.000KHz VBW:3000.000KHz SWT:Auto</p> |
| Avg. | <p>Site : 03CH12-HY Condition : AVG_BE_54 3m HORN_9120D_1328 VERTICAL : RBW:1000.000KHz VBW:1.000KHz SWT:Auto</p> | <p>Site : 03CH12-HY Condition : AVG_54 3m HORN_9120D_1328 VERTICAL : RBW:1000.000KHz VBW:1.000KHz SWT:Auto</p> |

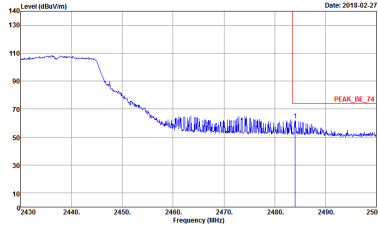
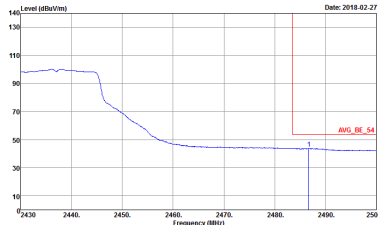

| WIFI | 2.4GHz 2400~2483.5MHz Band Edge @ 3m | |
|--------------------|---|-------------------|
| ANT | 802.11g CH06 2437MHz - R | |
| 1 | Vertical | Fundamental |
| <p>Peak</p> |  <p>Site : 03CH12-HY Condition : PEAK_BE_74 3m HORN_9120D_1328 VERTICAL : RBW:1000.000KHz VBW:3000.000KHz SWT:Auto</p> | <p>Left Blank</p> |
| <p>Avg.</p> |  <p>Site : 03CH12-HY Condition : AVG_BE_54 3m HORN_9120D_1328 VERTICAL : RBW:1000.000KHz VBW:1.000KHz SWT:Auto</p> | <p>Left Blank</p> |



| WIFI | 2.4GHz 2400~2483.5MHz Band Edge @ 3m | |
|------|---|--|
| ANT | 802.11g CH11 2462MHz | |
| 1 | Horizontal | Fundamental |
| Peak | <p>Site : 03CH12-HY Condition : PEAK_BE_74 3m HORN_9120D_1328 HORIZONTAL : RBW:1000.000kHz VBW:3000.000kHz SWT:Auto</p> | <p>Site : 03CH12-HY Condition : PEAK_74 3m HORN_9120D_1328 HORIZONTAL : RBW:1000.000kHz VBW:3000.000kHz SWT:Auto</p> |
| Avg. | <p>Site : 03CH12-HY Condition : AVG_BE_54 3m HORN_9120D_1328 HORIZONTAL : RBW:1000.000kHz VBW:1.000kHz SWT:Auto</p> | <p>Site : 03CH12-HY Condition : AVG_54 3m HORN_9120D_1328 HORIZONTAL : RBW:1000.000kHz VBW:1.000kHz SWT:Auto</p> |



| WIFI | 2.4GHz 2400~2483.5MHz Band Edge @ 3m | |
|------|---|--|
| ANT | 802.11g CH11 2462MHz | |
| 1 | Vertical | Fundamental |
| Peak | <p>Site : 03CH12-HY Condition : PEAK_BE_74 3m HORN_9120D_1328 VERTICAL : RBW:1000.000KHz VBW:3000.000KHz SWT:Auto</p> | <p>Site : 03CH12-HY Condition : PEAK_74 3m HORN_9120D_1328 VERTICAL : RBW:1000.000KHz VBW:3000.000KHz SWT:Auto</p> |
| Avg. | <p>Site : 03CH12-HY Condition : AVG_BE_54 3m HORN_9120D_1328 VERTICAL : RBW:1000.000KHz VBW:1.000KHz SWT:Auto</p> | <p>Site : 03CH12-HY Condition : AVG_54 3m HORN_9120D_1328 VERTICAL : RBW:1000.000KHz VBW:1.000KHz SWT:Auto</p> |

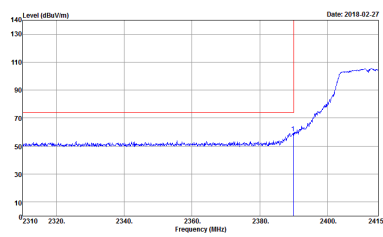
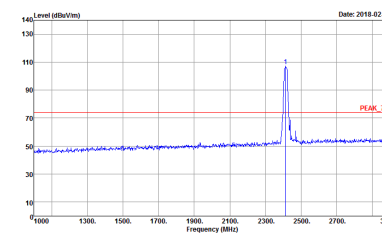
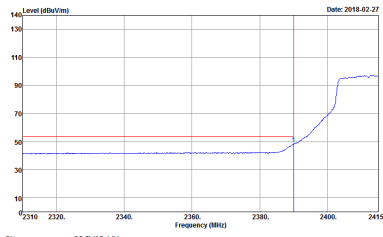
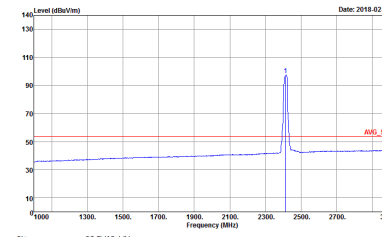

2.4GHz 2400~2483.5MHz
WIFI 802.11n HT20 (Band Edge @ 3m)

| WIFI | 2.4GHz 2400~2483.5MHz Band Edge @ 3m | |
|-------------|---|---|
| ANT | 802.11n HT20 CH01 2412MHz | |
| 1 | Horizontal | Fundamental |
| Peak |  <p>Site : 03CH12-HY Condition : PEAK_BE_74 3m HORN_9120D_1328 HORIZONTAL : RBW:1000.000kHz VBW:3000.000kHz SWT:Auto</p> |  <p>Site : 03CH12-HY Condition : PEAK_74 3m HORN_9120D_1328 HORIZONTAL : RBW:1000.000kHz VBW:3000.000kHz SWT:Auto</p> |
| Avg. |  <p>Site : 03CH12-HY Condition : AVG_BE_54 3m HORN_9120D_1328 HORIZONTAL : RBW:1000.000kHz VBW:1.000kHz SWT:Auto</p> |  <p>Site : 03CH12-HY Condition : AVG_54 3m HORN_9120D_1328 HORIZONTAL : RBW:1000.000kHz VBW:1.000kHz SWT:Auto</p> |



| WIFI | 2.4GHz 2400~2483.5MHz Band Edge @ 3m | |
|-------------|---|--|
| ANT | 802.11n HT20 CH01 2412MHz | |
| 1 | Vertical | Fundamental |
| Peak | <p>Site : 03CH12-HY Condition : PEAK_BE_74 3m HORN_91200_1328 VERTICAL : RBW:1000.000kHz VBW:3000.000kHz SWT:Auto</p> | <p>Site : 03CH12-HY Condition : PEAK_74 3m HORN_91200_1328 VERTICAL : RBW:1000.000kHz VBW:3000.000kHz SWT:Auto</p> |
| Avg. | <p>Site : 03CH12-HY Condition : AVG_BE_54 3m HORN_91200_1328 VERTICAL : RBW:1000.000kHz VBW:1.000kHz SWT:Auto</p> | <p>Site : 03CH12-HY Condition : AVG_54 3m HORN_91200_1328 VERTICAL : RBW:1000.000kHz VBW:1.000kHz SWT:Auto</p> |

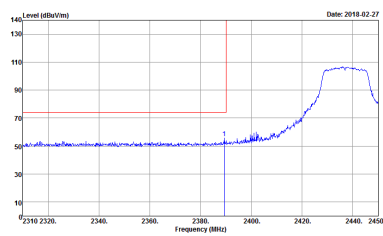
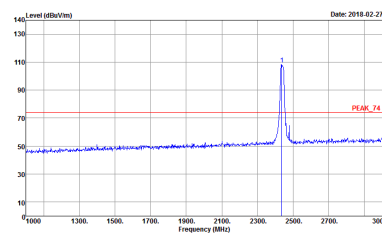
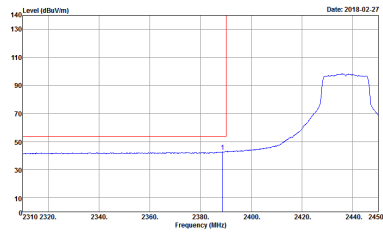
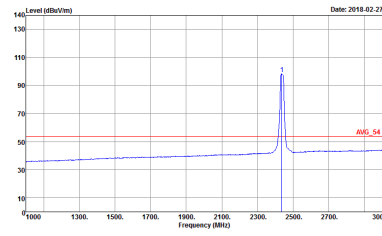

| WIFI | 2.4GHz 2400~2483.5MHz Band Edge @ 3m | |
|------|---|---|
| ANT | 802.11n HT20 CH06 2437MHz - L | |
| 1 | Horizontal | Fundamental |
| Peak |  <p>Site : 03CH12-HY Condition : PEAK_BE_74 3m HORN_9120D_1328 HORIZONTAL : RBW:1000.000kHz VBW:3000.000kHz SWT:Auto</p> |  <p>Site : 03CH12-HY Condition : PEAK_74 3m HORN_9120D_1328 HORIZONTAL : RBW:1000.000kHz VBW:3000.000kHz SWT:Auto</p> |
| Avg. |  <p>Site : 03CH12-HY Condition : AVG_BE_54 3m HORN_9120D_1328 HORIZONTAL : RBW:1000.000kHz VBW:1.000kHz SWT:Auto</p> |  <p>Site : 03CH12-HY Condition : AVG_54 3m HORN_9120D_1328 HORIZONTAL : RBW:1000.000kHz VBW:1.000kHz SWT:Auto</p> |



| WIFI | 2.4GHz 2400~2483.5MHz Band Edge @ 3m | |
|------|--------------------------------------|-------------|
| ANT | 802.11n HT20 CH06 2437MHz - R | |
| 1 | Horizontal | Fundamental |
| Peak | | Left blank |
| Avg. | | Left blank |

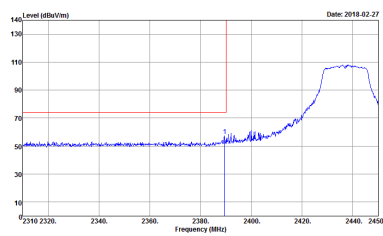
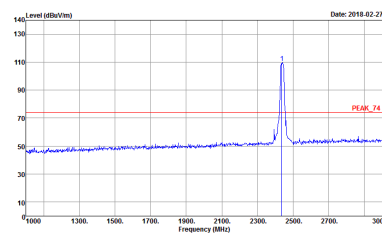
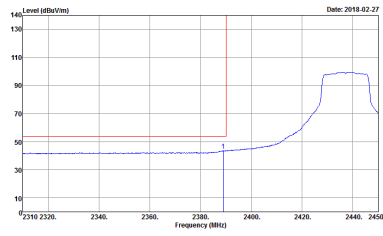
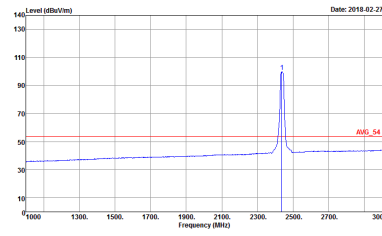

| WIFI | 2.4GHz 2400~2483.5MHz Band Edge @ 3m | |
|------|---|---|
| ANT | 802.11n HT20 CH06 2437MHz - L | |
| 1 | Vertical | Fundamental |
| Peak |  <p>Site : 03CH12-HY Condition : PEAK_BE_74 3m HORN_9120D_1328 VERTICAL : RBW:1000.000kHz VBW:3000.000kHz SWT:Auto</p> |  <p>Site : 03CH12-HY Condition : PEAK_74 3m HORN_9120D_1328 VERTICAL : RBW:1000.000kHz VBW:3000.000kHz SWT:Auto</p> |
| Avg. |  <p>Site : 03CH12-HY Condition : AVG_BE_54 3m HORN_9120D_1328 VERTICAL : RBW:1000.000kHz VBW:1.000kHz SWT:Auto</p> |  <p>Site : 03CH12-HY Condition : AVG_54 3m HORN_9120D_1328 VERTICAL : RBW:1000.000kHz VBW:1.000kHz SWT:Auto</p> |

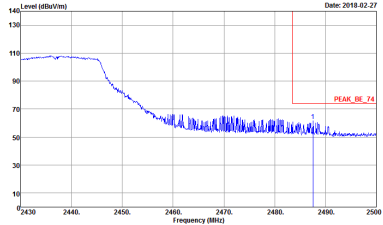
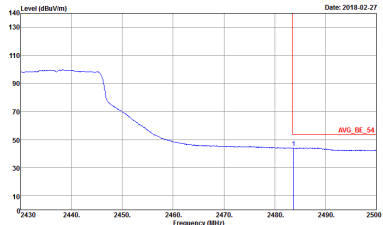

| WIFI | 2.4GHz 2400~2483.5MHz Band Edge @ 3m | |
|--------------------|---|-------------------|
| ANT | 802.11n HT20 CH06 2437MHz - R | |
| 1 | Vertical | Fundamental |
| <p>Peak</p> |  <p>Site : 03CH12-HY Condition : PEAK_BE_74 3m HORN_9120D_1328 VERTICAL : RBW:1000.000KHz VBW:3000.000KHz SWT:Auto</p> | <p>Left Blank</p> |
| <p>Avg.</p> |  <p>Site : 03CH12-HY Condition : AVG_BE_54 3m HORN_9120D_1328 VERTICAL : RBW:1000.000KHz VBW:1.000KHz SWT:Auto</p> | <p>Left Blank</p> |

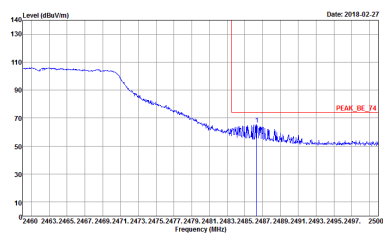
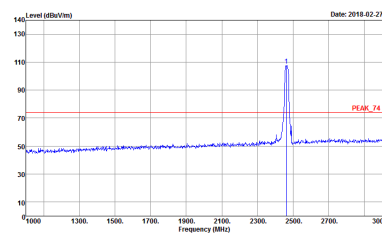
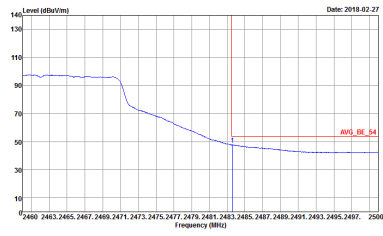
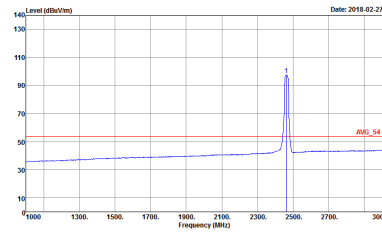

| WIFI | 2.4GHz 2400~2483.5MHz Band Edge @ 3m | |
|------|---|---|
| ANT | 802.11n HT20 CH11 2462MHz | |
| 1 | Horizontal | Fundamental |
| Peak |  <p>Site : 03CH12-HY Condition : PEAK_BE_74 3m HORN_9120D_1328 HORIZONTAL : RBW:1000.000kHz VBW:3000.000kHz SWT:Auto</p> |  <p>Site : 03CH12-HY Condition : PEAK_74 3m HORN_9120D_1328 HORIZONTAL : RBW:1000.000kHz VBW:3000.000kHz SWT:Auto</p> |
| Avg. |  <p>Site : 03CH12-HY Condition : AVG_BE_54 3m HORN_9120D_1328 HORIZONTAL : RBW:1000.000kHz VBW:1.000kHz SWT:Auto</p> |  <p>Site : 03CH12-HY Condition : AVG_54 3m HORN_9120D_1328 HORIZONTAL : RBW:1000.000kHz VBW:1.000kHz SWT:Auto</p> |



| WIFI | 2.4GHz 2400~2483.5MHz Fundamental @ 3m | |
|------|---|--|
| ANT | 802.11n HT20 CH11 2462MHz | |
| 1 | Vertical | Fundamental |
| Peak | <p>Site : 03CH12-HY Condition : PEAK_BE_74 3m HORN_9120D_1328 VERTICAL : RBW:1000.000KHz VBW:3000.000KHz SWT:Auto</p> | <p>Site : 03CH12-HY Condition : PEAK_74 3m HORN_9120D_1328 VERTICAL : RBW:1000.000KHz VBW:3000.000KHz SWT:Auto</p> |
| Avg. | <p>Site : 03CH12-HY Condition : AVG_BE_54 3m HORN_9120D_1328 VERTICAL : RBW:1000.000KHz VBW:1.000KHz SWT:Auto</p> | <p>Site : 03CH12-HY Condition : AVG_54 3m HORN_9120D_1328 VERTICAL : RBW:1000.000KHz VBW:1.000KHz SWT:Auto</p> |



2.4GHz 2400~2483.5MHz
WIFI 802.11b (Harmonic @ 3m)

| WIFI | 2.4GHz 2400~2483.5MHz Harmonic @ 3m | |
|--------------|---|---|
| ANT | 802.11b CH01 2412MHz | |
| 1 | Horizontal | Vertical |
| Peak Avg. | <p>Site : 03CH12-HY Condition : PEAK_74 3m HORN_91200_1328 HORIZONTAL Detector : Peak</p> | <p>Site : 03CH12-HY Condition : PEAK_74 3m HORN_91200_1328 VERTICAL Detector : Peak</p> |



| | | |
|--------------|---|---|
| WIFI | 2.4GHz 2400~2483.5MHz Harmonic @ 3m | |
| ANT | 802.11b CH06 2437MHz | |
| 1 | Horizontal | Vertical |
| Peak Avg. | <p>Site : 03CH12-HY Condition : PEAK_74 3m HORN_91200_1328 HORIZONTAL Detector : Peak</p> | <p>Site : 03CH12-HY Condition : PEAK_74 3m HORN_91200_1328 VERTICAL Detector : Peak</p> |



| WIFI | 2.4GHz 2400~2483.5MHz Harmonic @ 3m | |
|----------------------------|---|---|
| ANT | 802.11b CH11 2462MHz | |
| 1 | Horizontal | Vertical |
| Peak Avg. | <p>Site : 03CH12-HY Condition : PEAK_74 3m HORN_91200_1328 HORIZONTAL Detector : Peak</p> | <p>Site : 03CH12-HY Condition : PEAK_74 3m HORN_91200_1328 VERTICAL Detector : Peak</p> |



2.4GHz 2400~2483.5MHz
 WIFI 802.11g (Harmonic @ 3m)

| WIFI | 2.4GHz 2400~2483.5MHz Harmonic @ 3m | |
|--------------|---|---|
| ANT | 802.11g CH01 2412MHz | |
| 1 | Horizontal | Vertical |
| Peak Avg. | <p>Site : 03CH12-HY Condition : PEAK_74 3m HORN_91200_1328 HORIZONTAL Detector : Peak</p> | <p>Site : 03CH12-HY Condition : PEAK_74 3m HORN_91200_1328 VERTICAL Detector : Peak</p> |

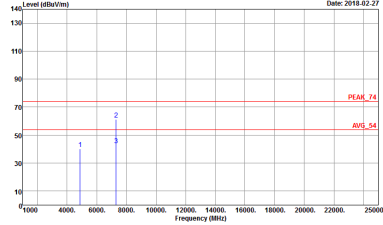
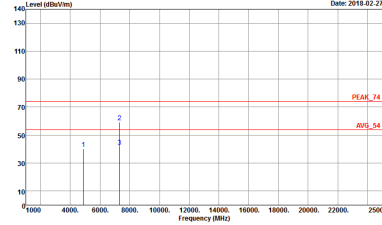

| | | |
|----------------------|---|--|
| WIFI | 2.4GHz 2400~2483.5MHz Harmonic @ 3m | |
| ANT | 802.11g CH06 2437MHz | |
| 1 | Horizontal | Vertical |
| <p>Peak Avg.</p> |  <p>Site : 03CH12-HY Condition : PEAK_74 3m HORN_91200_1328 HORIZONTAL Detector : Peak</p> |  <p>Site : 03CH12-HY Condition : PEAK_74 3m HORN_91200_1328 VERTICAL Detector : Peak</p> |



| | | |
|--------------|---|---|
| WIFI | 2.4GHz 2400~2483.5MHz Harmonic @ 3m | |
| ANT | 802.11g CH11 2462MHz | |
| 1 | Horizontal | Vertical |
| Peak Avg. | <p>Site : 03CH12-HY Condition : PEAK_74 3m HORN_91200_1328 HORIZONTAL Detector : Peak</p> | <p>Site : 03CH12-HY Condition : PEAK_74 3m HORN_91200_1328 VERTICAL Detector : Peak</p> |



2.4GHz 2400~2483.5MHz
 WIFI 802.11n HT20 (Harmonic @ 3m)

| WIFI | 2.4GHz 2400~2483.5MHz Harmonic @ 3m | |
|--------------|---|---|
| ANT | 802.11n HT20 CH01 2412MHz | |
| 1 | Horizontal | Vertical |
| Peak Avg. | <p>Site : 03CH12-HY Condition : PEAK_74 3m HORN_91200_1328 HORIZONTAL Detector : Peak</p> | <p>Site : 03CH12-HY Condition : PEAK_74 3m HORN_91200_1328 VERTICAL Detector : Peak</p> |

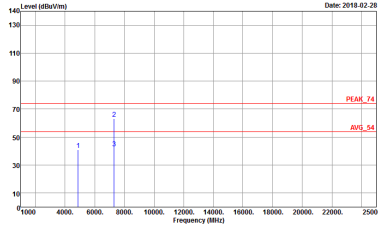
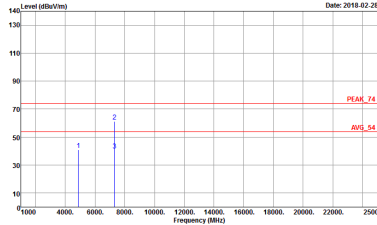

| | | |
|------------------------------------|---|--|
| WIFI | 2.4GHz 2400~2483.5MHz Harmonic @ 3m | |
| ANT | 802.11n HT20 CH06 2437MHz | |
| 1 | Horizontal | Vertical |
| <p>Peak Avg.</p> |  <p>Site : 03CH12-HY Condition : PEAK_74 3m HORN_91200_1328 HORIZONTAL Detector : Peak</p> |  <p>Site : 03CH12-HY Condition : PEAK_74 3m HORN_91200_1328 VERTICAL Detector : Peak</p> |



| WIFI | 2.4GHz 2400~2483.5MHz Harmonic @ 3m | |
|--------------|---|---|
| ANT | 802.11n HT20 CH11 2462MHz | |
| 1 | Horizontal | Vertical |
| Peak Avg. | <p>Site : 03CH12-HY Condition : PEAK_74 3m HORN_91200_1328 HORIZONTAL Detector : Peak</p> | <p>Site : 03CH12-HY Condition : PEAK_74 3m HORN_91200_1328 VERTICAL Detector : Peak</p> |



Emission below 1GHz
2.4GHz WIFI 802.11b (LF)

| WIFI | 2.4GHz 2400~2483.5MHz | |
|--------------|--|--|
| ANT | 802.11b LF | |
| 1 | Horizontal | Vertical |
| QP / Peak | <p>Site : 03CH12-HY Condition : QP 3m BTL06_6111D_40103 HORIZONTAL Detector : Peak</p> | <p>Site : 03CH12-HY Condition : QP 3m BTL06_6111D_40103 VERTICAL Detector : Peak</p> |

Appendix E. Duty Cycle Plots

| Band | Duty Cycle(%) | T(us) | 1/T(kHz) | VBW Setting | Duty Factor(dB) |
|---------------------|---------------|-------|----------|-------------|-----------------|
| 802.11b | 98.89 | - | - | 10Hz | 0.05 |
| 802.11g | 94.50 | 2.060 | 0.49 | 1KHz | 0.25 |
| 2.4GHz 802.11n HT20 | 94.12 | 1.920 | 0.52 | 1KHz | 0.26 |

802.11b

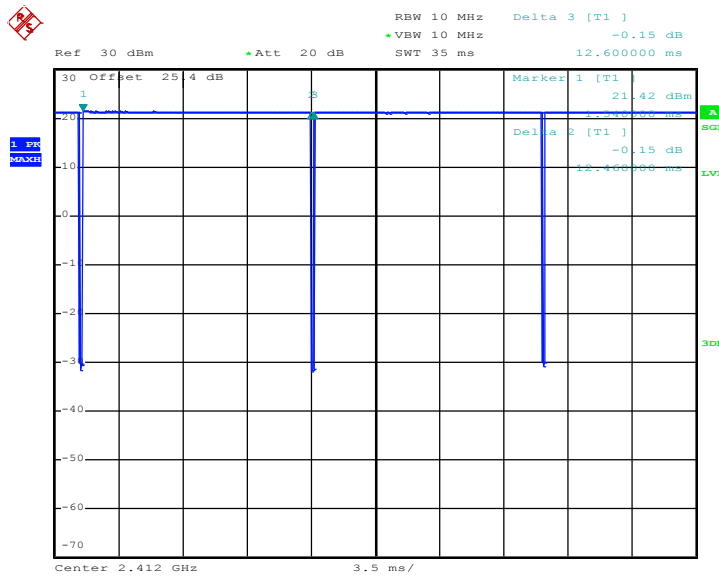

Date: 7.FEB.2018 20:43:46



802.11g

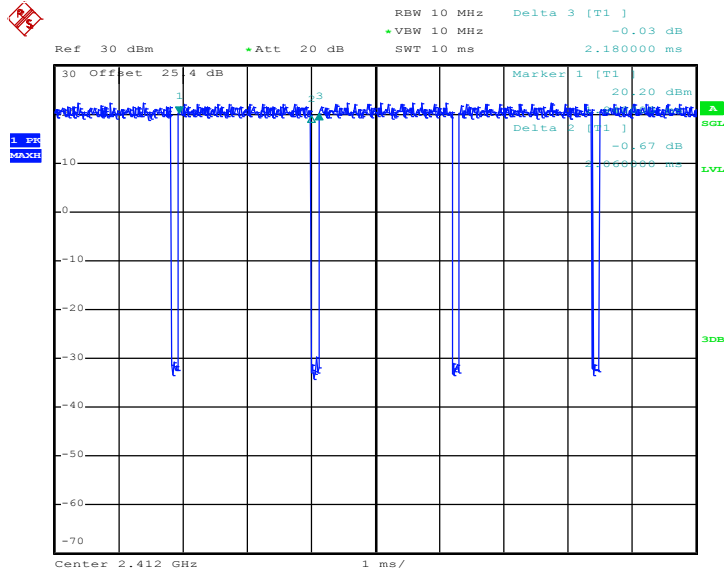

Date: 12.FEB.2018 11:36:29

802.11n HT20

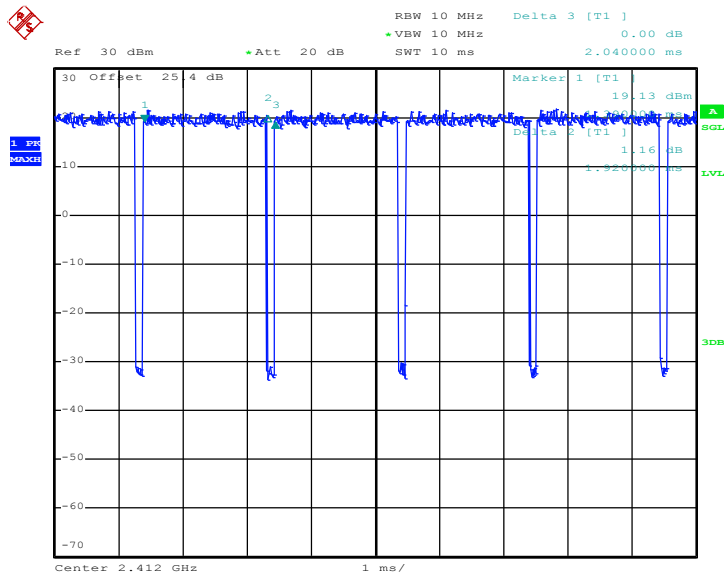

Date: 12.FEB.2018 11:45:22