



FCC RF Test Report

APPLICANT : Motorola Mobility LLC
EQUIPMENT : Mobile Cellular Phone
BRAND NAME : Motorola
MODEL NAME : XT1929-1(SS)
FCC ID : IHDT56XE2
STANDARD : FCC Part 15 Subpart E §15.407
CLASSIFICATION : (NII) Unlicensed National Information Infrastructure

The product was received on Jan. 18, 2018 and testing was completed on Mar. 05, 2018. We, SPORTON INTERNATIONAL INC., would like to declare that the tested sample has been evaluated in accordance with the test procedures and has been in compliance with the applicable technical standards.

The test results in this report apply exclusively to the tested model / sample. Without written approval of SPORTON INTERNATIONAL INC., the test report shall not be reproduced except in full.

Reviewed by: Joseph Lin / Supervisor

Approved by: Jones Tsai / Manager



SPORTON INTERNATIONAL INC.

No. 52, Hwa Ya 1st Rd., Hwa Ya Technology Park, Kwei-Shan District, Tao Yuan City, Taiwan, R.O.C.

SPORTON INTERNATIONAL INC.

TEL : 886-3-327-3456

FAX : 886-3-328-4978

FCC ID: IHDT56XE2

Page Number : 1 of 30

Report Issued Date : Mar. 09, 2018

Report Version : Rev. 01

Report Template No.: BU5-FR15EWLB4 AC MA Version 1.4



TABLE OF CONTENTS

REVISION HISTORY.....3

SUMMARY OF TEST RESULT4

1 GENERAL DESCRIPTION5

 1.1 Applicant5

 1.2 Manufacturer5

 1.3 Product Feature of Equipment Under Test.....5

 1.4 Product Specification of Equipment Under Test.....7

 1.5 Modification of EUT7

 1.6 Testing Location8

 1.7 Applicable Standards8

2 TEST CONFIGURATION OF EQUIPMENT UNDER TEST9

 2.1 Carrier Frequency and Channel9

 2.2 Test Mode 10

 2.3 Connection Diagram of Test System 11

 2.4 Support Unit used in test configuration and system 12

 2.5 EUT Operation Test Setup 12

 2.6 Measurement Results Explanation Example 12

3 TEST RESULT 13

 3.1 6dB and 26dB and 99% Occupied Bandwidth Measurement 13

 3.2 Maximum Conducted Output Power Measurement 16

 3.3 Power Spectral Density Measurement 17

 3.4 Unwanted Emissions Measurement 19

 3.5 AC Conducted Emission Measurement.....25

 3.6 Automatically Discontinue Transmission 27

 3.7 Antenna Requirements 28

4 LIST OF MEASURING EQUIPMENT29

5 UNCERTAINTY OF EVALUATION30

APPENDIX A. CONDUCTED TEST RESULTS

APPENDIX B. AC CONDUCTED EMISSION TEST RESULT

APPENDIX C. RADIATED SPURIOUS EMISSION

APPENDIX D. RADIATED SPURIOUS EMISSION PLOTS

APPENDIX E. DUTY CYCLE PLOTS



REVISION HISTORY

REPORT NO.	VERSION	DESCRIPTION	ISSUED DATE
FR811821-02F	Rev. 01	Initial issue of report	Mar. 09, 2018



SUMMARY OF TEST RESULT

Report Section	FCC Rule	Description	Limit	Result	Remark
3.1	15.403(i)	6dB, 26dB and 99% Occupied Bandwidth	> 500kHz	Pass	-
3.2	15.407(a)	Maximum Conducted Output Power	≤ 30 dBm	Pass	-
3.3	15.407(a)	Power Spectral Density	≤ 30 dBm/500kHz	Pass	-
3.4	15.407(b)	Unwanted Emissions	15.407(b)(4)(i) & 15.209(a)	Pass	Under limit 3.12 dB at 17265.000 MHz
3.5	15.207	AC Conducted Emission	15.207(a)	Pass	Under limit 15.86 dB at 0.751 MHz
3.6	15.407(c)	Automatically Discontinue Transmission	Discontinue Transmission	Pass	-
3.7	15.203 & 15.407(a)	Antenna Requirement	N/A	Pass	-



1 General Description

1.1 Applicant

Motorola Mobility LLC
222 W,Merchandise Mart Plaza, Chicago IL 60654 USA

1.2 Manufacturer

Motorola Mobility LLC
222 W,Merchandise Mart Plaza, Chicago IL 60654 USA

1.3 Product Feature of Equipment Under Test

Product Feature	
Equipment	Mobile Cellular Phone
Brand Name	Motorola
Model Name	XT1929-1(SS)
FCC ID	IHDT56XE2
IMEI Code	Conducted : IMEI: 351885090004200 Conduction : IMEI: 351885090010991 Radiation : IMEI: 351885090010702
EUT supports Radios application	CDMA/EV-DO/GSM/EGPRS/WCDMA/HSPA/LTE/GNSS/NFC WLAN 11b/g/n HT20 WLAN 11a/n HT20/HT40 WLAN 11ac VHT20/VHT40/VHT80 Bluetooth BR/EDR/LE
HW Version	DVT2
EUT Stage	Identical Prototype

Remark: The above EUT's information was declared by manufacturer. Please refer to the specifications or user's manual for more detailed description.



Accessory List	
AC Adapter 1	Brand Name : Motorola
	Model Name : SC-22 SPN5970A
	Manufacturer : Salom
AC Adapter 2	Brand Name : Motorola
	Model Name : SC-22 SPN5993A
	Manufacturer : Chenyang
Battery	Brand Name : Motorola
	Model Name : JS40
	Manufacturer : SUNWODA
C2Audio Cable 1	Brand Name : Motorola
	Model Name : SC18C27844
	Manufacturer : Luxshare
C2Audio Cable 2	Brand Name : Motorola
	Model Name : SC18C27845
	Manufacturer : Cabletech
USB Cable 1	Brand Name : Cabletech
	Model Name : SKN6473A
USB Cable 2	Brand Name : FOXLINK
	Model Name : SKN6473A 17195-C 0403532
USB Cable 3	Brand Name : SAIBAO
	Model Name : SKN6473A 17214-C 1127044
USB Cable 4	Brand Name : Luxshare
	Model Name : SKN6473A 17227-C 1126538



1.4 Product Specification of Equipment Under Test

Standards-related Product Specification	
Tx/Rx Channel Frequency Range	5745 MHz ~ 5825 MHz
Maximum Output Power	802.11a : 16.96 dBm / 0.0497 W 802.11n HT20 : 16.93 dBm / 0.0493 W 802.11n HT40 : 15.96 dBm / 0.0394 W 802.11ac VHT20 : 15.90 dBm / 0.0389 W 802.11ac VHT40 : 14.89 dBm / 0.0308 W 802.11ac VHT80 : 14.93 dBm / 0.0311 W
99% Occupied Bandwidth	802.11a : 17.65 MHz 802.11n HT20 : 18.65 MHz 802.11n HT40 : 36.60 MHz 802.11ac VHT80 : 75.84 MHz
Antenna Type / Gain	Loop Antenna with gain -7.00 dBi
Type of Modulation	802.11a/n : OFDM (BPSK / QPSK / 16QAM / 64QAM) 802.11ac : OFDM (BPSK / QPSK / 16QAM / 64QAM / 256QAM)

1.5 Modification of EUT

No modifications are made to the EUT during all test items.



1.6 Testing Location

Sporton Lab is accredited to ISO 17025 by Taiwan Accreditation Foundation (TAF code : 1190) and the FCC designation No. TW1190 and TW0007 under the FCC 2.948(e) by Mutual Recognition Agreement (MRA) in FCC Test.

Test Site	SPORTON INTERNATIONAL INC.	
Test Site Location	No. 52, Hwa Ya 1st Rd., Hwa Ya Technology Park, Kwei-Shan District, Tao Yuan City, Taiwan, R.O.C. TEL: +886-3-327-3456 FAX: +886-3-328-4978	
Test Site No.	Sporton Site No.	
	TH05-HY	CO05-HY

Note: The test site complies with ANSI C63.4 2014 requirement.

Test Site	SPORTON INTERNATIONAL INC.	
Test Site Location	No.58, Aly. 75, Ln. 564, Wenhua 3rd Rd. Guishan Dist, Taoyuan City, Taiwan (R.O.C.) TEL: +886-3-327-3456 FAX: +886-3-328-4978	
Test Site No.	Sporton Site No.	
	03CH12-HY	

Note: The test site complies with ANSI C63.4 2014 requirement.

1.7 Applicable Standards

According to the specifications of the manufacturer, the EUT must comply with the requirements of the following standards:

- FCC Part 15 Subpart E
- FCC KDB 789033 D02 General UNII Test Procedures New Rules v02r01.
- ANSI C63.10-2013

Remark:

1. All test items were verified and recorded according to the standards and without any deviation during the test.
2. This EUT has also been tested and complied with the requirements of FCC Part 15, Subpart B, recorded in a separate test report.



2 Test Configuration of Equipment Under Test

- a. The EUT has been associated with peripherals and configuration operated in a manner tended to maximize its emission characteristics in a typical application. Frequency range investigated: conduction emission (150 kHz to 30 MHz), radiation emission (9 kHz to the 10th harmonic of the highest fundamental frequency or to 40 GHz, whichever is lower). For radiated measurement, pre-scanned in three orthogonal panels, X, Y, Z. The worst cases (X plane) were recorded in this report.
- b. AC power line Conducted Emission was tested under maximum output power.

2.1 Carrier Frequency and Channel

Frequency Band	Channel	Freq. (MHz)	Channel	Freq. (MHz)
5725-5850 MHz Band 4 (U-NII-3)	149	5745	157	5785
	151*	5755	159*	5795
	153	5765	161	5805
	155 [#]	5775	165	5825

Note:

1. The above Frequency and Channel in "*" were 802.11n HT40 and 802.11ac VHT40.
2. The above Frequency and Channel in "[#]" were 802.11ac VHT80.



2.2 Test Mode

Final test modes are considering the modulation and worse data rates as below table.

Modulation	Data Rate
802.11a	6 Mbps
802.11n HT20	MCS0
802.11n HT40	MCS0
802.11ac VHT20 (Covered by HT20)	MCS0
802.11ac VHT40 (Covered by HT40)	MCS0
802.11ac VHT80	MCS0

AC Conducted Emission	Mode 1 : GSM1900 Idle + Bluetooth Link + WLAN (5GHz) Link + MP3 + Battery + USB Cable 1 Type C (Charging from Adapter 1)
Remark: For Radiated Test Cases, The tests were performance with Adapter 1, and USB Cable 1 Type C.	

Ch. #		Band IV : 5725-5850 MHz			
		802.11a	802.11n HT20	802.11n HT40	802.11ac VHT80
L	Low	149	149	151	-
M	Middle	157	157	-	155
H	High	165	165	159	-

2.3 Connection Diagram of Test System

<EUT with Adapter>

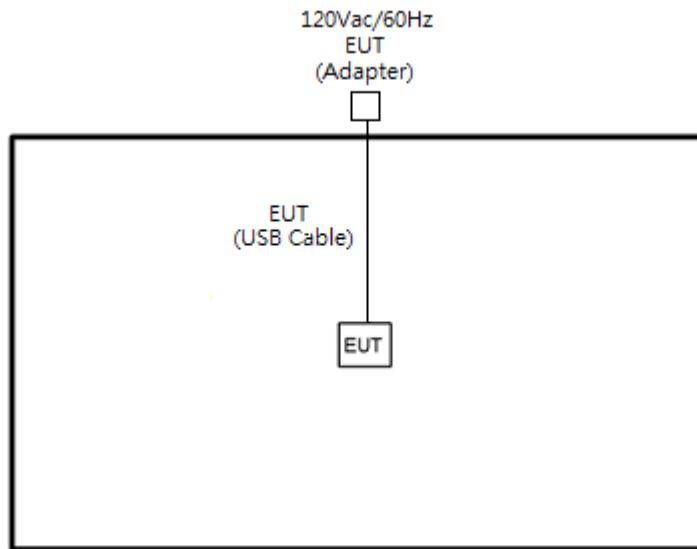

<AC Conducted Emission Mode>

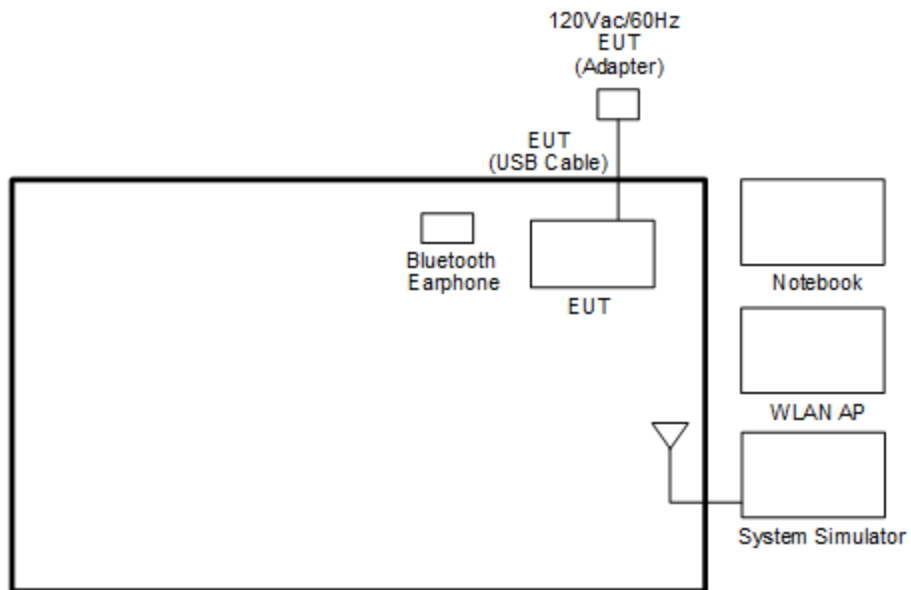



2.4 Support Unit used in test configuration and system

Item	Equipment	Trade Name	Model Name	FCC ID	Data Cable	Power Cord
1.	System Simulator	Anritsu	MT8820C	N/A	N/A	Unshielded, 1.8 m
2.	WLAN AP	ASUS	RT-AC66U	KA2DIR628A2	N/A	Unshielded, 1.8 m
3.	Notebook	DELL	Latitude E6320	FCC DoC/ Contains FCC ID: QDS-BRCM1054	N/A	AC I/P: Unshielded, 1.2 m DC O/P: Shielded, 1.8 m
4.	SD Card	SanDisk	MicroSD HC	FCC DoC	N/A	N/A
5.	Bluetooth Earphone	Lenovo	LBH 301	PYAHS-107W	N/A	N/A

2.5 EUT Operation Test Setup

The RF test items, utility “QRCT” was installed in Notebook which was programmed in order to make the EUT get into the engineering modes to provide channel selection, power level, data rate and the application type and for continuous transmitting signals.

2.6 Measurement Results Explanation Example

For all conducted test items:

The offset level is set in the spectrum analyzer to compensate the RF cable loss and attenuator factor between EUT conducted output port and spectrum analyzer. With the offset compensation, the spectrum analyzer reading level is exactly the EUT RF output level.

Example :

The spectrum analyzer offset is derived from RF cable loss and attenuator factor.

Offset = RF cable loss + attenuator factor.

Following shows an offset computation example with cable loss 4.2 dB and 10dB attenuator.

$$\begin{aligned}
 \text{Offset(dB)} &= \text{RF cable loss(dB)} + \text{attenuator factor(dB)}. \\
 &= 4.2 + 10 = 14.2 \text{ (dB)}
 \end{aligned}$$

3 Test Result

3.1 6dB and 26dB and 99% Occupied Bandwidth Measurement

3.1.1 Description of 6dB and 26dB and 99% Occupied Bandwidth

The minimum 6 dB bandwidth shall be at least 500 kHz.

26dB and 99% Occupied bandwidth are reporting only.

3.1.2 Measuring Instruments

The measuring equipment is listed in the section 4 of this test report.

3.1.3 Test Procedures

1. The testing follows FCC KDB 789033 D02 General UNII Test Procedures New Rules v02r01. Section C) Emission bandwidth for the band 5.725-5.85GHz
2. Set RBW = 100kHz.
3. Set the VBW $\geq 3 \times$ RBW.
4. Detector = Peak.
5. Trace mode = max hold
6. Measure the maximum width of the emission that is 6 dB down from the peak of the emission.
7. Measure and record the results in the test report.

3.1.4 Test Setup

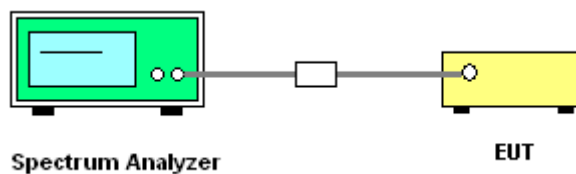

3.1.5 Test Result of 6dB Bandwidth

Please refer to Appendix A.

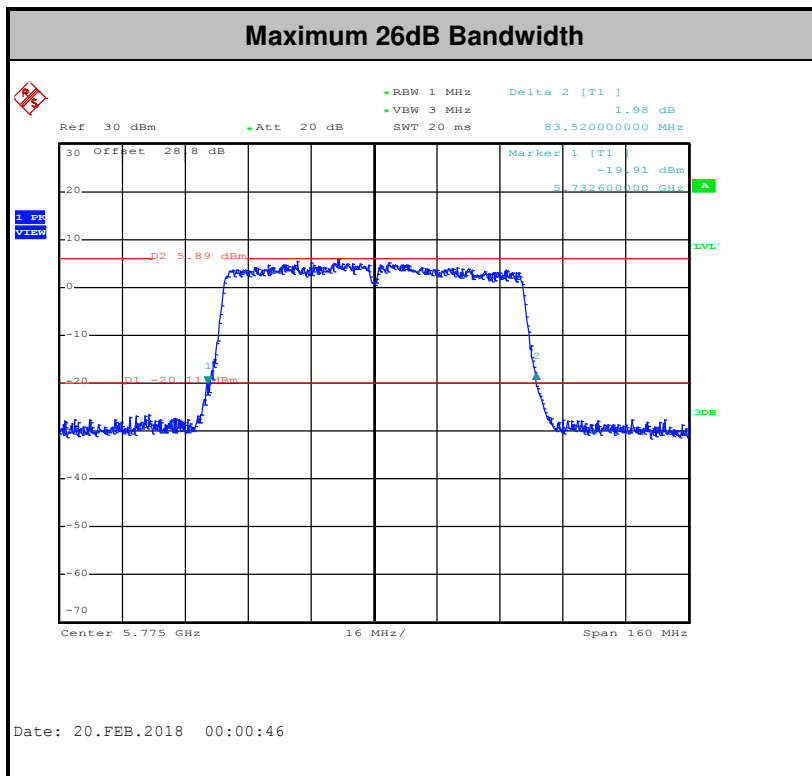
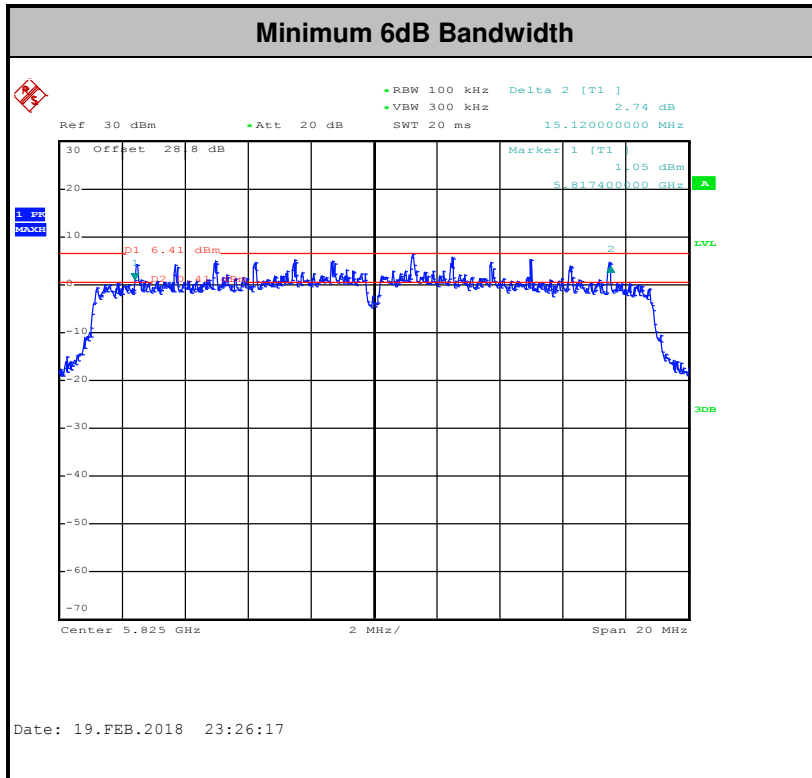

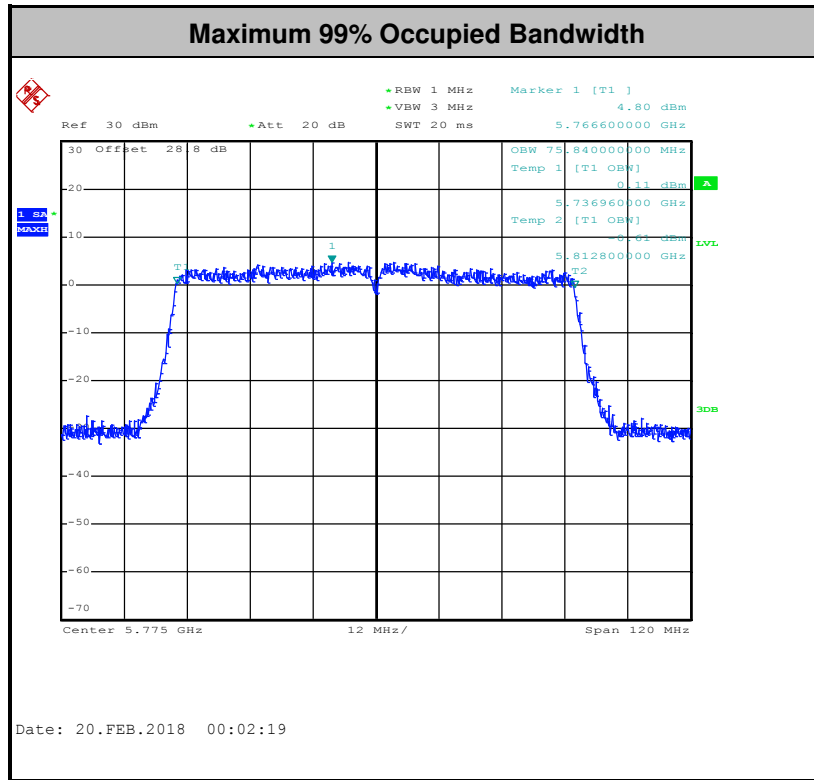

Note: The occupied channel bandwidth is maintained within the band of operation for all of the modulations.

3.2 Maximum Conducted Output Power Measurement

3.2.1 Limit of Maximum Conducted Output Power

For the band 5.725–5.85 GHz, the maximum conducted output power over the frequency band of operation shall not exceed 1 W.

If transmitting antennas of directional gain greater than 6 dBi are used, the peak output power shall be reduced by the amount in dB that the directional gain of the antenna exceeds 6 dBi.

3.2.2 Measuring Instruments

The measuring equipment is listed in the section 4 of this test report.

3.2.3 Test Procedures

The testing follows Method PM of FCC KDB 789033 D02 General UNII Test Procedures New Rules v02r01.

Method PM (Measurement using an RF average power meter):

1. Measurement is performed using a wideband RF power meter.
2. The EUT is configured to transmit continuously with a consistent duty cycle at its maximum power control level.
3. Measure the average power of the transmitter, and the average power is corrected with duty factor, $10 \log(1/x)$, where x is the duty cycle.

3.2.4 Test Setup

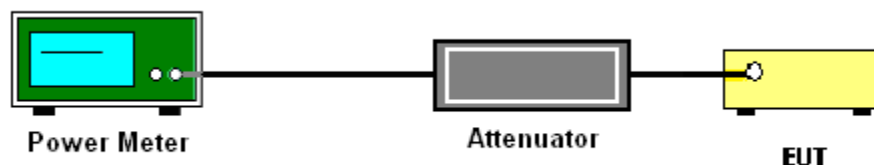

3.2.5 Test Result of Maximum Conducted Output Power

Please refer to Appendix A.



3.3 Power Spectral Density Measurement

3.3.1 Limit of Power Spectral Density

For the band 5.725–5.85 GHz, the maximum power spectral density shall not exceed 30 dBm in any 500-kHz band.

If transmitting antennas of directional gain greater than 6 dBi are used, the peak output power shall be reduced by the amount in dB that the directional gain of the antenna exceeds 6 dBi.

3.3.2 Measuring Instruments

The measuring equipment is listed in the section 4 of this test report.

3.3.3 Test Procedures

The testing follows FCC KDB 789033 D02 General UNII Test Procedures New Rules v02r01. Section F) Maximum power spectral density.

Method SA-2

(trace averaging across on and off times of the EUT transmissions, followed by duty cycle correction).

- Measure the duty cycle.
 - Set span to encompass the entire emission bandwidth (EBW) of the signal.
 - Set RBW = 300 kHz.
 - Set VBW \geq 1 MHz.
 - Number of points in sweep \geq 2 Span / RBW.
 - Sweep time = auto.
 - Detector = RMS
 - Trace average at least 100 traces in power averaging mode.
 - Add $10 \log(500\text{kHz}/\text{RBW})$ to the test result.
 - Add $10 \log(1/x)$, where x is the duty cycle, to the measured power in order to compute the average power during the actual transmission times. For example, add $10 \log(1/0.25) = 6$ dB if the duty cycle is 25 percent.
1. The RF output of EUT was connected to the spectrum analyzer by a low loss cable.
 2. Each plot has already offset with cable loss, and attenuator loss. Measure the PPSD and record it.



3.4 Unwanted Emissions Measurement

This section is to measure unwanted emissions through radiated measurement for band edge spurious emissions and out of band emissions measurement.

3.4.1 Limit of Unwanted Emissions

- (1) For transmitters operating in the 5.725-5.85 GHz band:
 15.407(b)(4)(i) All emissions shall be limited to a level of -27 dBm/MHz at 75 MHz or more above or below the band edge increasing linearly to 10 dBm/MHz at 25 MHz above or below the band edge, and from 25 MHz above or below the band edge increasing linearly to a level of 15.6 dBm/MHz at 5 MHz above or below the band edge, and from 5 MHz above or below the band edge increasing linearly to a level of 27 dBm/MHz at the band edge.
- (2) Unwanted spurious emissions fallen in restricted bands shall comply with the general field strength limits as below table,

Frequency (MHz)	Field Strength (microvolts/meter)	Measurement Distance (meters)
0.009 – 0.490	2400/F(kHz)	300
0.490 – 1.705	24000/F(kHz)	30
1.705 – 30.0	30	30
30 – 88	100	3
88 – 216	150	3
216 - 960	200	3
Above 960	500	3

Note: The following formula is used to convert the EIRP to field strength.

$$E = \frac{1000000\sqrt{30P}}{3} \text{ } \mu\text{V/m, where P is the eirp (Watts)}$$



EIRP (dBm)	Field Strength at 3m (dBμV/m)
-17	78.3
- 27	68.3

(3) KDB789033 D02 v02r01 G)2)c)

- (i) Section 15.407(b)(1) to (b)(3) specify the unwanted emission limits for the U-NII-1 and U-NII-2 bands. As specified, emissions above 1000 MHz that are outside of the restricted bands are subject to a peak emission limit of -27 dBm/MHz.³
- (ii) Section 15.407(b)(4) specifies the unwanted emission limit for the U-NII-3 band. A band emissions mask is specified in Section 15.407(b)(4)(i). The emission limits are in terms of a Peak detector. An alternative to the band emissions mask is specified in Section 15.407(b)(4)(ii). The alternative limits are based on the highest antenna gain specified in the filing. There are also marketing and importation restrictions for the devices using the alternative limit.⁴

Note 3: An out-of-band emission that complies with both the average and peak limits of Section 15.209 is not required to satisfy the -27 dBm/MHz peak emission limit.

Note 4: Only devices with antenna gains of 10 dBi or less may be approved using the emission limits specified in Section 15.247(d) till March 2, 2018; all other devices operating in this band must use the mask specified in Section 15.407(b)(4)(i).

3.4.2 Measuring Instruments

The measuring equipment is listed in the section 4 of this test report.



3.4.3 Test Procedures

1. The testing follows FCC KDB 789033 D02 General UNII Test Procedures New Rules v02r01. Section G) Unwanted emissions measurement.
 - (1) Procedure for Unwanted Emissions Measurements Below 1000MHz
 - RBW = 120 kHz
 - VBW = 300 kHz
 - Detector = Peak
 - Trace mode = max hold
 - (2) Procedure for Peak Unwanted Emissions Measurements Above 1000 MHz
 - RBW = 1 MHz
 - VBW \geq 3 MHz
 - Detector = Peak
 - Sweep time = auto
 - Trace mode = max hold
 - (3) Procedures for Average Unwanted Emissions Measurements Above 1000MHz
 - RBW = 1 MHz
 - VBW = 10 Hz, when duty cycle is no less than 98 percent.
 - VBW \geq 1/T, when duty cycle is less than 98 percent where T is the minimum transmission duration over which the transmitter is on and is transmitting at its maximum power control level for the tested mode of operation.



2. The EUT was placed on a turntable with 0.8 meter for frequency below 1GHz and 1.5 meter for frequency above 1GHz respectively above ground.
3. The EUT was set 3 meters from the interference receiving antenna which was mounted on the top of a variable height antenna tower.
4. The antenna is a broadband antenna and its height is adjusted between one meter and four meters above ground to find the maximum value of the field strength for both horizontal polarization and vertical polarization of the antenna.
5. For each suspected emission, the EUT was arranged to its worst case and then adjust the antenna tower (from 1 m to 4 m) and turntable (from 0 degree to 360 degrees) to find the maximum reading.
6. For testing below 1GHz, if the emission level of the EUT in peak mode was 3 dB lower than the limit specified, then peak values of EUT will be reported, otherwise, the emissions will be repeated one by one using the CISPR quasi-peak method and reported.
7. For testing above 1GHz, the emission level of the EUT in peak mode was 20dB lower than average limit (that means the emission level in average mode also complies with the limit in average mode), then peak values of EUT will be reported, otherwise, the emissions will be measured in average mode again and reported.

3.4.4 Test Setup

For radiated emissions below 30MHz

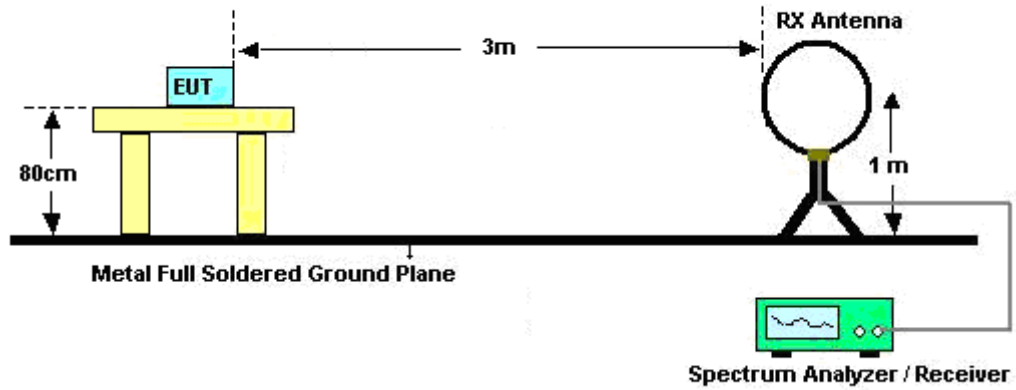

For radiated emissions from 30MHz to 1GHz

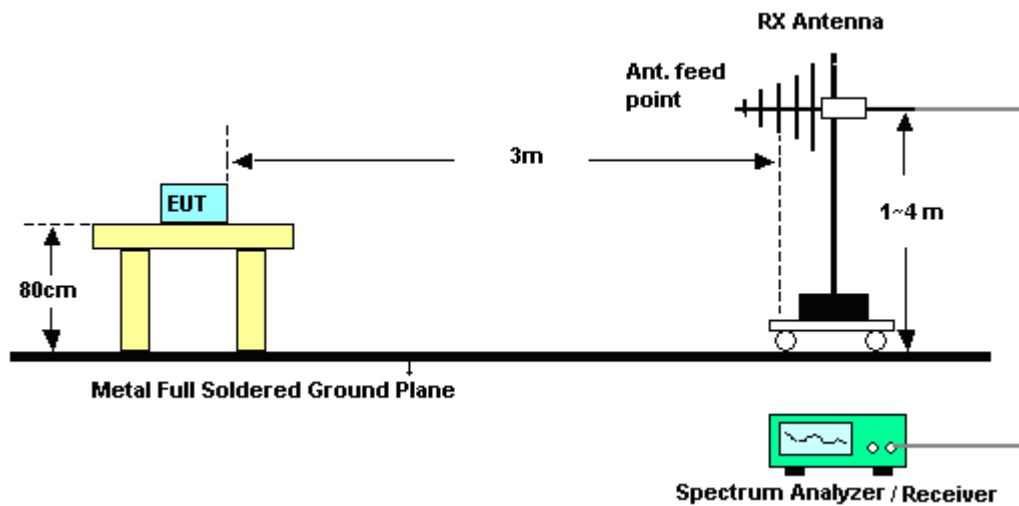

For radiated emissions above 1GHz

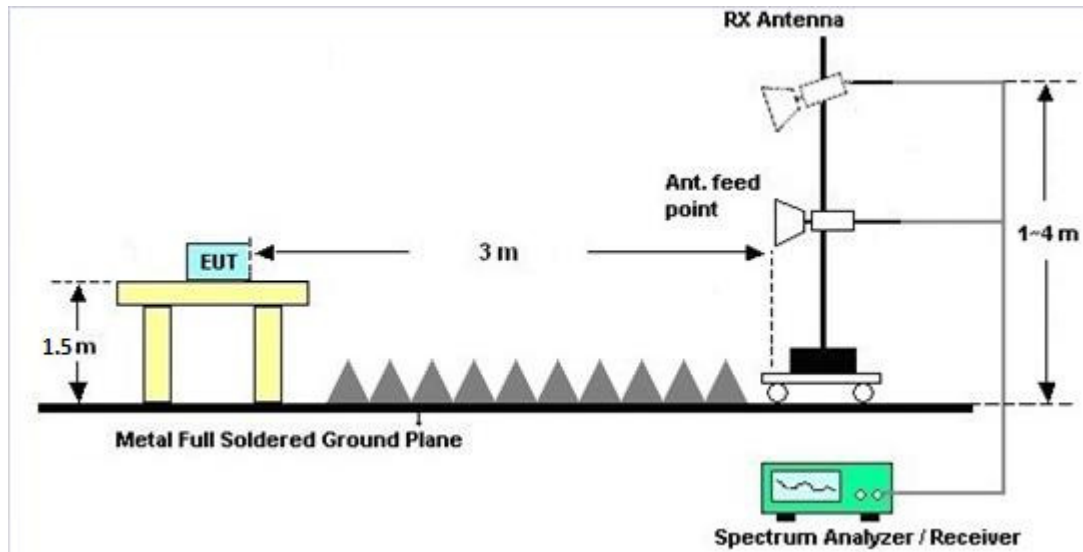

3.4.5 Test Results of Radiated Emissions (9 kHz ~ 30 MHz)

The low frequency, which started from 9 kHz to 30MHz, was pre-scanned and the result which was 20dB lower than the limit line was not reported.

There is a comparison data of both open-field test site and semi-Anechoic chamber, and the result came out very similar.

3.4.6 Test Result of Radiated Band Edges

Please refer to Appendix C and D.

3.4.7 Duty Cycle

Please refer to Appendix E.

3.4.8 Test Result of Unwanted Radiated Emission (30MHz ~ 10th Harmonic)

Please refer to Appendix C and D.



3.5 AC Conducted Emission Measurement

3.5.1 Limit of AC Conducted Emission

For equipment that is designed to be connected to the public utility (AC) power line, the radio frequency voltage that is conducted back onto the AC power line on any frequency or frequencies within the band 150 kHz to 30 MHz shall not exceed the limits in the following table.

Frequency of emission (MHz)	Conducted limit (dBµV)	
	Quasi-peak	Average
0.15-0.5	66 to 56*	56 to 46*
0.5-5	56	46
5-30	60	50

*Decreases with the logarithm of the frequency.

3.5.2 Measuring Instruments

The measuring equipment is listed in the section 4 of this test report.

3.5.3 Test Procedures

1. The EUT was placed 0.4 meter from the conducting wall of the shielding room was kept at least 80 centimeters from any other grounded conducting surface.
2. Connect EUT to the power mains through a line impedance stabilization network (LISN).
3. All the support units are connecting to the other LISN.
4. The LISN provides 50 ohm coupling impedance for the measuring instrument.
5. The FCC states that a 50 ohm, 50 microhenry LISN should be used.
6. Both sides of AC line were checked for maximum conducted interference.
7. The frequency range from 150 kHz to 30 MHz was searched.
8. Set the test-receiver system to Peak Detect Function and specified bandwidth with Maximum Hold Mode.

3.5.4 Test Setup

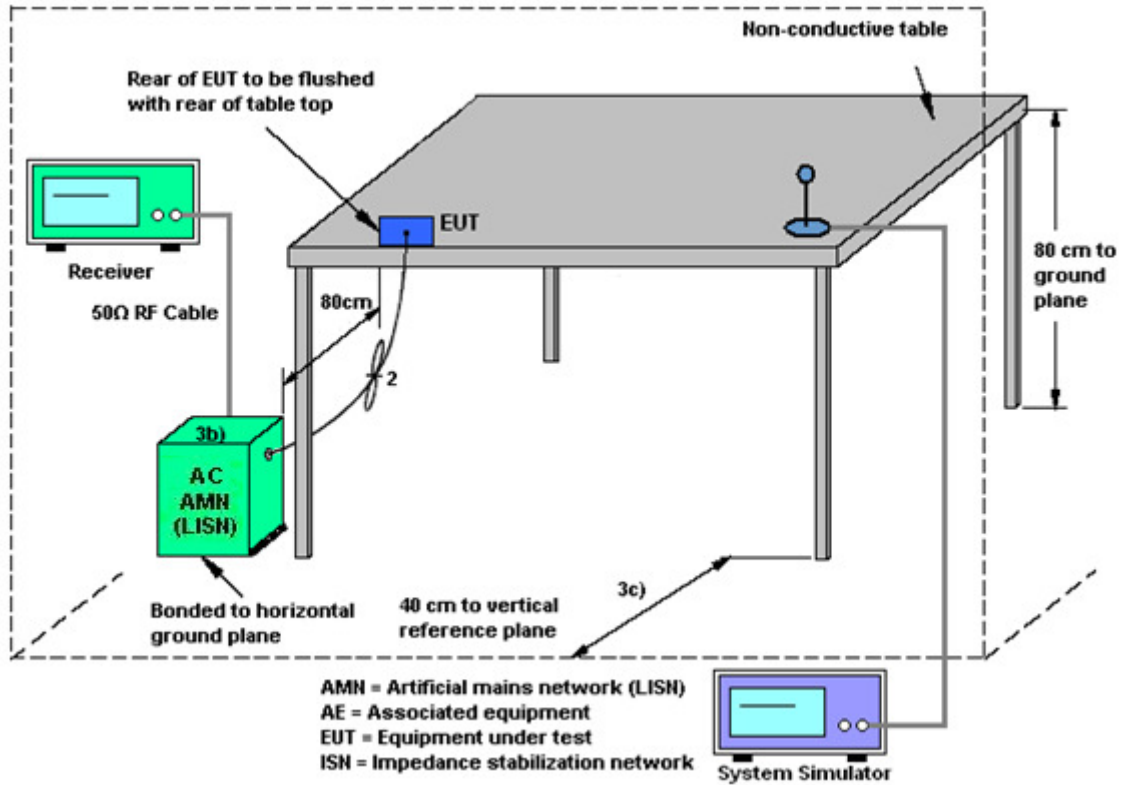

3.5.5 Test Result of AC Conducted Emission

Please refer to Appendix B.



3.6 Automatically Discontinue Transmission

3.6.1 Limit of Automatically Discontinue Transmission

The device shall automatically discontinue transmission in case of either absence of information to transmit or operational failure. These provisions are not intended to preclude the transmission of control or signaling information or the use of repetitive codes used by certain digital technologies to complete frame or burst intervals. Applicants shall include in their application for equipment authorization to describe how this requirement is met.

3.6.2 Measuring Instruments

The measuring equipment is listed in the section 4 of this test report.

3.6.3 Test Result of Automatically Discontinue Transmission

While the EUT is not transmitting any information, the EUT can automatically discontinue transmission and become standby mode for power saving. The EUT can detect the controlling signal of ACK message transmitting from remote device and verify whether it shall resend or discontinue transmission.



3.7 Antenna Requirements

3.7.1 Standard Applicable

If transmitting antenna directional gain is greater than 6 dBi, both the peak transmit power and the peak power spectral density shall be reduced by the amount in dB that the directional gain of the antenna exceeds 6 dBi.

3.7.2 Antenna Anti-Replacement Construction

An embedded-in antenna design is used.

3.7.3 Antenna Gain

The antenna peak gain of EUT is less than 6 dBi. Therefore, it is not necessary to reduce maximum peak output power limit.



4 List of Measuring Equipment

Instrument	Manufacturer	Model No.	Serial No.	Characteristics	Calibration Date	Test Date	Due Date	Remark
Power Meter	Anritsu	ML2495A	0932001	N/A	Sep. 26, 2017	Feb. 12, 2018~ Feb. 19, 2018	Sep. 25, 2018	Conducted (TH05-HY)
Power Sensor	Anritsu	MA2411B	0846202	300MHz~40GHz z	Sep. 26, 2017	Feb. 12, 2018~ Feb. 19, 2018	Sep. 25, 2018	Conducted (TH05-HY)
Spectrum Analyzer	Rohde & Schwarz	FSP30	101067	9kHz ~ 30GHz	Nov. 13, 2017	Feb. 12, 2018~ Feb. 19, 2018	Nov. 12, 2018	Conducted (TH05-HY)
AC Power Source	ChainTek	APC-1000W	N/A	N/A	N/A	Feb. 28, 2018	N/A	Conduction (CO05-HY)
EMI Test Receiver	Rohde & Schwarz	ESR3	102388	3.6GHz	Dec. 08, 2017	Feb. 28, 2018	Dec. 07, 2018	Conduction (CO05-HY)
LISN	Rohde & Schwarz	ENV216	100080	9kHz~30MHz	Nov. 30, 2017	Feb. 28, 2018	Nov. 29, 2018	Conduction (CO05-HY)
Amplifier	MITEQ	TTA1840-35-HG	1871923	18GHz~40GHz, VSWR : 2.5:1 max	Jul. 18, 2017	Feb. 27, 2018~ Mar. 05, 2018	Jul. 17, 2018	Radiation (03CH12-HY)
Bilog Antenna	TESEQ	CBL 6111D&00800 N1D01N-06	40103&07	30MHz~1GHz	Jan. 10, 2018	Feb. 27, 2018~ Mar. 05, 2018	Jan. 09, 2019	Radiation (03CH12-HY)
Loop Antenna	Rohde & Schwarz	HFH2-Z2	100488	9 kHz~30 MHz	Nov. 23, 2017	Feb. 27, 2018~ Mar. 05, 2018	Nov. 22, 2019	Radiation (03CH12-HY)
EMI Test Receiver	Rohde & Schwarz	ESU26	100390	20Hz~26.5GHz	Dec. 25, 2017	Feb. 27, 2018~ Mar. 05, 2018	Dec. 24, 2018	Radiation (03CH12-HY)
Horn Antenna	SCHWARZBECK	BBHA 9120D	9120D-132 8	1GHz ~ 18GHz	Oct. 20, 2017	Feb. 27, 2018~ Mar. 05, 2018	Oct. 19, 2018	Radiation (03CH12-HY)
Preamplifier	COM-POWER	PA-103	161075	10MHz~1GHz	Mar. 23, 2017	Feb. 27, 2018~ Mar. 05, 2018	Mar. 22, 2018	Radiation (03CH12-HY)
Preamplifier	Keysight	83017A	MY532701 48	1GHz~26.5GHz	Jan. 15, 2018	Feb. 27, 2018~ Mar. 05, 2018	Jan. 14, 2019	Radiation (03CH12-HY)
Preamplifier	MITEQ	AMF-7D-0010 1800	2025787	1GHz~18GHz	Feb. 13, 2017	Feb. 27, 2018~ Mar. 05, 2018	Feb. 12, 2019	Radiation (03CH12-HY)
Antenna Mast	EMEC	AM-BS-4500-B	N/A	1m~4m	N/A	Feb. 27, 2018~ Mar. 05, 2018	N/A	Radiation (03CH12-HY)
Turn Table	EMEC	TT2000	N/A	0~360 Degree	N/A	Feb. 27, 2018~ Mar. 05, 2018	N/A	Radiation (03CH12-HY)
Attenuator	Fairview Microwave	SA18S5W-10	n/a	10db	Mar. 24, 2017	Feb. 27, 2018~ Mar. 05, 2018	Mar. 23, 2018	Radiation (03CH12-HY)
SHF-EHF Horn Antenna	SCHWARZBECK	BBHA 9170	BBHA9170 576	18GHz ~ 40GHz	Apr. 27, 2017	Feb. 27, 2018~ Mar. 05, 2018	Apr. 26, 2018	Radiation (03CH12-HY)
Spectrum Analyzer	Keysight	N9010A	MY553705 26	10Hz~44GHz	Mar. 15, 2017	Feb. 27, 2018~ Mar. 05, 2018	Mar. 14, 2018	Radiation (03CH12-HY)



5 Uncertainty of Evaluation

Uncertainty of Conducted Emission Measurement (150kHz ~ 30MHz)

Measuring Uncertainty for a Level of Confidence of 95% ($U = 2Uc(y)$)	2.70
---	------

Uncertainty of Radiated Emission Measurement (30 MHz ~ 1000 MHz)

Measuring Uncertainty for a Level of Confidence of 95% ($U = 2Uc(y)$)	5.10
---	------

Uncertainty of Radiated Emission Measurement (1000 MHz ~ 18000 MHz)

Measuring Uncertainty for a Level of Confidence of 95% ($U = 2Uc(y)$)	5.20
---	------

Uncertainty of Radiated Emission Measurement (18000 MHz ~ 40000 MHz)

Measuring Uncertainty for a Level of Confidence of 95% ($U = 2Uc(y)$)	4.70
---	------

Appendix A. Test Result of Conducted Test Items

Test Engineer:	White Lin / Luffy Lin	Temperature:	21~25	°C
Test Date:	2018/2/12 ~ 2018/02/19	Relative Humidity:	51~54	%

TEST RESULTS DATA
6dB and 26dB EBW and 99% OBW

Band IV									
Mod.	Data Rate	NTX	CH.	Freq. (MHz)	99% Bandwidth (MHz)	26 dB Bandwidth (MHz)	6 dB Bandwidth (MHz)	6dB Bandwidth min. Limit (MHz)	Pass/Fail
11a	6M bps	1	149	5745	17.35	23.80	15.44	0.5	Pass
11a	6Mbps	1	157	5785	17.55	24.20	15.32	0.5	Pass
11a	6Mbps	1	165	5825	17.65	23.57	15.32	0.5	Pass
HT20	MCS 0	1	149	5745	18.55	24.97	15.88	0.5	Pass
HT20	MCS 0	1	157	5785	18.65	26.44	15.30	0.5	Pass
HT20	MCS 0	1	165	5825	18.55	24.64	15.12	0.5	Pass
HT40	MCS 0	1	151	5755	36.60	41.60	35.30	0.5	Pass
HT40	MCS 0	1	159	5795	36.60	42.22	35.84	0.5	Pass
VHT80	MCS 0	1	155	5775	75.84	83.52	75.12	0.5	Pass

TEST RESULTS DATA
Average Power Table

Band IV										
Mod.	Data Rate	NTX	CH.	Freq. (MHz)	Duty Factor (dB)	Average Conducted Power (dBm)	FCC Conducted Power Limit (dBm)	DG (dBi)		Pass/Fail
11a	6M bps	1	149	5745	0.22	16.96	30.00	-7.00		Pass
11a	6Mbps	1	157	5785	0.22	16.88	30.00	-7.00		Pass
11a	6Mbps	1	165	5825	0.22	16.94	30.00	-7.00		Pass
HT20	MCS 0	1	149	5745	0.25	16.93	30.00	-7.00		Pass
HT20	MCS 0	1	157	5785	0.25	16.86	30.00	-7.00		Pass
HT20	MCS 0	1	165	5825	0.25	16.91	30.00	-7.00		Pass
HT40	MCS 0	1	151	5755	0.43	15.91	30.00	-7.00		Pass
HT40	MCS 0	1	159	5795	0.43	15.96	30.00	-7.00		Pass
VHT20	MCS 0	1	149	5745	0.26	15.90	30.00	-7.00		Pass
VHT20	MCS 0	1	157	5785	0.26	15.66	30.00	-7.00		Pass
VHT20	MCS 0	1	165	5825	0.26	15.79	30.00	-7.00		Pass
VHT40	MCS 0	1	151	5755	0.43	14.89	30.00	-7.00		Pass
VHT40	MCS 0	1	159	5795	0.43	14.86	30.00	-7.00		Pass
VHT80	MCS 0	1	155	5775	0.65	14.93	30.00	-7.00		Pass

TEST RESULTS DATA
Power Spectral Density

Band IV										
Mod.	Data Rate	NTX	CH.	Freq. (MHz)	Duty Factor (dB)	10log (500kHz /RBW) Factor (dB)	Average Power Density (dBm/500kHz)	Average PSD Limit (dBm/500kHz)	DG (dBi)	Pass/Fail
11a	6M bps	1	149	5745	0.22	2.22	2.94	30.00	-7.00	Pass
11a	6Mbps	1	157	5785	0.22	2.22	1.94	30.00	-7.00	Pass
11a	6Mbps	1	165	5825	0.22	2.22	2.78	30.00	-7.00	Pass
HT20	MCS 0	1	149	5745	0.25	2.22	2.32	30.00	-7.00	Pass
HT20	MCS 0	1	157	5785	0.25	2.22	1.57	30.00	-7.00	Pass
HT20	MCS 0	1	165	5825	0.25	2.22	2.40	30.00	-7.00	Pass
HT40	MCS 0	1	151	5755	0.43	2.22	-1.48	30.00	-7.00	Pass
HT40	MCS 0	1	159	5795	0.43	2.22	-1.76	30.00	-7.00	Pass
VHT80	MCS 0	1	155	5775	0.65	2.22	-5.90	30.00	-7.00	Pass



Appendix B. AC Conducted Emission Test Results

Test Engineer :	Shareef Yu	Temperature :	22~23°C
		Relative Humidity :	58~62%

EUT Information

Report NO : 811821-02
 Test Mode : Mode 1
 Test Voltage : 120Vac/60Hz
 Phase : Line

Full Spectrum

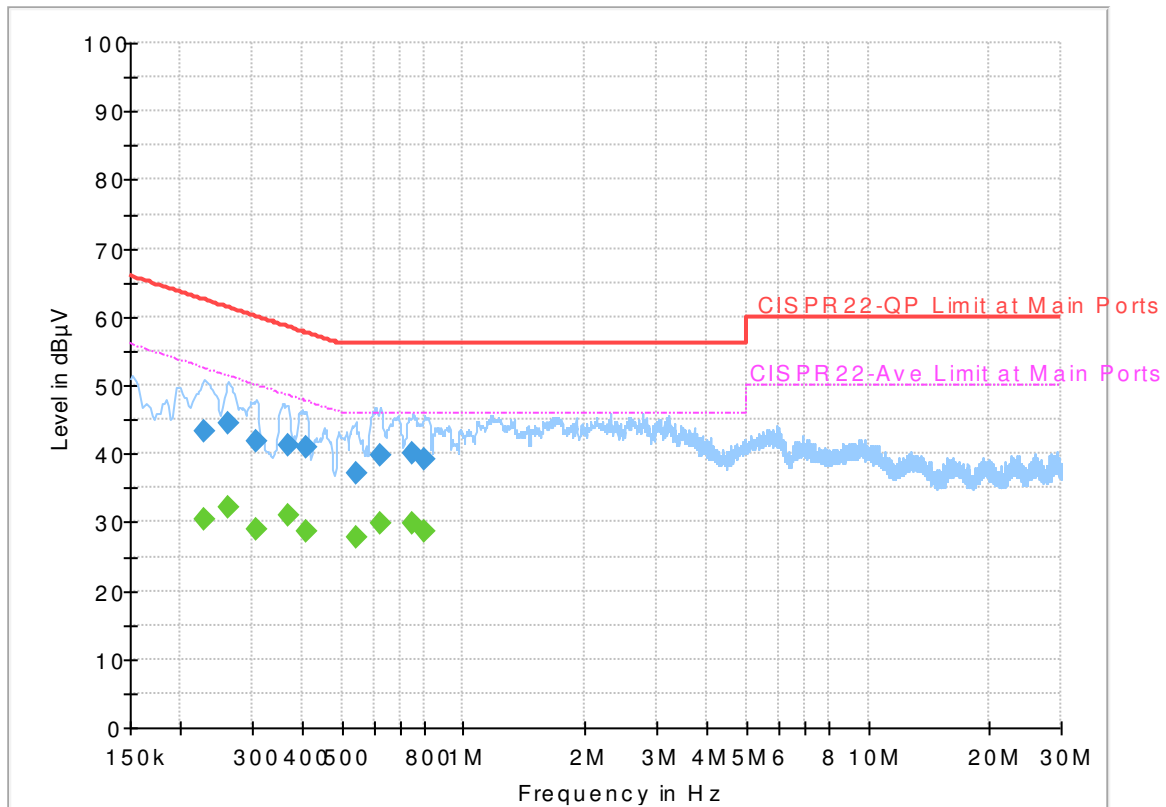

Final Result

Frequency (MHz)	QuasiPeak (dBµV)	Average (dBµV)	Limit (dBµV)	Margin (dB)	Line	Filter	Corr. (dB)
0.228750	---	30.45	52.50	22.05	L1	OFF	19.5
0.228750	43.21	---	62.50	19.29	L1	OFF	19.5
0.262500	---	32.03	51.35	19.32	L1	OFF	19.5
0.262500	44.42	---	61.35	16.93	L1	OFF	19.5
0.307500	---	28.95	50.04	21.09	L1	OFF	19.5
0.307500	41.86	---	60.04	18.18	L1	OFF	19.5
0.368250	---	30.94	48.54	17.60	L1	OFF	19.5
0.368250	41.29	---	58.54	17.25	L1	OFF	19.5
0.408750	---	28.74	47.67	18.93	L1	OFF	19.5
0.408750	40.82	---	57.67	16.85	L1	OFF	19.5
0.541500	---	27.74	46.00	18.26	L1	OFF	19.5
0.541500	37.02	---	56.00	18.98	L1	OFF	19.5
0.620250	---	29.75	46.00	16.25	L1	OFF	19.5
0.620250	39.84	---	56.00	16.16	L1	OFF	19.5
0.750750	---	29.70	46.00	16.30	L1	OFF	19.5
0.750750	40.14	---	56.00	15.86	L1	OFF	19.5
0.804750	---	28.58	46.00	17.42	L1	OFF	19.5
0.804750	39.16	---	56.00	16.84	L1	OFF	19.5

EUT Information

Report NO : 811821-02
 Test Mode : Mode 1
 Test Voltage : 120Vac/60Hz
 Phase : Neutral

Full Spectrum

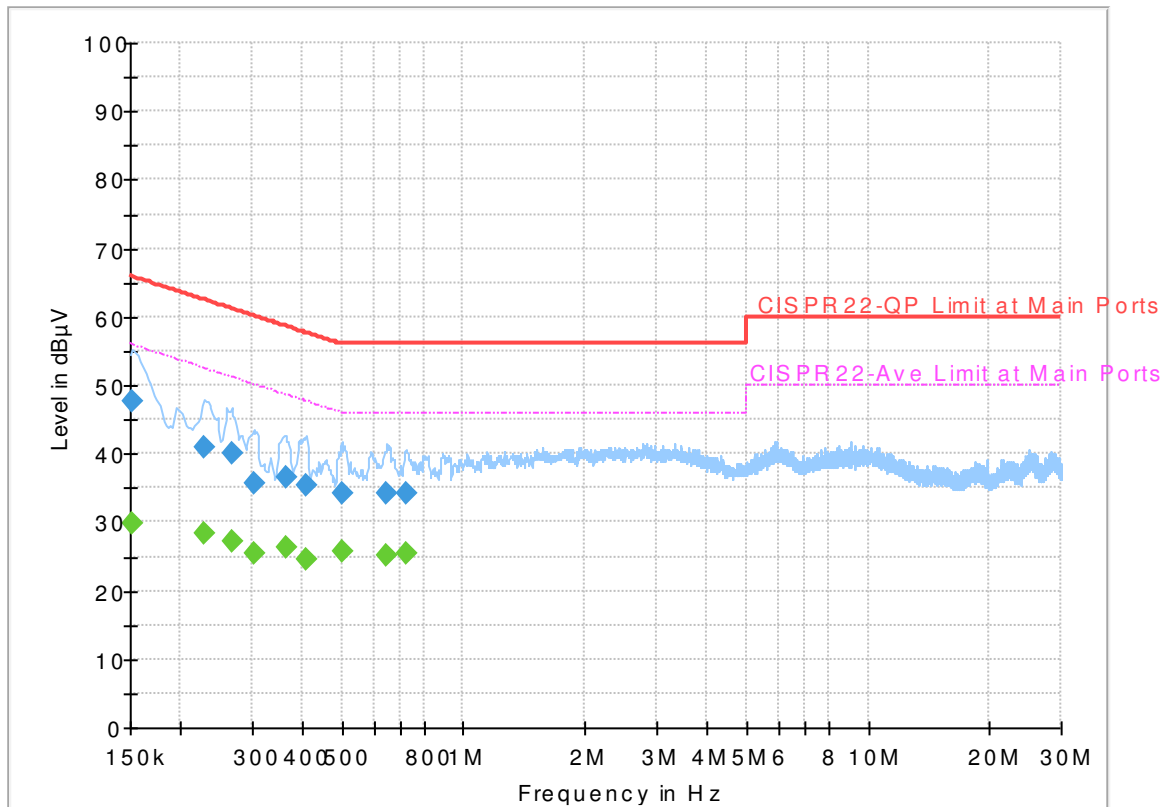

Final Result

Frequency (MHz)	QuasiPeak (dBµV)	Average (dBµV)	Limit (dBµV)	Margin (dB)	Line	Filter	Corr. (dB)
0.152250	---	29.69	55.88	26.19	N	OFF	19.5
0.152250	47.80	---	65.88	18.08	N	OFF	19.5
0.228750	---	28.38	52.50	24.12	N	OFF	19.5
0.228750	40.96	---	62.50	21.54	N	OFF	19.5
0.267000	---	27.30	51.21	23.91	N	OFF	19.5
0.267000	40.01	---	61.21	21.20	N	OFF	19.5
0.303000	---	25.48	50.16	24.68	N	OFF	19.5
0.303000	35.72	---	60.16	24.44	N	OFF	19.5
0.363750	---	26.41	48.64	22.23	N	OFF	19.5
0.363750	36.44	---	58.64	22.20	N	OFF	19.5
0.411000	---	24.54	47.63	23.09	N	OFF	19.5
0.411000	35.40	---	57.63	22.23	N	OFF	19.5
0.501000	---	25.74	46.00	20.26	N	OFF	19.5
0.501000	34.22	---	56.00	21.78	N	OFF	19.5
0.647250	---	25.10	46.00	20.90	N	OFF	19.5
0.647250	34.18	---	56.00	21.82	N	OFF	19.5
0.719250	---	25.50	46.00	20.50	N	OFF	19.5
0.719250	34.16	---	56.00	21.84	N	OFF	19.5



Appendix C. Radiated Spurious Emission

Test Engineer :	Watt Tseng, Karl Hou, and Nick Yu	Temperature :	21~23°C
		Relative Humidity :	57~60%

Band 4 - 5725~5850MHz
WIFI 802.11a (Band Edge @ 3m)

WIFI Ant.	Note	Frequency (MHz)	Level (dBμV/m)	Over Limit (dB)	Limit Line (dBμV/m)	Read Level (dBμV)	Antenna Factor (dB/m)	Path Loss (dB)	Preamp Factor (dB)	Ant Pos (cm)	Table Pos (deg)	Peak Avg. (P/A)	Pol. (H/V)	
802.11a CH 149 5745MHz		5647.2	49.73	-18.47	68.2	42.41	32.19	6.35	31.22	104	59	P	H	
		5698.6	61.03	-43.14	104.17	53.65	32.27	6.36	31.25	104	59	P	H	
		5717.6	64.17	-45.96	110.13	56.75	32.31	6.37	31.26	104	59	P	H	
		5724.4	65.67	-55.16	120.83	58.25	32.31	6.37	31.26	104	59	P	H	
	*	5745	110.08	-	-	102.64	32.34	6.37	31.27	104	59	P	H	
	*	5745	99.04	-	-	91.6	32.34	6.37	31.27	104	59	A	H	
														H
														H
			5617.6	48.57	-19.63	68.2	41.27	32.17	6.34	31.21	356	112	P	V
			5698.2	55.48	-48.39	103.87	48.1	32.27	6.36	31.25	356	112	P	V
			5717.6	58.79	-51.34	110.13	51.37	32.31	6.37	31.26	356	112	P	V
			5724.2	62.09	-58.29	120.38	54.67	32.31	6.37	31.26	356	112	P	V
	*	5745	107.13	-	-	99.69	32.34	6.37	31.27	356	112	P	V	
	*	5745	96.33	-	-	88.89	32.34	6.37	31.27	356	112	A	V	
														V
														V



WIFI Ant. 1	Note	Frequency (MHz)	Level (dBµV/m)	Over Limit (dB)	Limit Line (dBµV/m)	Read Level (dBµV)	Antenna Factor (dB/m)	Path Loss (dB)	Preamp Factor (dB)	Ant Pos (cm)	Table Pos (deg)	Peak Avg. (P/A)	Pol. (H/V)
		5644.6	49.21	-18.99	68.2	41.89	32.19	6.35	31.22	113	61	P	H
		5696.4	50.68	-51.87	102.55	43.3	32.27	6.36	31.25	113	61	P	H
		5719.6	56.2	-54.49	110.69	48.78	32.31	6.37	31.26	113	61	P	H
		5724.4	55.92	-64.91	120.83	48.5	32.31	6.37	31.26	113	61	P	H
	*	5785	109.09	-	-	101.61	32.39	6.38	31.29	113	61	P	H
	*	5785	98.25	-	-	90.77	32.39	6.38	31.29	113	61	A	H
		5851.8	52.55	-65.55	118.1	44.97	32.48	6.42	31.32	113	61	P	H
		5866	53.54	-54.18	107.72	45.93	32.51	6.43	31.33	113	61	P	H
		5886.4	49.84	-46.9	96.74	42.21	32.53	6.44	31.34	113	61	P	H
		5931.6	49.31	-18.89	68.2	41.59	32.6	6.47	31.35	113	61	P	H
													H
													H
802.11a													
CH 157													
5785MHz		5609.2	48.78	-19.42	68.2	41.51	32.14	6.34	31.21	335	114	P	V
		5676.2	49.72	-37.91	87.63	42.36	32.24	6.35	31.23	335	114	P	V
		5720	50.6	-60.2	110.8	43.18	32.31	6.37	31.26	335	114	P	V
		5723.4	52.12	-66.43	118.55	44.7	32.31	6.37	31.26	335	114	P	V
	*	5785	106.38	-	-	98.9	32.39	6.38	31.29	335	114	P	V
	*	5785	95.43	-	-	87.95	32.39	6.38	31.29	335	114	A	V
		5850.2	49.97	-71.77	121.74	42.39	32.48	6.42	31.32	335	114	P	V
		5855.2	50.5	-60.24	110.74	42.89	32.51	6.42	31.32	335	114	P	V
		5879.6	49.16	-52.62	101.78	41.52	32.53	6.44	31.33	335	114	P	V
		5930.6	49.62	-18.58	68.2	41.9	32.6	6.47	31.35	335	114	P	V
													V
													V



WiFi Ant. 1	Note	Frequency (MHz)	Level (dBµV/m)	Over Limit (dB)	Limit Line (dBµV/m)	Read Level (dBµV)	Antenna Factor (dB/m)	Path Loss (dB)	Preamp Factor (dB)	Ant Pos (cm)	Table Pos (deg)	Peak Avg. (P/A)	Pol. (H/V)	
802.11a CH 165 5825MHz	*	5825	109.14	-	-	101.6	32.46	6.39	31.31	108	62	P	H	
	*	5825	98.3	-	-	90.76	32.46	6.39	31.31	108	62	A	H	
		5854.6	60.56	-51.15	111.71	52.95	32.51	6.42	31.32	108	62	P	H	
		5856.6	59.99	-50.36	110.35	52.38	32.51	6.42	31.32	108	62	P	H	
		5884.4	55.77	-42.45	98.22	48.14	32.53	6.44	31.34	108	62	P	H	
		5941.8	49.59	-18.61	68.2	41.85	32.63	6.48	31.37	108	62	P	H	
														H
														H
	*	5825	106.91	-	-	99.37	32.46	6.39	31.31	365	112	P	V	
	*	5825	96.22	-	-	88.68	32.46	6.39	31.31	365	112	A	V	
		5854.6	55.83	-55.88	111.71	48.22	32.51	6.42	31.32	365	112	P	V	
		5855	54.66	-56.14	110.8	47.05	32.51	6.42	31.32	365	112	P	V	
		5878.8	52.9	-49.48	102.38	45.27	32.53	6.43	31.33	365	112	P	V	
		5939.8	49.19	-19.01	68.2	41.45	32.63	6.48	31.37	365	112	P	V	
														V
														V
													V	
Remark	1. No other spurious found. 2. All results are PASS against Peak and Average limit line.													



Band 4 5725~5850MHz
WIFI 802.11a (Harmonic @ 3m)

WIFI Ant. 1	Note	Frequency (MHz)	Level (dBμV/m)	Over Limit (dB)	Limit Line (dBμV/m)	Read Level (dBμV)	Antenna Factor (dB/m)	Path Loss (dB)	Preamp Factor (dB)	Ant Pos (cm)	Table Pos (deg)	Peak Avg. (P/A)	Pol. (H/V)
802.11a CH 149 5745MHz		11490	45.64	-28.36	74	60.59	40.11	10.33	65.39	100	0	P	H
		17235	47.71	-20.49	68.2	57.71	41.54	12.73	64.27	100	0	P	H
													H
													H
		11490	45.07	-28.93	74	60.02	40.11	10.33	65.39	100	0	P	V
		17235	48	-20.2	68.2	58	41.54	12.73	64.27	100	0	P	V
													V
													V
802.11a CH 157 5785MHz		11570	45.43	-28.57	74	60.5	39.93	10.37	65.37	100	0	P	H
		17355	46.18	-22.02	68.2	55.51	41.96	12.82	64.11	100	0	P	H
													H
													H
		11570	45.77	-28.23	74	60.84	39.93	10.37	65.37	100	0	P	V
		17355	45.76	-22.44	68.2	55.09	41.96	12.82	64.11	100	0	P	V
													V
													V
802.11a CH 165 5825MHz		11650	45.18	-28.82	74	60.34	39.77	10.41	65.34	100	0	P	H
		17475	45.1	-23.1	68.2	53.76	42.38	12.91	63.95	100	0	P	H
													H
													H
		11650	46.37	-27.63	74	61.53	39.77	10.41	65.34	100	0	P	V
		17475	44.92	-23.28	68.2	53.58	42.38	12.91	63.95	100	0	P	V
													V
													V
Remark	1. No other spurious found. 2. All results are PASS against Peak and Average limit line.												



Band 4 5725~5850MHz
WIFI 802.11n HT20 (Band Edge @ 3m)

WIFI Ant. 1	Note	Frequency (MHz)	Level (dBμV/m)	Over Limit (dB)	Limit Line (dBμV/m)	Read Level (dBμV)	Antenna Factor (dB/m)	Path Loss (dB)	Preamp Factor (dB)	Ant Pos (cm)	Table Pos (deg)	Peak Avg. (P/A)	Pol. (H/V)	
802.11n HT20 CH 149 5745MHz		5649.4	49.67	-18.53	68.2	42.35	32.19	6.35	31.22	102	60	P	H	
		5700	62.45	-42.75	105.2	55.07	32.27	6.36	31.25	102	60	P	H	
		5718.8	64.37	-46.09	110.46	56.95	32.31	6.37	31.26	102	60	P	H	
		5725	66.43	-55.77	122.2	59.01	32.31	6.37	31.26	102	60	P	H	
	*	5745	109.54	-	-	102.1	32.34	6.37	31.27	102	60	P	H	
	*	5745	98.19	-	-	90.75	32.34	6.37	31.27	102	60	A	H	
														H
														H
			5612.2	48.68	-19.52	68.2	41.41	32.14	6.34	31.21	376	111	P	V
			5697.8	57.17	-46.41	103.58	49.79	32.27	6.36	31.25	376	111	P	V
			5718.8	61.07	-49.39	110.46	53.65	32.31	6.37	31.26	376	111	P	V
			5725	63.15	-59.05	122.2	55.73	32.31	6.37	31.26	376	111	P	V
	*		5745	106.89	-	-	99.45	32.34	6.37	31.27	376	111	P	V
	*		5745	95.83	-	-	88.39	32.34	6.37	31.27	376	111	A	V
														V
														V



WIFI Ant. 1	Note	Frequency (MHz)	Level (dBμV/m)	Over Limit (dB)	Limit Line (dBμV/m)	Read Level (dBμV)	Antenna Factor (dB/m)	Path Loss (dB)	Preamp Factor (dB)	Ant Pos (cm)	Table Pos (deg)	Peak Avg. (P/A)	Pol. (H/V)
		5605	49.48	-18.72	68.2	42.21	32.14	6.34	31.21	104	60	P	H
		5687.4	50.62	-45.29	95.91	43.24	32.27	6.36	31.25	104	60	P	H
		5719.4	52.96	-57.67	110.63	45.54	32.31	6.37	31.26	104	60	P	H
		5724	54.31	-65.61	119.92	46.89	32.31	6.37	31.26	104	60	P	H
	*	5785	108.55	-	-	101.07	32.39	6.38	31.29	104	60	P	H
	*	5785	97.35	-	-	89.87	32.39	6.38	31.29	104	60	A	H
		5851.2	52.03	-67.43	119.46	44.45	32.48	6.42	31.32	104	60	P	H
		5862.6	51.24	-57.43	108.67	43.63	32.51	6.43	31.33	104	60	P	H
		5894.4	49.67	-41.14	90.81	42.01	32.56	6.44	31.34	104	60	P	H
		5929.2	48.91	-19.29	68.2	41.19	32.6	6.47	31.35	104	60	P	H
802.11n													H
HT20													H
CH 157		5633.8	48.94	-19.26	68.2	41.62	32.19	6.35	31.22	390	110	P	V
5785MHz		5687.8	50.54	-45.66	96.2	43.16	32.27	6.36	31.25	390	110	P	V
		5702.6	49.75	-56.18	105.93	42.35	32.29	6.36	31.25	390	110	P	V
		5725	53	-69.2	122.2	45.58	32.31	6.37	31.26	390	110	P	V
	*	5785	106.81	-	-	99.33	32.39	6.38	31.29	390	110	P	V
	*	5785	95.42	-	-	87.94	32.39	6.38	31.29	390	110	A	V
		5850.2	49.91	-71.83	121.74	42.33	32.48	6.42	31.32	390	110	P	V
		5862.6	48.7	-59.97	108.67	41.09	32.51	6.43	31.33	390	110	P	V
		5888.8	49.72	-45.24	94.96	42.06	32.56	6.44	31.34	390	110	P	V
		5944.4	49.5	-18.7	68.2	41.76	32.63	6.48	31.37	390	110	P	V
													V
													V



WIFI Ant. 1	Note	Frequency (MHz)	Level (dBμV/m)	Over Limit (dB)	Limit Line (dBμV/m)	Read Level (dBμV)	Antenna Factor (dB/m)	Path Loss (dB)	Preamp Factor (dB)	Ant Pos (cm)	Table Pos (deg)	Peak Avg. (P/A)	Pol. (H/V)	
802.11n HT20 CH 165 5825MHz	*	5825	109.09	-	-	101.55	32.46	6.39	31.31	115	63	P	H	
	*	5825	97.65	-	-	90.11	32.46	6.39	31.31	115	63	A	H	
		5850.2	58.49	-63.25	121.74	50.91	32.48	6.42	31.32	115	63	P	H	
		5859.8	59.39	-50.06	109.45	51.79	32.51	6.42	31.33	115	63	P	H	
		5876.8	55.28	-48.58	103.86	47.65	32.53	6.43	31.33	115	63	P	H	
		5941	50.12	-18.08	68.2	42.38	32.63	6.48	31.37	115	63	P	H	
														H
														H
	*	5825	106.31	-	-	98.77	32.46	6.39	31.31	346	114	P	V	
	*	5825	95.19	-	-	87.65	32.46	6.39	31.31	346	114	A	V	
		5851.2	57.3	-62.16	119.46	49.72	32.48	6.42	31.32	346	114	P	V	
		5858.4	55.47	-54.38	109.85	47.87	32.51	6.42	31.33	346	114	P	V	
		5882.6	54.41	-45.15	99.56	46.77	32.53	6.44	31.33	346	114	P	V	
		5945.6	49.25	-18.95	68.2	41.51	32.63	6.48	31.37	346	114	P	V	
														V
														V
Remark	1. No other spurious found. 2. All results are PASS against Peak and Average limit line.													



Band 4 5725~5850MHz
WIFI 802.11n HT20 (Harmonic @ 3m)

WIFI Ant. 1	Note	Frequency (MHz)	Level (dBμV/m)	Over Limit (dB)	Limit Line (dBμV/m)	Read Level (dBμV)	Antenna Factor (dB/m)	Path Loss (dB)	Preamp Factor (dB)	Ant Pos (cm)	Table Pos (deg)	Peak Avg. (P/A)	Pol. (H/V)
802.11n HT20 CH 149 5745MHz		11490	45.02	-28.98	74	59.97	40.11	10.33	65.39	100	0	P	H
		17235	47.82	-20.38	68.2	57.82	41.54	12.73	64.27	100	0	P	H
													H
													H
		11490	44.82	-29.18	74	59.77	40.11	10.33	65.39	100	0	P	V
		17235	46.46	-21.74	68.2	56.46	41.54	12.73	64.27	100	0	P	V
													V
802.11n HT20 CH 157 5785MHz		11570	44.96	-29.04	74	60.03	39.93	10.37	65.37	100	0	P	H
		17355	46.04	-22.16	68.2	55.37	41.96	12.82	64.11	100	0	P	H
													H
													H
		11570	45.12	-28.88	74	60.19	39.93	10.37	65.37	100	0	P	V
		17355	45.42	-22.78	68.2	54.75	41.96	12.82	64.11	100	0	P	V
													V
802.11n HT20 CH 165 5825MHz		11650	45.52	-28.48	74	60.68	39.77	10.41	65.34	100	0	P	H
		17475	44.7	-23.5	68.2	53.36	42.38	12.91	63.95	100	0	P	H
													H
													H
		11650	44.74	-29.26	74	59.9	39.77	10.41	65.34	100	0	P	V
		17475	45.67	-22.53	68.2	54.33	42.38	12.91	63.95	100	0	P	V
													V
Remark	1. No other spurious found.												
	2. All results are PASS against Peak and Average limit line.												



Band 4 5725~5850MHz
WIFI 802.11n HT40 (Band Edge @ 3m)

WIFI Ant. 1	Note	Frequency (MHz)	Level (dBμV/m)	Over Limit (dB)	Limit Line (dBμV/m)	Read Level (dBμV)	Antenna Factor (dB/m)	Path Loss (dB)	Preamp Factor (dB)	Ant Pos (cm)	Table Pos (deg)	Peak Avg. (P/A)	Pol. (H/V)
		5645	54.76	-13.44	68.2	47.44	32.19	6.35	31.22	100	62	P	H
		5694	62.82	-37.96	100.78	55.44	32.27	6.36	31.25	100	62	P	H
		5716.8	65.63	-44.28	109.91	58.24	32.29	6.36	31.26	100	62	P	H
		5724.4	64.27	-56.56	120.83	56.85	32.31	6.37	31.26	100	62	P	H
	*	5755	104.99	-	-	97.53	32.36	6.37	31.27	100	62	P	H
	*	5755	94.17	-	-	86.71	32.36	6.37	31.27	100	62	A	H
		5852.8	52.02	-63.8	115.82	44.44	32.48	6.42	31.32	100	62	P	H
		5857.2	52.14	-58.04	110.18	44.53	32.51	6.42	31.32	100	62	P	H
		5918	50.27	-23.09	73.36	42.57	32.58	6.47	31.35	100	62	P	H
		5934	50.24	-17.96	68.2	42.51	32.6	6.48	31.35	100	62	P	H
802.11n													H
HT40													H
CH 151		5645.4	52.26	-15.94	68.2	44.94	32.19	6.35	31.22	352	115	P	V
5755MHz		5694.2	60.69	-40.23	100.92	53.31	32.27	6.36	31.25	352	115	P	V
		5717.8	64.31	-45.87	110.18	56.89	32.31	6.37	31.26	352	115	P	V
		5724.2	63.09	-57.29	120.38	55.67	32.31	6.37	31.26	352	115	P	V
	*	5755	104.15	-	-	96.69	32.36	6.37	31.27	352	115	P	V
	*	5755	93.33	-	-	85.87	32.36	6.37	31.27	352	115	A	V
		5850	51.36	-70.84	122.2	43.78	32.48	6.42	31.32	352	115	P	V
		5859.4	51.56	-58.01	109.57	43.96	32.51	6.42	31.33	352	115	P	V
		5911.6	50.81	-27.28	78.09	43.12	32.58	6.46	31.35	352	115	P	V
		5946.2	49.81	-18.39	68.2	42.07	32.63	6.48	31.37	352	115	P	V
													V
													V



WIFI Ant. 1	Note	Frequency (MHz)	Level (dBμV/m)	Over Limit (dB)	Limit Line (dBμV/m)	Read Level (dBμV)	Antenna Factor (dB/m)	Path Loss (dB)	Preamp Factor (dB)	Ant Pos (cm)	Table Pos (deg)	Peak Avg. (P/A)	Pol. (H/V)
		5617	49.35	-18.85	68.2	42.05	32.17	6.34	31.21	104	64	P	H
		5694	55.03	-45.75	100.78	47.65	32.27	6.36	31.25	104	64	P	H
		5718.6	60.51	-49.9	110.41	53.09	32.31	6.37	31.26	104	64	P	H
		5725	61.61	-60.59	122.2	54.19	32.31	6.37	31.26	104	64	P	H
	*	5795	104.34	-	-	96.84	32.41	6.38	31.29	104	64	P	H
	*	5795	93.57	-	-	86.07	32.41	6.38	31.29	104	64	A	H
		5851.4	60.27	-58.74	119.01	52.69	32.48	6.42	31.32	104	64	P	H
		5857.2	60.79	-49.39	110.18	53.18	32.51	6.42	31.32	104	64	P	H
		5875	56.73	-48.47	105.2	49.1	32.53	6.43	31.33	104	64	P	H
		5945.4	49.52	-18.68	68.2	41.78	32.63	6.48	31.37	104	64	P	H
													H
													H
802.11n													
HT40													
CH 159		5639.8	49.32	-18.88	68.2	42	32.19	6.35	31.22	384	113	P	V
5795MHz		5693.2	53.35	-46.84	100.19	45.97	32.27	6.36	31.25	384	113	P	V
		5716.2	57.98	-51.76	109.74	50.59	32.29	6.36	31.26	384	113	P	V
		5725	59.44	-62.76	122.2	52.02	32.31	6.37	31.26	384	113	P	V
	*	5795	104.07	-	-	96.57	32.41	6.38	31.29	384	113	P	V
	*	5795	93.4	-	-	85.9	32.41	6.38	31.29	384	113	A	V
		5850.8	59.07	-61.31	120.38	51.49	32.48	6.42	31.32	384	113	P	V
		5857.6	58.63	-51.44	110.07	51.02	32.51	6.42	31.32	384	113	P	V
		5875.2	54.09	-50.96	105.05	46.46	32.53	6.43	31.33	384	113	P	V
		5933.8	49.59	-18.61	68.2	41.86	32.6	6.48	31.35	384	113	P	V
													V
													V
Remark	1. No other spurious found. 2. All results are PASS against Peak and Average limit line.												



Band 4 5725~5850MHz
WIFI 802.11n HT40 (Harmonic @ 3m)

WIFI Ant. 1	Note	Frequency (MHz)	Level (dBμV/m)	Over Limit (dB)	Limit Line (dBμV/m)	Read Level (dBμV)	Antenna Factor (dB/m)	Path Loss (dB)	Preamp Factor (dB)	Ant Pos (cm)	Table Pos (deg)	Peak Avg. (P/A)	Pol. (H/V)	
802.11n HT40 CH 151 5755MHz		11510	46.86	-27.14	74	61.82	40.1	10.34	65.4	100	0	P	H	
		17265	55.29	-12.91	68.2	65.11	41.66	12.75	64.23	100	0	P	H	
													H	
													H	
			11510	47.07	-26.93	74	62.03	40.1	10.34	65.4	100	0	P	V
			17265	65.08	-3.12	68.2	74.9	41.66	12.75	64.23	100	0	P	V
														V
802.11n HT40 CH 159 5795MHz		11590	48.67	-25.33	74	63.77	39.89	10.38	65.37	100	0	P	H	
		17385	54.54	-13.66	68.2	63.68	42.08	12.84	64.06	100	0	P	H	
													H	
													H	
			11590	48.62	-25.38	74	63.72	39.89	10.38	65.37	100	0	P	V
			17385	64.33	-3.87	68.2	73.47	42.08	12.84	64.06	137	97	P	V
														V
Remark	1. No other spurious found.													
	2. All results are PASS against Peak and Average limit line.													



Band 4 5725~5850MHz
WIFI 802.11ac VHT80 (Band Edge @ 3m)

WIFI Ant. 1	Note	Frequency (MHz)	Level (dBμV/m)	Over Limit (dB)	Limit Line (dBμV/m)	Read Level (dBμV)	Antenna Factor (dB/m)	Path Loss (dB)	Preamp Factor (dB)	Ant Pos (cm)	Table Pos (deg)	Peak Avg. (P/A)	Pol. (H/V)
		5649.6	52.65	-15.55	68.2	45.3	32.22	6.35	31.22	100	62	P	H
		5699.2	61.61	-43	104.61	54.23	32.27	6.36	31.25	100	62	P	H
		5718.6	64.95	-45.46	110.41	57.53	32.31	6.37	31.26	100	62	P	H
		5721	63.44	-49.64	113.08	56.02	32.31	6.37	31.26	100	62	P	H
	*	5775	99.88	-	-	92.39	32.39	6.38	31.28	100	62	P	H
	*	5775	89.12	-	-	81.63	32.39	6.38	31.28	100	62	A	H
		5853.8	61.35	-52.19	113.54	53.74	32.51	6.42	31.32	100	62	P	H
		5858.8	60.95	-48.78	109.73	53.35	32.51	6.42	31.33	100	62	P	H
		5875.2	54.84	-50.21	105.05	47.21	32.53	6.43	31.33	100	62	P	H
		5932.6	49.8	-18.4	68.2	42.08	32.6	6.47	31.35	100	62	P	H
													H
													H
802.11ac VHT80 CH 155 5775MHz		5641.4	51.48	-16.72	68.2	44.16	32.19	6.35	31.22	386	114	P	V
		5700	59.01	-46.19	105.2	51.63	32.27	6.36	31.25	386	114	P	V
		5718.8	62.93	-47.53	110.46	55.51	32.31	6.37	31.26	386	114	P	V
		5720.8	62.66	-49.96	112.62	55.24	32.31	6.37	31.26	386	114	P	V
	*	5775	99.81	-	-	92.32	32.39	6.38	31.28	386	114	P	V
	*	5775	89.19	-	-	81.7	32.39	6.38	31.28	386	114	A	V
		5854	59.98	-53.1	113.08	52.37	32.51	6.42	31.32	386	114	P	V
		5858.4	58.95	-50.9	109.85	51.35	32.51	6.42	31.33	386	114	P	V
		5875.6	52.99	-51.76	104.75	45.36	32.53	6.43	31.33	386	114	P	V
		5937.4	50.56	-17.64	68.2	42.85	32.6	6.48	31.37	386	114	P	V
													V
													V
Remark	1. No other spurious found. 2. All results are PASS against Peak and Average limit line.												



Band 4 5725~5850MHz

WIFI 802.11ac VHT80 (Harmonic @ 3m)

WIFI Ant. 1	Note	Frequency (MHz)	Level (dBμV/m)	Over Limit (dB)	Limit Line (dBμV/m)	Read Level (dBμV)	Antenna Factor (dB/m)	Path Loss (dB)	Preamp Factor (dB)	Ant Pos (cm)	Table Pos (deg)	Peak Avg. (P/A)	Pol. (H/V)	
802.11ac VHT80 CH 155 5775MHz		11550	47.35	-26.65	74	62.39	39.98	10.36	65.38	100	0	P	H	
		17325	48.68	-19.52	68.2	58.21	41.84	12.79	64.16	100	0	P	H	
													H	
													H	
			11550	47.14	-26.86	74	62.18	39.98	10.36	65.38	100	0	P	V
			17325	50.52	-17.68	68.2	60.05	41.84	12.79	64.16	100	0	P	V
														V
Remark	1. No other spurious found. 2. All results are PASS against Peak and Average limit line.													



Emission below 1GHz

5GHz WIFI 802.11n HT40 (LF @ 3m)

WIFI	Note	Frequency	Level	Over	Limit	Read	Antenna	Path	Preamp	Ant	Table	Peak	Pol.	
Ant.				Limit	Line	Level	Factor	Loss	Factor	Pos	Pos	Avg.		
1		(MHz)	(dBμV/m)	(dB)	(dBμV/m)	(dBμV)	(dB/m)	(dB)	(dB)	(cm)	(deg)	(P/A)	(H/V)	
5GHz 802.11n HT40 LF		99.12	21.38	-22.12	43.5	34.9	16.03	0.85	30.4			P	H	
		193.08	23.35	-20.15	43.5	37.31	15.04	1.28	30.28			P	H	
		256.26	24.09	-21.91	46	33.32	19.5	1.47	30.2			P	H	
		568.1	28.37	-17.63	46	30.29	25.75	2.03	29.7			P	H	
		746.6	41.2	-4.8	46	40.38	27.95	2.31	29.44	100	0	P	H	
		979	34.91	-19.09	54	30.46	30.69	2.76	29			P	H	
													H	
													H	
													H	
													H	
													H	
													H	
			30.54	26.31	-13.69	40	32.1	23.96	0.44	30.19			P	V
			94.26	24.7	-18.8	43.5	38.79	15.46	0.86	30.41			P	V
			195.51	21.06	-22.44	43.5	34.98	15.08	1.28	30.28			P	V
			467.3	26.27	-19.73	46	30.84	23.49	1.79	29.85			P	V
			734.7	39.45	-6.55	46	38.99	27.64	2.28	29.46	100	0	P	V
			953.8	35.68	-10.32	46	31.19	30.81	2.73	29.05			P	V
													V	
													V	
													V	
													V	
													V	
													V	
Remark	1. No other spurious found. 2. All results are PASS against limit line.													



Note symbol

*	Fundamental Frequency which can be ignored. However, the level of any unwanted emissions shall not exceed the level of the fundamental frequency.
!	Test result is over limit line.
P/A	Peak or Average
H/V	Horizontal or Vertical



A calculation example for radiated spurious emission is shown as below:

WIFI	Note	Frequency	Level	Over	Limit	Read	Antenna	Path	Preamp	Ant	Table	Peak	Pol.
Ant.				Limit	Line	Level	Factor	Loss	Factor	Pos	Pos	Avg.	
1		(MHz)	(dBμV/m)	(dB)	(dBμV/m)	(dBμV)	(dB/m)	(dB)	(dB)	(cm)	(deg)	(P/A)	(H/V)
802.11b		2390	55.45	-18.55	74	54.51	32.22	4.58	35.86	103	308	P	H
CH 01													
2412MHz		2390	43.54	-10.46	54	42.6	32.22	4.58	35.86	103	308	A	H

1. Path Loss(dB) = Cable loss(dB) + Filter loss(dB) + Attenuator loss(dB)
2. Level(dBμV/m) = Antenna Factor(dB/m) + Path Loss(dB) + Read Level(dBμV) - Preamp Factor(dB)
3. Over Limit(dB) = Level(dBμV/m) – Limit Line(dBμV/m)

For Peak Limit @ 2390MHz:

1. Level(dBμV/m)
= Antenna Factor(dB/m) + Path Loss(dB) + Read Level(dBμV) - Preamp Factor(dB)
= 32.22(dB/m) + 4.58(dB) + 54.51(dBμV) – 35.86 (dB)
= 55.45 (dBμV/m)
2. Over Limit(dB)
= Level(dBμV/m) – Limit Line(dBμV/m)
= 55.45(dBμV/m) – 74(dBμV/m)
= -18.55(dB)

For Average Limit @ 2390MHz:

1. Level(dBμV/m)
= Antenna Factor(dB/m) + Path Loss(dB) + Read Level(dBμV) - Preamp Factor(dB)
= 32.22(dB/m) + 4.58(dB) + 42.6(dBμV) – 35.86 (dB)
= 43.54 (dBμV/m)
2. Over Limit(dB) = Level(dBμV/m) – Limit Line(dBμV/m)
= 43.54(dBμV/m) – 54(dBμV/m)
= -10.46(dB)

Both peak and average measured complies with the limit line, so test result is “PASS”.



Appendix D. Radiated Spurious Emission Plots

Test Engineer :	Watt Tseng, Karl Hou, and Nick Yu	Temperature :	21~23°C
		Relative Humidity :	57~60%

Band 4 - 5725~5850MHz
WIFI 802.11a (Band Edge @ 3m)

WIFI	Band 4 5725~5850MHz Band Edge @ 3m	
ANT	802.11a CH149 5745MHz	
1	Horizontal	Fundamental
Peak	<p>Site : 03CH12-IY Condition : PEAK_BE(B4)_16-24 3m HORN_9120D_1328 HORIZONTAL : RBW:1000.000kHz VBW:3000.000kHz SWT:Auto</p>	<p>Site : 03CH12-IY Condition : PEAK(UNIT) 3m HORN_9120D_1328 HORIZONTAL : RBW:1000.000kHz VBW:3000.000kHz SWT:Auto</p>



WIFI	Band 4 5725~5850MHz Band Edge @ 3m	
ANT	802.11a CH149 5745MHz	
1	Vertical	Fundamental
Peak	<p>Site : 03CH12-HY Condition : PEAK_18(03_12_24) 3m HORN_91200_1328 VERTICAL : RBW:1000.000kHz VBW:3000.000kHz SWT:Auto</p>	<p>Site : 03CH12-HY Condition : PEAK(0305) 3m HORN_91200_1328 VERTICAL : RBW:1000.000kHz VBW:3000.000kHz SWT:Auto</p>



WIFI	Band 4 5725~5850MHz Band Edge @ 3m	
ANT	802.11a CH157 5785MHz	
1	Horizontal	Fundamental
Peak		
Peak		Left blank



WIFI	Band 4 5725~5850MHz Band Edge @ 3m	
ANT	802.11a CH157 5785MHz	
1	Vertical	Fundamental
Peak		
Peak		Left blank



WIFI	Band 4 5725~5850MHz Band Edge @ 3m	
ANT	802.11a CH165 5825MHz	
1	Horizontal	Fundamental
Peak	<p>Site : 03CH12-HV Condition : PEAK_BE(B4)_16-24 3m HORN_91200_1328 HORIZONTAL : RBW:1000.000kHz VBW:3000.000kHz SWT:Auto</p>	<p>Site : 03CH12-HV Condition : PEAK(UNIT) 3m HORN_91200_1328 HORIZONTAL : RBW:1000.000kHz VBW:3000.000kHz SWT:Auto</p>



WIFI	Band 4 5725~5850MHz Band Edge @ 3m	
ANT	802.11a CH165 5825MHz	
1	Vertical	Fundamental
Peak	<p>Site : 03CH12-HY Condition : PEAK_BE(B4)_16-24 3m HORN_91200_1326 VERTICAL : RBW:1000.000kHz VBW:3000.000kHz SWT:Auto</p>	<p>Site : 03CH12-HY Condition : PEAK(UMB) 3m HORN_91200_1326 VERTICAL : RBW:1000.000kHz VBW:3000.000kHz SWT:Auto</p>

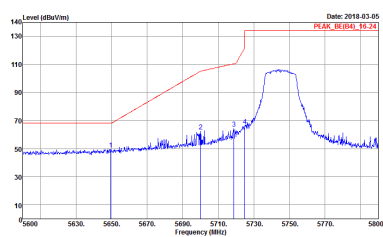
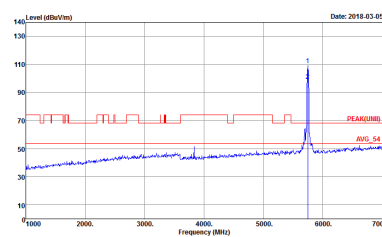

Band 4 5725~5850MHz
WIFI 802.11n HT20 (Band Edge @ 3m)

WIFI	Band 4 5725~5850MHz Band Edge @ 3m	
ANT	802.11n HT20 CH149 5745MHz	
1	Horizontal	Fundamental
Peak	 <p>Site Condition : 03:CH12-44Y : PEAK_BE(B4)_16-24 3m HORN_9120D_1328 HORIZONTAL : RBW:1000.000KHz VBW:3000.000KHz SWT:Auto</p>	 <p>Site Condition : 03:CH12-44Y : PEAK(UNIT) 3m HORN_9120D_1328 HORIZONTAL : RBW:1000.000KHz VBW:3000.000KHz SWT:Auto</p>



WIFI	Band 4 5725~5850MHz Band Edge @ 3m	
ANT	802.11n HT20 CH149 5745MHz	
1	Vertical	Fundamental
Peak	<p>Site : 03CH12-HY Condition : PEAK_BEB[4], 16-24 3m HORN, 91200, 1328 VERTICAL : RBW:1000.000kHz VBW:3000.000kHz SWT:Auto</p>	<p>Site : 03CH12-HY Condition : PEAK[UNIT] 3m HORN, 91200, 1328 VERTICAL : RBW:1000.000kHz VBW:3000.000kHz SWT:Auto</p>



WIFI	Band 4 5725~5850MHz Band Edge @ 3m	
ANT	802.11n HT20 CH157 5785MHz	
1	Horizontal	Fundamental
Peak		
Peak		Left blank



WIFI	Band 4 5725~5850MHz Band Edge @ 3m	
ANT	802.11n HT20 CH157 5785MHz	
1	Vertical	Fundamental
Peak		
Peak		Left blank



WIFI	Band 4 5725~5850MHz Band Edge @ 3m	
ANT	802.11n HT20 CH165 5825MHz	
1	Horizontal	Fundamental
Peak	<p>Site : 03CH12-HY Condition : PEAK_BE(B4)_16-24 3m HORN_91200_1328 HORIZONTAL : RBW:1000.000kHz VBW:3000.000kHz SWT:Auto</p>	<p>Site : 03CH12-HY Condition : PEAK(FUNTI) 3m HORN_91200_1328 HORIZONTAL : RBW:1000.000kHz VBW:3000.000kHz SWT:Auto</p>



WIFI	Band 4 5725~5850MHz Band Edge @ 3m	
ANT	802.11n HT20 CH165 5825MHz	
1	Vertical	Fundamental
Peak	<p>Site : 03CH12-HY Condition : PEAK_BE(B4)_16-24 3m HORN_91200_1328 VERTICAL : RBW:1000.000kHz VBW:3000.000kHz SWT:Auto</p>	<p>Site : 03CH12-HY Condition : PEAK(UNIT) 3m HORN_91200_1328 VERTICAL : RBW:1000.000kHz VBW:3000.000kHz SWT:Auto</p>



**Band 4 5725~5850MHz
WIFI 802.11n HT40 (Band Edge @ 3m)**

WIFI	Band 4 5725~5850MHz Band Edge @ 3m	
ANT	802.11n HT40 CH151 5755MHz	
1	Horizontal	Fundamental
Peak	<p>Site : 03CH12-HY Condition : PEAK_BE(B4)_16-24 3m HORN_9120D_1328 HORIZONTAL : RBW:1000.000KHz VBW:3000.000KHz SWT:Auto</p>	<p>Site : 03CH12-HY Condition : PEAK(UNIT) 3m HORN_9120D_1328 HORIZONTAL : RBW:1000.000KHz VBW:3000.000KHz SWT:Auto</p>
Peak	<p>Site : 03CH12-HY Condition : PEAK_BE(B4)_16-24 3m HORN_9120D_1328 HORIZONTAL : RBW:1000.000KHz VBW:3000.000KHz SWT:Auto</p>	Left blank



WIFI	Band 4 5725~5850MHz Band Edge @ 3m	
ANT	802.11n HT40 CH151 5755MHz	
1	Vertical	Fundamental
Peak		
Peak		Left blank



WIFI	Band 4 5725~5850MHz Band Edge @ 3m	
ANT	802.11n HT40 CH159 5795MHz	
1	Horizontal	Fundamental
Peak	<p>Site : 03CH12-HY Condition : PEAK_BE(B4)_16-24 3m HORN_91200_1328 HORIZONTAL : RBW:1000.000KHz VBW:3000.000KHz SWT:Auto</p>	<p>Site : 03CH12-HY Condition : PEAK(UWB) 3m HORN_91200_1328 HORIZONTAL : RBW:1000.000KHz VBW:3000.000KHz SWT:Auto</p>
Peak	<p>Site : 03CH12-HY Condition : PEAK_BE(B4)_16-24 3m HORN_91200_1328 HORIZONTAL : RBW:1000.000KHz VBW:3000.000KHz SWT:Auto</p>	Left blank



WIFI	Band 4 5725~5850MHz Band Edge @ 3m	
ANT	802.11n HT40 CH159 5795MHz	
1	Vertical	Fundamental
Peak	<p>Site : 03CH12-HY Condition : PEAK_BE(B4)_16-24 3m HORN_9120D_1328 VERTICAL : RBW:1000.000kHz VBW:3000.000kHz SWT:Auto</p>	<p>Site : 03CH12-HY Condition : PEAK(UNIT) 3m HORN_9120D_1328 VERTICAL : RBW:1000.000kHz VBW:3000.000kHz SWT:Auto</p>
Peak	<p>Site : 03CH12-HY Condition : PEAK_BE(B4)_16-24 3m HORN_9120D_1328 VERTICAL : RBW:1000.000kHz VBW:3000.000kHz SWT:Auto</p>	Left blank



Band 4 5725~5850MHz
WIFI 802.11ac VHT80 (Band Edge @ 3m)

WIFI	Band 4 5725~5850MHz Band Edge @ 3m	
ANT	802.11ac VHT80 CH155 5775MHz	
1	Horizontal	Fundamental
Peak	<p>Site Condition : 03CH12-HY : PEAK_BE(B4)_16-24 3m HORN_9120D_1328 HORIZONTAL : RBW:1000.000kHz VBW:3000.000kHz SWT:Auto</p>	<p>Site Condition : 03CH12-HY : PEAK(UNIT) 3m HORN_9120D_1328 HORIZONTAL : RBW:1000.000kHz VBW:3000.000kHz SWT:Auto</p>
Peak	<p>Site Condition : 03CH12-HY : PEAK_BE(B4)_16-24 3m HORN_9120D_1328 HORIZONTAL : RBW:1000.000kHz VBW:3000.000kHz SWT:Auto</p>	Left blank

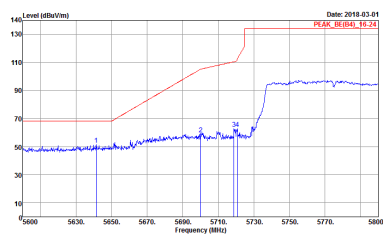
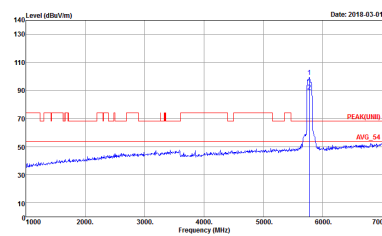
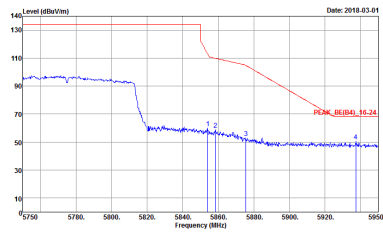

WIFI	Band 4 5725~5850MHz Band Edge @ 3m	
ANT	802.11ac VHT80 CH155 5775MHz	
1	Vertical	Fundamental
Peak	 <p>Site : 03CH12-HY Condition : PEAK_BE(B4)_16-24 3m HORN_9120D_1328 VERTICAL : RBW:1000.000KHz VBW:3000.000KHz SWT:Auto</p>	 <p>Site : 03CH12-HY Condition : PEAK(UWB) 3m HORN_9120D_1328 VERTICAL : RBW:1000.000KHz VBW:3000.000KHz SWT:Auto</p>
Peak	 <p>Site : 03CH12-HY Condition : PEAK_BE(B4)_16-24 3m HORN_9120D_1328 VERTICAL : RBW:1000.000KHz VBW:3000.000KHz SWT:Auto</p>	Left blank

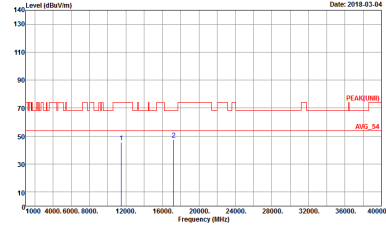
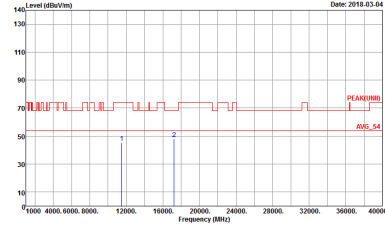

Band 4 - 5725~5850MHz
WIFI 802.11a (Harmonic @ 3m)

WIFI	Band 4 5725~5850MHz Harmonic @ 3m	
ANT	802.11a CH149 5745MHz	
1	Horizontal	Vertical
<p>Peak Avg.</p>	 <p>Site : 03CH12-HY Condition : PEAK(UNIT) 3m HORN_9120D_1328 HORIZONTAL Detector : Peak</p>	 <p>Site : 03CH12-HY Condition : PEAK(UNIT) 3m HORN_9120D_1328 VERTICAL Detector : Peak</p>



WIFI	Band 4 5725~5850MHz Harmonic @ 3m	
ANT	802.11a CH157 5785MHz	
1	Horizontal	Vertical
Peak Avg.	<p>Site : 03CH12-HY Condition : PEAK(UNIT) 3m HORN_9120D_1328 HORIZONTAL Detector : Peak</p>	<p>Site : 03CH12-HY Condition : PEAK(UNIT) 3m HORN_9120D_1328 VERTICAL Detector : Peak</p>



WIFI	Band 4 5725~5850MHz Harmonic @ 3m	
ANT	802.11a CH165 5825MHz	
1	Horizontal	Vertical
Peak Avg.	<p>Site : 03CH12-HY Condition : PEAK(UNIT) 3m HORN_9120D_1328 HORIZONTAL Detector : Peak</p>	<p>Site : 03CH12-HY Condition : PEAK(UNIT) 3m HORN_9120D_1328 VERTICAL Detector : Peak</p>



**Band 4 5725~5850MHz
WIFI 802.11n HT20 (Harmonic @ 3m)**

WIFI	Band 4 5725~5850MHz Harmonic @ 3m	
ANT	802.11n HT20 CH149 5745MHz	
1	Horizontal	Vertical
Peak Avg.	<p>Site : 03CH12-HY Condition : PEAK(UNIT) 3m HORN_9120D_1328 HORIZONTAL Detector : Peak</p>	<p>Site : 03CH12-HY Condition : PEAK(UNIT) 3m HORN_9120D_1328 VERTICAL Detector : Peak</p>



WIFI	Band 4 5725~5850MHz Harmonic @ 3m	
ANT	802.11n HT20 CH157 5785MHz	
1	Horizontal	Vertical
Peak Avg.	<p>Site : 03CH12-HY Condition : PEAK(UNIT) 3m HORN_9120D_1328 HORIZONTAL Detector : Peak</p>	<p>Site : 03CH12-HY Condition : PEAK(UNIT) 3m HORN_9120D_1328 VERTICAL Detector : Peak</p>



WIFI	Band 4 5725~5850MHz Harmonic @ 3m	
ANT	802.11n HT20 CH165 5825MHz	
1	Horizontal	Vertical
Peak Avg.	<p>Site : 03CH12-HY Condition : PEAK(UNIT) 3m HORN_9120D_1328 HORIZONTAL Detector : Peak</p>	<p>Site : 03CH12-HY Condition : PEAK(UNIT) 3m HORN_9120D_1328 VERTICAL Detector : Peak</p>



**Band 4 5725~5850MHz
WIFI 802.11n HT40 (Harmonic @ 3m)**

WIFI	Band 4 5725~5850MHz Harmonic @ 3m	
ANT	802.11n HT40 CH151 5755MHz	
1	Horizontal	Vertical
Peak Avg.	<p>Site : 03CH12-HY Condition : PEAK(UNIT) 3m HORN_9120D_1328 HORIZONTAL Detector : Peak</p>	<p>Site : 03CH12-HY Condition : PEAK(UNIT) 3m HORN_9120D_1328 VERTICAL Detector : Peak</p>



WIFI	Band 4 5725~5850MHz Harmonic @ 3m	
ANT	802.11n HT40 CH159 5795MHz	
1	Horizontal	Vertical
Peak Avg.	<p>Site : 03CH12-HY Condition : PEAK(UNIT) 3m HORN_9120D_1328 HORIZONTAL Detector : Peak</p>	<p>Site : 03CH12-HY Condition : PEAK(UNIT) 3m HORN_9120D_1328 VERTICAL Detector : Peak</p>



Band 4 5725~5850MHz
WIFI 802.11ac VHT80 (Harmonic @ 3m)

WIFI	Band 4 5725~5850MHz Harmonic @ 3m	
ANT	802.11ac VHT80 CH155 5775MHz	
1	Horizontal	Vertical
Peak Avg.	<p>Site : 03CH12-HY Condition : PEAK(UNIT) 3m HORN_9120D_1328 HORIZONTAL Detector : Peak</p>	<p>Site : 03CH12-HY Condition : PEAK(UNIT) 3m HORN_9120D_1328 VERTICAL Detector : Peak</p>



Emission below 1GHz
5GHz WIFI 802.11n HT40 (LF)

WIFI	5GHz 5725~5850MHz	
ANT	802.11n HT40 LF	
1	Horizontal	Vertical
QP / Peak	<p>Site : 03CH12-HY Condition : QP 3m BIL06_6111D_40103 HORIZONTAL Detector : Peak</p>	<p>Site : 03CH12-HY Condition : QP 3m BIL06_6111D_40103 VERTICAL Detector : Peak</p>



Appendix E. Duty Cycle Plots

Band	Duty Cycle (%)	T(us)	1/T(kHz)	VBW Setting	Duty Factor(dB)
802.11a	94.98	2.080	0.48	1KHz	0.22
5GHz 802.11n HT20	94.38	1.930	0.52	1KHz	0.25
5GHz 802.11n HT40	90.48	950	1.05	3KHz	0.43
5GHz 802.11ac VHT20	94.15	1930	0.52	1KHz	0.26
5GHz 802.11ac VHT40	90.48	950	1.05	3KHz	0.43
5GHz 802.11ac VHT80	86.05	740	1.35	3KHz	0.65



802.11a

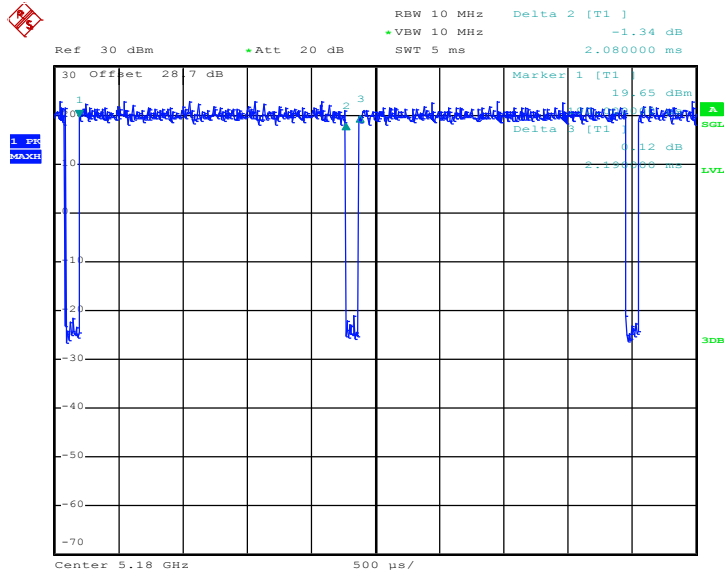

Date: 12.FEB.2018 13:51:57

802.11n HT20

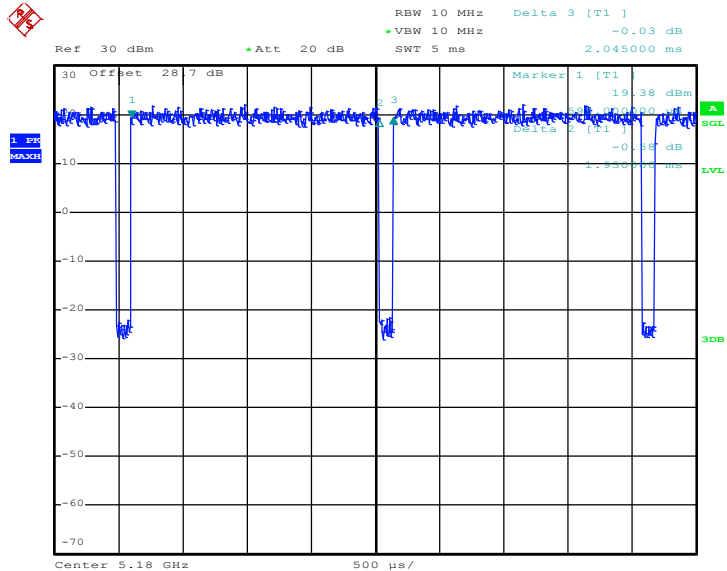

Date: 12.FEB.2018 14:14:42



802.11n HT40

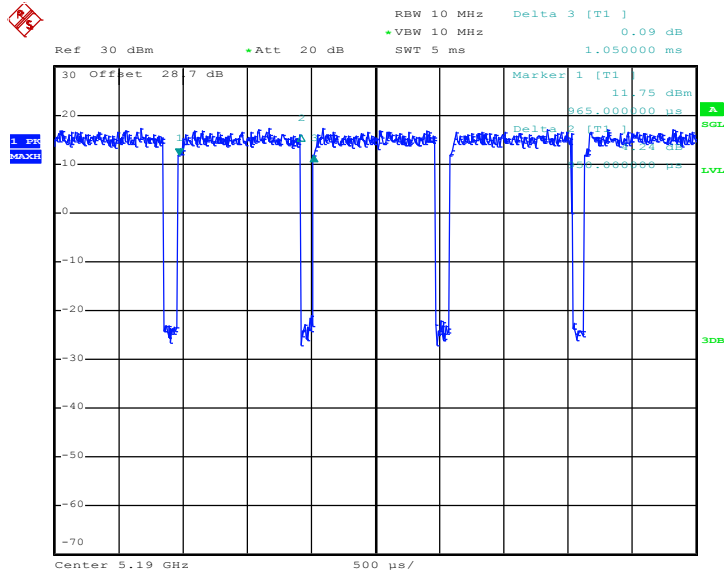

Date: 12.FEB.2018 14:22:34

802.11ac VHT20

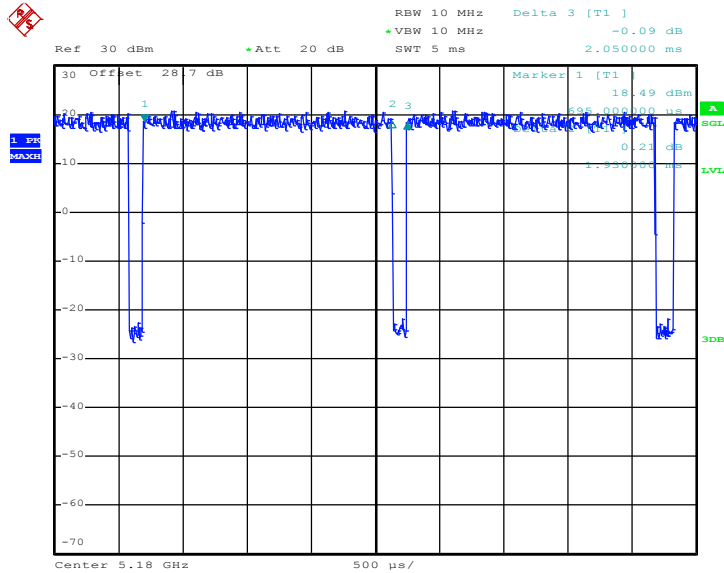

Date: 12.FEB.2018 14:35:27



802.11ac VHT40

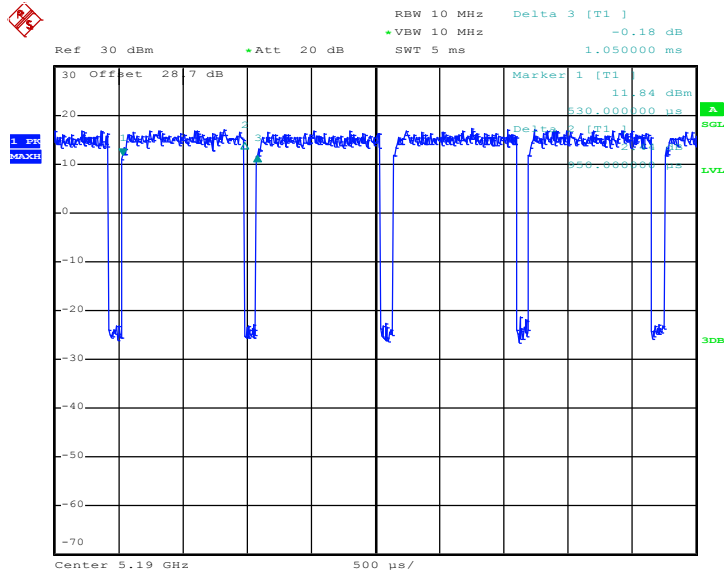

Date: 12.FEB.2018 14:46:14

802.11ac VHT80

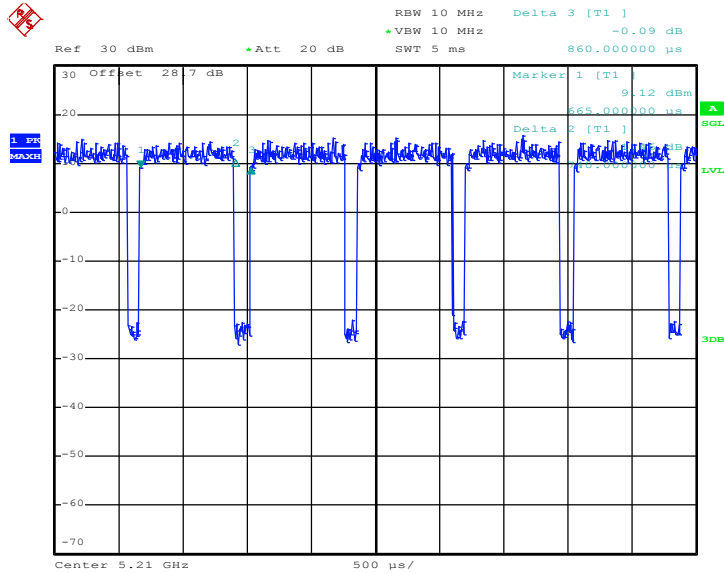

Date: 12.FEB.2018 15:10:11