

FCC SAR Test Report

APPLICANT : Motorola Mobility LLC
EQUIPMENT : Mobile Cellular Phone
BRAND NAME : Motorola
MODEL NAME : XT1925-2, XT1925-1
FCC ID : IHDT56XD5
STANDARD : FCC 47 CFR Part 2 (2.1093)
ANSI/IEEE C95.1-1992
IEEE 1528-2013

We, Sporton International (Kunshan) Inc., would like to declare that the tested sample has been evaluated in accordance with the procedures and had been in compliance with the applicable technical standards.

The test results in this report apply exclusively to the tested model / sample. Without written approval of Sporton International (Kunshan) Inc., the test report shall not be reproduced except in full.



Approved by: Mark Qu / Manager



Sporton International (Kunshan) Inc.

No.3-2 Ping-Xiang Rd, Kunshan Development Zone Kunshan City Jiangsu Province 215335 China



Table of Contents

1. Statement of Compliance 4
2. Administration Data 5
3. Guidance Applied..... 5
4. Equipment Under Test (EUT) Information 6
4.1 General Information 6
4.2 Specification of Accessory 8
4.3 General LTE SAR Test and Reporting Considerations 9
5. Re-use of Measured Data 11
5.1 Introduction Section 11
5.2 Difference Section 11
5.3 Spot Check Verification Data Section 12
5.4 Reference detail Section 12
6. RF Exposure Limits..... 13
6.1 Uncontrolled Environment 13
6.2 Controlled Environment 13
7. Specific Absorption Rate (SAR)..... 14
7.1 Introduction 14
7.2 SAR Definition 14
8. System Description and Setup 15
8.1 E-Field Probe 16
8.2 Data Acquisition Electronics (DAE) 16
8.3 Phantom 17
8.4 Device Holder 18
9. Measurement Procedures 19
9.1 Spatial Peak SAR Evaluation 19
9.2 Power Reference Measurement 20
9.3 Area Scan 20
9.4 Zoom Scan 21
9.5 Volume Scan Procedures 21
9.6 Power Drift Monitoring 21
10. Test Equipment List 22
11. System Verification 23
11.1 Tissue Simulating Liquids 23
11.2 Tissue Verification 24
11.3 System Performance Check Results 25
12. RF Exposure Positions 26
12.1 Ear and handset reference point 26
12.2 Definition of the cheek position 27
12.3 Definition of the tilt position 28
12.4 Body Worn Accessory 29
12.5 Product Specific 10g SAR Exposure 30
12.6 Wireless Router 30
13. Conducted RF Output Power (Unit: dBm) 31
14. Antenna Location 35
15. SAR Test Results 37
15.1 Head SAR 39
15.2 Hotspot SAR 40
15.3 Body Worn Accessory SAR 41
15.4 Product specific 10g SAR 42
16. Simultaneous Transmission Analysis 43
16.1 Head Exposure Conditions 44
16.2 Hotspot Exposure Conditions 45
16.3 Body-Worn Accessory Exposure Conditions 47
16.4 Product specific 10g SAR Exposure Conditions 48
16.5 SPLSR Evaluation and Analysis 49
17. Uncertainty Assessment 53
18. References 54
Appendix A. Plots of System Performance Check
Appendix B. Plots of High SAR Measurement
Appendix C. DASYS Calibration Certificate
Appendix D. Test Setup Photos
Appendix E. Reference Report



Revision History

REPORT NO.	VERSION	DESCRIPTION	ISSUED DATE
FA7D2507-03	Rev. 01	Initial issue of report	Feb. 05, 2018



1. Statement of Compliance

The maximum results of Specific Absorption Rate (SAR) found during testing for Motorola Mobility LLC, Mobile Cellular Phone, XT1925-2, XT1925-1, are as follows.

Highest 1g SAR Summary						
Equipment Class	Frequency Band		Head (Separation 0mm)	Hotspot (Separation 5mm)	Body-worn (Separation 5mm)	Highest Simultaneous Transmission 1g SAR (W/kg)
			1g SAR (W/kg)			
Licensed	GSM	GSM850	0.42	1.14	1.14	1.56
		GSM1900	0.15	1.07	0.79	
	WCDMA	Band V	0.44	0.94	0.94	
		Band IV	0.49	1.03	0.78	
		Band II	0.32	1.06	0.68	
	LTE	Band 12/Band 17	0.34	0.66	0.66	
		Band 5	0.36	1.05	1.05	
		Band 4	0.32	0.93	0.60	
		Band 2	0.25	1.08	0.70	
		Band 7	0.86	0.96	0.96	
DTS	WLAN	2.4GHz WLAN	0.74	0.43	0.43	1.47
NII		5GHz WLAN	0.99	0.82	0.85	1.56
DSS	Bluetooth	2.4GHz Bluetooth		0.11	0.11	1.22
Highest 10g SAR Summary						
Equipment Class	Frequency Band		Product Specific 10g SAR (W/kg) (Separation 0mm)			Highest Simultaneous Transmission 10g SAR (W/kg)
Licensed	GSM	GSM1900	3.40			3.67
	WCDMA	Band IV	2.78			
		Band II	2.86			
	LTE	Band 4	3.40			
		Band 2	3.62			
		Band 7	1.11			
NII	WLAN	5GHz WLAN	0.54			3.67
Date of Testing:			2018/1/18~2018/1/20			

Remark: This device supports both LTE B17 and B12. Since the supported frequency span for LTE B17 falls completely within the supports frequency span for LTE B12, both LTE bands have the same target power, and both LTE bands share the same transmission path; therefore, SAR was only assessed for LTE B12.

This device is in compliance with Specific Absorption Rate (SAR) for general population/uncontrolled exposure limits (1.6 W/kg for Partial-Body 1g SAR, 4.0 W/kg for Product Specific 10g SAR) specified in FCC 47 CFR part 2 (2.1093) and ANSI/IEEE C95.1-1992, and had been tested in accordance with the measurement methods and procedures specified in IEEE 1528-2013 and FCC KDB publications.



2. Administration Data

Testing Laboratory	
Test Site	Sporton International (Kunshan) Inc.
Test Site Location	No.3-2 Ping-Xiang Rd, Kunshan Development Zone Kunshan City Jiangsu Province 215335 China TEL : +86-512-57900158 FAX : +86-512-57900958

Applicant	
Company Name	Motorola Mobility LLC
Address	222 W,Merchandise Mart Plaza, Chicago IL 60654 USA

Manufacturer	
Company Name	Motorola Mobility LLC
Address	222 W, Merchandise Mart Plaza, Chicago IL 60654 USA

3. Guidance Applied

The Specific Absorption Rate (SAR) testing specification, method, and procedure for this device is in accordance with the following standards:

- FCC 47 CFR Part 2 (2.1093)
- ANSI/IEEE C95.1-1992
- IEEE 1528-2013
- FCC KDB 865664 D01 SAR Measurement 100 MHz to 6 GHz v01r04
- FCC KDB 865664 D02 SAR Reporting v01r02
- FCC KDB 447498 D01 General RF Exposure Guidance v06
- FCC KDB 648474 D04 SAR Evaluation Considerations for Wireless Handsets v01r03
- FCC KDB 248227 D01 802.11 Wi-Fi SAR v02r02
- FCC KDB 941225 D01 3G SAR Procedures v03r01
- FCC KDB 941225 D05 SAR for LTE Devices v02r05
- FCC KDB 941225 D06 Hotspot Mode SAR v02r01



4. Equipment Under Test (EUT) Information

4.1 General Information

Product Feature & Specification	
Equipment Name	Mobile Cellular Phone
Brand Name	Motorola
Model Name	XT1925-2, XT1925-1
FCC ID	IHDT56XD5
IMEI Code	SIM1: 351847090011353 SIM2: 351847090011361
Wireless Technology and Frequency Range	GSM850: 824.2 MHz ~ 848.8 MHz GSM1900: 1850.2 MHz ~ 1909.8 MHz WCDMA Band II: 1852.4 MHz ~ 1907.6 MHz WCDMA Band IV: 1712.4 MHz ~ 1752.6 MHz WCDMA Band V: 826.4 MHz ~ 846.6 MHz LTE Band 2: 1850.7 MHz ~ 1909.3 MHz LTE Band 4: 1710.7 MHz ~ 1754.3 MHz LTE Band 5: 824.7 MHz ~ 848.3 MHz LTE Band 7: 2502.5 MHz ~ 2567.5 MHz LTE Band 12: 699.7 MHz ~ 715.3 MHz LTE Band 17: 706.5 MHz ~ 713.5 MHz WLAN 2.4GHz Band: 2412 MHz ~ 2462 MHz WLAN 5.2GHz Band: 5180 MHz ~ 5240 MHz WLAN 5.3GHz Band: 5260 MHz ~ 5320 MHz WLAN 5.5GHz Band: 5500 MHz ~ 5700 MHz WLAN 5.8GHz Band: 5745 MHz ~ 5825 MHz Bluetooth: 2402 MHz ~ 2480 MHz
Mode	GSM/GPRS/EGPRS RMC/AMR 12.2Kbps HSDPA HSUPA DC-HSDPA HSPA+ (16QAM uplink is not supported) LTE: QPSK, 16QAM, 64QAM WLAN 2.4GHz 802.11b/g/n HT20 WLAN 5GHz 802.11a/n HT20/HT40 Bluetooth v3.0+EDR, Bluetooth v4.0 LE, Bluetooth v4.1 LE, Bluetooth v4.2 LE
HW Version	DVT1-B
SW Version	ali_n-userdebug 8.0.0 OPS27.55 1276 intcfg,test-keys
GSM / (E)GPRS Transfer mode	Class B – EUT cannot support Packet Switched and Circuit Switched Network simultaneously but can automatically switch between Packet and Circuit Switched Network.
EUT Stage	Identical Prototype

Remark:

1. This device supports VoIP in GPRS, EGPRS, WCDMA and LTE (e.g. for 3rd-party VoIP), LTE supports VoLTE operation.
2. This device 2.4GHz WLAN support hotspot operation and Bluetooth support tethering applications.
3. This device 2.4GHz WLAN/5.2GHz WLAN/5.8GHz WLAN support hotspot operation, and 5.2GHz WLAN/5.8GHz WLAN supports WiFi Direct (GC/GO), and 5.3GHz / 5.5GHz supports WiFi Direct (GC only).
4. This device does not support DTM operation and supports GRPS/EGRPS mode up to multi-slot class 12.
5. When operating in any other radiated condition, the device uses the default power which is the same as full power level.
6. The device employs proximity sensors that detect the presence of the user's body at the front or back faces of the device. When front or back body worn condition is detected, GSM1900, WCDMA band II/IV and LTE band 2/4/7 reduced power will be active. (P-sensor can't work at detecting presence of the user's body at the four edges of the device.)
7. When hotspot mode is enabled, power reduction will be activated to limit the maximum power of GSM1900, WCDMA band II/IV and LTE band 2/4/7.
8. P-sensor can detect handheld state, for product specific 10g SAR condition, GSM1900, WCDMA band II/IV, LTE band



- 2/4 reduced powers will be active. For LTE band 7, the power level is the same as the full power.
9. This device hotspot reduced power and P-sensor reduced power level are the same. So only show one reduced power level for hotspot reduced power and P-sensor reduced power for this application.
 10. When the phone is in talking mode and receiver worked, then power reduction will be implemented immediately at WLAN5.2/5.3GHz.
 11. This device has three WWAN transmitter antennas. WWAN antenna 1 is located at the middle of bottom edge of the device, WWAN antenna 2 is located at the right side of bottom edge of the device, and WWAN antenna 3 is located at the left side of bottom edge of the device which can refer to antenna location chapter. WWAN antenna 1 frequency bands include GSM850/1900, WCDMA Band II/IV/V, LTE band 2/4/5/12/17, WWAN antenna 2 frequency band only includes LTE band 7 and WWAN antenna 3 frequency band also only includes LTE band 7.
 12. The device is capable of switching between the WWAN antenna 2 and WWAN antenna 3 based on signal strength. When WWAN antenna 2 acted as a transmitter, then WWAN antenna 3 acted as a receiver. The same as the reversed.
 13. There are two different types of EUT. They are dual SIM card mobile (XT1925-2) and single SIM card mobile (XT1925-1). It is special to declare. The others are the same including circuit design, PCB board, structure and all components. After pre-scan two types of EUT, we found test result of the sample that dual SIM was the worst, so we chose dual SIM card mobile to perform all tests.
 14. The dual SIM card mobile has 2 SIM slots and supports dual SIM dual standby. The WWAN radio transmission will be enabled by either one SIM at a time (single active). After pre-scan two SIM cards power, we found test result of the SIM1 was the worse, so we chose dual SIM1 card to perform all tests.
 15. This device implements antenna tuning techniques for several WWAN (cellular) operating modes and frequencies for the purpose of improving antenna efficiency over a broad range of frequencies. Specifically, these techniques are employed in the GSM, WCDMA and LTE modes of WWAN antenna 1.

4.2 Specification of Accessory

Specification of Accessory			
AC Adapter 1(US)	Brand Name	Motorola (Salom)	Model Name SC-22
	Power Rating	I/P: 100-240 Vac, 500mA, O/P: 5Vdc,3000mA or 9Vdc,1600mA or 12Vdc,1200mA	
AC Adapter 1(EU)	Brand Name	Motorola (Salom)	Model Name SC-23
	Power Rating	I/P: 100-240 Vac, 500mA, O/P: 5Vdc,3000mA or 9Vdc,1600mA or 12Vdc,1200mA	
AC Adapter 1(UK)	Brand Name	Motorola (Salom)	Model Name SC-24
	Power Rating	I/P: 100-240 Vac, 500mA, O/P: 5Vdc,3000mA or 9Vdc,1600mA or 12Vdc,1200mA	
AC Adapter 1(IN)	Brand Name	Motorola (Salom)	Model Name SC-25
	Power Rating	I/P: 100-240 Vac, 500mA, O/P: 5Vdc,3000mA or 9Vdc,1600mA or 12Vdc,1200mA	
AC Adapter 1(AU)	Brand Name	Motorola (Salom)	Model Name SC-26
	Power Rating	I/P: 100-240 Vac, 500mA, O/P: 5Vdc,3000mA or 9Vdc,1600mA or 12Vdc,1200mA	
AC Adapter1 (AR)	Brand Name	Motorola (Salom)	Model Name SC-27
	Power Rating	I/P: 100-240 Vac, 500mA, O/P: 5Vdc,3000mA or 9Vdc,1600mA or 12Vdc,1200mA	
AC Adapter 2(US)	Brand Name	Motorola (Chenyang)	Model Name SC-22
	Power Rating	I/P: 100-240 Vac, 500mA, O/P: 5Vdc,3000mA or 9Vdc,1600mA or 12Vdc,1200mA	
AC Adapter 2(EU)	Brand Name	Motorola (Chenyang)	Model Name SC-23
	Power Rating	I/P: 100-240 Vac, 500mA, O/P: 5Vdc,3000mA or 9Vdc,1600mA or 12Vdc,1200mA	
AC Adapter 2(UK)	Brand Name	Motorola (Chenyang)	Model Name SC-24
	Power Rating	I/P: 100-240 Vac, 500mA, O/P: 5Vdc,3000mA or 9Vdc,1600mA or 12Vdc,1200mA	
AC Adapter 2(IN)	Brand Name	Motorola (Chenyang)	Model Name SC-25
	Power Rating	I/P: 100-240 Vac, 500mA, O/P: 5Vdc,3000mA or 9Vdc,1600mA or 12Vdc,1200mA	
AC Adapter 2(AU)	Brand Name	Motorola (Chenyang)	Model Name SC-26
	Power Rating	I/P: 100-240 Vac, 500mA, O/P: 5Vdc,3000mA or 9Vdc,1600mA or 12Vdc,1200mA	
AC Adapter 2(AR)	Brand Name	Motorola (Chenyang)	Model Name SC-27
	Power Rating	I/P: 100-240 Vac, 500mA, O/P: 5Vdc,3000mA or 9Vdc,1600mA or 12Vdc,1200mA	
Battery	Brand Name	Motorola (ATL)	Model Name HG30
	Power Rating	3.8Vdc,3000mAh	Type Li-ion
Earphone 1	Brand Name	Motorola (Jiahe)	Model Name LS-118M-12
	Signal Line Type	1.2 meter, non-shielded cable, without ferrite core	
Earphone 2	Brand Name	Motorola (Lianyun)	Model Name TS910A-38AMS01WHR-M
	Signal Line Type	1.2 meter, non-shielded cable, without ferrite core	
USB Cable	Brand Name	Motorola (Liqi)	Model Name L32B-053000100-ALL
	Signal Line Type	1.0 meter, shielded cable, without ferrite core	



4.3 General LTE SAR Test and Reporting Considerations

Summarized necessary items addressed in KDB 941225 D05 v02r05								
FCC ID	IHDT56XD5							
Equipment Name	Mobile Cellular Phone							
Operating Frequency Range of each LTE transmission band	LTE Band 2: 1850.7 MHz ~ 1909.3 MHz LTE Band 4: 1710.7 MHz ~ 1754.3 MHz LTE Band 5: 824.7 MHz ~ 848.3 MHz LTE Band 7: 2502.5 MHz ~ 2567.5 MHz LTE Band 12: 699.7 MHz ~ 715.3 MHz LTE Band 17: 706.5 MHz ~ 713.5 MHz							
Channel Bandwidth	LTE Band 2: 1.4MHz, 3MHz, 5MHz, 10MHz, 15MHz, 20MHz LTE Band 4: 1.4MHz, 3MHz, 5MHz, 10MHz, 15MHz, 20MHz LTE Band 5: 1.4MHz, 3MHz, 5MHz, 10MHz LTE Band 7: 5MHz, 10MHz, 15MHz, 20MHz LTE Band 12: 1.4MHz, 3MHz, 5MHz, 10MHz LTE Band 17: 5MHz, 10MHz							
Uplink Modulations Used	QPSK, 16QAM and 64QAM							
LTE Voice / Data requirements	Voice and Data							
LTE Release Version	R8, Cat4							
CA Support	Not Supported							
LTE MPR permanently built-in by design	Table 6.2.3-1: Maximum Power Reduction (MPR) for Power Class 1, 2 and 3							
	Modulation	Channel bandwidth / Transmission bandwidth (N _{RB})						MPR (dB)
		1.4 MHz	3.0 MHz	5 MHz	10 MHz	15 MHz	20 MHz	
	QPSK	> 5	> 4	> 8	> 12	> 16	> 18	≤ 1
	16 QAM	≤ 5	≤ 4	≤ 8	≤ 12	≤ 16	≤ 18	≤ 1
	16 QAM	> 5	> 4	> 8	> 12	> 16	> 18	≤ 2
	64 QAM	≤ 5	≤ 4	≤ 8	≤ 12	≤ 16	≤ 18	≤ 2
64 QAM	> 5	> 4	> 8	> 12	> 16	> 18	≤ 3	
256 QAM	≥ 1						≤ 5	
LTE A-MPR	In the base station simulator configuration, Network Setting value is set to NS_01 to disable A-MPR during SAR testing and the LTE SAR tests was transmitting on all TTI frames (Maximum TTI)							
Spectrum plots for RB configuration	A properly configured base station simulator was used for the SAR and power measurement; therefore, spectrum plots for each RB allocation and offset configuration are not included in the SAR report.							
Power reduction applied to satisfy SAR compliance	Yes 1. When hotspot mode is enabled, power reduction will be activated to limit the maximum power of LTE band 2/4/7. 2. The device employs proximity sensors that detect the presence of the user's body at the front or back faces of the device. When front or back body worn condition is detected LTE band 2/4/7 reduced power will be active. (P-sensor can't work at detecting presence of the user's body at the four edges of the device.) 3. P-sensor can detect handheld state, for product specific 10g SAR condition LTE band 2/4 reduced powers will be active. For LTE band 7, the power levels are the same as the full power.							



Transmission (H, M, L) channel numbers and frequencies in each LTE band												
LTE Band 2												
	Bandwidth 1.4 MHz		Bandwidth 3 MHz		Bandwidth 5 MHz		Bandwidth 10 MHz		Bandwidth 15 MHz		Bandwidth 20 MHz	
	Ch. #	Freq. (MHz)	Ch. #	Freq. (MHz)	Ch. #	Freq. (MHz)	Ch. #	Freq. (MHz)	Ch. #	Freq. (MHz)	Ch. #	Freq. (MHz)
L	18607	1850.7	18615	1851.5	18625	1852.5	18650	1855	18675	1857.5	18700	1860
M	18900	1880	18900	1880	18900	1880	18900	1880	18900	1880	18900	1880
H	19193	1909.3	19185	1908.5	19175	1907.5	19150	1905	19125	1902.5	19100	1900
LTE Band 4												
	Bandwidth 1.4 MHz		Bandwidth 3 MHz		Bandwidth 5 MHz		Bandwidth 10 MHz		Bandwidth 15 MHz		Bandwidth 20 MHz	
	Ch. #	Freq. (MHz)	Ch. #	Freq. (MHz)	Ch. #	Freq. (MHz)	Ch. #	Freq. (MHz)	Ch. #	Freq. (MHz)	Ch. #	Freq. (MHz)
L	19957	1710.7	19965	1711.5	19975	1712.5	20000	1715	20025	1717.5	20050	1720
M	20175	1732.5	20175	1732.5	20175	1732.5	20175	1732.5	20175	1732.5	20175	1732.5
H	20393	1754.3	20385	1753.5	20375	1752.5	20350	1750	20325	1747.5	20300	1745
LTE Band 5												
	Bandwidth 1.4 MHz		Bandwidth 3 MHz		Bandwidth 5 MHz		Bandwidth 10 MHz					
	Ch. #	Freq. (MHz)	Ch. #	Freq. (MHz)	Ch. #	Freq. (MHz)	Ch. #	Freq. (MHz)	Ch. #	Freq. (MHz)	Ch. #	Freq. (MHz)
L	20407	824.7	20415	825.5	20425	826.5	20450	829				
M	20525	836.5	20525	836.5	20525	836.5	20525	836.5				
H	20643	848.3	20635	847.5	20625	846.5	20600	844				
LTE Band 7												
	Bandwidth 5 MHz		Bandwidth 10 MHz		Bandwidth 15 MHz		Bandwidth 20 MHz					
	Ch. #	Freq. (MHz)	Ch. #	Freq. (MHz)	Ch. #	Freq. (MHz)	Ch. #	Freq. (MHz)	Ch. #	Freq. (MHz)	Ch. #	Freq. (MHz)
L	20775	2502.5	20800	2505	20825	2507.5	20850	2510				
M	21100	2535	21100	2535	21100	2535	21100	2535				
H	21425	2567.5	21400	2565	21375	2562.5	21350	2560				
LTE Band 12												
	Bandwidth 1.4 MHz		Bandwidth 3 MHz		Bandwidth 5 MHz		Bandwidth 10 MHz					
	Ch. #	Freq. (MHz)	Ch. #	Freq. (MHz)	Ch. #	Freq. (MHz)	Ch. #	Freq. (MHz)	Ch. #	Freq. (MHz)	Ch. #	Freq. (MHz)
L	23017	699.7	23025	700.5	23035	701.5	23060	704				
M	23095	707.5	23095	707.5	23095	707.5	23095	707.5				
H	23173	715.3	23165	714.5	23155	713.5	23130	711				
LTE Band 17												
	Bandwidth 5 MHz				Bandwidth 10 MHz							
	Channel #		Freq.(MHz)		Channel #		Freq. (MHz)					
L	23755		706.5		23780		709					
M	23790		710		23790		710					
H	23825		713.5		23800		711					



5. Re-use of Measured Data

5.1 Introduction Section

This application re-uses data collected on a similar device. The subject device of this application (Model: XT1925-2, XT1925-1, FCC ID: IHDT56XD5) is electrically identical to the reference device (Model: XT1925-6, XT1925-12, XT1925DL, FCC ID: IHDT56XD1) for the portions of the circuitry corresponding to the data being re-used, as treated by KDB Publication 178919 D01.

5.2 Difference Section

For details concerning the similarity with respect to component placement, mechanical/electrical design etc., please refer to the Product Equality Declaration "PED" file.

The re-used RF data includes the following bands provided in Appendix E (Sporton SAR Report No. FA7D2507 for the reference device Model: XT1925-6, XT1925-12, XT1925DL, FCC ID: IHDT56XD1):

- GSM850/1900
- WCDMA Band V/II/IV
- LTE Band 2/4/5/7/12/17
- WLAN 2.4GHz/Bluetooth

WLAN 5GHz is for full SAR test, spot check for all WWAN bands and WLAN 2.4GHz/Bluetooth are performed for ensure that SAR measurement for both device are the same. So, the original SAR value can represent this application.



5.3 Spot Check Verification Data Section

Band	BW (MHz)	Modulation	RB Size	RB Offset	Mode	Test Position	Gap (mm)	Power Mode	Ch.	Freq. (MHz)	Original model (FCC ID: IHDT56XD1)				Spot check model (FCC ID: IHDT56XD5)				Deviation
											Average Power (dBm)	Tune-Up Limit (dBm)	Measured 1g SAR (W/kg)	Reported 1g SAR (W/kg)	Average Power (dBm)	Tune-Up Limit (dBm)	Measured 1g SAR (W/kg)	Reported 1g SAR (W/kg)	
GSM850	-	-	-	-	GPRS 2 Tx slots	Front	5	Full	251	848.8	30.85	31.50	0.983	1.142	30.85	31.50	0.833	0.967	-15.32%
GSM1900	-	-	-	-	GPRS 2 Tx slots	Bottom Side	5	Hotspot On	810	1909.8	24.13	24.50	0.985	1.073	24.13	24.50	0.910	0.991	-7.64%
WCDMA Band V	-	-	-	-	RMC 12.2Kbps	Front	5	Full	4233	846.6	22.43	24.00	0.655	0.940	22.43	24.00	0.529	0.759	-19.26%
WCDMA Band IV	-	-	-	-	RMC 12.2Kbps	Bottom Side	5	Hotspot On	1513	1752.6	16.21	16.50	0.964	1.031	16.21	16.50	0.901	0.963	-6.60%
WCDMA Band II	-	-	-	-	RMC 12.2Kbps	Bottom Side	5	Hotspot On	9538	1907.6	16.10	16.50	0.967	1.060	16.10	16.50	0.965	1.058	-0.19%
LTE Band 12	10M	QPSK	1	0	-	Front	5	Full	23095	707.5	23.05	24.00	0.531	0.661	0.531	0.661	0.524	0.652	-1.36%
LTE Band 26/5	15M	QPSK	1	74	-	Front	5	Full	26865	831.5	23.82	24.00	1.010	1.053					-1.23%
LTE Band 5	10M	QPSK	1	49	-	Front	5	Full	20525	836.5					23.42	24.00	0.910	1.040	
LTE Band 66/4	20M	QPSK	1	99	-	Bottom Side	5	Hotspot On	132572	1770	14.93	15.00	0.913	0.928					-12.93%
LTE Band 4	20M	QPSK	1	0	-	Bottom Side	5	Hotspot On	20175	1732.5					14.50	15.00	0.720	0.808	
LTE Band 25/2	20M	QPSK	1	0	-	Bottom Side	5	Hotspot On	26590	1905	15.78	16.00	1.030	1.084					-3.04%
LTE Band 2	20M	QPSK	1	0	-	Bottom Side	5	Hotspot On	19100	1900					15.56	16.00	0.950	1.051	
LTE Band 7	20M	QPSK	1	0	-	Front	5	Hotspot On	20850	2510	18.25	18.50	0.907	0.961	18.25	18.50	0.763	0.808	-15.92%
WLAN2.4GHz	-	-	-	-	802.11b 1Mbps	Left Tilted	0	Full	6	2437	17.44	18.00	0.637	0.740	17.44	18.00	0.612	0.711	-17.30%
Bluetooth					1Mbps	Back	5	Full	39	2441	11.63	12.00	0.093	0.110	11.63	12.00	0.087	0.103	-6.36%

Note: In the table above, we chose the worst SAR of WWAN and WLAN 2.4GHz/BT to verify , all the deviation of SAR test results are compliant with uncertainty budget.

5.4 Reference detail Section

Reference FCC ID	Folder Test/RF Exposure	Report Title/Section
IHDT56XD1	RF Exposure(FA7D2507)	All sections applicable (for all WWAN bands and WLAN 2.4GHz/BT)

6. RF Exposure Limits

6.1 Uncontrolled Environment

Uncontrolled Environments are defined as locations where there is the exposure of individuals who have no knowledge or control of their exposure. The general population/uncontrolled exposure limits are applicable to situations in which the general public may be exposed or in which persons who are exposed as a consequence of their employment may not be made fully aware of the potential for exposure or cannot exercise control over their exposure. Members of the general public would come under this category when exposure is not employment-related; for example, in the case of a wireless transmitter that exposes persons in its vicinity.

6.2 Controlled Environment

Controlled Environments are defined as locations where there is exposure that may be incurred by persons who are aware of the potential for exposure, (i.e. as a result of employment or occupation). In general, occupational/controlled exposure limits are applicable to situations in which persons are exposed as a consequence of their employment, who have been made fully aware of the potential for exposure and can exercise control over their exposure. The exposure category is also applicable when the exposure is of a transient nature due to incidental passage through a location where the exposure levels may be higher than the general population/uncontrolled limits, but the exposed person is fully aware of the potential for exposure and can exercise control over his or her exposure by leaving the area or by some other appropriate means.

Limits for Occupational/Controlled Exposure (W/kg)

Whole-Body	Partial-Body	Hands, Wrists, Feet and Ankles
0.4	8.0	20.0

Limits for General Population/Uncontrolled Exposure (W/kg)

Whole-Body	Partial-Body	Hands, Wrists, Feet and Ankles
0.08	1.6	4.0

Whole-Body SAR is averaged over the entire body, partial-body SAR is averaged over any 1gram of tissue defined as a tissue volume in the shape of a cube. SAR for hands, wrists, feet and ankles is averaged over any 10 grams of tissue defined as a tissue volume in the shape of a cube.

7. Specific Absorption Rate (SAR)

7.1 Introduction

SAR is related to the rate at which energy is absorbed per unit mass in an object exposed to a radio field. The SAR distribution in a biological body is complicated and is usually carried out by experimental techniques or numerical modeling. The standard recommends limits for two tiers of groups, occupational/controlled and general population/uncontrolled, based on a person's awareness and ability to exercise control over his or her exposure. In general, occupational/controlled exposure limits are higher than the limits for general population/uncontrolled.

7.2 SAR Definition

The SAR definition is the time derivative (rate) of the incremental energy (dW) absorbed by (dissipated in) an incremental mass (dm) contained in a volume element (dv) of a given density (ρ). The equation description is as below:

$$SAR = \frac{d}{dt} \left(\frac{dW}{dm} \right) = \frac{d}{dt} \left(\frac{dW}{\rho dv} \right)$$

SAR is expressed in units of Watts per kilogram (W/kg)

$$SAR = \frac{\sigma |E|^2}{\rho}$$

Where: σ is the conductivity of the tissue, ρ is the mass density of the tissue and E is the RMS electrical field strength.

8. System Description and Setup

The DASY system used for performing compliance tests consists of the following items:

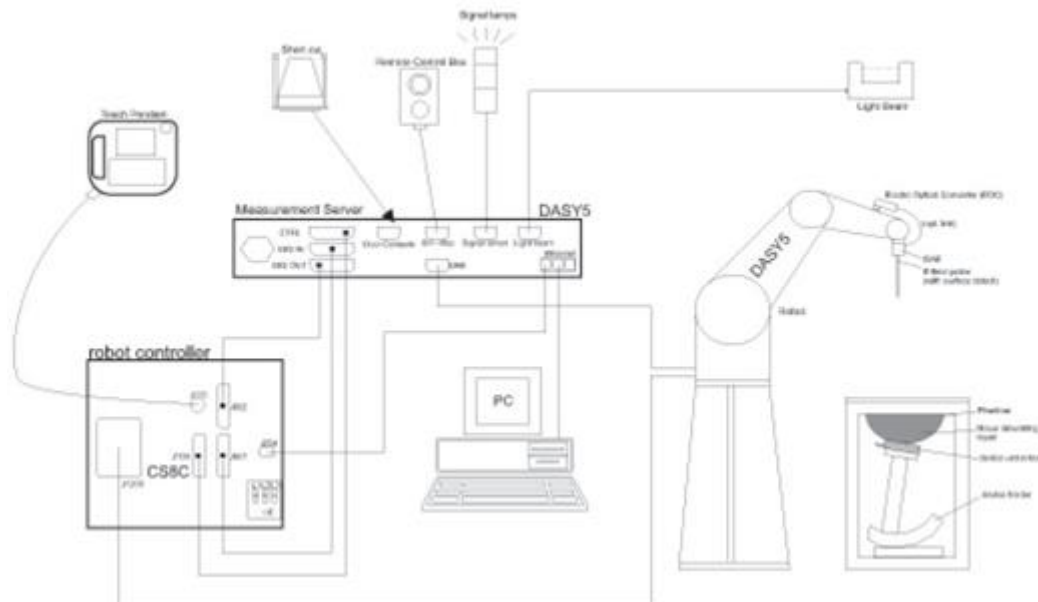

- A standard high precision 6-axis robot with controller, teach pendant and software. An arm extension for accommodating the data acquisition electronics (DAE).
- An isotropic Field probe optimized and calibrated for the targeted measurement.
- A data acquisition electronics (DAE) which performs the signal amplification, signal multiplexing, AD-conversion, offset measurements, mechanical surface detection, collision detection, etc. The unit is battery powered with standard or rechargeable batteries. The signal is optically transmitted to the EOC.
- The Electro-optical converter (EOC) performs the conversion from optical to electrical signals for the digital communication to the DAE. To use optical surface detection, a special version of the EOC is required. The EOC signal is transmitted to the measurement server.
- The function of the measurement server is to perform the time critical tasks such as signal filtering, control of the robot operation and fast movement interrupts.
- The Light Beam used is for probe alignment. This improves the (absolute) accuracy of the probe positioning.
- A computer running WinXP or Win7 and the DASY5 software.
- Remote control and teach pendant as well as additional circuitry for robot safety such as warning lamps, etc.
- The phantom, the device holder and other accessories according to the targeted measurement.

8.1 E-Field Probe

The SAR measurement is conducted with the dosimetric probe (manufactured by SPEAG). The probe is specially designed and calibrated for use in liquid with high permittivity. The dosimetric probe has special calibration in liquid at different frequency. This probe has a built in optical surface detection system to prevent from collision with phantom.

<EX3DV4 Probe>

Construction	Symmetric design with triangular core Built-in shielding against static charges PEEK enclosure material (resistant to organic solvents, e.g., DGBE)	
Frequency	10 MHz – >6 GHz Linearity: ±0.2 dB (30 MHz – 6 GHz)	
Directivity	±0.3 dB in TSL (rotation around probe axis) ±0.5 dB in TSL (rotation normal to probe axis)	
Dynamic Range	10 µW/g – >100 mW/g Linearity: ±0.2 dB (noise: typically <1 µW/g)	
Dimensions	Overall length: 337 mm (tip: 20 mm) Tip diameter: 2.5 mm (body: 12 mm) Typical distance from probe tip to dipole centers: 1 mm	

8.2 Data Acquisition Electronics (DAE)

The data acquisition electronics (DAE) consists of a highly sensitive electrometer-grade preamplifier with auto-zeroing, a channel and gain-switching multiplexer, a fast 16 bit AD-converter and a command decoder and control logic unit. Transmission to the measurement server is accomplished through an optical downlink for data and status information as well as an optical uplink for commands and the clock.

The input impedance of the DAE is 200 MOhm; the inputs are symmetrical and floating. Common mode rejection is above 80 dB.



Fig 5.1 Photo of DAE

8.3 Phantom

<SAM Twin Phantom>

Shell Thickness	2 ± 0.2 mm; Center ear point: 6 ± 0.2 mm	
Filling Volume	Approx. 25 liters	
Dimensions	Length: 1000 mm; Width: 500 mm; Height: adjustable feet	
Measurement Areas	Left Hand, Right Hand, Flat Phantom	

The bottom plate contains three pair of bolts for locking the device holder. The device holder positions are adjusted to the standard measurement positions in the three sections. A white cover is provided to tap the phantom during off-periods to prevent water evaporation and changes in the liquid parameters. On the phantom top, three reference markers are provided to identify the phantom position with respect to the robot.

<ELI Phantom>

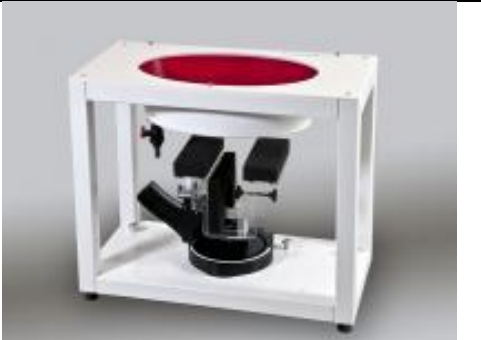
Shell Thickness	2 ± 0.2 mm (sagging: <1%)	
Filling Volume	Approx. 30 liters	
Dimensions	Major ellipse axis: 600 mm Minor axis: 400 mm	

The ELI phantom is intended for compliance testing of handheld and body-mounted wireless devices in the frequency range of 30 MHz to 6 GHz. ELI4 is fully compatible with standard and all known tissue simulating liquids.

8.4 Device Holder

<Mounting Device for Hand-Held Transmitter>

In combination with the Twin SAM V5.0/V5.0c or ELI phantoms, the Mounting Device for Hand-Held Transmitters enables rotation of the mounted transmitter device to specified spherical coordinates. At the heads, the rotation axis is at the ear opening. Transmitter devices can be easily and accurately positioned according to IEC 62209-1, IEEE 1528, FCC, or other specifications. The device holder can be locked for positioning at different phantom sections (left head, right head, flat). And upgrade kit to Mounting Device to enable easy mounting of wider devices like big smart-phones, e-books, small tablets, etc. It holds devices with width up to 140 mm.



Mounting Device for Hand-Held Transmitters



Mounting Device Adaptor for Wide-Phones

<Mounting Device for Laptops and other Body-Worn Transmitters>

The extension is lightweight and made of POM, acrylic glass and foam. It fits easily on the upper part of the mounting device in place of the phone positioned. The extension is fully compatible with the SAM Twin and ELI phantoms.



Mounting Device for Laptops

9. Measurement Procedures

The measurement procedures are as follows:

<Conducted power measurement>

- (a) For WWAN power measurement, use base station simulator to configure EUT WWAN transmission in conducted connection with RF cable, at maximum power in each supported wireless interface and frequency band.
- (b) Read the WWAN RF power level from the base station simulator.
- (c) For WLAN/BT power measurement, use engineering software to configure EUT WLAN/BT continuously transmission, at maximum RF power in each supported wireless interface and frequency band
- (d) Connect EUT RF port through RF cable to the power meter, and measure WLAN/BT output power

<SAR measurement>

- (a) Use base station simulator to configure EUT WWAN transmission in radiated connection, and engineering software to configure EUT WLAN/BT continuously transmission, at maximum RF power, in the highest power channel.
- (b) Place the EUT in the positions as Appendix D demonstrates.
- (c) Set scan area, grid size and other setting on the DASY software.
- (d) Measure SAR results for the highest power channel on each testing position.
- (e) Find out the largest SAR result on these testing positions of each band
- (f) Measure SAR results for other channels in worst SAR testing position if the reported SAR of highest power channel is larger than 0.8 W/kg

According to the test standard, the recommended procedure for assessing the peak spatial-average SAR value consists of the following steps:

- (a) Power reference measurement
- (b) Area scan
- (c) Zoom scan
- (d) Power drift measurement

9.1 Spatial Peak SAR Evaluation

The procedure for spatial peak SAR evaluation has been implemented according to the test standard. It can be conducted for 1g and 10g, as well as for user-specific masses. The DASY software includes all numerical procedures necessary to evaluate the spatial peak SAR value.

The base for the evaluation is a "cube" measurement. The measured volume must include the 1g and 10g cubes with the highest averaged SAR values. For that purpose, the center of the measured volume is aligned to the interpolated peak SAR value of a previously performed area scan.

The entire evaluation of the spatial peak values is performed within the post-processing engine (SEMCAD). The system always gives the maximum values for the 1g and 10g cubes. The algorithm to find the cube with highest averaged SAR is divided into the following stages:

- (a) Extraction of the measured data (grid and values) from the Zoom Scan
- (b) Calculation of the SAR value at every measurement point based on all stored data (A/D values and measurement parameters)
- (c) Generation of a high-resolution mesh within the measured volume
- (d) Interpolation of all measured values from the measurement grid to the high-resolution grid
- (e) Extrapolation of the entire 3-D field distribution to the phantom surface over the distance from sensor to surface
- (f) Calculation of the averaged SAR within masses of 1g and 10g

9.2 Power Reference Measurement

The Power Reference Measurement and Power Drift Measurements are for monitoring the power drift of the device under test in the batch process. The minimum distance of probe sensors to surface determines the closest measurement point to phantom surface. This distance cannot be smaller than the distance of sensor calibration points to probe tip as defined in the probe properties.

9.3 Area Scan

The area scan is used as a fast scan in two dimensions to find the area of high field values, before doing a fine measurement around the hot spot. The sophisticated interpolation routines implemented in DASY software can find the maximum found in the scanned area, within a range of the global maximum. The range (in dB0 is specified in the standards for compliance testing. For example, a 2 dB range is required in IEEE standard 1528 and IEC 62209 standards, whereby 3 dB is a requirement when compliance is assessed in accordance with the ARIB standard (Japan), if only one zoom scan follows the area scan, then only the absolute maximum will be taken as reference. For cases where multiple maximums are detected, the number of zoom scans has to be increased accordingly.

Area scan parameters extracted from FCC KDB 865664 D01v01r04 SAR measurement 100 MHz to 6 GHz.

	≤ 3 GHz	> 3 GHz
Maximum distance from closest measurement point (geometric center of probe sensors) to phantom surface	5 ± 1 mm	$\frac{1}{2} \cdot \delta \cdot \ln(2) \pm 0.5$ mm
Maximum probe angle from probe axis to phantom surface normal at the measurement location	30° ± 1°	20° ± 1°
Maximum area scan spatial resolution: Δx_{Area} , Δy_{Area}	≤ 2 GHz: ≤ 15 mm 2 – 3 GHz: ≤ 12 mm	3 – 4 GHz: ≤ 12 mm 4 – 6 GHz: ≤ 10 mm
	When the x or y dimension of the test device, in the measurement plane orientation, is smaller than the above, the measurement resolution must be ≤ the corresponding x or y dimension of the test device with at least one measurement point on the test device.	

9.4 Zoom Scan

Zoom scans are used to assess the peak spatial SAR values within a cubic averaging volume containing 1 gram and 10 gram of simulated tissue. The zoom scan measures points (refer to table below) within a cube whose base faces are centered on the maxima found in a preceding area scan job within the same procedure. When the measurement is done, the zoom scan evaluates the averaged SAR for 1 gram and 10 gram and displays these values next to the job's label.

Zoom scan parameters extracted from FCC KDB 865664 D01v01r04 SAR measurement 100 MHz to 6 GHz.

			≤ 3 GHz	> 3 GHz
Maximum zoom scan spatial resolution: $\Delta x_{Zoom}, \Delta y_{Zoom}$			≤ 2 GHz: ≤ 8 mm 2 – 3 GHz: ≤ 5 mm*	3 – 4 GHz: ≤ 5 mm* 4 – 6 GHz: ≤ 4 mm*
Maximum zoom scan spatial resolution, normal to phantom surface	uniform grid: $\Delta z_{Zoom}(n)$		≤ 5 mm	3 – 4 GHz: ≤ 4 mm 4 – 5 GHz: ≤ 3 mm 5 – 6 GHz: ≤ 2 mm
	graded grid	$\Delta z_{Zoom}(1)$: between 1 st two points closest to phantom surface	≤ 4 mm	3 – 4 GHz: ≤ 3 mm 4 – 5 GHz: ≤ 2.5 mm 5 – 6 GHz: ≤ 2 mm
		$\Delta z_{Zoom}(n>1)$: between subsequent points	$\leq 1.5 \cdot \Delta z_{Zoom}(n-1)$	
Minimum zoom scan volume	x, y, z	≥ 30 mm	3 – 4 GHz: ≥ 28 mm 4 – 5 GHz: ≥ 25 mm 5 – 6 GHz: ≥ 22 mm	
Note: δ is the penetration depth of a plane-wave at normal incidence to the tissue medium; see draft standard IEEE P1528-2011 for details. * When zoom scan is required and the <i>reported</i> SAR from the <i>area scan based 1-g SAR estimation</i> procedures of KDB 447498 is ≤ 1.4 W/kg, ≤ 8 mm, ≤ 7 mm and ≤ 5 mm zoom scan resolution may be applied, respectively, for 2 GHz to 3 GHz, 3 GHz to 4 GHz and 4 GHz to 6 GHz.				

9.5 Volume Scan Procedures

The volume scan is used to assess overlapping SAR distributions for antennas transmitting in different frequency bands. It is equivalent to an oversized zoom scan used in standalone measurements. The measurement volume will be used to enclose all the simultaneous transmitting antennas. For antennas transmitting simultaneously in different frequency bands, the volume scan is measured separately in each frequency band. In order to sum correctly to compute the 1g aggregate SAR, the EUT remain in the same test position for all measurements and all volume scan use the same spatial resolution and grid spacing. When all volume scan were completed, the software, SEMCAD postprocessor can combine and subsequently superpose these measurement data to calculating the multiband SAR.

9.6 Power Drift Monitoring

All SAR testing is under the EUT install full charged battery and transmit maximum output power. In DASYS measurement software, the power reference measurement and power drift measurement procedures are used for monitoring the power drift of EUT during SAR test. Both these procedures measure the field at a specified reference position before and after the SAR testing. The software will calculate the field difference in dB. If the power drifts more than 5%, the SAR will be retested.



10. Test Equipment List

Manufacturer	Name of Equipment	Type/Model	Serial Number	Calibration	
				Last Cal.	Due Date
SPEAG	5000MHz System Validation Kit	D5GHzV2	1167	2017/7/26	2018/7/25
SPEAG	Data Acquisition Electronics	DAE4	1338	2017/12/4	2018/12/3
SPEAG	Dosimetric E-Field Probe	EX3DV4	3898	2017/6/27	2018/6/26
SPEAG	SAM Twin Phantom	QD 000 P40 CB	TP-1488	NCR	NCR
SPEAG	SAM Twin Phantom	QD 000 P40 CB	TP-1489	NCR	NCR
SPEAG	Phone Positioner	N/A	N/A	NCR	NCR
Anritsu	Radio communication analyzer	MT8820C	6201300654	2017/8/7	2018/8/6
Anritsu	Radio communication analyzer	MT8821C	6201692204	2017/3/29	2018/3/28
Agilent	Wireless Communication Test Set	E5515C	MY52102706	2017/4/18	2018/4/17
Agilent	ENA Series Network Analyzer	E5071C	MY46111157	2017/4/18	2018/4/17
SPEAG	DAK Kit	DAK3.5	1146	2017/7/18	2018/7/17
R&S	Signal Generator	SMR20	102049	2017/8/17	2018/8/16
Anritsu	Power Meter	ML2495A	1419002	2017/5/15	2018/5/14
Anritsu	Power Sensor	MA2411B	1339124	2017/5/15	2018/5/14
Anritsu	Power Meter	ML2495A	1218006	2017/10/6	2018/10/5
Anritsu	Power Sensor	MA2411B	1207363	2017/10/6	2018/10/5
R&S	CBT BLUETOOTH TESTER	CBT	100783	2017/8/8	2018/8/7
EXA	Spectrum Analyzer	N9010A	MY55150244	2017/4/18	2018/4/17
WISEWIND	Hygrometer	WISEWIND 0905	0905	2017/4/20	2018/4/19
JM	DIGITAC THERMOMETER	JM222	AA1207166	2017/4/19	2018/4/18
ARRA	Power Divider	A3200-2	N/A	Note	
Agilent	Dual Directional Coupler	778D	50422	Note	
PASTERNAK	Dual Directional Coupler	PE2214-10	N/A	Note	
MCL	Attenuation1	BW-S10W5+	N/A	Note	
MCL	Attenuation2	BW-S10W5+	N/A	Note	
MCL	Attenuation3	BW-S10W5+	N/A	Note	
AR	Amplifier	5S1G4	333096	Note	
mini-circuits	Amplifier	ZVE-3W-83+	162601250	Note	

Note:

Prior to system verification and validation, the path loss from the signal generator to the system check source and the power meter, which includes the amplifier, cable, attenuator and directional coupler, was measured by the network analyzer. The reading of the power meter was offset by the path loss difference between the path to the power meter and the path to the system check source to monitor the actual power level fed to the system check

11. System Verification

11.1 Tissue Simulating Liquids

For the measurement of the field distribution inside the SAM phantom with DASY, the phantom must be filled with around 25 liters of homogeneous body tissue simulating liquid. For head SAR testing, the liquid height from the ear reference point (ERP) of the phantom to the liquid top surface is larger than 15 cm, which is shown in Fig. 10.1. For body SAR testing, the liquid height from the center of the flat phantom to the liquid top surface is larger than 15 cm, which is shown in Fig. 10.2.

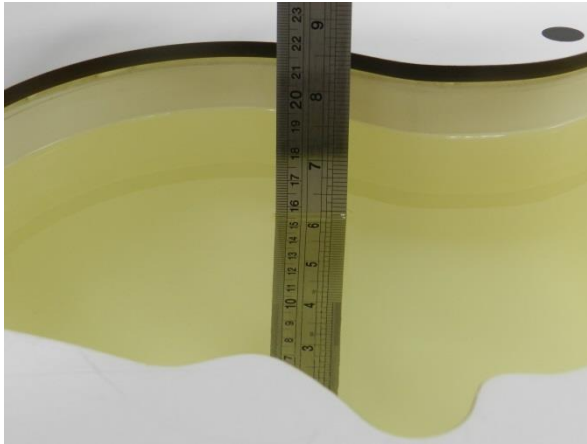

Fig 10.1 Photo of Liquid Height for Head SAR

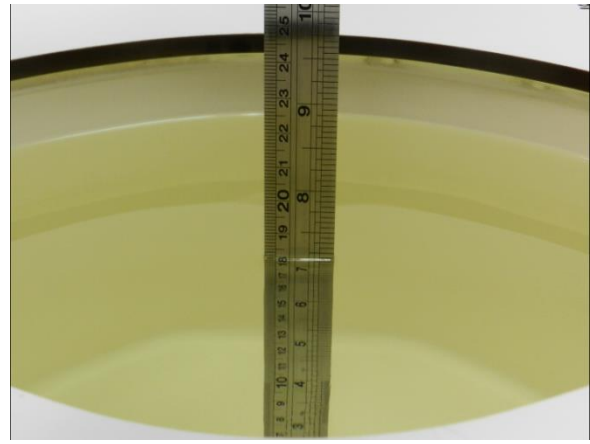

Fig 10.2 Photo of Liquid Height for Body SAR

11.2 Tissue Verification

The following tissue formulations are provided for reference only as some of the parameters have not been thoroughly verified. The composition of ingredients may be modified accordingly to achieve the desired target tissue parameters required for routine SAR evaluation.

Simulating Liquid for 5GHz, Manufactured by SPEAG

Ingredients	(% by weight)
Water	64~78%
Mineral oil	11~18%
Emulsifiers	9~15%
Additives and Salt	2~3%

<Tissue Dielectric Parameter Check Results>

Frequency (MHz)	Tissue Type	Liquid Temp. (°C)	Conductivity (σ)	Permittivity (ε _r)	Conductivity Target (σ)	Permittivity Target (ε _r)	Delta (σ) (%)	Delta (ε _r) (%)	Limit (%)	Date
5250	Head	22.6	4.864	37.111	4.71	35.90	3.27	3.37	±5	2018/1/18
5600	Head	22.6	5.206	36.588	5.07	35.50	2.68	3.06	±5	2018/1/18
5750	Head	22.6	5.361	36.370	5.22	35.40	2.70	2.74	±5	2018/1/18
5250	Body	22.7	5.506	47.953	5.36	48.90	2.72	-1.94	±5	2018/1/19
5600	Body	22.7	5.953	47.365	5.77	48.50	3.17	-2.34	±5	2018/1/19
5750	Body	22.8	6.154	47.115	5.94	48.30	3.60	-2.45	±5	2018/1/20

11.3 System Performance Check Results

Comparing to the original SAR value provided by SPEAG, the verification data should be within its specification of 10 %. Below table shows the target SAR and measured SAR after normalized to 1W input power. The table below indicates the system performance check can meet the variation criterion and the plots can be referred to Appendix A of this report.

<1g SAR>

Date	Frequency (MHz)	Tissue Type	Input Power (mW)	Dipole S/N	Probe S/N	DAE S/N	Measured 1g SAR (W/kg)	Targeted 1g SAR (W/kg)	Normalized 1g SAR (W/kg)	Deviation (%)
2018/1/18	5250	Head	100	1167	3898	1338	8.31	79.90	83.10	4.01
2018/1/18	5600	Head	100	1167	3898	1338	8.50	83.80	85.00	1.43
2018/1/18	5750	Head	100	1167	3898	1338	8.20	80.60	82.00	1.74
2018/1/19	5250	Body	100	1167	3898	1338	7.38	76.90	73.80	-4.03
2018/1/19	5600	Body	100	1167	3898	1338	7.42	80.00	74.20	-7.25
2018/1/20	5750	Body	100	1167	3898	1338	7.64	77.50	76.40	-1.42

<10g SAR>

Date	Frequency (MHz)	Tissue Type	Input Power (mW)	Dipole S/N	Probe S/N	DAE S/N	Measured 10g SAR (W/kg)	Targeted 10g SAR (W/kg)	Normalized 10g SAR (W/kg)	Deviation (%)
2018/1/19	5250	Body	100	1167	3898	1338	2.03	21.50	20.30	-5.58
2018/1/19	5600	Body	100	1167	3898	1338	2.21	22.40	22.10	-1.34

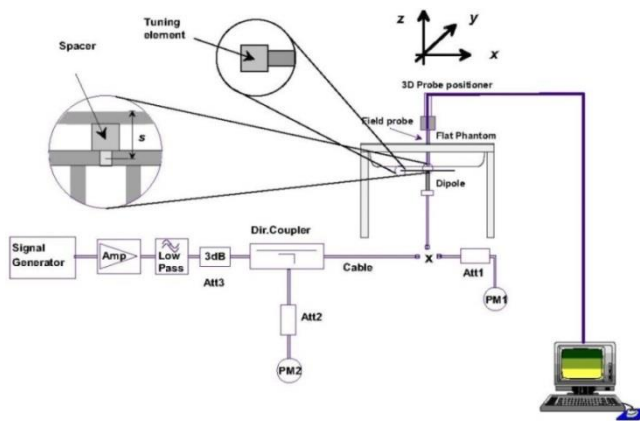

Fig 8.3.1 System Performance Check Setup

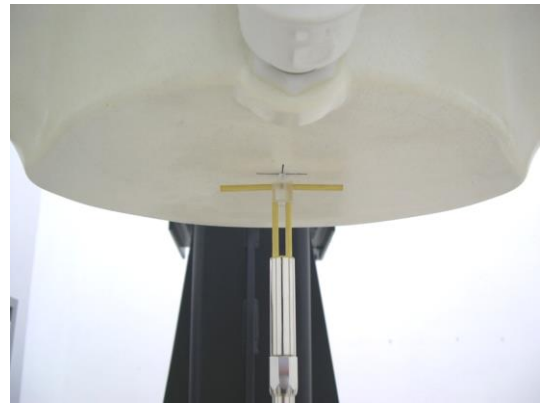

Fig 8.3.2 Setup Photo

12. RF Exposure Positions

12.1 Ear and handset reference point

Figure 9.1.1 shows the front, back, and side views of the SAM phantom. The center-of-mouth reference point is labeled “M,” the left ear reference point (ERP) is marked “LE,” and the right ERP is marked “RE.” Each ERP is 15 mm along the B-M (back-mouth) line behind the entrance-to-ear-canal (EEC) point, as shown in Figure 9.1.2 The Reference Plane is defined as passing through the two ear reference points and point M. The line N-F (neck-front), also called the reference pivoting line, is normal to the Reference Plane and perpendicular to both a line passing through RE and LE and the B-M line (see Figure 9.1.3). Both N-F and B-M lines should be marked on the exterior of the phantom shell to facilitate handset positioning. Posterior to the N-F line the ear shape is a flat surface with 6 mm thickness at each ERP, and forward of the N-F line the ear is truncated, as illustrated in Figure 9.1.2. The ear truncation is introduced to preclude the ear lobe from interfering with handset tilt, which could lead to unstable positioning at the cheek.

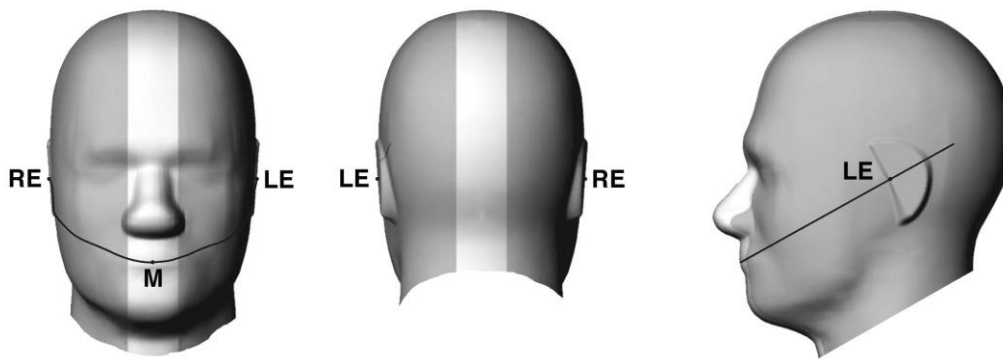

Fig 9.1.1 Front, back, and side views of SAM twin phantom

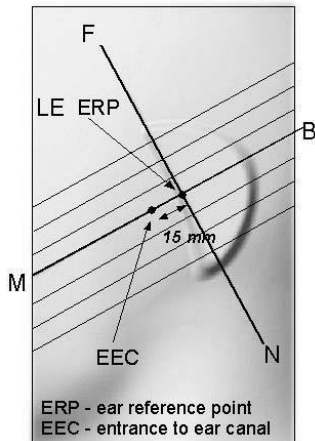

Fig 9.1.2 Close-up side view of phantom showing the ear region.

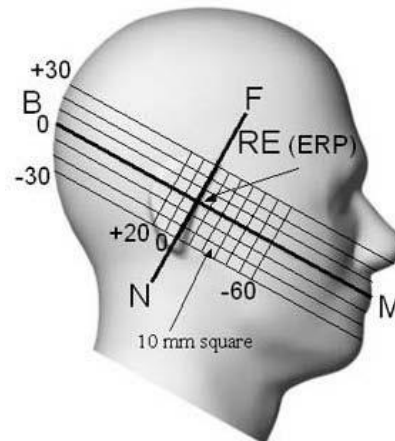

Fig 9.1.3 Side view of the phantom showing relevant markings and seven cross-sectional plane locations

12.2 Definition of the cheek position

1. Ready the handset for talk operation, if necessary. For example, for handsets with a cover piece (flip cover), open the cover. If the handset can transmit with the cover closed, both configurations must be tested.
2. Define two imaginary lines on the handset—the vertical centerline and the horizontal line. The vertical centerline passes through two points on the front side of the handset—the midpoint of the width w_t of the handset at the level of the acoustic output (point A in Figure 9.2.1 and Figure 9.2.2), and the midpoint of the width w_b of the bottom of the handset (point B). The horizontal line is perpendicular to the vertical centerline and passes through the center of the acoustic output (see Figure 9.2.1). The two lines intersect at point A. Note that for many handsets, point A coincides with the center of the acoustic output; however, the acoustic output may be located elsewhere on the horizontal line. Also note that the vertical centerline is not necessarily parallel to the front face of the handset (see Figure 9.2.2), especially for clamshell handsets, handsets with flip covers, and other irregularly-shaped handsets.
3. Position the handset close to the surface of the phantom such that point A is on the (virtual) extension of the line passing through points RE and LE on the phantom (see Figure 9.2.3), such that the plane defined by the vertical centerline and the horizontal line of the handset is approximately parallel to the sagittal plane of the phantom.
4. Translate the handset towards the phantom along the line passing through RE and LE until handset point A touches the pinna at the ERP.
5. While maintaining the handset in this plane, rotate it around the LE-RE line until the vertical centerline is in the plane normal to the plane containing B-M and N-F lines, i.e., the Reference Plane.
6. Rotate the handset around the vertical centerline until the handset (horizontal line) is parallel to the N-F line.
7. While maintaining the vertical centerline in the Reference Plane, keeping point A on the line passing through RE and LE, and maintaining the handset contact with the pinna, rotate the handset about the N-F line until any point on the handset is in contact with a phantom point below the pinna on the cheek. See Figure 9.2.3. The actual rotation angles should be documented in the test report.

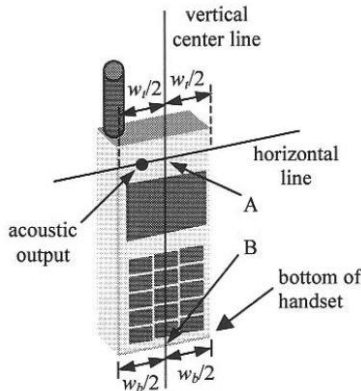

Fig 9.2.1 Handset vertical and horizontal reference lines—"fixed case"

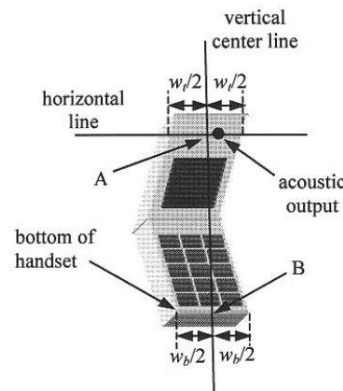

Fig 9.2.2 Handset vertical and horizontal reference lines—"clam-shell case"

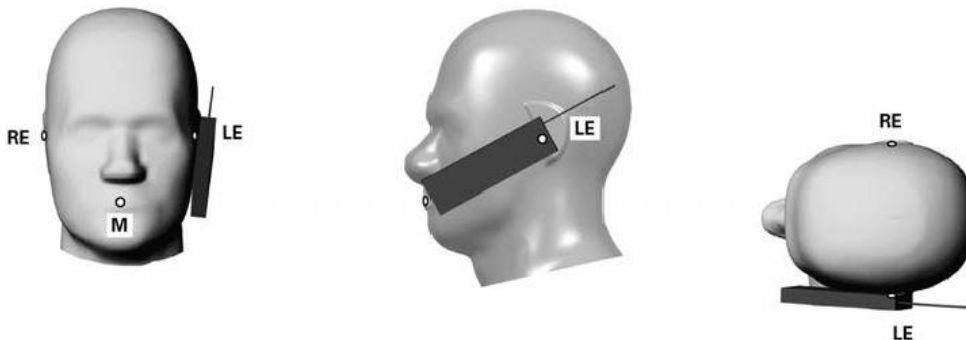

Fig 9.2.3 cheek or touch position. The reference points for the right ear (RE), left ear (LE), and mouth (M), which establish the Reference Plane for handset positioning, are indicated.

12.3 Definition of the tilt position

1. Ready the handset for talk operation, if necessary. For example, for handsets with a cover piece (flip cover), open the cover. If the handset can transmit with the cover closed, both configurations must be tested.
2. While maintaining the orientation of the handset, move the handset away from the pinna along the line passing through RE and LE far enough to allow a rotation of the handset away from the cheek by 15°.
3. Rotate the handset around the horizontal line by 15°.
4. While maintaining the orientation of the handset, move the handset towards the phantom on the line passing through RE and LE until any part of the handset touches the ear. The tilt position is obtained when the contact point is on the pinna. See Figure 9.3.1. If contact occurs at any location other than the pinna, e.g., the antenna at the back of the phantom head, the angle of the handset should be reduced. In this case, the tilt position is obtained if any point on the handset is in contact with the pinna and a second point

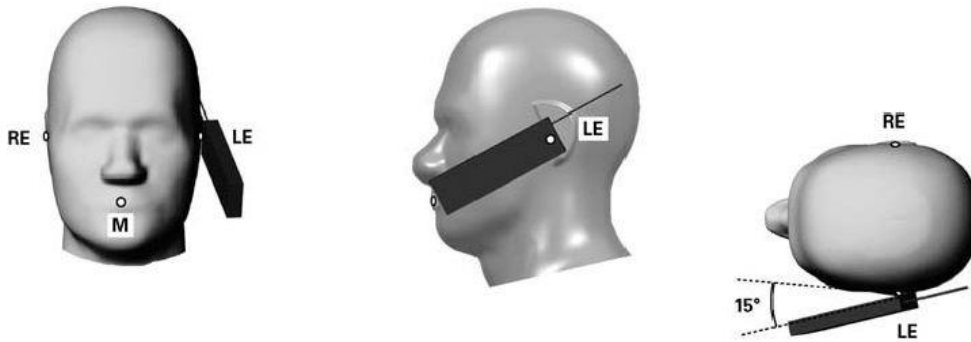

Fig 9.3.1 Tilt position. The reference points for the right ear (RE), left ear (LE), and mouth (M), which define the Reference Plane for handset positioning, are indicated.

12.4 Body Worn Accessory

Body-worn operating configurations are tested with the belt-clips and holsters attached to the device and positioned against a flat phantom in a normal use configuration (see Figure 9.4). Per KDB648474 D04v01r03, body-worn accessory exposure is typically related to voice mode operations when handsets are carried in body-worn accessories. The body-worn accessory procedures in FCC KDB 447498 D01v06 should be used to test for body-worn accessory SAR compliance, without a headset connected to it. This enables the test results for such configuration to be compatible with that required for hotspot mode when the body-worn accessory test separation distance is greater than or equal to that required for hotspot mode, when applicable. When the reported SAR for body-worn accessory, measured without a headset connected to the handset is > 1.2 W/kg, the highest reported SAR configuration for that wireless mode and frequency band should be repeated for that body-worn accessory with a headset attached to the handset.

Accessories for body-worn operation configurations are divided into two categories: those that do not contain metallic components and those that do contain metallic components. When multiple accessories that do not contain metallic components are supplied with the device, the device is tested with only the accessory that dictates the closest spacing to the body. Then multiple accessories that contain metallic components are tested with the device with each accessory. If multiple accessories share an identical metallic component (i.e. the same metallic belt-chip used with different holsters with no other metallic components) only the accessory that dictates the closest spacing to the body is tested.

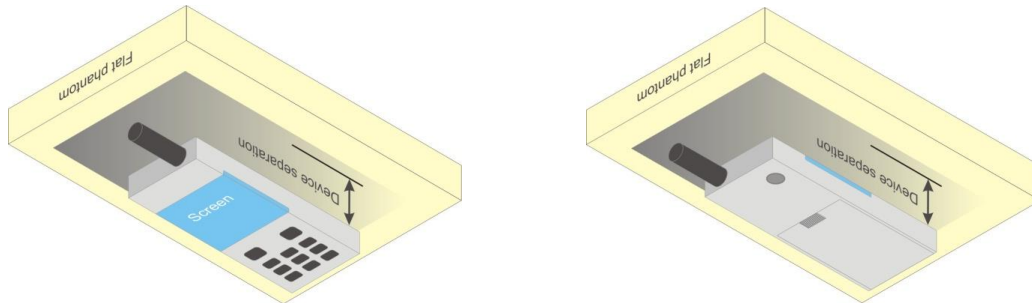

Fig 9.4 Body Worn Position



12.5 Product Specific 10g SAR Exposure

For smart phones with a display diagonal dimension > 15.0 cm or an overall diagonal dimension > 16.0 cm that provide similar mobile web access and multimedia support found in mini-tablets or UMPC mini-tablets that support voice calls next to the ear, According to KDB648474 D04v01r03, the following phablet procedures should be applied to evaluate SAR compliance for each applicable wireless modes and frequency band. Devices marketed as phablets, regardless of form factors and operating characteristics must be tested as a phablet to determine SAR compliance

1. The normally required head and body-worn accessory SAR test procedures for handsets, including hotspot mode, must be applied.
2. The UMPC mini-tablet procedures must also be applied to test the SAR of all surfaces and edges with an antenna located at ≤ 25 mm from that surface or edge, in direct contact with a flat phantom, for 10-g extremity SAR according to the body-equivalent tissue dielectric parameters in KDB 865664 to address interactive hand use exposure conditions.6 The UMPC mini-tablet 1-g SAR at 5 mm is not required. When hotspot mode applies, 10-g extremity SAR is required only for the surfaces and edges with hotspot mode 1-g reported SAR > 1.2 W/kg.

12.6 Wireless Router

Some battery-operated handsets have the capability to transmit and receive user through simultaneous transmission of WIFI simultaneously with a separate licensed transmitter. The FCC has provided guidance in FCC KDB Publication 941225 D06 v02r01 where SAR test considerations for handsets ($L \times W \geq 9$ cm x 5 cm) are based on a composite test separation distance of 10mm from the front, back and edges of the device containing transmitting antennas within 2.5cm of their edges, determined from general mixed use conditions for this type of devices. Since the hotspot SAR results may overlap with the body-worn accessory SAR requirements, the more conservative configurations can be considered, thus excluding some body-worn accessory SAR tests.

When the user enables the personal wireless router functions for the handset, actual operations include simultaneous transmission of both the WIFI transmitter and another licensed transmitter. Both transmitters often do not transmit at the same transmitting frequency and thus cannot be evaluated for SAR under actual use conditions due to the limitations of the SAR assessment probes. Therefore, SAR must be evaluated for each frequency transmission and mode separately and spatially summed with the WIFI transmitter according to FCC KDB Publication 447498 D01v06 publication procedures. The "Portable Hotspot" feature on the handset was NOT activated during SAR assessments, to ensure the SAR measurements were evaluated for a single transmission frequency RF signal at a time.

13. Conducted RF Output Power (Unit: dBm)

<WLAN Conducted Power>

General Note:

1. Per KDB 248227 D01v02r02, SAR test reduction is determined according to 802.11 transmission mode configurations and certain exposure conditions with multiple test positions. In the 2.4 GHz band, separate SAR procedures are applied to DSSS and OFDM configurations to simplify DSSS test requirements. For OFDM, in both 2.4 and 5 GHz bands, an initial test configuration must be determined for each standalone and aggregated frequency band, according to the transmission mode configuration with the highest maximum output power specified for production units to perform SAR measurements. If the same highest maximum output power applies to different combinations of channel bandwidths, modulations and data rates, additional procedures are applied to determine which test configurations require SAR measurement. When applicable, an initial test position may be applied to reduce the number of SAR measurements required for next to the ear, UMPC mini-tablet or hotspot mode configurations with multiple test positions.
2. For 2.4 GHz 802.11b DSSS, either the initial test position procedure for multiple exposure test positions or the DSSS procedure for fixed exposure position is applied; these are mutually exclusive. For 2.4 GHz and 5 GHz OFDM configurations, the initial test configuration is applied to measure SAR using either the initial test position procedure for multiple exposure test position configurations or the initial test configuration procedures for fixed exposure test conditions. Based on the reported SAR of the measured configurations and maximum output power of the transmission mode configurations that are not included in the initial test configuration, the subsequent test configuration and initial test position procedures are applied to determine if SAR measurements are required for the remaining OFDM transmission configurations. In general, the number of test channels that require SAR measurement is minimized based on maximum output power measured for the test sample(s).
3. For OFDM transmission configurations in the 2.4 GHz and 5 GHz bands, When the same maximum power is specified for multiple transmission modes in a frequency band, the largest channel bandwidth, lowest order modulation, lowest data rate and lowest order 802.11a/g/n/ac mode is used for SAR measurement, on the highest measured output power channel for each frequency band.
4. DSSS and OFDM configurations are considered separately according to the required SAR procedures. SAR is measured in the initial test position using the 802.11 transmission mode configuration required by the DSSS procedure or initial test configuration and subsequent test configuration(s) according to the OFDM procedures.18 The initial test position procedure is described in the following:
 - a. When the reported SAR of the initial test position is ≤ 0.4 W/kg, further SAR measurement is not required for the other test positions in that exposure configuration and 802.11 transmission mode combinations within the frequency band or aggregated band.
 - b. When the reported SAR of the test position is > 0.4 W/kg, SAR is repeated for the 802.11 transmission mode configuration tested in the initial test position to measure the subsequent next closet/smallest test separation distance and maximum coupling test position on the highest maximum output power channel, until the report SAR is ≤ 0.8 W/kg or all required test position are tested.
 - c. For all positions/configurations, when the reported SAR is > 0.8 W/kg, SAR is measured for these test positions/configurations on the subsequent next highest measured output power channel(s) until the reported SAR is ≤ 1.2 W/kg or all required channels are tested.



<Full Power Mode>

<5GHz WLAN>

	Mode	Channel	Frequency (MHz)	Average power (dBm)	Tune-Up Limit	Duty Cycle %
5.2GHz WLAN	802.11a 6Mbps	36	5180	12.94	14.50	87.43
		40	5200	14.97	15.50	
		44	5220	15.04	15.50	
		48	5240	14.77	15.50	
	802.11n-HT20 MCS0	36	5180	11.92	13.50	86.42
		40	5200	15.07	15.50	
		44	5220	15.05	15.50	
		48	5240	14.94	15.50	
	802.11n-HT40 MCS0	38	5190	10.86	12.50	86.05
		46	5230	14.07	15.00	

	Mode	Channel	Frequency (MHz)	Average power (dBm)	Tune-Up Limit	Duty Cycle %
5.3GHz WLAN	802.11a 6Mbps	52	5260	14.97	15.50	87.43
		56	5280	14.73	15.50	
		60	5300	14.46	15.50	
		64	5320	13.96	15.50	
	802.11n-HT20 MCS0	52	5260	14.92	15.50	86.42
		56	5280	14.82	15.50	
		60	5300	14.52	15.50	
		64	5320	14.45	15.50	
	802.11n-HT40 MCS0	54	5270	13.96	15.00	86.05
		62	5310	9.71	11.50	

5.5GHz WLAN	Mode	Channel	Frequency (MHz)	Average power (dBm)	Tune-Up Limit	Duty Cycle %
	802.11a 6Mbps	100	5500	14.77	15.50	87.43
		116	5580	14.86	15.50	
		124	5620	14.94	15.50	
		132	5660	14.79	15.50	
		140	5700	12.13	14.00	
	802.11n-HT20 MCS0	100	5500	14.86	15.50	86.42
		116	5580	14.92	15.50	
		124	5620	15.05	15.50	
		132	5660	14.88	15.50	
		140	5700	11.78	13.50	
	802.11n-HT40 MCS0	102	5510	11.63	13.50	86.05
		110	5550	13.87	14.50	
		126	5630	14.26	14.50	
		134	5670	13.57	14.50	

5.8GHz WLAN	Mode	Channel	Frequency (MHz)	Average power (dBm)	Tune-Up Limit	Duty Cycle %
	802.11a 6Mbps	149	5745	14.54	15.50	87.43
		157	5785	15.31	15.50	
		165	5825	14.82	15.50	
	802.11n-HT20 MCS0	149	5745	14.52	15.50	86.42
		157	5785	15.28	15.50	
		165	5825	14.78	15.50	
	802.11n-HT40 MCS0	151	5755	13.43	15.00	86.05
		159	5795	13.94	15.00	

<Reduced Power Mode for Receiver On>

<5GHz WLAN>

	Mode	Channel	Frequency (MHz)	Average power (dBm)	Tune-Up Limit	Duty Cycle %
5.2GHz WLAN	802.11a 6Mbps	36	5180	12.94	13.00	87.43
		40	5200	12.93	13.00	
		44	5220	12.65	13.00	
		48	5240	12.31	13.00	
	802.11n-HT20 MCS0	36	5180	11.44	13.00	86.42
		40	5200	12.10	13.00	
		44	5220	11.84	13.00	
		48	5240	11.52	13.00	
	802.11n-HT40 MCS0	38	5190	12.47	12.50	86.05
		46	5230	12.12	12.50	

	Mode	Channel	Frequency (MHz)	Average power (dBm)	Tune-Up Limit	Duty Cycle %
5.3GHz WLAN	802.11a 6Mbps	52	5260	12.54	13.00	87.43
		56	5280	12.47	13.00	
		60	5300	12.29	13.00	
		64	5320	11.69	13.00	
	802.11n-HT20 MCS0	52	5260	11.69	13.00	86.42
		56	5280	11.79	13.00	
		60	5300	11.50	13.00	
		64	5320	11.08	13.00	
	802.11n-HT40 MCS0	54	5270	12.03	12.50	86.05
		62	5310	9.71	11.50	

14. Antenna Location

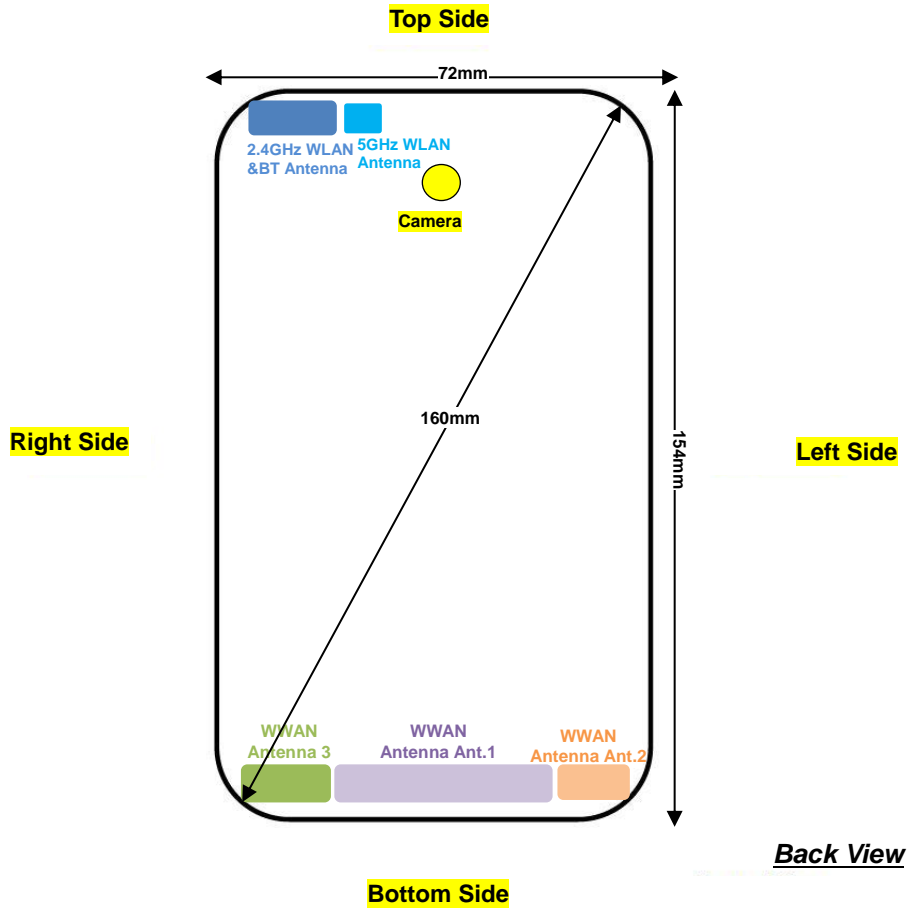

Distance of the Antenna to the EUT surface/edge						
Antennas	Back	Front	Top Side	Bottom Side	Right Side	Left Side
WWAN Antenna 1	≤ 25mm	≤ 25mm	>25mm	≤ 25mm	≤ 25mm	≤ 25mm
WWAN Antenna 2	≤ 25mm	≤ 25mm	>25mm	≤ 25mm	>25mm	≤ 25mm
WWAN Antenna 3	≤ 25mm	≤ 25mm	>25mm	≤ 25mm	≤ 25mm	>25mm
2.4GHz WLAN & BT	≤ 25mm	≤ 25mm	≤ 25mm	>25mm	≤ 25mm	>25mm
5GHz WLAN	≤ 25mm	≤ 25mm	≤ 25mm	>25mm	≤ 25mm	>25mm

Positions for SAR tests; Hotspot mode						
Antennas	Back	Front	Top Side	Bottom Side	Right Side	Left Side
WWAN Antenna 1	Yes	Yes	No	Yes	Yes	Yes
WWAN Antenna 2	Yes	Yes	No	Yes	No	Yes
WWAN Antenna 3	Yes	Yes	No	Yes	Yes	No
2.4GHz WLAN & BT	Yes	Yes	Yes	No	Yes	No
5GHz WLAN	Yes	Yes	Yes	No	Yes	No

General Note:

1. This device has three WWAN transmitter antennas. WWAN antenna 1 is located at the middle of bottom edge of the device, WWAN antenna 2 is located at the right side of bottom edge of the device, and WWAN antenna 3 is located at the left side of bottom edge of the device which can refer to antenna location chapter. WWAN antenna 1 frequency bands include GSM850/1900, WCDMA Band II/IV/V, LTE band 2/4/5/12/17, WWAN antenna 2 frequency band only includes LTE band 7 and WWAN antenna 3 frequency band also only includes LTE band 7.
2. The device is capable of switching between the WWAN antenna 2 and WWAN antenna 3 based on signal strength. When WWAN antenna 2 acted as a transmitter, then WWAN antenna 3 acted as a receiver. The same as the reversed.
3. Referring to KDB 941225 D06 v02r01, when the overall device length and width are ≥ 9cm*5cm, the test distance is 10 mm. SAR must be measured for all sides and surfaces with a transmitting antenna located within 25mm from that surface or edge.

15. SAR Test Results

General Note:

1. Per KDB 447498 D01v06, the reported SAR is the measured SAR value adjusted for maximum tune-up tolerance.
 - a. Tune-up scaling Factor = tune-up limit power (mW) / EUT RF power (mW), where tune-up limit is the maximum rated power among all production units.
 - b. For SAR testing of WLAN signal with non-100% duty cycle, the measured SAR is scaled-up by the duty cycle scaling factor which is equal to "1/(duty cycle)"
 - c. For WLAN: Reported SAR(W/kg)= Measured SAR(W/kg)* Duty Cycle scaling factor * Tune-up scaling factor
2. Per KDB 447498 D01v06, for each exposure position, testing of other required channels within the operating mode of a frequency band is not required when the *reported* 1-g or 10-g SAR for the mid-band or highest output power channel is:
 - ≤ 0.8 W/kg or 2.0 W/kg, for 1-g or 10-g respectively, when the transmission band is ≤ 100 MHz
 - ≤ 0.6 W/kg or 1.5 W/kg, for 1-g or 10-g respectively, when the transmission band is between 100 MHz and 200 MHz
 - ≤ 0.4 W/kg or 1.0 W/kg, for 1-g or 10-g respectively, when the transmission band is ≥ 200 MHz
3. Per KDB 865664 D01v01r04, for each frequency band, repeated SAR measurement is not required when the measured SAR is < 0.8 W/kg.
4. Per KDB 648474 D04v01r03, when the reported SAR for a body-worn accessory measured without a headset connected to the handset is ≤ 1.2 W/kg, SAR testing with a headset connected to the handset is not required.
5. The device employs proximity sensors that detect the presence of the user's body at the front or back faces of the device. When front or back body worn condition is detected, GSM1900, WCDMA band II/IV and LTE band 2/4/7 reduced power will be active. (P-sensor can't work at detecting presence of the user's body at the four edges of the device.)
6. When hotspot mode is enabled, power reduction will be activated to limit the maximum power of GSM1900, WCDMA band II/IV and LTE band 2/4/7.
7. P-sensor can detect handheld state, for product specific 10g SAR condition, GSM1900, WCDMA band II/IV, LTE band 2/4 reduced powers will be active. For LTE band 7, the power level is the same as the full power.
8. This device hotspot reduced power and P-sensor reduced power level are the same. So only show one reduced power level for hotspot reduced power and P-sensor reduced power for this application.
9. This device has three WWAN transmitter antennas. WWAN antenna 1 is located at the middle of bottom edge of the device, WWAN antenna 2 is located at the right side of bottom edge of the device, and WWAN antenna 3 is located at the left side of bottom edge of the device which can refer to antenna location chapter. WWAN antenna 1 frequency bands include GSM850/1900, WCDMA Band II/IV/V, LTE band 2/4/5/12/17, WWAN antenna 2 frequency band only includes LTE band 7 and WWAN antenna 3 frequency band also only includes LTE band 7.
10. The device is capable of switching between the WWAN antenna 2 and WWAN antenna 3 based on signal strength. When WWAN antenna 2 acted as a transmitter, then WWAN antenna 3 acted as a receiver. The same as the reversed.
11. Per KDB648474 D04v01r03, for smart phones with a display diagonal dimension > 15.0 cm or an overall diagonal dimension > 16.0 cm, when hotspot mode applies, 10-g extremity SAR is required only for the surfaces and edges with hotspot mode 1-g reported SAR > 1.2 W/kg, however, when power reduction applies to hotspot mode the measured SAR must be scaled to the maximum output power, including tolerance, allowed for phablet modes to compare with the 1.2 W/kg SAR test reduction threshold.
 - a. For this device for WWAN transmitter scaled to reduced power mode for product specific 10g SAR is higher than 1.2W/kg of GSM1900, WCDMA band II/IV, LTE band 2/4/7, therefore product specific SAR is necessary.
 - b. WLAN 5.3/5.5GHz tested the product specific 10g SAR since it has no hotspot mode. P-sensor can detect handheld state, for front and back of product specific 10g SAR condition, WLAN 5.3GHz reduced powers will be active.
 - c. When 10-g product specific 10g SAR is considered, SAR thresholds is specified in the procedures for SAR test reduction and exclusion should be multiplied by 2.5.



WLAN Note:

1. Per KDB 248227 D01v02r02, for 2.4GHz 802.11g/n SAR testing is not required when the highest reported SAR for DSSS is adjusted by the ratio of OFDM to DSSS specified maximum output power and the adjusted SAR is ≤ 1.2 W/kg.
2. Per KDB 248227 D01v02r02, U-NII-1 SAR testing is not required when the U-NII-2A band highest reported SAR for a test configuration is ≤ 1.2 W/kg, SAR is not required for U-NII-1 band.
3. When the reported SAR of the test position is > 0.4 W/kg, SAR is repeated for the 802.11 transmission mode configuration tested in the initial test position to measure the subsequent next closet/smallest test separation distance and maximum coupling test position on the highest maximum output power channel, until the report SAR is ≤ 0.8 W/kg or all required test position are tested.
4. For all positions / configurations, when the reported SAR is > 0.8 W/kg, SAR is measured for these test positions / configurations on the subsequent next highest measured output power channel(s) until the reported SAR is ≤ 1.2 W/kg or all required channels are tested.
5. During SAR testing the WLAN transmission was verified using a spectrum analyzer.
6. Additional BT/WLAN SAR test with headset was for conservative simultaneous transmission analysis.

15.1 Head SAR

<WLAN 5GHz SAR>

Plot No.	Band	Mode	Test Position	Power Mode	Ch.	Freq. (MHz)	Average Power (dBm)	Tune-Up Limit (dBm)	Tune-up Scaling Factor	Duty Cycle %	Duty Cycle Scaling Factor	Power Drift (dB)	Measured 1g SAR (W/kg)	Reported 1g SAR (W/kg)
	WLAN5.3GHz	802.11a 6Mbps	Right Cheek	Receiver On	52	5260	12.54	13.00	1.112	87.43	1.144	0.05	0.567	0.721
	WLAN5.3GHz	802.11a 6Mbps	Right Tilted	Receiver On	52	5260	12.54	13.00	1.112	87.43	1.144	0.03	0.596	0.758
01	WLAN5.3GHz	802.11a 6Mbps	Left Cheek	Receiver On	52	5260	12.54	13.00	1.112	87.43	1.144	0.01	0.781	0.993
	WLAN5.3GHz	802.11a 6Mbps	Left Tilted	Receiver On	52	5260	12.54	13.00	1.112	87.43	1.144	0.05	0.653	0.830
	WLAN5.3GHz	802.11a 6Mbps	Left Cheek	Receiver On	56	5280	12.47	13.00	1.130	87.43	1.144	0.04	0.684	0.884
	WLAN5.3GHz	802.11a 6Mbps	Left Tilted	Receiver On	56	5280	12.47	13.00	1.130	87.43	1.144	0.08	0.513	0.663
	WLAN5.5GHz	802.11a 6Mbps	Right Cheek	Full	124	5620	14.94	15.50	1.138	87.43	1.144	0.03	0.449	0.584
	WLAN5.5GHz	802.11a 6Mbps	Right Tilted	Full	124	5620	14.94	15.50	1.138	87.43	1.144	0.01	0.347	0.452
02	WLAN5.5GHz	802.11a 6Mbps	Left Cheek	Full	124	5620	14.94	15.50	1.138	87.43	1.144	0.03	0.686	0.893
	WLAN5.5GHz	802.11a 6Mbps	Left Tilted	Full	124	5620	14.94	15.50	1.138	87.43	1.144	0.05	0.608	0.791
	WLAN5.5GHz	802.11a 6Mbps	Left Cheek	Full	116	5580	14.86	15.50	1.159	87.43	1.144	0.03	0.613	0.813
	WLAN 5.8GHz	802.11a 6Mbps	Right Cheek	Full	157	5785	15.31	15.50	1.045	87.43	1.144	0.08	0.285	0.341
	WLAN 5.8GHz	802.11a 6Mbps	Right Tilted	Full	157	5785	15.31	15.50	1.045	87.43	1.144	-0.03	0.239	0.286
03	WLAN 5.8GHz	802.11a 6Mbps	Left Cheek	Full	157	5785	15.31	15.50	1.045	87.43	1.144	0.12	0.459	0.549
	WLAN 5.8GHz	802.11a 6Mbps	Left Tilted	Full	157	5785	15.31	15.50	1.045	87.43	1.144	-0.02	0.365	0.436



15.2 Hotspot SAR

<WLAN 5GHz SAR>

Plot No.	Band	Mode	Test Position	Gap (mm)	Power Mode	Ch.	Freq. (MHz)	Average Power (dBm)	Tune-Up Limit (dBm)	Tune-up Scaling Factor	Duty Cycle %	Duty Cycle Scaling Factor	Power Drift (dB)	Measured 1g SAR (W/kg)	Reported 1g SAR (W/kg)
	WLAN5.2GHz	802.11a 6Mbps	Front	5	Full	44	5220	15.04	15.50	1.112	87.43	1.144	0.03	0.388	0.493
04	WLAN5.2GHz	802.11a 6Mbps	Back	5	Full	44	5220	15.04	15.50	1.112	87.43	1.144	-0.07	0.642	0.817
	WLAN5.2GHz	802.11a 6Mbps	Right Side	5	Full	44	5220	15.04	15.50	1.112	87.43	1.144	0.01	0.076	0.097
	WLAN5.2GHz	802.11a 6Mbps	Top Side	5	Full	44	5220	15.04	15.50	1.112	87.43	1.144	0.05	0.239	0.304
	WLAN5.2GHz	802.11a 6Mbps	Back	5	Full	40	5200	14.97	15.50	1.130	87.43	1.144	0.01	0.561	0.725
	WLAN 5.8GHz	802.11a 6Mbps	Front	5	Full	157	5785	15.31	15.50	1.045	87.43	1.144	0.05	0.182	0.218
05	WLAN 5.8GHz	802.11a 6Mbps	Back	5	Full	157	5785	15.31	15.50	1.045	87.43	1.144	-0.09	0.517	0.618
	WLAN 5.8GHz	802.11a 6Mbps	Right Side	5	Full	157	5785	15.31	15.50	1.045	87.43	1.144	0.01	0.135	0.161
	WLAN 5.8GHz	802.11a 6Mbps	Top Side	5	Full	157	5785	15.31	15.50	1.045	87.43	1.144	0.03	0.229	0.274



15.3 Body Worn Accessory SAR

<WLAN 5GHz SAR>

Plot No.	Band	Mode	Test Position	Gap (mm)	Power Mode	Ch.	Freq. (MHz)	Average Power (dBm)	Tune-Up Limit (dBm)	Tune-up Scaling Factor	Duty Cycle %	Duty Cycle Scaling Factor	Power Drift (dB)	Measured 1g SAR (W/kg)	Reported 1g SAR (W/kg)
	WLAN5.3GHz	802.11a 6Mbps	Front	5	Full	52	5260	14.97	15.50	1.130	87.43	1.144	0.05	0.395	0.511
06	WLAN5.3GHz	802.11a 6Mbps	Back	5	Full	52	5260	14.97	15.50	1.130	87.43	1.144	-0.01	0.657	0.849
	WLAN5.3GHz	802.11a 6Mbps	Back	5	Full	56	5280	14.73	15.50	1.194	87.43	1.144	0.03	0.612	0.836
	WLAN5.5GHz	802.11a 6Mbps	Front	5	Full	124	5620	14.94	15.50	1.138	87.43	1.144	0.02	0.209	0.272
07	WLAN5.5GHz	802.11a 6Mbps	Back	5	Full	124	5620	14.94	15.50	1.138	87.43	1.144	-0.09	0.403	0.524
	WLAN 5.8GHz	802.11a 6Mbps	Front	5	Full	157	5785	15.31	15.50	1.045	87.43	1.144	-0.05	0.182	0.218
08	WLAN 5.8GHz	802.11a 6Mbps	Back	5	Full	157	5785	15.31	15.50	1.045	87.43	1.144	-0.09	0.517	0.618



15.4 Product specific 10g SAR

<WLAN 5GHz SAR>

Plot No.	Band	Mode	Test Position	Gap (mm)	Power Mode	Ch.	Freq. (MHz)	Average Power (dBm)	Tune-Up Limit (dBm)	Tune-up Scaling Factor	Duty Cycle %	Duty Cycle Scaling Factor	Power Drift (dB)	Max Area Scan SAR	Measured 10g SAR (W/kg)	Reported 10g SAR (W/kg)
	WLAN5.3GHz	802.11a 6Mbps	Front	0	Full	52	5260	14.97	15.50	1.130	87.43	1.144		1.13		
09	WLAN5.3GHz	802.11a 6Mbps	Back	0	Full	52	5260	14.97	15.50	1.130	87.43	1.144	0.01	3.48	0.415	0.536
	WLAN5.3GHz	802.11a 6Mbps	Right Side	0	Full	52	5260	14.97	15.50	1.130	87.43	1.144		0.29		
	WLAN5.3GHz	802.11a 6Mbps	Top Side	0	Full	52	5260	14.97	15.50	1.130	87.43	1.144		1.25		
	WLAN 5.5GHz	802.11a 6Mbps	Front	0	Full	124	5620	14.94	15.50	1.138	87.43	1.144		0.63		
10	WLAN 5.5GHz	802.11a 6Mbps	Back	0	Full	124	5620	14.94	15.50	1.138	87.43	1.144	0.09	1.42	0.24	0.312
	WLAN 5.5GHz	802.11a 6Mbps	Right Side	0	Full	124	5620	14.94	15.50	1.138	87.43	1.144		0.085		
	WLAN 5.5GHz	802.11a 6Mbps	Top Side	0	Full	124	5620	14.94	15.50	1.138	87.43	1.144		0.514		

16. Simultaneous Transmission Analysis

No.	Simultaneous Transmission Configurations	Portable Handset				Note
		Head	Body-worn	Hotspot	Product specific 10g SAR	
1.	GSM Voice + WLAN2.4GHz	Yes	Yes			
2.	GPRS/EDGE + WLAN2.4GHz	Yes	Yes	Yes	Yes	WLAN Hotspot
3.	WCDMA + WLAN2.4GHz	Yes	Yes	Yes	Yes	WLAN Hotspot
4.	LTE + WLAN2.4GHz	Yes	Yes	Yes	Yes	WLAN Hotspot
5.	GSM Voice + WLAN5.3/5.5GHz	Yes	Yes			
6.	GPRS/EDGE + WLAN5.3/5.5GHz	Yes	Yes		Yes	WLAN Direct (GC only)
7.	WCDMA + WLAN5.3/5.5GHz	Yes	Yes		Yes	WLAN Direct (GC only)
8.	LTE + WLAN5.3/5.5GHz	Yes	Yes		Yes	WLAN Direct (GC only)
9.	GSM Voice + WLAN5.2/5.8GHz	Yes	Yes			
10.	GPRS/EDGE + WLAN5.2/5.8GHz	Yes	Yes	Yes	Yes	WLAN Hotspot/Direct(GC/GO)
11.	WCDMA + WLAN5.2/5.8GHz	Yes	Yes	Yes	Yes	WLAN Hotspot/Direct(GC/GO)
12.	LTE + WLAN5.2/5.8GHz	Yes	Yes	Yes	Yes	WLAN Hotspot/Direct(GC/GO)
13.	GSM Voice + Bluetooth		Yes			
14.	GPRS/EDGE + Bluetooth		Yes	Yes	Yes	BT Tethering
15.	WCDMA + Bluetooth		Yes	Yes	Yes	BT Tethering
16.	LTE + Bluetooth		Yes	Yes	Yes	BT Tethering

General Note:

- This device supports VoIP in GPRS, EGPRS, WCDMA and LTE (e.g. for 3rd-party VoIP), LTE supports VoLTE operation.
- EUT will choose each GSM, WCDMA and LTE according to the network signal condition; therefore, they will not operate simultaneously at any moment.
- This device 2.4GHz WLAN support hotspot operation and Bluetooth support tethering applications.
- This device 2.4GHz WLAN/ 5.2GHz WLAN/5.8GHz WLAN support hotspot operation, and 5.2GHz WLAN/5.8GHz WLAN supports WLAN Direct (GC/GO), and 5.3GHz / 5.5GHz supports WLAN Direct (GC only).
- EUT will choose either WLAN 2.4GHz or WLAN 5GHz according to the network signal condition; therefore, 2.4GHz WLAN and 5GHz WLAN will not operate simultaneously at any moment though they have independent antenna.
- WLAN 2.4GHz and Bluetooth share the same antenna so can't transmit simultaneously.
- According to the EUT character, WLAN 5GHz and Bluetooth can't transmit simultaneously.
- Chose the worst zoom scan SAR of WLAN correspondingly for co-located with WWAN analysis.
- The reported SAR summation is calculated based on the same configuration and test position.
- Per KDB 447498 D01v06, simultaneous transmission SAR is compliant if,
 - 1g Scalar SAR summation < 1.6W/kg and 10g Scalar SAR summation < 4.0W/kg.
 - $SPLSR = (SAR1 + SAR2)^{1.5} / (\text{min. separation distance, mm})$, and the peak separation distance is determined from the square root of $[(x1-x2)^2 + (y1-y2)^2 + (z1-z2)^2]$, where (x1, y1, z1) and (x2, y2, z2) are the coordinates of the extrapolated peak SAR locations in the zoom scan.
 - If $SPLSR \leq 0.04$ for 1g SAR, $SPLSR \leq 0.10$ for 10g SAR simultaneously transmission SAR measurement is not necessary.
 - Simultaneously transmission SAR measurement, and the reported multi-band 1g SAR < 1.6W/kg and 10g SAR < 4.0W/kg.
 - The SPLSR calculated results please refer to section 16.5.



16.1 Head Exposure Conditions

WWAN Band	Exposure Position	1		2	3	1+2		1+3			
		WWAN		2.4GHz WLAN	5GHz WLAN	Summed 1g SAR (W/kg)	SPLSR	Case No	Summed 1g SAR (W/kg)	SPLSR	Case No
		Ant.	1g SAR (W/kg)	1g SAR (W/kg)	1g SAR (W/kg)						
GSM	GSM850	Right Cheek	1	0.418	0.740	0.721	1.16		1.14		
		Right Tilted	1	0.263	0.740	0.758	1.00		1.02		
		Left Cheek	1	0.327	0.472	0.993	0.80		1.32		
		Left Tilted	1	0.223	0.740	0.830	0.96		1.05		
	GSM1900	Right Cheek	1	0.151	0.740	0.721	0.89		0.87		
		Right Tilted	1	0.068	0.740	0.758	0.81		0.83		
		Left Cheek	1	0.134	0.472	0.993	0.61		1.13		
		Left Tilted	1	0.063	0.740	0.830	0.80		0.89		
WCDMA	Band V	Right Cheek	1	0.440	0.740	0.721	1.18		1.16		
		Right Tilted	1	0.309	0.740	0.758	1.05		1.07		
		Left Cheek	1	0.344	0.472	0.993	0.82		1.34		
		Left Tilted	1	0.266	0.740	0.830	1.01		1.10		
	Band IV	Right Cheek	1	0.414	0.740	0.721	1.15		1.14		
		Right Tilted	1	0.247	0.740	0.758	0.99		1.01		
		Left Cheek	1	0.488	0.472	0.993	0.96		1.48		
		Left Tilted	1	0.179	0.740	0.830	0.92		1.01		
	Band II	Right Cheek	1	0.308	0.740	0.721	1.05		1.03		
		Right Tilted	1	0.156	0.740	0.758	0.90		0.91		
		Left Cheek	1	0.319	0.472	0.993	0.79		1.31		
		Left Tilted	1	0.139	0.740	0.830	0.88		0.97		
LTE	Band 12	Right Cheek	1	0.337	0.740	0.721	1.08		1.06		
		Right Tilted	1	0.234	0.740	0.758	0.97		0.99		
		Left Cheek	1	0.312	0.472	0.993	0.78		1.31		
		Left Tilted	1	0.194	0.740	0.830	0.93		1.02		
	Band 5	Right Cheek	1	0.360	0.740	0.721	1.10		1.08		
		Right Tilted	1	0.198	0.740	0.758	0.94		0.96		
		Left Cheek	1	0.275	0.472	0.993	0.75		1.27		
		Left Tilted	1	0.189	0.740	0.830	0.93		1.02		
	Band 4	Right Cheek	1	0.269	0.740	0.721	1.01		0.99		
		Right Tilted	1	0.119	0.740	0.758	0.86		0.88		
		Left Cheek	1	0.317	0.472	0.993	0.79		1.31		
		Left Tilted	1	0.138	0.740	0.830	0.88		0.97		
	Band 2	Right Cheek	1	0.247	0.740	0.721	0.99		0.97		
		Right Tilted	1	0.124	0.740	0.758	0.86		0.88		
		Left Cheek	1	0.199	0.472	0.993	0.67		1.19		
		Left Tilted	1	0.125	0.740	0.830	0.87		0.96		
	Band 7	Right Cheek	2	0.427	0.740	0.721	1.17		1.15		
		Right Tilted	2	0.311	0.740	0.758	1.05		1.07		
		Left Cheek	2	0.864	0.472	0.993	1.34		1.86	0.03	#1
		Left Tilted	2	0.195	0.740	0.830	0.94		1.03		
		Right Cheek	3	0.724	0.740	0.721	1.46		1.45		
		Right Tilted	3	0.187	0.740	0.758	0.93		0.95		
		Left Cheek	3	0.340	0.472	0.993	0.81		1.33		
		Left Tilted	3	0.241	0.740	0.830	0.98		1.07		



16.2 Hotspot Exposure Conditions

WWAN Band	Exposure Position	1		2	3	4	1+2			1+3			1+4			
		WWAN		2.4GHz WLAN	5GHz WLAN	Bluetooth	Summed 1g SAR (W/kg)	SPLSR	Case No	Summed 1g SAR (W/kg)	SPLSR	Case No	Summed 1g SAR (W/kg)	SPLSR	Case No	
		Ant.	1g SAR (W/kg)	1g SAR (W/kg)	1g SAR (W/kg)	1g SAR (W/kg)										
GSM	GSM850	Front	1	1.142	0.171	0.493	0.078	1.31			1.64	0.01	#2	1.22		
		Back	1	0.929	0.427	0.817	0.110	1.36			1.75	0.01	#3	1.04		
		Left Side	1	0.400				0.40			0.40			0.40		
		Right Side	1	0.646	0.427	0.161	0.018	1.07			0.81			0.66		
		Top Side	1		0.427	0.304	0.072	0.43			0.30			0.07		
		Bottom Side	1	0.553				0.55			0.55			0.55		
	GSM1900	Front	1	0.785	0.171	0.493	0.078	0.96			1.28			0.86		
		Back	1	0.645	0.427	0.817	0.110	1.07			1.46			0.76		
		Left Side	1	0.110				0.11			0.11			0.11		
		Right Side	1	0.032	0.427	0.161	0.018	0.46			0.19			0.05		
		Top Side	1		0.427	0.304	0.072	0.43			0.30			0.07		
		Bottom Side	1	1.073				1.07			1.07			1.07		
WCDMA	Band V	Front	1	0.940	0.171	0.493	0.078	1.11			1.43			1.02		
		Back	1	0.553	0.427	0.817	0.110	0.98			1.37			0.66		
		Left Side	1	0.262				0.26			0.26			0.26		
		Right Side	1	0.539	0.427	0.161	0.018	0.97			0.70			0.56		
		Top Side	1		0.427	0.304	0.072	0.43			0.30			0.07		
		Bottom Side	1	0.464				0.46			0.46			0.46		
	Band IV	Front	1	0.775	0.171	0.493	0.078	0.95			1.27			0.85		
		Back	1	0.428	0.427	0.817	0.110	0.86			1.25			0.54		
		Left Side	1	0.088				0.09			0.09			0.09		
		Right Side	1	0.044	0.427	0.161	0.018	0.47			0.21			0.06		
		Top Side	1		0.427	0.304	0.072	0.43			0.30			0.07		
		Bottom Side	1	1.031				1.03			1.03			1.03		
	Band II	Front	1	0.675	0.171	0.493	0.078	0.85			1.17			0.75		
		Back	1	0.549	0.427	0.817	0.110	0.98			1.37			0.66		
		Left Side	1	0.100				0.10			0.10			0.10		
		Right Side	1	0.029	0.427	0.161	0.018	0.46			0.19			0.05		
		Top Side	1		0.427	0.304	0.072	0.43			0.30			0.07		
		Bottom Side	1	1.060				1.06			1.06			1.06		



WWAN Band	Exposure Position	1		2	3	4	1+2			1+3			1+4			
		WWAN		2.4GHz WLAN	5GHz WLAN	Bluetooth	Summed 1g SAR (W/kg)	SPLSR	Case No	Summed 1g SAR (W/kg)	SPLSR	Case No	Summed 1g SAR (W/kg)	SPLSR	Case No	
		Ant.	1g SAR (W/kg)	1g SAR (W/kg)	1g SAR (W/kg)	1g SAR (W/kg)										
LTE	Band 12	Front	1	0.661	0.171	0.493	0.078	0.83			1.15			0.74		
		Back	1	0.576	0.427	0.817	0.110	1.00			1.39			0.69		
		Left Side	1	0.395				0.40			0.40			0.40		
		Right Side	1	0.554	0.427	0.161	0.018	0.98			0.72			0.57		
		Top Side	1		0.427	0.304	0.072	0.43			0.30			0.07		
		Bottom Side	1	0.375				0.38			0.38			0.38		
	Band 5	Front	1	1.053	0.171	0.493	0.078	1.22			1.55			1.13		
		Back	1	1.042	0.427	0.817	0.110	1.47			1.86	0.02	#4	1.15		
		Left Side	1	0.260				0.26			0.26			0.26		
		Right Side	1	0.651	0.427	0.161	0.018	1.08			0.81			0.67		
		Top Side	1		0.427	0.304	0.072	0.43			0.30			0.07		
		Bottom Side	1	0.697				0.70			0.70			0.70		
	Band 4	Front	1	0.603	0.171	0.493	0.078	0.77			1.10			0.68		
		Back	1	0.399	0.427	0.817	0.110	0.83			1.22			0.51		
		Left Side	1	0.076				0.08			0.08			0.08		
		Right Side	1	0.035	0.427	0.161	0.018	0.46			0.20			0.05		
		Top Side	1		0.427	0.304	0.072	0.43			0.30			0.07		
		Bottom Side	1	0.928				0.93			0.93			0.93		
	Band 2	Front	1	0.702	0.171	0.493	0.078	0.87			1.20			0.78		
		Back	1	0.503	0.427	0.817	0.110	0.93			1.32			0.61		
		Left Side	1	0.091				0.09			0.09			0.09		
		Right Side	1	0.029	0.427	0.161	0.018	0.46			0.19			0.05		
		Top Side	1		0.427	0.304	0.072	0.43			0.30			0.07		
		Bottom Side	1	1.084				1.08			1.08			1.08		
	Band 7	Front	2	0.833	0.171	0.493	0.078	1.00			1.33			0.91		
		Back	2	0.621	0.427	0.817	0.110	1.05			1.44			0.73		
		Left Side	2	0.526				0.53			0.53			0.53		
		Right Side	2		0.427	0.161	0.018	0.43			0.16			0.02		
Top Side		2		0.427	0.304	0.072	0.43			0.30			0.07			
Bottom Side		2	0.100				0.10			0.10			0.10			
Front		3	0.961	0.171	0.493	0.078	1.13			1.45			1.04			
Back		3	0.664	0.427	0.817	0.110	1.09			1.48			0.77			
Right Side		3	0.562	0.427	0.161	0.018	0.99			0.72			0.58			
Top Side		3		0.427	0.304	0.072	0.43			0.30			0.07			
Bottom Side	3	0.069				0.07			0.07			0.07				



16.3 Body-Worn Accessory Exposure Conditions

WWAN Band		Exposure Position	1		2	3	4	1+2			1+3			1+4		
			WWAN		2.4GHz WLAN	5GHz WLAN	Bluetooth	Summed 1g SAR (W/kg)	SPLSR	Case No	Summed 1g SAR (W/kg)	SPLSR	Case No	Summed 1g SAR (W/kg)	SPLSR	Case No
			Ant.	1g SAR (W/kg)	1g SAR (W/kg)	1g SAR (W/kg)	1g SAR (W/kg)									
GSM	GSM850	Front	1	1.142	0.171	0.511	0.078	1.31			1.65	0.01	#5	1.22		
		Back	1	0.929	0.427	0.849	0.110	1.36			1.78	0.02	#6	1.04		
	GSM1900	Front	1	0.785	0.171	0.511	0.078	0.96			1.30			0.86		
		Back	1	0.645	0.427	0.849	0.110	1.07			1.49			0.76		
WCDMA	Band V	Front	1	0.940	0.171	0.511	0.078	1.11			1.45			1.02		
		Back	1	0.553	0.427	0.849	0.110	0.98			1.40			0.66		
	Band IV	Front	1	0.775	0.171	0.511	0.078	0.95			1.29			0.85		
		Back	1	0.428	0.427	0.849	0.110	0.86			1.28			0.54		
	Band II	Front	1	0.675	0.171	0.511	0.078	0.85			1.19			0.75		
		Back	1	0.549	0.427	0.849	0.110	0.98			1.40			0.66		
LTE	Band 12	Front	1	0.661	0.171	0.511	0.078	0.83			1.17			0.74		
		Back	1	0.576	0.427	0.849	0.110	1.00			1.43			0.69		
	Band 5	Front	1	1.053	0.171	0.511	0.078	1.22			1.56			1.13		
		Back	1	1.042	0.427	0.849	0.110	1.47			1.89	0.02	#7	1.15		
	Band 4	Front	1	0.603	0.171	0.511	0.078	0.77			1.11			0.68		
		Back	1	0.399	0.427	0.849	0.110	0.83			1.25			0.51		
	Band 2	Front	1	0.702	0.171	0.511	0.078	0.87			1.21			0.78		
		Back	1	0.503	0.427	0.849	0.110	0.93			1.35			0.61		
	Band 7	Front	2	0.833	0.171	0.511	0.078	1.00			1.34			0.91		
		Back	2	0.621	0.427	0.849	0.110	1.05			1.47			0.73		
Front		3	0.961	0.171	0.511	0.078	1.13			1.47			1.04			
Back		3	0.664	0.427	0.849	0.110	1.09			1.51			0.77			

16.4 Product specific 10g SAR Exposure Conditions

WWAN Band		Exposure Position	1		2	1+2		
			WWAN Bottom		5GHz WLAN	Summed 10g SAR (W/kg)	SPLSR	Case No
			Ant.	10g SAR (W/kg)	10g SAR (W/kg)			
GSM	GSM1900	Front	1	3.131	0.536	3.67		
		Back	1	2.582	0.536	3.12		
		Bottom Side	1	3.403		3.40		
WCDMA	Band IV	Front	1	1.806	0.536	2.34		
		Back	1	1.397	0.536	1.93		
		Bottom Side	1	2.777		2.78		
	Band II	Front	1	2.446	0.536	2.98		
		Back	1	1.886	0.536	2.42		
		Bottom Side	1	2.861		2.86		
LTE	Band 4	Front	1	2.859	0.536	3.40		
		Back	1	2.302	0.536	2.84		
		Bottom Side	1	3.397		3.40		
	Band 2	Front	1	2.995	0.536	3.53		
		Back	1	2.537	0.536	3.07		
		Bottom Side	1	3.620		3.62		
	Band 7	Front	2	1.092	0.536	1.63		
		Back	2	1.033	0.536	1.57		
		Left Side	2	0.975		0.98		
		Front	3	1.004	0.536	1.54		
		Back	3	1.108	0.536	1.64		
		Right Side	3	0.824	0.536	1.36		

Remark: For Bluetooth/WLAN 2.4GHz Product specific 10g stand-alone SAR is not required for a transmitter or antenna, due to 1g hotspot SAR is <1.2W/kg.

16.5 SPLSR Evaluation and Analysis

General Note:

- When standalone SAR is measured for both antennas in the pair, the peak location separation distance is computed by the square root of $[(x1-x2)^2 + (y1-y2)^2 + (z1-z2)^2]$, where (x1, y1, z1) and (x2, y2, z2) are the coordinates in the area scans or extrapolated peak SAR locations in the zoom scans, as appropriate.
- $SPLSR = (SAR_1 + SAR_2)^{1.5} / (min. \text{ separation distance, mm})$. If $SPLSR \leq 0.04$ for 1g SAR and $SPLSR \leq 0.10$ for 10g SAR, simultaneously transmission SAR measurement is not necessary.

Case #1	Band	Position	1g SAR (W/kg)	Gap (mm)	SAR peak location (cm)			3D distance (mm)	Summed 1g SAR (W/kg)	SPLSR Results	Simultaneous SAR
					X	Y	Z				
	LTE Band 7 Ant.2	Left Cheek	0.864	0	4.51	-5.92	-0.19	83.03	1.86	0.03	Not required
	WLAN5GHz		0.993	0	0.41	1.3	-0.17				

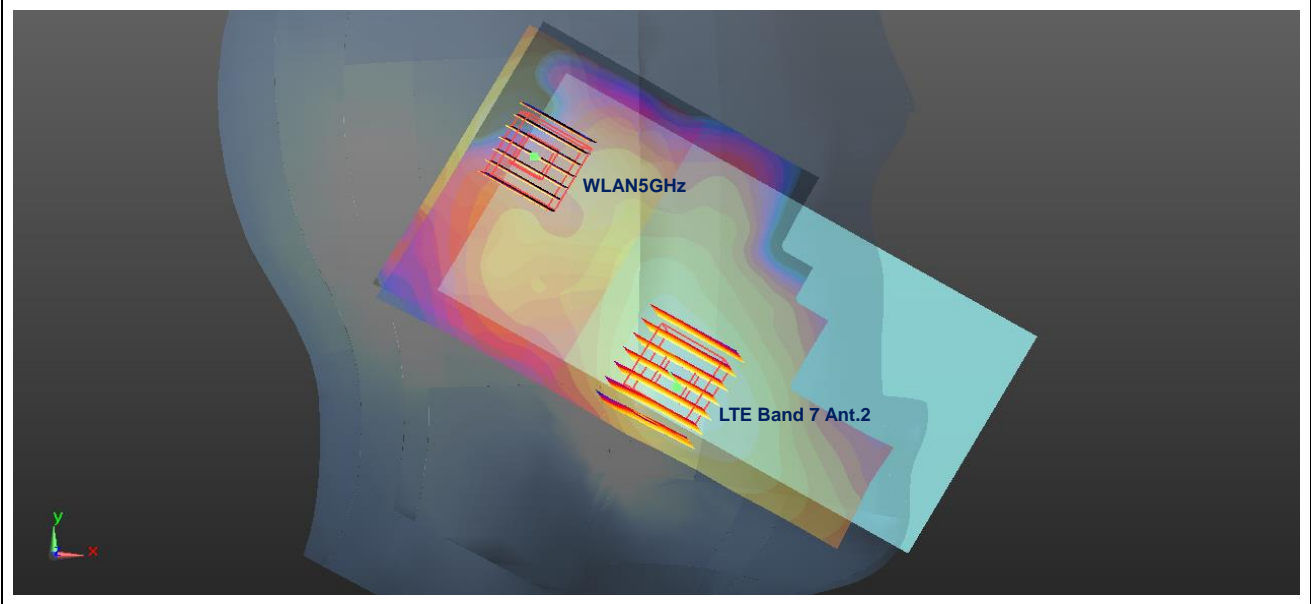

Case #2	Band	Position	1g SAR (W/kg)	Gap (mm)	SAR peak location (cm)			3D distance (mm)	Summed 1g SAR (W/kg)	SPLSR Results	Simultaneous SAR
					X	Y	Z				
	GSM850	Front	1.142	5	9.33	-1.16	0.4	158.36	1.64	0.01	Not required
	WLAN5GHz		0.493	5	-6.41	0.58	0.35				

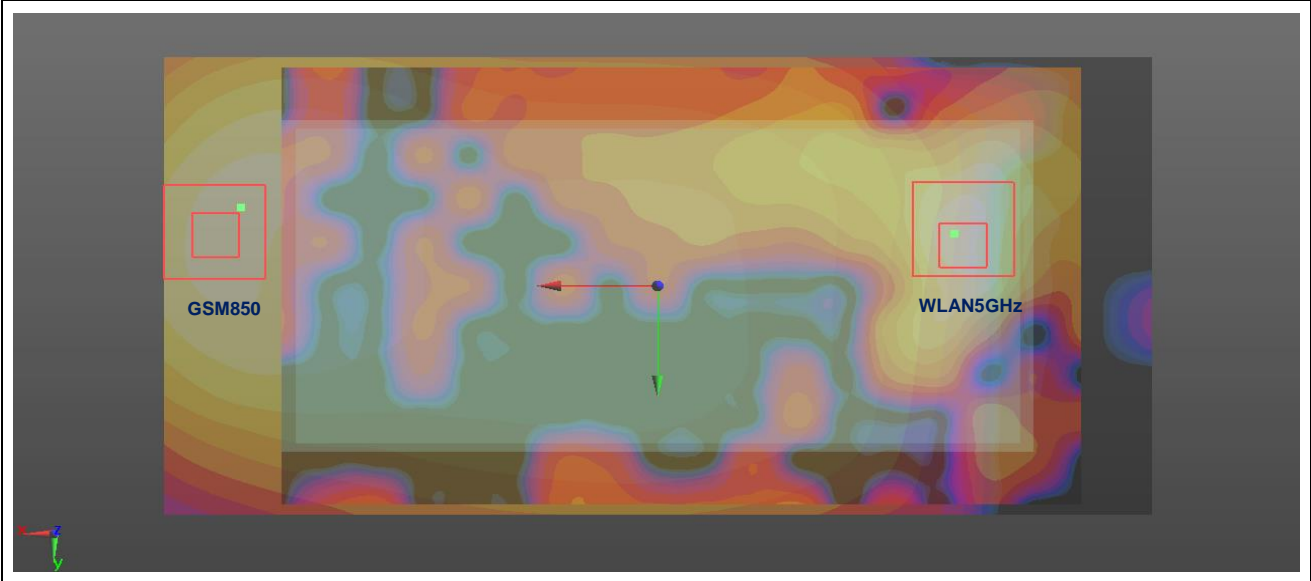

Case #3	Band	Position	1g SAR (W/kg)	Gap (mm)	SAR peak location (cm)			3D distance (mm)	Summed 1g SAR (W/kg)	SPLSR Results	Simultaneous SAR
	GSM850				X	Y	Z				
	GSM850	Back	0.929	5	9.02	0.6	0.39	155.63	1.75	0.01	Not required
	WLAN5GHz		0.817	5	-6.48	-0.8	0.4				

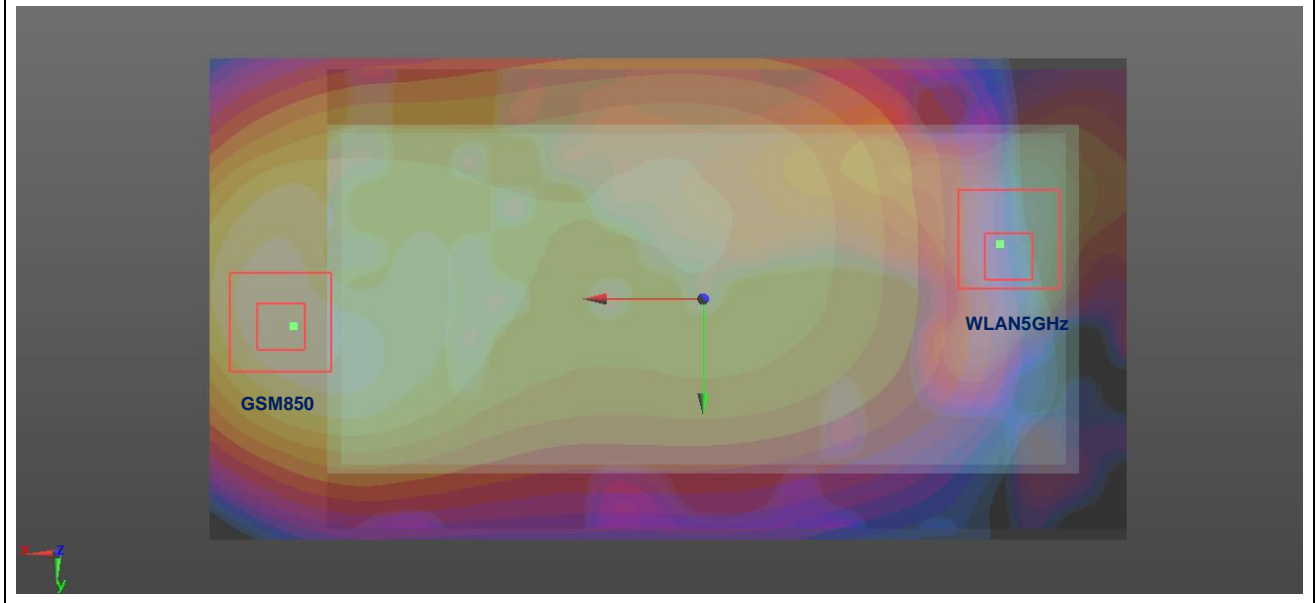

Case #4	Band	Position	1g SAR (W/kg)	Gap (mm)	SAR peak location (cm)			3D distance (mm)	Summed 1g SAR (W/kg)	SPLSR Results	Simultaneous SAR
	LTE Band 5				X	Y	Z				
	LTE Band 5	Back	1.042	5	7.35	1.95	0.55	141.02	1.86	0.02	Not required
	WLAN5GHz		0.817	5	-6.48	-0.8	0.4				

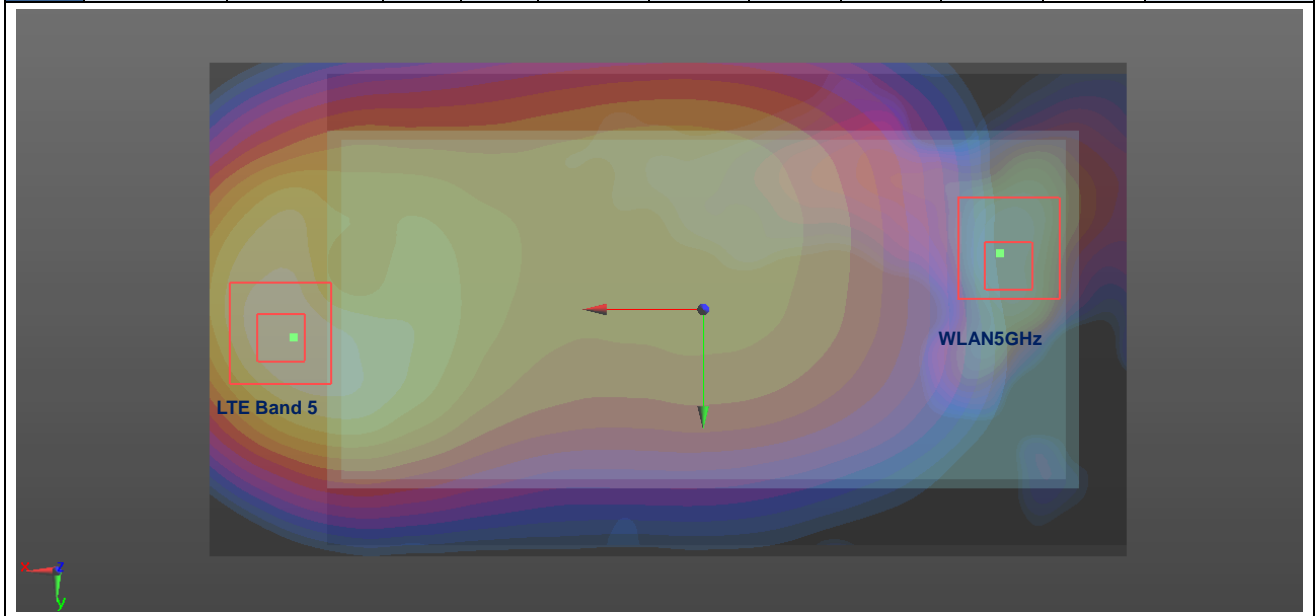

Case #5	Band	Position	1g SAR (W/kg)	Gap (mm)	SAR peak location (cm)			3D distance (mm)	Summed 1g SAR (W/kg)	SPLSR Results	Simultaneous SAR
					X	Y	Z				
	GSM850	Front	1.142	5	9.33	-1.16	0.4	158.28	1.65	0.01	Not required
	WLAN5GHz		0.511	5	-6.32	1.20	0.25				

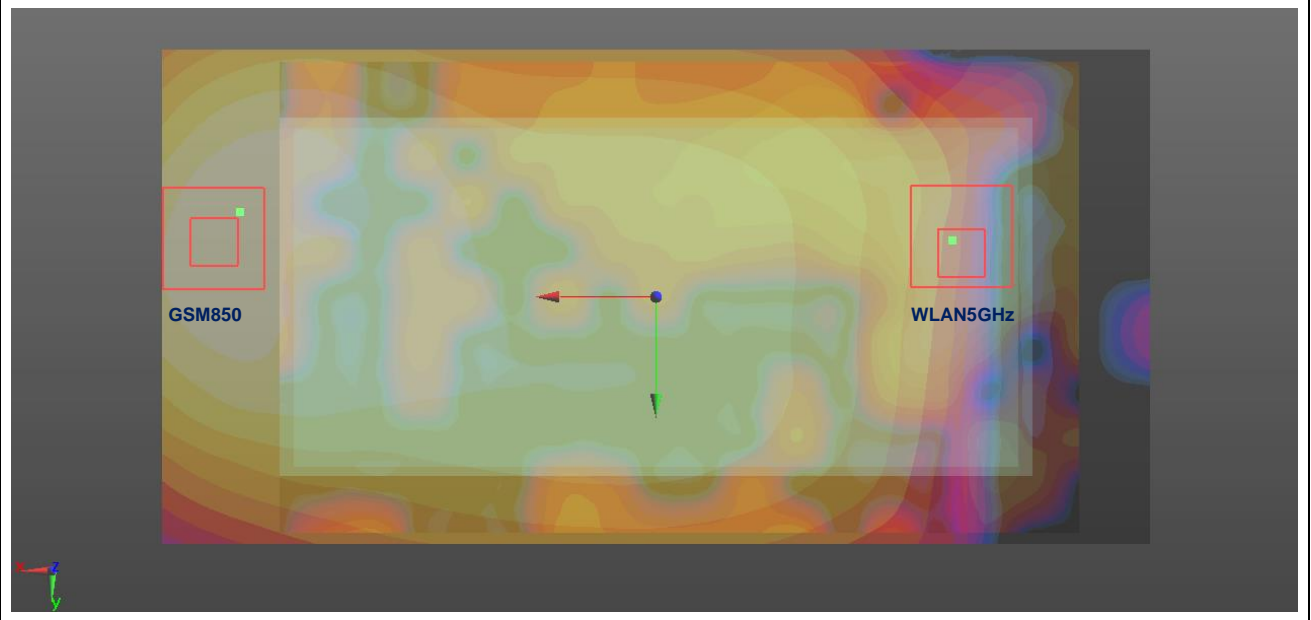

Case #6	Band	Position	1g SAR (W/kg)	Gap (mm)	SAR peak location (cm)			3D distance (mm)	Summed 1g SAR (W/kg)	SPLSR Results	Simultaneous SAR
					X	Y	Z				
	GSM850	Back	0.929	5	9.02	0.6	0.39	155.81	1.78	0.02	Not required
	WLAN5GHz		0.849	5	-6.56	0.78	0.4				

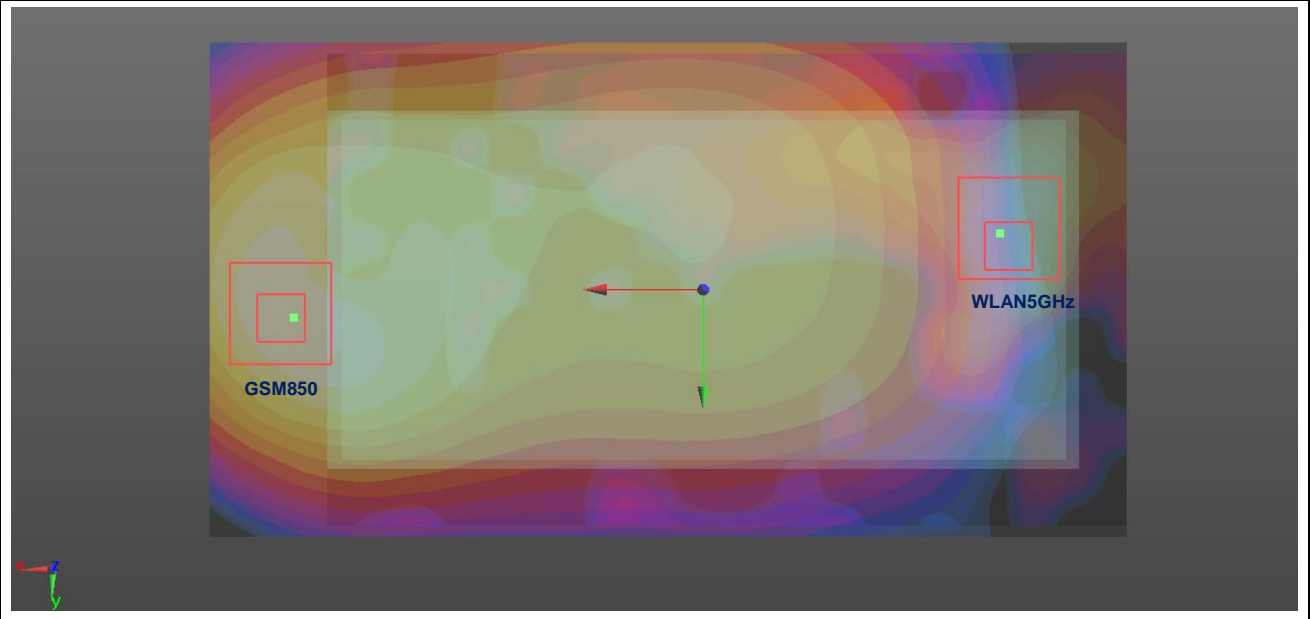

Case #7	Band	Position	1g SAR (W/kg)	Gap (mm)	SAR peak location (cm)			3D distance (mm)	Summed 1g SAR (W/kg)	SPLSR Results	Simultaneous SAR
					X	Y	Z				
	LTE Band 5	Back	1.042	5	7.35	1.95	0.55	139.60	1.89	0.02	Not required
	WLAN5GHz		0.849	5	-6.56	0.78	0.4				

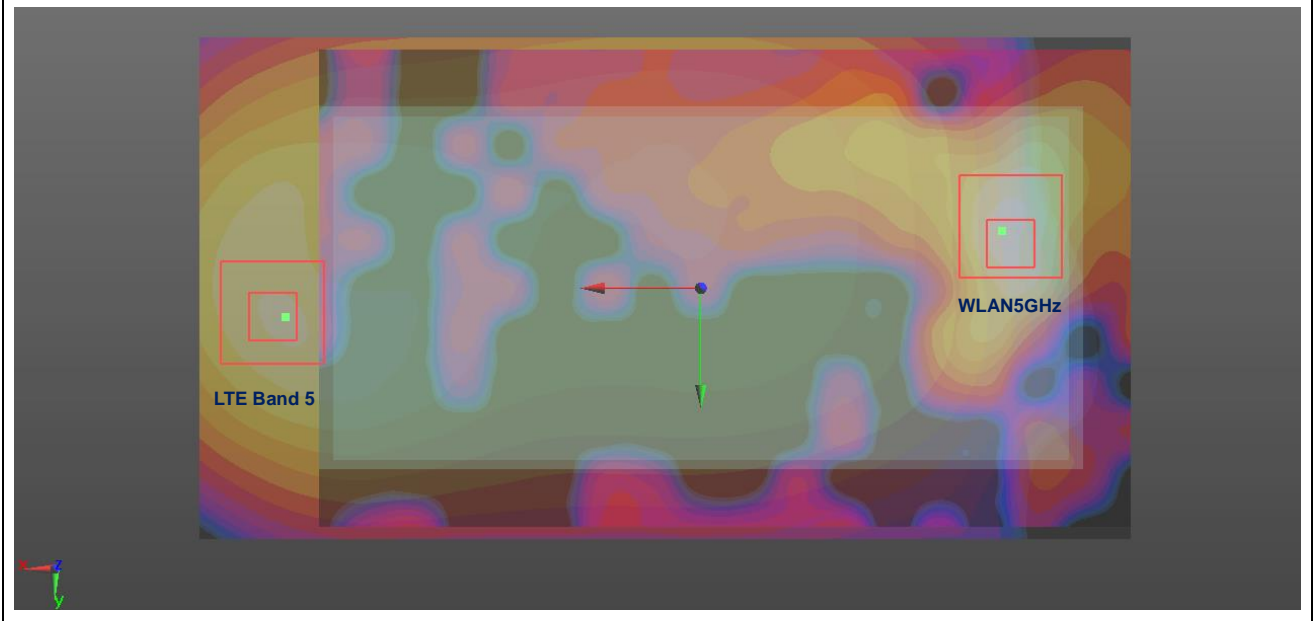

Test Engineer: Nick Hu



17. Uncertainty Assessment

Pre KDB 865664 D01 SAR measurement 100MHz to 6GHz, when the highest measured 1-g SAR within a frequency band is < 1.5 W/kg and the measured 10-g SAR within a frequency band is < 3.75 W/kg. The expanded SAR measurement uncertainty must be $\leq 30\%$, for a confidence interval of $k = 2$. If these conditions are met, extensive SAR measurement uncertainty analysis described in IEEE Std 1528-2013 is not required in SAR reports submitted for equipment approval. For this device, the highest measured 1-g SAR is less 1.5W/kg and highest measured 10-g SAR is less 3.75W/kg. Therefore, the measurement uncertainty table is not required in this report.

18. References

- [1] FCC 47 CFR Part 2 “Frequency Allocations and Radio Treaty Matters; General Rules and Regulations”
- [2] ANSI/IEEE Std. C95.1-1992, “IEEE Standard for Safety Levels with Respect to Human Exposure to Radio Frequency Electromagnetic Fields, 3 kHz to 300 GHz”, September 1992
- [3] IEEE Std. 1528-2013, “IEEE Recommended Practice for Determining the Peak Spatial-Average Specific Absorption Rate (SAR) in the Human Head from Wireless Communications Devices: Measurement Techniques”, Sep 2013
- [4] SPEAG DASY System Handbook
- [5] FCC KDB 865664 D01 v01r04, "SAR Measurement Requirements for 100 MHz to 6 GHz", Aug 2015.
- [6] FCC KDB 865664 D02 v01r02, “RF Exposure Compliance Reporting and Documentation Considerations” Oct 2015.
- [7] FCC KDB 447498 D01 v06, “Mobile and Portable Device RF Exposure Procedures and Equipment Authorization Policies”, Oct 2015
- [8] FCC KDB 648474 D04 v01r03, “SAR Evaluation Considerations for Wireless Handsets”, Oct 2015.
- [9] FCC KDB 248227 D01 v02r02, “SAR Guidance for IEEE 802.11 (WiFi) Transmitters”, Oct 2015.
- [10] FCC KDB 941225 D01 v03r01, “3G SAR MEAUREMENT PROCEDURES”, Oct 2015
- [11] FCC KDB 941225 D05 v02r05, “SAR Evaluation Considerations for LTE Devices”, Dec 2015
- [12] FCC KDB 941225 D06 v02r01, "SAR Evaluation Procedures for Portable Devices with Wireless Router Capabilities", Oct 2015.



Appendix A. Plots of System Performance Check

The plots are shown as follows.

System Check_HSL_5250MHz

DUT: D5GHzV2-SN:1167

Communication System: UID 0, CW (0); Frequency: 5250 MHz; Duty Cycle: 1:1
Medium: HSL_5000 Medium parameters used: $f = 5250$ MHz; $\sigma = 4.864$ S/m; $\epsilon_r = 37.111$; $\rho = 1000$ kg/m³
Ambient Temperature : 23.5 °C ; Liquid Temperature : 22.6 °C

DASY5 Configuration:

- Probe: EX3DV4 - SN3898; ConvF(5.62, 5.62, 5.62); Calibrated: 2017.6.27;
- Sensor-Surface: 1.4mm (Mechanical Surface Detection)
- Electronics: DAE4 Sn1338; Calibrated: 2017.12.4
- Phantom: SAM1; Type: SAM; Serial: TP-1488
- Measurement SW: DASY52, Version 52.8 (8); SEMCAD X Version 14.6.10 (7331)

Pin=250mW/Area Scan (71x71x1): Interpolated grid: dx=1.000 mm, dy=1.000 mm
Maximum value of SAR (interpolated) = 21.3 W/kg

Pin=250mW/Zoom Scan (8x8x7)/Cube 0: Measurement grid: dx=4mm, dy=4mm, dz=1.4mm
Reference Value = 44.38 V/m; Power Drift = -0.14 dB
Peak SAR (extrapolated) = 35.1 W/kg
SAR(1 g) = 8.31 W/kg; SAR(10 g) = 2.15 W/kg
Maximum value of SAR (measured) = 20.9 W/kg

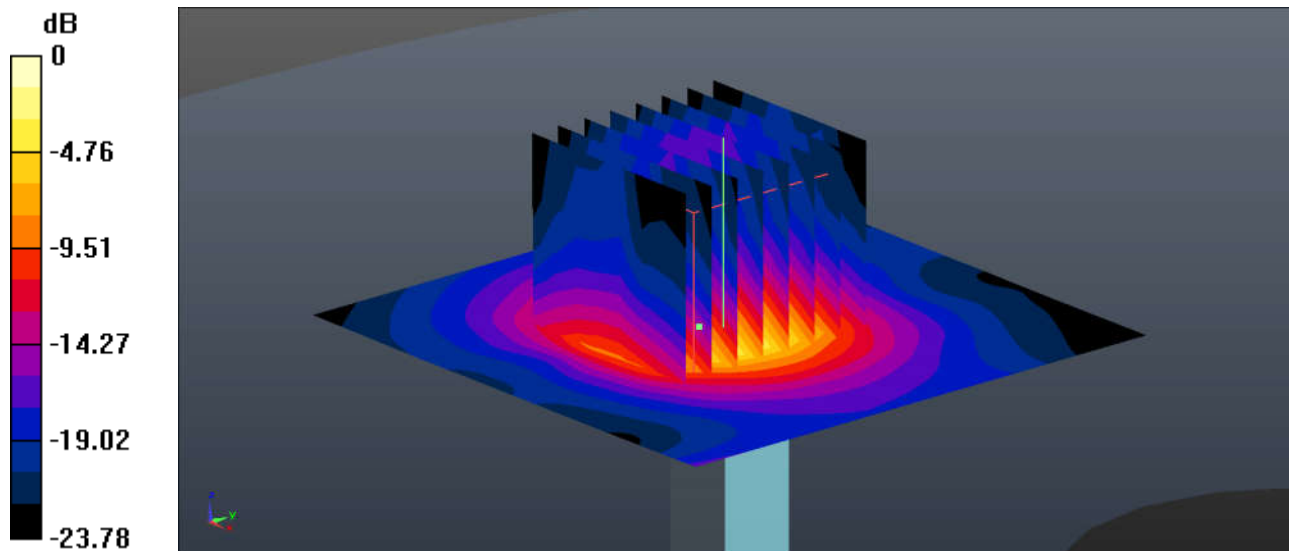

0 dB = 20.9 W/kg = 13.20 dBW/kg

System Check_HSL_5600MHz

DUT: D5GHzV2-SN:1167

Communication System: UID 0, CW (0); Frequency: 5600 MHz; Duty Cycle: 1:1

Medium: HSL_5000 Medium parameters used: $f = 5600 \text{ MHz}$; $\sigma = 5.206 \text{ S/m}$; $\epsilon_r = 36.588$; $\rho = 1000 \text{ kg/m}^3$

Ambient Temperature : $23.5 \text{ }^\circ\text{C}$; Liquid Temperature : $22.6 \text{ }^\circ\text{C}$

DASY5 Configuration:

- Probe: EX3DV4 - SN3898; ConvF(5.03, 5.03, 5.03); Calibrated: 2017.6.27;
- Sensor-Surface: 1.4mm (Mechanical Surface Detection)
- Electronics: DAE4 Sn1338; Calibrated: 2017.12.4
- Phantom: SAM1; Type: SAM; Serial: TP-1488
- Measurement SW: DASY52, Version 52.8 (8); SEMCAD X Version 14.6.10 (7331)

Pin=250mW/Area Scan (71x71x1): Interpolated grid: $dx=1.000 \text{ mm}$, $dy=1.000 \text{ mm}$

Maximum value of SAR (interpolated) = 24.5 W/kg

Pin=250mW/Zoom Scan (8x8x7)/Cube 0: Measurement grid: $dx=4\text{mm}$, $dy=4\text{mm}$, $dz=1.4\text{mm}$

Reference Value = 44.85 V/m ; Power Drift = -0.06 dB

Peak SAR (extrapolated) = 38.7 W/kg

SAR(1 g) = 8.50 W/kg ; SAR(10 g) = 2.27 W/kg

Maximum value of SAR (measured) = 24.0 W/kg

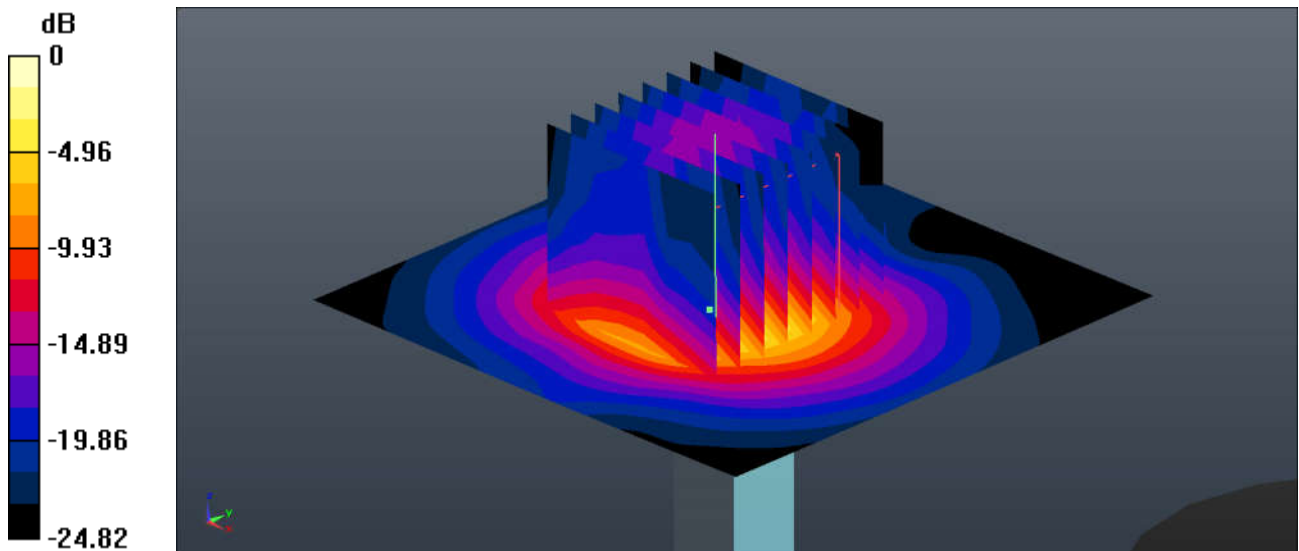

0 dB = $24.0 \text{ W/kg} = 13.80 \text{ dBW/kg}$

System Check_HSL_5750MHz

DUT: D5GHzV2-SN:1167

Communication System: UID 0, CW (0); Frequency: 5750 MHz; Duty Cycle: 1:1
Medium: HSL_5000 Medium parameters used: $f = 5750 \text{ MHz}$; $\sigma = 5.361 \text{ S/m}$; $\epsilon_r = 36.37$; $\rho = 1000 \text{ kg/m}^3$
Ambient Temperature : $23.5 \text{ }^\circ\text{C}$; Liquid Temperature : $22.6 \text{ }^\circ\text{C}$

DASY5 Configuration:

- Probe: EX3DV4 - SN3898; ConvF(5.18, 5.18, 5.18); Calibrated: 2017.6.27;
- Sensor-Surface: 1.4mm (Mechanical Surface Detection)
- Electronics: DAE4 Sn1338; Calibrated: 2017.12.4
- Phantom: SAM1; Type: SAM; Serial: TP-1488
- Measurement SW: DASY52, Version 52.8 (8); SEMCAD X Version 14.6.10 (7331)

CW/Area Scan (71x71x1): Interpolated grid: $dx=1.000 \text{ mm}$, $dy=1.000 \text{ mm}$
Maximum value of SAR (interpolated) = 22.9 W/kg

CW/Zoom Scan (8x8x7)/Cube 0: Measurement grid: $dx=4\text{mm}$, $dy=4\text{mm}$, $dz=1.4\text{mm}$
Reference Value = 42.62 V/m ; Power Drift = -0.06 dB
Peak SAR (extrapolated) = 38.7 W/kg
SAR(1 g) = 8.20 W/kg ; SAR(10 g) = 2.16 W/kg
Maximum value of SAR (measured) = 23.5 W/kg

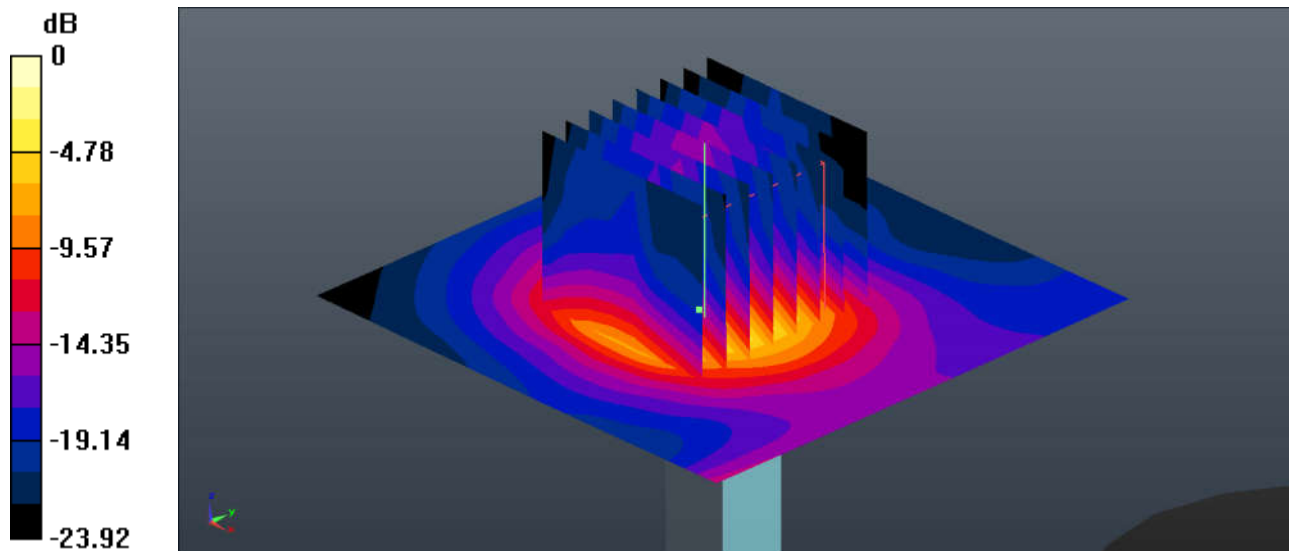

0 dB = $23.5 \text{ W/kg} = 13.71 \text{ dBW/kg}$

System Check_Body_5250MHz

DUT: D5GHzV2-SN:1167

Communication System: UID 0, CW (0); Frequency: 5250 MHz; Duty Cycle: 1:1
Medium: MSL_5000 Medium parameters used: $f = 5250$ MHz; $\sigma = 5.506$ S/m; $\epsilon_r = 47.953$; $\rho = 1000$ kg/m³
Ambient Temperature : 23.3 °C ; Liquid Temperature : 22.7 °C

DASY5 Configuration:

- Probe: EX3DV4 - SN3898; ConvF(5.13, 5.13, 5.13); Calibrated: 2017.6.27;
- Sensor-Surface: 1.4mm (Mechanical Surface Detection)
- Electronics: DAE4 Sn1338; Calibrated: 2017.12.4
- Phantom: SAM2; Type: SAM; Serial: TP-1489
- Measurement SW: DASY52, Version 52.8 (8); SEMCAD X Version 14.6.10 (7331)

Pin=100mW/Area Scan (71x71x1): Interpolated grid: dx=1.000 mm, dy=1.000 mm
Maximum value of SAR (interpolated) = 11.6 W/kg

Pin=100mW/Zoom Scan (8x8x7)/Cube 0: Measurement grid: dx=4mm, dy=4mm, dz=1.4mm
Reference Value = 30.02 V/m; Power Drift = 0.02 dB
Peak SAR (extrapolated) = 21.0 W/kg
SAR(1 g) = 7.38 W/kg; SAR(10 g) = 2.03 W/kg
Maximum value of SAR (measured) = 11.5 W/kg

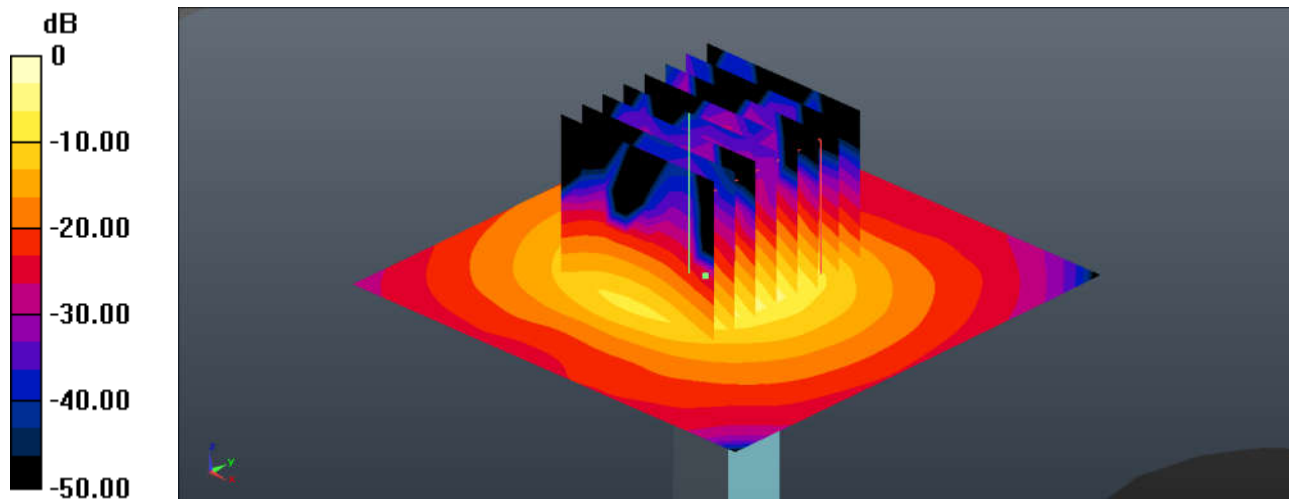

0 dB = 11.5 W/kg = 10.61 dBW/kg

System Check_Body_5600MHz

DUT: D5GHzV2-SN:1167

Communication System: UID 0, CW (0); Frequency: 5600 MHz; Duty Cycle: 1:1
Medium: MSL_5000 Medium parameters used: $f = 5600$ MHz; $\sigma = 5.953$ S/m; $\epsilon_r = 47.365$; $\rho = 1000$ kg/m³
Ambient Temperature : 23.5 °C ; Liquid Temperature : 22.7 °C

DASY5 Configuration:

- Probe: EX3DV4 - SN3898; ConvF(4.14, 4.14, 4.14); Calibrated: 2017.6.27;
- Sensor-Surface: 1.4mm (Mechanical Surface Detection)
- Electronics: DAE4 Sn1338; Calibrated: 2017.12.4
- Phantom: SAM2; Type: SAM; Serial: TP-1489
- Measurement SW: DASY52, Version 52.8 (8); SEMCAD X Version 14.6.10 (7331)

Pin=100mW/Area Scan (71x71x1): Interpolated grid: dx=1.000 mm, dy=1.000 mm
Maximum value of SAR (interpolated) = 13.5 W/kg

Pin=100mW/Zoom Scan (8x8x7)/Cube 0: Measurement grid: dx=4mm, dy=4mm, dz=1.4mm
Reference Value = 30.62 V/m; Power Drift = 0.05 dB
Peak SAR (extrapolated) = 24.0 W/kg
SAR(1 g) = 7.42 W/kg; SAR(10 g) = 2.21 W/kg
Maximum value of SAR (measured) = 13.2 W/kg

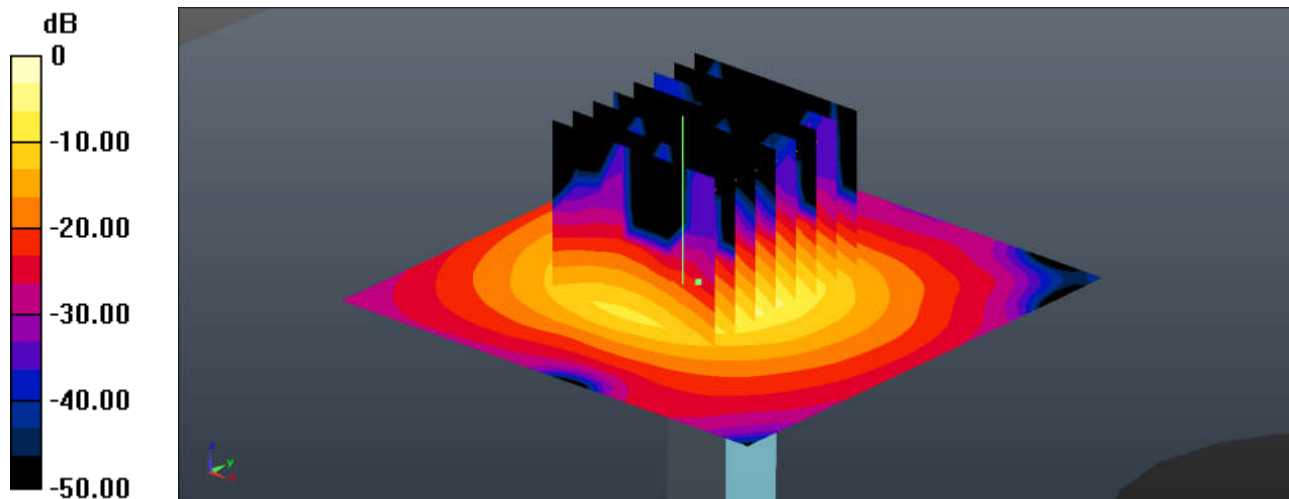

0 dB = 13.2 W/kg = 11.21 dBW/kg

System Check_Body_5750MHz

DUT: D5GHzV2-SN:1167

Communication System: UID 0, CW (0); Frequency: 5750 MHz; Duty Cycle: 1:1
Medium: MSL_5000 Medium parameters used: $f = 5750$ MHz; $\sigma = 6.154$ S/m; $\epsilon_r = 47.115$; $\rho = 1000$ kg/m³
Ambient Temperature : 23.5 °C ; Liquid Temperature : 22.8 °C

DASY5 Configuration:

- Probe: EX3DV4 - SN3898; ConvF(4.5, 4.5, 4.5); Calibrated: 2017.6.27;
- Sensor-Surface: 1.4mm (Mechanical Surface Detection)
- Electronics: DAE4 Sn1338; Calibrated: 2017.12.4
- Phantom: SAM2; Type: SAM; Serial: TP-1489
- Measurement SW: DASY52, Version 52.8 (8); SEMCAD X Version 14.6.10 (7331)

Pin=100mW/Area Scan (71x71x1): Interpolated grid: dx=1.000 mm, dy=1.000 mm
Maximum value of SAR (interpolated) = 12.6 W/kg

Pin=100mW/Zoom Scan (8x8x7)/Cube 0: Measurement grid: dx=4mm, dy=4mm, dz=1.4mm
Reference Value = 29.51 V/m; Power Drift = 0.03 dB
Peak SAR (extrapolated) = 23.6 W/kg
SAR(1 g) = 7.64 W/kg; SAR(10 g) = 2.10 W/kg
Maximum value of SAR (measured) = 12.6 W/kg

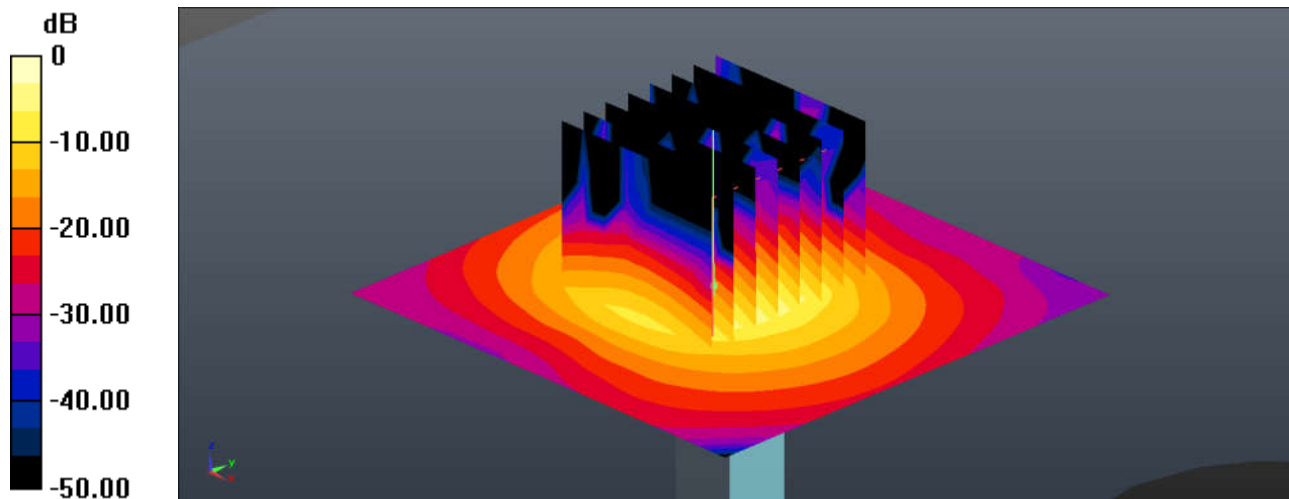

0 dB = 12.6 W/kg = 11.00 dBW/kg



Appendix B. Plots of High SAR Measurement

The plots are shown as follows.

01_WLAN5.3GHz_802.11a 6Mbps_Left Cheek_0mm_Ch52

Communication System: UID 0, WIFI (0); Frequency: 5260 MHz; Duty Cycle: 1:1.144
Medium: HSL_5000 Medium parameters used: $f = 5260$ MHz; $\sigma = 4.87$ S/m; $\epsilon_r = 37.108$;
 $\rho = 1000$ kg/m³
Ambient Temperature : 23.5 °C ; Liquid Temperature : 22.6 °C

DASY5 Configuration:

- Probe: EX3DV4 - SN3898; ConvF(5.62, 5.62, 5.62); Calibrated: 2017.6.27;
- Sensor-Surface: 1.4mm (Mechanical Surface Detection)
- Electronics: DAE4 Sn1338; Calibrated: 2017.12.4
- Phantom: SAM1; Type: SAM; Serial: TP-1488
- Measurement SW: DASY52, Version 52.8 (8); SEMCAD X Version 14.6.10 (7331)

Ch52/Area Scan (91x181x1): Interpolated grid: dx=1.000 mm, dy=1.000 mm
Maximum value of SAR (interpolated) = 1.57 W/kg

Ch52/Zoom Scan (7x7x7)/Cube 0: Measurement grid: dx=4mm, dy=4mm, dz=1.4mm
Reference Value = 15.83 V/m; Power Drift = 0.01 dB
Peak SAR (extrapolated) = 3.00 W/kg
SAR(1 g) = 0.781 W/kg; SAR(10 g) = 0.262 W/kg
Maximum value of SAR (measured) = 1.77 W/kg

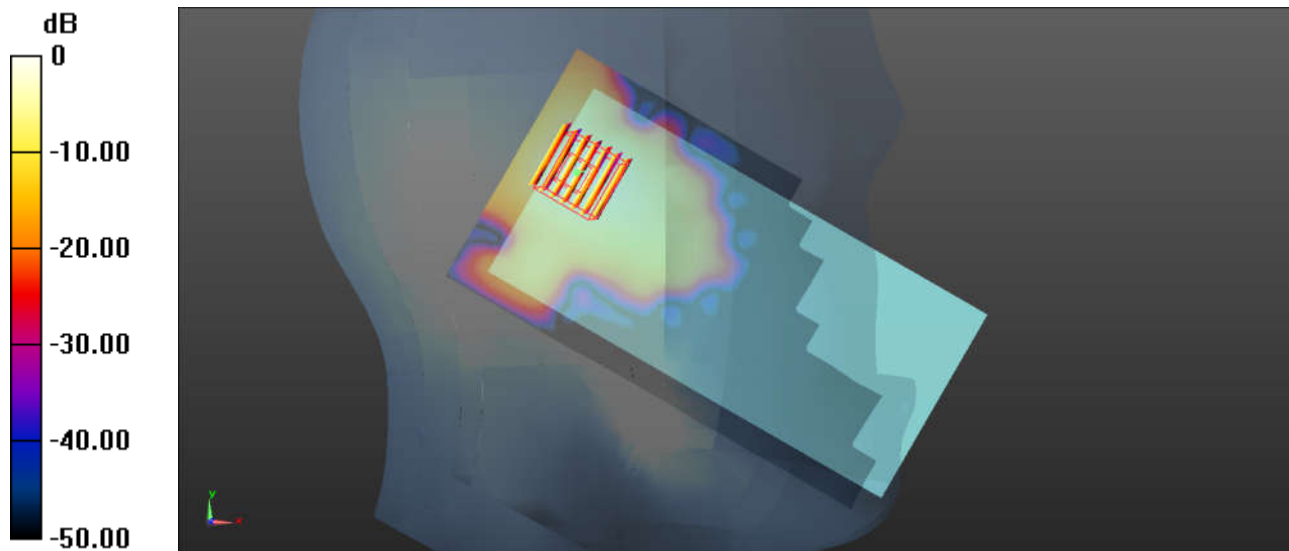

0 dB = 1.77 W/kg = 2.48 dBW/kg

02_WLAN5.5GHz_802.11a 6Mbps_Left Cheek_0mm_Ch124

Communication System: UID 0, WIFI (0); Frequency: 5620 MHz; Duty Cycle: 1:1.144
Medium: HSL_5000 Medium parameters used: $f = 5620$ MHz; $\sigma = 5.229$ S/m; $\epsilon_r = 36.562$;
 $\rho = 1000$ kg/m³
Ambient Temperature : 23.5 °C ; Liquid Temperature : 22.6 °C

DASY5 Configuration:

- Probe: EX3DV4 - SN3898; ConvF(5.03, 5.03, 5.03); Calibrated: 2017.6.27;
- Sensor-Surface: 1.4mm (Mechanical Surface Detection)
- Electronics: DAE4 Sn1338; Calibrated: 2017.12.4
- Phantom: SAM1; Type: SAM; Serial: TP-1488
- Measurement SW: DASY52, Version 52.8 (8); SEMCAD X Version 14.6.10 (7331)

Ch124/Area Scan (91x61x1): Interpolated grid: dx=1.000 mm, dy=1.000 mm
Maximum value of SAR (interpolated) = 2.14 W/kg

Ch124/Zoom Scan (7x7x7)/Cube 0: Measurement grid: dx=4mm, dy=4mm, dz=1.4mm
Reference Value = 12.82 V/m; Power Drift = 0.03 dB
Peak SAR (extrapolated) = 3.53 W/kg
SAR(1 g) = 0.686 W/kg; SAR(10 g) = 0.228 W/kg
Maximum value of SAR (measured) = 1.86 W/kg

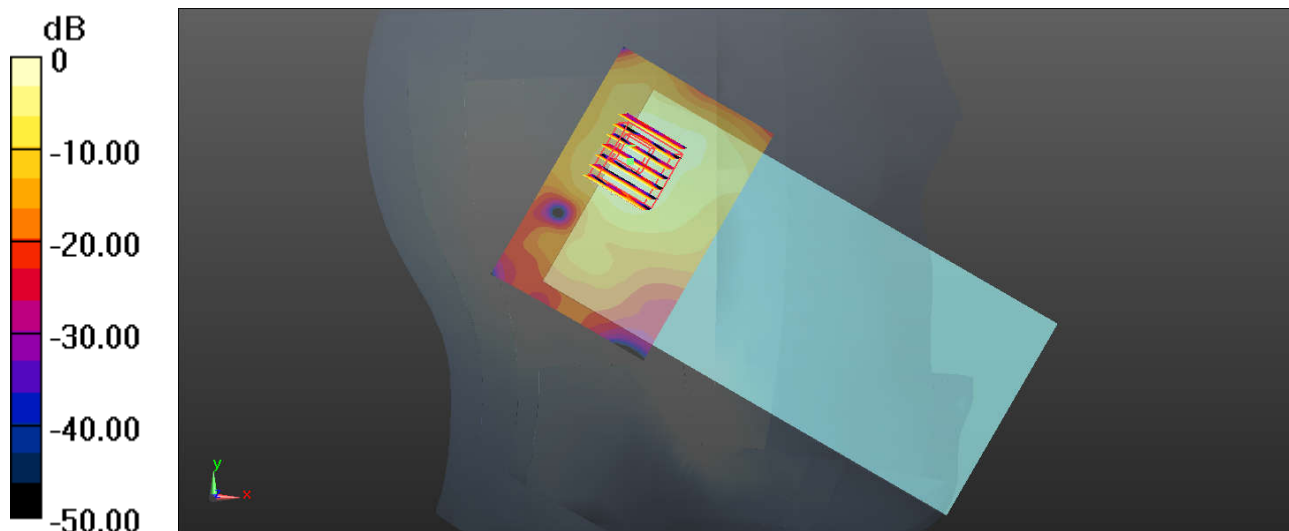

0 dB = 1.86 W/kg = 2.70 dBW/kg

03_WLAN5.8GHz_Band4 802.11a MCS0_Left Cheek_0mm_Ch157

Communication System: UID 0, WIFI (0); Frequency: 5785 MHz; Duty Cycle: 1:1.144
Medium: HSL_5000 Medium parameters used: $f = 5785$ MHz; $\sigma = 5.403$ S/m; $\epsilon_r = 36.334$;
 $\rho = 1000$ kg/m³
Ambient Temperature : 23.5 °C ; Liquid Temperature : 22.6 °C

DASY5 Configuration:

- Probe: EX3DV4 - SN3898; ConvF(5.18, 5.18, 5.18); Calibrated: 2017.6.27;
- Sensor-Surface: 1.4mm (Mechanical Surface Detection)
- Electronics: DAE4 Sn1338; Calibrated: 2017.12.4
- Phantom: SAM1; Type: SAM; Serial: TP-1488
- Measurement SW: DASY52, Version 52.8 (8); SEMCAD X Version 14.6.10 (7331)

Ch157/Area Scan (91x181x1): Interpolated grid: dx=1.000 mm, dy=1.000 mm
Maximum value of SAR (interpolated) = 1.31 W/kg

Ch157/Zoom Scan (7x7x7)/Cube 0: Measurement grid: dx=4mm, dy=4mm, dz=1.4mm
Reference Value = 10.49 V/m; Power Drift = 0.12 dB
Peak SAR (extrapolated) = 2.23 W/kg
SAR(1 g) = 0.459 W/kg; SAR(10 g) = 0.149 W/kg
Maximum value of SAR (measured) = 1.32 W/kg

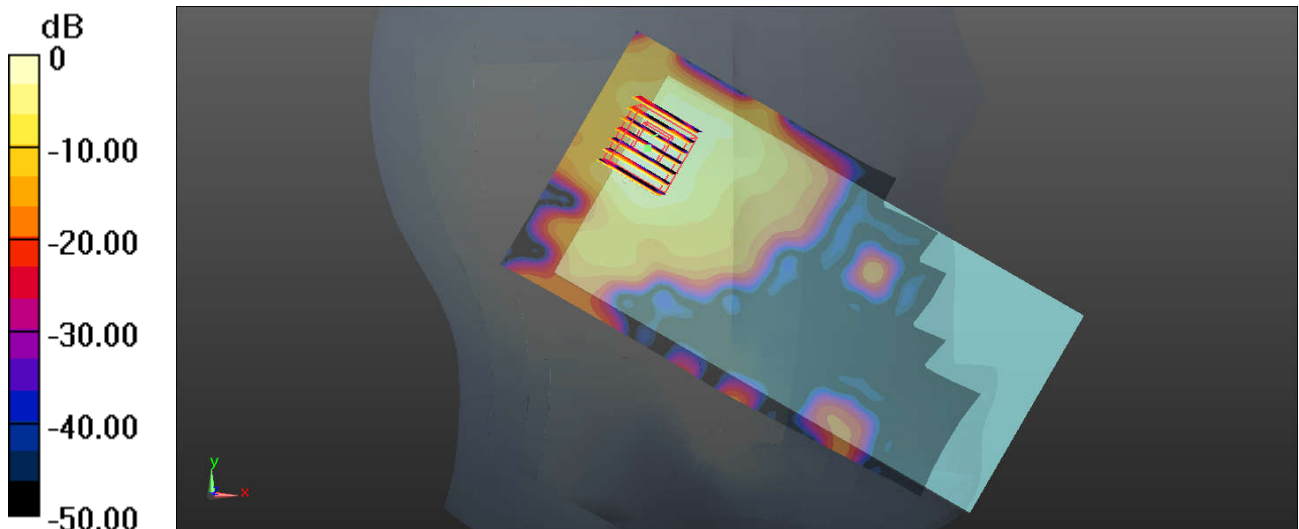

0 dB = 1.32 W/kg = 1.21 dBW/kg

04_WLAN5.2GHz_802.11a 6Mbps_Back_5mm_Ch44

Communication System: UID 0, WIFI (0); Frequency: 5220 MHz; Duty Cycle: 1:1.144
Medium: MSL_5000 Medium parameters used: $f = 5220$ MHz; $\sigma = 5.463$ S/m; $\epsilon_r = 48.007$; $\rho = 1000$ kg/m³
Ambient Temperature : 23.3 °C ; Liquid Temperature : 22.7 °C

DASY5 Configuration:

- Probe: EX3DV4 - SN3898; ConvF(5.13, 5.13, 5.13); Calibrated: 2017.6.27;
- Sensor-Surface: 1.4mm (Mechanical Surface Detection)
- Electronics: DAE4 Sn1338; Calibrated: 2017.12.4
- Phantom: SAM2; Type: SAM; Serial: TP-1489
- Measurement SW: DASY52, Version 52.8 (8); SEMCAD X Version 14.6.10 (7331)

Ch44/Area Scan (171x101x1): Interpolated grid: dx=1.000 mm, dy=1.000 mm
Maximum value of SAR (interpolated) = 1.46 W/kg

Ch44/Zoom Scan (7x7x7)/Cube 0: Measurement grid: dx=4mm, dy=4mm, dz=1.4mm
Reference Value = 0.3990 V/m; Power Drift = -0.07 dB
Peak SAR (extrapolated) = 3.51 W/kg
SAR(1 g) = 0.642 W/kg; SAR(10 g) = 0.172 W/kg
Maximum value of SAR (measured) = 1.92 W/kg

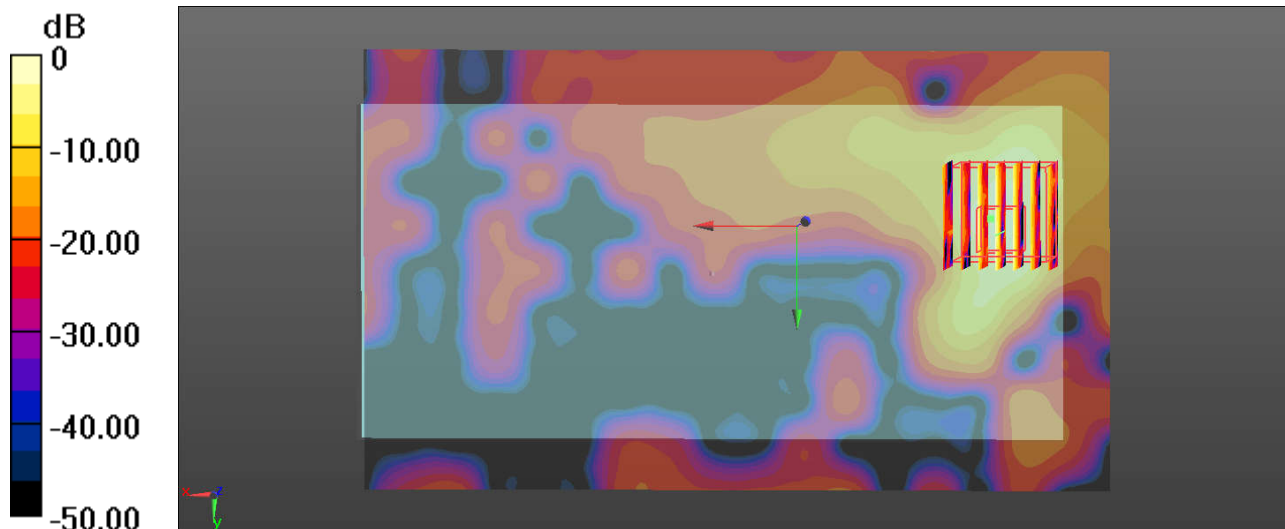

0 dB = 1.92 W/kg = 2.83 dBW/kg

05_WLAN5.8GHz_802.11a 6Mbps_Back_5mm_Ch157

Communication System: UID 0, WIFI (0); Frequency: 5785 MHz; Duty Cycle: 1:1.144
Medium: MSL_5000 Medium parameters used: $f = 5785$ MHz; $\sigma = 6.207$ S/m; $\epsilon_r = 47.068$;
 $\rho = 1000$ kg/m³
Ambient Temperature : 23.5 °C ; Liquid Temperature : 22.8 °C

DASY5 Configuration:

- Probe: EX3DV4 - SN3898; ConvF(4.5, 4.5, 4.5); Calibrated: 2017.6.27;
- Sensor-Surface: 1.4mm (Mechanical Surface Detection)
- Electronics: DAE4 Sn1338; Calibrated: 2017.12.4
- Phantom: SAM2; Type: SAM; Serial: TP-1489
- Measurement SW: DASY52, Version 52.8 (8); SEMCAD X Version 14.6.10 (7331)

Ch157/Area Scan (181x101x1): Interpolated grid: dx=1.000 mm, dy=1.000 mm
Maximum value of SAR (interpolated) = 1.50 W/kg

Ch157/Zoom Scan (7x7x7)/Cube 0: Measurement grid: dx=4mm, dy=4mm, dz=1.4mm

Reference Value = 0.7180 V/m; Power Drift = -0.09 dB

Peak SAR (extrapolated) = 2.68 W/kg

SAR(1 g) = 0.517 W/kg; SAR(10 g) = 0.138 W/kg

Maximum value of SAR (measured) = 1.51 W/kg

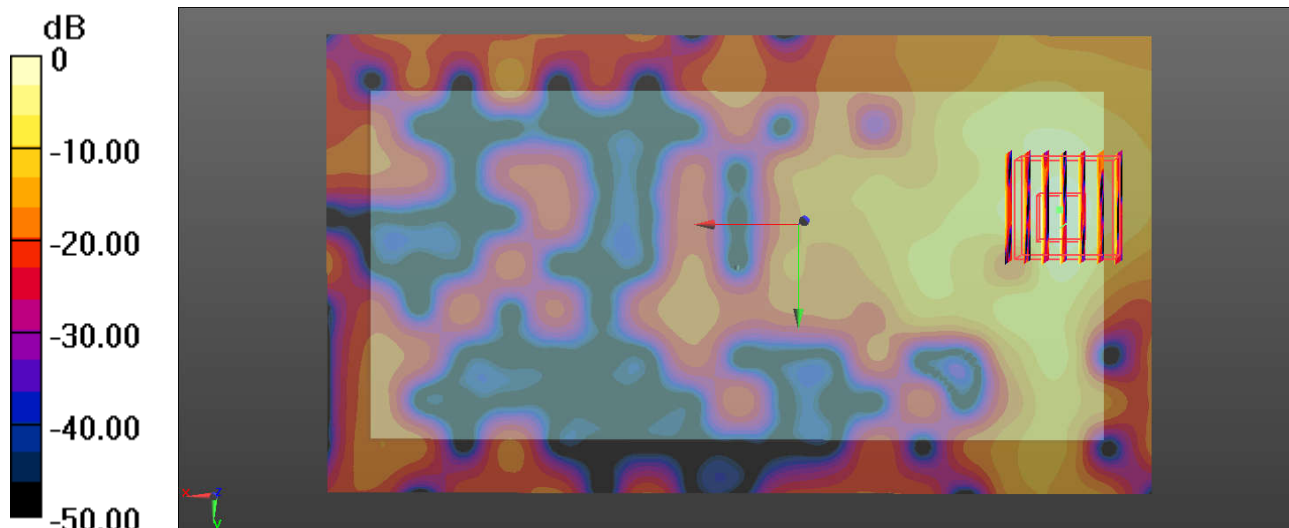

0 dB = 1.51 W/kg = 1.79 dBW/kg

06_WLAN5.3GHz_802.11a 6Mbps_Back_5mm_Ch52

Communication System: UID 0, WIFI (0); Frequency: 5260 MHz; Duty Cycle: 1:1.144
Medium: MSL_5000 Medium parameters used: $f = 5260$ MHz; $\sigma = 5.519$ S/m; $\epsilon_r = 47.949$;
 $\rho = 1000$ kg/m³
Ambient Temperature : 23.3 °C ; Liquid Temperature : 22.7 °C

DASY5 Configuration:

- Probe: EX3DV4 - SN3898; ConvF(5.13, 5.13, 5.13); Calibrated: 2017.6.27;
- Sensor-Surface: 1.4mm (Mechanical Surface Detection)
- Electronics: DAE4 Sn1338; Calibrated: 2017.12.4
- Phantom: SAM2; Type: SAM; Serial: TP-1489
- Measurement SW: DASY52, Version 52.8 (8); SEMCAD X Version 14.6.10 (7331)

Ch52/Area Scan (171x101x1): Interpolated grid: dx=1.000 mm, dy=1.000 mm
Maximum value of SAR (interpolated) = 1.49 W/kg

Ch52/Zoom Scan (7x7x7)/Cube 0: Measurement grid: dx=4mm, dy=4mm, dz=1.4mm
Reference Value = 0.4010 V/m; Power Drift = -0.01 dB
Peak SAR (extrapolated) = 3.60 W/kg
SAR(1 g) = 0.657 W/kg; SAR(10 g) = 0.176 W/kg
Maximum value of SAR (measured) = 1.97 W/kg

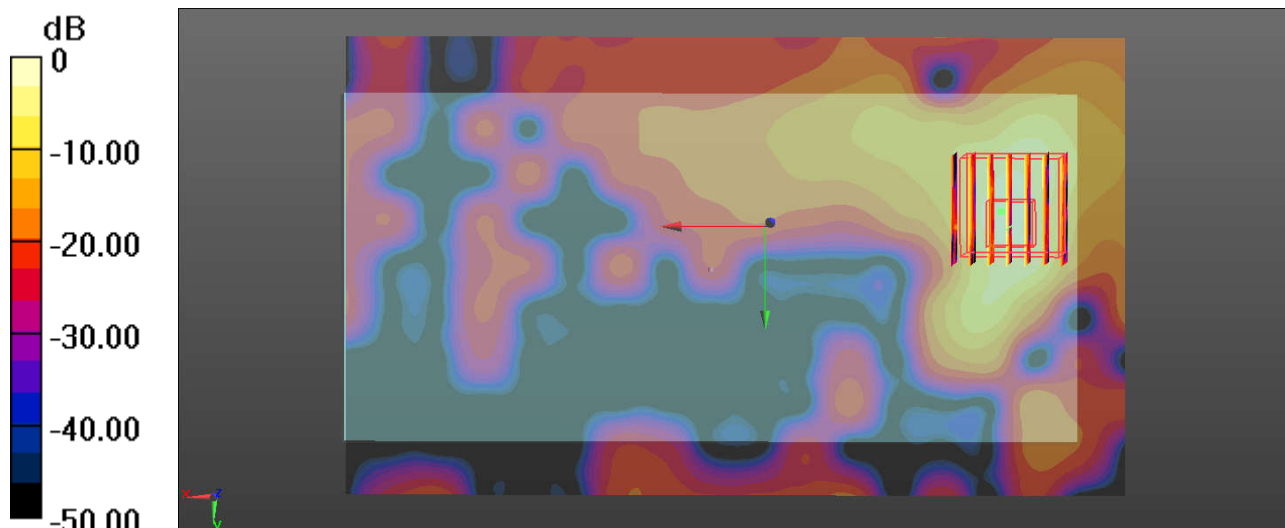

0 dB = 1.97 W/kg = 2.94 dBW/kg

07_WLAN5.5GHz_802.11a 6Mbps_Back_5mm_Ch124

Communication System: UID 0, WIFI (0); Frequency: 5620 MHz; Duty Cycle: 1:1.144
Medium: MSL_5000 Medium parameters used: $f = 5620$ MHz; $\sigma = 5.986$ S/m; $\epsilon_r = 47.334$;
 $\rho = 1000$ kg/m³
Ambient Temperature : 23.5 °C ; Liquid Temperature : 22.7 °C

DASY5 Configuration:

- Probe: EX3DV4 - SN3898; ConvF(4.14, 4.14, 4.14); Calibrated: 2017.6.27;
- Sensor-Surface: 1.4mm (Mechanical Surface Detection)
- Electronics: DAE4 Sn1338; Calibrated: 2017.12.4
- Phantom: SAM2; Type: SAM; Serial: TP-1489
- Measurement SW: DASY52, Version 52.8 (8); SEMCAD X Version 14.6.10 (7331)

Ch124/Area Scan (171x101x1): Interpolated grid: dx=1.000 mm, dy=1.000 mm
Maximum value of SAR (interpolated) = 1.17 W/kg

Ch124/Zoom Scan (7x7x7)/Cube 0: Measurement grid: dx=4mm, dy=4mm, dz=1.4mm
Reference Value = 0.8450 V/m; Power Drift = -0.09 dB
Peak SAR (extrapolated) = 2.01 W/kg
SAR(1 g) = 0.403 W/kg; SAR(10 g) = 0.111 W/kg
Maximum value of SAR (measured) = 1.14 W/kg

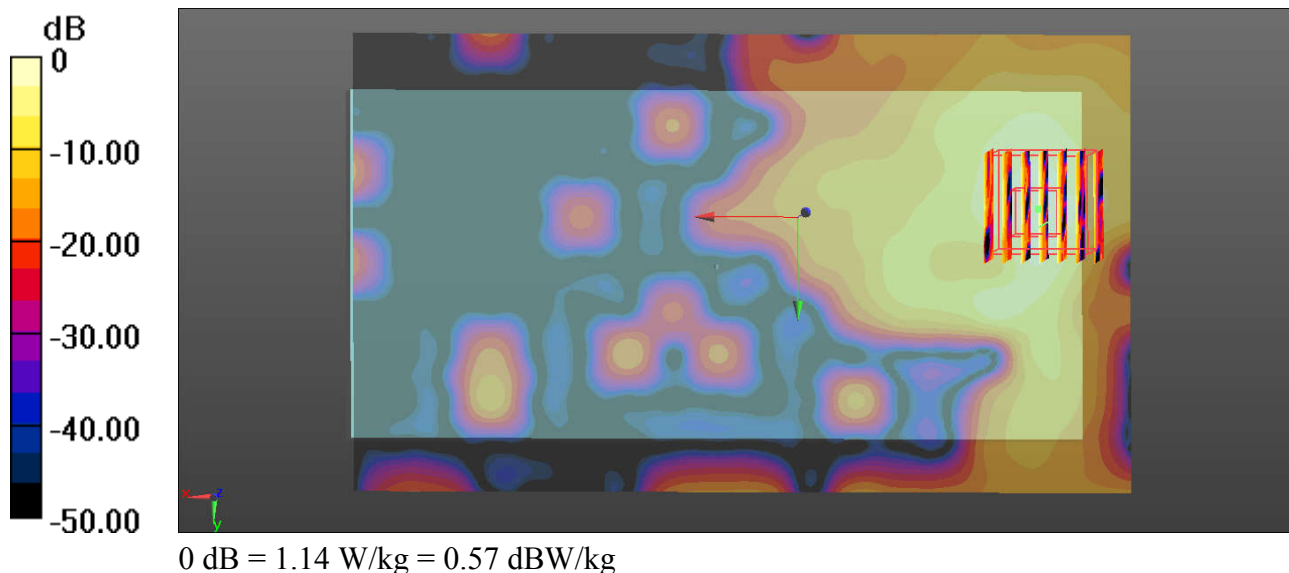

08_WLAN5.8GHz_802.11a 6Mbps_Back_5mm_Ch157

Communication System: UID 0, WIFI (0); Frequency: 5785 MHz; Duty Cycle: 1:1.144
Medium: MSL_5000 Medium parameters used: $f = 5785$ MHz; $\sigma = 6.207$ S/m; $\epsilon_r = 47.068$;
 $\rho = 1000$ kg/m³
Ambient Temperature : 23.5 °C ; Liquid Temperature : 22.8 °C

DASY5 Configuration:

- Probe: EX3DV4 - SN3898; ConvF(4.5, 4.5, 4.5); Calibrated: 2017.6.27;
- Sensor-Surface: 1.4mm (Mechanical Surface Detection)
- Electronics: DAE4 Sn1338; Calibrated: 2017.12.4
- Phantom: SAM2; Type: SAM; Serial: TP-1489
- Measurement SW: DASY52, Version 52.8 (8); SEMCAD X Version 14.6.10 (7331)

Ch157/Area Scan (181x101x1): Interpolated grid: dx=1.000 mm, dy=1.000 mm
Maximum value of SAR (interpolated) = 1.50 W/kg

Ch157/Zoom Scan (7x7x7)/Cube 0: Measurement grid: dx=4mm, dy=4mm, dz=1.4mm

Reference Value = 0.7180 V/m; Power Drift = -0.09 dB

Peak SAR (extrapolated) = 2.68 W/kg

SAR(1 g) = 0.517 W/kg; SAR(10 g) = 0.138 W/kg

Maximum value of SAR (measured) = 1.51 W/kg

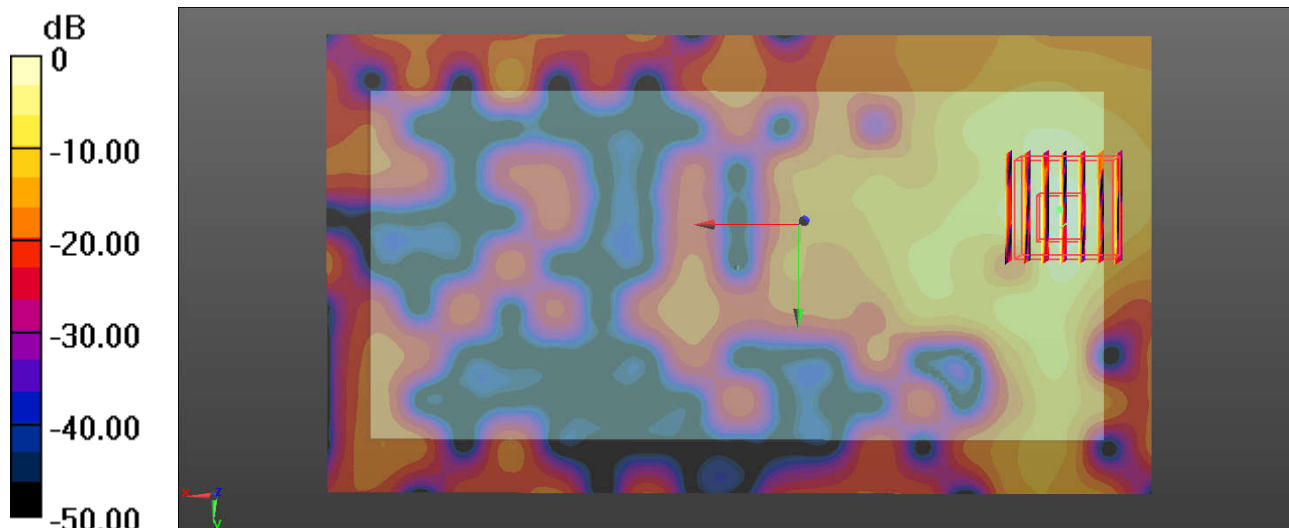

0 dB = 1.51 W/kg = 1.79 dBW/kg

09_WLAN5.3GHz_802.11a 6Mbps_Back_0mm_Ch52

Communication System: UID 0, WIFI (0); Frequency: 5260 MHz; Duty Cycle: 1:1.144
 Medium: MSL_5000 Medium parameters used: $f = 5260$ MHz; $\sigma = 5.519$ S/m; $\epsilon_r = 47.949$;
 $\rho = 1000$ kg/m³
 Ambient Temperature : 23.3 °C ; Liquid Temperature : 22.7 °C

DASY5 Configuration:

- Probe: EX3DV4 - SN3898; ConvF(5.13, 5.13, 5.13); Calibrated: 2017.6.27;
- Sensor-Surface: 1.4mm (Mechanical Surface Detection)
- Electronics: DAE4 Sn1338; Calibrated: 2017.12.4
- Phantom: SAM2; Type: SAM; Serial: TP-1489
- Measurement SW: DASY52, Version 52.8 (8); SEMCAD X Version 14.6.10 (7331)

Ch52/Area Scan (91x181x1): Interpolated grid: dx=1.000 mm, dy=1.000 mm
 Maximum value of SAR (interpolated) = 3.48 W/kg

Ch52/Zoom Scan (7x7x7)/Cube 0: Measurement grid: dx=4mm, dy=4mm, dz=1.4mm
 Reference Value = 0 V/m; Power Drift = 0.01 dB
 Peak SAR (extrapolated) = 14.1 W/kg
SAR(1 g) = 1.92 W/kg; SAR(10 g) = 0.415 W/kg
 Maximum value of SAR (measured) = 6.23 W/kg

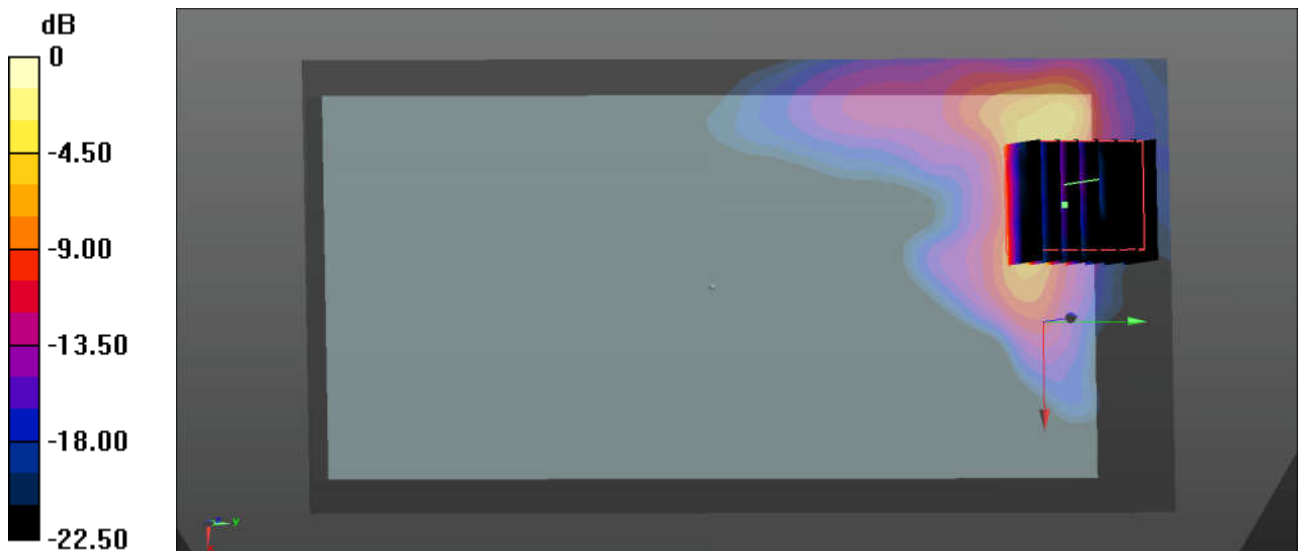

0 dB = 6.23 W/kg = 7.94 dBW/kg

10_WLAN5.5GHz_802.11a 6Mbps_Back_0mm_Ch124

Communication System: UID 0, WIFI (0); Frequency: 5620 MHz; Duty Cycle: 1:1.144
 Medium: MSL_5000 Medium parameters used: $f = 5620$ MHz; $\sigma = 5.229$ S/m; $\epsilon_r = 36.562$;
 $\rho = 1000$ kg/m³
 Ambient Temperature : 23.5 °C ; Liquid Temperature : 22.7 °C

DASY5 Configuration:

- Probe: EX3DV4 - SN3898; ConvF(4.14, 4.14, 4.14); Calibrated: 2017.6.27;
- Sensor-Surface: 1.4mm (Mechanical Surface Detection)
- Electronics: DAE4 Sn1338; Calibrated: 2017.12.4
- Phantom: SAM2; Type: SAM; Serial: TP-1489
- Measurement SW: DASY52, Version 52.8 (8); SEMCAD X Version 14.6.10 (7331)

Ch124/Area Scan (91x181x1): Interpolated grid: dx=1.000 mm, dy=1.000 mm
 Maximum value of SAR (interpolated) = 1.42 W/kg

Ch124/Zoom Scan (7x7x7)/Cube 0: Measurement grid: dx=4mm, dy=4mm, dz=1.4mm
 Reference Value = 0 V/m; Power Drift = 0.09 dB
 Peak SAR (extrapolated) = 2.67 W/kg
SAR(1 g) = 0.719 W/kg; SAR(10 g) = 0.240 W/kg
 Maximum value of SAR (measured) = 1.48 W/kg

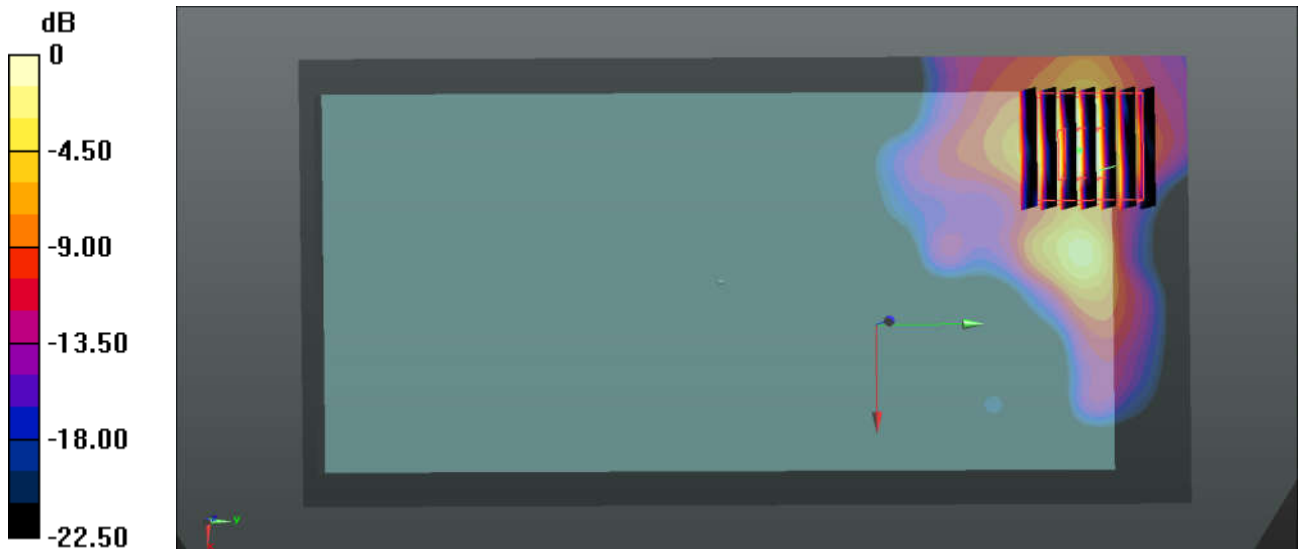

0 dB = 1.48 W/kg = 1.70 dBW/kg



Appendix C. DAS Y Calibration Certificate

The DAS Y calibration certificates are shown as follows.



Accredited by the Swiss Accreditation Service (SAS)
The Swiss Accreditation Service is one of the signatories to the EA
Multilateral Agreement for the recognition of calibration certificates

Accreditation No.: **SCS 0108**

Client **Sporton (Auden)**

Certificate No: **D5GHzV2-1167_Jul17**

CALIBRATION CERTIFICATE

Object **D5GHzV2 - SN:1167**

Calibration procedure(s) **QA CAL-22.v2
Calibration procedure for dipole validation kits between 3-6 GHz**

Calibration date: **July 26, 2017**

This calibration certificate documents the traceability to national standards, which realize the physical units of measurements (SI).
The measurements and the uncertainties with confidence probability are given on the following pages and are part of the certificate.

All calibrations have been conducted in the closed laboratory facility: environment temperature (22 ± 3)°C and humidity < 70%.

Calibration Equipment used (M&TE critical for calibration)

Primary Standards	ID #	Cal Date (Certificate No.)	Scheduled Calibration
Power meter NRP	SN: 104778	04-Apr-17 (No. 217-02521/02522)	Apr-18
Power sensor NRP-Z91	SN: 103244	04-Apr-17 (No. 217-02521)	Apr-18
Power sensor NRP-Z91	SN: 103245	04-Apr-17 (No. 217-02522)	Apr-18
Reference 20 dB Attenuator	SN: 5058 (20k)	07-Apr-17 (No. 217-02528)	Apr-18
Type-N mismatch combination	SN: 5047.2 / 06327	07-Apr-17 (No. 217-02529)	Apr-18
Reference Probe EX3DV4	SN: 3503	31-Dec-16 (No. EX3-3503_Dec16)	Dec-17
DAE4	SN: 601	28-Mar-17 (No. DAE4-601_Mar17)	Mar-18

Secondary Standards	ID #	Check Date (in house)	Scheduled Check
Power meter EPM-442A	SN: GB37480704	07-Oct-15 (in house check Oct-16)	In house check: Oct-18
Power sensor HP 8481A	SN: US37292783	07-Oct-15 (in house check Oct-16)	In house check: Oct-18
Power sensor HP 8481A	SN: MY41092317	07-Oct-15 (in house check Oct-16)	In house check: Oct-18
RIF generator R&S SMT-06	SN: 100972	15-Jun-15 (in house check Oct-16)	In house check: Oct-18
Network Analyzer HP 8753E	SN: US37390585	18-Oct-01 (in house check Oct-16)	In house check: Oct-17

Calibrated by: **Johannes Kurikka** Laboratory Technician

Approved by: **Katja Pokovic** Technical Manager

Issued: July 27, 2017

This calibration certificate shall not be reproduced except in full without written approval of the laboratory.



Accredited by the Swiss Accreditation Service (SAS)
The Swiss Accreditation Service is one of the signatories to the EA
Multilateral Agreement for the recognition of calibration certificates

Accreditation No.: SCS 0108

Glossary:

TSL	tissue simulating liquid
ConvF	sensitivity in TSL / NORM x,y,z
N/A	not applicable or not measured

Calibration is Performed According to the Following Standards:

- IEEE Std 1528-2013, "IEEE Recommended Practice for Determining the Peak Spatial-Averaged Specific Absorption Rate (SAR) in the Human Head from Wireless Communications Devices: Measurement Techniques", June 2013
- IEC 62209-1, "Measurement procedure for the assessment of Specific Absorption Rate (SAR) from hand-held and body-mounted devices used next to the ear (frequency range of 300 MHz to 6 GHz)", July 2016
- IEC 62209-2, "Procedure to determine the Specific Absorption Rate (SAR) for wireless communication devices used in close proximity to the human body (frequency range of 30 MHz to 6 GHz)", March 2010
- KDB 865664, "SAR Measurement Requirements for 100 MHz to 6 GHz"

Additional Documentation:

- DASY4/5 System Handbook

Methods Applied and Interpretation of Parameters:

- Measurement Conditions:** Further details are available from the Validation Report at the end of the certificate. All figures stated in the certificate are valid at the frequency indicated.
- Antenna Parameters with TSL:** The dipole is mounted with the spacer to position its feed point exactly below the center marking of the flat phantom section, with the arms oriented parallel to the body axis.
- Feed Point Impedance and Return Loss:** These parameters are measured with the dipole positioned under the liquid filled phantom. The impedance stated is transformed from the measurement at the SMA connector to the feed point. The Return Loss ensures low reflected power. No uncertainty required.
- Electrical Delay:** One-way delay between the SMA connector and the antenna feed point. No uncertainty required.
- SAR measured:** SAR measured at the stated antenna input power.
- SAR normalized:** SAR as measured, normalized to an input power of 1 W at the antenna connector.
- SAR for nominal TSL parameters:** The measured TSL parameters are used to calculate the nominal SAR result.

The reported uncertainty of measurement is stated as the standard uncertainty of measurement multiplied by the coverage factor $k=2$, which for a normal distribution corresponds to a coverage probability of approximately 95%.