



FCC RF Test Report

APPLICANT : Motorola Mobility LLC
EQUIPMENT : Mobile Cellular Phone
BRAND NAME : Motorola
MODEL NAME : XT1925-6, XT1925-12, XT1925DL
FCC ID : IHDT56XD1
STANDARD : FCC 47 CFR Part 2, 22(H), 24(E), 27(L)
CLASSIFICATION : PCS Licensed Transmitter Held to Ear (PCE)

The product was received on Dec. 25, 2017 and testing was completed on Jan. 14, 2018. We, Sporton International (Kunshan) Inc., would like to declare that the tested sample has been evaluated in accordance with the test procedures given in ANSI/TIA-603-E and has been in compliance with the applicable technical standards.

The test results in this report apply exclusively to the tested model / sample. Without written approval of Sporton International (Kunshan) Inc., the test report shall not be reproduced except in full.



Approved by: James Huang / Manager

Sporton International (Kunshan) Inc.

**No.3-2 Ping-Xiang Rd, Kunshan Development Zone Kunshan City Jiangsu Province 215335
China**



TABLE OF CONTENTS

REVISION HISTORY..... 3

SUMMARY OF TEST RESULT 4

1 GENERAL DESCRIPTION 5

 1.1 Applicant..... 5

 1.2 Manufacturer 5

 1.3 Product Feature of Equipment Under Test 5

 1.4 Product Specification of Equipment Under Test 6

 1.5 Specification of Accessory 7

 1.6 Modification of EUT 8

 1.7 Maximum ERP/EIRP Power, Frequency Tolerance, and Emission Designator 8

 1.8 Testing Location 8

 1.9 Applicable Standards 9

2 TEST CONFIGURATION OF EQUIPMENT UNDER TEST 10

 2.1 Test Mode..... 10

 2.2 Connection Diagram of Test System 11

 2.3 Support Unit used in test configuration 12

 2.4 Measurement Results Explanation Example 12

3 CONDUCTED TEST RESULT..... 13

 3.1 Measuring Instruments..... 13

 3.2 Test Setup 13

 3.3 Test Result of Conducted Test..... 13

 3.4 Conducted Output Power and ERP/EIRP 14

 3.5 Peak-to-Average Ratio 15

 3.6 99% Occupied Bandwidth and 26dB Bandwidth Measurement..... 16

 3.7 Conducted Band Edge 17

 3.8 Conducted Spurious Emission 18

 3.9 Frequency Stability..... 19

4 RADIATED TEST ITEMS 20

 4.1 Measuring Instruments..... 20

 4.2 Test Setup 20

 4.3 Test Result of Radiated Test..... 20

 4.4 Field Strength of Spurious Radiation Measurement 21

5 LIST OF MEASURING EQUIPMENT 22

6 UNCERTAINTY OF EVALUATION 23

APPENDIX A. TEST RESULTS OF CONDUCTED TEST

APPENDIX B. TEST RESULTS OF RADIATED TEST

APPENDIX C. TEST SETUP PHOTOGRAPHS



REVISION HISTORY

| REPORT NO. | VERSION | DESCRIPTION | ISSUED DATE |
|------------|---------|-------------------------|---------------|
| FG7D2507A | Rev. 01 | Initial issue of report | Jan. 30, 2018 |
| | | | |
| | | | |
| | | | |
| | | | |
| | | | |
| | | | |
| | | | |
| | | | |
| | | | |
| | | | |
| | | | |
| | | | |
| | | | |
| | | | |
| | | | |
| | | | |
| | | | |
| | | | |
| | | | |



SUMMARY OF TEST RESULT

| Report Section | FCC Rule | Description | Limit | Result | Remark |
|----------------|--|---|------------------------|--------|------------------------------------|
| 3.4 | §2.1046 | Conducted Output Power | Reporting Only | PASS | - |
| | §22.913(a)(2) | Effective Radiated Power | < 7 Watts | PASS | - |
| | §24.232(c) | Equivalent Isotropic Radiated Power | < 2 Watts | PASS | - |
| | §27.50(d)(4) | Equivalent Isotropic Radiated Power | < 1 Watts | PASS | - |
| 3.5 | §24.232(d) | Peak-to-Average Ratio | < 13 dB | PASS | - |
| 3.6 | §2.1049 §22.917(b) §24.238(b) §27.53(g) | Occupied Bandwidth | Reporting Only | PASS | - |
| 3.7 | §2.1051 §22.917(a) §24.238(a) §27.53(h) | Band Edge Measurement | < 43+10log10(P[Watts]) | PASS | - |
| 3.8 | §2.1051 §22.917(a) §24.238(a) §27.53(h) | Conducted Emission | < 43+10log10(P[Watts]) | PASS | - |
| 3.9 | §2.1055 §22.355 | Frequency Stability for Temperature & Voltage | < 2.5 ppm for Part 22H | PASS | - |
| | §2.1055 §24.235 §27.54 | | Within Authorized Band | | |
| 4.4 | §2.1053 §22.917(a) §24.238(a) §27.53(h) | Field Strength of Spurious Radiation | < 43+10log10(P[Watts]) | PASS | Under limit 5.74 dB at 2546.00 MHz |



1 General Description

1.1 Applicant

Motorola Mobility LLC
222 W, Merchandise Mart Plaza, Chicago IL 60654 USA

1.2 Manufacturer

Motorola Mobility LLC
222 W, Merchandise Mart Plaza, Chicago IL 60654 USA

1.3 Product Feature of Equipment Under Test

| Product Feature | |
|---------------------------------|---|
| Equipment | Mobile Cellular Phone |
| Brand Name | Motorola |
| Model Name | XT1925-6, XT1925-12, XT1925DL |
| FCC ID | IHDT56XD1 |
| EUT supports Radios application | CDMA/EVDO/GSM/GPRS/EGPRS/WCDMA/HSPA/ DC-HSDPA/HSPA+(Uplink is not supported)/LTE/ WLAN 2.4GHz 802.11b/g/n HT20/ WLAN 5GHz 802.11a/n HT20/HT40 Bluetooth v3.0 + EDR / Bluetooth v4.0 LE Bluetooth v4.1 LE / Bluetooth v4.2 LE |
| IMEI Code | Conducted: 351849090020632 Radiation: 351884090035585 for 22H 351849090019634 for 24E/27L |
| MEID Code | Radiation: 351884090003585 for CDMA |
| HW Version | DVT1-B |
| SW Version | ali_n-userdebug 8.0.0 OPS27.55 1276 intcfg,test-keys |
| EUT Stage | Identical Prototype |

Remark: The above EUT's information was declared by manufacturer. Please refer to the specifications or user's manual for more detailed description.



1.4 Product Specification of Equipment Under Test

| Standards-related Product Specification | |
|---|---|
| Tx Frequency | <p>GSM/GPRS/EDGE: 850: 824.2 MHz ~ 848.8 MHz 1900: 1850.2 MHz ~ 1909.8MHz</p> <p>WCDMA: Band V: 826.4 MHz ~ 846.6 MHz Band II: 1852.4 MHz ~ 1907.6 MHz Band IV: 1712.4 MHz ~ 1752.6 MHz</p> <p>CDMA2000: BC0: 824.70 MHz ~ 848.31 MHz BC1: 1851.25 MHz ~ 1908.75 MHz</p> |
| Rx Frequency | <p>GSM/GPRS/EDGE: 850: 869.2 MHz ~ 893.8 MHz 1900: 1930.2 MHz ~ 1989.8 MHz</p> <p>WCDMA: Band V: 871.4 MHz ~ 891.6 MHz Band II: 1932.4 MHz ~ 1987.6 MHz Band IV: 2112.4 MHz ~ 2152.6 MHz</p> <p>CDMA2000: BC0: 869.70 MHz ~ 893.31 MHz BC1: 1931.25 MHz ~ 1988.75 MHz</p> |
| Maximum Output Power | <p>GSM/GPRS/EDGE: 850: 33.09 dBm 1900: 29.91 dBm</p> <p>WCDMA: Band V: 22.52 dBm Band II: 22.56 dBm Band IV: 22.51 dBm</p> <p>CDMA2000: BC0: 24.13 dBm BC1: 23.55 dBm</p> |
| Antenna Type | Fixed Internal PIFA Antenna |
| Antenna Gain | Cellular Band: -1.49 dBi PCS Band: -0.23 dBi AWS Band: 0.64 dBi |
| Type of Modulation | GSM: GMSK GPRS: GMSK EDGE: GMSK / 8PSK WCDMA : BPSK (Uplink) HSDPA/DC-HSDPA : QPSK (Uplink) HSUPA : QPSK (Uplink) HSPA+ : 16QAM (Uplink is not supported) DC-HSDPA : 64QAM CDMA2000 1xRTT: QPSK CDMA2000 1xEV-DO: QPSK/8PSK |



1.5 Specification of Accessory

| Specification of Accessory | | | |
|----------------------------|------------------|--|--------------------------------|
| AC Adapter 1(US) | Brand Name | Motorola (Salom) | Model Name SC-22 |
| | Power Rating | I/P: 100-240 Vac, 500mA, O/P: 5Vdc,3000mA or 9Vdc,1600mA or 12Vdc,1200mA | |
| AC Adapter 1(EU) | Brand Name | Motorola (Salom) | Model Name SC-23 |
| | Power Rating | I/P: 100-240 Vac, 500mA, O/P: 5Vdc,3000mA or 9Vdc,1600mA or 12Vdc,1200mA | |
| AC Adapter 1(UK) | Brand Name | Motorola (Salom) | Model Name SC-24 |
| | Power Rating | I/P: 100-240 Vac, 500mA, O/P: 5Vdc,3000mA or 9Vdc,1600mA or 12Vdc,1200mA | |
| AC Adapter 1(IN) | Brand Name | Motorola (Salom) | Model Name SC-25 |
| | Power Rating | I/P: 100-240 Vac, 500mA, O/P: 5Vdc,3000mA or 9Vdc,1600mA or 12Vdc,1200mA | |
| AC Adapter 1(AU) | Brand Name | Motorola (Salom) | Model Name SC-26 |
| | Power Rating | I/P: 100-240 Vac, 500mA, O/P: 5Vdc,3000mA or 9Vdc,1600mA or 12Vdc,1200mA | |
| AC Adapter 2(US) | Brand Name | Motorola (Chenyang) | Model Name SC-22 |
| | Power Rating | I/P: 100-240 Vac, 500mA, O/P: 5Vdc,3000mA or 9Vdc,1600mA or 12Vdc,1200mA | |
| AC Adapter 2(EU) | Brand Name | Motorola (Chenyang) | Model Name SC-23 |
| | Power Rating | I/P: 100-240 Vac, 500mA, O/P: 5Vdc,3000mA or 9Vdc,1600mA or 12Vdc,1200mA | |
| AC Adapter 2(UK) | Brand Name | Motorola (Chenyang) | Model Name SC-24 |
| | Power Rating | I/P: 100-240 Vac, 500mA, O/P: 5Vdc,3000mA or 9Vdc,1600mA or 12Vdc,1200mA | |
| AC Adapter 2(IN) | Brand Name | Motorola (Chenyang) | Model Name SC-25 |
| | Power Rating | I/P: 100-240 Vac, 500mA, O/P: 5Vdc,3000mA or 9Vdc,1600mA or 12Vdc,1200mA | |
| AC Adapter 2(AU) | Brand Name | Motorola (Chenyang) | Model Name SC-26 |
| | Power Rating | I/P: 100-240 Vac, 500mA, O/P: 5Vdc,3000mA or 9Vdc,1600mA or 12Vdc,1200mA | |
| Battery | Brand Name | Motorola (ATL) | Model Name HG30 |
| | Power Rating | 3.8Vdc,3000mAh | Type Li-ion |
| Earphone 1 | Brand Name | Motorola (Jiahe) | Model Name LS-118M-12 |
| | Signal Line Type | 1.2 meter, non-shielded cable, without ferrite core | |
| Earphone 2 | Brand Name | Motorola (Lianyun) | Model Name TS910A-38AMS01WHR-M |
| | Signal Line Type | 1.2 meter, non-shielded cable, without ferrite core | |
| USB Cable | Brand Name | Motorola (Liqi) | Model Name L32B-053000100-ALL |
| | Signal Line Type | 1.0 meter, shielded cable, without ferrite core | |



1.6 Modification of EUT

No modifications are made to the EUT during all test items.

1.7 Maximum ERP/EIRP Power, Frequency Tolerance, and Emission Designator

| FCC Rule | System | Type of Modulation | Maximum ERP/EIRP (W) | Frequency Tolerance (ppm) | Emission Designator |
|----------|----------------------------|--------------------|----------------------|---------------------------|---------------------|
| Part 22H | GSM850 GSM | GMSK | 0.8810 | 0.0407 ppm | 243KGXW |
| Part 22H | GSM850 EDGE class 8 | 8PSK | 0.2075 | 0.0335 ppm | 246KG7W |
| Part 22H | CDMA2000 BC0 1xRTT | QPSK | 0.1119 | 0.0251 ppm | 1M28F9W |
| Part 22H | WCDMA Band V RMC 12.2Kbps | BPSK | 0.0773 | 0.0514 ppm | 4M13F9W |
| Part 24E | GSM1900 GSM | GMSK | 0.9290 | 0.0176 ppm | 243KGXW |
| Part 24E | GSM1900 EDGE class 8 | 8PSK | 0.3524 | 0.0186 ppm | 246KG7W |
| Part 24E | CDMA2000 BC1 1xRTT | QPSK | 0.2148 | 0.0133 ppm | 1M27F9W |
| Part 24E | WCDMA Band II RMC 12.2Kbps | BPSK | 0.1710 | 0.0112 ppm | 4M15F9W |
| Part 27L | WCDMA Band IV RMC 12.2Kbps | BPSK | 0.2065 | 0.0144 ppm | 4M13F9W |

1.8 Testing Location

Sporton International (Kunshan) Inc. is accredited to ISO 17025 by National Voluntary Laboratory Accreditation Program (NVLAP code: 600155-0) and the FCC designation No. is CN5013.

| | | | |
|---------------------------|---|-----------|---------------------------------------|
| Test Site | Sporton International (Kunshan) Inc. | | |
| Test Site Location | No.3-2 Ping-Xiang Rd, Kunshan Development Zone Kunshan City Jiangsu Province 215335 China TEL : +86-512-57900158 FAX : +86-512-57900958 | | |
| Test Site No. | Sporton Site No. | | FCC Test Firm Registration No. |
| | TH01-KS | 03CH03-KS | 630927 |

Note: The test site complies with ANSI C63.4 2014 requirement.



1.9 Applicable Standards

According to the specifications of the manufacturer, the EUT must comply with the requirements of the following standards:

- ♦ 47 CFR Part 2, 22(H), 24(E), 27(L)
- ♦ ANSI/TIA-603-E
- ♦ FCC KDB 971168 D01 Power Meas. License Digital Systems v03
- ♦ FCC KDB 412172 D01 Determining ERP and EIRP v01r01

Remark:

1. All test items were verified and recorded according to the standards and without any deviation during the test.
2. This EUT has also been tested and complied with the requirements of FCC Part 15, Subpart B, recorded in a separate test report.



2 Test Configuration of Equipment Under Test

2.1 Test Mode

Antenna port conducted and radiated test items were performed according to KDB 971168 D01 Power Meas. License Digital Systems v03 with maximum output power.

Radiated measurements were performed with rotating EUT in different three orthogonal test planes to find the maximum emission.

Radiated emissions were investigated as following frequency range:

1. 30 MHz to 10th harmonic for GSM850 and CDMA BC0 and WCDMA Band V.
2. 30 MHz to 10th harmonic for WCDMA Band IV.
3. 30 MHz to 10th harmonic for GSM1900 and CDMA BC1 and WCDMA Band II.

All modes and data rates and positions were investigated.

Test modes are chosen to be reported as the worst case configuration below:

| Test Modes | | |
|---------------|---|---|
| Band | Radiated TCs | Conducted TCs |
| GSM 850 | <ul style="list-style-type: none"> ■ GSM Link ■ EDGE class 8 Link | <ul style="list-style-type: none"> ■ GSM Link ■ EDGE class 8 Link |
| GSM 1900 | <ul style="list-style-type: none"> ■ GSM Link ■ EDGE class 8 Link | <ul style="list-style-type: none"> ■ GSM Link ■ EDGE class 8 Link |
| CDMA BC0 | <ul style="list-style-type: none"> ■ 1xRTT Link | <ul style="list-style-type: none"> ■ 1xRTT Link |
| CDMA BC1 | <ul style="list-style-type: none"> ■ 1xRTT Link | <ul style="list-style-type: none"> ■ 1xRTT Link |
| WCDMA Band V | <ul style="list-style-type: none"> ■ RMC 12.2Kbps Link | <ul style="list-style-type: none"> ■ RMC 12.2Kbps Link |
| WCDMA Band II | <ul style="list-style-type: none"> ■ RMC 12.2Kbps Link | <ul style="list-style-type: none"> ■ RMC 12.2Kbps Link |
| WCDMA Band IV | <ul style="list-style-type: none"> ■ RMC 12.2Kbps Link | <ul style="list-style-type: none"> ■ RMC 12.2Kbps Link |

2.2 Connection Diagram of Test System

For 22H (GSM, WCDMA)

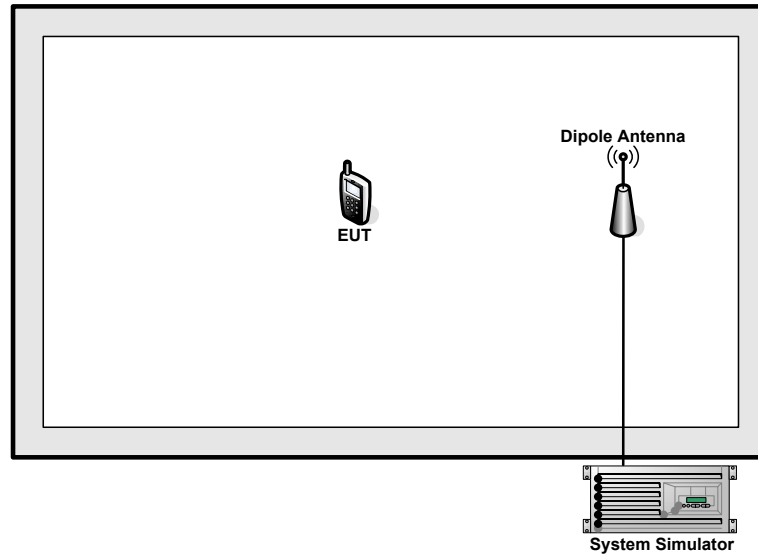

For 22H (CDMA), 24E, 27L

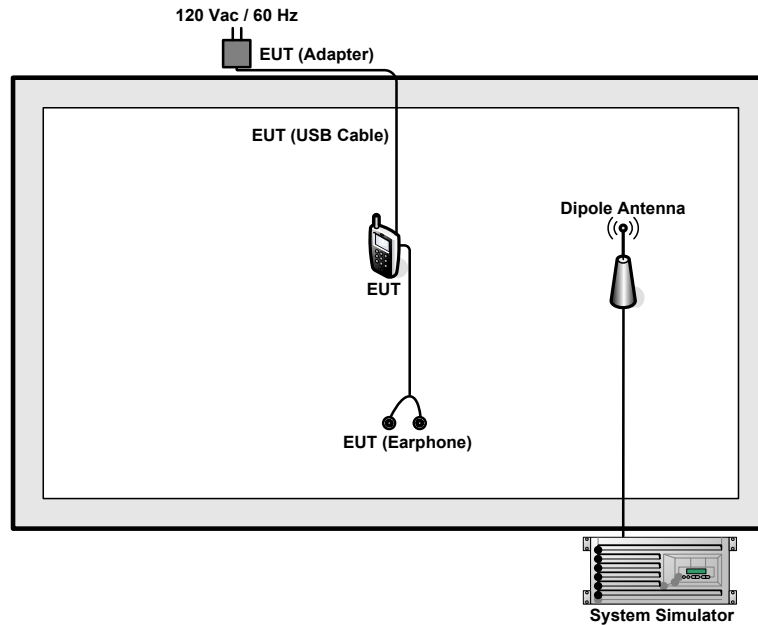



2.3 Support Unit used in test configuration

| Item | Equipment | Trade Name | Model No. | FCC ID | Data Cable | Power Cord |
|------|------------------|------------|-----------|--------|------------|-------------------|
| 1. | System Simulator | R&S | CMU 200 | N/A | N/A | Unshielded, 1.8 m |
| 2. | DC Power Supply | GW INSTEK | GPS-3030D | N/A | N/A | Unshielded, 1.8 m |

2.4 Measurement Results Explanation Example

For all conducted test items:

The offset level is set in the spectrum analyzer to compensate the RF cable loss and attenuator factor between RF conducted output port and spectrum analyzer. With the offset compensation, the spectrum analyzer reading level will be exactly the RF output level.

The spectrum analyzer offset is derived from RF cable loss and attenuator factor.

Offset = RF cable loss + attenuator factor.

The following shows an offset computation example with RF cable loss 4.4 dB and a 10dB attenuator.

Example :

$$\begin{aligned} \text{Offset(dB)} &= \text{RF cable loss(dB)} + \text{attenuator factor(dB)}. \\ &= 4.4 + 10 = 14.4 \text{ (dB)} \end{aligned}$$

3 Conducted Test Result

3.1 Measuring Instruments

See list of measuring instruments of this test report.

3.2 Test Setup

3.2.1 Conducted Output Power

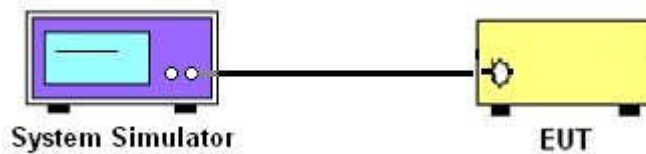

3.2.2 Peak-to-Average Ratio, Occupied Bandwidth, Conducted Band-Edge and Conducted Spurious Emission

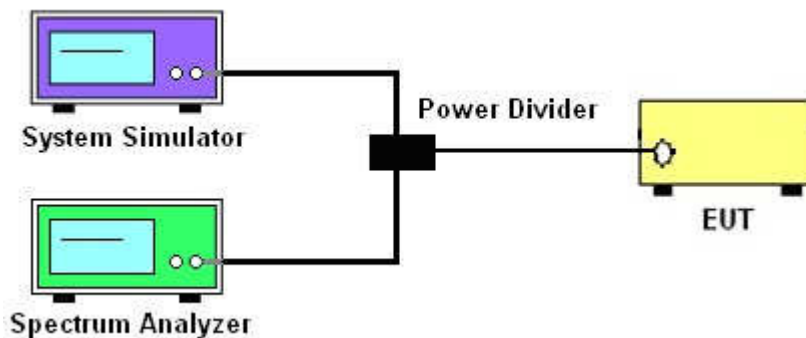

3.2.3 Frequency Stability

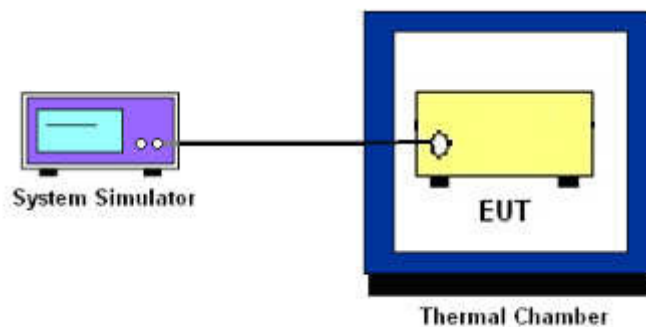

3.3 Test Result of Conducted Test

Please refer to Appendix A.



3.4 Conducted Output Power and ERP/EIRP

3.4.1 Description of the Conducted Output Power and ERP/EIRP

A system simulator was used to establish communication with the EUT. Its parameters were set to enforce EUT transmitting at the maximum power. The measured power in the radio frequency on the transmitter output terminals shall be reported.

The ERP of mobile transmitters must not exceed 7 Watts for GSM850 and CDMA BC0 and WCDMA Band V.

The EIRP of mobile transmitters must not exceed 2 Watts for GSM1900 and CDMA BC1 and WCDMA Band II.

The EIRP of mobile transmitters must not exceed 1 Watts for WCDMA Band IV.

According to KDB 412172 D01 Power Approach,

$EIRP = P_T + G_T - L_C$, $ERP = EIRP - 2.15$, where

P_T = transmitter output power in dBm

G_T = gain of the transmitting antenna in dBi

L_C = signal attenuation in the connecting cable between the transmitter and antenna in dB

3.4.2 Test Procedures

1. The transmitter output port was connected to the system simulator.
2. Set EUT at maximum power through system simulator.
3. Select lowest, middle, and highest channels for each band and different modulation.
4. Measure the maximum burst average power for GSM and maximum average power for other modulation signal.



3.5 Peak-to-Average Ratio

3.5.1 Description of the PAR Measurement

The peak-to-average ratio (PAR) of the transmission may not exceed 13 dB.

3.5.2 Test Procedures

1. The testing follows FCC KDB 971168 D01 v03 Section 5.7.1.
2. The EUT was connected to spectrum analyzer and system simulator via a power divider.
3. Set EUT to transmit at maximum output power.
4. When the duty cycle is less than 98%, then signal gating will be implemented on the spectrum analyzer by triggering from the system simulator.
5. Set the CCDF (Complementary Cumulative Distribution Function) option of the spectrum analyzer.
Record the maximum PAPR level associated with a probability of 0.1%.



3.6 99% Occupied Bandwidth and 26dB Bandwidth Measurement

3.6.1 Description of 99% Occupied Bandwidth and 26dB Bandwidth Measurement

The occupied bandwidth is the width of a frequency band such that, below the lower and above the upper frequency limits, the mean powers emitted are each equal to a specified percentage 0.5% of the total mean transmitted power.

The 26 dB emission bandwidth is defined as the frequency range between two points, one above and one below the carrier frequency, at which the spectral density of the emission is attenuated 26 dB below the maximum in-band spectral density of the modulated signal. Spectral density (power per unit bandwidth) is to be measured with a detector of resolution bandwidth equal to approximately 1.0% of the emission bandwidth.

3.6.2 Test Procedures

1. The testing follows FCC KDB 971168 v03 Section 4.2.
2. The EUT was connected to spectrum analyzer and system simulator via a power divider.
3. The spectrum analyzer center frequency is set to the nominal EUT channel center frequency. The span range for the spectrum analyzer shall be between two and five times the anticipated OBW.
4. The nominal resolution bandwidth (RBW) shall be in the range of 1 to 5 % of the anticipated OBW, and the VBW shall be at least 3 times the RBW.
5. Set the detection mode to peak, and the trace mode to max hold.
6. Determine the reference value: Set the EUT to transmit a modulated signal. Allow the trace to stabilize. Set the spectrum analyzer marker to the highest level of the displayed trace.
(this is the reference value)
7. Determine the “-26 dB down amplitude” as equal to (Reference Value – X).
8. Place two markers, one at the lowest and the other at the highest frequency of the envelope of the spectral display such that each marker is at or slightly below the “-X dB down amplitude” determined in step 6. If a marker is below this “-X dB down amplitude” value it shall be placed as close as possible to this value. The OBW is the positive frequency difference between the two markers.
9. Use the 99 % power bandwidth function of the spectrum analyzer and report the measured bandwidth.



3.7 Conducted Band Edge

3.7.1 Description of Conducted Band Edge Measurement

The power of any emission outside of the authorized operating frequency ranges must be lower than the transmitter power (P) by a factor of at least $43 + 10 \log (P)$ dB.

3.7.2 Test Procedures

1. The testing follows FCC KDB 971168 D01 v03 Section 6.0.
2. The EUT was connected to the spectrum analyzer and system simulator via a power divider.
3. The RF output of EUT was connected to the spectrum analyzer by an RF cable and attenuator. The path loss was compensated to the results for each measurement.
4. The band edges of low and high channels for the highest RF powers were measured.
5. The RF fundamental frequency should be excluded against the limit line in the operating frequency band.
6. The limit line is derived from $43 + 10\log(P)$ dB below the transmitter power P(Watts)
 $= P(W) - [43 + 10\log(P)]$ (dB)
 $= [30 + 10\log(P)]$ (dBm) - $[43 + 10\log(P)]$ (dB)
 $= -13\text{dBm}$.



3.8 Conducted Spurious Emission

3.8.1 Description of Conducted Spurious Emission Measurement

The power of any emission outside of the authorized operating frequency ranges must be lower than the transmitter power (P) by a factor of at least $43 + 10 \log (P)$ dB.

It is measured by means of a calibrated spectrum analyzer and scanned from 30 MHz up to a frequency including its 10th harmonic.

3.8.2 Test Procedures

1. The testing follows FCC KDB 971168 D01 v03 Section 6.0.
2. The EUT was connected to the spectrum analyzer and system simulator via a power divider.
3. The RF output of EUT was connected to the spectrum analyzer by an RF cable and attenuator. The path loss was compensated to the results for each measurement.
4. The middle channel for the highest RF power within the transmitting frequency was measured.
5. The conducted spurious emission for the whole frequency range was taken.
6. The RF fundamental frequency should be excluded against the limit line in the operating frequency band.
7. The limit line is derived from $43 + 10\log(P)$ dB below the transmitter power P(Watts)
= $P(W) - [43 + 10\log(P)]$ (dB)
= $[30 + 10\log(P)]$ (dBm) - $[43 + 10\log(P)]$ (dB)
= -13dBm.



3.9 Frequency Stability

3.9.1 Description of Frequency Stability Measurement

The frequency stability shall be measured by variation of ambient temperature and variation of primary supply voltage to ensure that the fundamental emission stays within the authorized frequency block. The frequency stability of the transmitter shall be maintained within $\pm 0.00025\%$ ($\pm 2.5\text{ppm}$) of the center frequency.

3.9.2 Test Procedures for Temperature Variation

1. The testing follows FCC KDB 971168 D01 v03 Section 9.0.
2. The EUT was set up in the thermal chamber and connected with the system simulator.
3. With power OFF, the temperature was decreased to -30°C and the EUT was stabilized before testing. Power was applied and the maximum change in frequency was recorded within one minute.
4. With power OFF, the temperature was raised in 10°C steps up to 50°C . The EUT was stabilized at each step for at least half an hour. Power was applied and the maximum frequency change was recorded within one minute.

3.9.3 Test Procedures for Voltage Variation

1. The testing follows FCC KDB 971168 D01 v03 Section 9.0.
2. The EUT was placed in a temperature chamber at $20\pm 5^{\circ}\text{C}$ and connected with the system simulator.
3. The power supply voltage to the EUT was varied from 85% to 115% of the nominal value measured at the input to the EUT.
4. The variation in frequency was measured for the worst case.

4 Radiated Test Items

4.1 Measuring Instruments

See list of measuring instruments of this test report.

4.2 Test Setup

4.2.1 For radiated test from 30MHz to 1GHz

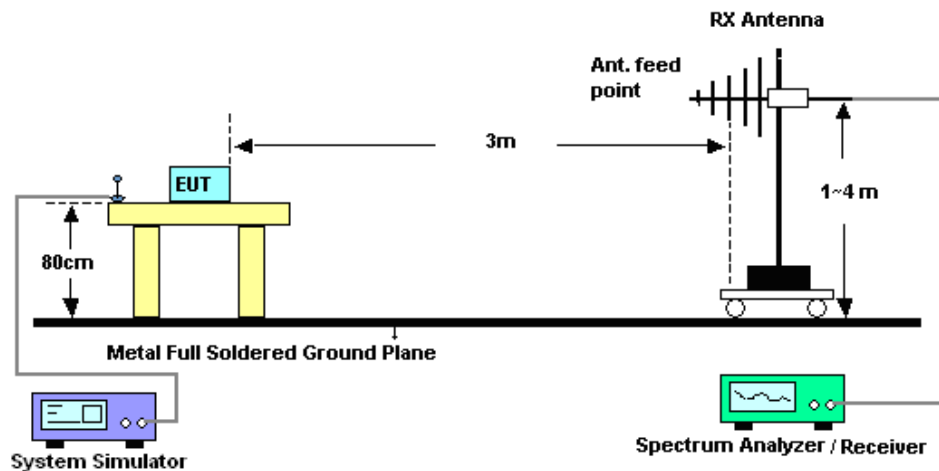

4.2.2 For radiated test above 1GHz

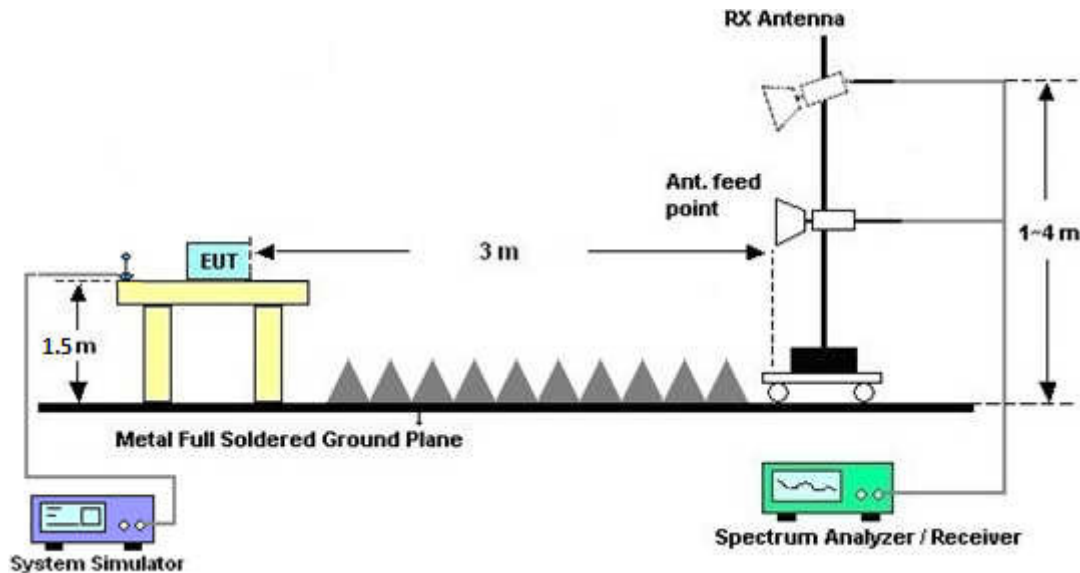

4.3 Test Result of Radiated Test

Please refer to Appendix B.



4.4 Field Strength of Spurious Radiation Measurement

4.4.1 Description of Field Strength of Spurious Radiated Measurement

The power of any emission outside of the authorized operating frequency ranges must be attenuated below the transmitter power (P) by a factor of at least $43 + 10 \log (P)$ dB. The spectrum is scanned from 30 MHz up to a frequency including its 10th harmonic.

4.4.2 Test Procedures

1. The testing follows FCC KDB 971168 D01 v03 Section 5.8 and ANSI/TIA-603-E Section 2.2.12.
2. The EUT was placed on a rotatable wooden table 0.8 meters for frequency below 1GHz and 1.5 meter for frequency above 1GHz above the ground.
3. The EUT was set 3 meters from the receiving antenna, which was mounted on the antenna tower.
4. The table was rotated 360 degrees to determine the position of the highest spurious emission.
5. The height of the receiving antenna is varied between one meter and four meters to search for the maximum spurious emission for both horizontal and vertical polarizations.
6. Make the measurement with the spectrum analyzer's RBW = 1MHz, VBW = 3MHz, taking record of maximum spurious emission.
7. A horn antenna was substituted in place of the EUT and was driven by a signal generator.
8. Tune the output power of signal generator to the same emission level with EUT maximum spurious emission.
9. Taking the record of output power at antenna port.
10. Repeat step 7 to step 8 for another polarization.
11. $EIRP \text{ (dBm)} = S.G. \text{ Power} - Tx \text{ Cable Loss} + Tx \text{ Antenna Gain}$
12. $ERP \text{ (dBm)} = EIRP - 2.15$
13. The RF fundamental frequency should be excluded against the limit line in the operating frequency band.
14. The limit line is derived from $43 + 10\log(P)$ dB below the transmitter power P(Watts)
 $= P(W) - [43 + 10\log(P)] \text{ (dB)}$
 $= [30 + 10\log(P)] \text{ (dBm)} - [43 + 10\log(P)] \text{ (dB)}$
 $= -13\text{dBm}.$



5 List of Measuring Equipment

| Instrument | Manufacturer | Model No. | Serial No. | Characteristics | Calibration Date | Test Date | Due Date | Remark |
|------------------------------|--------------|----------------------|------------|----------------------|------------------|---------------------------------|---------------|-----------------------|
| Spectrum Analyzer | R&S | FSV40 | 101040 | 10Hz~40GHz | Aug. 08, 2017 | Jan. 02, 2018~ Jan. 07, 2018 | Aug. 07, 2018 | Conducted (TH01-KS) |
| Radio communication analyzer | Anritsu | MT8820C | 6201300652 | 2G/3G/LTE_ full band | Aug. 08, 2017 | Jan. 02, 2018~ Jan. 07, 2018 | Aug. 07, 2018 | Conducted (TH01-KS) |
| Thermal Chamber | Ten Billion | TTC-B3S | TBN-960502 | -40~+150°C | Oct. 12, 2017 | Jan. 02, 2018~ Jan. 07, 2018 | Oct. 11, 2018 | Conducted (TH01-KS) |
| EXA Spectrum Analyzer | Keysight | N9010A | MY55150244 | 10Hz~44GHz | Apr. 18, 2017 | Jan. 04, 2018~ Jan. 14, 2018 | Apr. 17, 2018 | Radiation (03CH03-KS) |
| Bilog Antenna | TeseQ | CBL6112D | 35406 | 25MHz~2GHz | Apr. 22, 2017 | Jan. 04, 2018~ Jan. 14, 2018 | Apr. 21, 2018 | Radiation (03CH03-KS) |
| Horn Antenna | Schwarzbeck | BBHA9120 D | 9120D-1356 | 1GHz~18GHz | Apr. 22, 2017 | Jan. 04, 2018~ Jan. 14, 2018 | Apr. 21, 2018 | Radiation (03CH03-KS) |
| SHF-EHF Horn | Schwarzbeck | BBHA 9170 | BBHA170249 | 15GHz~40GHz | Feb. 15, 2017 | Jan. 04, 2018~ Jan. 14, 2018 | Feb. 14, 2018 | Radiation (03CH03-KS) |
| Amplifier | com-power | PA-103A | 161069 | 1MHz~1000MHz / 32 dB | Apr. 18, 2017 | Jan. 04, 2018~ Jan. 14, 2018 | Apr. 17, 2018 | Radiation (03CH03-KS) |
| Amplifier | MITEQ | TTA1840-35 -HG | 1887435 | 18GHz~40GHz | Oct. 12, 2017 | Jan. 04, 2018~ Jan. 14, 2018 | Oct. 11, 2018 | Radiation (03CH03-KS) |
| high gain Amplifier | MITEQ | AMF-7D-00 101800-30- | 2025788 | 1GHz~18GHz | Apr. 18, 2017 | Jan. 04, 2018~ Jan. 14, 2018 | Apr. 17, 2018 | Radiation (03CH03-KS) |
| Amplifier | Agilent | 8449B | 3008A02370 | 1GHz~26.5GHz | Oct. 12, 2017 | Jan. 04, 2018~ Jan. 14, 2018 | Oct. 11, 2018 | Radiation (03CH03-KS) |
| AC Power Source | Chroma | 61601 | F104090004 | N/A | NCR | Jan. 04, 2018~ Jan. 14, 2018 | NCR | Radiation (03CH03-KS) |
| Turn Table | ChamPro | EM 1000-T | 060762-T | 0~360 degree | NCR | Jan. 04, 2018~ Jan. 14, 2018 | NCR | Radiation (03CH03-KS) |
| Antenna Mast | ChamPro | EM 1000-A | 060762-A | 1 m~4 m | NCR | Jan. 04, 2018~ Jan. 14, 2018 | NCR | Radiation (03CH03-KS) |

NCR: No Calibration Required



6 Uncertainty of Evaluation

Uncertainty of Radiated Emission Measurement (30 MHz ~ 1000 MHz)

| | |
|---|-------|
| Measuring Uncertainty for a Level of Confidence of 95% ($U = 2Uc(y)$) | 2.8dB |
|---|-------|

Uncertainty of Radiated Emission Measurement (1 GHz ~ 40 GHz)

| | |
|---|-------|
| Measuring Uncertainty for a Level of Confidence of 95% ($U = 2Uc(y)$) | 3.3dB |
|---|-------|



Appendix A. Test Results of Conducted Test

Conducted Output Power(Average power)

| Conducted Power (*Unit: dBm) | | | | | | |
|------------------------------|--------------|-------|-------|---------|--------|--------------|
| Band | GSM850 | | | GSM1900 | | |
| Channel | 128 | 189 | 251 | 512 | 661 | 810 |
| Frequency | 824.2 | 836.4 | 848.8 | 1850.2 | 1880.0 | 1909.8 |
| GSM | 33.09 | 32.86 | 32.91 | 29.51 | 29.82 | 29.91 |
| GPRS class 8 | 33.07 | 32.84 | 32.89 | 29.49 | 29.80 | 29.89 |
| GPRS class 10 | 31.08 | 31.14 | 30.85 | 27.98 | 28.28 | 28.36 |
| GPRS class 11 | 28.73 | 28.85 | 28.61 | 25.91 | 26.11 | 26.19 |
| GPRS class 12 | 27.25 | 27.11 | 27.20 | 24.46 | 24.86 | 24.70 |
| EGPRS class 8 | 26.76 | 26.81 | 26.72 | 25.50 | 25.69 | 25.70 |
| EGPRS class 10 | 24.54 | 24.50 | 24.47 | 23.26 | 23.42 | 23.40 |
| EGPRS class 11 | 22.59 | 22.68 | 22.61 | 22.20 | 22.31 | 22.42 |
| EGPRS class 12 | 22.97 | 23.01 | 22.81 | 20.66 | 20.80 | 20.82 |

| Conducted Power (*Unit: dBm) | | | | | | | | | |
|------------------------------|--------------|-------|-------|---------------|--------------|--------|---------------|--------|--------------|
| Band | WCDMA Band V | | | WCDMA Band II | | | WCDMA Band IV | | |
| Channel | 4132 | 4182 | 4233 | 9262 | 9400 | 9538 | 1312 | 1413 | 1513 |
| Frequency | 826.4 | 836.4 | 846.6 | 1852.4 | 1880 | 1907.6 | 1712.4 | 1732.6 | 1752.6 |
| AMR 12.2K | 22.50 | 22.40 | 22.41 | 22.31 | 22.55 | 22.53 | 22.30 | 22.41 | 22.50 |
| RMC 12.2K | 22.52 | 22.41 | 22.43 | 22.33 | 22.56 | 22.55 | 22.31 | 22.43 | 22.51 |
| HSDPA Subtest-1 | 21.42 | 21.24 | 21.39 | 21.39 | 21.64 | 21.56 | 21.36 | 21.58 | 21.48 |
| HSDPA Subtest-2 | 21.44 | 21.25 | 21.42 | 21.38 | 21.68 | 21.56 | 21.32 | 21.57 | 21.20 |
| HSDPA Subtest-3 | 20.91 | 20.73 | 20.89 | 20.88 | 21.17 | 21.10 | 20.82 | 21.10 | 21.03 |
| HSDPA Subtest-4 | 20.91 | 20.77 | 20.93 | 20.93 | 21.16 | 21.09 | 20.81 | 21.07 | 21.01 |
| DC-HSDPA Subtest-1 | 21.35 | 21.13 | 21.35 | 21.35 | 21.62 | 21.56 | 21.35 | 21.48 | 21.42 |
| DC-HSDPA Subtest-2 | 21.48 | 21.25 | 21.42 | 21.26 | 21.58 | 21.51 | 21.31 | 21.49 | 21.38 |
| DC-HSDPA Subtest-3 | 20.89 | 20.71 | 20.85 | 20.87 | 21.15 | 21.05 | 20.80 | 21.08 | 21.02 |
| DC-HSDPA Subtest-4 | 20.88 | 20.78 | 20.89 | 20.80 | 21.05 | 21.06 | 20.78 | 21.05 | 21.03 |
| HSUPA Subtest-1 | 21.43 | 21.22 | 21.33 | 21.37 | 21.62 | 21.55 | 21.29 | 21.57 | 21.42 |
| HSUPA Subtest-2 | 19.38 | 19.23 | 19.37 | 19.38 | 19.59 | 19.54 | 19.28 | 19.54 | 19.54 |
| HSUPA Subtest-3 | 20.38 | 20.24 | 20.35 | 20.42 | 20.64 | 20.56 | 20.33 | 20.50 | 20.57 |
| HSUPA Subtest-4 | 19.40 | 19.25 | 19.34 | 19.36 | 19.64 | 19.54 | 19.29 | 19.54 | 19.46 |
| HSUPA Subtest-5 | 21.40 | 21.20 | 21.40 | 21.40 | 21.60 | 21.60 | 21.30 | 21.50 | 21.50 |



| Conducted Power (*Unit: dBm) | | | | | | |
|------------------------------|---------------|--------|--------|---------------|-------|---------|
| Band | CDMA 2000 BC0 | | | CDMA 2000 BC1 | | |
| Channel | 1013 | 384 | 777 | 25 | 600 | 1175 |
| Frequency | 824.7 | 836.52 | 848.31 | 1851.25 | 1880 | 1908.75 |
| 1xRTT RC1 SO55 | 24.13 | 24.05 | 24.07 | 23.52 | 23.50 | 23.55 |
| 1xRTT RC3 SO55 | 24.08 | 24.00 | 23.86 | 23.41 | 23.48 | 23.54 |
| 1xRTT RC3 SO32 (+ F-SCH) | 24.07 | 24.07 | 23.85 | 23.47 | 23.48 | 23.52 |
| 1xRTT RC3 SO32 (+SCH) | 24.02 | 23.98 | 23.77 | 23.38 | 23.44 | 23.49 |
| 1xEVDO RTAP 153.6Kbps | 24.01 | 23.95 | 23.78 | 23.42 | 23.49 | 23.53 |
| 1xEVDO RETAP 4096Bits | 24.05 | 24.01 | 23.98 | 23.40 | 23.47 | 23.49 |



ERP/EIRP

| GSM850 (G _T - L _C = -1.49dB) | | | |
|--|--------|--------|--------|
| Channel | 128 | 189 | 251 |
| | (Low) | (Mid) | (High) |
| Frequency | 824.2 | 836.4 | 848.8 |
| (MHz) | | | |
| Conducted Power (dBm) | 33.09 | 32.86 | 32.91 |
| Conducted Power (Watts) | 2.0370 | 1.9320 | 1.9543 |
| ERP(dBm) | 29.45 | 29.22 | 29.27 |
| ERP(Watts) | 0.8810 | 0.8356 | 0.8453 |

| EDGE850 (G _T - L _C = -1.49dB) | | | |
|---|--------|--------|--------|
| Channel | 128 | 189 | 251 |
| | (Low) | (Mid) | (High) |
| Frequency | 824.2 | 836.4 | 848.8 |
| (MHz) | | | |
| Conducted Power (dBm) | 26.76 | 26.81 | 26.72 |
| Conducted Power (Watts) | 0.4742 | 0.4797 | 0.4699 |
| ERP(dBm) | 23.12 | 23.17 | 23.08 |
| ERP(Watts) | 0.2051 | 0.2075 | 0.2032 |

| CDMA 2000 BC0 (G _T - L _C = -1.49dB) | | | |
|---|--------|--------|--------|
| Channel | 1013 | 384 | 777 |
| | (Low) | (Mid) | (High) |
| Frequency | 824.7 | 836.52 | 848.31 |
| (MHz) | | | |
| Conducted Power (dBm) | 24.13 | 24.05 | 24.07 |
| Conducted Power (Watts) | 0.2588 | 0.2541 | 0.2553 |
| ERP(dBm) | 20.49 | 20.41 | 20.43 |
| ERP(Watts) | 0.1119 | 0.1099 | 0.1104 |



| GSM1900 (G _T - L _C = -0.23dB) | | | |
|---|--------|--------|--------|
| Channel | 512 | 661 | 810 |
| | (Low) | (Mid) | (High) |
| Frequency | 1850.2 | 1880 | 1909.8 |
| (MHz) | | | |
| Conducted Power (dBm) | 29.51 | 29.82 | 29.91 |
| Conducted Power (Watts) | 0.8933 | 0.9594 | 0.9795 |
| EIRP(dBm) | 29.28 | 29.59 | 29.68 |
| EIRP(Watts) | 0.8472 | 0.9099 | 0.9290 |

| EDGE1900 (G _T - L _C = -0.23dB) | | | |
|--|--------|--------|--------|
| Channel | 512 | 661 | 810 |
| | (Low) | (Mid) | (High) |
| Frequency | 1850.2 | 1880 | 1909.8 |
| (MHz) | | | |
| Conducted Power (dBm) | 25.50 | 25.69 | 25.70 |
| Conducted Power (Watts) | 0.3548 | 0.3707 | 0.3715 |
| EIRP(dBm) | 25.27 | 25.46 | 25.47 |
| EIRP(Watts) | 0.3365 | 0.3516 | 0.3524 |

| CDMA 2000 BC1 (G _T - L _C = -0.23dB) | | | |
|---|---------|--------|---------|
| Channel | 25 | 600 | 1175 |
| | (Low) | (Mid) | (High) |
| Frequency | 1851.25 | 1880 | 1908.75 |
| (MHz) | | | |
| Conducted Power (dBm) | 23.52 | 23.5 | 23.55 |
| Conducted Power (Watts) | 0.2249 | 0.2239 | 0.2265 |
| EIRP(dBm) | 23.29 | 23.27 | 23.32 |
| EIRP(Watts) | 0.2133 | 0.2123 | 0.2148 |



| WCDMA Band V ($G_T - L_C = -1.49\text{dB}$) | | | |
|---|--------|--------|--------|
| Channel | 4132 | 4182 | 4233 |
| | (Low) | (Mid) | (High) |
| Frequency | 826.4 | 836.4 | 846.6 |
| (MHz) | | | |
| Conducted Power (dBm) | 22.52 | 22.41 | 22.43 |
| Conducted Power (Watts) | 0.1786 | 0.1742 | 0.1750 |
| ERP(dBm) | 18.88 | 18.77 | 18.79 |
| ERP(Watts) | 0.0773 | 0.0753 | 0.0757 |

| WCDMA Band II ($G_T - L_C = -0.23\text{dB}$) | | | |
|--|--------|--------|--------|
| Channel | 9262 | 9400 | 9538 |
| | (Low) | (Mid) | (High) |
| Frequency | 1852.4 | 1880 | 1907.6 |
| (MHz) | | | |
| Conducted Power (dBm) | 22.33 | 22.56 | 22.55 |
| Conducted Power (Watts) | 0.1710 | 0.1803 | 0.1799 |
| EIRP(dBm) | 22.1 | 22.33 | 22.32 |
| EIRP(Watts) | 0.1622 | 0.1710 | 0.1706 |

| WCDMA Band IV ($G_T - L_C = 0.64\text{dB}$) | | | |
|---|--------|--------|--------|
| Channel | 1312 | 1413 | 1513 |
| | (Low) | (Mid) | (High) |
| Frequency | 1712.4 | 1732.6 | 1752.6 |
| (MHz) | | | |
| Conducted Power (dBm) | 22.31 | 22.43 | 22.51 |
| Conducted Power (Watts) | 0.1702 | 0.1750 | 0.1782 |
| EIRP(dBm) | 22.95 | 23.07 | 23.15 |
| EIRP(Watts) | 0.1972 | 0.2028 | 0.2065 |



Peak-to-Average Ratio

| Mode | GSM850(dB) | | Limit: 13dB |
|------------|------------|--------------|-------------|
| Mod. | GSM | EDGE class 8 | Result |
| Lowest CH | 0.41 | 3.36 | PASS |
| Middle CH | 0.41 | 3.39 | |
| Highest CH | 0.38 | 3.33 | |

| Mode | GSM1900(dB) | | Limit: 13dB |
|------------|-------------|--------------|-------------|
| Mod. | GSM | EDGE class 8 | Result |
| Lowest CH | 0.35 | 3.57 | PASS |
| Middle CH | 0.35 | 3.33 | |
| Highest CH | 0.32 | 3.45 | |

| Mode | CDMA BC0(dB) | CDMA BC1(dB) | Limit: 13dB |
|------------|--------------|--------------|-------------|
| Mod. | 1xRTT | 1xRTT | Result |
| Lowest CH | 3.10 | 2.87 | PASS |
| Middle CH | 3.45 | 2.90 | |
| Highest CH | 3.59 | 3.19 | |

| Mode | WCDMA Band V(dB) | WCDMA Band II(dB) | WCDMA Band IV(dB) | Limit: 13dB |
|------------|------------------|-------------------|-------------------|-------------|
| Mod. | RMC 12.2Kbps | RMC 12.2Kbps | RMC 12.2Kbps | Result |
| Lowest CH | 3.07 | 2.93 | 3.13 | PASS |
| Middle CH | 3.25 | 2.84 | 3.74 | |
| Highest CH | 3.36 | 3.19 | 3.28 | |

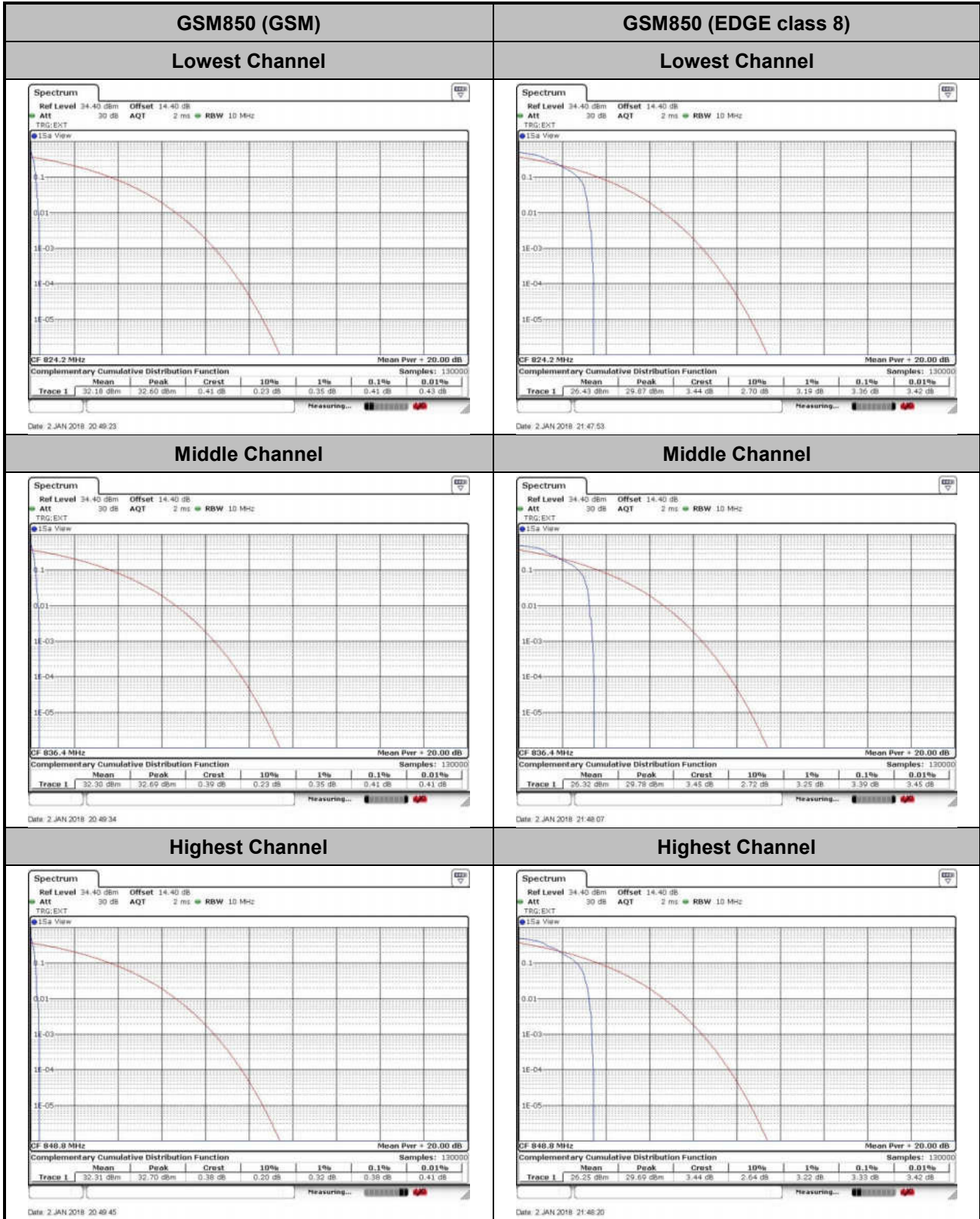

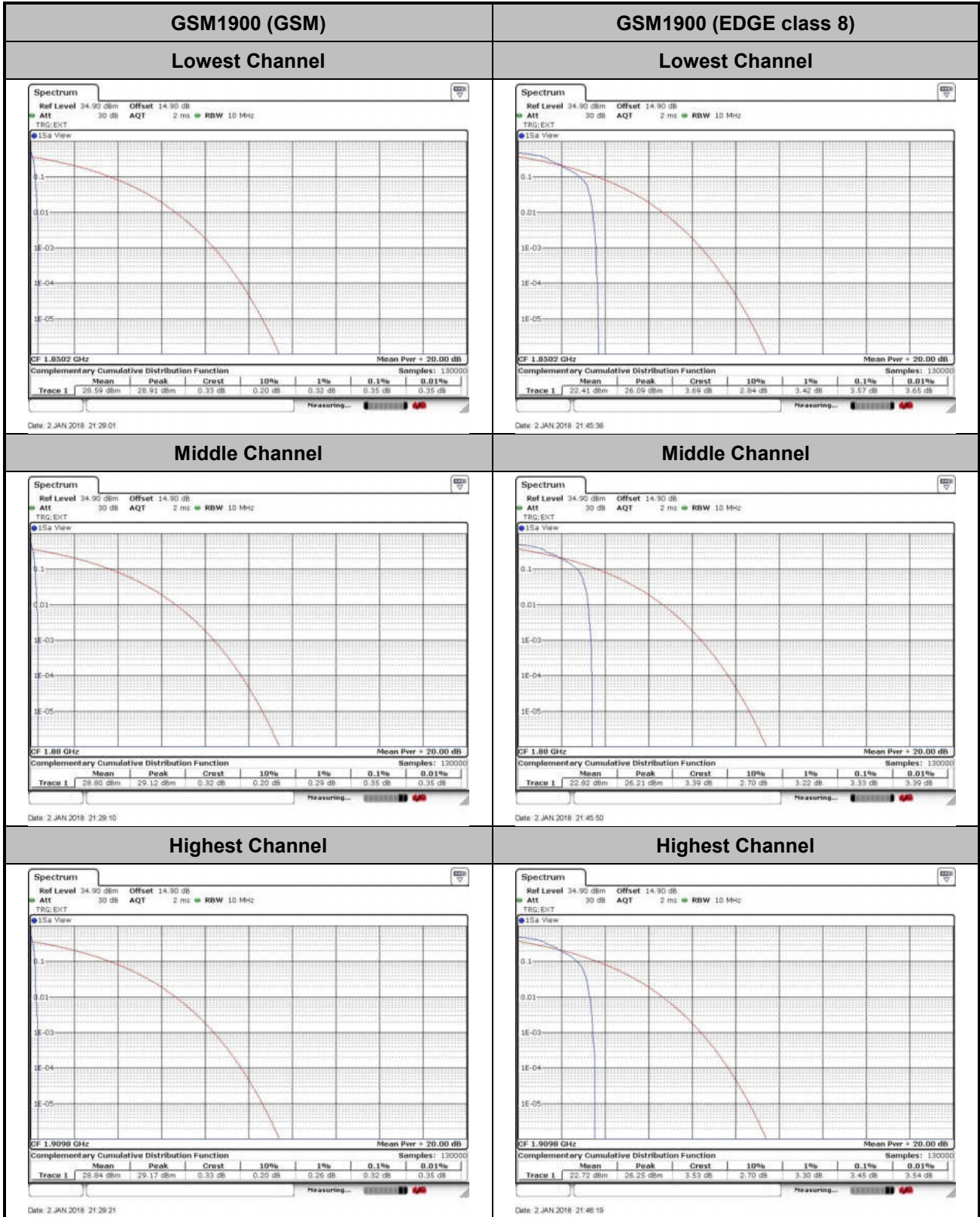



CDMA BC0 (1xRTT)

Lowest Channel

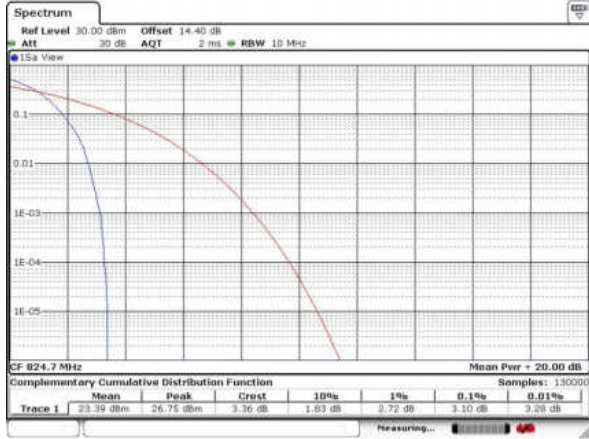

Date: 7 JAN 2018 04:38:02

CDMA BC1 (1xRTT)

Lowest Channel

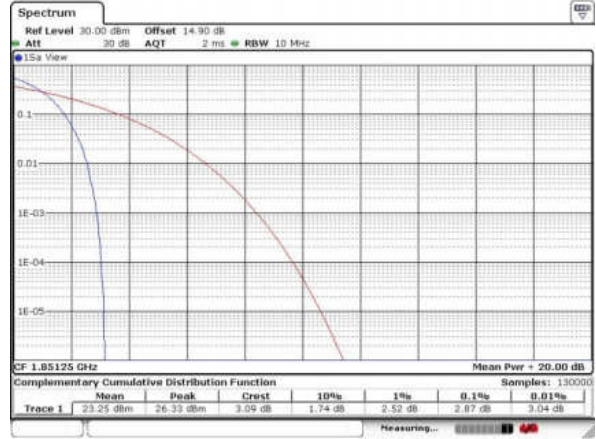

Date: 7 JAN 2018 05:02:38

Middle Channel

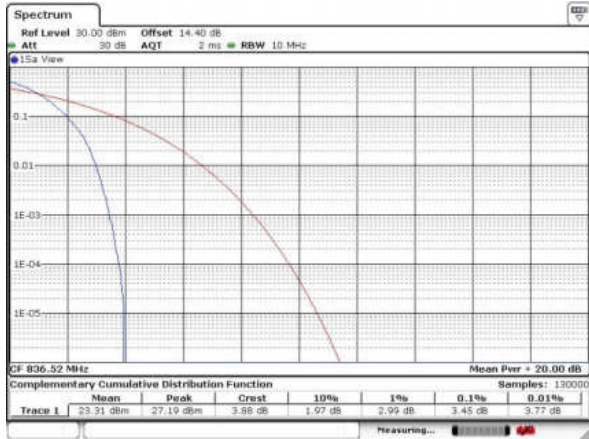

Date: 7 JAN 2018 04:38:29

Middle Channel

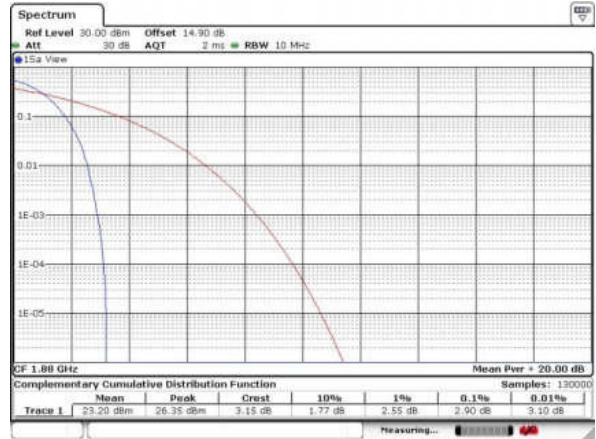

Date: 7 JAN 2018 05:02:45

Highest Channel

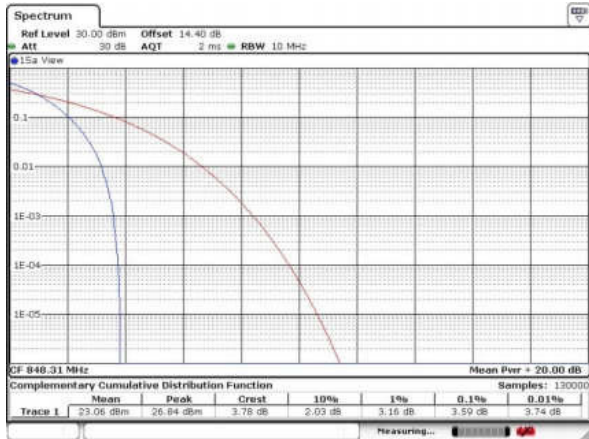

Date: 7 JAN 2018 04:38:49

Highest Channel

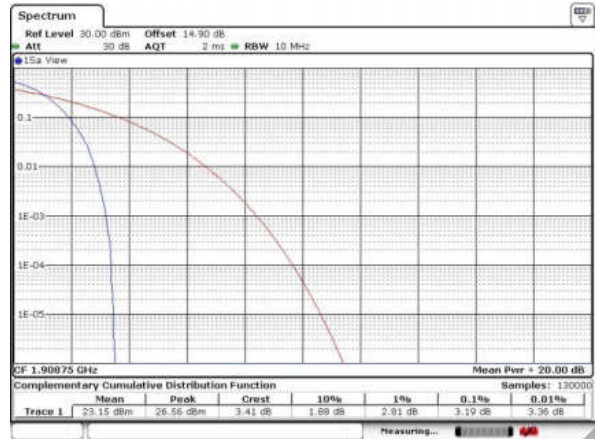

Date: 7 JAN 2018 05:02:52

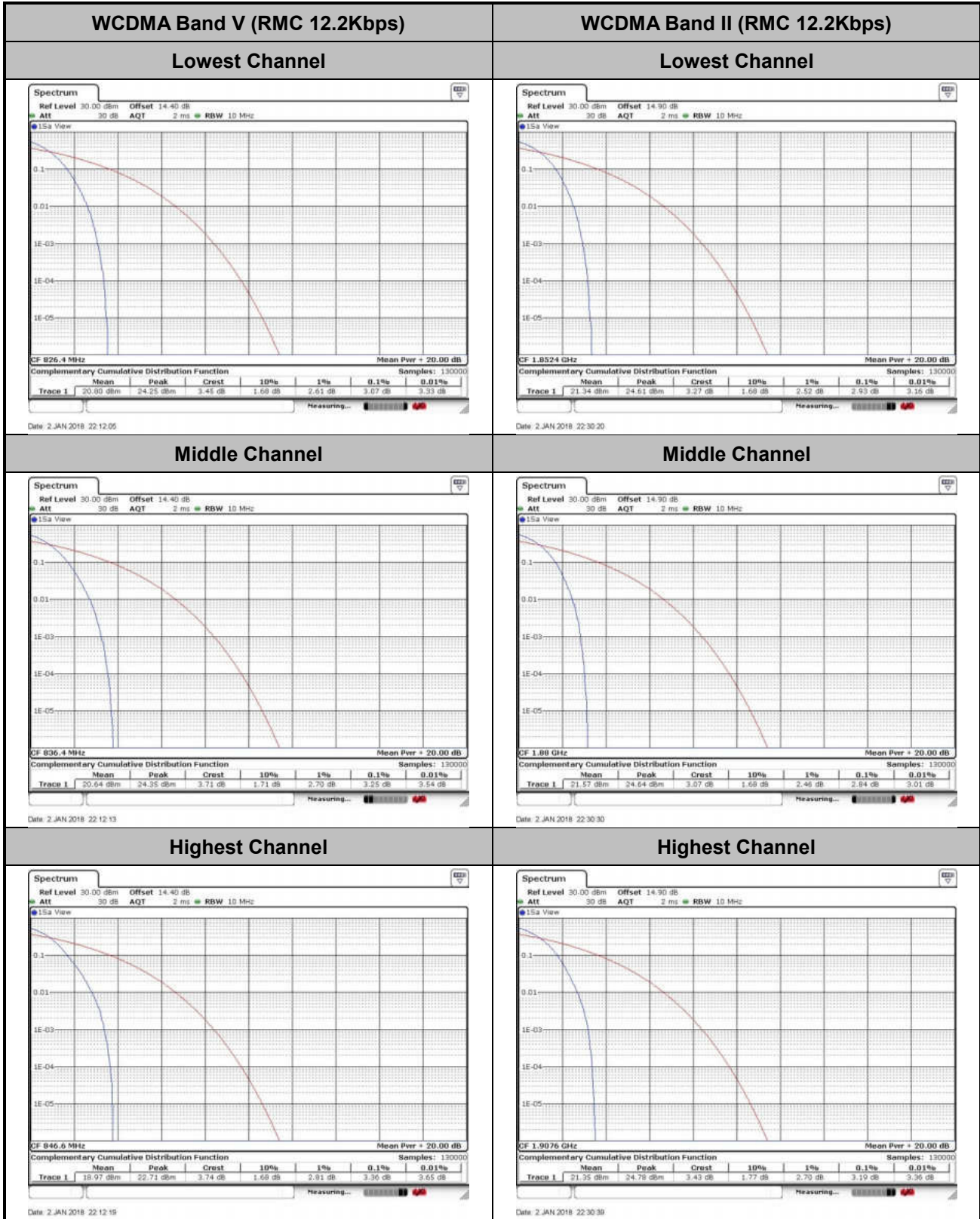

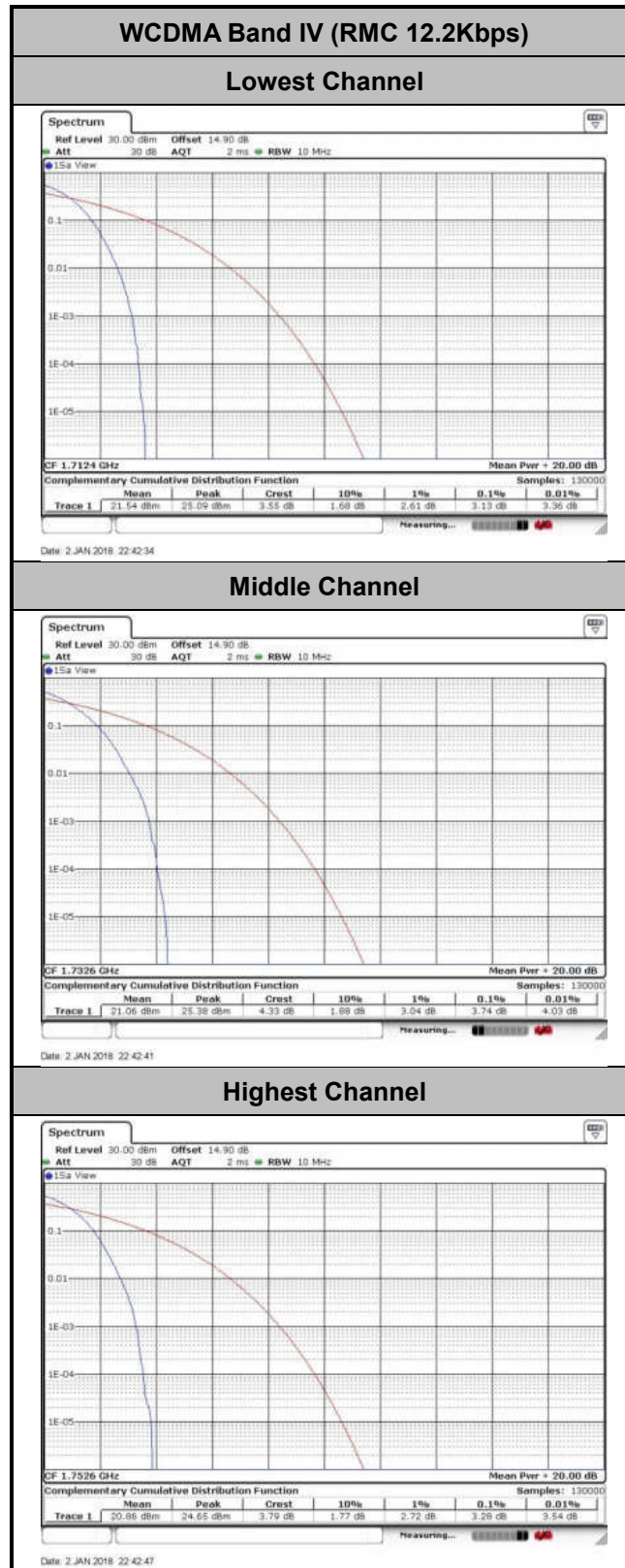



26dB Bandwidth

| Mode | GSM850(MHz) | |
|------------|-------------|--------------|
| Mod. | GSM | EDGE class 8 |
| Lowest CH | 0.315 | 0.303 |
| Middle CH | 0.316 | 0.313 |
| Highest CH | 0.317 | 0.313 |

| Mode | GSM1900(MHz) | |
|------------|--------------|--------------|
| Mod. | GSM | EDGE class 8 |
| Lowest CH | 0.316 | 0.312 |
| Middle CH | 0.314 | 0.315 |
| Highest CH | 0.312 | 0.313 |

| Mode | CDMA BC0(MHz) | CDMA BC1(MHz) |
|------------|---------------|---------------|
| Mod. | 1xRTT | 1xRTT |
| Lowest CH | 1.43 | 1.44 |
| Middle CH | 1.42 | 1.44 |
| Highest CH | 1.42 | 1.44 |

| Mode | WCDMA Band V(MHz) | WCDMA Band II(MHz) | WCDMA Band IV(MHz) |
|------------|-------------------|--------------------|--------------------|
| Mod. | RMC 12.2Kbps | RMC 12.2Kbps | RMC 12.2Kbps |
| Lowest CH | 4.72 | 4.74 | 4.71 |
| Middle CH | 4.71 | 4.74 | 4.71 |
| Highest CH | 4.70 | 4.72 | 4.70 |



GSM850 (GSM)

Lowest Channel



Date: 2 JAN 2018 20:27:25

GSM850 (EDGE class 8)

Lowest Channel



Date: 2 JAN 2018 20:52:41

Middle Channel

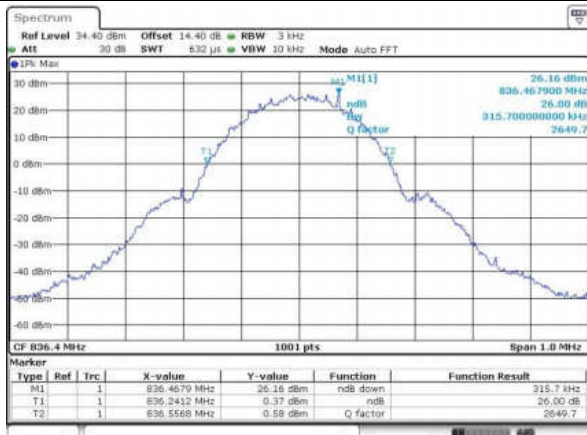

Date: 2 JAN 2018 20:27:53

Middle Channel

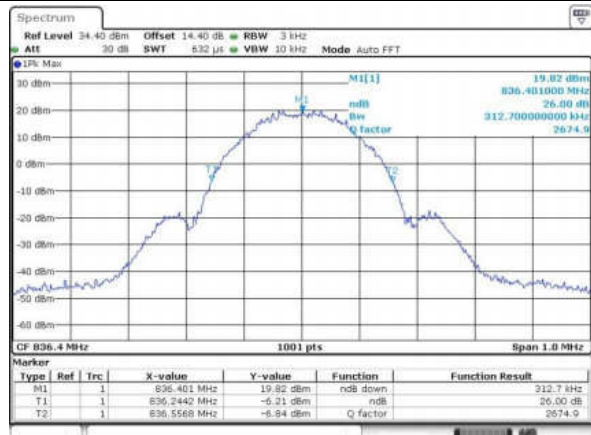

Date: 2 JAN 2018 20:53:12

Highest Channel

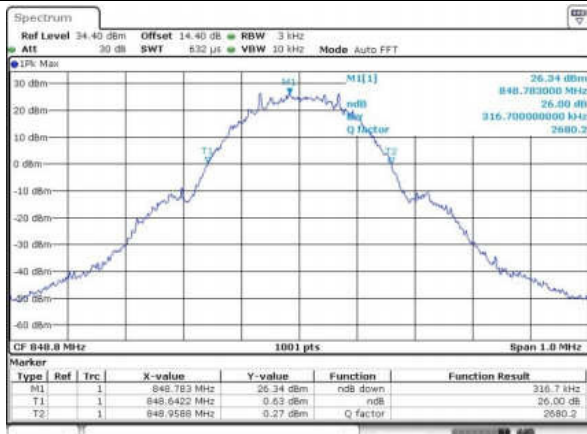

Date: 2 JAN 2018 20:28:21

Highest Channel

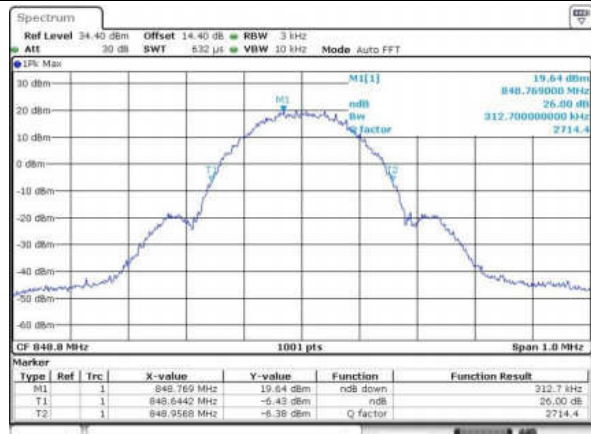

Date: 2 JAN 2018 20:53:46



GSM1900 (GSM)

Lowest Channel

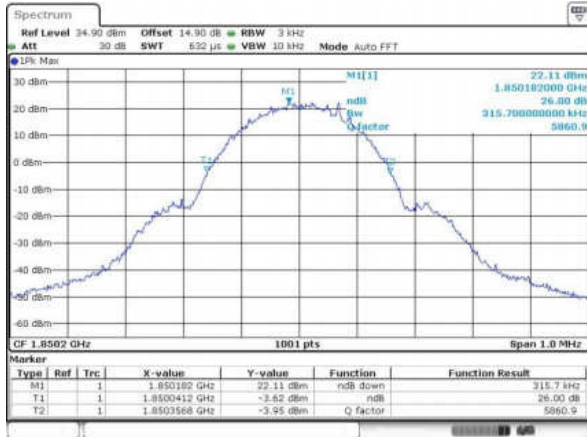

Date: 2 JAN 2018 21:08:45

GSM1900 (EDGE class 8)

Lowest Channel

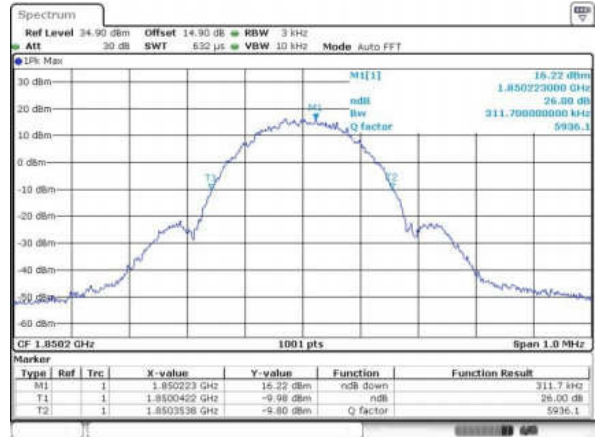

Date: 2 JAN 2018 21:31:13

Middle Channel

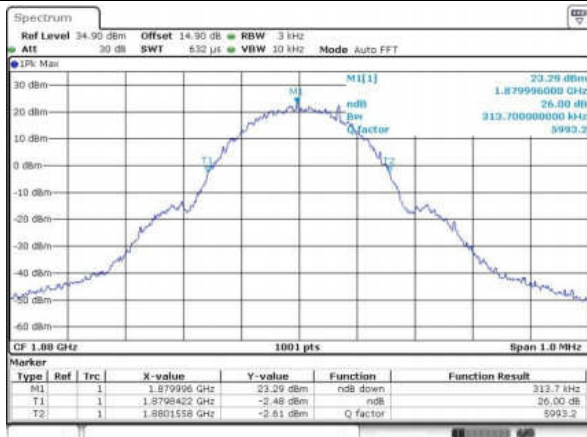

Date: 2 JAN 2018 21:09:13

Middle Channel

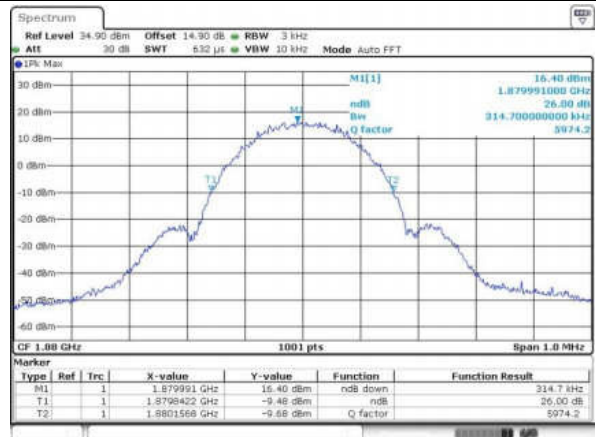

Date: 2 JAN 2018 21:31:46

Highest Channel

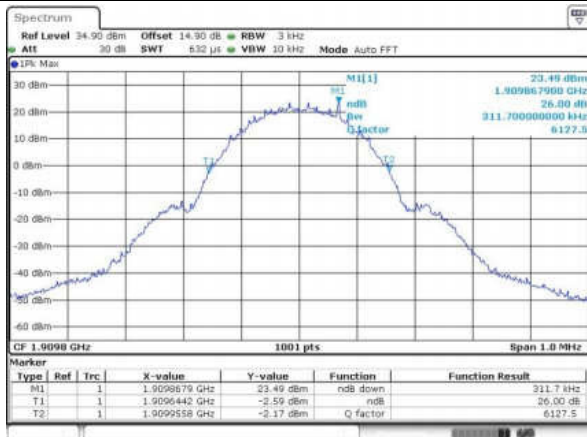

Date: 2 JAN 2018 21:09:42

Highest Channel

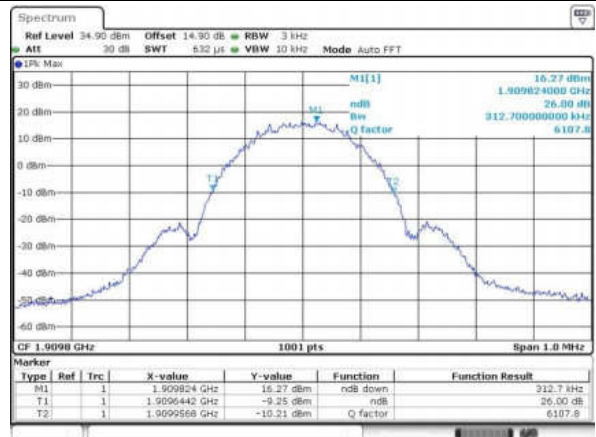

Date: 2 JAN 2018 21:32:24



CDMA BC0 (1xRTT)

Lowest Channel

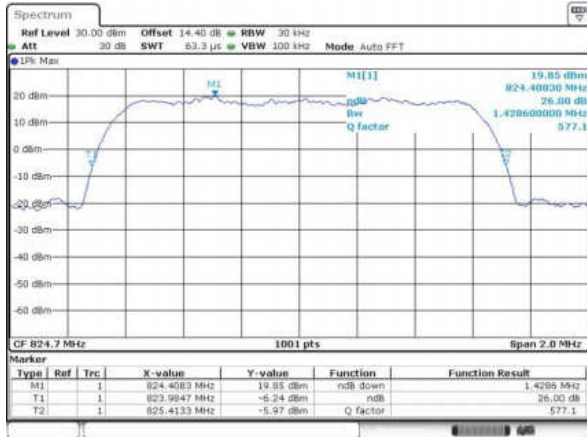

Date: 7.JAN.2018 04:03:00

CDMA BC1 (1xRTT)

Lowest Channel

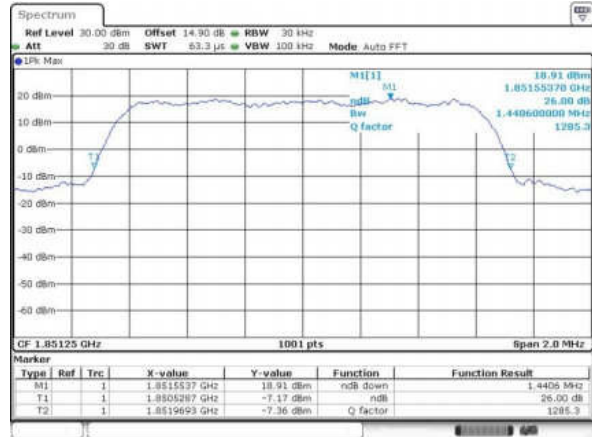

Date: 7.JAN.2018 04:43:05

Middle Channel

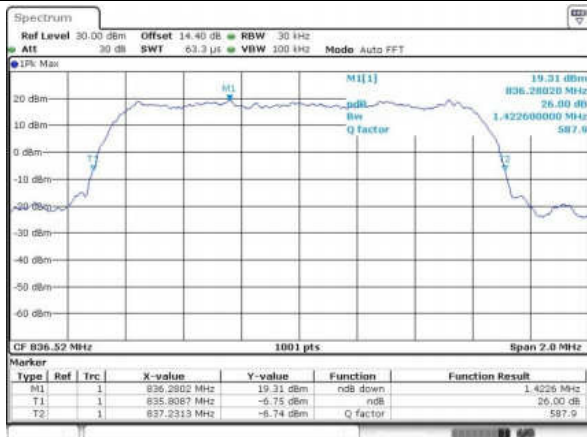

Date: 7.JAN.2018 04:04:04

Middle Channel

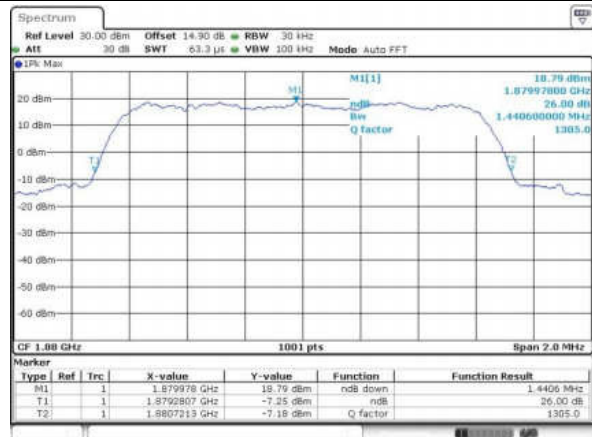

Date: 7.JAN.2018 04:43:42

Highest Channel

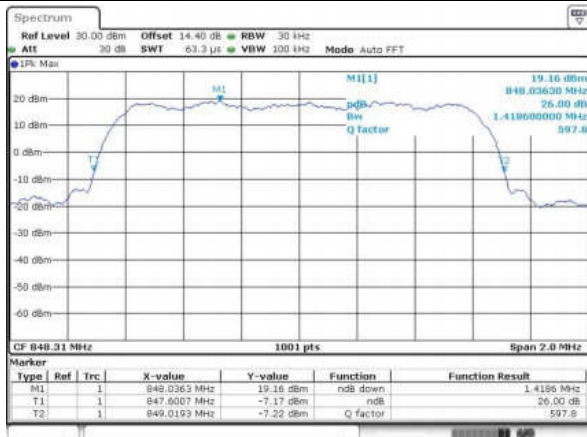

Date: 7.JAN.2018 04:04:38

Highest Channel

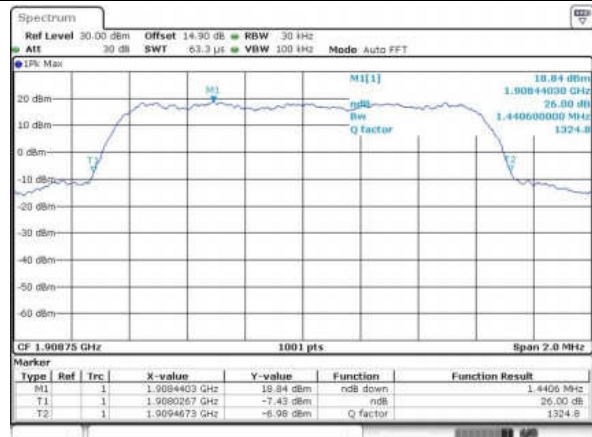

Date: 7.JAN.2018 04:44:17



WCDMA Band V (RMC 12.2Kbps)

Lowest Channel

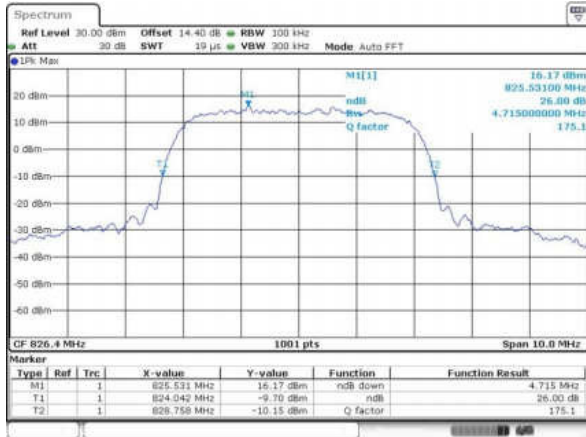

Date: 2 JAN 2018 21:54:46

WCDMA Band II (RMC 12.2Kbps)

Lowest Channel

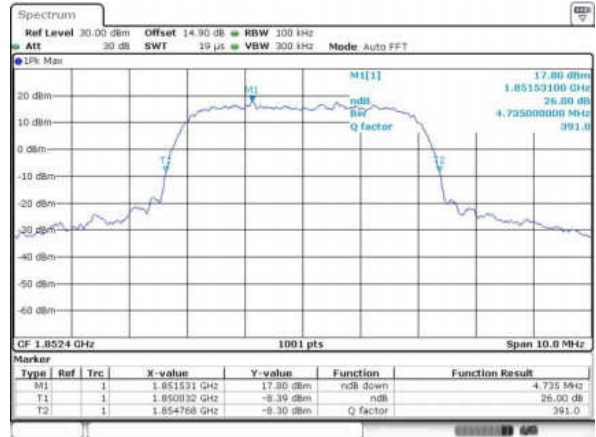

Date: 2 JAN 2018 22:15:18

Middle Channel

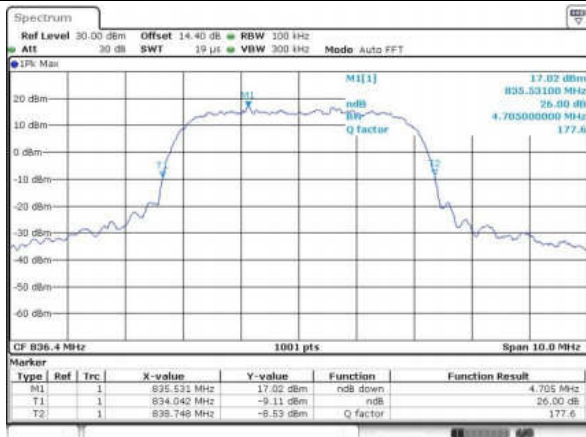

Date: 2 JAN 2018 21:55:14

Middle Channel

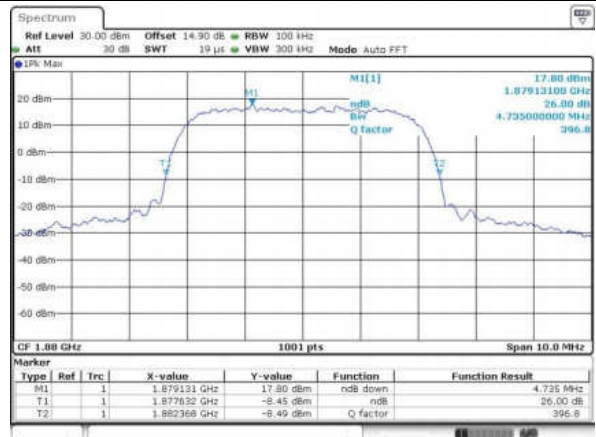

Date: 2 JAN 2018 22:15:46

Highest Channel

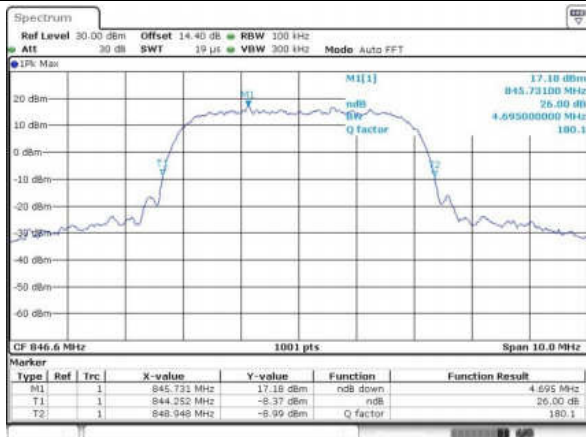

Date: 2 JAN 2018 21:55:42

Highest Channel

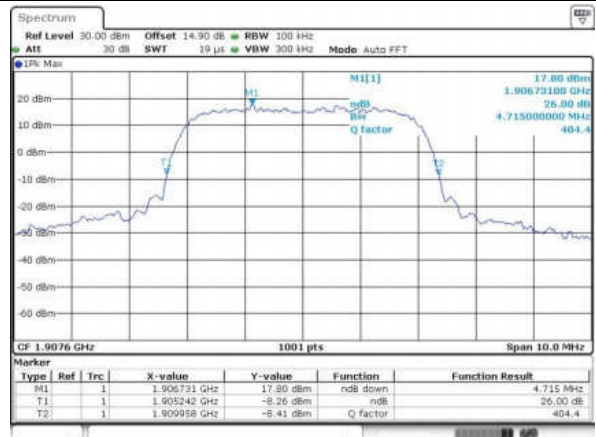

Date: 2 JAN 2018 22:16:14