



# FCC RF Test Report

**APPLICANT** : Motorola Mobility LLC  
**EQUIPMENT** : Mobile Cellular Phone  
**BRAND NAME** : Motorola  
**MODEL NAME** : XT1925-2, XT1925-1  
**FCC ID** : IHDT56XD5  
**STANDARD** : FCC Part 15 Subpart E §15.407  
**CLASSIFICATION** : (NII) Unlicensed National Information Infrastructure

The product was received on Dec. 25, 2017 and testing was completed on Feb. 02, 2018. We, Sporton International (Kunshan) Inc., would like to declare that the tested sample has been evaluated in accordance with the test procedures and has been in compliance with the applicable technical standards.

The test results in this report apply exclusively to the tested model / sample. Without written approval of Sporton International (Kunshan) Inc., the test report shall not be reproduced except in full.



Approved by: James Huang / Manager

**Sporton International (Kunshan) Inc.**  
**No.3-2 Ping-Xiang Rd, Kunshan Development Zone Kunshan City Jiangsu Province 215335**  
**China**



# TABLE OF CONTENTS

**1 GENERAL DESCRIPTION ..... 5**

1.1 Applicant ..... 5

1.2 Manufacturer ..... 5

1.3 Product Feature of Equipment Under Test ..... 5

1.4 Product Specification of Equipment Under Test ..... 6

1.5 Specification of Accessory ..... 7

1.6 Modification of EUT ..... 7

1.7 Testing Location ..... 7

1.8 Applicable Standards ..... 8

**2 TEST CONFIGURATION OF EQUIPMENT UNDER TEST ..... 9**

2.1 Carrier Frequency Channel ..... 9

2.2 Test Mode ..... 10

2.3 Connection Diagram of Test System ..... 12

2.4 Support Unit used in test configuration and system ..... 13

2.5 EUT Operation Test Setup ..... 13

2.6 Measurement Results Explanation Example ..... 13

**3 TEST RESULT ..... 14**

3.1 26dB & 99% Occupied Bandwidth Measurement ..... 14

3.2 Maximum Conducted Output Power Measurement ..... 16

3.3 Power Spectral Density Measurement ..... 18

3.4 Unwanted Radiated Emission Measurement ..... 21

3.5 AC Conducted Emission Measurement ..... 27

3.6 Automatically Discontinue Transmission ..... 31

3.7 Antenna Requirements ..... 32

**4 LIST OF MEASURING EQUIPMENTS ..... 33**

**5 UNCERTAINTY OF EVALUATION ..... 34**

**APPENDIX A. CONDUCTED TEST RESULTS**

**APPENDIX B. RADIATED SPURIOUS EMISSION**

**APPENDIX C. DUTY CYCLE PLOTS**

**APPENDIX D. SETUP PHOTOGRAPHS**



## REVISION HISTORY

REPORT NO.	VERSION	DESCRIPTION	ISSUED DATE
FR7D2507-03D	Rev. 01	Initial issue of report	Feb. 05, 2018



### SUMMARY OF TEST RESULT

Report Section	FCC Rule	Description	Limit	Result	Remark
3.1	2.1049 15.403(i)	26dB & 99% Bandwidth	-	Pass	-
3.2	15.407(a)	Maximum Conducted Output Power	FCC ≤ 24 dBm (depend on band)	Pass	-
3.3	15.407(a)	Power Spectral Density	FCC ≤ 11 dBm (depend on band)	Pass	-
3.4	15.407(b)	Unwanted Emissions	15.407(b) 15.209(a)	Pass	Under limit 3.1 dB at 5149.990 MHz
3.5	15.207	AC Conducted Emission	15.207(a)	Pass	Under limit 11.26 dB at 0.163 MHz
3.6	15.407(c)	Automatically Discontinue Transmission	Discontinue Transmission	Pass	-
3.7	15.203 & 15.407(a)	Antenna Requirement	N/A	Pass	-



# 1 General Description

## 1.1 Applicant

Motorola Mobility LLC  
222 W, Merchandise Mart Plaza, Chicago IL 60654 USA

## 1.2 Manufacturer

Motorola Mobility LLC  
222 W, Merchandise Mart Plaza, Chicago IL 60654 USA

## 1.3 Product Feature of Equipment Under Test

Product Feature	
Equipment	Mobile Cellular Phone
Brand Name	Motorola
Model Name	XT1925-2, XT1925-1
FCC ID	IHDT56XD5
EUT supports Radios application	GSM/GPRS/EGPRS/WCDMA/HSPA/DC-HSDPA/ HSPA+(16QAM uplink is not supported)/LTE WLAN 2.4GHz 802.11b/g/n HT20 WLAN 5GHz 802.11a/n HT20/HT40 Bluetooth v3.0+EDR/ Bluetooth v4.0 LE/ Bluetooth v4.1 LE/Bluetooth v4.2 LE
IMEI Code	Conducted: 351848090017317/351848090017325 Conduction/Radiation: 351848090015253/351848090015261
HW Version	DVT1-B
SW Version	ali_n-userdebug 8.0.0 OPS27.55 1276 intcfg,test-keys
EUT Stage	Identical Prototype

**Remark:**

1. The above EUT's information was declared by manufacturer. Please refer to the specifications or user's manual for more detailed description.
2. There are two types of EUT: sample 1 (XT1925-2) is dual SIM card, sample 2 (XT1925-1) is single SIM card. According to the difference, only choose sample 1 to perform full test.



### 1.4 Product Specification of Equipment Under Test

Standards-related Product Specification	
<b>Tx/Rx Frequency Range</b>	5180 MHz ~ 5240 MHz 5260 MHz ~ 5320 MHz 5500 MHz ~ 5700 MHz
<b>Maximum Output Power to Antenna</b>	<5180 MHz ~ 5240 MHz> 802.11a : 15.04 dBm / 0.0319 W 802.11n HT20 : 15.05 dBm / 0.0320 W 802.11n HT40 : 14.07 dBm / 0.0255 W <5260 MHz ~ 5320 MHz> 802.11a : 14.97 dBm / 0.0314 W 802.11n HT20 : 14.92 dBm / 0.0310 W 802.11n HT40 : 13.96 dBm / 0.0249 W <5500 MHz ~ 5700 MHz > 802.11a : 14.86 dBm / 0.0306 W 802.11n HT20 : 14.92 dBm / 0.0310 W 802.11n HT40 : 13.87 dBm / 0.0244 W
<b>99% Occupied Bandwidth</b>	<5180 MHz ~ 5240 MHz> 802.11a : 28.22 MHz 802.11n HT20 : 29.72 MHz 802.11n VHT40 : 42.46 MHz <5260 MHz ~ 5320 MHz> 802.11a : 27.12 MHz 802.11n HT20 : 27.62 MHz 802.11n VHT40 : 40.56 MHz <5500 MHz ~ 5700 MHz > 802.11a : 23.08 MHz 802.11n HT20 : 24.23 MHz 802.11n HT40 : 38.26 MHz
<b>Antenna Gain / Gain</b>	<5180 MHz ~ 5240 MHz> PIFA Antenna with gain -0.71 dBi <5260 MHz ~ 5320 MHz> PIFA Antenna with gain 0.47 dBi <5500 MHz ~ 5720 MHz> PIFA Antenna with gain 0.47 dBi
<b>Type of Modulation</b>	802.11a/n : OFDM (BPSK / QPSK / 16QAM / 64QAM)



## 1.5 Specification of Accessory

Specification of Accessory			
AC Adapter 1(US)	Brand Name	Motorola (Salom)	Model Name SC-22
	Power Rating	I/P: 100-240 Vac, 500mA, O/P: 5Vdc,3000mA or 9Vdc,1600mA or 12Vdc,1200mA	
AC Adapter 1(EU)	Brand Name	Motorola (Salom)	Model Name SC-23
	Power Rating	I/P: 100-240 Vac, 500mA, O/P: 5Vdc,3000mA or 9Vdc,1600mA or 12Vdc,1200mA	
AC Adapter 1(UK)	Brand Name	Motorola (Salom)	Model Name SC-24
	Power Rating	I/P: 100-240 Vac, 500mA, O/P: 5Vdc,3000mA or 9Vdc,1600mA or 12Vdc,1200mA	
AC Adapter 1(IN)	Brand Name	Motorola (Salom)	Model Name SC-25
	Power Rating	I/P: 100-240 Vac, 500mA, O/P: 5Vdc,3000mA or 9Vdc,1600mA or 12Vdc,1200mA	
AC Adapter 1(AU)	Brand Name	Motorola (Salom)	Model Name SC-26
	Power Rating	I/P: 100-240 Vac, 500mA, O/P: 5Vdc,3000mA or 9Vdc,1600mA or 12Vdc,1200mA	
AC Adapter 1(AR)	Brand Name	Motorola (Salom)	Model Name SC-27
	Power Rating	I/P: 100-240 Vac, 500mA, O/P: 5Vdc,3000mA or 9Vdc,1600mA or 12Vdc,1200mA	
AC Adapter 2(US)	Brand Name	Motorola (Chenyang)	Model Name SC-22
	Power Rating	I/P: 100-240 Vac, 500mA, O/P: 5Vdc,3000mA or 9Vdc,1600mA or 12Vdc,1200mA	
AC Adapter 2(EU)	Brand Name	Motorola (Chenyang)	Model Name SC-23
	Power Rating	I/P: 100-240 Vac, 500mA, O/P: 5Vdc,3000mA or 9Vdc,1600mA or 12Vdc,1200mA	
AC Adapter 2(UK)	Brand Name	Motorola (Chenyang)	Model Name SC-24
	Power Rating	I/P: 100-240 Vac, 500mA, O/P: 5Vdc,3000mA or 9Vdc,1600mA or 12Vdc,1200mA	
AC Adapter 2(IN)	Brand Name	Motorola (Chenyang)	Model Name SC-25
	Power Rating	I/P: 100-240 Vac, 500mA, O/P: 5Vdc,3000mA or 9Vdc,1600mA or 12Vdc,1200mA	
AC Adapter 2(AU)	Brand Name	Motorola (Chenyang)	Model Name SC-26
	Power Rating	I/P: 100-240 Vac, 500mA, O/P: 5Vdc,3000mA or 9Vdc,1600mA or 12Vdc,1200mA	
AC Adapter 2(AR)	Brand Name	Motorola (Chenyang)	Model Name SC-27
	Power Rating	I/P: 100-240 Vac, 500mA, O/P: 5Vdc,3000mA or 9Vdc,1600mA or 12Vdc,1200mA	
Battery	Brand Name	Motorola (ATL)	Model Name HG30
	Power Rating	3.8Vdc,3000mAh	Type Li-ion
Earphone 1	Brand Name	Motorola (Jiahe)	Model Name LS-118M-12
	Signal Line Type	1.2 meter, non-shielded cable, without ferrite core	
Earphone 2	Brand Name	Motorola (Lianyun)	Model Name TS910A-38AMS01WHR-M
	Signal Line Type	1.2 meter, non-shielded cable, without ferrite core	
USB Cable	Brand Name	Motorola (Liqi)	Model Name L32B-053000100-ALL
	Signal Line Type	1.0 meter, shielded cable, without ferrite core	

## 1.6 Modification of EUT

No modifications are made to the EUT during all test items.

## 1.7 Testing Location

Sporton International (Kunshan) Inc. is accredited to ISO 17025 by National Voluntary Laboratory Accreditation Program (NVLAP code: 600155-0) and the FCC designation No. is CN5013.



<b>Test Site</b>	Sporton International (Kunshan) Inc.			
<b>Test Site Location</b>	No.3-2 Ping-Xiang Rd, Kunshan Development Zone Kunshan City Jiangsu Province 215335 China TEL : +86-512-57900158 FAX : +86-512-57900958			
<b>Test Site No.</b>	<b>Sporton Site No.</b>			<b>FCC Test Firm Registration No.</b>
	TH01-KS	03CH03-KS	CO01-KS	630927

**Note:** The test site complies with ANSI C63.4 2014 requirement.

### 1.8 Applicable Standards

According to the specifications of the manufacturer, the EUT must comply with the requirements of the following standards:

- ♦ FCC Part 15 Subpart E
- ♦ FCC KDB 789033 D02 General UNII Test Procedures New Rules v02r01
- ♦ ANSI C63.10-2013

**Remark:**

1. All test items were verified and recorded according to the standards and without any deviation during the test.
2. This EUT has also been tested and complied with the requirements of FCC Part 15, Subpart B, recorded in a separate test report.





## 2 Test Configuration of Equipment Under Test

The EUT has been associated with peripherals and configuration operated in a manner tended to maximize its emission characteristics in a typical application. Frequency range investigated: conducted emission (150 kHz to 30 MHz) and radiated emission (9 kHz to the 10th harmonic of the highest fundamental frequency or to 40 GHz, whichever is lower). For radiated measurement, pre-scanned in three orthogonal planes, X, Y, Z. The worst cases were recorded in this report.

### 2.1 Carrier Frequency Channel

Frequency Band	Channel	Freq. (MHz)	Channel	Freq. (MHz)
5180-5240 MHz Band 1 (U-NII-1)	36	5180	44	5220
	38*	5190	46*	5230
	40	5200	48	5240
	-	-	-	-

Frequency Band	Channel	Freq. (MHz)	Channel	Freq. (MHz)
5260-5320 MHz Band 2 (U-NII-2A)	52	5260	60	5300
	54*	5270	62*	5310
	56	5280	64	5320
	-	-	-	-

Frequency Band	Channel	Freq. (MHz)	Channel	Freq. (MHz)
5500-5700 MHz Band 3 (U-NII-2C)	100	5500	112	5560
	102*	5510	116	5580
	104	5520	132	5660
	-	-	134*	5670
	108	5540	136	5680
	110*	5550	140	5700

Frequency Band	Channel	Freq. (MHz)	Channel	Freq. (MHz)
TDWR Channel	118*	5590	124	5620
	120	5600	126*	5630
	-	-	128	5640

**Note:** The above Frequency and Channel in "\*" were 802.11n HT40.



## 2.2 Test Mode

Final test mode of conducted test items and radiated spurious emissions are considering the modulation and worse data rates as below table.

Modulation	Data Rate
802.11a	6 Mbps
802.11n HT20	MCS0
802.11n HT40	MCS0

<b>AC Conducted Emission</b>	Mode 1 : GSM850 Idle + Bluetooth Link + WLAN Link (5G) + USB Cable (Charging from Adapter 1) + Earphone 1
<b>Remark:</b> For Radiated Test Cases, The tests were performed with Earphone 1, Adapter 1 and USB Cable.	



Ch. #		Band I : 5150-5250 MHz	Band II : 5250-5350 MHz	Band III : 5470-5725MHz
		802.11a	802.11a	802.11a
L	Low	36	52	100
M	Middle	44	60	116
H	High	48	64	140

Ch. #		Band I : 5150-5250 MHz	Band II : 5250-5350 MHz	Band III : 5470-5725MHz
		802.11n HT20	802.11n HT20	802.11n HT20
L	Low	36	52	100
M	Middle	44	60	116
H	High	48	64	140

Ch. #		Band I : 5150-5250 MHz	Band II : 5250-5350 MHz	Band III : 5470-5725MHz
		802.11n HT40	802.11n HT40	802.11n HT40
L	Low	38	54	102
M	Middle	-	-	110
H	High	46	62	134

## 2.3 Connection Diagram of Test System

<WLAN Tx Mode>

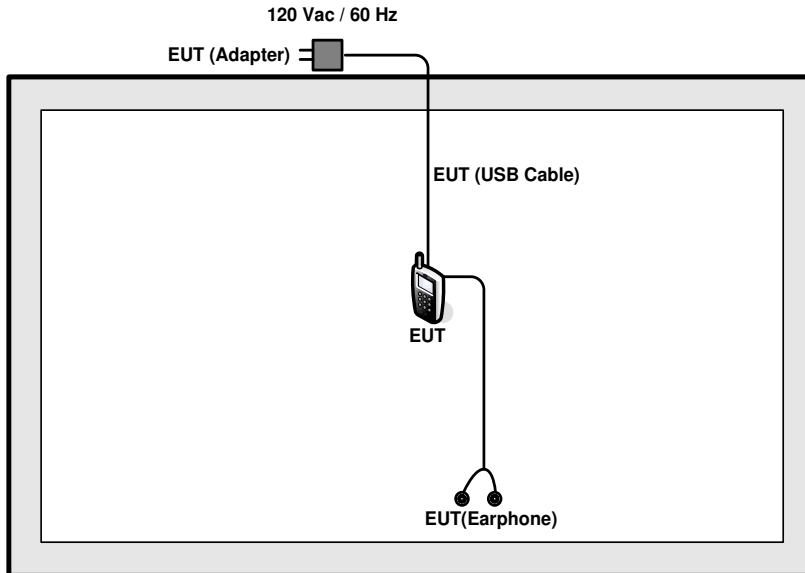

<AC Conducted Emission Mode>

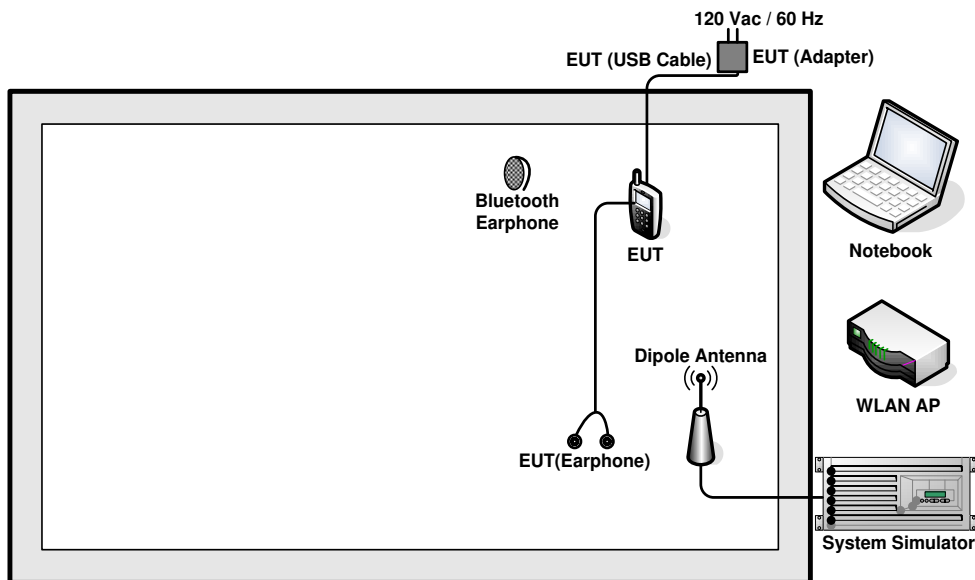



## 2.4 Support Unit used in test configuration and system

Item	Equipment	Trade Name	Model Name	FCC ID	Data Cable	Power Cord
1.	System Simulator	R&S	CMU 200	N/A	N/A	Unshielded, 1.8 m
2.	WLAN AP	D-Link	DIR-855	KA2DIR855A2	N/A	Unshielded, 1.8 m
3.	Notebook	Lenovo	G480	N/A	N/A	AC I/P: Unshielded, 1.8 m DC O/P: Shielded, 1.8 m
4.	Bluetooth Earphone	Lenovo	LBH308	N/A	N/A	N/A

## 2.5 EUT Operation Test Setup

For WLAN RF test items, an engineering test program was provided and enabled to make EUT continuously transmit/receive.

For AC power line conducted emissions, the EUT was set to connect with the WLAN AP under large package sizes transmission.

## 2.6 Measurement Results Explanation Example

For all conducted test items:

The offset level is set in the spectrum analyzer to compensate the RF cable loss between EUT conducted output port and spectrum analyzer. With the offset compensation, the spectrum analyzer reading level is exactly the EUT RF output level.

Example :

The spectrum analyzer offset is derived from RF cable loss.

$$\text{Offset} = \text{RF cable loss.}$$

Following shows an offset computation example with cable loss 6.5 dB.

$$\begin{aligned} \text{Offset(dB)} &= \text{RF cable loss(dB)}. \\ &= 6.5 \text{ (dB)} \end{aligned}$$

### 3 Test Result

#### 3.1 26dB & 99% Occupied Bandwidth Measurement

##### 3.1.1 Description of 26dB & 99% Occupied Bandwidth

This section is for reporting purpose only.

There is no restriction limits for bandwidth.

##### 3.1.2 Measuring Instruments

The measuring equipment is listed in the section 4 of this test report.

##### 3.1.3 Test Procedures

1. The testing follows FCC KDB 789033 D02 General UNII Test Procedures New Rules v02r01.  
Section C) Emission bandwidth
2. Set RBW = approximately 1% of the emission bandwidth.
3. Set the VBW > RBW.
4. Detector = Peak.
5. Trace mode = max hold
6. Measure the maximum width of the emission that is 26 dB down from the peak of the emission.  
Compare this with the RBW setting of the analyzer. Readjust RBW and repeat measurement as needed until the RBW/EBW ratio is approximately 1%.
7. For 99% Bandwidth Measurement, the spectrum analyzer's resolution bandwidth (RBW) is set 1MHz and set the Video bandwidth (VBW)  $\geq 3 * RBW$ .
8. Measure and record the results in the test report.

##### 3.1.4 Test Setup

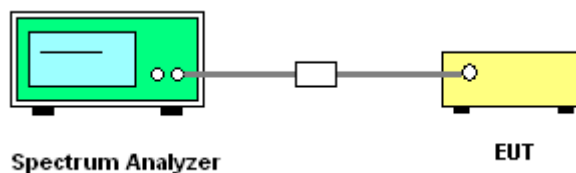



### 3.1.5 Test Result of 26dB & 99% Occupied Bandwidth Plots

Please refer to Appendix A.

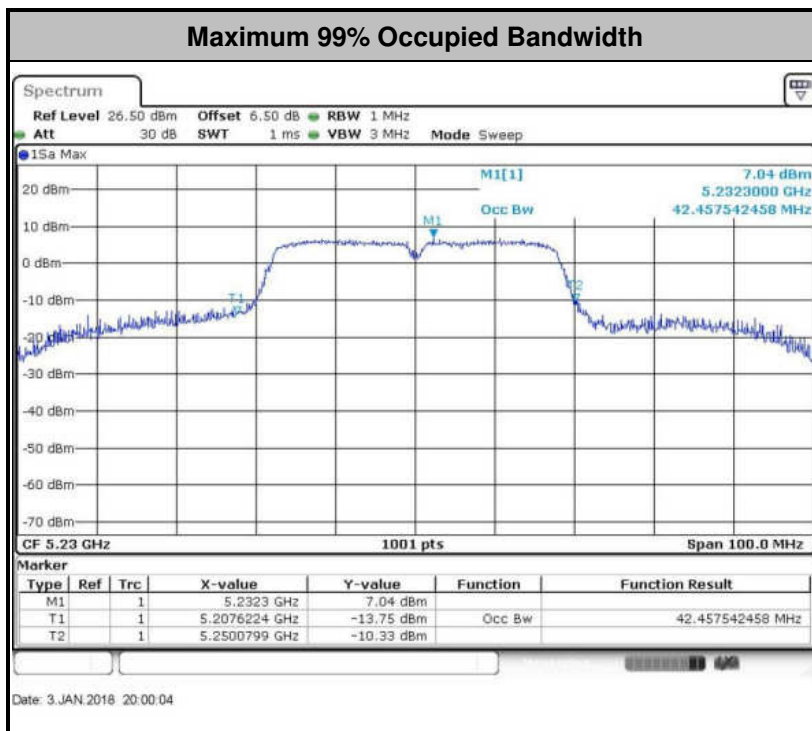
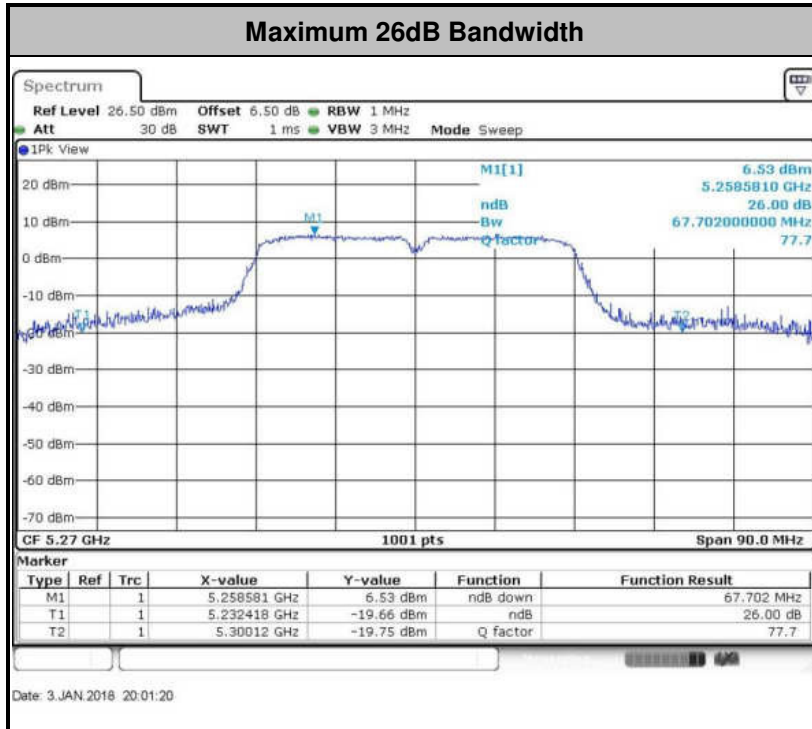



## 3.2 Maximum Conducted Output Power Measurement

### 3.2.1 Limit of Maximum Conducted Output Power

<FCC 14-30 CFR 15.407>

For mobile and portable client devices in the 5.15–5.25 GHz band, the maximum conducted output power over the frequency band of operation shall not exceed 250 mW.

For the 5.25–5.725 GHz bands, the maximum conducted output power over the frequency bands of operation shall not exceed the lesser of 250 mW or  $11 \text{ dBm} + 10 \log B$ , where B is the 26 dB emission bandwidth in megahertz.

If transmitting antennas of directional gain greater than 6 dBi are used, the peak output power shall be reduced by the amount in dB that the directional gain of the antenna exceeds 6 dBi.

Note that U-NII-2 band, devices with a maximum e.i.r.p. greater than 500 mW shall implement TPC in order to have the capability to operate at least 6 dB below the maximum permitted e.i.r.p. of 1 W.

### 3.2.2 Measuring Instruments

The measuring equipment is listed in the section 4 of this test report.



### 3.2.3 Test Procedures

The testing follows Method PM of FCC KDB 789033 D02 General UNII Test Procedures New Rules v02r01.

Method PM (Measurement using an RF average power meter):

1. Measurement is performed using a wideband RF power meter.
2. The EUT is configured to transmit continuously with a consistent duty cycle at its maximum power control level.
3. Measure the average power of the transmitter, and the average power is corrected with duty factor,  $10 \log(1/x)$ , where  $x$  is the duty cycle.

### 3.2.4 Test Setup

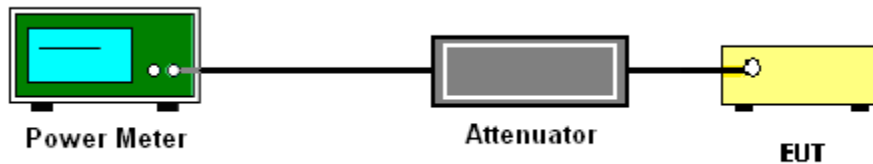

### 3.2.5 Test Result of Maximum Conducted Output Power

Please refer to Appendix A.



### 3.3 Power Spectral Density Measurement

#### 3.3.1 Limit of Power Spectral Density

<FCC 14-30 CFR 15.407>

For mobile and portable client devices in the 5.15–5.25 GHz band, the maximum power spectral density shall not exceed 11dBm in any 1 megahertz band.

For the 5.25–5.725 GHz bands, the maximum power spectral density shall not exceed 11 dBm in any 1 megahertz band.

If transmitting antennas of directional gain greater than 6 dBi are used, the peak output power shall be reduced by the amount in dB that the directional gain of the antenna exceeds 6 dBi.

#### 3.3.2 Measuring Instruments

The measuring equipment is listed in the section 4 of this test report.

### 3.3.3 Test Procedures

The testing follows FCC KDB 789033 D02 General UNII Test Procedures New Rules v02r01.  
Section F) Maximum power spectral density.

#### # Method SA-2 #

(trace averaging across on and off times of the EUT transmissions, followed by duty cycle correction).

1. The testing follows Method SA-2 of FCC KDB 789033 D02 General UNII Test Procedures New Rules v02r01.
  - Measure the duty cycle.
  - Set span to encompass the entire emission bandwidth (EBW) of the signal.
  - Set RBW = 1 MHz.
  - Set VBW  $\geq$  3 MHz.
  - Number of points in sweep  $\geq$  2 Span / RBW.
  - Sweep time = auto.
  - Detector = RMS
  - Trace average at least 100 traces in power averaging mode.
  - Add  $10 \log(1/x)$ , where  $x$  is the duty cycle, to the measured power in order to compute the average power during the actual transmission times. For example, add  $10 \log(1/0.25) = 6$  dB if the duty cycle is 25 percent.
2. The RF output of EUT was connected to the spectrum analyzer by a low loss cable.
3. Each plot has already offset with cable loss, and attenuator loss. Measure the PPSD and record it.

### 3.3.4 Test Setup

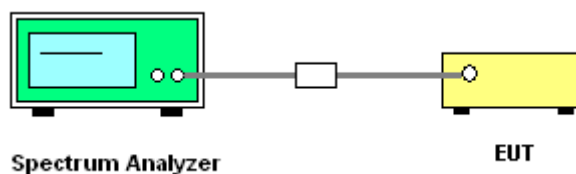



### 3.3.5 Test Result of Power Spectral Density

Please refer to Appendix A.

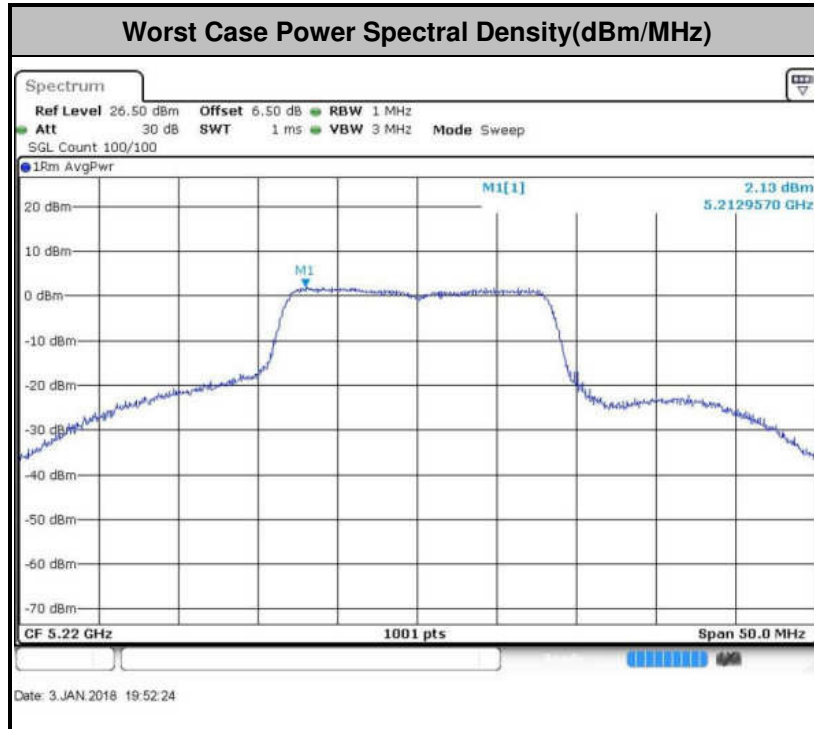

**Note:** Average Power Density (dB) = Measured value+ Duty Factor



### 3.4 Unwanted Radiated Emission Measurement

This section is to measure unwanted emissions through radiated measurement for band edge spurious emissions and out of band emissions measurement.

#### 3.4.1 Limit of Unwanted Emissions

- (1) For transmitters operating in the 5150-5250 MHz band: all emissions outside of the 5150-5350 MHz band shall not exceed an EIRP of -27dBm/MHz.

For transmitters operating in the 5250-5350 MHz band: all emissions outside of the 5150-5350 MHz band shall not exceed an EIRP of -27 dBm/MHz. Devices operating in the 5250-5350 MHz band that generate emissions in the 5150-5250 MHz band must meet all applicable technical requirements for operation in the 5150-5250 MHz band (including indoor use) or alternatively meet an out-of-band emission EIRP limit of -27 dBm/MHz in the 5150-5250 MHz band.

For transmitters operating in the 5470-5725MHz band: all emissions outside of the 5470-5725MHz band shall not exceed an EIRP of -27 dBm/MHz.

- (2) Unwanted spurious emissions fallen in restricted bands shall comply with the general field strength limits as below table

Frequency (MHz)	Field Strength (microvolts/meter)	Measurement Distance (meters)
0.009 – 0.490	2400/F(kHz)	300
0.490 – 1.705	24000/F(kHz)	30
1.705 – 30.0	30	30
30 – 88	100	3
88 – 216	150	3
216 - 960	200	3
Above 960	500	3

**Note:** The following formula is used to convert the EIRP to field strength.

$$E = \frac{1000000\sqrt{30P}}{3} \mu\text{V/m, where P is the eirp (Watts)}$$



EIRP (dBm)	Field Strength at 3m (dBμV/m)
- 27	68.3

(3) KDB789033 D01 v02r01 G)2)c)

- (i) Section 15.407(b)(1) to (b)(3) specify the unwanted emission limits for the U-NII-1 and U-NII-2 bands. As specified, emissions above 1000 MHz that are outside of the restricted bands are subject to a peak emission limit of -27 dBm/MHz.<sup>3</sup>
- (ii) Section 15.407(b)(4) specifies the unwanted emission limit for the U-NII-3 band. A band emissions mask is specified in Section 15.407(b)(4)(i). The emission limits are in terms of a Peak detector. An alternative to the band emissions mask is specified in Section 15.407(b)(4)(ii). The alternative limits are based on the highest antenna gain specified in the filing. There are also marketing and importation restrictions for the devices using the alternative limit.<sup>4</sup>

**Note 3:** An out-of-band emission that complies with both the average and peak limits of Section 15.209 is not required to satisfy the -27 dBm/MHz peak emission limit.

**Note 4:** Only devices with antenna gains of 10 dBi or less may be approved using the emission limits specified in Section 15.247(d) till March 2, 2018; all other devices operating in this band must use the mask specified in Section 15.407(b)(4)(i).



### **3.4.2 Measuring Instruments**

The measuring equipment is listed in the section 4 of this test report.

### **3.4.3 Test Procedures**

1. The testing follows FCC KDB 789033 D02 General UNII Test Procedures New Rules v02r01. Section G) Unwanted emissions measurement.

(1) Procedure for Unwanted Emissions Measurements Below 1000MHz

- RBW = 120 kHz
- VBW = 300 kHz
- Detector = Peak
- Trace mode = max hold

(2) Procedure for Peak Unwanted Emissions Measurements Above 1000 MHz

- RBW = 1 MHz
- VBW  $\geq$  3 MHz
- Detector = Peak
- Sweep time = auto
- Trace mode = max hold

(3) Procedures for Average Unwanted Emissions Measurements Above 1000MHz

- RBW = 1 MHz
- VBW = 10 Hz, when duty cycle is no less than 98 percent.
- VBW  $\geq$  1/T, when duty cycle is less than 98 percent where T is the minimum transmission duration over which the transmitter is on and is transmitting at its maximum power control level for the tested mode of operation.

2. The EUT was placed on a turntable with 0.8 meter for frequency below 1GHz and 1.5 meter for frequency above 1GHz respectively above ground.
3. The EUT was set 3 meters from the interference receiving antenna which was mounted on the top of a variable height antenna tower.
4. The antenna is a broadband antenna and its height is adjusted between one meter and four meters above ground to find the maximum value of the field strength for both horizontal polarization and vertical polarization of the antenna.
5. For each suspected emission, the EUT was arranged to its worst case and then adjust the antenna tower (from 1 m to 4 m) and turntable (from 0 degree to 360 degrees) to find the maximum reading.
6. For testing below 1GHz, if the emission level of the EUT in peak mode was 3 dB lower than the limit specified, then peak values of EUT will be reported, otherwise, the emissions will be repeated one by one using the CISPR quasi-peak method and reported.
7. For testing above 1GHz, the emission level of the EUT in peak mode was 20dB lower than average limit (that means the emission level in average mode also complies with the limit in average mode), then peak values of EUT will be reported, otherwise, the emissions will be measured in average mode again and reported.

### 3.4.4 Test Setup

For radiated emissions below 30MHz

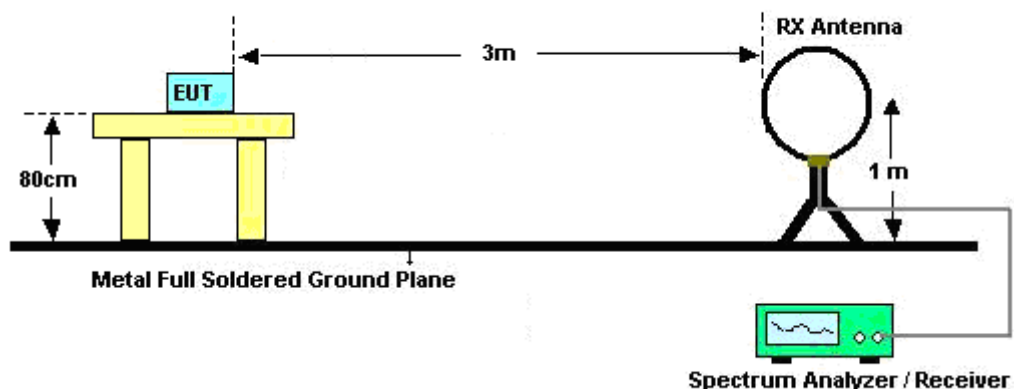



For radiated emissions from 30MHz to 1GHz

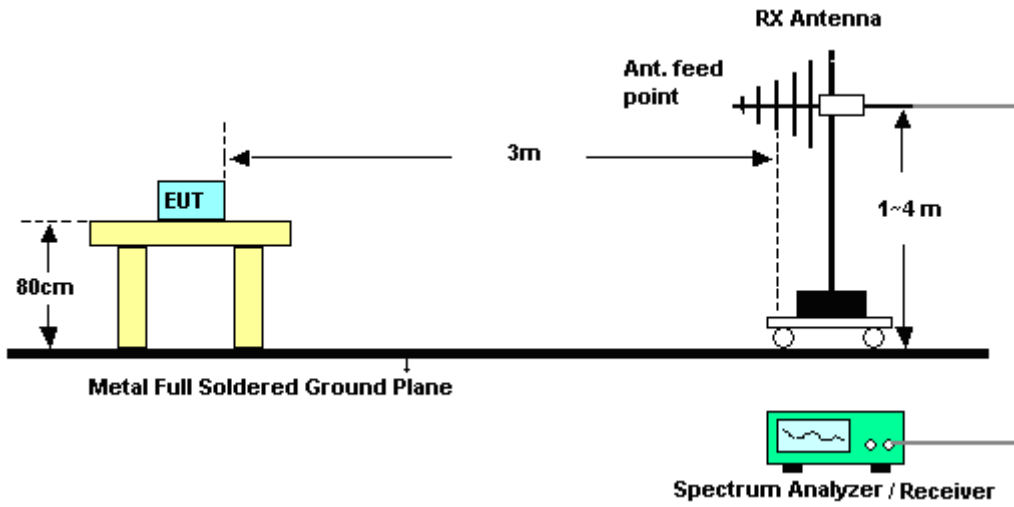

For radiated emissions above 1GHz

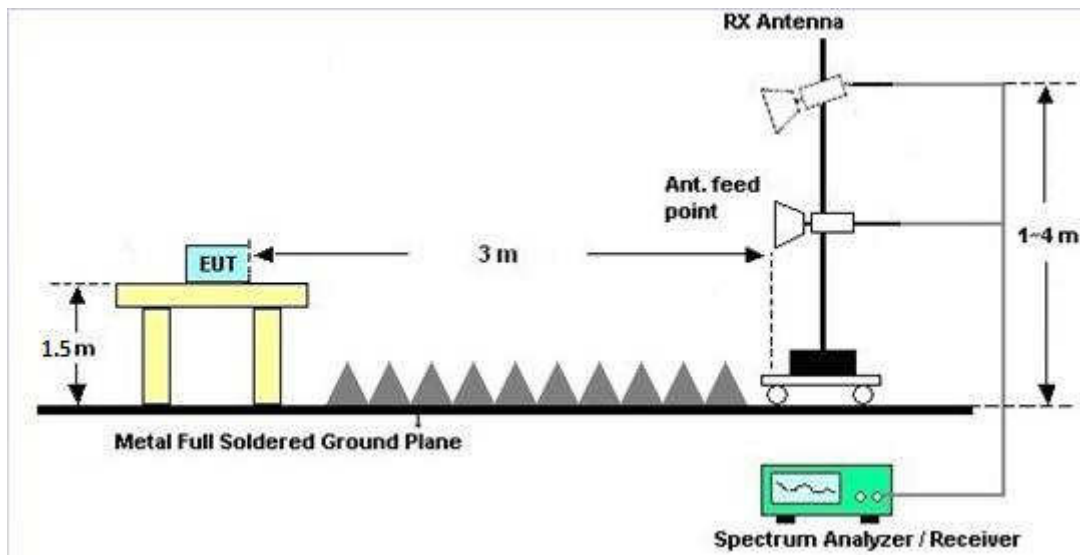



### **3.4.5 Test Results of Radiated Spurious Emissions (9 kHz ~ 30 MHz)**

The low frequency, which started from 9 kHz to 30MHz, was pre-scanned and the result which was 20dB lower than the limit line was not reported.

### **3.4.6 Test Result of Radiated Spurious at Band Edges**

Please refer to Appendix B.

### **3.4.7 Duty Cycle**

Please refer to Appendix C.

### **3.4.8 Test Result of Radiated Spurious Emissions (30MHz ~ 10th Harmonic)**

Please refer to Appendix B.



### 3.5 AC Conducted Emission Measurement

#### 3.5.1 Limit of AC Conducted Emission

For equipment that is designed to be connected to the public utility (AC) power line, the radio frequency voltage that is conducted back onto the AC power line on any frequency or frequencies within the band 150 kHz to 30 MHz shall not exceed the limits in the following table.

Frequency of emission (MHz)	Conducted limit (dBµV)	
	Quasi-peak	Average
0.15-0.5	66 to 56*	56 to 46*
0.5-5	56	46
5-30	60	50

\*Decreases with the logarithm of the frequency.

#### 3.5.2 Measuring Instruments

The measuring equipment is listed in the section 4 of this test report.

#### 3.5.3 Test Procedures

1. The EUT was placed 0.4 meter from the conducting wall of the shielding room was kept at least 80 centimeters from any other grounded conducting surface.
2. Connect EUT to the power mains through a line impedance stabilization network (LISN).
3. All the support units are connecting to the other LISN.
4. The LISN provides 50 ohm coupling impedance for the measuring instrument.
5. The FCC states that a 50 ohm, 50 microhenry LISN should be used.
6. Both sides of AC line were checked for maximum conducted interference.
7. The frequency range from 150 kHz to 30 MHz was searched.
8. Set the test-receiver system to Peak Detect Function and specified bandwidth with Maximum Hold Mode.

### 3.5.4 Test Setup

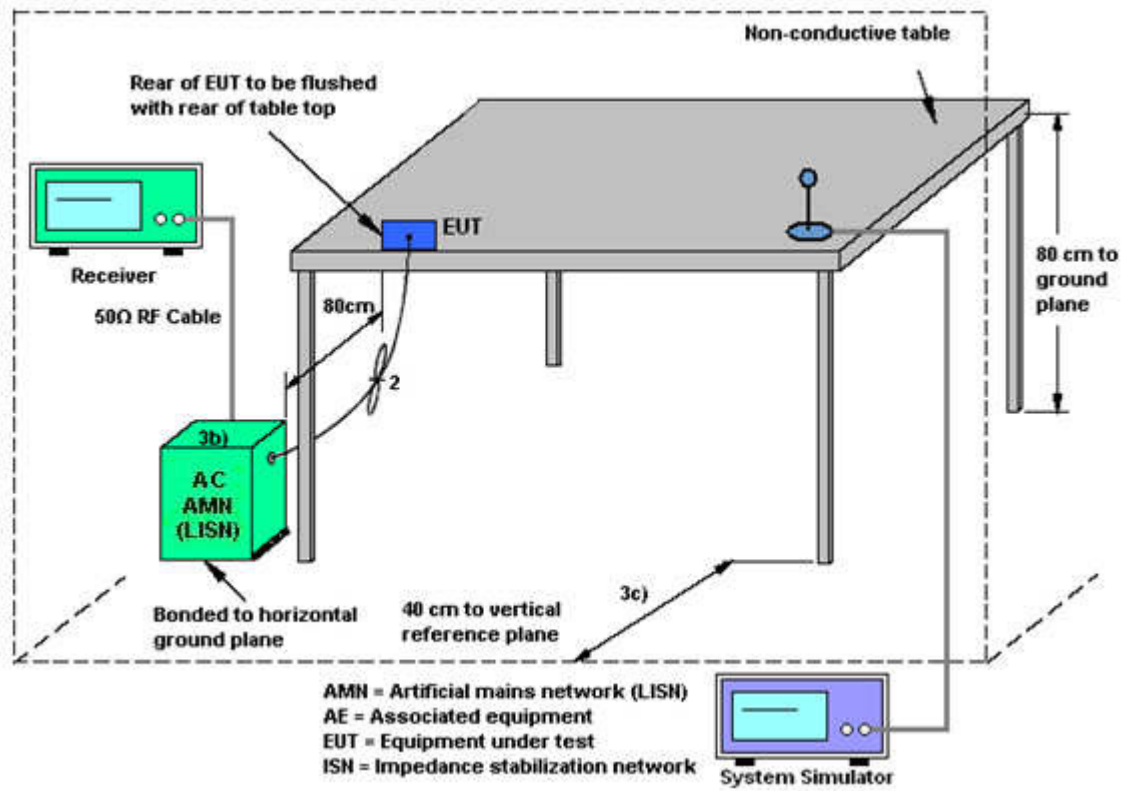



### 3.5.5 Test Result of AC Conducted Emission

Test Mode :	Mode 1	Temperature :	22~24°C
Test Engineer :	Amos Zhang	Relative Humidity :	42~45%
Test Voltage :	120Vac / 60Hz	Phase :	Line
Function Type :	GSM850 Idle + Bluetooth Link + WLAN Link (5G) + USB Cable (Charging from Adapter 1) + Earphone 1		

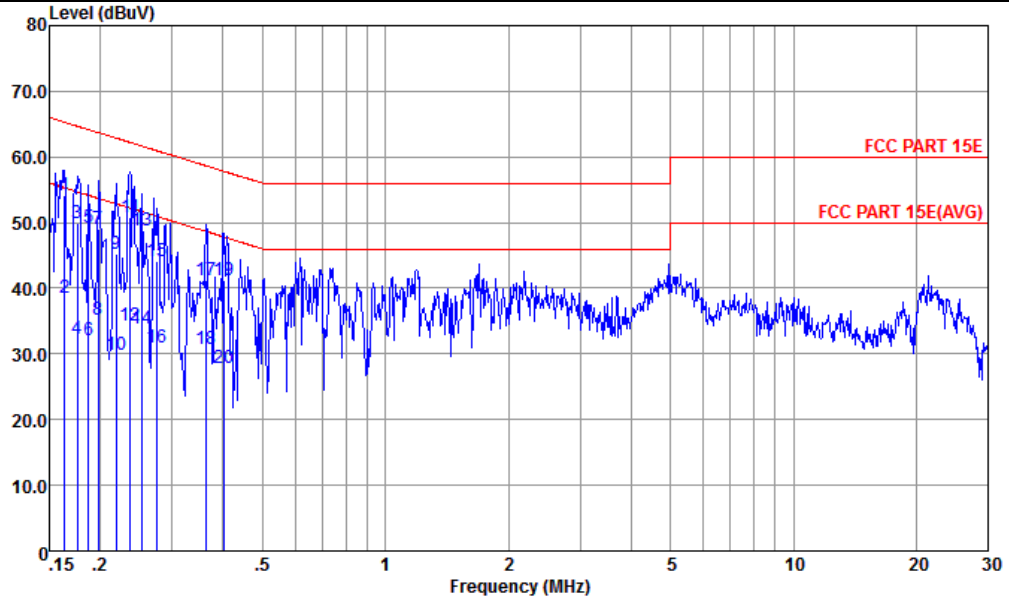

Site : CO01-KS  
 Condition : FCC PART 15E LISN-L-171013-060103 LINE

mode : Mode 1  
 : 351848090015253/351848090015261 #9

	Freq	Level	Over Limit	Limit Line	Read Level	LISN Factor	Cable Loss	Remark
	MHz	dBuV	dB	dBuV	dBuV	dB	dB	
1 *	0.163	54.04	-11.26	65.30	43.30	0.17	10.57	QP
2	0.163	38.54	-16.76	55.30	27.80	0.17	10.57	Average
3	0.176	49.91	-14.77	64.68	39.20	0.18	10.53	QP
4	0.176	32.31	-22.37	54.68	21.60	0.18	10.53	Average
5	0.187	49.28	-14.87	64.15	38.60	0.19	10.49	QP
6	0.187	31.98	-22.17	54.15	21.30	0.19	10.49	Average
7	0.198	48.96	-14.75	63.71	38.30	0.20	10.46	QP
8	0.198	35.16	-18.55	53.71	24.50	0.20	10.46	Average
9	0.219	45.15	-17.73	62.88	34.49	0.21	10.45	QP
10	0.219	29.95	-22.93	52.88	19.29	0.21	10.45	Average
11	0.237	50.85	-11.37	62.22	40.20	0.21	10.44	QP
12	0.237	34.25	-17.97	52.22	23.60	0.21	10.44	Average
13	0.252	48.85	-12.84	61.69	38.19	0.22	10.44	QP
14	0.252	33.95	-17.74	51.69	23.29	0.22	10.44	Average
15	0.276	44.15	-16.79	60.94	33.50	0.22	10.43	QP
16	0.276	30.95	-19.99	50.94	20.30	0.22	10.43	Average
17	0.363	41.25	-17.40	58.65	30.60	0.24	10.41	QP
18	0.363	30.85	-17.80	48.65	20.20	0.24	10.41	Average
19	0.402	41.15	-16.66	57.81	30.50	0.25	10.40	QP
20	0.402	27.95	-19.86	47.81	17.30	0.25	10.40	Average



Test Mode :	Mode 1	Temperature :	22~24°C
Test Engineer :	Amos Zhang	Relative Humidity :	42~45%
Test Voltage :	120Vac / 60Hz	Phase :	Neutral
Function Type :	GSM850 Idle + Bluetooth Link + WLAN Link (5G) + USB Cable (Charging from Adapter 1) + Earphone 1		

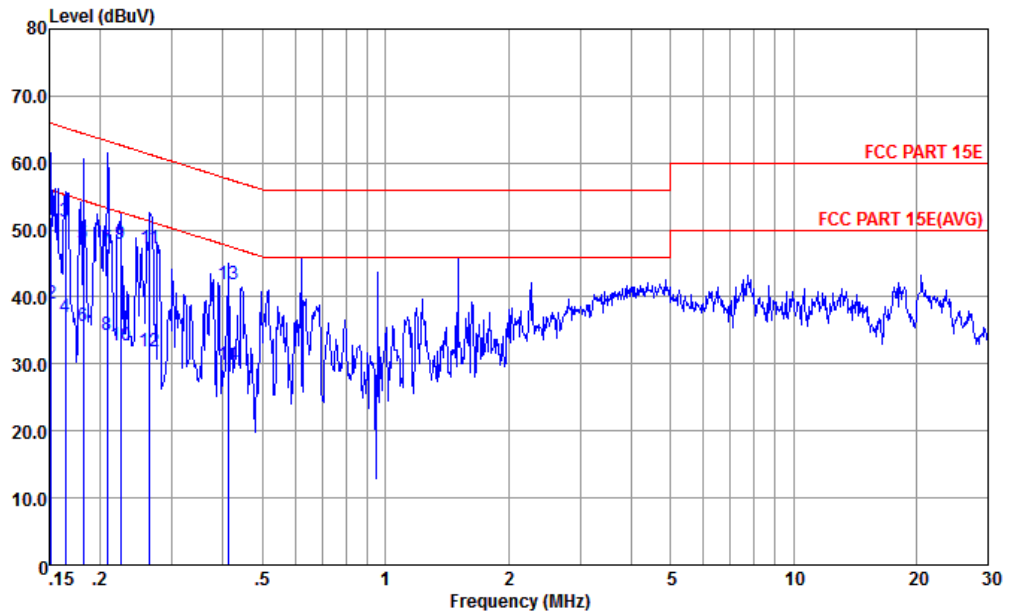

Site : CO01-KS  
 Condition : FCC PART 15E LISN-N-171013-060103 NEUTRAL

mode : Mode 1  
 : 351848090015253/351848090015261 #9

	Freq	Level	Over Limit	Limit Line	Read Level	LISN Factor	Cable Loss	Remark
	MHz	dBuV	dB	dBuV	dBuV	dB	dB	
1 *	0.152	51.99	-13.92	65.91	41.10	0.28	10.61	QP
2	0.152	38.99	-16.92	55.91	28.10	0.28	10.61	Average
3	0.164	51.15	-14.10	65.25	40.30	0.28	10.57	QP
4	0.164	37.05	-18.20	55.25	26.20	0.28	10.57	Average
5	0.182	47.99	-16.43	64.42	37.20	0.28	10.51	QP
6	0.182	35.59	-18.83	54.42	24.80	0.28	10.51	Average
7	0.208	47.33	-15.94	63.27	36.60	0.28	10.45	QP
8	0.208	34.33	-18.94	53.27	23.60	0.28	10.45	Average
9	0.224	47.93	-14.73	62.66	37.20	0.28	10.45	QP
10	0.224	32.83	-19.83	52.66	22.10	0.28	10.45	Average
11	0.264	47.32	-13.97	61.29	36.60	0.28	10.44	QP
12	0.264	31.82	-19.47	51.29	21.10	0.28	10.44	Average
13	0.413	41.88	-15.71	57.59	31.20	0.29	10.39	QP
14	0.413	29.88	-17.71	47.59	19.20	0.29	10.39	Average



## **3.6 Automatically Discontinue Transmission**

### **3.6.1 Limit of Automatically Discontinue Transmission**

The device shall automatically discontinue transmission in case of either absence of information to transmit or operational failure. These provisions are not intended to preclude the transmission of control or signaling information or the use of repetitive codes used by certain digital technologies to complete frame or burst intervals. Applicants shall include in their application for equipment authorization to describe how this requirement is met.

### **3.6.2 Measuring Instruments**

The measuring equipment is listed in the section 4 of this test report.

### **3.6.3 Test Result of Automatically Discontinue Transmission**

While the EUT is not transmitting any information, the EUT can automatically discontinue transmission and become standby mode for power saving. The EUT can detect the controlling signal of ACK message transmitting from remote device and verify whether it shall resend or discontinue transmission.



## **3.7 Antenna Requirements**

### **3.7.1 Standard Applicable**

If transmitting antenna directional gain is greater than 6 dBi, both the peak transmit power and the peak power spectral density shall be reduced by the amount in dB that the directional gain of the antenna exceeds 6 dBi.

### **3.7.2 Antenna Anti-Replacement Construction**

An embedded-in antenna design is used.

### **3.7.3 Antenna Gain**

The antenna gain is less than 6 dBi. Therefore, it is not necessary to reduce maximum peak output power limit.





## 4 List of Measuring Equipments

Instrument	Manufacturer	Model No.	Serial No.	Characteristics	Calibration Date	Test Date	Due Date	Remark
Spectrum Analyzer	R&S	FSV40	101040	10Hz~40GHz	Aug. 08, 2017	Jan. 03, 2018	Aug. 07, 2018	Conducted (TH01-KS)
Pulse Power Sensor	Anritsu	MA2411B	0917070	300MHz~40GHz	Jan. 19, 2017	Jan. 03, 2018	Jan. 18, 2018	Conducted (TH01-KS)
Power Meter	Anritsu	ML2495A	1005002	50MHz Bandwidth	Jan. 19, 2017	Jan. 03, 2018	Jan. 18, 2018	Conducted (TH01-KS)
EMI Test Receiver	Keysight	N9038A	MY56400004	3Hz~8.5GHz; Max 30dBm	Oct. 19, 2017	Feb. 02, 2018	Oct. 18, 2018	Radiation (03CH03-KS)
EXA Spectrum Analyzer	Keysight	N9010A	MY55150244	10Hz~44GHz	Apr. 18, 2017	Feb. 02, 2018	Apr. 17, 2018	Radiation (03CH03-KS)
Loop Antenna	R&S	HFH2-Z2	100321	9kHz~30MHz	Oct. 22, 2017	Feb. 02, 2018	Oct. 21, 2018	Radiation (03CH03-KS)
Bilog Antenna	TeseQ	CBL6112D	35406	25MHz~2GHz	Apr. 22, 2017	Feb. 02, 2018	Apr. 21, 2018	Radiation (03CH03-KS)
Double Ridge Horn Antenna	ETS-Lindgren	3117	75957	1GHz~18GHz	Oct. 21, 2017	Feb. 02, 2018	Oct. 20, 2018	Radiation (03CH03-KS)
SHF-EHF Horn	Schwarzbeck	BBHA 9170	BBHA170249	15GHz~40GHz	Feb. 15, 2017	Feb. 02, 2018	Feb. 14, 2018	Radiation (03CH03-KS)
Amplifier	com-power	PA-103A	161069	1MHz~1000MHz / 32 dB	Apr. 18, 2017	Feb. 02, 2018	Apr. 17, 2018	Radiation (03CH03-KS)
Amplifier	MITEQ	TTA1840-35-HG	1887435	18GHz~40GHz	Oct. 12, 2017	Feb. 02, 2018	Oct. 11, 2018	Radiation (03CH03-KS)
high gain Amplifier	MITEQ	AMF-7D-0010 1800-30-10P	2025788	1GHz~18GHz	Apr. 18, 2017	Feb. 02, 2018	Apr. 17, 2018	Radiation (03CH03-KS)
Amplifier	Agilent	8449B	3008A02370	1GHz~26.5GHz	Oct. 12, 2017	Feb. 02, 2018	Oct. 11, 2018	Radiation (03CH03-KS)
AC Power Source	Chroma	61601	F104090004	N/A	NCR	Feb. 02, 2018	NCR	Radiation (03CH03-KS)
Turn Table	ChamPro	EM 1000-T	060762-T	0~360 degree	NCR	Feb. 02, 2018	NCR	Radiation (03CH03-KS)
Antenna Mast	ChamPro	EM 1000-A	060762-A	1 m~4 m	NCR	Feb. 02, 2018	NCR	Radiation (03CH03-KS)
EMI Receiver	R&S	ESC17	100768	9kHz~7GHz;	Apr. 20, 2017	Feb. 01, 2018	Apr. 19, 2018	Conduction (CO01-KS)
AC LISN	MessTec	AN3016	060103	9kHz~30MHz	Oct. 13, 2017	Feb. 01, 2018	Oct. 12, 2018	Conduction (CO01-KS)
AC LISN (for auxiliary equipment)	MessTec	AN3016	060105	9kHz~30MHz	Oct. 13, 2017	Feb. 01, 2018	Oct. 12, 2018	Conduction (CO01-KS)
AC Power Source	Chroma	61602	ABP0000008 11	AC 0V~300V, 45Hz~1000Hz	Oct. 12, 2017	Feb. 01, 2018	Oct. 11, 2018	Conduction (CO01-KS)

NCR: No Calibration Required



## 5 Uncertainty of Evaluation

### Uncertainty of Conducted Emission Measurement (150kHz ~ 30MHz)

Measuring Uncertainty for a Level of Confidence of 95% ( $U = 2Uc(y)$ )	2.3dB
---	-------

### Uncertainty of Radiated Emission Measurement (30 MHz ~ 1000 MHz)

Measuring Uncertainty for a Level of Confidence of 95% ( $U = 2Uc(y)$ )	4.6dB
---	-------

### Uncertainty of Radiated Emission Measurement (1000 MHz ~ 18000 MHz)

Measuring Uncertainty for a Level of Confidence of 95% ( $U = 2Uc(y)$ )	4.5dB
---	-------



## **Appendix A. Conducted Test Results**

Test Engineer:	Start Xu	Temperature:	21~25	°C
Test Date:	2018/1/3	Relative Humidity:	51~54	%

**TEST RESULTS DATA**  
**26dB and 99% OBW**

Band I										
Mod.	Data Rate	NTX	CH.	Freq. (MHz)	99% Bandwidth (MHz)	26 dB Bandwidth (MHz)	IC 99% Bandwidth Power Limit (dBm)	IC 99% Bandwidth EIRP Limit (dBm)		
11a	6Mbps	1	36	5180	19.48	28.82	-	22.90		
11a	6Mbps	1	44	5220	28.22	44.11	-	23.01		
11a	6Mbps	1	48	5240	25.27	42.91	-	23.01		
HT20	MCS0	1	36	5180	19.63	25.82	-	22.93		
HT20	MCS0	1	44	5220	29.72	45.50	-	23.01		
HT20	MCS0	1	48	5240	29.52	46.10	-	23.01		
HT40	MCS0	1	38	5190	37.16	44.96	-	23.01		
HT40	MCS0	1	46	5230	42.46	65.90	-	23.01		

**TEST RESULTS DATA**  
**Average Power Table**

FCC Band I										
Mod.	Data Rate	NTX	CH.	Freq. (MHz)	Duty Factor (dB)	Average Conducted Power (dBm)	FCC Conducted Power Limit (dBm)	DG (dBi)		Pass/Fail
11a	6Mbps	1	36	5180	0.58	12.94	24.00	-0.71		Pass
11a	6Mbps	1	44	5220	0.58	15.04	24.00	-0.71		Pass
11a	6Mbps	1	48	5240	0.58	14.77	24.00	-0.71		Pass
HT20	MCS0	1	36	5180	0.63	11.92	24.00	-0.71		Pass
HT20	MCS0	1	44	5220	0.63	15.05	24.00	-0.71		Pass
HT20	MCS0	1	48	5240	0.63	14.94	24.00	-0.71		Pass
HT40	MCS0	1	38	5190	0.65	10.86	24.00	-0.71		Pass
HT40	MCS0	1	46	5230	0.65	14.07	24.00	-0.71		Pass

**TEST RESULTS DATA**  
**Power Spectral Density**

FCC Band I										
Mod.	Data Rate	NTX	CH.	Freq. (MHz)	Duty Factor (dB)	Average Power Density (dBm/MHz)	Average PSD Limit (dBm/MHz)	DG (dBi)	-	Pass/Fail
11a	6Mbps	1	36	5180	0.58	1.97	11.00	-0.71		Pass
11a	6Mbps	1	44	5220	0.58	2.71	11.00	-0.71		Pass
11a	6Mbps	1	48	5240	0.58	2.41	11.00	-0.71		Pass
HT20	MCS0	1	36	5180	0.63	0.48	11.00	-0.71		Pass
HT20	MCS0	1	44	5220	0.63	2.40	11.00	-0.71		Pass
HT20	MCS0	1	48	5240	0.63	2.09	11.00	-0.71		Pass
HT40	MCS0	1	38	5190	0.65	-3.66	11.00	-0.71		Pass
HT40	MCS0	1	46	5230	0.65	-1.37	11.00	-0.71		Pass

**TEST RESULTS DATA**  
**26dB and 99% OBW**

Band II										
Mod.	Data Rate	NTX	CH.	Freq. (MHz)	99% Bandwidth (MHz)	26 dB Bandwidth (MHz)	IC 99% Bandwidth Power Limit (dBm)	IC 99% Bandwidth EIRP Limit (dBm)	FCC 26dB Bandwidth Power Limit (dBm)	Note
11a	6M bps	1	52	5260	24.88	42.26	23.98	30.00	23.98	
11a	6M bps	1	60	5300	27.12	44.21	23.98	30.00	23.98	
11a	6M bps	1	64	5320	23.98	41.16	23.98	30.00	23.98	
HT20	MCS 0	1	52	5260	27.62	46.35	23.98	30.00	23.98	
HT20	MCS 0	1	60	5300	27.52	45.36	23.98	30.00	23.98	
HT20	MCS 0	1	64	5320	27.37	45.90	23.98	30.00	23.98	
HT40	MCS 0	1	54	5270	40.56	67.70	23.98	30.00	23.98	
HT40	MCS 0	1	62	5310	36.86	44.96	23.98	30.00	23.98	



**TEST RESULTS DATA**  
**Average Power Table**

FCC Band II										
Mod.	Data Rate	NTX	CH.	Freq. (MHz)	Duty Factor (dB)	Average Conducted Power (dBm)	FCC Conducted Power Limit (dBm)	DG (dBi)	EIRP Power Limit (dBm)	Pass/Fail
11a	6M bps	1	52	5260	0.58	14.97	23.98	0.47	26.99	Pass
11a	6M bps	1	60	5300	0.58	14.46	23.98	0.47	26.99	Pass
11a	6M bps	1	64	5320	0.58	13.96	23.98	0.47	26.99	Pass
HT20	MCS 0	1	52	5260	0.63	14.92	23.98	0.47	26.99	Pass
HT20	MCS 0	1	60	5300	0.63	14.52	23.98	0.47	26.99	Pass
HT20	MCS 0	1	64	5320	0.63	14.45	23.98	0.47	26.99	Pass
HT40	MCS 0	1	54	5270	0.65	13.96	23.98	0.47	26.99	Pass
HT40	MCS 0	1	62	5310	0.65	9.71	23.98	0.47	26.99	Pass

**TEST RESULTS DATA**  
**Power Spectral Density**

Band II										
Mod.	Data Rate	NTX	CH.	Freq. (MHz)	Duty Factor (dB)	Average Power Density (dBm/MHz)	Average PSD Limit (dBm/MHz)	DG (dBi)		Pass/Fail
11a	6M bps	1	52	5260	0.58	2.29	11.00	0.47		Pass
11a	6M bps	1	60	5300	0.58	1.89	11.00	0.47		Pass
11a	6M bps	1	64	5320	0.58	2.62	11.00	0.47		Pass
HT20	MCS 0	1	52	5260	0.63	2.14	11.00	0.47		Pass
HT20	MCS 0	1	60	5300	0.63	1.72	11.00	0.47		Pass
HT20	MCS 0	1	64	5320	0.63	1.76	11.00	0.47		Pass
HT40	MCS 0	1	54	5270	0.65	-1.50	11.00	0.47		Pass
HT40	MCS 0	1	62	5310	0.65	-4.60	11.00	0.47		Pass

**TEST RESULTS DATA**  
**26dB and 99% OBW**

Band III										
Mod.	Data Rate	NTX	CH.	Freq. (MHz)	99% Bandwidth (MHz)	26 dB Bandwidth (MHz)	IC 99% Bandwidth Power Limit (dBm)	IC 99% Bandwidth EIRP Limit (dBm)	FCC 26dB Bandwidth Power Limit (dBm)	Note
11a	6M bps	1	100	5500	23.08	40.01	23.98	30.00	23.98	
11a	6M bps	1	116	5580	21.83	41.41	23.98	30.00	23.98	
11a	6M bps	1	140	5700	18.88	24.68	23.76	29.76	23.98	
HT20	MCS 0	1	100	5500	24.23	42.46	23.98	30.00	23.98	
HT20	MCS 0	1	116	5580	23.88	42.36	23.98	30.00	23.98	
HT20	MCS 0	1	140	5700	20.08	24.43	23.98	30.00	23.98	
HT40	MCS 0	1	102	5510	37.56	47.83	23.98	30.00	23.98	
HT40	MCS 0	1	110	5550	38.26	58.44	23.98	30.00	23.98	
HT40	MCS 0	1	134	5670	38.06	51.61	23.98	30.00	23.98	

**TEST RESULTS DATA**  
**Average Power Table**

FCC Band III										
Mod.	Data Rate	NTX	CH.	Freq. (MHz)	Duty Factor (dB)	Average Conducted Power (dBm)	FCC Conducted Power Limit (dBm)	DG (dBi)	EIRP Power Limit (dBm)	Pass/Fail
11a	6M bps	1	100	5500	0.58	14.77	23.98	0.47	26.99	Pass
11a	6M bps	1	116	5580	0.58	14.86	23.98	0.47	26.99	Pass
11a	6M bps	1	140	5700	0.58	12.13	23.98	0.47	26.99	Pass
HT20	MCS 0	1	100	5500	0.63	14.86	23.98	0.47	26.99	Pass
HT20	MCS 0	1	116	5580	0.63	14.92	23.98	0.47	26.99	Pass
HT20	MCS 0	1	140	5700	0.63	11.78	23.98	0.47	26.99	Pass
HT40	MCS 0	1	102	5510	0.65	11.63	23.98	0.47	26.99	Pass
HT40	MCS 0	1	110	5550	0.65	13.87	23.98	0.47	26.99	Pass
HT40	MCS 0	1	134	5670	0.65	13.57	23.98	0.47	26.99	Pass

**TEST RESULTS DATA**  
**Power Spectral Density**

Band III										
Mod.	Data Rate	NTX	CH.	Freq. (MHz)	Duty Factor (dB)	Average Power Density (dBm/MHz)	Average PSD Limit (dBm/MHz)	DG (dBi)		Pass/Fail
11a	6M bps	1	100	5500	0.58	2.35	11.00	0.47		Pass
11a	6M bps	1	116	5580	0.58	2.61	11.00	0.47		Pass
11a	6M bps	1	140	5700	0.58	1.23	11.00	0.47		Pass
HT20	MCS 0	1	100	5500	0.63	2.45	11.00	0.47		Pass
HT20	MCS 0	1	116	5580	0.63	2.25	11.00	0.47		Pass
HT20	MCS 0	1	140	5700	0.63	0.14	11.00	0.47		Pass
HT40	MCS 0	1	102	5510	0.65	-3.00	11.00	0.47		Pass
HT40	MCS 0	1	110	5550	0.65	-1.55	11.00	0.47		Pass
HT40	MCS 0	1	134	5670	0.65	-0.91	11.00	0.47		Pass



## Appendix B. Radiated Spurious Emission

### Band 1 - 5150~5250MHz WIFI 802.11a (Band Edge @ 3m)

WIFI	Note	Frequency	Level	Over Limit	Limit Line	Read Level	Antenna Factor	Cable Loss	Preamp Factor	Ant Pos	Table Pos	Peak Avg.	Pol.
		( MHz )	( dBμV/m )	( dB )	( dBμV/m )	( dBμV )	( dB/m )	( dB )	( dB )	( cm )	( deg )	( P/A )	( H/V )
802.11a CH 36 5180MHz		5148.32	63.55	-10.45	74	53.21	35.16	11.88	36.7	396	352	P	H
	!	5149.99	50.2	-3.8	54	39.86	35.16	11.88	36.7	396	352	A	H
	*	5174	101.01	-	-	90.59	35.18	11.93	36.69	396	352	P	H
	*	5174	93.87	-	-	83.45	35.18	11.93	36.69	396	352	A	H
		5147.52	58.27	-15.73	74	47.93	35.16	11.88	36.7	299	2	P	V
		5149.99	46.34	-7.66	54	36	35.16	11.88	36.7	299	2	A	V
	*	5176	95.03	-	-	84.61	35.18	11.93	36.69	299	2	P	V
	*	5176	88.79	-	-	78.37	35.18	11.93	36.69	299	2	A	V
802.11a CH 44 5220MHz		5128.16	53.16	-20.84	74	42.84	35.16	11.86	36.7	389	351	P	H
		5149.92	43.58	-10.42	54	33.24	35.16	11.88	36.7	389	351	A	H
	*	5214	102.15	-	-	91.67	35.2	11.97	36.69	389	351	P	H
	*	5214	94.6	-	-	84.12	35.2	11.97	36.69	389	351	A	H
		5387.22	52.01	-21.99	74	41.25	35.28	12.17	36.69	389	351	P	H
		5387.58	42.86	-11.14	54	32.1	35.28	12.17	36.69	389	351	A	H
		5116.96	53.15	-20.85	74	42.86	35.15	11.84	36.7	383	136	P	V
		5100.64	43.48	-10.52	54	33.22	35.14	11.82	36.7	383	136	A	V
	*	5214	98.95	-	-	88.47	35.2	11.97	36.69	383	136	P	V
	*	5214	92.02	-	-	81.54	35.2	11.97	36.69	383	136	A	V
		5392.98	53.28	-20.72	74	42.52	35.28	12.17	36.69	383	136	P	V
	5389.38	42.97	-11.03	54	32.21	35.28	12.17	36.69	383	136	A	V	



802.11a CH 48 5240MHz	*	5246	101	-	-	90.47	35.21	12.01	36.69	399	359	P	H
	*	5246	93.8	-	-	83.27	35.21	12.01	36.69	399	359	A	H
		5364.9	52.15	-21.85	74	41.42	35.27	12.15	36.69	399	359	P	H
		5389.02	43.06	-10.94	54	32.3	35.28	12.17	36.69	399	359	A	H
	*	5246	98.79	-	-	88.26	35.21	12.01	36.69	397	2	P	V
	*	5246	91.2	-	-	80.67	35.21	12.01	36.69	397	2	A	V
		5387.94	53.33	-20.67	74	42.57	35.28	12.17	36.69	397	2	P	V
		5395.14	43.06	-10.94	54	32.27	35.29	12.19	36.69	397	2	A	V
Remark	<ol style="list-style-type: none"> <li>No other spurious found.</li> <li>All results are PASS against Peak and Average limit line.</li> </ol>												



Band 1 5150~5250MHz

WIFI 802.11a (Harmonic @ 3m)

WIFI	Note	Frequency ( MHz )	Level ( dBμV/m )	Over Limit ( dB )	Limit Line ( dBμV/m )	Read Level (dBμV)	Antenna Factor ( dB/m )	Cable Loss ( dB )	Preamp Factor ( dB )	Ant Pos ( cm )	Table Pos ( deg )	Peak Avg. (P/A)	Pol. (H/V)
802.11a CH 36 5180MHz		10360	44.97	-29.03	74	57.22	38.25	15.65	66.15	300	360	P	H
		10360	44.98	-29.02	74	57.23	38.25	15.65	66.15	300	360	P	V
802.11a CH 44 5220MHz		10440	45.93	-28.07	74	58.07	38.28	15.68	66.1	300	360	P	H
		10440	45.06	-28.94	74	57.2	38.28	15.68	66.1	300	360	P	V
802.11a CH 48 5240MHz		10480	46.99	-27.01	74	59.06	38.3	15.7	66.07	300	360	P	H
		10480	46.29	-27.71	74	58.36	38.3	15.7	66.07	300	360	P	V
<b>Remark</b>	1. No other spurious found. 2. All results are PASS against Peak and Average limit line.												





**Band 1 5150~5250MHz**  
**WIFI 802.11n HT20 (Band Edge @ 3m)**

WIFI	Note	Frequency ( MHz )	Level ( dBμV/m )	Over Limit ( dB )	Limit Line ( dBμV/m )	Read Level ( dBμV )	Antenna Factor ( dB/m )	Cable Loss ( dB )	Preamp Factor ( dB )	Ant Pos ( cm )	Table Pos ( deg )	Peak Avg. ( P/A )	Pol. ( H/V )
802.11n HT20 CH 36 5180MHz		5148.8	62	-12	74	51.66	35.16	11.88	36.7	100	355	P	H
	!	5149.76	49.5	-4.5	54	39.16	35.16	11.88	36.7	100	355	A	H
	*	5174	101.45	-	-	91.03	35.18	11.93	36.69	100	355	P	H
	*	5174	93.81	-	-	83.39	35.18	11.93	36.69	100	355	A	H
		5148.48	60.33	-13.67	74	49.99	35.16	11.88	36.7	306	141	P	V
		5149.92	47.52	-6.48	54	37.18	35.16	11.88	36.7	306	141	A	V
	*	5176	98.43	-	-	88.01	35.18	11.93	36.69	306	141	P	V
	5176	90.79	-	-	80.37	35.18	11.93	36.69	306	141	A	V	
802.11n HT20 CH 44 5220MHz		5101.6	53.61	-20.39	74	43.35	35.14	11.82	36.7	100	360	P	H
		5148.32	44.68	-9.32	54	34.34	35.16	11.88	36.7	100	360	A	H
	*	5226	102.48	-	-	91.97	35.21	11.99	36.69	100	360	P	H
	*	5226	95.59	-	-	85.08	35.21	11.99	36.69	100	360	A	H
		5381.64	52.58	-21.42	74	41.82	35.28	12.17	36.69	100	360	P	H
		5397.48	43.43	-10.57	54	32.64	35.29	12.19	36.69	100	360	A	H
		5147.68	54.13	-19.87	74	43.79	35.16	11.88	36.7	300	144	P	V
		5149.44	44.13	-9.87	54	33.79	35.16	11.88	36.7	300	144	A	V
	*	5214	99.88	-	-	89.4	35.2	11.97	36.69	300	144	P	V
	*	5214	93.2	-	-	82.72	35.2	11.97	36.69	300	144	A	V
		5353.92	52.55	-21.45	74	41.85	35.26	12.13	36.69	300	144	P	V
	5384.7	43.24	-10.76	54	32.48	35.28	12.17	36.69	300	144	A	V	



802.11n HT20 CH 48 5240MHz	*	5234	103.23	-	-	92.72	35.21	11.99	36.69	100	353	P	H
	*	5234	95.7	-	-	85.19	35.21	11.99	36.69	100	353	A	H
		5380.92	52.24	-21.76	74	41.48	35.28	12.17	36.69	100	353	P	H
		5384.52	43.5	-10.5	54	32.74	35.28	12.17	36.69	100	353	A	H
	*	5232	100.19	-	-	89.68	35.21	11.99	36.69	331	347	P	V
	*	5232	92.47	-	-	81.96	35.21	11.99	36.69	331	347	A	V
		5396.58	52.14	-21.86	74	41.35	35.29	12.19	36.69	331	347	P	V
		5391.9	43.31	-10.69	54	32.55	35.28	12.17	36.69	331	347	A	V

**Remark**

- No other spurious found.
- All results are PASS against Peak and Average limit line.



**Band 1 5150~5250MHz**  
**WIFI 802.11n HT20 (Harmonic @ 3m)**

WIFI	Note	Frequency ( MHz )	Level ( dBμV/m )	Over Limit ( dB )	Limit Line ( dBμV/m )	Read Level (dBμV)	Antenna Factor ( dB/m )	Cable Loss ( dB )	Preamp Factor ( dB )	Ant Pos ( cm )	Table Pos ( deg )	Peak Avg. (P/A)	Pol. (H/V)
802.11n HT20 CH 36 5180MHz		10360	43.12	-30.88	74	55.37	38.25	15.65	66.15	100	360	P	H
		10360	42.2	-31.8	74	54.45	38.25	15.65	66.15	100	360	P	V
802.11n HT20 CH 44 5220MHz		10440	43.96	-30.04	74	56.1	38.28	15.68	66.1	100	360	P	H
		10440	42.79	-31.21	74	54.93	38.28	15.68	66.1	100	360	P	V
802.11n HT20 CH 48 5240MHz		10480	43.93	-30.07	74	56	38.3	15.7	66.07	100	360	P	H
		10480	43.87	-30.13	74	55.94	38.3	15.7	66.07	100	360	P	V
<b>Remark</b>	1. No other spurious found. 2. All results are PASS against Peak and Average limit line.												



**Band 1 5150~5250MHz**  
**WIFI 802.11n HT40 (Band Edge @ 3m)**

WIFI	Note	Frequency ( MHz )	Level ( dBμV/m )	Over Limit ( dB )	Limit Line ( dBμV/m )	Read Level ( dBμV )	Antenna Factor ( dB/m )	Cable Loss ( dB )	Preamp Factor ( dB )	Ant Pos ( cm )	Table Pos ( deg )	Peak Avg. ( P/A )	Pol. ( H/V )
802.11n HT40 CH 38 5190MHz		5149.28	61.29	-12.71	74	50.95	35.16	11.88	36.7	300	23	P	H
	!	5149.99	50.9	-3.1	54	40.56	35.16	11.88	36.7	300	23	A	H
	*	5182	94.7	-	-	84.28	35.18	11.93	36.69	300	23	P	H
	*	5182	87.56	-	-	77.14	35.18	11.93	36.69	300	23	A	H
		5377.68	52.02	-21.98	74	41.26	35.28	12.17	36.69	300	23	P	H
		5394.78	42.59	-11.41	54	31.8	35.29	12.19	36.69	300	23	A	H
		5148.16	60.89	-13.11	74	50.55	35.16	11.88	36.7	300	146	P	V
	!	5149.99	49.38	-4.62	54	39.04	35.16	11.88	36.7	300	146	A	V
	*	5180	92.26	-	-	81.84	35.18	11.93	36.69	300	146	P	V
	*	5180	85.2	-	-	74.78	35.18	11.93	36.69	300	146	A	V
	5365.44	51.59	-22.41	74	40.86	35.27	12.15	36.69	300	146	P	V	
	5388.48	42.59	-11.41	54	31.83	35.28	12.17	36.69	300	146	A	V	
802.11n HT40 CH 46 5230MHz		5149.28	56.67	-17.33	74	46.33	35.16	11.88	36.7	100	360	P	H
		5149.12	46.15	-7.85	54	35.81	35.16	11.88	36.7	100	360	A	H
	*	5226	98.28	-	-	87.77	35.21	11.99	36.69	100	360	P	H
	*	5226	90.57	-	-	80.06	35.21	11.99	36.69	100	360	A	H
		5397.48	52.94	-21.06	74	42.15	35.29	12.19	36.69	100	360	P	H
		5395.86	42.61	-11.39	54	31.82	35.29	12.19	36.69	100	360	A	H
		5140.96	54.87	-19.13	74	44.53	35.16	11.88	36.7	298	141	P	V
		5148.64	44.82	-9.18	54	34.48	35.16	11.88	36.7	298	141	A	V
	*	5226	94.4	-	-	83.89	35.21	11.99	36.69	298	141	P	V
	*	5226	87.15	-	-	76.64	35.21	11.99	36.69	298	141	A	V
	5397.12	52.6	-21.4	74	41.81	35.29	12.19	36.69	298	141	P	V	
	5392.26	42.56	-11.44	54	31.8	35.28	12.17	36.69	298	141	A	V	
<b>Remark</b>	1. No other spurious found. 2. All results are PASS against Peak and Average limit line.												



Band 1 5150~5250MHz
WIFI 802.11n HT40 (Harmonic @ 3m)

Table with 14 columns: WIFI, Note, Frequency (MHz), Level (dBµV/m), Over Limit (dB), Limit Line (dBµV/m), Read Level (dBµV), Antenna Factor (dB/m), Cable Loss (dB), Preamp Factor (dB), Ant Pos (cm), Table Pos (deg), Peak Avg. (P/A), Pol. (H/V). Rows include data for 802.11n HT40 CH 38 (5190MHz) and 802.11n HT40 CH 46 (5230MHz). A Remark section at the bottom states: '1. No other spurious found. 2. All results are PASS against Peak and Average limit line.'



Band 2 - 5250~5350MHz
WIFI 802.11a (Band Edge @ 3m)

Table with 14 columns: WIFI, Note, Frequency, Level, Over Limit, Limit Line, Read Level, Antenna Factor, Cable Loss, Preamp Factor, Ant Pos, Table Pos, Peak Avg, Pol. (H/V). Rows include data for 802.11a CH 52 (5260MHz) and 802.11a CH 60 (5300MHz).



<b>802.11a</b> <b>CH 64</b> <b>5320MHz</b>	*	5316	98.39	-	-	87.74	35.25	12.09	36.69	388	353	P	H
	*	5316	90.29	-	-	79.64	35.25	12.09	36.69	388	353	A	H
		5352.2	63.99	-10.01	74	53.29	35.26	12.13	36.69	388	353	P	H
	!	5350.1	50.53	-3.47	54	39.83	35.26	12.13	36.69	388	353	A	H
	*	5326	95.94	-	-	85.29	35.25	12.09	36.69	294	12	P	V
	*	5326	89.44	-	-	78.79	35.25	12.09	36.69	294	12	A	V
		5356	60.14	-13.86	74	49.44	35.26	12.13	36.69	294	12	P	V
		5350.01	47.25	-6.75	54	36.55	35.26	12.13	36.69	294	12	A	V
<b>Remark</b>	1. No other spurious found. 2. All results are PASS against Peak and Average limit line.												



Band 2 5250~5350MHz

WIFI 802.11a (Harmonic @ 3m)

WIFI	Note	Frequency ( MHz )	Level ( dBμV/m )	Over Limit ( dB )	Limit Line ( dBμV/m )	Read Level (dBμV)	Antenna Factor ( dB/m )	Cable Loss ( dB )	Preamp Factor ( dB )	Ant Pos ( cm )	Table Pos ( deg )	Peak Avg. (P/A)	Pol. (H/V)
802.11a CH 52 5260MHz		10520	46.52	-27.48	74	58.53	38.31	15.72	66.04	299	360	P	H
		10520	43.92	-30.08	74	55.93	38.31	15.72	66.04	299	360	P	V
802.11a CH 60 5300MHz		10600	47.4	-26.6	74	59.29	38.34	15.75	65.98	300	360	P	H
		10600	44.95	-29.05	74	56.84	38.34	15.75	65.98	300	360	P	V
802.11a CH 64 5320MHz		10640	47.8	-26.2	74	59.63	38.36	15.77	65.96	300	360	P	H
		10640	45.7	-28.3	74	57.53	38.36	15.77	65.96	300	360	P	V
<b>Remark</b>	1. No other spurious found. 2. All results are PASS against Peak and Average limit line.												





Band 2 5250~5350MHz
WIFI 802.11n HT20 (Band Edge @ 3m)

Table with 14 columns: WIFI, Note, Frequency (MHz), Level (dBµV/m), Over Limit (dB), Limit Line (dBµV/m), Read Level (dBµV), Antenna Factor (dB/m), Cable Loss (dB), Preamp Factor (dB), Ant Pos (cm), Table Pos (deg), Peak Avg. (P/A), Pol. (H/V). Rows include data for 802.11n HT20 CH 52 (5260MHz) and 802.11n HT20 CH 60 (5300MHz).



802.11n HT20 CH 64 5320MHz	*	5314	99.56	-	-	88.91	35.25	12.09	36.69	332	347	P	H
	*	5314	92.64	-	-	81.99	35.25	12.09	36.69	332	347	A	H
		5351.4	65.12	-8.88	74	54.42	35.26	12.13	36.69	332	347	P	H
	!	5350.5	50.74	-3.26	54	40.04	35.26	12.13	36.69	332	347	A	H
	*	5322	96.24	-	-	85.59	35.25	12.09	36.69	397	342	P	V
	*	5322	89.53	-	-	78.88	35.25	12.09	36.69	397	342	A	V
		5352.8	60.55	-13.45	74	49.85	35.26	12.13	36.69	397	342	P	V
	!	5350.1	48.76	-5.24	54	38.06	35.26	12.13	36.69	397	342	A	V
Remark	<ol style="list-style-type: none"> <li>No other spurious found.</li> <li>All results are PASS against Peak and Average limit line.</li> </ol>												



**Band 2 5250~5350MHz**  
**WIFI 802.11n HT20 (Harmonic @ 3m)**

WIFI	Note	Frequency ( MHz )	Level ( dBμV/m )	Over Limit ( dB )	Limit Line ( dBμV/m )	Read Level (dBμV)	Antenna Factor ( dB/m )	Cable Loss ( dB )	Preamp Factor ( dB )	Ant Pos ( cm )	Table Pos ( deg )	Peak Avg. (P/A)	Pol. (H/V)
802.11n HT20 CH 52 5260MHz		10520	42.78	-31.22	74	54.79	38.31	15.72	66.04	100	360	P	H
		10520	42.46	-31.54	74	54.47	38.31	15.72	66.04	100	360	P	V
802.11n HT20 CH 60 5300MHz		10600	41.88	-32.12	74	53.77	38.34	15.75	65.98	100	360	P	H
		10600	42.27	-31.73	74	54.16	38.34	15.75	65.98	100	360	P	V
802.11n HT20 CH 64 5320MHz		10640	42.15	-31.85	74	53.98	38.36	15.77	65.96	300	360	P	H
		10640	43.44	-30.56	74	55.27	38.36	15.77	65.96	300	360	P	V
<b>Remark</b>	1. No other spurious found. 2. All results are PASS against Peak and Average limit line.												



**Band 2 5250~5350MHz**  
**WIFI 802.11n HT40 (Band Edge @ 3m)**

WIFI	Note	Frequency ( MHz )	Level ( dBμV/m )	Over Limit ( dB )	Limit Line ( dBμV/m )	Read Level ( dBμV )	Antenna Factor ( dB/m )	Cable Loss ( dB )	Preamp Factor ( dB )	Ant Pos ( cm )	Table Pos ( deg )	Peak Avg. ( P/A )	Pol. ( H/V )
802.11n HT40 CH 54 5270MHz		5136.16	52.79	-21.21	74	42.47	35.16	11.86	36.7	100	360	P	H
		5100.64	43.59	-10.41	54	33.33	35.14	11.82	36.7	100	360	A	H
	*	5260	97.64	-	-	87.08	35.22	12.03	36.69	100	360	P	H
	*	5260	90.32	-	-	79.76	35.22	12.03	36.69	100	360	A	H
		5353.6	53.47	-20.53	74	42.77	35.26	12.13	36.69	100	360	P	H
		5350.3	43.5	-10.5	54	32.8	35.26	12.13	36.69	100	360	A	H
		5128.8	53.21	-20.79	74	42.89	35.16	11.86	36.7	300	167	P	V
		5113.6	43.43	-10.57	54	33.14	35.15	11.84	36.7	300	167	A	V
	*	5258	93.37	-	-	82.84	35.21	12.01	36.69	300	167	P	V
	*	5258	85.76	-	-	75.23	35.21	12.01	36.69	300	167	A	V
		5386	52.89	-21.11	74	42.13	35.28	12.17	36.69	300	167	P	V
		5388.9	42.95	-11.05	54	32.19	35.28	12.17	36.69	300	167	A	V
802.11n HT40 CH 62 5310MHz		5124.96	53.5	-20.5	74	43.18	35.16	11.86	36.7	100	0	P	H
		5104.64	43.53	-10.47	54	33.27	35.14	11.82	36.7	100	0	A	H
	*	5306	92.59	-	-	81.97	35.24	12.07	36.69	100	0	P	H
	*	5306	85.55	-	-	74.93	35.24	12.07	36.69	100	0	A	H
		5351.3	60.29	-13.71	74	49.59	35.26	12.13	36.69	100	0	P	H
	!	5350.5	50.32	-3.68	54	39.62	35.26	12.13	36.69	100	0	A	H
		5126.08	52.83	-21.17	74	42.51	35.16	11.86	36.7	300	146	P	V
		5104.64	43.43	-10.57	54	33.17	35.14	11.82	36.7	300	146	A	V
	*	5296	87.79	-	-	77.17	35.24	12.07	36.69	300	146	P	V
	*	5296	80.77	-	-	70.15	35.24	12.07	36.69	300	146	A	V
	5352	55.98	-18.02	74	45.28	35.26	12.13	36.69	300	146	P	V	
	5350.2	46.2	-7.8	54	35.5	35.26	12.13	36.69	300	146	A	V	
<b>Remark</b>	1. No other spurious found. 2. All results are PASS against Peak and Average limit line.												



Band 2 5250~5350MHz
WIFI 802.11n HT40 (Harmonic @ 3m)

Table with 14 columns: WIFI, Note, Frequency (MHz), Level (dBµV/m), Over Limit (dB), Limit Line (dBµV/m), Read Level (dBµV), Antenna Factor (dB/m), Cable Loss (dB), Preamp Factor (dB), Ant Pos (cm), Table Pos (deg), Peak Avg. (P/A), Pol. (H/V). Rows include data for 802.11n HT40 CH 54 at 10540MHz and 802.11n HT40 CH 62 at 10620MHz. A Remark section at the bottom states: '1. No other spurious found. 2. All results are PASS against Peak and Average limit line.'



**Band 3 - 5470~5725MHz**  
**WIFI 802.11a (Band Edge @ 3m)**

WIFI	Note	Frequency	Level	Over	Limit	Read	Antenna	Cable	Preamp	Ant	Table	Peak	Pol.
		( MHz )	( dBμV/m )	( dB )	( dBμV/m )	( dBμV )	( dB/m )	( dB )	( dB )	( cm )	( deg )	( P/A )	( H/V )
802.11a CH 100 5500MHz		5469.04	58.8	-15.2	74	47.9	35.32	12.27	36.69	383	12	P	H
	!	5469.68	48.26	-5.74	54	37.36	35.32	12.27	36.69	383	12	A	H
	*	5504	98.35	-	-	87.37	35.34	12.32	36.68	383	12	P	H
	*	5504	90.8	-	-	79.82	35.34	12.32	36.68	383	12	A	H
		5463.92	56.33	-17.67	74	45.43	35.32	12.27	36.69	399	341	P	V
		5469.99	46.61	-7.39	54	35.71	35.32	12.27	36.69	399	341	A	V
	*	5504	95.28	-	-	84.3	35.34	12.32	36.68	399	341	P	V
	*	5504	88.18	-	-	77.2	35.34	12.32	36.68	399	341	A	V
802.11a CH 116 5580MHz		5430.48	52.71	-21.29	74	41.87	35.3	12.23	36.69	397	360	P	H
		5451.76	43.88	-10.12	54	33.01	35.31	12.25	36.69	397	360	A	H
	*	5586	101.12	-	-	90	35.38	12.42	36.68	397	360	P	H
	*	5586	93.64	-	-	82.52	35.38	12.42	36.68	397	360	A	H
		5754.68	53.87	-20.13	74	42.56	35.56	12.6	36.85	397	360	P	H
		5752.76	44.26	-9.74	54	32.95	35.56	12.6	36.85	397	360	A	H
		5461.52	52.86	-21.14	74	41.99	35.31	12.25	36.69	400	337	P	V
		5435.92	43.88	-10.12	54	33.04	35.3	12.23	36.69	400	337	A	V
	*	5586	94.09	-	-	82.97	35.38	12.42	36.68	400	337	P	V
	*	5586	87.55	-	-	76.43	35.38	12.42	36.68	400	337	A	V
		5746.84	53.36	-20.64	74	42.08	35.54	12.59	36.85	400	337	P	V
		5741.56	44.04	-9.96	54	32.76	35.54	12.59	36.85	400	337	A	V



802.11a CH 140 5700MHz	*	5704	101.81	-	-	90.54	35.49	12.55	36.77	400	360	P	H
	*	5704	94.56	-	-	83.29	35.49	12.55	36.77	400	360	A	H
		5725.24	60.23	-13.77	74	48.95	35.52	12.57	36.81	400	360	P	H
	!	5725.01	50.79	-3.21	54	39.51	35.52	12.57	36.81	400	360	A	H
	*	5704	96.4	-	-	85.13	35.49	12.55	36.77	171	322	P	V
	*	5704	89.17	-	-	77.9	35.49	12.55	36.77	171	322	A	V
		5725.32	56.95	-17.05	74	45.67	35.52	12.57	36.81	171	322	P	V
		5725.08	47.88	-6.12	54	36.6	35.52	12.57	36.81	171	322	A	V
Remark	<ol style="list-style-type: none"> <li>No other spurious found.</li> <li>All results are PASS against Peak and Average limit line.</li> </ol>												



Band 3 - 5470~5725MHz

WIFI 802.11a (Harmonic @ 3m)

WIFI	Note	Frequency ( MHz )	Level ( dBμV/m )	Over Limit ( dB )	Limit Line ( dBμV/m )	Read Level (dBμV)	Antenna Factor ( dB/m )	Cable Loss ( dB )	Preamp Factor ( dB )	Ant Pos ( cm )	Table Pos ( deg )	Peak Avg. (P/A)	Pol. (H/V)
802.11a		11000	45.33	-28.67	74	56.61	38.5	15.92	65.7	100	360	P	H
CH 100 5500MHz		11000	44.36	-29.64	74	55.64	38.5	15.92	65.7	100	360	P	V
802.11a		11160	47.63	-26.37	74	58.65	38.57	15.99	65.58	100	360	P	H
CH 116 5580MHz		11160	42.8	-31.2	74	53.82	38.57	15.99	65.58	100	360	P	V
802.11a		11400	45.12	-28.88	74	55.77	38.66	16.1	65.41	100	360	P	H
CH 140 5700MHz		11400	43.33	-30.67	74	53.98	38.66	16.1	65.41	100	360	P	V
<b>Remark</b>	1. No other spurious found. 2. All results are PASS against Peak and Average limit line.												





Band 3 - 5470~5725MHz
WIFI 802.11n HT20 (Band Edge @ 3m)

Table with 14 columns: WIFI, Note, Frequency (MHz), Level (dBµV/m), Over Limit (dB), Limit Line (dBµV/m), Read Level (dBµV), Antenna Factor (dB/m), Cable Loss (dB), Preamp Factor (dB), Ant Pos (cm), Table Pos (deg), Peak Avg. (P/A), Pol. (H/V). Rows include data for 802.11n HT20 CH 100 (5500MHz) and 802.11n HT20 CH 116 (5580MHz).



802.11n HT20 CH 140 5700MHz	*	5706	98.21	-	-	86.98	35.49	12.55	36.81	364	7	P	H
	*	5706	91.73	-	-	80.5	35.49	12.55	36.81	364	7	A	H
		5725.16	63.06	-10.94	74	51.78	35.52	12.57	36.81	364	7	P	H
	!	5725.01	50.31	-3.69	54	39.03	35.52	12.57	36.81	364	7	A	H
	*	5708	92.21	-	-	80.98	35.49	12.55	36.81	300	25	P	V
	*	5708	85.29	-	-	74.06	35.49	12.55	36.81	300	25	A	V
		5725.32	56.71	-17.29	74	45.43	35.52	12.57	36.81	300	25	P	V
		5725.01	46.38	-7.62	54	35.1	35.52	12.57	36.81	300	25	A	V
Remark	<ol style="list-style-type: none"> <li>No other spurious found.</li> <li>All results are PASS against Peak and Average limit line.</li> </ol>												



**Band 3 - 5470~5725MHz**  
**WIFI 802.11n HT20 (Harmonic @ 3m)**

WIFI	Note	Frequency ( MHz )	Level ( dBμV/m )	Over Limit ( dB )	Limit Line ( dBμV/m )	Read Level (dBμV)	Antenna Factor ( dB/m )	Cable Loss ( dB )	Preamp Factor ( dB )	Ant Pos ( cm )	Table Pos ( deg )	Peak Avg. (P/A)	Pol. (H/V)
802.11n HT20 CH 100 5500MHz		11000	46.41	-27.59	74	57.69	38.5	15.92	65.7	300	360	P	H
		11000	45.69	-28.31	74	56.97	38.5	15.92	65.7	300	360	P	V
802.11n HT20 CH 116 5580MHz		11160	45.64	-28.36	74	56.66	38.57	15.99	65.58	300	360	P	H
		11160	44.52	-29.48	74	55.54	38.57	15.99	65.58	300	360	P	V
802.11n HT20 CH 140 5700MHz		11400	45.19	-28.81	74	55.84	38.66	16.1	65.41	100	360	P	H
		11400	42.85	-31.15	74	53.5	38.66	16.1	65.41	100	360	P	V
<b>Remark</b>	1. No other spurious found. 2. All results are PASS against Peak and Average limit line.												



Band 3 - 5470~5725MHz
WIFI 802.11n HT40 (Band Edge @ 3m)

Table with 14 columns: WIFI, Note, Frequency (MHz), Level (dBµV/m), Over Limit (dB), Limit Line (dBµV/m), Read Level (dBµV), Antenna Factor (dB/m), Cable Loss (dB), Preamp Factor (dB), Ant Pos (cm), Table Pos (deg), Peak Avg. (P/A), Pol. (H/V). Rows include data for 802.11n HT40 CH 102 (5510MHz) and 802.11n HT40 CH 110 (5550MHz).



802.11n HT40 CH 134 5670MHz		5419.92	52.56	-21.44	74	41.75	35.29	12.21	36.69	395	344	P	H
		5450.64	43.17	-10.83	54	32.3	35.31	12.25	36.69	395	344	A	H
	*	5680	98.52	-	-	87.32	35.45	12.52	36.77	395	344	P	H
	*	5680	91.17	-	-	79.97	35.45	12.52	36.77	395	344	A	H
		5725.88	59.78	-14.22	74	48.5	35.52	12.57	36.81	395	344	P	H
	!	5725.56	49.82	-4.18	54	38.54	35.52	12.57	36.81	395	344	A	H
		5393.84	52.29	-21.71	74	41.53	35.28	12.17	36.69	100	327	P	V
		5448.88	43.09	-10.91	54	32.22	35.31	12.25	36.69	100	327	A	V
	*	5684	91.98	-	-	80.75	35.47	12.53	36.77	100	327	P	V
	*	5684	85.14	-	-	73.91	35.47	12.53	36.77	100	327	A	V
		5731.88	55.81	-18.19	74	44.57	35.52	12.57	36.85	100	327	P	V
		5725.16	46.8	-7.2	54	35.52	35.52	12.57	36.81	100	327	A	V
<b>Remark</b>	1. No other spurious found. 2. All results are PASS against Peak and Average limit line.												



Band 3 - 5470~5725MHz
WIFI 802.11n HT40 (Harmonic @ 3m)

Table with 14 columns: WIFI, Note, Frequency (MHz), Level (dBµV/m), Over Limit (dB), Limit Line (dBµV/m), Read Level (dBµV), Antenna Factor (dB/m), Cable Loss (dB), Preamp Factor (dB), Ant Pos (cm), Table Pos (deg), Peak Avg. (P/A), Pol. (H/V). Rows include test results for channels 102, 110, and 134 at various frequencies.



Band 3 - 5470~5725MHz

Emission below 1GHz

WIFI 802.11n HT40 (LF @ 3m)

WIFI	Note	Frequency	Level	Over Limit	Limit Line	Read Level	Antenna Factor	Cable Loss	Preamp Factor	Ant Pos	Table Pos	Peak Avg.	Pol.
		( MHz )	( dBμV/m )	( dB )	( dBμV/m )	( dBμV )	( dB/m )	( dB )	( dB )	( cm )	( deg )	( P/A )	( H/V )
802.11n HT20 LF		36.79	31.12	-8.88	40	37.79	24.7	0.89	32.26	100	48	P	H
		42.61	26.97	-13.03	40	37.38	20.8	0.99	32.2	-	-	P	H
		81.41	24.6	-15.4	40	39.88	15.66	1.31	32.25	-	-	P	H
		182.29	31.57	-11.93	43.5	44.68	17.18	1.98	32.27	-	-	P	H
		208.48	30.28	-13.22	43.5	43.36	17.03	2.12	32.23	-	-	P	H
		901.06	32.85	-13.15	46	30.73	29	4.57	31.45	-	-	P	H
		36.79	31.34	-8.66	40	38.01	24.7	0.89	32.26	100	36	P	V
		58.13	29.21	-10.79	40	45.68	14.64	1.1	32.21	-	-	P	V
		66.86	27.34	-12.66	40	44.83	13.54	1.2	32.23	-	-	P	V
		80.44	26.55	-13.45	40	41.99	15.5	1.31	32.25	-	-	P	V
		186.17	24.43	-19.07	43.5	37.56	17.14	2	32.27	-	-	P	V
		208.48	25.39	-18.11	43.5	38.47	17.03	2.12	32.23	-	-	P	V
Remark	1. No other spurious found. 2. All results are PASS against limit line.												



**Note symbol**

*	<b>Fundamental Frequency</b> which can be ignored. However, the level of any unwanted emissions shall not exceed the level of the fundamental frequency.
!	Test result is <b>not under limit 6dB</b> .
P/A	<b>Peak</b> or <b>Average</b>
H/V	<b>Horizontal</b> or <b>Vertical</b>





A calculation example for radiated spurious emission is shown as below:

WIFI	Note	Frequency	Level	Over	Limit	Read	Antenna	Cable	Preamp	Ant	Table	Peak	Pol.
Ant.				Limit	Line	Level	Factor	Loss	Factor	Pos	Pos	Avg.	
1		( MHz )	( dBμV/m )	( dB )	( dBμV/m )	( dBμV )	( dB/m )	( dB )	( dB )	( cm )	( deg )	( P/A )	( H/V )
802.11b		2390	55.45	-18.55	74	54.51	32.22	4.58	35.86	103	308	P	H
CH 01													
2412MHz		2390	43.54	-10.46	54	42.6	32.22	4.58	35.86	103	308	A	H

- Level(dBμV/m) =  
Antenna Factor(dB/m) + Cable Loss(dB) + Read Level(dBμV) - Preamp Factor(dB)
- Over Limit(dB) = Level(dBμV/m) – Limit Line(dBμV/m)

**For Peak Limit @ 2390MHz:**

- Level(dBμV/m)  
= Antenna Factor(dB/m) + Cable Loss(dB) + Read Level(dBμV) - Preamp Factor(dB)  
= 32.22(dB/m) + 4.58(dB) + 54.51(dBμV) – 35.86 (dB)  
= 55.45 (dBμV/m)
- Over Limit(dB)  
= Level(dBμV/m) – Limit Line(dBμV/m)  
= 55.45(dBμV/m) – 74(dBμV/m)  
= -18.55(dB)

**For Average Limit @ 2390MHz:**

- Level(dBμV/m)  
= Antenna Factor(dB/m) + Cable Loss(dB) + Read Level(dBμV) - Preamp Factor(dB)  
= 32.22(dB/m) + 4.58(dB) + 42.6(dBμV) – 35.86 (dB)  
= 43.54 (dBμV/m)
- Over Limit(dB)  
= Level(dBμV/m) – Limit Line(dBμV/m)  
= 43.54(dBμV/m) – 54(dBμV/m)  
= -10.46(dB)

Both peak and average measured complies with the limit line, so test result is “PASS”.



### Appendix C. Duty Cycle Plots

Band	Duty Cycle(%)	T(ms)	1/T(kHz)	VBW Setting
802.11a	87.43	1.361	0.735	1 kHz
802.11n HT20	86.42	1.272	0.786	1 kHz
802.11n HT40	86.05	1.225	0.816	1 kHz

#### 802.11a

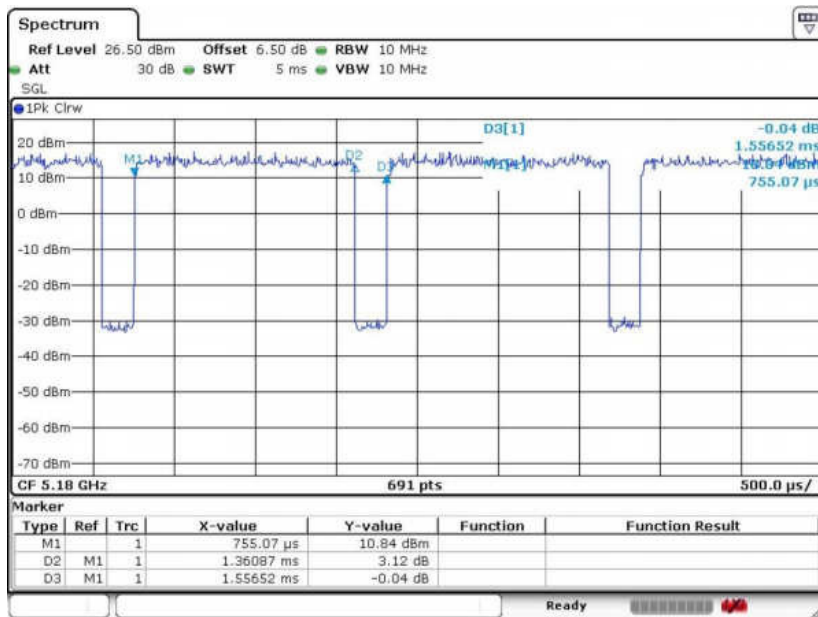



802.11n HT20

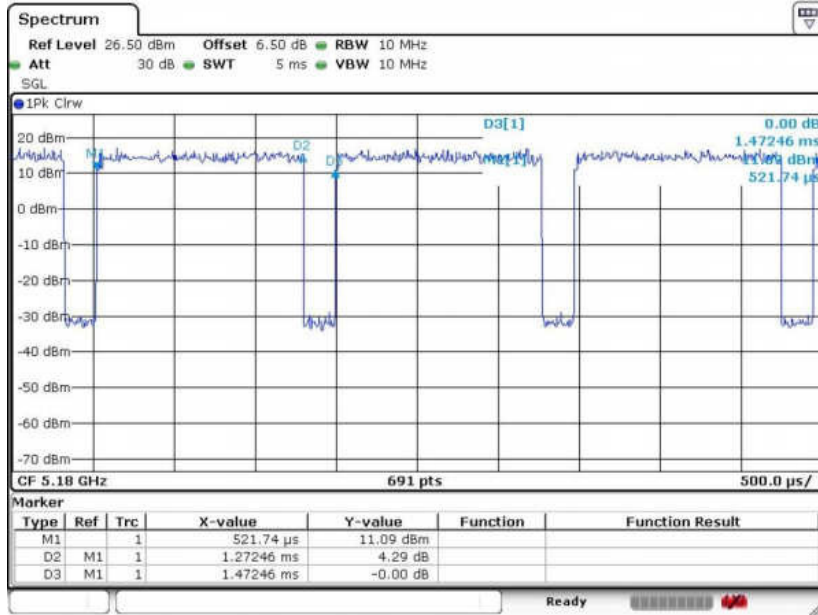

802.11n HT40

