



# FCC Test Report

**APPLICANT** : Motorola Mobility LLC  
**EQUIPMENT** : Mobile Cellular Phone  
**BRAND NAME** : Motorola  
**MODEL NAME** : XT1925-6, XT1925-12, XT1925DL  
**FCC ID** : IHDT56XD1  
**STANDARD** : FCC 47 CFR FCC Part 15 Subpart B  
**CLASSIFICATION** : Certification

The product was received on Dec. 25, 2017 and testing was completed on Jan. 17, 2018. We, Sporton International (Kunshan) Inc., would like to declare that the tested sample has been evaluated in accordance with the test procedures given in ANSI C63.4-2014 and has been in compliance with the applicable technical standards.

The test results in this report apply exclusively to the tested model / sample. Without written approval of Sporton International (Kunshan) Inc., the test report shall not be reproduced except in full.



Approved by: James Huang / Manager

**Sporton International (Kunshan) Inc.**

**No.3-2 Ping-Xiang Rd, Kunshan Development Zone Kunshan City Jiangsu Province 215335  
China**



# TABLE OF CONTENTS

**REVISION HISTORY ..... 3**

**SUMMARY OF TEST RESULT ..... 4**

**1. GENERAL DESCRIPTION ..... 5**

    1.1. Applicant..... 5

    1.2. Manufacturer ..... 5

    1.3. Product Feature of Equipment Under Test ..... 5

    1.4. Product Specification of Equipment Under Test ..... 6

    1.5. Modification of EUT ..... 7

    1.6. Specification of Accessory ..... 8

    1.7. Test Location ..... 9

    1.8. Applicable Standards ..... 9

**2. TEST CONFIGURATION OF EQUIPMENT UNDER TEST ..... 10**

    2.1. Test Mode ..... 10

    2.2. Connection Diagram of Test System ..... 12

    2.3. Support Unit used in test configuration and system ..... 14

    2.4. EUT Operation Test Setup ..... 14

**3. TEST RESULT ..... 15**

    3.1. Test of AC Conducted Emission Measurement ..... 15

    3.2. Test of Radiated Emission Measurement ..... 21

**4. LIST OF MEASURING EQUIPMENT ..... 27**

**5. UNCERTAINTY OF EVALUATION ..... 28**

**APPENDIX A. SETUP PHOTOGRAPHS**





### SUMMARY OF TEST RESULT

Report Section	FCC Rule	Description	Limit	Result	Remark
3.1	15.107	AC Conducted Emission	< 15.107 limits	PASS	Under limit 3.86 dB at 0.169 MHz
3.2	15.109	Radiated Emission	< 15.109 limits	PASS	Under limit 3.07 dB at 43.77 MHz



# 1. General Description

## 1.1. Applicant

Motorola Mobility LLC  
222 W,Merchandise Mart Plaza, Chicago IL 60654 USA

## 1.2. Manufacturer

Motorola Mobility LLC  
222 W, Merchandise Mart Plaza, Chicago IL 60654 USA

## 1.3. Product Feature of Equipment Under Test

Product Feature	
Equipment	Mobile Cellular Phone
Brand Name	Motorola
Model Name	XT1925-6, XT1925-12, XT1925DL
FCC ID	IHDT56XD1
EUT supports Radios application	CDMA/EV-DO/GSM/GPRS/EGPRS/WCDMA/HSPA/ HSPA+(Uplink is not supported)/DC-HSDPA/LTE/ WLAN 2.4GHz 802.11b/g/n HT20/ WLAN 5GHz 802.11a/n HT20/HT40 Bluetooth v3.0 + EDR/Bluetooth v4.0 LE/ Bluetooth v4.1 LE/Bluetooth v4.2 LE
IMEI Code	Conduction: 351884090003551 Radiation: 351884090003577
HW Version	DVT1-B
SW Version	ali_n-userdebug 8.0.0 OPS27.55 1276 intcfg,test-keys
EUT Stage	Identical Prototype

Remark: The above EUT's information was declared by manufacturer. Please refer to the specifications or user's manual for more detailed description.



### 1.4. Product Specification of Equipment Under Test

Standards-related Product Specification	
<b>Tx Frequency</b>	GSM850: 824.2 MHz ~ 848.8 MHz GSM1900: 1850.2 MHz ~ 1909.8MHz WCDMA Band V: 826.4 MHz ~ 846.6 MHz WCDMA Band IV : 1712.4 MHz ~ 1752.6 MHz WCDMA Band II: 1852.4 MHz ~ 1907.6 MHz LTE Band 2 : 1850.7 MHz ~ 1909.3 MHz LTE Band 4 : 1710.7 MHz ~ 1754.3 MHz LTE Band 5 : 824.7 MHz ~ 848.3 MHz LTE Band 7 : 2502.5 MHz ~ 2567.5 MHz LTE Band 12 : 699.7 MHz ~ 715.3 MHz LTE Band 13 : 779.5 MHz ~ 784.5 MHz LTE Band 17 : 706.5 MHz ~ 713.5 MHz LTE Band 25 : 1850.7MHz ~ 1914.3 MHz LTE Band 26 : 814.7MHz ~ 848.3 MHz LTE Band 30 : 2307.5 MHz ~ 2312.5 MHz LTE Band 66 : 1710.7 MHz ~ 1779.3 MHz LTE Band 38 : 2572.5 MHz ~ 2617.5 MHz LTE Band 41 : 2498.5 MHz ~ 2687.5 MHz CDMA2000 BC0: 824.70 MHz ~ 848.31 MHz CDMA2000 BC1: 1851.25 MHz ~ 1908.75 MHz CDMA2000 BC10: 817.9 MHz ~ 823.1 MHz 802.11b/g/n: 2412 MHz ~ 2462 MHz 802.11a/n: 5180 MHz ~ 5240 MHz; 5260 MHz ~ 5320 MHz; 5500 MHz ~ 5700 MHz; 5745 MHz ~ 5825 MHz Bluetooth: 2402 MHz ~ 2480 MHz
<b>Rx Frequency</b>	GSM850: 869.2 MHz ~ 893.8 MHz GSM1900: 1930.2 MHz ~ 1989.8 MHz WCDMA Band V: 871.4 MHz ~ 891.6 MHz WCDMA Band IV : 2112.4 MHz ~ 2152.6 MHz WCDMA Band II: 1932.4 MHz ~ 1987.6 MHz LTE Band 2 : 1930.7 MHz ~ 1989.3 MHz LTE Band 4 : 2110.7 MHz ~ 2154.3 MHz LTE Band 5 : 869.7 MHz ~ 893.3 MHz LTE Band 7: 2622.5 MHz ~ 2687.5 MHz LTE Band 12 : 729.7 MHz ~ 745.3 MHz LTE Band 13 : 748.5 MHz ~ 753.5 MHz LTE Band 17 : 736.5 MHz ~ 743.5 MHz LTE Band 25 : 1930.7 MHz ~ 1994.3 MHz LTE Band 26 : 859.7 MHz ~ 893.3 MHz LTE Band 29 : 718.5 MHz ~ 726.5 MHz LTE Band 30 : 2352.5 MHz ~ 2357.5 MHz LTE Band 66 : 2110.7 MHz ~ 2199.3 MHz LTE Band 38 : 2572.5 MHz ~ 2617.5 MHz LTE Band 41 : 2498.5 MHz ~ 2687.5 MHz CDMA2000 BC0: 869.70 MHz ~ 893.31 MHz CDMA2000 BC1: 1931.25 MHz ~ 1988.75 MHz CDMA2000 BC10: 862.9 MHz ~ 868.1 MHz 802.11b/g/n: 2412 MHz ~ 2462 MHz 802.11a/n: 5180 MHz ~ 5240 MHz; 5260 MHz ~ 5320 MHz; 5500 MHz ~ 5700 MHz; 5745 MHz ~ 5825 MHz



	Bluetooth: 2402 MHz ~ 2480 MHz GNSS: 1559 MHz to 1610 MHz FM : 88 MHz ~ 108 MHz
<b>Antenna Type</b>	WWAN : Fixed Internal PIFA Antenna WLAN : Fixed Internal PIFA Antenna Bluetooth : Fixed Internal PIFA Antenna GNSS: Fixed Internal PIFA Antenna FM: External headset Antenna
<b>Type of Modulation</b>	GSM: GMSK GPRS: GMSK EDGE(MCS 0-4): GMSK / (MCS 5-9): 8PSK WCDMA : BPSK (Uplink) HSDPA/DC-HSDPA : QPSK (Uplink) HSUPA : QPSK (Uplink) HSPA+ : 16QAM (Uplink is not supported) DC-HSDPA : 64QAM LTE: QPSK / 16QAM / 64QAM 802.11b : DSSS (DBPSK / DQPSK / CCK) 802.11a/g/n : OFDM (BPSK / QPSK / 16QAM / 64QAM) Bluetooth LE : GFSK Bluetooth (1Mbps) : GFSK Bluetooth (2Mbps) : $\pi/4$ -DQPSK Bluetooth (3Mbps) : 8-DPSK GNSS : BPSK FM : FM

Note: GNSS=BDS+GLONASS+GPS

### 1.5. Modification of EUT

No modifications are made to the EUT during all test items.



### 1.6. Specification of Accessory

Specification of Accessory				
AC Adapter 1(US)	Brand Name	Motorola (Salom)	Model Name	SC-22
	Power Rating	I/P: 100-240 Vac, 500mA, O/P: 5Vdc,3000mA or 9Vdc,1600mA or 12Vdc,1200mA		
AC Adapter 1(EU)	Brand Name	Motorola (Salom)	Model Name	SC-23
	Power Rating	I/P: 100-240 Vac, 500mA, O/P: 5Vdc,3000mA or 9Vdc,1600mA or 12Vdc,1200mA		
AC Adapter 1(UK)	Brand Name	Motorola (Salom)	Model Name	SC-24
	Power Rating	I/P: 100-240 Vac, 500mA, O/P: 5Vdc,3000mA or 9Vdc,1600mA or 12Vdc,1200mA		
AC Adapter 1(IN)	Brand Name	Motorola (Salom)	Model Name	SC-25
	Power Rating	I/P: 100-240 Vac, 500mA, O/P: 5Vdc,3000mA or 9Vdc,1600mA or 12Vdc,1200mA		
AC Adapter 1(AU)	Brand Name	Motorola (Salom)	Model Name	SC-26
	Power Rating	I/P: 100-240 Vac, 500mA, O/P: 5Vdc,3000mA or 9Vdc,1600mA or 12Vdc,1200mA		
AC Adapter 2(US)	Brand Name	Motorola (Chenyang)	Model Name	SC-22
	Power Rating	I/P: 100-240 Vac, 500mA, O/P: 5Vdc,3000mA or 9Vdc,1600mA or 12Vdc,1200mA		
AC Adapter 2(EU)	Brand Name	Motorola (Chenyang)	Model Name	SC-23
	Power Rating	I/P: 100-240 Vac, 500mA, O/P: 5Vdc,3000mA or 9Vdc,1600mA or 12Vdc,1200mA		
AC Adapter 2(UK)	Brand Name	Motorola (Chenyang)	Model Name	SC-24
	Power Rating	I/P: 100-240 Vac, 500mA, O/P: 5Vdc,3000mA or 9Vdc,1600mA or 12Vdc,1200mA		
AC Adapter 2(IN)	Brand Name	Motorola (Chenyang)	Model Name	SC-25
	Power Rating	I/P: 100-240 Vac, 500mA, O/P: 5Vdc,3000mA or 9Vdc,1600mA or 12Vdc,1200mA		
AC Adapter 2(AU)	Brand Name	Motorola (Chenyang)	Model Name	SC-26
	Power Rating	I/P: 100-240 Vac, 500mA, O/P: 5Vdc,3000mA or 9Vdc,1600mA or 12Vdc,1200mA		
Battery	Brand Name	Motorola (ATL)	Model Name	HG30
	Power Rating	3.8Vdc,3000mAh	Type	Li-ion
Earphone 1	Brand Name	Motorola (Jiahe)	Model Name	LS-118M-12
	Signal Line Type	1.2 meter, non-shielded cable, without ferrite core		
Earphone 2	Brand Name	Motorola (Lianyun)	Model Name	TS910A-38AMS01WHR-M
	Signal Line Type	1.2 meter, non-shielded cable, without ferrite core		
USB Cable	Brand Name	Motorola (Liqi)	Model Name	L32B-053000100-ALL
	Signal Line Type	1.0 meter, shielded cable, without ferrite core		





### 1.7. Test Location

Sporton International (Kunshan) Inc. is accredited to ISO 17025 by National Voluntary Laboratory Accreditation Program (NVLAP code: 600155-0) and the FCC designation No. is CN5013.

<b>Test Site</b>	Sporton International (Kunshan) Inc.		
<b>Test Site Location</b>	No.3-2 Ping-Xiang Rd, Kunshan Development Zone Kunshan City Jiangsu Province 215335 China TEL : +86-512-57900158 FAX : +86-512-57900958		
<b>Test Site No.</b>	<b>Sporton Site No.</b>		<b>FCC Test Firm Registration No.</b>
	CO01-KS	03CH02-KS	630927

**Note:** The test site complies with ANSI C63.4 2014 requirement.

### 1.8. Applicable Standards

According to the specifications of the manufacturer, the EUT must comply with the requirements of the following standards:

- FCC 47 CFR FCC Part 15 Subpart B
- ANSI C63.4-2014

**Remark:** All test items were verified and recorded according to the standards and without any deviation during the test.



## 2. Test Configuration of Equipment Under Test

### 2.1. Test Mode

The EUT has been associated with peripherals pursuant to ANSI C63.4-2014 and configuration operated in a manner tended to maximize its emission characteristics in a typical application.

Frequency range investigated: conduction (150 kHz to 30 MHz), radiation (30MHz to the 5th harmonic of the highest fundamental frequency or to 40 GHz, whichever is lower).

Test Items	Function Type
AC Conducted Emission	Mode 1: GSM850 Idle + Bluetooth Idle + WLAN Idle (2.4G) + USB Cable (Charging from Adapter 1) + Earphone 1 + Battery + Camera (Rear)<Fig.1>
	Mode 2: GSM1900 Idle + Bluetooth Idle + WLAN Idle (5G) + USB Cable (Charging from Adapter 1) + Earphone 1 + Battery + Camera (Front) <Fig.1>
	Mode 3: CDMA2000 BC0 Idle + Bluetooth Idle + WLAN Idle + USB Cable (Charging from Adapter 1) + Earphone 1 + Battery + MPEG4 <Fig.1>
	Mode 4: LTE Band 7 Idle + Bluetooth Idle + WLAN Idle (5G) + USB Cable (Charging from Adapter 1) + Earphone 1 + Battery + GNSS Rx <Fig.2>
	Mode 5: GSM1900 Idle + Bluetooth Idle + WLAN Idle (5G) + USB Cable (Charging from Adapter 2) + Earphone 2 + Battery + Camera (Front)<Fig.1>
	Mode 6: USB Cable (Charging from Adapter 1) + Earphone 1 + Battery + FM Rx (88MHz)<Fig.3>
	Mode 7: USB Cable (Charging from Adapter 1) + Earphone 1 + Battery + FM Rx (98MHz)<Fig.3>
	Mode 8: USB Cable (Charging from Adapter 1) + Earphone 1 + Battery + FM Rx (108MHz)<Fig.3>
	Mode 9: USB Cable (Charging from Adapter 2) + Earphone 2 + Battery + FM Rx (88MHz)<Fig.3>
	Mode 10 : LTE Band 7 Idle + Bluetooth Idle + WLAN Idle (2.4G) + Earphone + USB Cable (Data Link with Notebook) + Battery + GNSS Rx<Fig.4>

<p>Radiated Emissions &lt; 1GHz</p>	<p>Mode 1: GSM850 Idle + Bluetooth Idle + WLAN Idle (2.4G) + USB Cable (Charging from Adapter 1) + Earphone 1 + Battery + Camera (Rear)&lt;Fig.1&gt;</p> <p>Mode 2: GSM1900 Idle + Bluetooth Idle + WLAN Idle (5G) + USB Cable (Charging from Adapter 1) + Earphone 1 + Battery + Camera (Front) &lt;Fig.1&gt;</p> <p>Mode 3: WCDMA Band V Idle + Bluetooth Idle + WLAN Idle (2.4G) + USB Cable (Charging from Adapter 1) + Earphone 1 + Battery + MPEG4 &lt;Fig.1&gt;</p> <p>Mode 4: LTE Band 7 Idle + Bluetooth Idle + WLAN Idle (5G) + USB Cable (Charging from Adapter 1) + Earphone 1 + Battery + GNSS Rx &lt;Fig.2&gt;</p> <p>Mode 5: GSM850 Idle + Bluetooth Idle + WLAN Idle (2.4G) + USB Cable (Charging from Adapter 2) + Earphone 2 + Battery + Camera (Rear)&lt;Fig.1&gt;</p> <p>Mode 6: USB Cable (Charging from Adapter 1) + Earphone 1 + Battery + FM Rx (88MHz)&lt;Fig.3&gt;</p> <p>Mode 7: USB Cable (Charging from Adapter 1) + Earphone 1 + Battery + FM Rx (98MHz)&lt;Fig.3&gt;</p> <p>Mode 8: USB Cable (Charging from Adapter 1) + Earphone 1 + Battery + FM Rx (108MHz)&lt;Fig.3&gt;</p> <p>Mode 9: USB Cable (Charging from Adapter 2) + Earphone 2 + Battery + FM Rx (108MHz)&lt;Fig.3&gt;</p> <p>Mode 10 :LTE Band 7 Idle + Bluetooth Idle + WLAN Idle(2.4G) + Earphone + USB Cable (Data Link with Notebook) + Battery + GNSS Rx&lt;Fig.4&gt;</p>
<p>Radiated Emissions ≥ 1GHz</p>	<p>Mode 1: USB Cable (Charging from Adapter 1) + Earphone 1 + Battery + FM Rx (108MHz) &lt;Fig.3&gt;</p> <p>Mode 2: LTE Band 7 Idle + Bluetooth Idle + WLAN Idle(2.4G) + Earphone + USB Cable (Data Link with Notebook) + Battery + GNSS Rx&lt;Fig.4&gt;</p>
<p><b>Remark:</b></p> <ol style="list-style-type: none"> <li>1. The worst case of AC is mode 6, and the USB Link mode of AC is mode 10; the test data of these modes were reported.</li> <li>2. The worst case of RE &lt; 1G is mode 8, and the USB Link mode of RE is mode 10; the test data of these modes were reported.</li> </ol>	

## 2.2. Connection Diagram of Test System

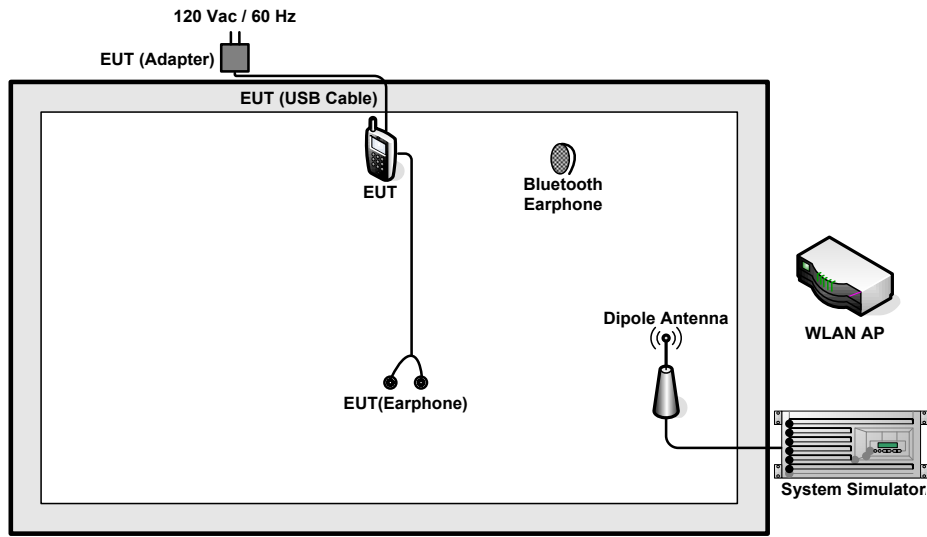

<Fig.1>

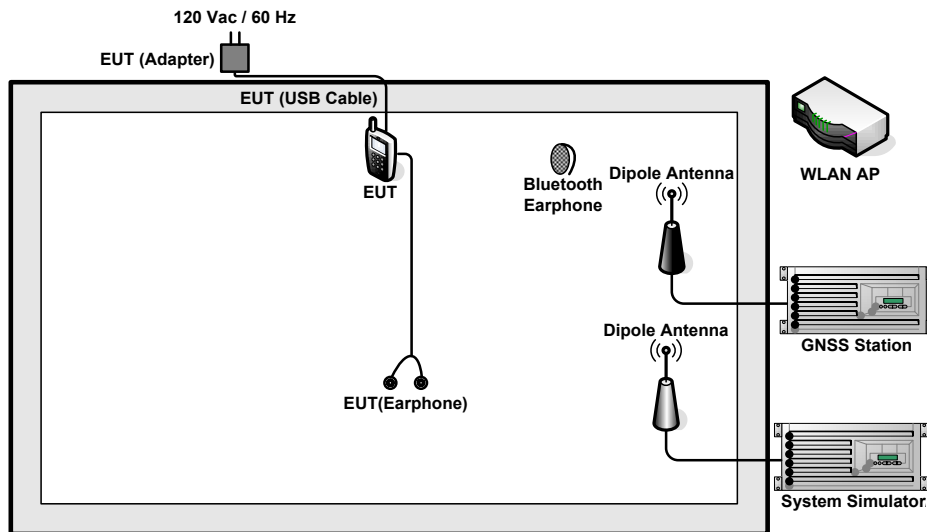

<Fig.2>

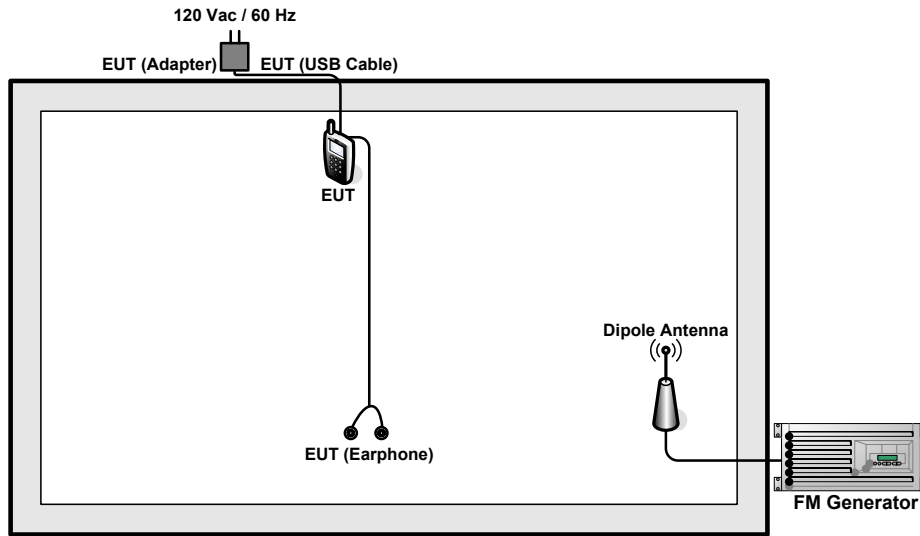

<Fig.3>

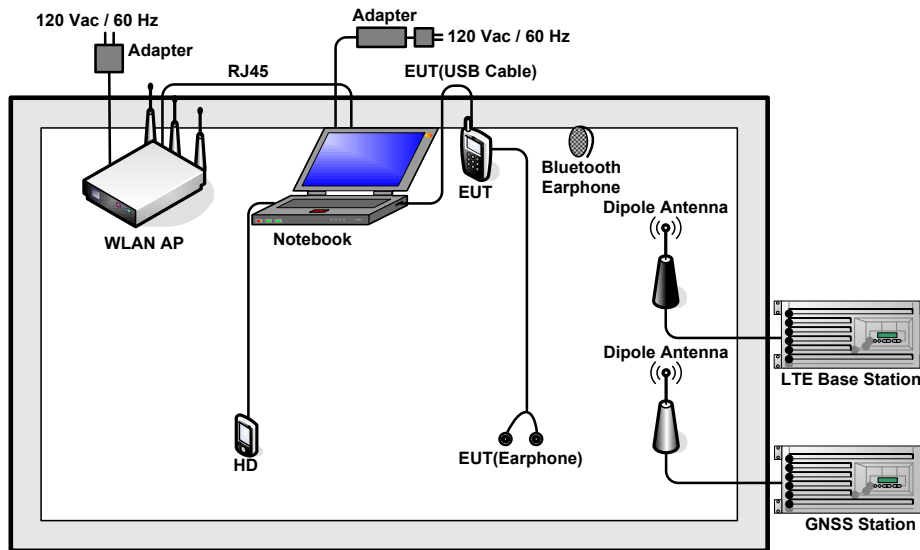

<Fig.4>

### 2.3. Support Unit used in test configuration and system

Item	Equipment	Trade Name	Model Name	FCC ID	Data Cable	Power Cord
1.	LTE Base Station	Anritsu	MT8820C	N/A	N/A	Unshielded, 1.8 m
2.	System Simulator	R&S	CMU 200	N/A	N/A	Unshielded, 1.8 m
3.	FM Generator	R&S	SMBV100A	N/A	N/A	Unshielded, 1.8 m
4.	GNSS Station	ADIVIC	MP9000	N/A	N/A	Unshielded, 1.8 m
5.	LABSAT GPS Simulator	RACELOGIC	RLLS03-2RP	N/A	N/A	LABSAT GPS Simulator
6.	WLAN AP	D-Link	DIR-855	KA2DIR855A2	N/A	Unshielded, 1.8 m
7.	WLAN AP	TP-Link	TL-WDR5600	N/A	N/A	Unshielded, 1.8 m
8.	Notebook	Lenovo	Y510P	N/A	N/A	AC I/P: Unshielded, 1.8 m DC O/P: Shielded, 1.8 m
9.	Notebook	Lenovo	G480	PRC4	N/A	AC I/P: Unshielded, 1.8 m DC O/P: Shielded, 1.8 m
10.	Bluetooth Earphone	Lenovo	LBH308	N/A	N/A	N/A
11.	Hard Disk	Lenovo	F310	FCC DoC	Shielded, 0.5 m	N/A
12.	SD Card	Kingston	8GB	N/A	N/A	N/A
13.	SD Card	SanDisk	Ultra	N/A	N/A	N/A

### 2.4. EUT Operation Test Setup

The EUT was in LTE idle mode during the testing. The EUT was synchronized to the BCCH, and is in continuous receiving mode by setting system simulator’s paging reorganization.

At the same time, the EUT was attached to the Bluetooth earphone or WLAN AP, and the following programs installed in the EUT were programmed during the test.

1. Data application is transferred between Notebook and EUT via USB cable.
2. Turn on GNSS function to make the EUT receive continuous signals from GNSS station.
3. Turn on FM function to make the EUT receive continuous signals from FM Generator.
4. Execute “Video Player” to play MPEG4 files.
5. Turn on camera to capture images.

### 3. Test Result

#### 3.1. Test of AC Conducted Emission Measurement

##### 3.1.1 Limits of AC Conducted Emission

For equipment that is designed to be connected to the public utility (AC) power line, the radio frequency voltage that is conducted back onto the AC power line on any frequency or frequencies within the band 150 kHz to 30 MHz shall not exceed the limits in the following table.

Frequency of emission (MHz)	Conducted limit (dBuV)	
	Quasi-peak	Average
0.15-0.5	66 to 56*	56 to 46*
0.5-5	56	46
5-30	60	50

\*Decreases with the logarithm of the frequency.

##### 3.1.2 Measuring Instruments

The measuring equipment is listed in the section 4 of this test report.

##### 3.1.3 Test Procedure

1. The EUT was placed 0.4 meter from the conducting wall of the shielding room was kept at least 80 centimeters from any other grounded conducting surface.
2. Connect EUT to the power mains through a line impedance stabilization network (LISN).
3. All the support units are connecting to the other LISN.
4. The LISN provides 50 ohm coupling impedance for the measuring instrument.
5. The FCC states that a 50 ohm, 50 microhenry LISN should be used.
6. Both sides of AC line were checked for maximum conducted interference.
7. The frequency range from 150 kHz to 30 MHz was searched.
8. Set the test-receiver system to Peak Detect Function and specified bandwidth (IF Bandwidth = 9kHz) with Maximum Hold Mode. Then measurement is also conducted by Average Detector and Quasi-Peak Detector Function respectively.

### 3.1.4 Test Setup

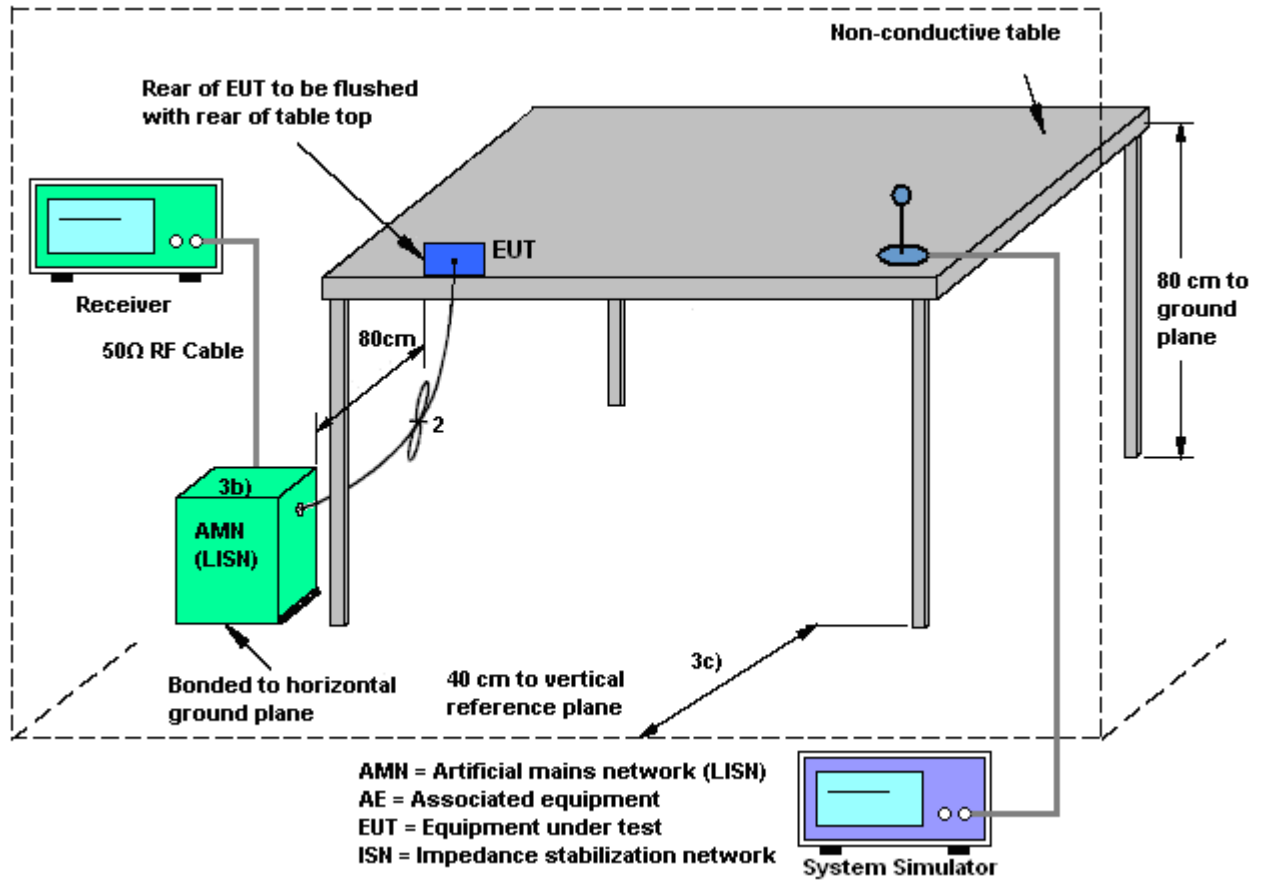





3.1.5 Test Result of AC Conducted Emission

Test Mode :	Mode 6	Temperature :	22~24°C
Test Engineer :	Amos Zhang	Relative Humidity :	42~46%
Test Voltage :	120Vac / 60Hz	Phase :	Line
Function Type :	USB Cable (Charging from Adapter 1) + Earphone 1 + Battery + FM Rx (88MHz)		

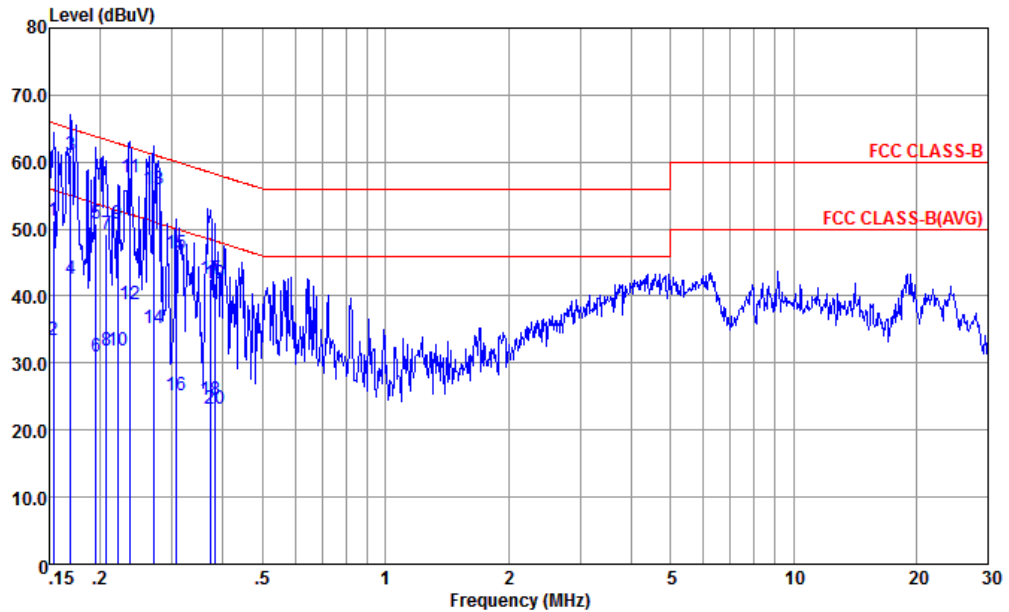

Site : CO01-KS  
 Condition : FCC CLASS-B LISN-L-171013-060103 LINE  
 Project : (FC) 7D2507

: 351884090003551

	Freq	Level	Over Limit	Limit Line	Read Level	LISN Factor	Cable Loss	Remark
	MHz	dBuV	dB	dBuV	dBuV	dB	dB	
1	0.153	51.27	-14.55	65.82	40.50	0.16	10.61	QP
2	0.153	33.37	-22.45	55.82	22.60	0.16	10.61	Average
3 *	0.169	61.13	-3.86	64.99	50.40	0.18	10.55	QP
4	0.169	42.63	-12.36	54.99	31.90	0.18	10.55	Average
5	0.195	50.86	-12.94	63.80	40.19	0.20	10.47	QP
6	0.195	30.96	-22.84	53.80	20.29	0.20	10.47	Average
7	0.207	49.26	-14.06	63.32	38.61	0.20	10.45	QP
8	0.207	31.86	-21.46	53.32	21.21	0.20	10.45	Average
9	0.221	50.86	-11.93	62.79	40.20	0.21	10.45	QP
10	0.221	31.86	-20.93	52.79	21.20	0.21	10.45	Average
11	0.237	57.75	-4.47	62.22	47.10	0.21	10.44	QP
12	0.237	38.85	-13.37	52.22	28.20	0.21	10.44	Average
13	0.270	55.85	-5.27	61.12	45.20	0.22	10.43	QP
14	0.270	35.25	-15.87	51.12	24.60	0.22	10.43	Average
15	0.307	46.25	-13.81	60.06	35.59	0.23	10.43	QP
16	0.307	25.25	-24.81	50.06	14.59	0.23	10.43	Average
17	0.371	42.55	-15.92	58.47	31.90	0.24	10.41	QP
18	0.371	24.55	-23.92	48.47	13.90	0.24	10.41	Average
19	0.381	41.85	-16.40	58.25	31.20	0.24	10.41	QP
20	0.381	23.25	-25.00	48.25	12.60	0.24	10.41	Average



Test Mode :	Mode 6	Temperature :	22~24°C
Test Engineer :	Amos Zhang	Relative Humidity :	42~46%
Test Voltage :	120Vac / 60Hz	Phase :	Neutral
Function Type :	USB Cable (Charging from Adapter 1) + Earphone 1 + Battery + FM Rx (88MHz)		

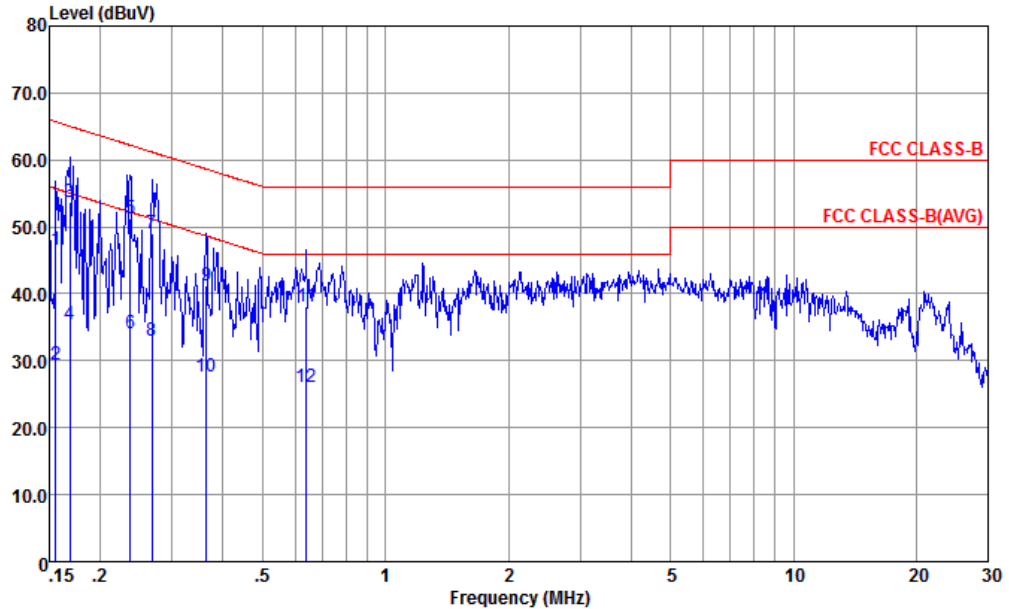

Site : CO01-KS  
 Condition : FCC CLASS-B LISN-N-171013-060103 NEUTRAL  
 Project : (FC) 7D2507

: 351884090003551

	Freq	Level	Over Limit	Limit Line	Read Level	LISN Factor	Cable Loss	Remark
	MHz	dBuV	dB	dBuV	dBuV	dB	dB	
1	0.156	46.48	-19.21	65.69	35.60	0.28	10.60	QP
2	0.156	29.48	-26.21	55.69	18.60	0.28	10.60	Average
3	0.169	53.73	-11.30	65.03	42.90	0.28	10.55	QP
4	0.169	35.43	-19.60	55.03	24.60	0.28	10.55	Average
5 *	0.237	51.23	-10.99	62.22	40.51	0.28	10.44	QP
6	0.237	34.03	-18.19	52.22	23.31	0.28	10.44	Average
7	0.267	49.02	-12.18	61.20	38.30	0.28	10.44	QP
8	0.267	33.02	-18.18	51.20	22.30	0.28	10.44	Average
9	0.363	41.30	-17.35	58.65	30.60	0.29	10.41	QP
10	0.363	27.60	-21.05	48.65	16.90	0.29	10.41	Average
11	0.641	38.10	-17.90	56.00	27.60	0.30	10.20	QP
12	0.641	26.00	-20.00	46.00	15.50	0.30	10.20	Average



Test Mode :	Mode 10	Temperature :	22~24°C
Test Engineer :	Amos Zhang	Relative Humidity :	42~46%
Test Voltage :	120Vac / 60Hz	Phase :	Line
Function Type :	LTE Band 7 Idle + Bluetooth Idle + WLAN Idle (2.4G) + Earphone + USB Cable (Data Link with Notebook) + Battery + GNSS Rx		

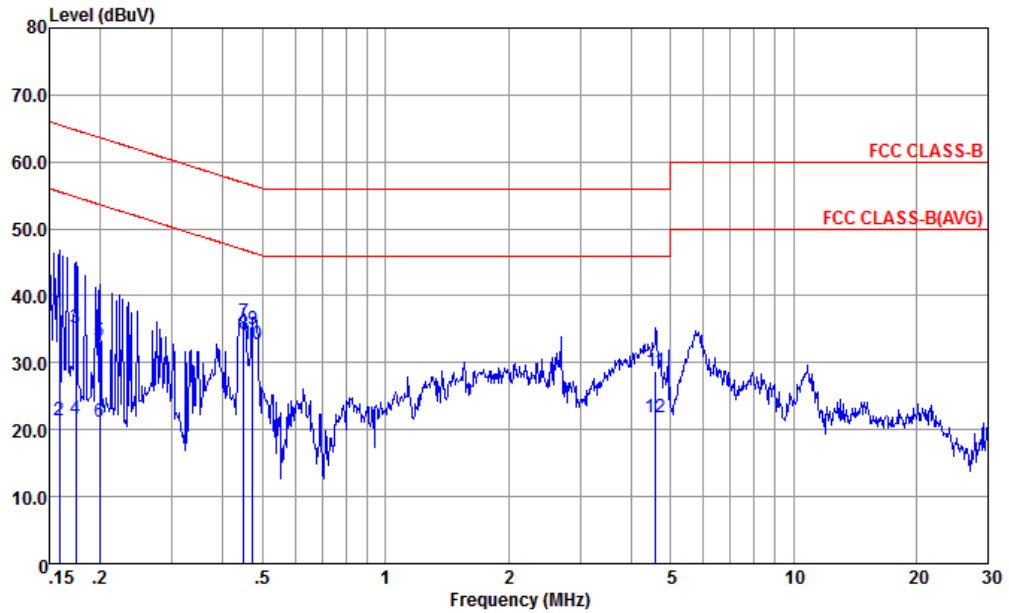

Site : CO01-KS  
 Condition : FCC CLASS-B LISN-L-171013-060103 LINE  
 Project : (FC) 7D2507

	Freq	Level	Over Limit	Limit Line	Read Level	LISN Factor	Cable Loss	Remark
	MHz	dBuV	dB	dBuV	dBuV	dB	dB	
1	0.159	37.55	-27.97	65.52	26.79	0.17	10.59	QP
2	0.159	21.35	-34.17	55.52	10.59	0.17	10.59	Average
3	0.174	35.32	-29.45	64.77	24.60	0.18	10.54	QP
4	0.174	21.52	-33.25	54.77	10.80	0.18	10.54	Average
5	0.200	33.26	-30.36	63.62	22.60	0.20	10.46	QP
6	0.200	21.16	-32.46	53.62	10.50	0.20	10.46	Average
7	0.449	36.11	-20.78	56.89	25.50	0.25	10.36	QP
8 *	0.449	34.41	-12.48	46.89	23.80	0.25	10.36	Average
9	0.474	34.89	-21.56	56.45	24.30	0.26	10.33	QP
10	0.474	32.79	-13.66	46.45	22.20	0.26	10.33	Average
11	4.598	28.77	-27.23	56.00	18.20	0.36	10.21	QP
12	4.598	21.87	-24.13	46.00	11.30	0.36	10.21	Average



Test Mode :	Mode 10	Temperature :	22~24°C
Test Engineer :	Amos Zhang	Relative Humidity :	42~46%
Test Voltage :	120Vac / 60Hz	Phase :	Neutral
Function Type :	LTE Band 7 Idle + Bluetooth Idle + WLAN Idle (2.4G) + Earphone + USB Cable (Data Link with Notebook) + Battery + GNSS Rx		

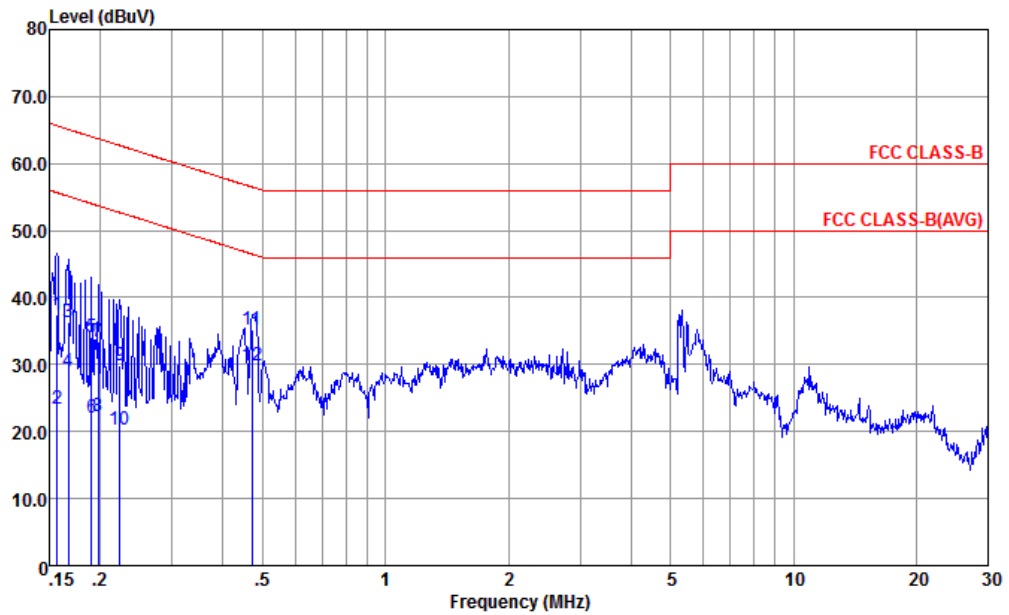

Site : CO01-KS  
 Condition : FCC CLASS-B LISN-N-171013-060103 NEUTRAL  
 Project : (FC) 7D2507

	Freq	Level	Over Limit	Limit Line	Read Level	LISN Factor	Cable Loss	Remark
	MHz	dBuV	dB	dBuV	dBuV	dB	dB	
1	0.156	37.47	-28.18	65.65	26.60	0.28	10.59	QP
2	0.156	23.37	-32.28	55.65	12.50	0.28	10.59	Average
3	0.167	36.34	-28.78	65.12	25.50	0.28	10.56	QP
4	0.167	29.04	-26.08	55.12	18.20	0.28	10.56	Average
5	0.190	34.06	-29.96	64.02	23.30	0.28	10.48	QP
6	0.190	22.06	-31.96	54.02	11.30	0.28	10.48	Average
7	0.198	33.34	-30.37	63.71	22.60	0.28	10.46	QP
8	0.198	22.24	-31.47	53.71	11.50	0.28	10.46	Average
9	0.223	29.93	-32.77	62.70	19.20	0.28	10.45	QP
10	0.223	20.33	-32.37	52.70	9.60	0.28	10.45	Average
11	0.471	35.22	-21.27	56.49	24.60	0.29	10.33	QP
12 *	0.471	29.92	-16.57	46.49	19.30	0.29	10.33	Average

## 3.2. Test of Radiated Emission Measurement

### 3.2.1. Limit of Radiated Emission

The emissions from an unintentional radiator shall not exceed the field strength levels specified in the following table:

Frequency (MHz)	Field Strength (microvolts/meter)	Measurement Distance (meters)
30 – 88	100	3
88 – 216	150	3
216 - 960	200	3
Above 960	500	3

### 3.2.2. Measuring Instruments

The measuring equipment is listed in the section 4 of this test report.

### 3.2.3. Test Procedures

1. The EUT was placed on a turntable with 0.8 meter above ground.
2. The EUT was set 3 meters from the interference receiving antenna, which was mounted on the top of a variable height antenna tower.
3. The table was rotated 360 degrees to determine the position of the highest radiation.
4. The antenna is a Bi-Log antenna and its height is adjusted between one to four meters above ground to find the maximum value of the field strength for both horizontal polarization and vertical polarization of the antenna.
5. For each suspected emission, the EUT was arranged to its worst case and then tune the antenna tower (from 1 m to 4 m) and turntable (from 0 degree to 360 degrees) to find the maximum reading.
6. Set the test-receiver system to Peak Detect Function and specified bandwidth with Maximum Hold Mode (RBW=120kHz/VBW=300kHz for frequency below 1GHz; RBW=1MHz VBW=3MHz (Peak), RBW=1MHz/VBW=10Hz (Average) for frequency above 1GHz).
7. If the emission level of the EUT in peak mode was 3 dB lower than the limit specified, peak values of EUT will be reported. Otherwise, the emission will be repeated by using the quasi-peak method and reported.
8. Emission level (dB $\mu$ V/m) = 20 log Emission level ( $\mu$ V/m)
9. Corrected Reading: Antenna Factor + Cable Loss + Read Level - Preamp Factor = Level

### 3.2.4. Test Setup of Radiated Emission

For radiated emissions from 30MHz to 1GHz

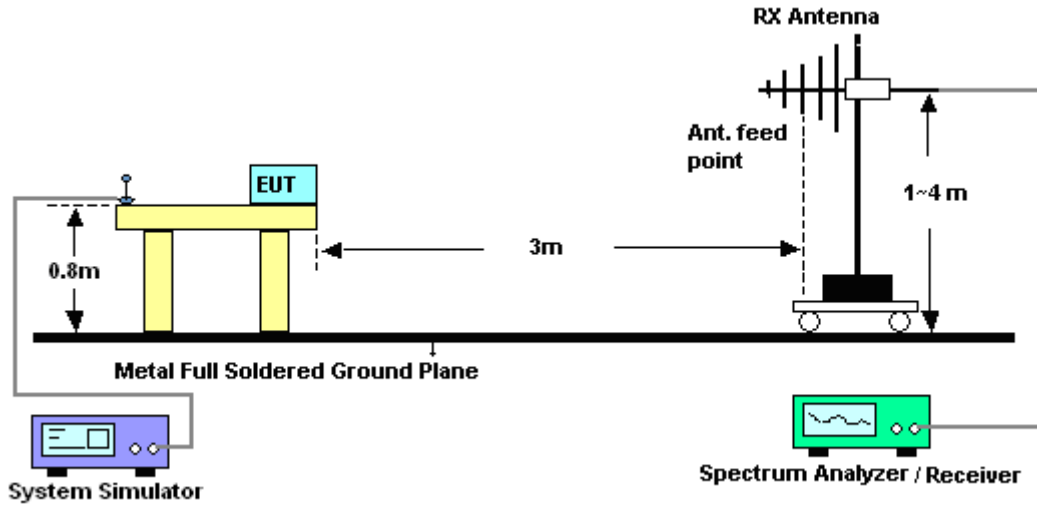

For radiated emissions above 1GHz

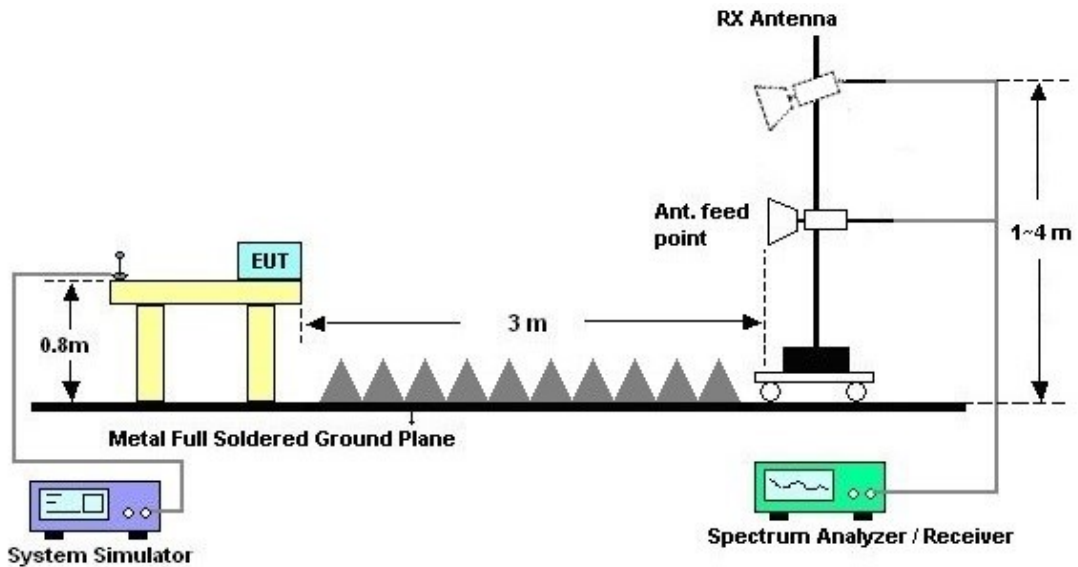



3.2.5. Test Result of Radiated Emission

Test Mode :	Mode 8	Temperature :	21~22°C
Test Engineer :	Leo Liao	Relative Humidity :	41~42%
Test Distance :	3m	Polarization :	Horizontal
Function Type :	USB Cable (Charging from Adapter 1) + Earphone 1 + Battery + FM Rx (108MHz)		
Remark :	#3 is Base station (FM option) signal which can be ignored.		

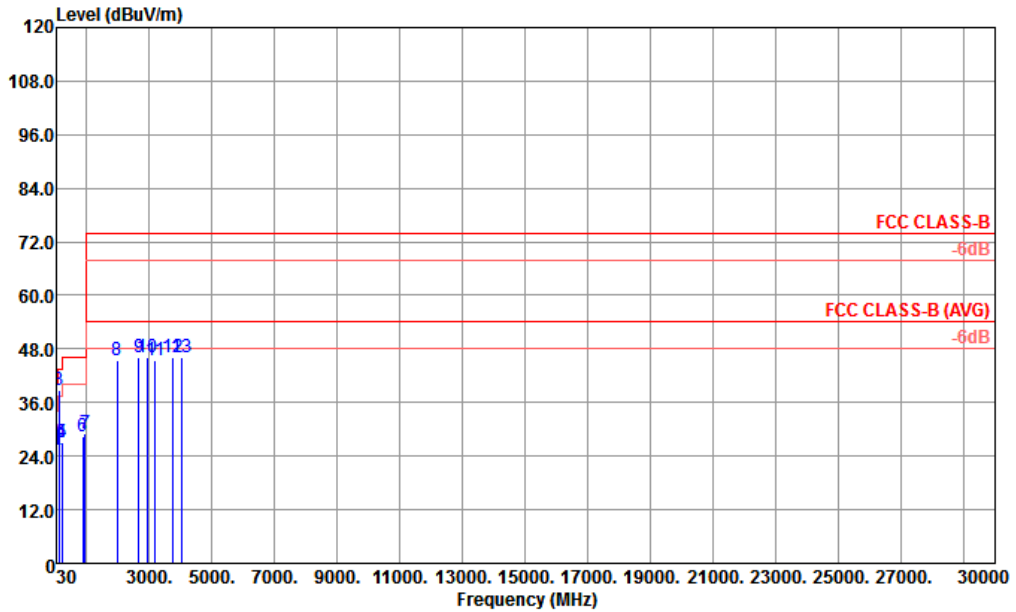

Site : 03CH02-KS  
 Condition : FCC CLASS-B 3m 02 LF ANT HORIZONTAL

IMEI : 351884090003577 #21

	Freq	Level	Over Limit	Limit Line	ReadAntenna Level	Cable Factor	Preamp Loss	A/Pos	T/Pos	Remark	
	MHz	dBuV/m	dB	dBuV/m	dBuV	dB/m	dB	dB	cm	deg	
1	31.35	25.73	-14.27	40.00	31.93	25.23	0.60	32.03	100	0 Peak	
2	44.31	25.33	-14.67	40.00	36.21	20.57	0.66	32.11	---	---	Peak
3 !	108.03	38.80			51.83	17.84	1.05	31.92	---	---	Peak
4	205.77	27.12	-16.38	43.50	41.37	15.93	1.48	31.66	---	---	Peak
5	210.90	27.14	-16.36	43.50	41.22	16.05	1.51	31.64	---	---	Peak
6	866.30	28.26	-17.74	46.00	25.74	27.24	3.07	27.79	---	---	Peak
7	953.80	29.22	-16.78	46.00	24.55	28.58	3.21	27.12	---	---	Peak
8	1976.00	45.57	-28.43	74.00	44.33	30.07	4.61	33.44	---	---	Peak
9	2654.00	46.04	-27.96	74.00	39.24	31.74	5.48	30.42	---	---	Peak
10	2940.00	46.18	-27.82	74.00	37.83	32.40	5.92	29.97	---	---	Peak
11	3195.00	45.45	-28.55	74.00	35.69	33.10	6.18	29.52	---	---	Peak
12	3732.00	46.28	-27.72	74.00	35.14	34.59	6.57	30.02	---	---	Peak
13	4017.00	46.07	-27.93	74.00	34.27	35.12	6.79	30.11	---	---	Peak



Test Mode :	Mode 8	Temperature :	21~22°C
Test Engineer :	Leo Liao	Relative Humidity :	41~42%
Test Distance :	3m	Polarization :	Vertical
Function Type :	USB Cable (Charging from Adapter 1) + Earphone 1 + Battery + FM Rx (108MHz)		
Remark :	#3 is Base station (FM option) signal which can be ignored.		

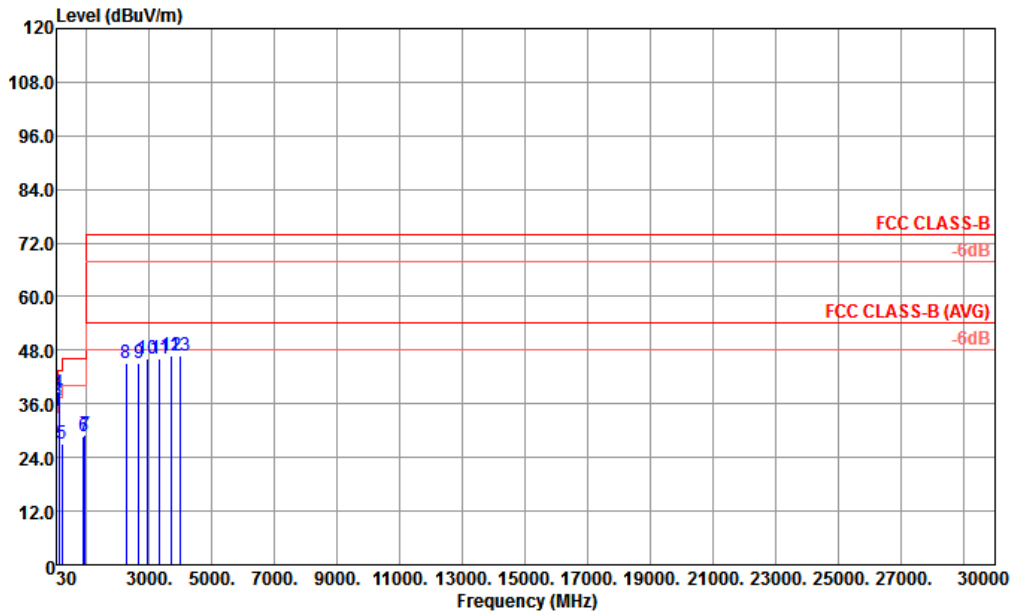

Site : 03CH02-KS  
 Condition : FCC CLASS-B 3m 02 LF ANT VERTICAL

IMEI : 351884090003577 #21

	Freq	Level	Over	Limit	ReadAntenna	Cable	Preamp	A/Pos	T/Pos	Remark	
	MHz	dBuV/m	dB	dBuV/m	dBuV	dB/m	dB	dB	cm	deg	
1 !	33.51	34.42	-5.58	40.00	40.96	24.87	0.63	32.04	---	---	Peak
2 !	41.61	36.61	-3.39	40.00	46.70	21.33	0.65	32.07	100	0	QP
3 !	43.77	36.93	-3.07	40.00	47.80	20.57	0.66	32.10	100	0	QP
4 !	108.03	38.36			51.39	17.84	1.05	31.92	---	---	Peak
5	207.12	27.21	-16.29	43.50	41.40	15.97	1.49	31.65	---	---	Peak
6	904.10	28.61	-17.39	46.00	25.41	27.58	3.10	27.48	---	---	Peak
7	944.70	28.96	-17.04	46.00	24.57	28.38	3.19	27.18	---	---	Peak
8	2252.00	45.09	-28.91	74.00	40.84	31.08	4.99	31.82	---	---	Peak
9	2656.00	45.17	-28.83	74.00	38.37	31.74	5.48	30.42	---	---	Peak
10	2950.00	46.28	-27.72	74.00	37.88	32.45	5.92	29.97	---	---	Peak
11	3327.00	46.08	-27.92	74.00	36.51	33.28	6.25	29.96	---	---	Peak
12	3711.00	46.81	-27.19	74.00	35.82	34.37	6.55	29.93	---	---	Peak
13	3975.00	46.72	-27.28	74.00	35.07	35.06	6.70	30.11	---	---	Peak





Test Mode :	Mode 10	Temperature :	21~22°C
Test Engineer :	Leo Liao	Relative Humidity :	41~42%
Test Distance :	3m	Polarization :	Horizontal
Function Type :	LTE Band 7 Idle + Bluetooth Idle + WLAN Idle(2.4G) + Earphone + USB Cable (Data Link with Notebook) + Battery + GNSS Rx		

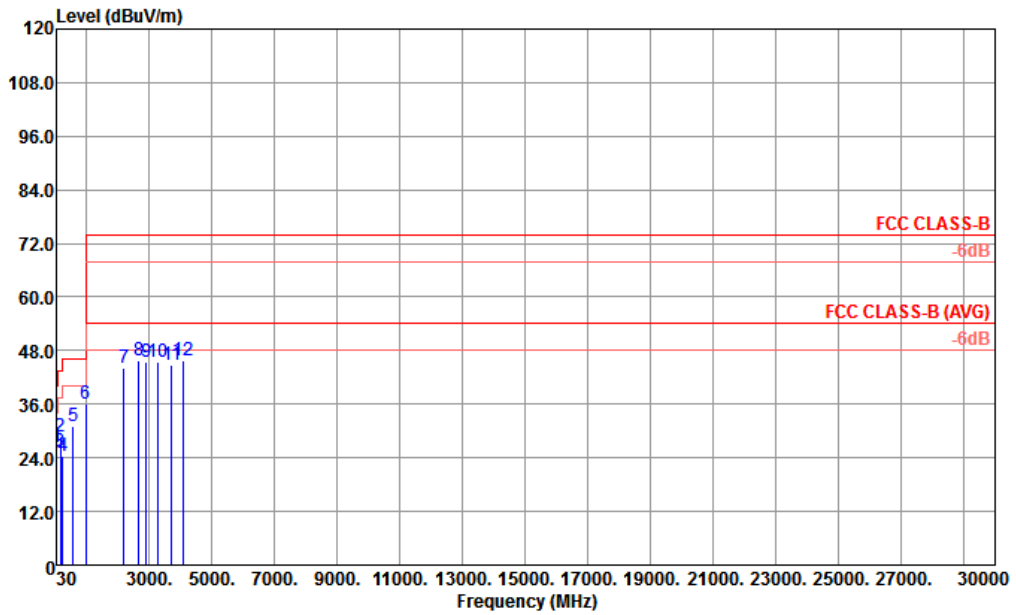

Site : 03CH02-KS  
Condition : FCC CLASS-B 3m 02 LF ANT HORIZONTAL

IMEI : 351884090003577 #21

	Freq	Level	Over	Limit	ReadAntenna	Cable	Preamp	A/Pos	T/Pos	Remark	
	MHz	dBuV/m	dB	dBuV/m	dBuV	dB/m	dB	dB	cm	deg	
1	43.77	26.56	-13.44	40.00	37.43	20.57	0.66	32.10	---	---	Peak
2	166.08	28.70	-14.80	43.50	42.21	16.96	1.32	31.79	---	---	Peak
3	170.40	25.55	-17.95	43.50	39.16	16.82	1.34	31.77	---	---	Peak
4	229.80	24.44	-21.56	46.00	37.98	16.43	1.63	31.60	---	---	Peak
5	575.80	31.11	-14.89	46.00	33.78	24.55	2.59	29.81	---	---	Peak
6	959.90	35.97	-10.03	46.00	31.14	28.70	3.21	27.08	100	0	Peak
7	2192.00	44.23	-29.77	74.00	40.29	30.94	4.94	31.94	---	---	Peak
8	2652.00	45.92	-28.08	74.00	39.12	31.74	5.48	30.42	---	---	Peak
9	2906.00	45.46	-28.54	74.00	37.23	32.30	5.90	29.97	---	---	Peak
10	3285.00	45.42	-28.58	74.00	35.84	33.21	6.24	29.87	---	---	Peak
11	3708.00	44.94	-29.06	74.00	33.95	34.37	6.55	29.93	---	---	Peak
12	4059.00	45.65	-28.35	74.00	33.70	35.20	6.86	30.11	---	---	Peak



Test Mode :	Mode 10	Temperature :	21~22°C
Test Engineer :	Leo Liao	Relative Humidity :	41~42%
Test Distance :	3m	Polarization :	Vertical
Function Type :	LTE Band 7 Idle + Bluetooth Idle + WLAN Idle(2.4G) + Earphone + USB Cable (Data Link with Notebook) + Battery + GNSS Rx		

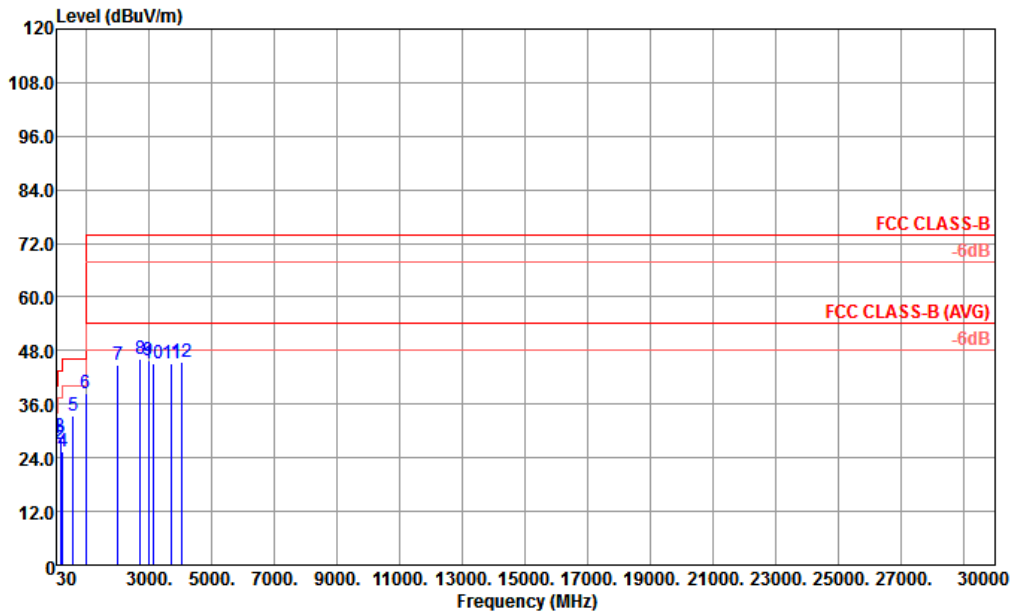

Site : 03CH02-KS  
Condition : FCC CLASS-B 3m 02 LF ANT VERTICAL

IMEI : 351884090003577 #21

	Freq	Level	Over Limit	Limit Line	ReadAntenna Level	Cable Loss	Preamp Factor	A/Pos	T/Pos	Remark	
	MHz	dBuV/m	dB	dBuV/m	dBuV	dB/m	dB	dB	cm	deg	
1	43.77	28.46	-11.54	40.00	39.33	20.57	0.66	32.10	---	---	Peak
2	153.12	27.04	-16.46	43.50	40.17	17.43	1.27	31.83	---	---	Peak
3	166.08	28.72	-14.78	43.50	42.23	16.96	1.32	31.79	---	---	Peak
4	229.80	25.40	-20.60	46.00	38.94	16.43	1.63	31.60	---	---	Peak
5	575.80	33.55	-12.45	46.00	36.22	24.55	2.59	29.81	---	---	Peak
6	959.90	38.37	-7.63	46.00	33.54	28.70	3.21	27.08	100	0	Peak
7	1986.00	44.77	-29.23	74.00	43.37	30.19	4.61	33.40	---	---	Peak
8	2716.00	46.17	-27.83	74.00	38.93	31.85	5.66	30.27	---	---	Peak
9	2962.00	45.88	-28.12	74.00	37.46	32.45	5.94	29.97	---	---	Peak
10	3105.00	45.06	-28.94	74.00	35.78	32.87	6.10	29.69	---	---	Peak
11	3714.00	45.14	-28.86	74.00	34.04	34.48	6.55	29.93	---	---	Peak
12	4038.00	45.46	-28.54	74.00	33.53	35.18	6.86	30.11	---	---	Peak



### 4. List of Measuring Equipment

Instrument	Manufacturer	Model No.	Serial No.	Characteristics	Calibration Date	Test Date	Due Date	Remark
EMI Receiver	R&S	ESCI7	100768	9kHz~7GHz;	Apr. 20, 2017	Jan. 17, 2018	Apr. 19, 2018	Conduction (CO01-KS)
AC LISN	MessTec	AN3016	060103	9kHz~30MHz	Oct. 13, 2017	Jan. 17, 2018	Oct. 12, 2018	Conduction (CO01-KS)
AC LISN (for auxiliary equipment)	MessTec	AN3016	060105	9kHz~30MHz	Oct. 13, 2017	Jan. 17, 2018	Oct. 12, 2018	Conduction (CO01-KS)
AC Power Source	Chroma	61602	ABP0000008 11	AC 0V~300V, 45Hz~1000Hz	Oct. 12, 2017	Jan. 17, 2018	Oct. 11, 2018	Conduction (CO01-KS)
EMI Test Receiver	R&S	ESR7	101403	9kHz~7GHz; Max 30dBm	Aug. 08, 2017	Jan. 12, 2018	Aug. 07, 2018	Radiation (03CH02-KS)
EXA Spectrum Analyzer	Keysight	N9010A	MY55150208	10Hz~44GHz, MAX 30dB	Apr. 18, 2017	Jan. 12, 2018	Apr. 17, 2018	Radiation (03CH02-KS)
Bilog Antenna	TeseQ	CBL6112D	23182	30MHz~2GHz	Jan. 22, 2017	Jan. 12, 2018	Jan. 21, 2018	Radiation (03CH02-KS)
Double Ridge Horn Antenna	ETS-Lindgren	3117	75957	1GHz~18GHz	Oct. 21, 2017	Jan. 12, 2018	Oct. 20, 2018	Radiation (03CH02-KS)
SHF-EHF Horn	Schwarzbeck	BBHA 9170	BBHA170249	15GHz~40GHz	Feb. 15, 2017	Jan. 12, 2018	Feb. 14, 2018	Radiation (03CH02-KS)
Amplifier	MITEQ	TTA1840-35-H G	1887435	18GHz~40GHz	Oct. 12, 2017	Jan. 12, 2018	Oct. 11, 2018	Radiation (03CH02-KS)
Amplifier	SONOMA	310N	187289	9kHz~1GHz	Aug. 07, 2017	Jan. 12, 2018	Aug. 06, 2018	Radiation (03CH02-KS)
Amplifier	Agilent	8449B	3008A02384	1-26.5GHz Gain 30dB	Oct. 12, 2017	Jan. 12, 2018	Oct. 11, 2018	Radiation (03CH02-KS)
AC Power Source	Chroma	61601	61601000247 3	N/A	NCR	Jan. 12, 2018	NCR	Radiation (03CH02-KS)
Turn Table	MF	MF7802	N/A	0~360 degree	NCR	Jan. 12, 2018	NCR	Radiation (03CH02-KS)
Antenna Mast	MF	MF7802	N/A	1 m~4 m	NCR	Jan. 12, 2018	NCR	Radiation (03CH02-KS)

NCR: No Calibration Required



## 5. Uncertainty of Evaluation

### Uncertainty of Conducted Emission Measurement (150 kHz ~ 30 MHz)

Measuring Uncertainty for a Level of Confidence of 95% ( $U = 2Uc(y)$ )	2.3dB
---	-------

### Uncertainty of Radiated Emission Measurement (30 MHz ~ 1000 MHz)

Measuring Uncertainty for a Level of Confidence of 95% ( $U = 2Uc(y)$ )	4.5dB
---	-------

### Uncertainty of Radiated Emission Measurement (1GHz ~ 18GHz)

Measuring Uncertainty for a Level of Confidence of 95% ( $U = 2Uc(y)$ )	4.2dB
---	-------

### Uncertainty of Radiated Emission Measurement (18GHz ~ 40GHz)

Measuring Uncertainty for a Level of Confidence of 95% ( $U = 2Uc(y)$ )	4.7dB
---	-------