



FCC RF Test Report

APPLICANT : Motorola Mobility LLC
EQUIPMENT : Mobile Cellular Phone
BRAND NAME : Motorola
MODEL NAME : XT1925-6, XT1925-12, XT1925DL
FCC ID : IHDT56XD1
STANDARD : FCC 47 CFR Part 2, 27D
CLASSIFICATION : PCS Licensed Transmitter Held to Ear (PCE)

The product was received on Dec. 25, 2017 and completely tested on Jan. 14, 2018. We, Sporton International (Kunshan) Inc., would like to declare that the tested sample has been evaluated in accordance with the procedures given in ANSI/TIA-603-E and shown compliance with the applicable technical standards.

The test results in this report apply exclusively to the tested model / sample. Without written approval of Sporton International (Kunshan) Inc., the test report shall not be reproduced except in full.



Approved by: James Huang / Manager

Sporton International (Kunshan) Inc.

No.3-2 Ping-Xiang Rd, Kunshan Development Zone Kunshan City Jiangsu Province 215335
China



TABLE OF CONTENTS

REVISION HISTORY..... 3
SUMMARY OF TEST RESULT 4
1 GENERAL DESCRIPTION 5
1.1. Applicant 5
1.2. Manufacturer 5
1.3. Product Feature of Equipment Under Test..... 5
1.4. Product Specification of Equipment Under Test..... 5
1.5. Modification of EUT 6
1.6. Maximum Frequency Tolerance and Emission Designator and Conducted power 6
1.7. Testing Site 7
1.8. Applied Standards 7
1.9. Specification of Accessory 8
2 TEST CONFIGURATION OF EQUIPMENT UNDER TEST 9
2.1 Test Mode 9
2.2 Connection Diagram of Test System 10
2.3 Support Unit used in test configuration and system 10
2.4 Measurement Results Explanation Example 10
2.5 Frequency List of Low/Middle/High Channels 11
3 CONDUCTED TEST ITEMS 12
3.1 Measuring Instruments 12
3.2 Test Setup 12
3.3 Test Result of Conducted Test 12
3.4 Conducted Output Power Measurement 13
3.5 Peak-to-Average Ratio 14
3.6 EIRP Power Density 15
3.7 Occupied Bandwidth 16
3.8 Conducted Band Edge Measurement 17
3.9 Conducted Spurious Emission Measurement 18
3.10 Frequency Stability Measurement 19
4 RADIATED TEST ITEMS 20
4.1 Measuring Instruments 20
4.2 Test Setup 20
4.3 Test Result of Radiated Test 20
4.4 Radiated Spurious Emission Measurement 21
5 LIST OF MEASURING EQUIPMENT 22
6 UNCERTAINTY OF EVALUATION 23
APPENDIX A. TEST RESULTS OF CONDUCTED TEST
APPENDIX B. TEST RESULTS OF RADIATED TEST
APPENDIX C. TEST SETUP PHOTOGRAPHS



REVISION HISTORY

| REPORT NO. | VERSION | DESCRIPTION | ISSUED DATE |
|------------|---------|-------------------------|---------------|
| FG7D2507C | Rev. 01 | Initial issue of report | Jan. 30, 2018 |
| | | | |
| | | | |
| | | | |
| | | | |
| | | | |
| | | | |
| | | | |
| | | | |
| | | | |
| | | | |
| | | | |
| | | | |
| | | | |
| | | | |
| | | | |
| | | | |
| | | | |
| | | | |
| | | | |
| | | | |



SUMMARY OF TEST RESULT

| Report Section | FCC Rule | Description | Limit | Result | Remark |
|----------------|--------------------------|--|-------------------------------------|--------|---|
| 3.4 | §2.1046 | Conducted Output Power | Reporting Only | PASS | - |
| 3.5 | - | Peak-to-Average Ratio | <13dB | N/A | Reporting only |
| 3.6 | §27.50 (a)(3) | EIRP Power Density | EIRP < 250mW/5MHz | PASS | - |
| 3.7 | §2.1049 | Occupied Bandwidth | Reporting Only | PASS | - |
| 3.8 | §2.1051 §27.53 (a)(4) | Conducted Band Edge Measurement | Refer standard | PASS | - |
| 3.9 | §2.1051 §27.53 (a)(4) | Conducted Spurious Emission | < 70+10log ₁₀ (P[Watts]) | PASS | - |
| 3.10 | §2.1055 §27.54 | Frequency Stability Temperature & Voltage | Within the band | PASS | - |
| 4.4 | §2.1053 §27.53 (a)(4) | Radiated Spurious Emission | < 70+10log ₁₀ (P[Watts]) | PASS | Under limit 3.44 dB at 6932.000 MHz |



1 General Description

1.1. Applicant

Motorola Mobility LLC
222 W,Merchandise Mart Plaza, Chicago IL 60654 USA

1.2. Manufacturer

Motorola Mobility LLC
222 W,Merchandise Mart Plaza, Chicago IL 60654 USA

1.3. Product Feature of Equipment Under Test

| Product Feature | |
|---------------------------------|--|
| Equipment | Mobile Cellular Phone |
| Brand Name | Motorola |
| Model Name | XT1925-6, XT1925-12, XT1925DL |
| FCC ID | IHDT56XD1 |
| EUT supports Radios application | CDMA/EV-DO/GSM/GPRS/EGPRS/WCDMA/HSPA/HSPA+(Uplink is not supported)/DC-HSDPA/LTE/WLAN 2.4GHz 802.11b/g/n HT20/WLAN 5GHz 802.11a/n HT20/HT40 Bluetooth v3.0 + EDR/Bluetooth v4.0 LE/Bluetooth v4.1 LE/Bluetooth v4.2 LE |
| IMEI Code | Conducted: 351849090020715 Radiation: 351884090035585 |
| HW Version | DVT1B |
| SW Version | ali_n-userdebug 8.0.0 OPS27.55 1276 intcfg,test-keys |
| EUT Stage | Identical Prototype |

1.4. Product Specification of Equipment Under Test

| Product Feature | |
|---------------------------------|--|
| Tx Frequency | LTE Band 30 : 2307.5 MHz ~ 2312.5 MHz |
| Rx Frequency | LTE Band 30 : 2352.5 MHz ~ 2357.5 MHz |
| Bandwidth | 5MHz / 10MHz |
| Maximum Output Power to Antenna | LTE Band 30 : 23.22 dBm |
| Antenna Type/Gain | PIFA Antenna / 0.33dBi (Antenna #2) PIFA Antenna / 0.23dBi (Antenna #3) |
| Type of Modulation | QPSK / 16QAM / 64QAM |

1.5. Modification of EUT

No modifications are made to the EUT during all test items.

1.6. Maximum Frequency Tolerance and Emission Designator and Conducted power

| LTE Band 30 | | QPSK | | | 16QAM | | |
|-------------|-----------------------|------------------------------|---------------------------|----------------------------|------------------------------|---------------------------|----------------------------|
| BW (MHz) | Frequency Range (MHz) | Emission Designator (99%OBW) | Frequency Tolerance (ppm) | Maximum Conducted power(W) | Emission Designator (99%OBW) | Frequency Tolerance (ppm) | Maximum Conducted power(W) |
| 5 | 2307.5 ~ 2312.5 | 4M50G7D | - | 0.1995 | 4M51W7D | - | 0.1702 |
| 10 | 2310.0 | 9M05G7D | 0.0022 | 0.2099 | 9M03W7D | - | 0.1754 |
| LTE Band 30 | | 64QAM | | | | | |
| BW (MHz) | Frequency Range (MHz) | Emission Designator (99%OBW) | Frequency Tolerance (ppm) | Maximum Conducted power(W) | | | |
| 5 | 2307.5 ~ 2312.5 | 4M55W7D | - | 0.1337 | | | |
| 10 | 2310.0 | 8M99W7D | - | 0.1365 | | | |

1.7. Testing Site

Sporton International (Kunshan) Inc. is accredited to ISO 17025 by National Voluntary Laboratory Accreditation Program (NVLAP code: 600155-0) and the FCC designation No. is CN5013.

| | | | |
|---------------------------|---|-----------|---------------------------------------|
| Test Site | Sporton International (Kunshan) Inc. | | |
| Test Site Location | No.3-2 Ping-Xiang Rd, Kunshan Development Zone Kunshan City Jiangsu Province 215335 China TEL : +86-512-57900158 FAX : +86-512-57900958 | | |
| Test Site No. | Sporton Site No. | | FCC Test Firm Registration No. |
| | TH01-KS | 03CH03-KS | 630927 |

Note: The test site complies with ANSI C63.4 2014 requirement.

1.8. Applied Standards

According to the specifications of the manufacturer, the EUT must comply with the requirements of the following standards:

- ♦ 47 CFR Part 2, Part 27(D)
- ♦ ANSI/TIA-603-E
- ♦ FCC KDB 971168 D01 Power Meas. License Digital Systems v03

Remark:

1. All test items were verified and recorded according to the standards and without any deviation during the test.
2. This EUT has also been tested and complied with the requirements of FCC Part 15, Subpart B, recorded in a separate test report.

1.9. Specification of Accessory

| Specification of Accessory | | | | |
|----------------------------|------------------|--|------------|---------------------|
| AC Adapter 1(US) | Brand Name | Motorola (Salom) | Model Name | SC-22 |
| | Power Rating | I/P: 100-240 Vac, 500mA, O/P: 5Vdc,3000mA or 9Vdc,1600mA or 12Vdc,1200mA | | |
| AC Adapter 1(EU) | Brand Name | Motorola (Salom) | Model Name | SC-23 |
| | Power Rating | I/P: 100-240 Vac, 500mA, O/P: 5Vdc,3000mA or 9Vdc,1600mA or 12Vdc,1200mA | | |
| AC Adapter 1(UK) | Brand Name | Motorola (Salom) | Model Name | SC-24 |
| | Power Rating | I/P: 100-240 Vac, 500mA, O/P: 5Vdc,3000mA or 9Vdc,1600mA or 12Vdc,1200mA | | |
| AC Adapter 1(IN) | Brand Name | Motorola (Salom) | Model Name | SC-25 |
| | Power Rating | I/P: 100-240 Vac, 500mA, O/P: 5Vdc,3000mA or 9Vdc,1600mA or 12Vdc,1200mA | | |
| AC Adapter 1(AU) | Brand Name | Motorola (Salom) | Model Name | SC-26 |
| | Power Rating | I/P: 100-240 Vac, 500mA, O/P: 5Vdc,3000mA or 9Vdc,1600mA or 12Vdc,1200mA | | |
| AC Adapter 2(US) | Brand Name | Motorola (Chenyang) | Model Name | SC-22 |
| | Power Rating | I/P: 100-240 Vac, 500mA, O/P: 5Vdc,3000mA or 9Vdc,1600mA or 12Vdc,1200mA | | |
| AC Adapter 2(EU) | Brand Name | Motorola (Chenyang) | Model Name | SC-23 |
| | Power Rating | I/P: 100-240 Vac, 500mA, O/P: 5Vdc,3000mA or 9Vdc,1600mA or 12Vdc,1200mA | | |
| AC Adapter 2(UK) | Brand Name | Motorola (Chenyang) | Model Name | SC-24 |
| | Power Rating | I/P: 100-240 Vac, 500mA, O/P: 5Vdc,3000mA or 9Vdc,1600mA or 12Vdc,1200mA | | |
| AC Adapter 2(IN) | Brand Name | Motorola (Chenyang) | Model Name | SC-25 |
| | Power Rating | I/P: 100-240 Vac, 500mA, O/P: 5Vdc,3000mA or 9Vdc,1600mA or 12Vdc,1200mA | | |
| AC Adapter 2(AU) | Brand Name | Motorola (Chenyang) | Model Name | SC-26 |
| | Power Rating | I/P: 100-240 Vac, 500mA, O/P: 5Vdc,3000mA or 9Vdc,1600mA or 12Vdc,1200mA | | |
| Battery | Brand Name | Motorola (ATL) | Model Name | HG30 |
| | Power Rating | 3.8Vdc,3000mAh | Type | Li-ion |
| Earphone 1 | Brand Name | Motorola (Jiahe) | Model Name | LS-118M-12 |
| | Signal Line Type | 1.2 meter, non-shielded cable, without ferrite core | | |
| Earphone 2 | Brand Name | Motorola (Lianyun) | Model Name | TS910A-38AMS01WHR-M |
| | Signal Line Type | 1.2 meter, non-shielded cable, without ferrite core | | |
| USB Cable | Brand Name | Motorola (Liqi) | Model Name | L32B-053000100-ALL |
| | Signal Line Type | 1.0 meter, shielded cable, without ferrite core | | |



2 Test Configuration of Equipment Under Test

2.1 Test Mode

Antenna port conducted and radiated test items listed below are performed according to KDB 971168 D01 Power Meas. License Digital Systems v03 with maximum output power.

Radiated measurements are performed by rotating the EUT in three different orthogonal test planes to find the maximum emission.

| Conducted Test Cases | Band | Bandwidth (MHz) | | | | | | Modulation | | | RB # | | | Test Channel | | | |
|-----------------------------|---|-----------------|---|---|----|----|----|------------|-------|-------|------|------|------|--------------|---|---|---|
| | | 1.4 | 3 | 5 | 10 | 15 | 20 | QPSK | 16QAM | 64QAM | 1 | Half | Full | L | M | H | |
| Max. Output Power | 30 | - | - | V | | - | - | V | V | V | V | V | V | V | V | V | |
| | | - | - | | V | - | - | V | V | V | V | V | V | | V | | |
| Peak-to-Average Ratio | 30 | - | - | | V | - | - | V | V | V | V | | V | | V | | |
| E.I.R.P PSD | 30 | - | - | V | | - | - | V | V | V | V | | | V | V | V | |
| | | - | - | | V | - | - | V | V | V | V | | | | V | | |
| 26dB and 99% Bandwidth | 30 | - | - | V | | - | - | V | V | V | | | V | V | V | V | |
| | | - | - | | V | - | - | V | V | V | | | V | | V | | |
| Conducted Band Edge | 30 | - | - | V | | - | - | V | V | V | V | | V | V | | V | |
| | | - | - | | V | - | - | V | V | V | V | | V | | V | | |
| Conducted Spurious Emission | 30 | - | - | V | | - | - | V | V | V | V | | | V | V | V | |
| | | - | - | | V | - | - | V | V | V | V | | | | V | | |
| Frequency Stability | 30 | - | - | | V | - | - | V | | | | | V | | V | | |
| Radiated Spurious Emission | 30 | - | - | V | | - | - | V | | | | V | | | V | V | V |
| | | | | | V | | | V | | | | V | | | | V | |
| Note | <ol style="list-style-type: none"> The mark "v " means that this configuration is chosen for testing The mark "- " means that this bandwidth is not supported. The device is investigated from 30MHz to 10 times of fundamental signal for radiated spurious emission test under different RB size/offset and modulations in exploratory test. Subsequently, only the worst case emissions are reported. | | | | | | | | | | | | | | | | |

2.2 Connection Diagram of Test System

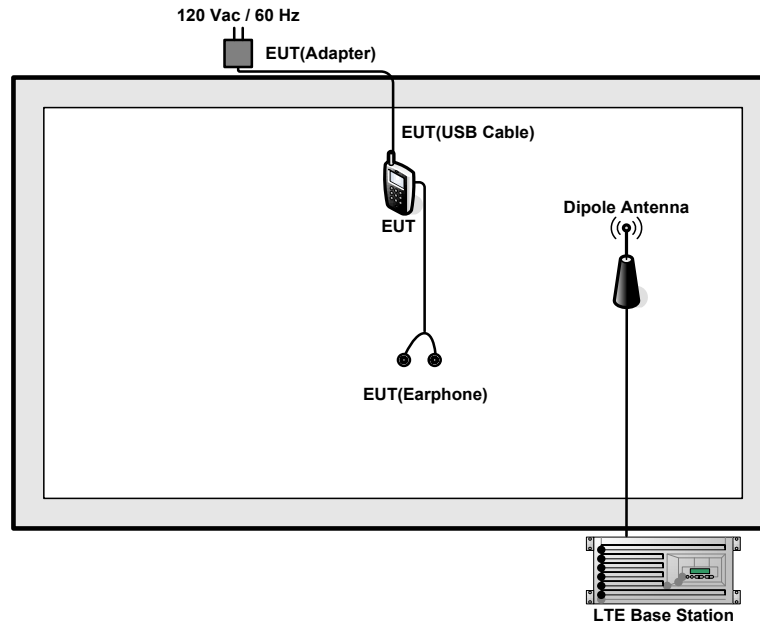

2.3 Support Unit used in test configuration and system

| Item | Equipment | Trade Name | Model No. | FCC ID | Data Cable | Power Cord |
|------|------------------|------------|-----------|--------|------------|-------------------|
| 1. | LTE Base Station | Anritsu | MT8820C | N/A | N/A | Unshielded, 1.8 m |
| 2. | DC Power Supply | GW INSTRON | GPS-3030D | N/A | N/A | Unshielded, 1.8 m |

2.4 Measurement Results Explanation Example

For all conducted test items:

The offset level is set in the spectrum analyzer to compensate the RF cable loss between EUT conducted output port and spectrum analyzer. With the offset compensation, the spectrum analyzer reading level is exactly the EUT RF output level.

Example:

The spectrum analyzer offset is derived from RF cable loss.

$Offset = RF\ cable\ loss.$

The following shows an offset computation example with RF cable loss 5.4dB.

Example :

$Offset(dB) = RF\ cable\ loss(dB).$
 $= 5.4 (dB)$



2.5 Frequency List of Low/Middle/High Channels

| LTE Band 30 Channel and Frequency List | | | | |
|--|------------------------|--------|--------|---------|
| BW [MHz] | Channel/Frequency(MHz) | Lowest | Middle | Highest |
| 10 | Channel | - | 27710 | - |
| | Frequency | - | 2310 | - |
| 5 | Channel | 27685 | 27710 | 27735 |
| | Frequency | 2307.5 | 2310 | 2312.5 |

3 Conducted Test Items

3.1 Measuring Instruments

See list of measuring instruments of this test report.

3.2 Test Setup

3.2.1 Conducted Output Power

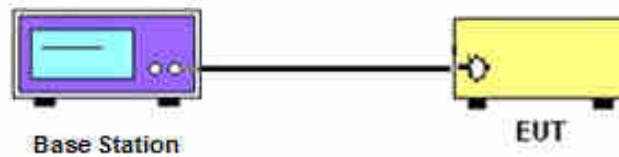

3.2.2 Peak-to-Average Ratio, Occupied / 26dB Bandwidth ,Band-Edge and Conducted Spurious Emission

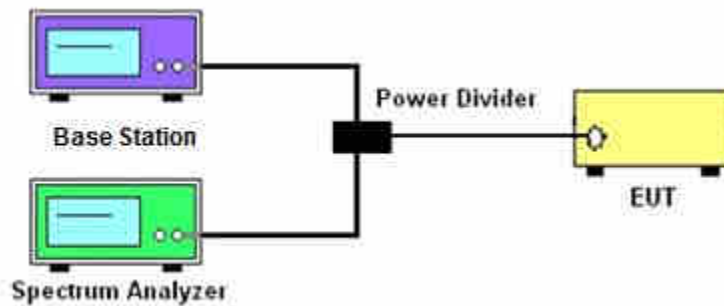

3.2.3 Frequency Stability

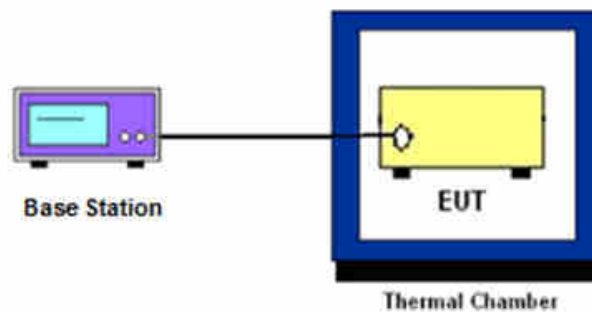

3.3 Test Result of Conducted Test

Please refer to Appendix A.



3.4 Conducted Output Power Measurement

3.4.1 Description of the Conducted Output Power Measurement

A base station simulator was used to establish communication with the EUT. Its parameters were set to transmit the maximum power on the EUT. The measured power in the radio frequency on the transmitter output terminals shall be reported.

3.4.2 Test Procedures

1. The transmitter output port was connected to base station.
2. Set EUT at maximum power through base station.
3. Select lowest, middle, and highest channels for each band and different modulation.



3.5 Peak-to-Average Ratio

3.5.1 Description of the PAR Measurement

Power Complementary Cumulative Distribution Function (CCDF) curves provide a means for characterizing the power peaks of a digitally modulated signal on a statistical basis. A CCDF curve depicts the probability of the peak signal amplitude exceeding the average power level. Most contemporary measurement instrumentation include the capability to produce CCDF curves for an input signal provided that the instrument's resolution bandwidth can be set wide enough to accommodate the entire input signal bandwidth. In measuring transmissions in this band using an average power technique, the peak-to-average ratio (PAR) of the transmission may not exceed 13 dB.

3.5.2 Test Procedures

1. The testing follows FCC KDB 971168 D01 v03 Section 5.7.1.
2. The EUT was connected to spectrum and system simulator via a power divider.
3. Set the CCDF (Complementary Cumulative Distribution Function) option in spectrum analyzer.
4. The highest RF powers were measured and recorded the maximum PAPR level associated with a probability of 0.1 %.
5. Record the deviation as Peak to Average Ratio.



3.6 EIRP Power Density

3.6.1 Description of EIRP Power Density

For mobile and portable stations transmitting in the 2305-2315 MHz band or the 2350-2360 MHz band, the average EIRP must not exceed 50 milliwatts within any 1 megahertz of authorized bandwidth, *except that* for mobile and portable stations compliant with 3GPP LTE standards or another advanced mobile broadband protocol that avoids concentrating energy at the edge of the operating band the average EIRP must not exceed 250 milliwatts within any 5 megahertz of authorized bandwidth but may exceed 50 milliwatts within any 1 megahertz of authorized bandwidth. For mobile and portable stations using time division duplexing (TDD) technology, the duty cycle must not exceed 38 percent in the 2305-2315 MHz and 2350-2360 MHz bands. Mobile and portable stations using FDD technology are restricted to transmitting in the 2305-2315 MHz band. Power averaging shall not include intervals in which the transmitter is off.

3.6.2 Test Procedures

1. Set instrument center frequency to OBW center frequency.
2. Set span to at least 1.5 times the OBW.
3. Set the RBW to the specified reference bandwidth (often 1 MHz).
4. Set VBW $\geq 3 \times$ RBW.
5. Detector = RMS (power averaging).
6. Ensure that the number of measurement points in the sweep $\geq 2 \times$ span/RBW.
7. Sweep time = auto couple.
8. Employ trace averaging (RMS) mode over a minimum of 100 traces.
9. Use the peak marker function to determine the maximum amplitude level within the reference bandwidth (PSD).

3.7 Occupied Bandwidth

3.7.1 Description of Occupied Bandwidth Measurement

The occupied bandwidth is the width of a frequency band such that, below the lower and above the upper frequency limits, the mean powers emitted are each equal to a specified percentage 0.5% of the total mean transmitted power.

The 26dB occupied bandwidth is the width of a frequency band such that, below the lower and above the upper frequency limits, the mean powers emitted are each equal 26 dB.

The 26 dB emission bandwidth(EBW) is defined as the frequency range between two points, one above and one below the carrier frequency, at which the spectral density of the emission is attenuated 26 dB below the maximum in-band spectral density of the modulated signal. Spectral density (power per unit bandwidth) is to be measured with a detector of resolution bandwidth equal to approximately 1.0% of the emission bandwidth.

3.7.2 Test Procedures

1. The EUT was connected to Spectrum Analyzer and Base Station via power divider.
2. The 26dB and 99% occupied bandwidth (BW) of the middle channel for the highest RF powers with full RB sizes were measured.

3.8 Conducted Band Edge Measurement

3.8.1 Description of Conducted Band Edge Measurement

27.53 (a)(4)

For mobile and portable stations operating in the 2305-2315 MHz and 2350-2360 MHz bands:

(i) By a factor of not less than: $43 + 10 \log (P)$ dB on all frequencies between 2305 and 2320 MHz and on all frequencies between 2345 and 2360 MHz that are outside the licensed band(s) of operation, not less than $55 + 10 \log (P)$ dB on all frequencies between 2320 and 2324 MHz and on all frequencies between 2341 and 2345 MHz, not less than $61 + 10 \log (P)$ dB on all frequencies between 2324 and 2328 MHz and on all frequencies between 2337 and 2341 MHz, and not less than $67 + 10 \log (P)$ dB on all frequencies between 2328 and 2337 MHz;

(ii) By a factor of not less than $43 + 10 \log (P)$ dB on all frequencies between 2300 and 2305 MHz, $55 + 10 \log (P)$ dB on all frequencies between 2296 and 2300 MHz, $61 + 10 \log (P)$ dB on all frequencies between 2292 and 2296 MHz, $67 + 10 \log (P)$ dB on all frequencies between 2288 and 2292 MHz, and $70 + 10 \log (P)$ dB below 2288 MHz;

(iii) By a factor of not less than $43 + 10 \log (P)$ dB on all frequencies between 2360 and 2365 MHz, and not less than $70 + 10 \log (P)$ dB above 2365 MHz.

3.8.2 Test Procedures

1. The EUT was connected to Spectrum Analyzer and Base Station via power divider.
2. The band edges of low and high channels were measured with $RBW \geq 1\%$ EBW set in Spectrum Analyzer, while the EUT was transmitting under maximum power.
3. The RF fundamental frequency should be excluded against the limit line in the operating frequency band.
4. The limit line is derived from $43 + 10\log(P)$ dB below the transmitter power P(Watts)
 $= P(W) - [43 + 10\log(P)]$ (dB) = $[30 + 10\log(P)]$ (dBm) - $[43 + 10\log(P)]$ (dB) = -13dBm.

3.9 Conducted Spurious Emission Measurement

3.9.1 Description of Conducted Spurious Emission Measurement

The power of any emission outside of the authorized operating frequency ranges must be lower than the transmitter power (P) by a factor of at least $70 + 10 \log (P)$ dB.

It is measured by means of a calibrated spectrum analyzer and scanned from 30MHz up to a frequency including its 10th harmonic.

3.9.2 Test Procedures

1. The EUT was connected to spectrum analyzer and base station via power divider.
2. The RF output of EUT was connected to the spectrum analyzer by RF cable and attenuator. The path loss was compensated to the results for each measurement.
3. The middle channel for the highest RF power within the transmitting frequency was measured.
4. The conducted spurious emission for the whole frequency range was taken.
5. Make the measurement with the spectrum analyzer's RBW = 1MHz, VBW = 3MHz, taking the record of maximum spurious emission.
6. The RF fundamental frequency should be excluded against the limit line in the operating frequency band.
7. The limit line is derived from $70 + 10\log(P)$ dB below the transmitter power P(Watts)
= $P(W) - [70 + 10\log(P)]$ (dB)
= $[30 + 10\log(P)]$ (dBm) - $[70 + 10\log(P)]$ (dB)
= -40dBm.

3.10 Frequency Stability Measurement

3.10.1 Description of Frequency Stability Measurement

The frequency stability shall be measured by variation of ambient temperature and variation of primary supply voltage to ensure that the fundamental emission stays within the authorized frequency block. The frequency stability of the transmitter shall be maintained within $\pm 0.00025\%$ ($\pm 2.5\text{ppm}$) of the center frequency.

3.10.2 Test Procedures for Temperature Variation

1. The EUT was set up in the thermal chamber and connected with the base station.
2. With power OFF, the temperature was decreased to -30°C and the EUT was stabilized before testing. Power was applied and the maximum change in frequency was recorded within one minute.
3. With power OFF, the temperature was raised in 10°C step up to 50°C . The EUT was stabilized at each step for at least half an hour. Power was applied and the maximum frequency change was recorded within one minute.

3.10.3 Test Procedures for Voltage Variation

1. The EUT was placed in a temperature chamber at $25\pm 5^{\circ}\text{C}$ and connected with the base station.
2. The power supply voltage to the EUT was varied from 85% to 115% of the nominal value measured at the input to the EUT.
3. The variation in frequency was measured for the worst case.

4 Radiated Test Items

4.1 Measuring Instruments

See list of measuring instruments of this test report.

4.2 Test Setup

4.2.1 For radiated test from 30MHz to 1GHz

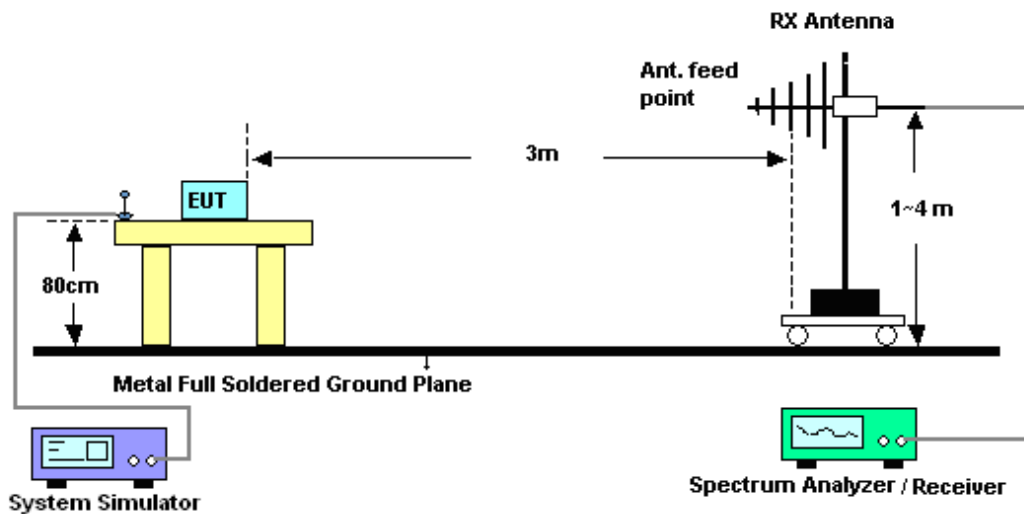

4.2.2 For radiated test above 1GHz

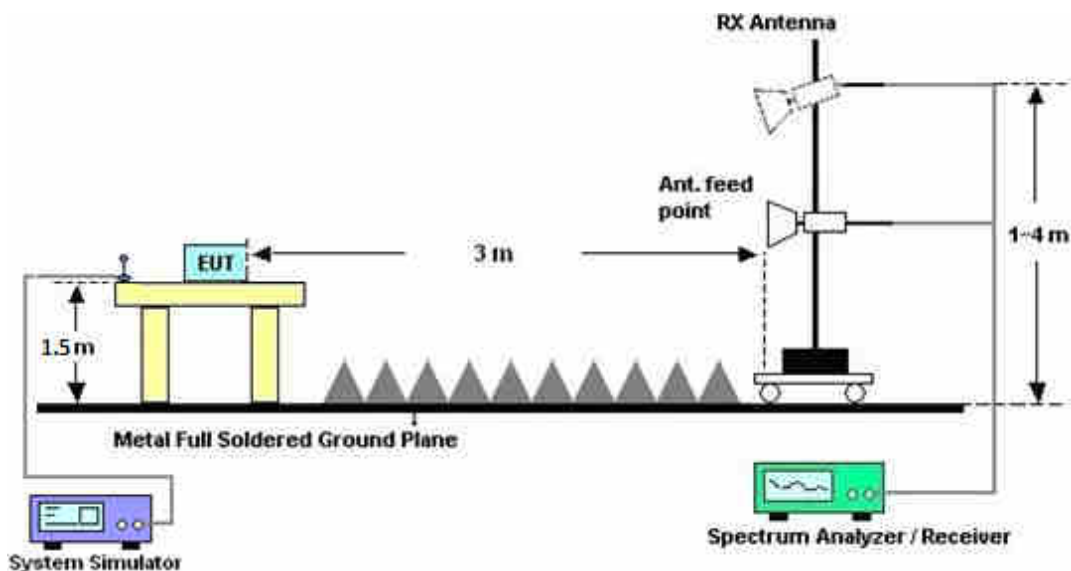

4.3 Test Result of Radiated Test

Please refer to Appendix B.



4.4 Radiated Spurious Emission Measurement

4.4.1 Description of Radiated Spurious Emission

The radiated spurious emission was measured by substitution method according to ANSI/TIA-603-E. The power of any emission outside of the authorized operating frequency ranges must be attenuated below the transmitter power (P) by a factor of at least $70 + 10 \log (P)$ dB.

4.4.2 Test Procedures

1. The EUT was placed on a turntable with 0.8 meter for frequency below 1GHz and 1.5 meter for frequency above 1GHz respectively above ground.
2. The EUT was set 3 meters from the receiving antenna, which was mounted on the antenna tower.
3. The table was rotated 360 degrees to determine the position of the highest spurious emission.
4. The height of the receiving antenna is varied between one meter and four meters to search the maximum spurious emission for both horizontal and vertical polarizations.
5. Make the measurement with the spectrum analyzer's RBW = 1MHz, VBW = 3MHz, Sweep = 500ms, Taking the record of maximum spurious emission.
6. A horn antenna was substituted in place of the EUT and was driven by a signal generator.
7. Tune the output power of signal generator to the same emission level with EUT maximum spurious emission.
8. Taking the record of output power at antenna port.
9. Repeat step 7 to step 8 for another polarization.
10. The RF fundamental frequency should be excluded against the limit line in the operating frequency band.
The limit line is derived from $70 + 10\log(P)$ dB below the transmitter power P(Watts)
 $= P(W) - [70 + 10\log(P)]$ (dB)
 $= [30 + 10\log(P)]$ (dBm) - $[70 + 10\log(P)]$ (dB)
 $= -40$ dBm.
11. EIRP (dBm) = S.G. Power – Tx Cable Loss + Tx Antenna Gain



5 List of Measuring Equipment

| Instrument | Manufacturer | Model No. | Serial No. | Characteristics | Calibration Date | Test Date | Due Date | Remark |
|------------------------------|--------------|----------------|------------|----------------------|------------------|---------------------------------|---------------|-----------------------|
| Spectrum Analyzer | R&S | FSV40 | 101040 | 10Hz~40GHz | Aug. 08, 2017 | Dec. 27, 2017~ Dec. 31, 2017 | Aug. 07, 2018 | Conducted (TH01-KS) |
| Radio communication analyzer | Anritsu | MT8820C | 6201300652 | 2G/3G/LTE_ full band | Aug. 08, 2017 | Dec. 27, 2017~ Dec. 31, 2017 | Aug. 07, 2018 | Conducted (TH01-KS) |
| Thermal Chamber | Ten Billion | TTC-B3S | TBN-960502 | -40~+150°C | Oct. 12, 2017 | Dec. 27, 2017~ Dec. 31, 2017 | Oct. 11, 2018 | Conducted (TH01-KS) |
| EXA Spectrum Analyzer | Keysight | N9010A | MY55150244 | 10Hz~44GHz | Apr. 18, 2017 | Jan. 14, 2018 | Apr. 17, 2018 | Radiation (03CH03-KS) |
| Bilog Antenna | TeseQ | CBL6112D | 35406 | 25MHz~2GHz | Apr. 22, 2017 | Jan. 14, 2018 | Apr. 21, 2018 | Radiation (03CH03-KS) |
| Horn Antenna | Schwarzbeck | BBHA9120 D | 9120D-1356 | 1GHz~18GHz | Apr. 22, 2017 | Jan. 14, 2018 | Apr. 21, 2018 | Radiation (03CH03-KS) |
| SHF-EHF Horn | Schwarzbeck | BBHA 9170 | BBHA170249 | 15GHz~40GHz | Feb. 15, 2017 | Jan. 14, 2018 | Feb. 14, 2018 | Radiation (03CH03-KS) |
| Amplifier | com-power | PA-103A | 161069 | 1MHz~1000MHz / 32 dB | Apr. 18, 2017 | Jan. 14, 2018 | Apr. 17, 2018 | Radiation (03CH03-KS) |
| Amplifier | MITEQ | TTA1840-35 -HG | 1887435 | 18GHz~40GHz | Oct. 12, 2017 | Jan. 14, 2018 | Oct. 11, 2018 | Radiation (03CH03-KS) |
| Amplifier | Agilent | 8449B | 3008A02370 | 1GHz~26.5GHz | Oct. 12, 2017 | Jan. 14, 2018 | Oct. 11, 2018 | Radiation (03CH03-KS) |
| AC Power Source | Chroma | 61601 | F104090004 | N/A | NCR | Jan. 14, 2018 | NCR | Radiation (03CH03-KS) |
| Turn Table | ChamPro | EM 1000-T | 060762-T | 0~360 degree | NCR | Jan. 14, 2018 | NCR | Radiation (03CH03-KS) |
| Antenna Mast | ChamPro | EM 1000-A | 060762-A | 1 m~4 m | NCR | Jan. 14, 2018 | NCR | Radiation (03CH03-KS) |

NCR: No Calibration Required



6 Uncertainty of Evaluation

Uncertainty of Radiated Emission Measurement (30 MHz ~ 1000 MHz)

| | |
|---|--------|
| Measuring Uncertainty for a Level of Confidence of 95% ($U = 2Uc(y)$) | 2.8 dB |
|---|--------|

Uncertainty of Radiated Emission Measurement (1 GHz ~ 40 GHz)

| | |
|---|--------|
| Measuring Uncertainty for a Level of Confidence of 95% ($U = 2Uc(y)$) | 3.3 dB |
|---|--------|



Appendix A. Test Results of Conducted Test

Conducted Output Power(Average power)

| LTE Band 30 Maximum Average Power [dBm] | | | | | | |
|---|---------|-----------|--------|--------|--------|---------|
| BW [MHz] | RB Size | RB Offset | Mod | Lowest | Middle | Highest |
| 5 | 1 | 0 | QPSK | 22.78 | 22.86 | 23 |
| 5 | 1 | 12 | | 22.72 | 22.92 | 22.84 |
| 5 | 1 | 24 | | 22.96 | 22.81 | 22.84 |
| 5 | 12 | 0 | | 21.87 | 21.89 | 21.97 |
| 5 | 12 | 7 | | 21.87 | 21.95 | 21.96 |
| 5 | 12 | 13 | | 21.86 | 21.96 | 21.94 |
| 5 | 25 | 0 | | 21.95 | 22.03 | 21.97 |
| 5 | 1 | 0 | 16-QAM | 22.19 | 22.16 | 22.31 |
| 5 | 1 | 12 | | 22.07 | 22.09 | 22.07 |
| 5 | 1 | 24 | | 22.07 | 22.25 | 22.27 |
| 5 | 12 | 0 | | 20.88 | 20.98 | 21 |
| 5 | 12 | 7 | | 20.89 | 21 | 21.01 |
| 5 | 12 | 13 | | 20.84 | 21.01 | 20.96 |
| 5 | 25 | 0 | | 20.94 | 20.99 | 21.05 |
| 5 | 1 | 0 | 64QAM | 21.06 | 21.04 | 21.26 |
| 5 | 1 | 12 | | 20.95 | 21.02 | 21.18 |
| 5 | 1 | 24 | | 20.92 | 20.96 | 21.21 |
| 5 | 12 | 0 | | 19.92 | 19.98 | 20.05 |
| 5 | 12 | 7 | | 19.92 | 19.97 | 20.03 |
| 5 | 12 | 13 | | 19.87 | 19.96 | 19.98 |
| 5 | 25 | 0 | | 19.94 | 20.03 | 20.03 |



| | | | | | | |
|----|----|----|--------|---|-------|---|
| 10 | 1 | 0 | QPSK | | 23.19 | |
| 10 | 1 | 25 | | | 22.89 | |
| 10 | 1 | 49 | | | 23.22 | |
| 10 | 25 | 0 | | | 22.01 | |
| 10 | 25 | 12 | | | 21.95 | |
| 10 | 25 | 25 | | | 21.97 | |
| 10 | 50 | 0 | | | 22.01 | |
| 10 | 1 | 0 | 16-QAM | - | 22.38 | - |
| 10 | 1 | 25 | | | 22.18 | |
| 10 | 1 | 49 | | | 22.44 | |
| 10 | 25 | 0 | | | 20.88 | |
| 10 | 25 | 12 | | | 21.04 | |
| 10 | 25 | 25 | | | 21.03 | |
| 10 | 50 | 0 | | | 20.97 | |
| 10 | 1 | 0 | 64QAM | | 21.19 | |
| 10 | 1 | 25 | | | 21.11 | |
| 10 | 1 | 49 | | | 21.35 | |
| 10 | 25 | 0 | | | 19.83 | |
| 10 | 25 | 12 | | | 20.02 | |
| 10 | 25 | 25 | | | 20.06 | |
| 10 | 50 | 0 | | | 19.96 | |



Peak-to-Average Ratio

| Mode | LTE Band 30 / 10MHz | | | | |
|------------|---------------------|---------|-------------|---------|-------------|
| Mod. | QPSK | | 16QAM | | Limit: 13dB |
| RB Size | 1RB | Full RB | 1RB | Full RB | Result |
| Lowest CH | - | - | - | - | PASS |
| Middle CH | 3.71 | 4.78 | 4.61 | 5.8 | |
| Highest CH | - | - | - | - | |
| Mod. | 64QAM | | Limit: 13dB | | |
| RB Size | 1RB | Full RB | Result | | |
| Lowest CH | | | PASS | | |
| Middle CH | 5.62 | 6.35 | | | |
| Highest CH | | | | | |



LTE Band 30 / 10MHz / QPSK

Middle Channel / 1RB

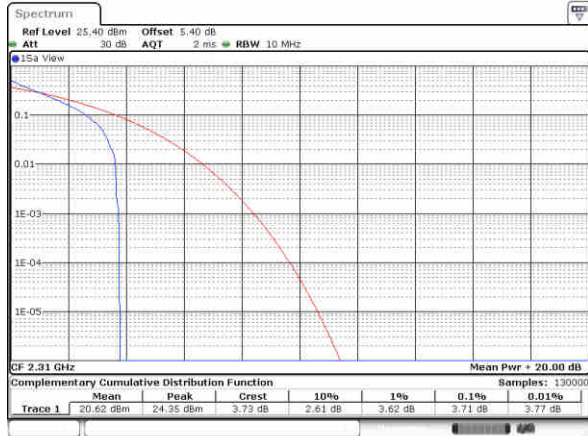

Date: 27 DEC 2017 22:47:03

Middle Channel / Full RB

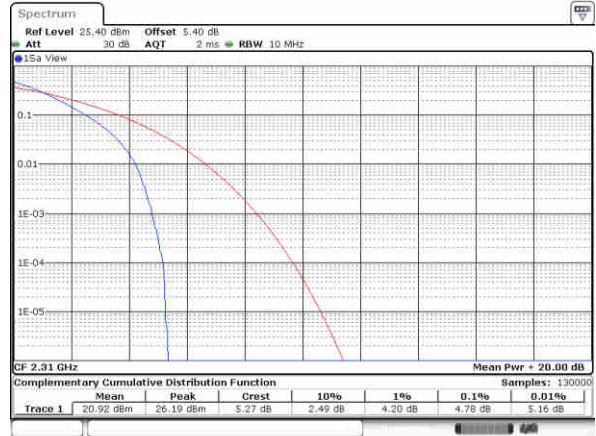

Date: 27 DEC 2017 22:47:19

LTE Band 30 / 10MHz / 16QAM

Middle Channel / 1RB

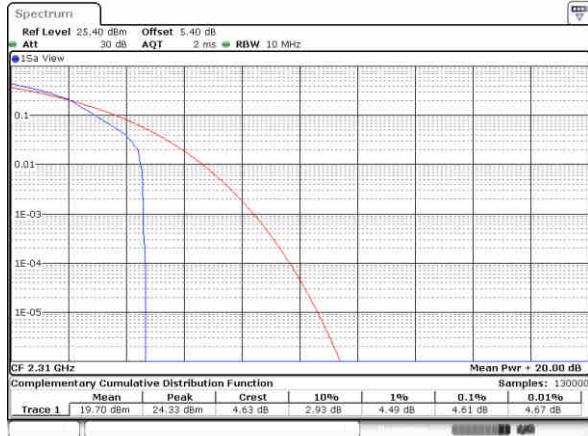

Date: 27 DEC 2017 22:46:50

Middle Channel / Full RB

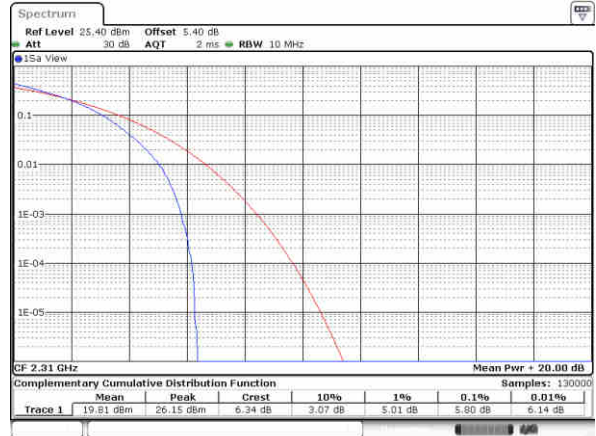

Date: 27 DEC 2017 22:47:38

LTE Band 30 / 10MHz / 64QAM

Middle Channel / 1RB

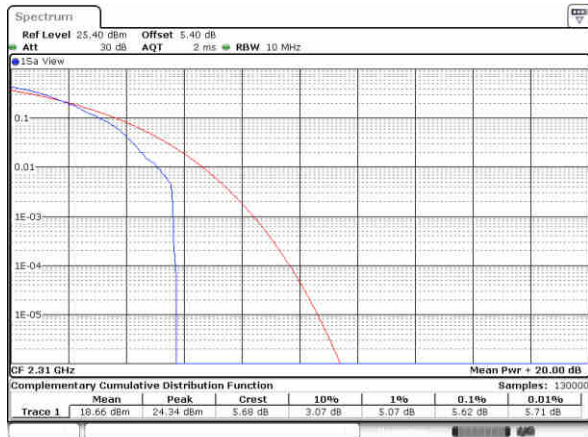

Date: 27 DEC 2017 22:48:18

Middle Channel / Full RB

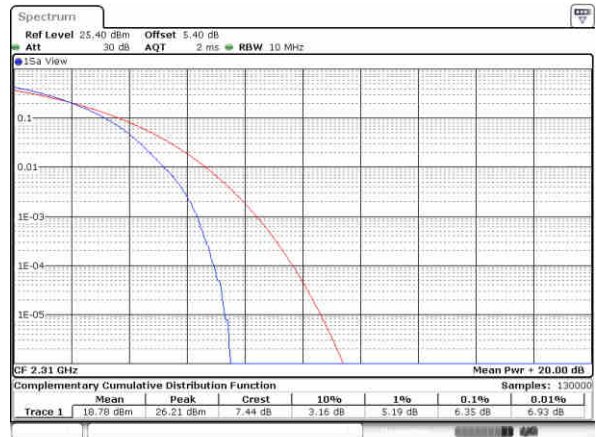

Date: 27 DEC 2017 22:48:04



EIRP Power Density

| Mode | LTE Band 30 : Conducted Power Density (dBm/5MHz) | | | | | | | | | | |
|------------|--|-------|-------|-------|-------|-------|--|--|--|--|--|
| | 5MHz | | 10MHz | | 5MHz | 10MHz | | | | | |
| BW | | | | | | | | | | | |
| Mod. | QPSK | 16QAM | QPSK | 16QAM | 64QAM | 64QAM | | | | | |
| Lowest CH | 23.31 | 22.57 | | | 21.57 | | | | | | |
| Middle CH | 23.25 | 22.61 | 23.39 | 22.57 | 21.45 | 21.42 | | | | | |
| Highest CH | 23.25 | 22.37 | | | 21.40 | | | | | | |

| Mode | LTE Band 30 : EIRP Power Density (dBm/5MHz) | | | | | | | | | | |
|--------------|---|-------|-------|-------|-------|-------|--|--|--|--|--|
| | 5MHz | | 10MHz | | 5MHz | 10MHz | | | | | |
| BW | | | | | | | | | | | |
| Mod. | QPSK | 16QAM | QPSK | 16QAM | 64QAM | 64QAM | | | | | |
| Lowest CH | 23.64 | 22.9 | | | 21.9 | | | | | | |
| Middle CH | 23.58 | 22.94 | 23.72 | 22.9 | 21.78 | 21.75 | | | | | |
| Highest CH | 23.58 | 22.7 | | | 21.73 | | | | | | |
| Antenna Gain | 0.33 dBi | | | | | | | | | | |
| Limit | 250mW / 5MHz = 24dBm / 5MHz | | | | | | | | | | |
| Result | PASS | | | | | | | | | | |



LTE Band 30 / 5MHz

Lowest Channel / 5MHz / 1RB24 / QPSK

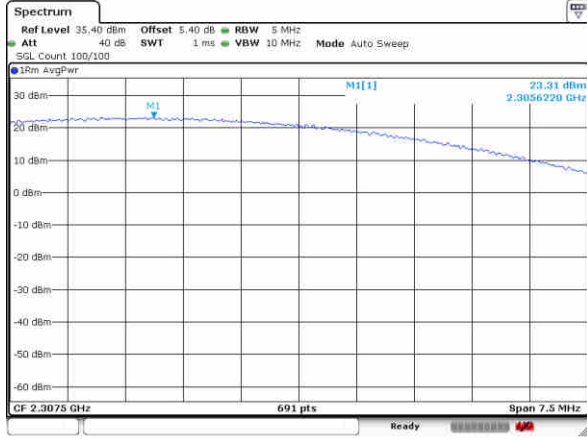

Date: 27 DEC 2017 23:08:03

Lowest Channel / 5MHz / 1RB0 / 16QAM



Date: 27 DEC 2017 23:08:50

Middle Channel / 5MHz / 1RB12 / QPSK

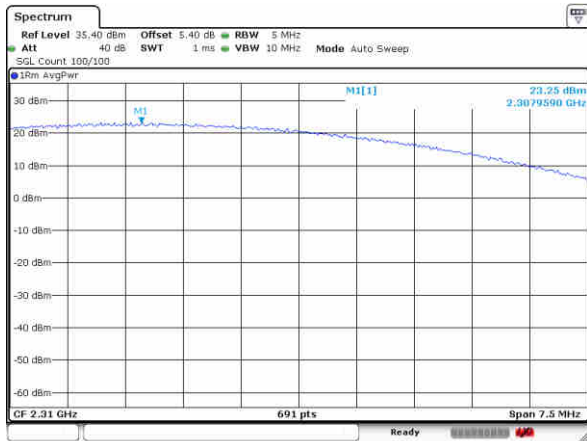

Date: 27 DEC 2017 23:10:58

Middle Channel / 5MHz / 1RB24 / 16QAM

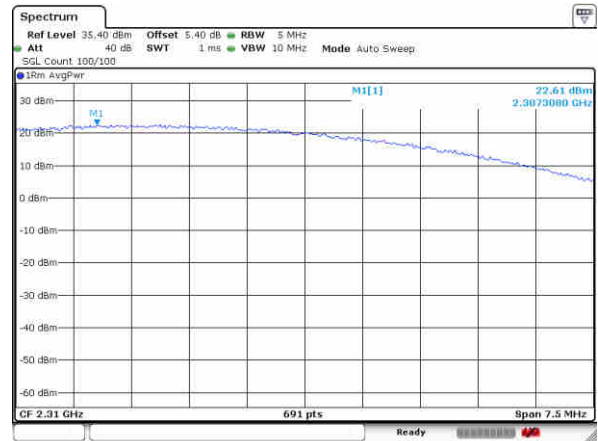

Date: 27 DEC 2017 23:10:37

Highest Channel / 5MHz / 1RB0 / QPSK

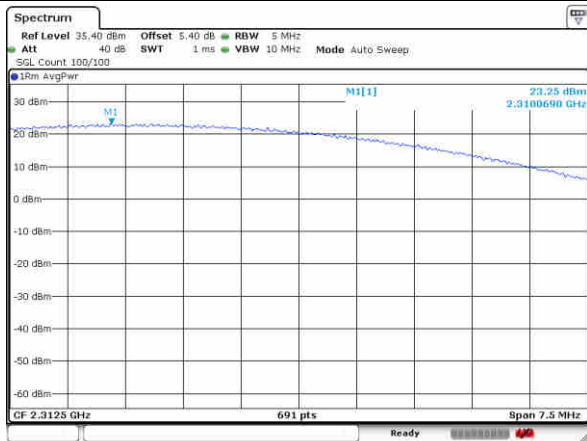

Date: 27 DEC 2017 23:11:42

Highest Channel / 5MHz / 1RB0 / 16QAM

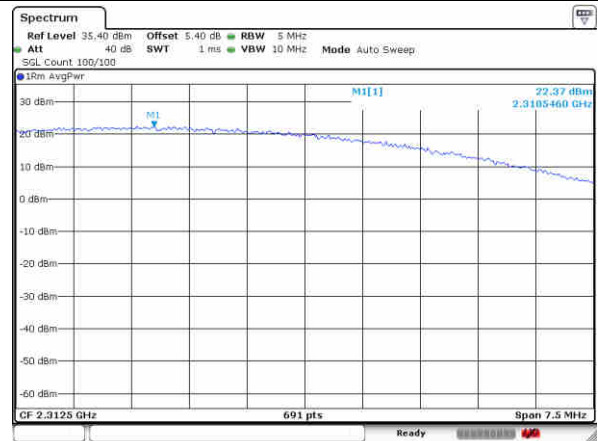

Date: 27 DEC 2017 23:12:08



LTE Band 30 / 10MHz

Lowest Channel / 10MHz / 1RB49 / QPSK



Date: 27 DEC 2017 23:14:31

Lowest Channel / 10MHz / 1RB49 / 16QAM



Date: 27 DEC 2017 23:14:08

LTE Band 30 / 5MHz

Lowest Channel / 5MHz / 1RB0 / 64QAM

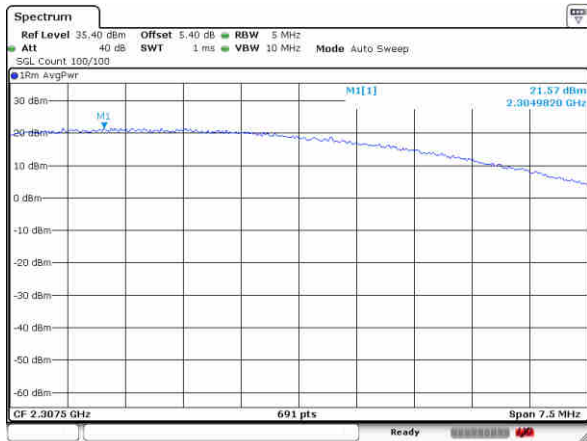

Date: 27 DEC 2017 23:09:15

Middle Channel / 5MHz / 1RB0 / 64QAM

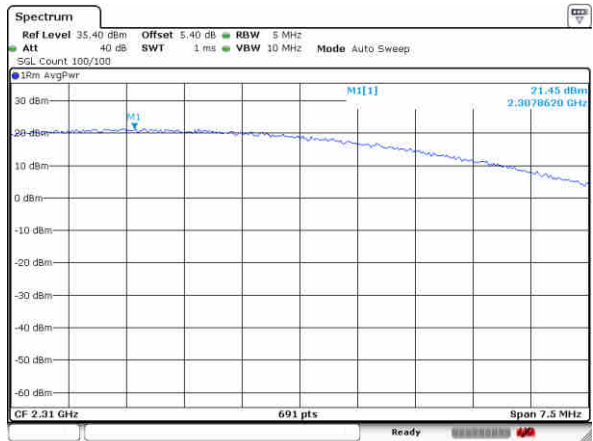

Date: 27 DEC 2017 23:09:59

LTE Band 30 / 5MHz

Highest Channel / 5MHz / 1RB0 / 64QAM



Date: 27 DEC 2017 23:12:36



LTE Band 30 / 10MHz

Middle Channel / 10MHz / 1RB49 / 64QAM

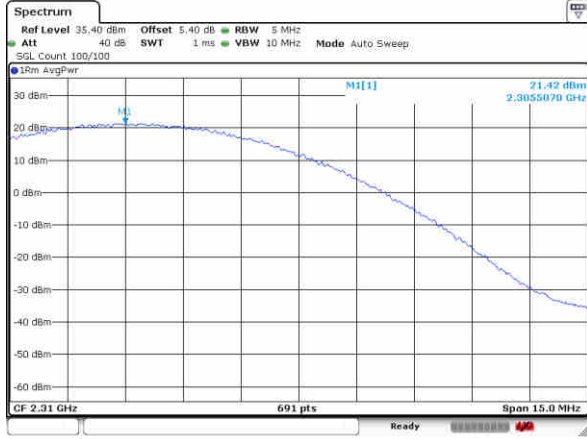



26dB Bandwidth

| Mode | LTE Band 30 : 26dB BW(MHz) | | | | | | | | | | |
|------------|----------------------------|-------|-------|-------|-------|-------|--|--|--|--|--|
| | 5MHz | | 10MHz | | 5MHz | 10MHz | | | | | |
| BW | QPSK | 16QAM | QPSK | 16QAM | 64QAM | 64QAM | | | | | |
| Mod. | QPSK | 16QAM | QPSK | 16QAM | 64QAM | 64QAM | | | | | |
| Lowest CH | 4.895 | 4.985 | - | - | 4.935 | | | | | | |
| Middle CH | 4.875 | 4.875 | 9.81 | 9.71 | 4.935 | 9.71 | | | | | |
| Highest CH | 4.965 | 4.915 | - | - | 4.875 | | | | | | |



LTE Band 30

Lowest Channel / 5MHz / QPSK

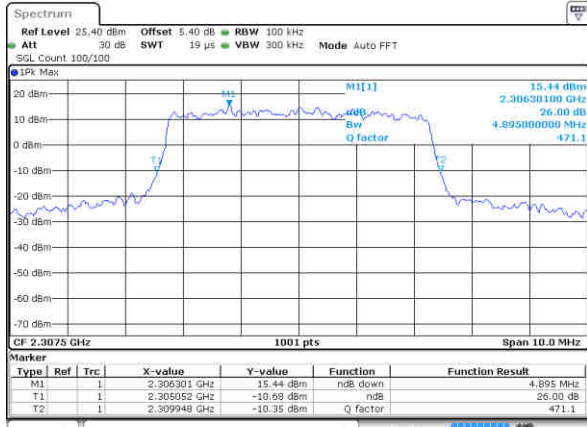

Date: 27 DEC 2017 21:41:28

Lowest Channel / 5MHz / 16QAM

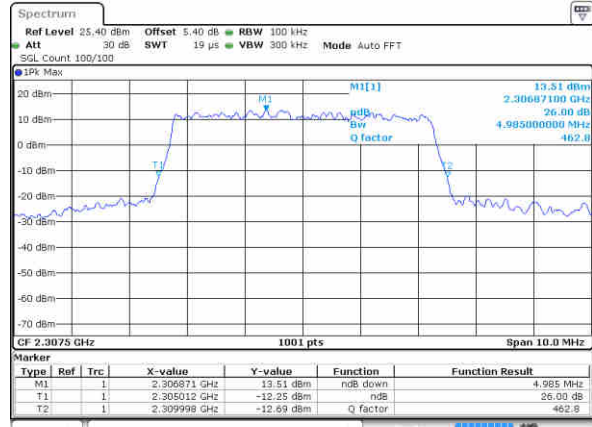

Date: 27 DEC 2017 21:41:52

Middle Channel / 5MHz / QPSK

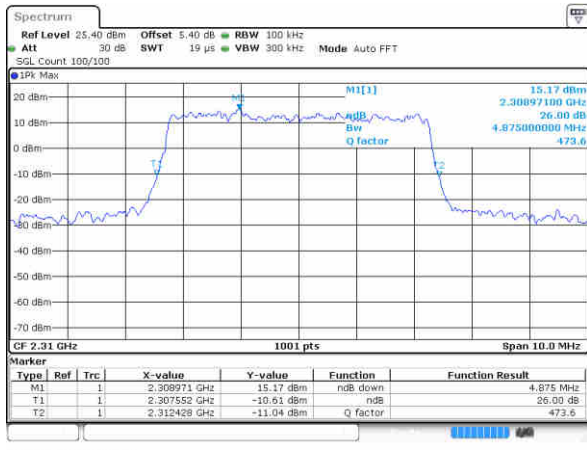

Date: 27 DEC 2017 21:54:33

Middle Channel / 5MHz / 16QAM

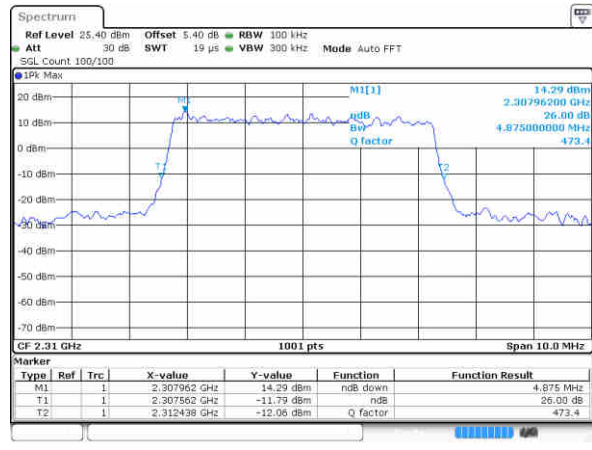

Date: 27 DEC 2017 21:55:53

Highest Channel / 5MHz / QPSK

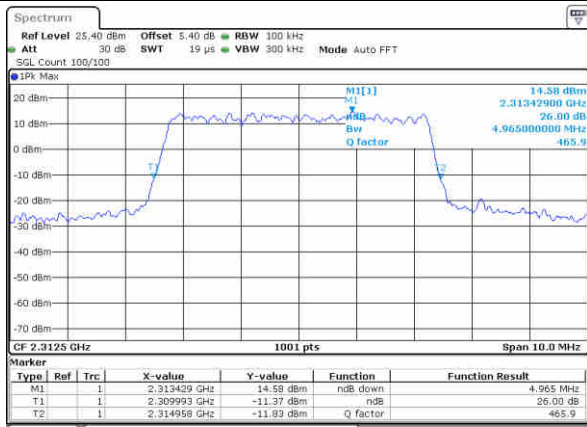

Date: 27 DEC 2017 21:55:07

Highest Channel / 5MHz / 16QAM

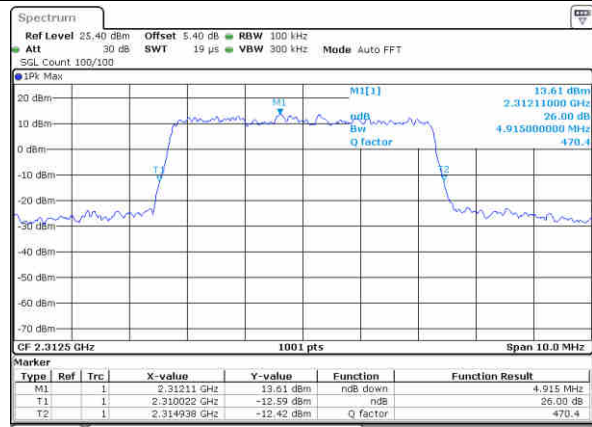

Date: 27 DEC 2017 21:55:45



LTE Band 30

Middle Channel / 10MHz / QPSK

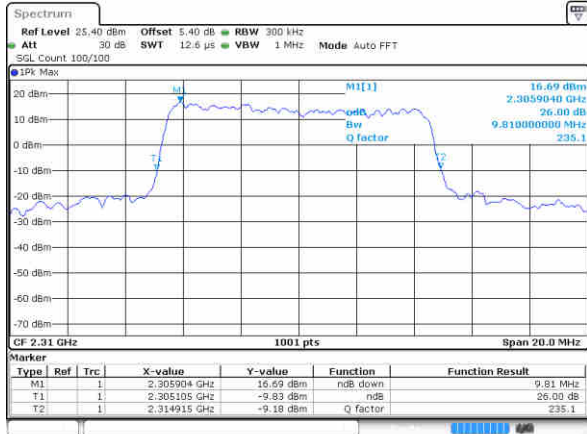

Middle Channel / 10MHz / 16QAM

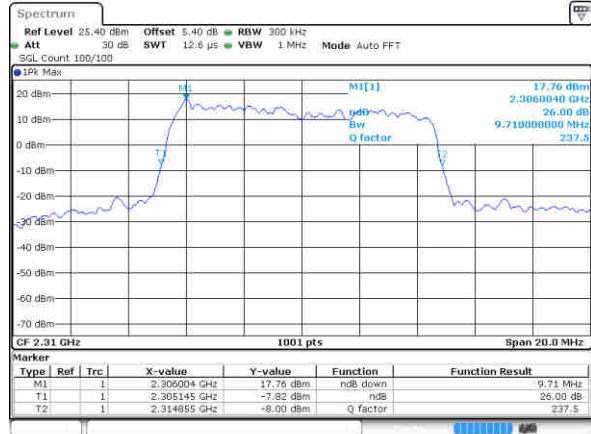

LTE Band 30

Lowest Channel / 5MHz / 64QAM

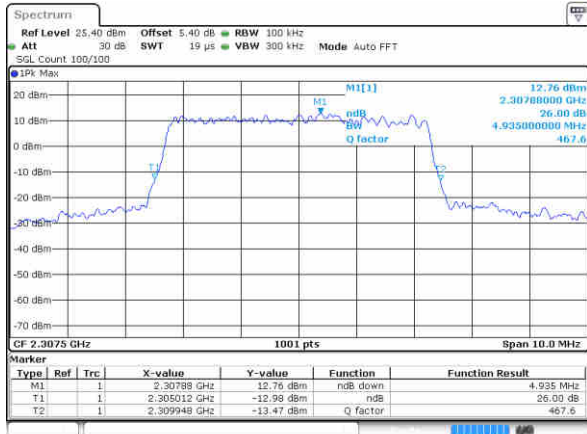

Middle Channel / 5MHz / 64QAM

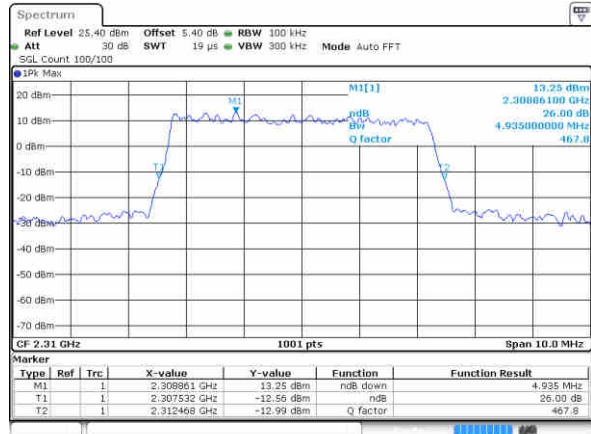

Highest Channel / 5MHz / 64QAM

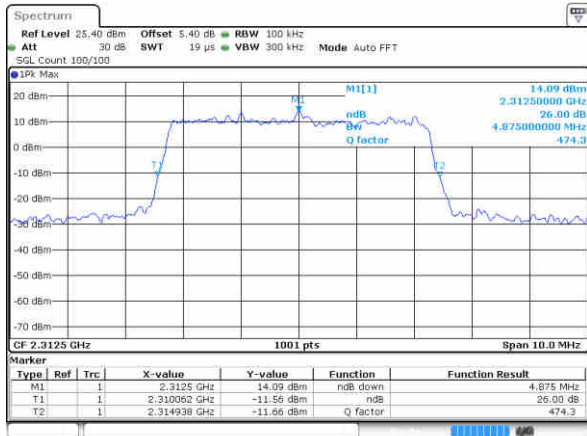

Middle Channel / 10MHz / 64QAM

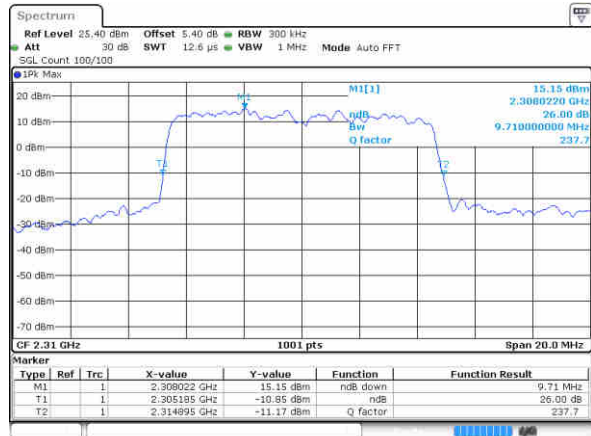



Occupied Bandwidth

| Mode | LTE Band 30 : 99%OBW(MHz) | | | | | | | | | | | |
|------------|---------------------------|-------|-------|-------|-------|-------|--|--|---|---|---|---|
| | 5MHz | | 10MHz | | 5MHz | 10MHz | | | | | | |
| BW | QPSK | 16QAM | QPSK | 16QAM | 64QAM | 64QAM | | | | | | |
| Lowest CH | 4.49 | 4.5 | - | - | 4.51 | | | | - | - | - | - |
| Middle CH | 4.5 | 4.51 | 9.05 | 9.03 | 4.51 | 8.99 | | | - | - | - | - |
| Highest CH | 4.48 | 4.49 | - | - | 4.55 | | | | - | - | - | - |



LTE Band 30

Lowest Channel / 5MHz / QPSK

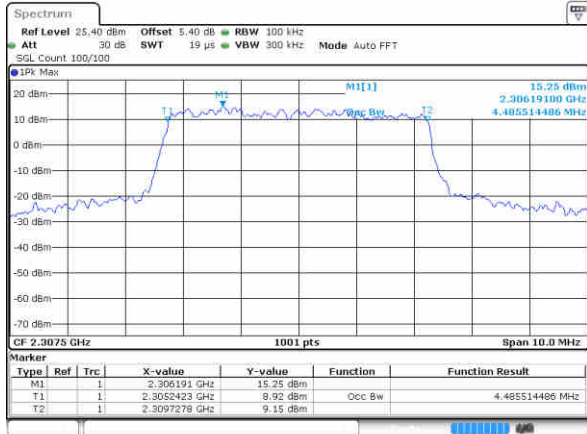

Date: 27 DEC 2017 21:41:16

Lowest Channel / 5MHz / 16QAM

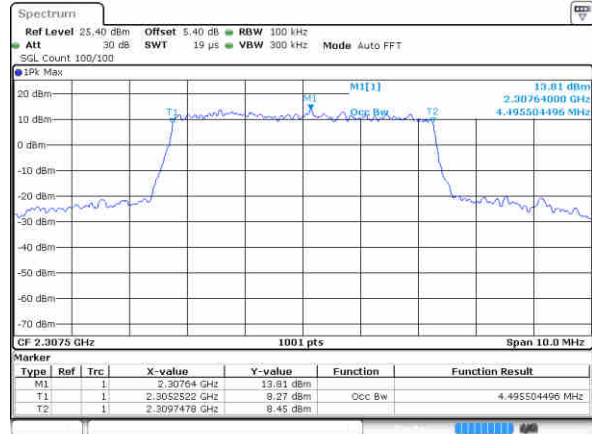

Date: 27 DEC 2017 21:41:42

Middle Channel / 5MHz / QPSK

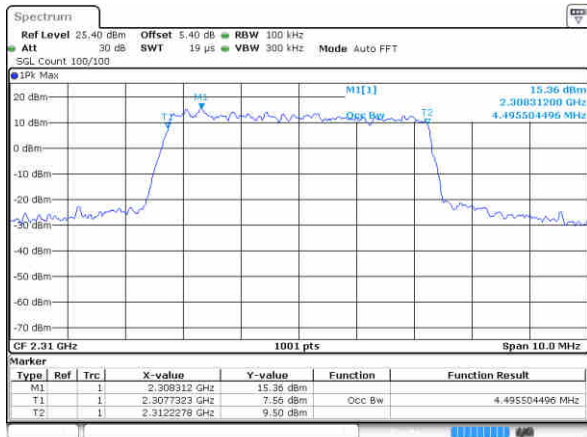

Date: 27 DEC 2017 21:54:20

Middle Channel / 5MHz / 16QAM

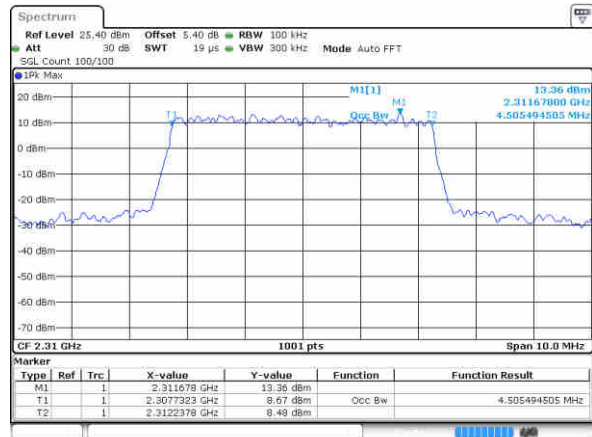

Date: 27 DEC 2017 21:53:38

Highest Channel / 5MHz / QPSK

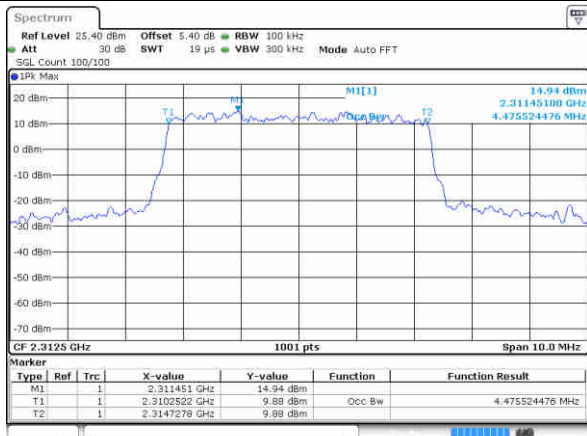

Date: 27 DEC 2017 21:54:51

Highest Channel / 5MHz / 16QAM

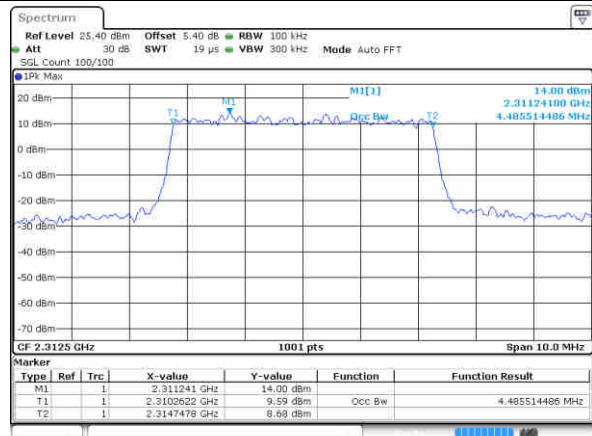

Date: 27 DEC 2017 21:55:58



LTE Band 30

Middle Channel / 10MHz / QPSK

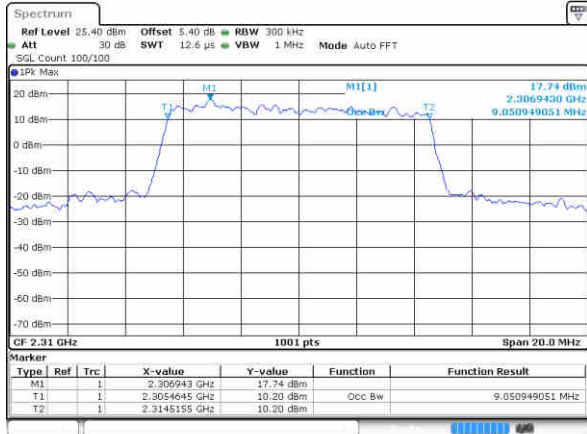

Date: 27 DEC 2017 22:07:06

Middle Channel / 10MHz / 16QAM

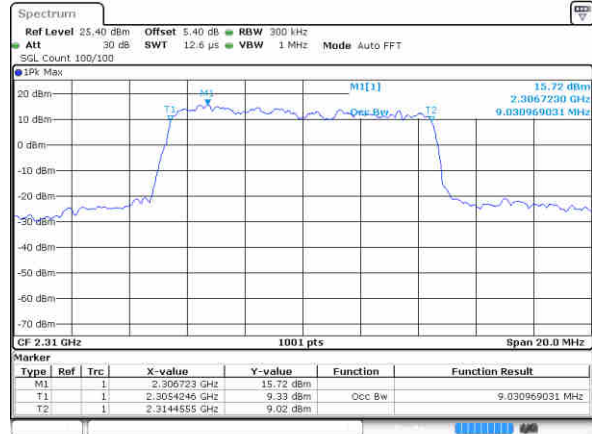

Date: 27 DEC 2017 22:08:11

LTE Band 30

Lowest Channel / 5MHz / 64QAM

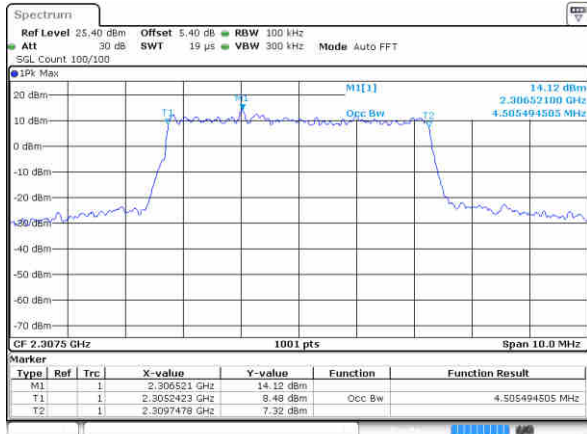

Date: 27 DEC 2017 22:54:05

Middle Channel / 5MHz / 64QAM

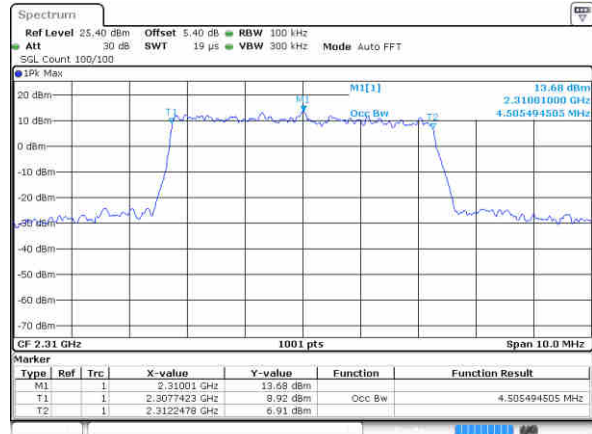

Date: 27 DEC 2017 22:57:36

Highest Channel / 5MHz / 64QAM

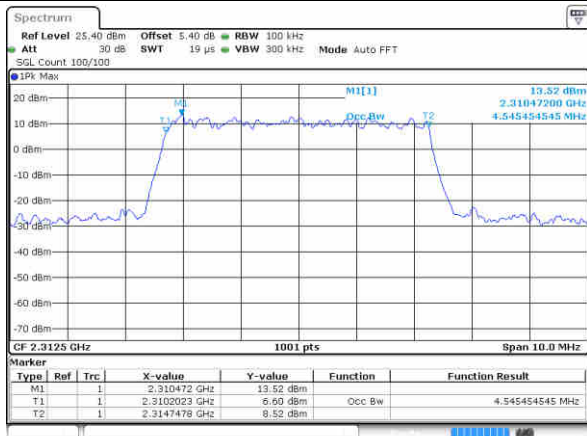

Date: 27 DEC 2017 22:58:06

Middle Channel / 10MHz / 64QAM

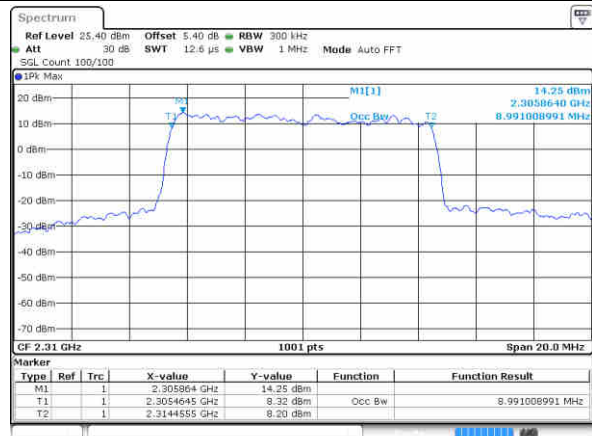

Date: 27 DEC 2017 22:53:30



Conducted Band Edge

LTE Band 30 / 5MHz / QPSK

Lowest Band Edge / 1 RB

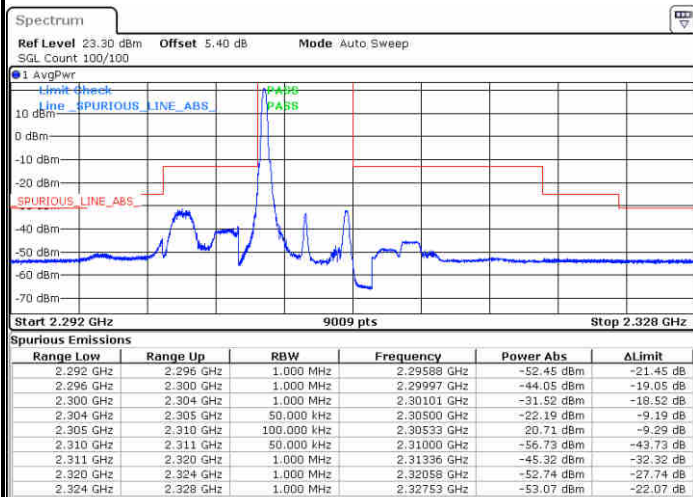

Date: 27 DEC 2017 21:46:46

Highest Band Edge / 1 RB

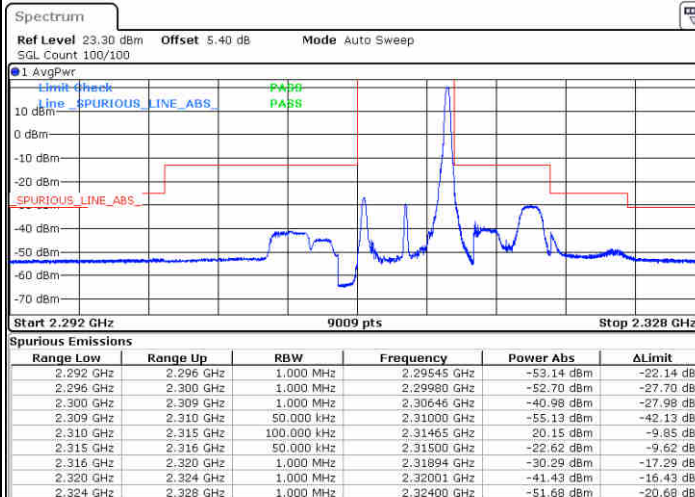

Date: 27 DEC 2017 22:01:05

Lowest Band Edge / Full RB

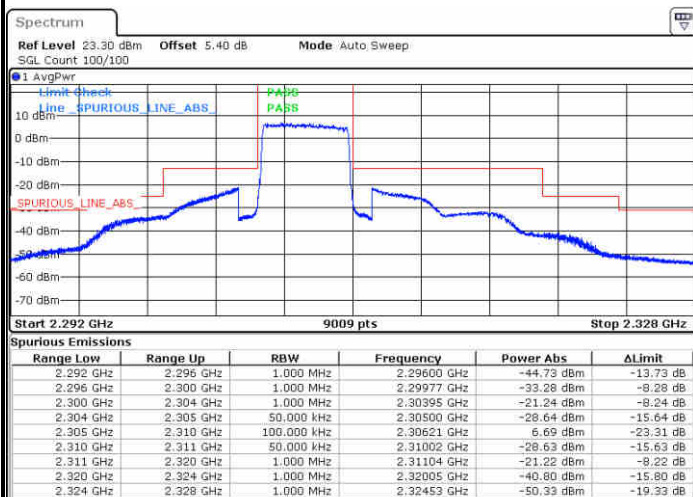

Date: 27 DEC 2017 21:45:01

Highest Band Edge / Full RB

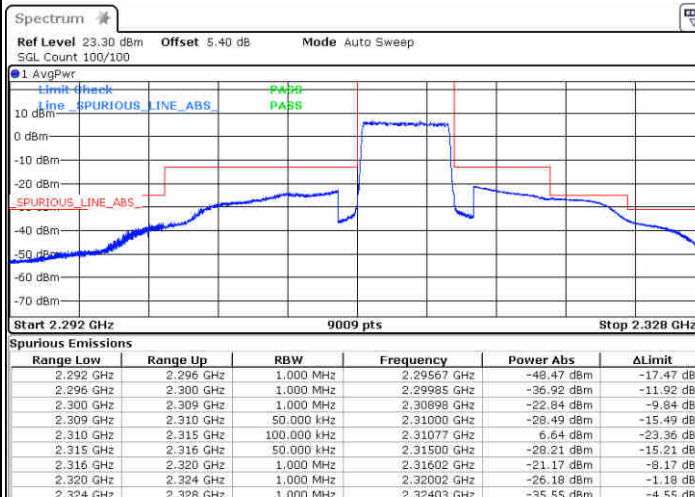

Date: 27 DEC 2017 22:00:21



LTE Band 30 / 5MHz / 16QAM

Lowest Band Edge / 1RB

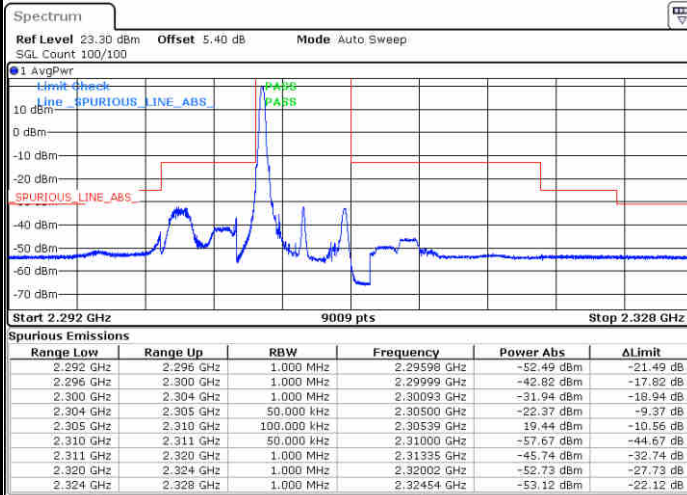

Date: 27 DEC 2017 21:48:14

Highest Band Edge / 1 RB

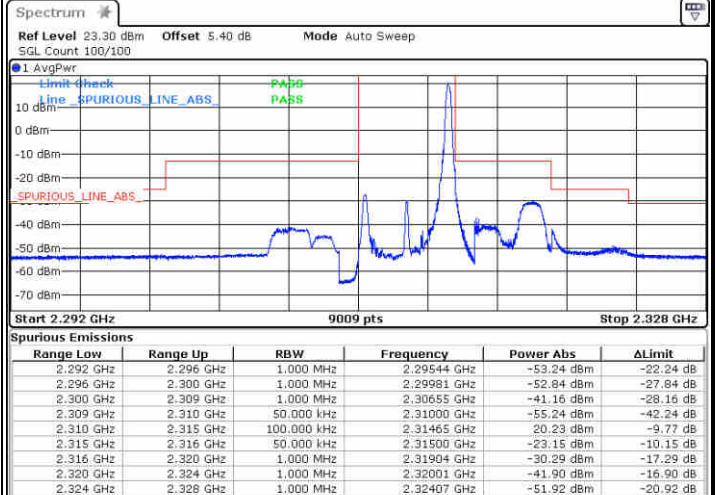

Date: 27 DEC 2017 22:04:12

Lowest Band Edge / Full RB

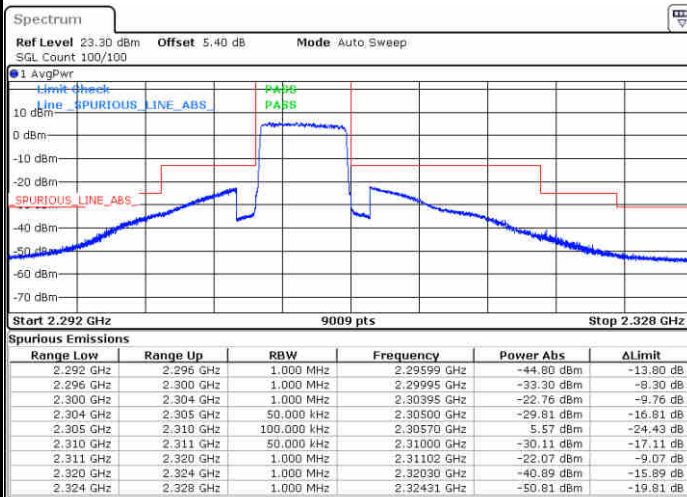

Date: 27 DEC 2017 21:42:37

Highest Band Edge / Full RB

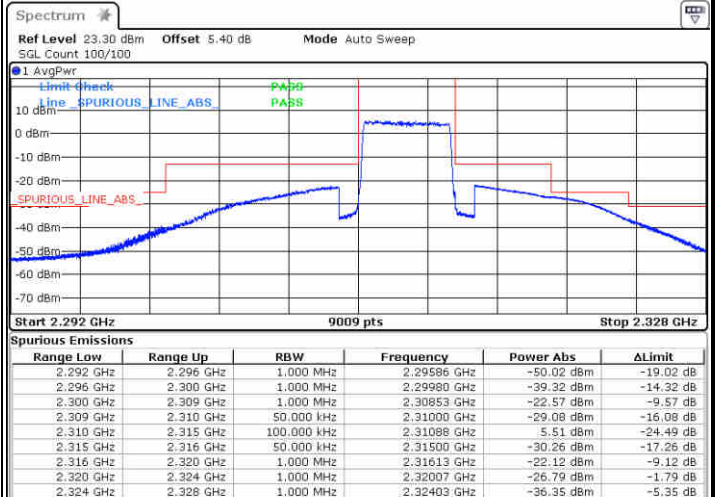

Date: 27 DEC 2017 21:58:41



LTE Band 30 / 10MHz / QPSK

Lowest Band Edge / 1 RB

Highest Band Edge / 1 RB

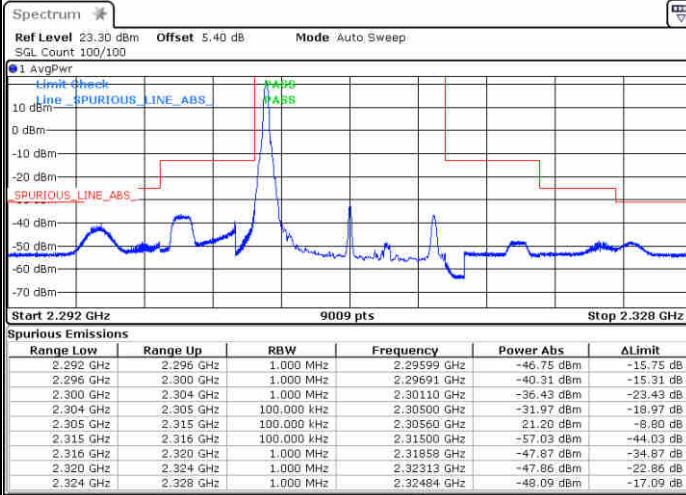

Date: 31 DEC 2017 22:57:46

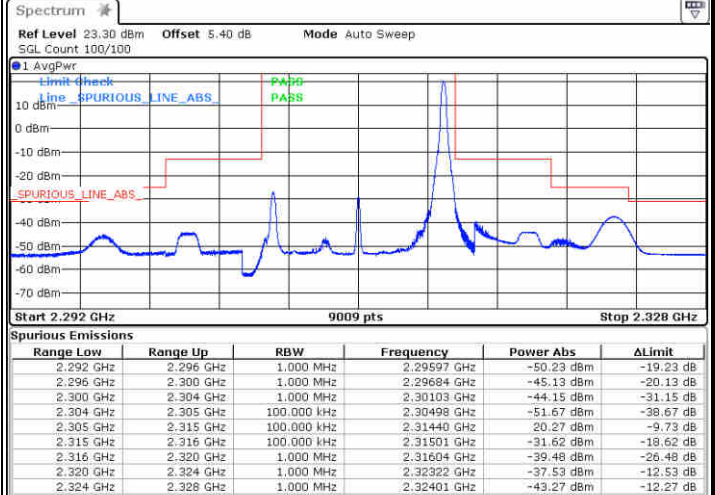

Date: 27 DEC 2017 22:44:26

Band Edge / Full RB

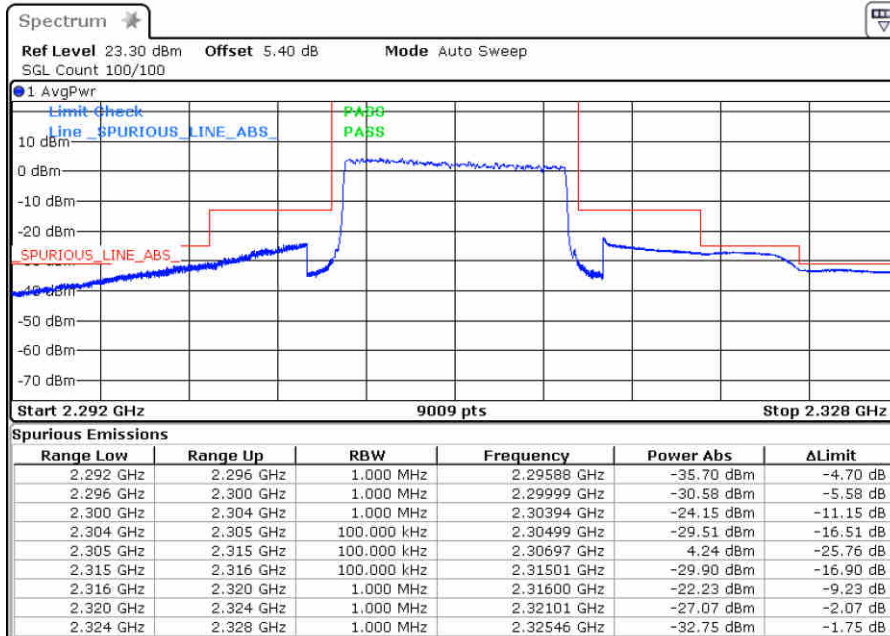

Date: 27 DEC 2017 22:22:46



LTE Band 30 / 10MHz / 16QAM

Lowest Band Edge / 1 RB

Highest Band Edge / 1 RB

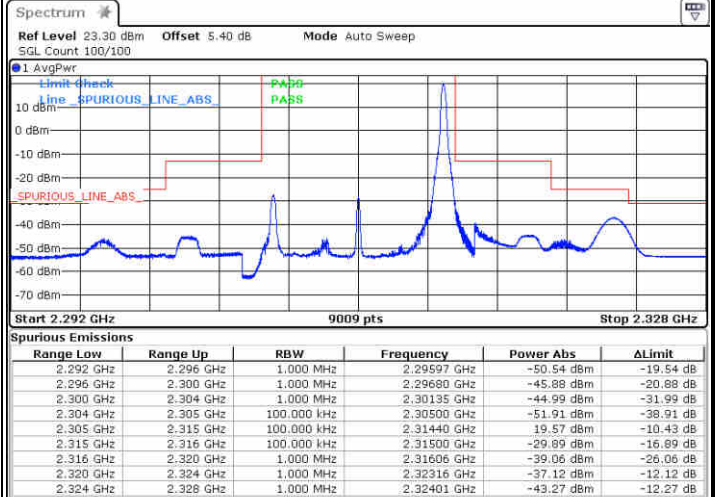
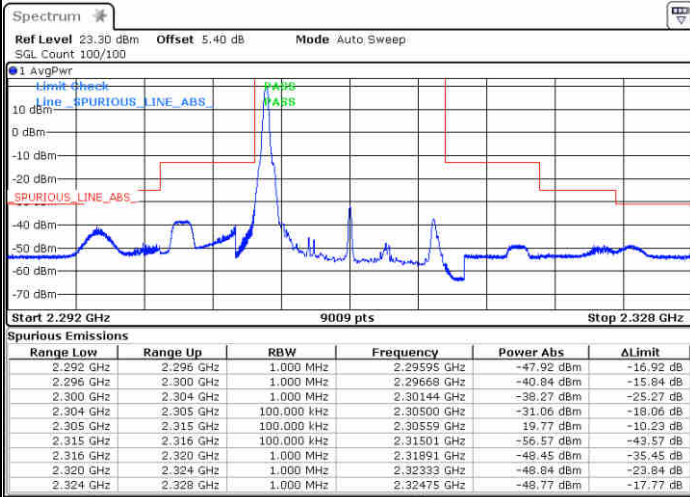

Date: 31 DEC 2017 22:58:36

Date: 27 DEC 2017 22:42:50

Band Edge / Full RB

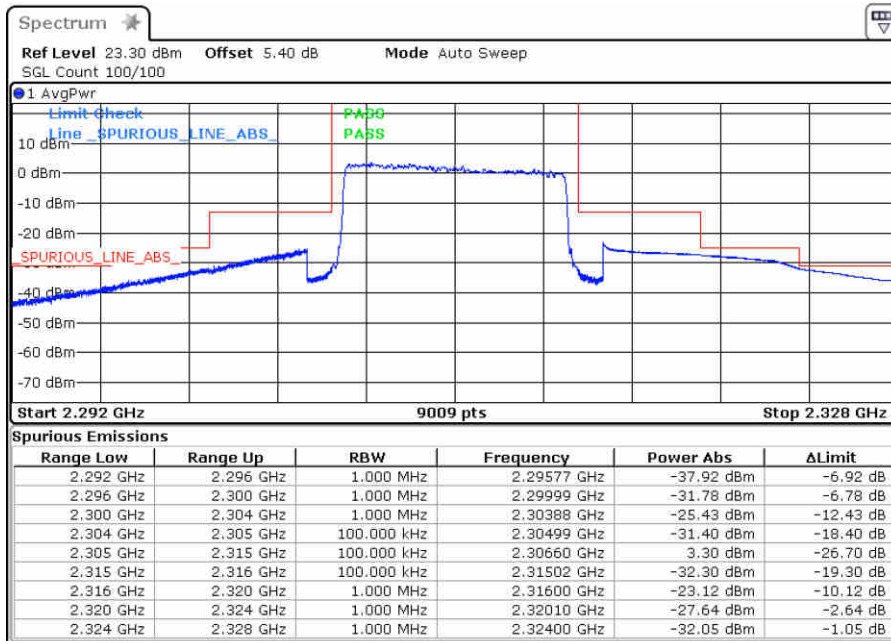

Date: 27 DEC 2017 22:41:14



LTE Band 30 / 5MHz / 64QAM

Lowest Band Edge / 1 RB

Highest Band Edge / 1 RB

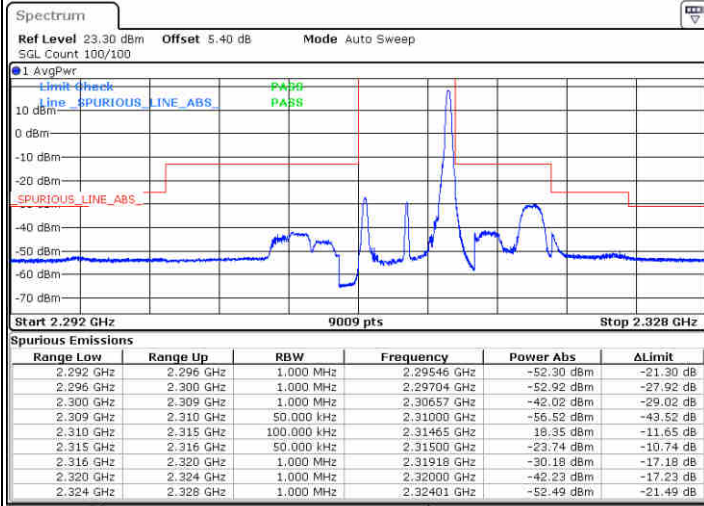
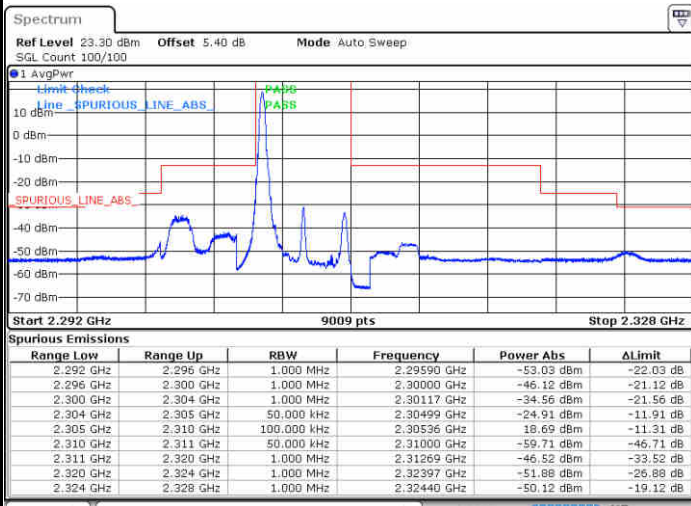

Date: 27 DEC 2017 22:55:30

Date: 27 DEC 2017 23:00:54

Lowest Band Edge / Full RB

Highest Band Edge / Full RB

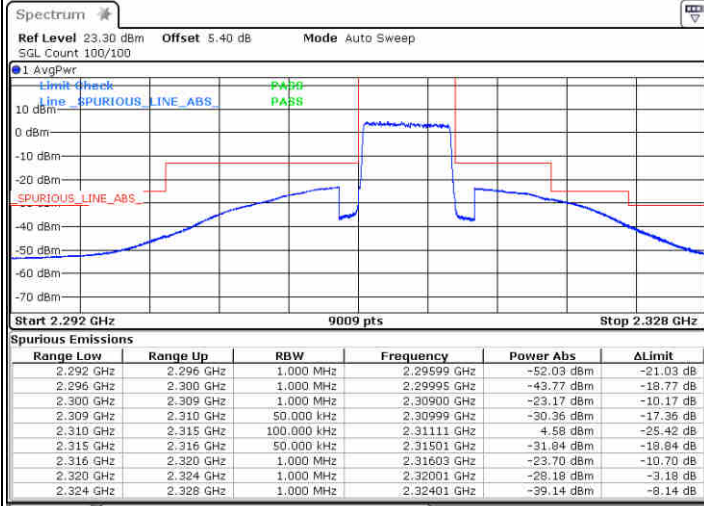
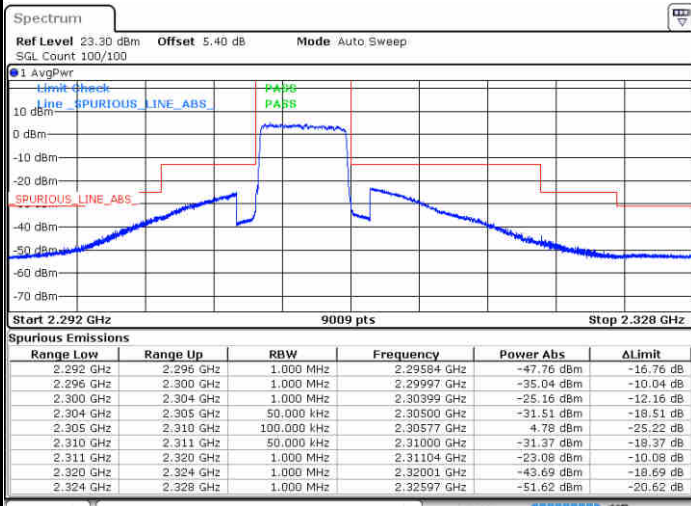

Date: 27 DEC 2017 22:54:51

Date: 27 DEC 2017 23:00:15



LTE Band 30 / 10MHz / 64QAM

Band Edge / 1 RB0

Band Edge / 1 RB MAX

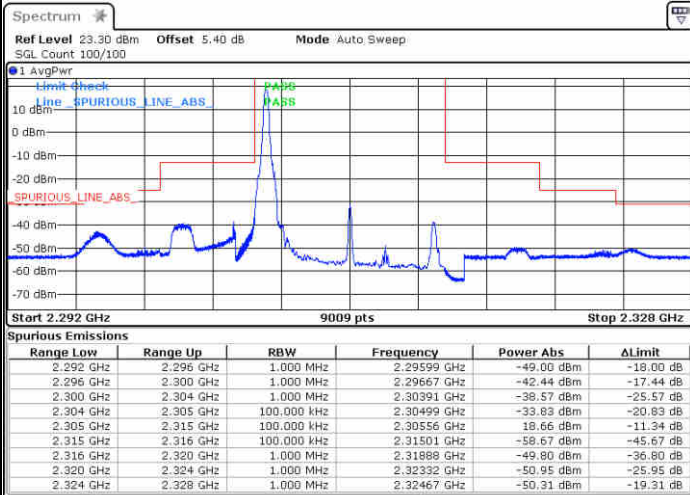

Date: 27 DEC 2017 22:48:53

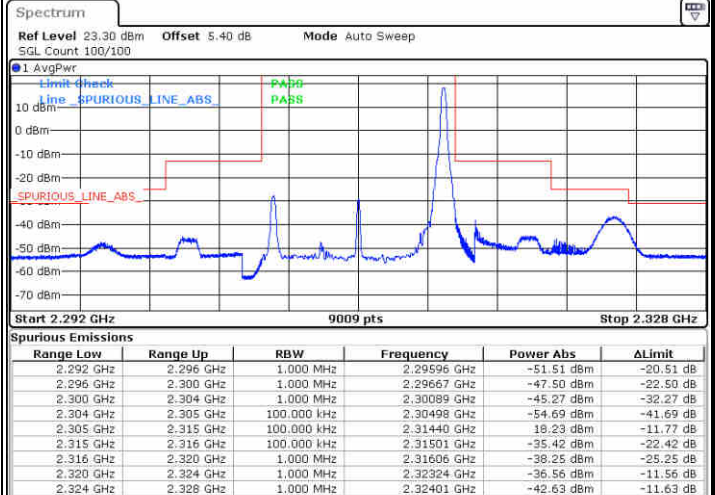

Date: 27 DEC 2017 22:50:20

Band Edge / Full RB

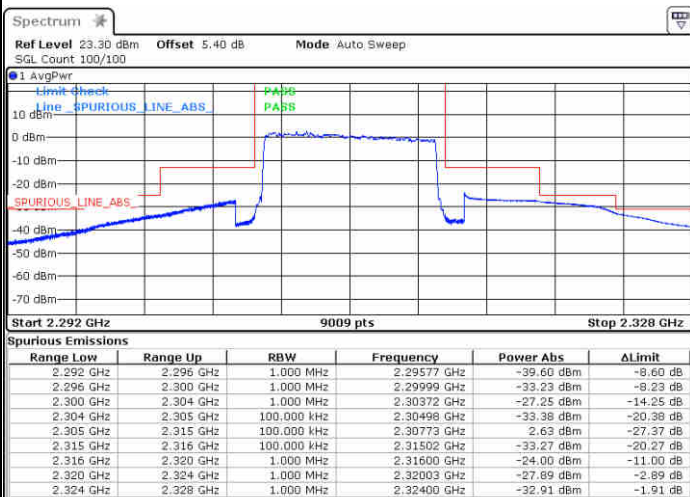

Date: 27 DEC 2017 22:53:11



Conducted Spurious Emission

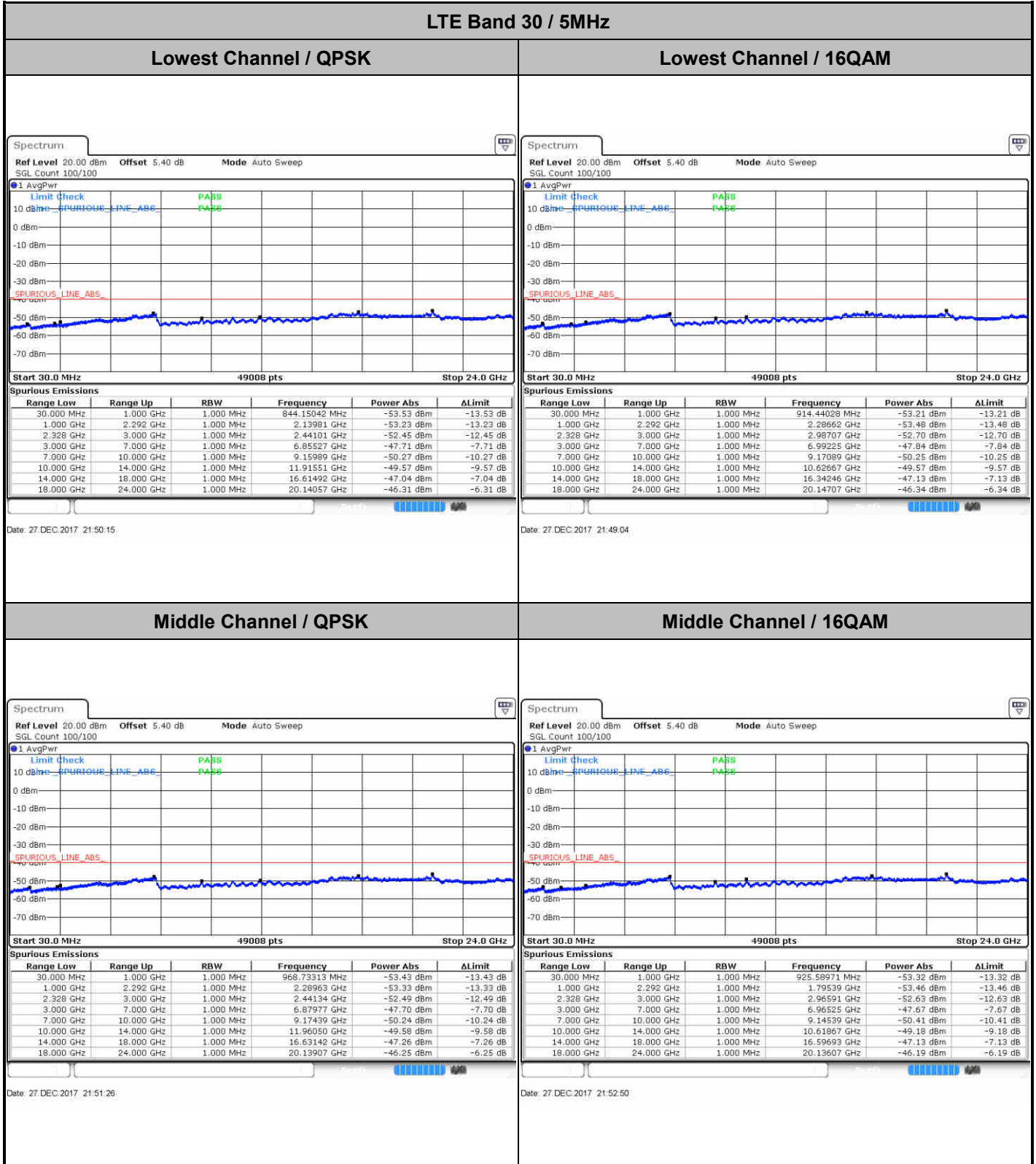



LTE Band 30 / 5MHz

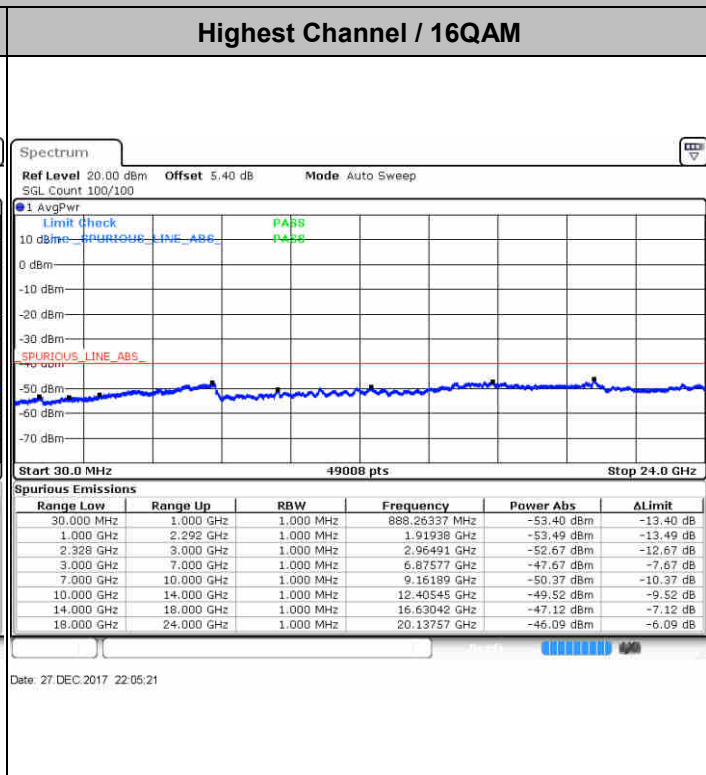
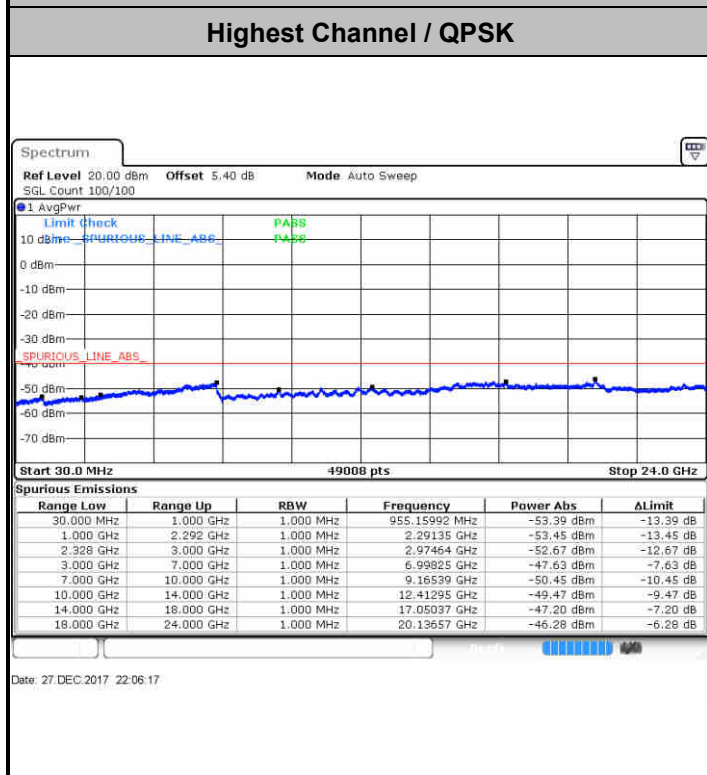

LTE Band 30 / 10MHz

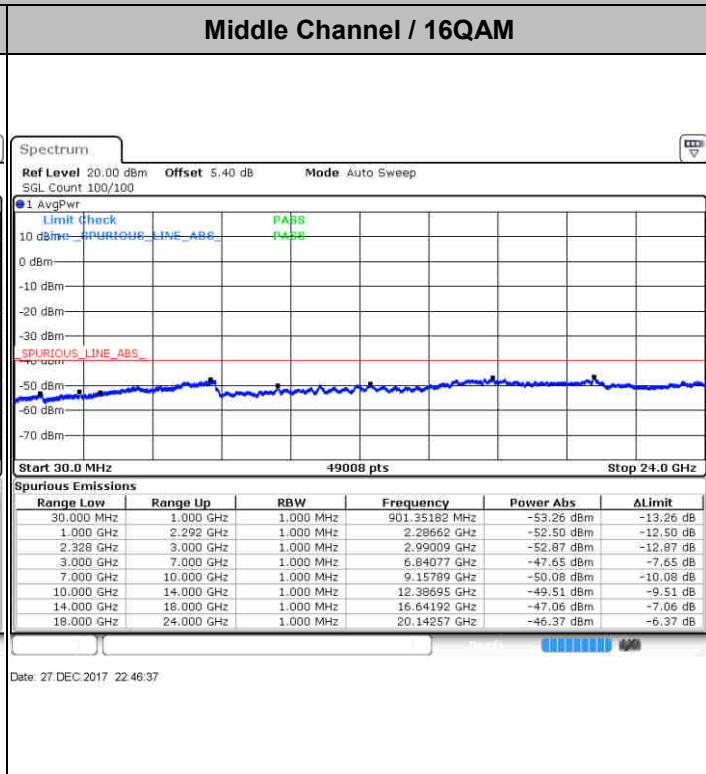
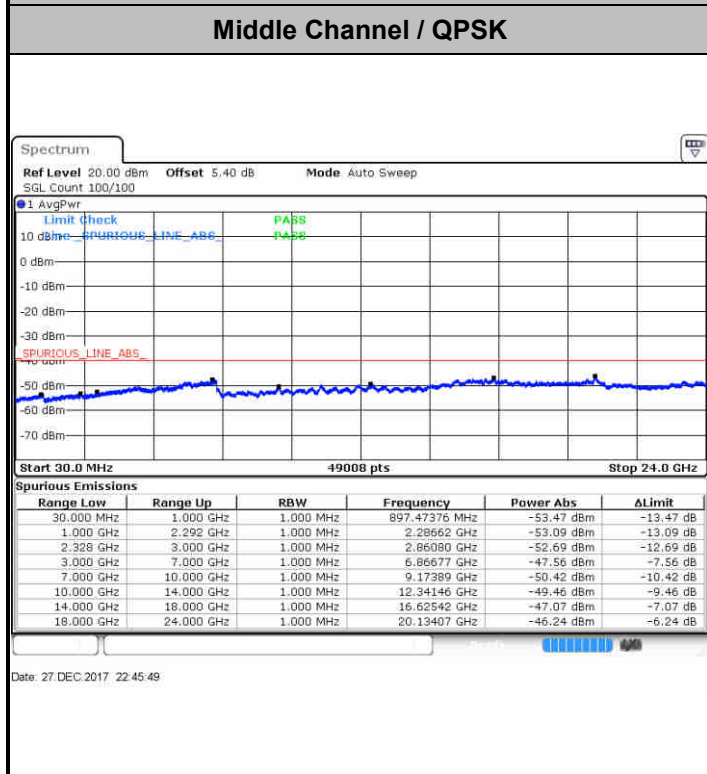



LTE Band 30 / 5MHz

Lowest Channel / 64QAM

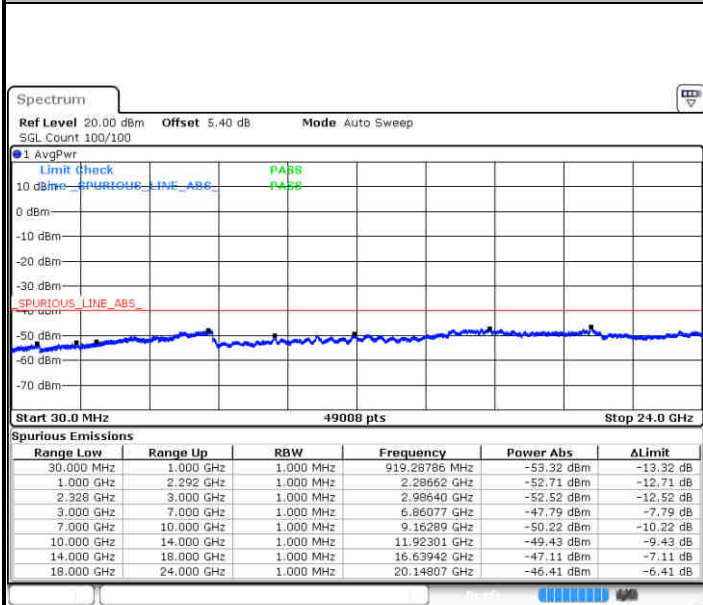

Date: 27 DEC 2017 22:56:24

Middle Channel / 64QAM

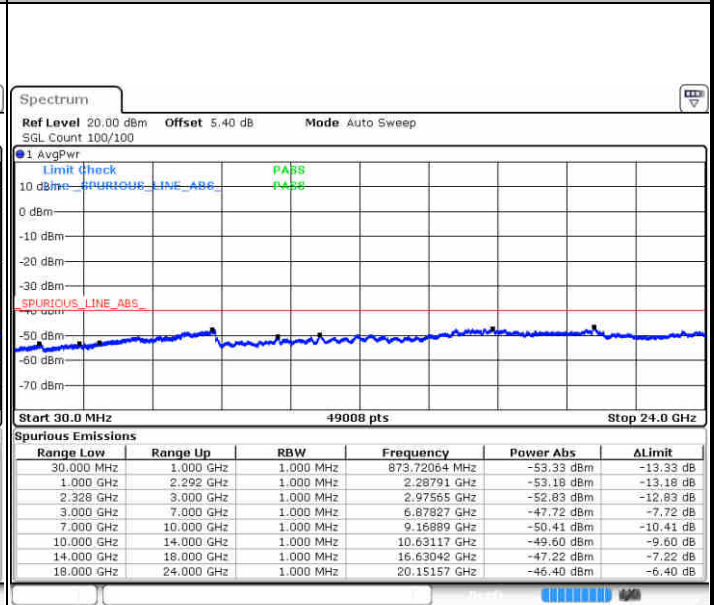

Date: 27 DEC 2017 22:57:17

Highest Channel / 64QAM

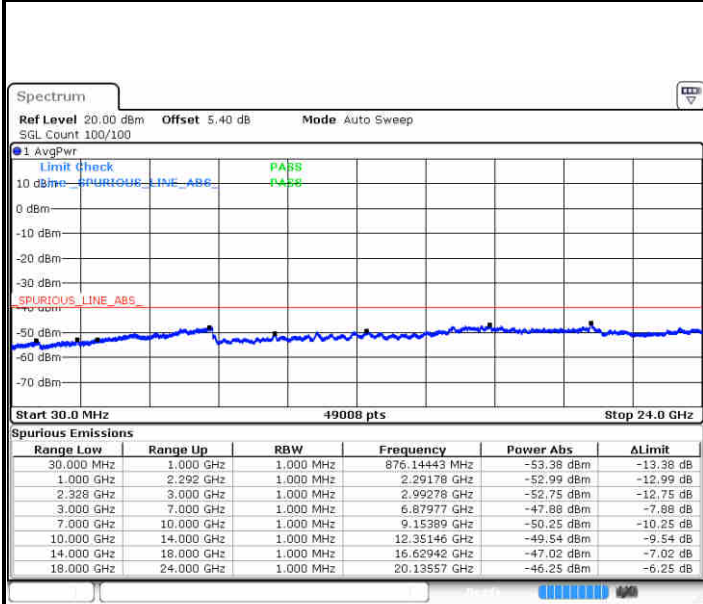

Date: 27 DEC 2017 23:01:43



LTE Band 30 / 10MHz

Middle Channel / 64QAM

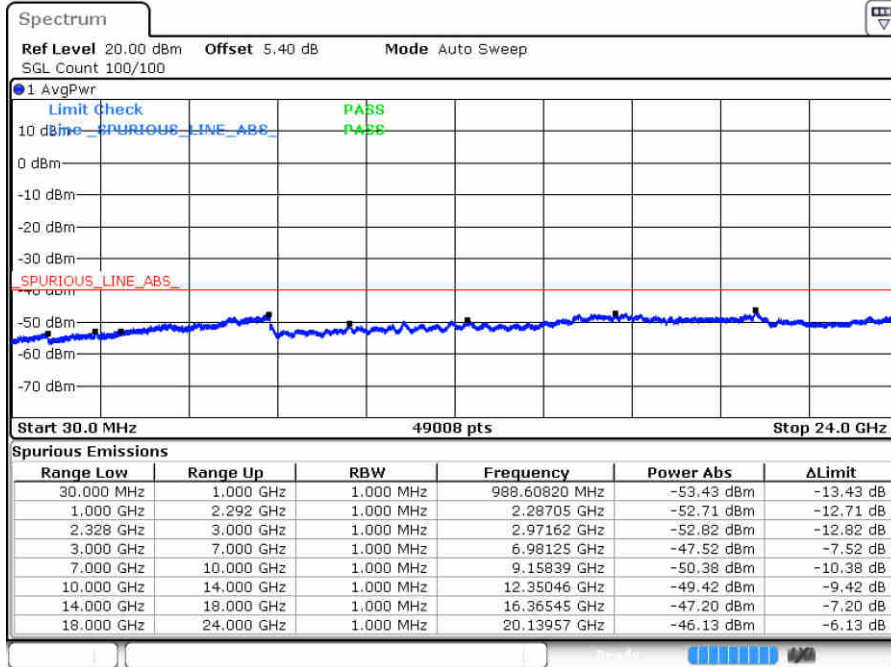

Date: 27 DEC 2017 23:17:45



Frequency Stability

| Test Conditions | | LTE Band 30 (QPSK) / Middle Channel | Limit |
|------------------|-------------------|-------------------------------------|---------|
| Temperature (°C) | Voltage (Volt) | BW 10MHz | Note 2. |
| | | Deviation (ppm) | Result |
| 50 | Normal Voltage | 0.0005 | PASS |
| 40 | Normal Voltage | 0.0002 | |
| 30 | Normal Voltage | 0.0018 | |
| 20(Ref.) | Normal Voltage | 0.0000 | |
| 10 | Normal Voltage | 0.0019 | |
| 0 | Normal Voltage | 0.0021 | |
| -10 | Normal Voltage | 0.0003 | |
| -20 | Normal Voltage | 0.0007 | |
| -30 | Normal Voltage | 0.0022 | |
| 20 | Maximum Voltage | 0.0001 | |
| 20 | Normal Voltage | 0.0004 | |
| 20 | Battery End Point | 0.0016 | |

Note:

1. Normal Voltage =3.8 V. ; Battery End Point (BEP) =3.4 V. ; Maximum Voltage =4.35 V.
2. Note: The frequency fundamental emissions stay within the authorized frequency block.



Appendix B. Test Results of Radiated Test

Radiated Spurious Emission

<Antenna #2>:

| LTE Band 30 / 5MHz / QPSK / RB Size 1 Offset 0 | | | | | | | | | |
|--|-------------------|--------------|---------------|-------------------|-------------------|--------------------|----------------------|-----------------------|--------------------|
| Channel | Frequency (MHz) | EIRP (dBm) | Limit (dBm) | Over Limit (dB) | SPA Reading (dBm) | S.G. Power (dBm) | TX Cable loss (dB) | TX Antenna Gain (dBi) | Polarization (H/V) |
| Lowest | 4612 | -62.30 | -40 | -22.30 | -47.11 | -68.17 | 2.12 | 7.99 | H |
| | 6916 | -45.50 | -40 | -5.50 | -38.10 | -54.66 | 2.51 | 11.67 | H |
| | 9220 | -60.54 | -40 | -20.54 | -50.34 | -71.12 | 3.02 | 13.59 | H |
| | 4612 | -63.38 | -40 | -23.38 | -48.5 | -69.25 | 2.12 | 7.99 | V |
| | 6916 | -54.65 | -40 | -14.65 | -45.53 | -63.81 | 2.51 | 11.67 | V |
| | 9220 | -57.31 | -40 | -17.31 | -50.65 | -67.88 | 3.02 | 13.59 | V |
| Middle | 4616 | -62.50 | -40 | -22.50 | -47.31 | -68.37 | 2.12 | 7.99 | H |
| | 6924 | -51.33 | -40 | -11.33 | -41.54 | -60.49 | 2.51 | 11.67 | H |
| | 9232 | -58.15 | -40 | -18.15 | -47.95 | -68.73 | 3.02 | 13.59 | H |
| | 4616 | -62.50 | -40 | -22.50 | -47.62 | -68.37 | 2.12 | 7.99 | V |
| | 6924 | -54.74 | -40 | -14.74 | -45.62 | -63.90 | 2.51 | 11.67 | V |
| | 9232 | -57.85 | -40 | -17.85 | -51.19 | -68.42 | 3.02 | 13.59 | V |
| Highest | 4620.68 | -63.98 | -40 | -23.98 | -48.79 | -69.85 | 2.12 | 7.99 | H |
| | 6932 | -51.79 | -40 | -11.79 | -41.87 | -60.95 | 2.51 | 11.67 | H |
| | 9240 | -59.55 | -40 | -19.55 | -49.35 | -70.13 | 3.02 | 13.59 | H |
| | 4620 | -65.31 | -40 | -25.31 | -50.43 | -71.18 | 2.12 | 7.99 | V |
| | 6932 | -55.25 | -40 | -15.25 | -46.13 | -64.41 | 2.51 | 11.67 | V |
| | 9240 | -55.66 | -40 | -15.66 | -49 | -66.23 | 3.02 | 13.59 | V |

Remark: Spurious emissions within 30-1000MHz were found more than 20dB below limit line.

| LTE Band 30 / 10MHz / QPSK / RB Size 1 Offset 0 | | | | | | | | | |
|---|-------------------|--------------|---------------|-------------------|-------------------|--------------------|----------------------|-----------------------|--------------------|
| Channel | Frequency (MHz) | EIRP (dBm) | Limit (dBm) | Over Limit (dB) | SPA Reading (dBm) | S.G. Power (dBm) | TX Cable loss (dB) | TX Antenna Gain (dBi) | Polarization (H/V) |
| Middle | 4612 | -63.95 | -40 | -23.95 | -48.76 | -69.82 | 2.12 | 7.99 | H |
| | 6916 | -44.35 | -40 | -4.35 | -37.50 | -53.51 | 2.51 | 11.67 | H |
| | 9224 | -58.57 | -40 | -18.57 | -48.37 | -69.15 | 3.02 | 13.59 | H |
| | 4612 | -62.63 | -40 | -22.63 | -47.75 | -68.50 | 2.12 | 7.99 | V |
| | 6916 | -53.59 | -40 | -13.59 | -44.47 | -62.75 | 2.51 | 11.67 | V |
| | 9224 | -54.39 | -40 | -14.39 | -47.73 | -64.96 | 3.02 | 13.59 | V |

Remark: Spurious emissions within 30-1000MHz were found more than 20dB below limit line.



<Antenna #3>:

| LTE Band 30 / 5MHz / QPSK / RB Size 1 Offset 0 | | | | | | | | | |
|--|-------------------|--------------|---------------|-------------------|-------------------|--------------------|----------------------|-----------------------|--------------------|
| Channel | Frequency (MHz) | EIRP (dBm) | Limit (dBm) | Over Limit (dB) | SPA Reading (dBm) | S.G. Power (dBm) | TX Cable loss (dB) | TX Antenna Gain (dBi) | Polarization (H/V) |
| Lowest | 4612 | -67.30 | -40 | -27.30 | -52.11 | -73.17 | 2.12 | 7.99 | H |
| | 6916 | -43.78 | -40 | -3.78 | -37.13 | -52.94 | 2.51 | 11.67 | H |
| | 9220 | -61.34 | -40 | -21.34 | -51.14 | -71.92 | 3.02 | 13.59 | H |
| | 11528 | -58.63 | -40 | -18.63 | -54.56 | -67.12 | 3.62 | 12.11 | H |
| | 4612 | -67.03 | -40 | -27.03 | -52.15 | -72.90 | 2.12 | 7.99 | V |
| | 6916 | -53.43 | -40 | -13.43 | -44.31 | -62.59 | 2.51 | 11.67 | V |
| | 9220 | -56.80 | -40 | -16.80 | -50.14 | -67.37 | 3.02 | 13.59 | V |
| Middle | 11528 | -55.41 | -40 | -15.41 | -50.87 | -63.90 | 3.62 | 12.11 | V |
| | 4616 | -67.17 | -40 | -27.17 | -51.98 | -73.04 | 2.12 | 7.99 | H |
| | 6924 | -43.97 | -40 | -3.97 | -37.26 | -53.13 | 2.51 | 11.67 | H |
| | 9232 | -59.84 | -40 | -19.84 | -49.64 | -70.42 | 3.02 | 13.59 | H |
| | 11540 | -56.82 | -40 | -16.82 | -52.75 | -65.31 | 3.62 | 12.11 | H |
| | 4616 | -65.42 | -40 | -25.42 | -50.54 | -71.29 | 2.12 | 7.99 | V |
| | 6924 | -53.75 | -40 | -13.75 | -44.63 | -62.91 | 2.51 | 11.67 | V |
| Highest | 9232 | -53.43 | -40 | -13.43 | -46.77 | -64.00 | 3.02 | 13.59 | V |
| | 11540 | -53.14 | -40 | -13.14 | -48.6 | -61.63 | 3.62 | 12.11 | V |
| | 4620 | -68.09 | -40 | -28.09 | -52.90 | -73.96 | 2.12 | 7.99 | H |
| | 6932 | -43.44 | -40 | -3.44 | -36.91 | -52.60 | 2.51 | 11.67 | H |
| | 9240 | -58.76 | -40 | -18.76 | -48.56 | -69.34 | 3.02 | 13.59 | H |
| | 11552 | -57.76 | -40 | -17.76 | -53.69 | -66.25 | 3.62 | 12.11 | H |
| | 4620 | -67.15 | -40 | -27.15 | -52.27 | -73.02 | 2.12 | 7.99 | V |
| 6932 | -54.85 | -40 | -14.85 | -45.73 | -64.01 | 2.51 | 11.67 | V | |
| 9240 | -55.46 | -40 | -15.46 | -48.8 | -66.03 | 3.02 | 13.59 | V | |
| 11552 | -53.18 | -40 | -13.18 | -48.64 | -61.67 | 3.62 | 12.11 | V | |

Remark: Spurious emissions within 30-1000MHz were found more than 20dB below limit line.

| LTE Band 30 / 10MHz / QPSK / RB Size 1 Offset 0 | | | | | | | | | |
|---|-------------------|--------------|---------------|-------------------|-------------------|--------------------|----------------------|-----------------------|--------------------|
| Channel | Frequency (MHz) | EIRP (dBm) | Limit (dBm) | Over Limit (dB) | SPA Reading (dBm) | S.G. Power (dBm) | TX Cable loss (dB) | TX Antenna Gain (dBi) | Polarization (H/V) |
| Middle | 4612 | -66.11 | -40 | -26.11 | -50.92 | -71.98 | 2.12 | 7.99 | H |
| | 6916 | -43.76 | -40 | -3.76 | -37.12 | -52.92 | 2.51 | 11.67 | H |
| | 9224 | -57.36 | -40 | -17.36 | -47.16 | -67.94 | 3.02 | 13.59 | H |
| | 11528 | -57.06 | -40 | -17.06 | -52.99 | -65.55 | 3.62 | 12.11 | H |
| | 4612 | -63.19 | -40 | -23.19 | -48.31 | -69.06 | 2.12 | 7.99 | V |
| | 6916 | -52.70 | -40 | -12.70 | -43.58 | -61.86 | 2.51 | 11.67 | V |
| | 9224 | -55.82 | -40 | -15.82 | -49.16 | -66.39 | 3.02 | 13.59 | V |
| | 11528 | -54.14 | -40 | -14.14 | -49.6 | -62.63 | 3.62 | 12.11 | V |

Remark: Spurious emissions within 30-1000MHz were found more than 20dB below limit line.