



# FCC RF Test Report

**APPLICANT** : Motorola Mobility LLC  
**EQUIPMENT** : Mobile Cellular Phone  
**BRAND NAME** : Motorola  
**MODEL NAME** : XT1921-5, XT1921-3  
**FCC ID** : IHDT56XC2  
**STANDARD** : FCC Part 15 Subpart C §15.247  
**CLASSIFICATION** : (DTS) Digital Transmission System

The product was received on Dec. 20, 2017 and testing was completed on Jan. 18, 2018. We, SPORTON INTERNATIONAL INC., would like to declare that the tested sample has been evaluated in accordance with the test procedures and has been in compliance with the applicable technical standards.

The test results in this report apply exclusively to the tested model / sample. Without written approval of SPORTON INTERNATIONAL INC., the test report shall not be reproduced except in full.

Reviewed by: Joseph Lin / Supervisor

Approved by: Jones Tsai / Manager



## **SPORTON INTERNATIONAL INC.**

**No. 52, Hwa Ya 1<sup>st</sup> Rd., Hwa Ya Technology Park, Kwei-Shan District, Tao Yuan City, Taiwan, R.O.C.**

SPORTON INTERNATIONAL INC.

TEL : 886-3-327-3456

FAX : 886-3-328-4978

FCC ID : IHDT56XC2

Page Number : 1 of 35

Report Issued Date : Feb. 13, 2018

Report Version : Rev. 01

Report Template No.: BU5-FR15CWLAC MA Version 2.0



# TABLE OF CONTENTS

**REVISION HISTORY..... 3**

**SUMMARY OF TEST RESULT ..... 4**

**1 GENERAL DESCRIPTION ..... 5**

    1.1 Applicant ..... 5

    1.2 Manufacturer ..... 5

    1.3 Product Feature of Equipment Under Test..... 5

    1.4 Product Specification of Equipment Under Test..... 6

    1.5 Modification of EUT ..... 6

    1.6 Testing Location ..... 7

    1.7 Applicable Standards..... 7

**2 TEST CONFIGURATION OF EQUIPMENT UNDER TEST ..... 8**

    2.1 Carrier Frequency and Channel ..... 8

    2.2 Test Mode ..... 9

    2.3 Connection Diagram of Test System ..... 10

    2.4 Support Unit used in test configuration and system ..... 11

    2.5 EUT Operation Test Setup ..... 11

    2.6 Measurement Results Explanation Example..... 11

**3 TEST RESULT ..... 12**

    3.1 6dB and 99% Bandwidth Measurement ..... 12

    3.2 Output Power Measurement..... 14

    3.3 Power Spectral Density Measurement ..... 15

    3.4 Conducted Band Edges and Spurious Emission Measurement ..... 17

    3.5 Radiated Band Edges and Spurious Emission Measurement ..... 27

    3.6 AC Conducted Emission Measurement..... 31

    3.7 Antenna Requirements ..... 33

**4 LIST OF MEASURING EQUIPMENT ..... 34**

**5 UNCERTAINTY OF EVALUATION ..... 35**

**APPENDIX A. CONDUCTED TEST RESULTS**

**APPENDIX B. AC CONDUCTED EMISSION TEST RESULT**

**APPENDIX C. RADIATED SPURIOUS EMISSION**

**APPENDIX D. RADIATED SPURIOUS EMISSION PLOTS**

**APPENDIX E. DUTY CYCLE PLOTS**



### REVISION HISTORY

REPORT NO.	VERSION	DESCRIPTION	ISSUED DATE
FR7D2018C	Rev. 01	Initial issue of report	Feb. 13, 2018



### SUMMARY OF TEST RESULT

Report Section	FCC Rule	Description	Limit	Result	Remark
3.1	15.247(a)(2)	6dB Bandwidth	$\geq 0.5\text{MHz}$	Pass	-
3.1	-	99% Bandwidth	-	Pass	-
3.2	15.247(b)	Power Output Measurement	$\leq 30\text{dBm}$	Pass	-
3.3	15.247(e)	Power Spectral Density	$\leq 8\text{dBm}/3\text{kHz}$	Pass	-
3.4	15.247(d)	Conducted Band Edges	$\leq 20\text{dBc}$	Pass	-
		Conducted Spurious Emission		Pass	-
3.5	15.247(d)	Radiated Band Edges and Radiated Spurious Emission	15.209(a) & 15.247(d)	Pass	Under limit 5.49 dB at 2483.520 MHz
3.6	15.207	AC Conducted Emission	15.207(a)	Pass	Under limit 17.00 dB at 0.150 MHz
3.7	15.203 & 15.247(b)	Antenna Requirement	N/A	Pass	-



# 1 General Description

## 1.1 Applicant

**Motorola Mobility LLC**  
222 W. Merchandise Mart Plaza, Chicago IL 60654, USA

## 1.2 Manufacturer

**Motorola Mobility LLC**  
222 W. Merchandise Mart Plaza, Chicago IL 60654, USA

## 1.3 Product Feature of Equipment Under Test

Product Feature	
<b>Equipment</b>	Mobile Cellular Phone
<b>Brand Name</b>	Motorola
<b>Model Name</b>	XT1921-5, XT1921-3
<b>FCC ID</b>	IHDT56XC2
<b>IMEI Code</b>	990005440074244 (for Radiation) 990005440016179 (for Conduction)
<b>EUT supports Radios application</b>	CDMA/EV-DO/GSM/EGPRS/WCDMA/HSPA/LTE/FM/GNSS WLAN 11b/g/n HT20 WLAN 11a/n HT20/HT40 Bluetooth BR/EDR/LE
<b>HW Version</b>	DVT1B
<b>EUT Stage</b>	Identical Prototype

**Remark:** The above EUT's information was declared by manufacturer. Please refer to the specifications or user's manual for more detailed description.

Accessory List	
<b>AC Adapter 1</b>	Brand Name : Motorola
	Model Name : C-P35
<b>AC Adapter 2</b>	Brand Name : Motorola
	Model Name : SSW-2919UMTJ C-P35 SPN5945A
<b>AC Adapter 3</b>	Brand Name : Motorola
	Model Name : C-P56
<b>AC Adapter 4</b>	Brand Name : Motorola
	Model Name : C-P56
<b>Battery</b>	Brand Name : Motorola
	Model Name : GK40
<b>USB Cable</b>	Brand Name : Saibao
	Model Name : SWT-A083A



### 1.4 Product Specification of Equipment Under Test

Standards-related Product Specification	
Tx/Rx Channel Frequency Range	2412 MHz ~ 2462 MHz
Maximum (Peak) Output Power to antenna	802.11b : 21.17 dBm (0.1309 W) 802.11g : 20.54 dBm (0.1132 W) 802.11n HT20 : 18.60 dBm (0.0724 W)
99% Occupied Bandwidth	802.11b : 13.85MHz 802.11g : 18.25MHz 802.11n HT20 : 19.10MHz
Antenna Type / Gain	PIFA Antenna with gain -3.2 dBi
Type of Modulation	802.11b : DSSS (DBPSK / DQPSK / CCK) 802.11g/n : OFDM (BPSK / QPSK / 16QAM / 64QAM)

### 1.5 Modification of EUT

No modifications are made to the EUT during all test items.



### 1.6 Testing Location

Sporton Lab is accredited to ISO 17025 by Taiwan Accreditation Foundation (TAF code : 1190) and the FCC designation No. TW1190 and TW0007 under the FCC 2.948(e) by Mutual Recognition Agreement (MRA) in FCC Test.

<b>Test Site</b>	SPORTON INTERNATIONAL INC.	
<b>Test Site Location</b>	No. 52, Hwa Ya 1 <sup>st</sup> Rd., Hwa Ya Technology Park, Kwei-Shan District, Tao Yuan City, Taiwan, R.O.C. TEL: +886-3-327-3456 FAX: +886-3-328-4978	
<b>Test Site No.</b>	<b>Sporton Site No.</b>	
	TH05-HY	CO05-HY

**Note:** The test site complies with ANSI C63.4 2014 requirement.

<b>Test Site</b>	SPORTON INTERNATIONAL INC.	
<b>Test Site Location</b>	No.58, Aly. 75, Ln. 564, Wenhua 3rd Rd., Kwei-Shan District, Tao Yuan City, Taiwan R.O.C. TEL: +886-3-327-0868 FAX: +886-3-327-0855	
<b>Test Site No.</b>	<b>Sporton Site No. :</b>	
	03CH13-HY	

**Note:** The test site complies with ANSI C63.4 2014 requirement.

### 1.7 Applicable Standards

According to the specifications of the manufacturer, the EUT must comply with the requirements of the following standards:

- ♦ FCC Part 15 Subpart C §15.247
- ♦ FCC KDB Publication No. 558074 D01 DTS Meas. Guidance v04
- ♦ ANSI C63.10-2013

**Remark:**

1. All test items were verified and recorded according to the standards and without any deviation during the test.
2. This EUT has also been tested and complied with the requirements of FCC Part 15, Subpart B, recorded in a separate test report.



## 2 Test Configuration of Equipment Under Test

- a. The EUT has been associated with peripherals and configuration operated in a manner tended to maximize its emission characteristics in a typical application. Frequency range investigated: conduction emission (150 kHz to 30 MHz), radiation emission (9 kHz to the 10th harmonic of the highest fundamental frequency or to 40 GHz, whichever is lower). For radiated measurement, pre-scanned in three orthogonal panels, X, Y, Z. The worst cases (X plane) were recorded in this report.
  
- b. AC power line Conducted Emission was tested under maximum output power.

### 2.1 Carrier Frequency and Channel

Frequency Band	Channel	Freq. (MHz)	Channel	Freq. (MHz)
2400-2483.5 MHz	1	2412	7	2442
	2	2417	8	2447
	3	2422	9	2452
	4	2427	10	2457
	5	2432	11	2462
	6	2437		





## 2.2 Test Mode

Final test modes are considering the modulation and worse data rates as below table.

Modulation	Data Rate
802.11b	1 Mbps
802.11g	6 Mbps
802.11n HT20	MCS0

Test Cases	
<b>AC Conducted Emission</b>	Mode 1 :GSM850 Idle + Bluetooth Link + WLAN (2.4GHz) Link + MP3 + SD Card + USB Cable (Charging from Adapter 1) + Earphone
<b>Remark:</b> For Radiated Test Cases, The tests were performance with Adapter 1.	

## 2.3 Connection Diagram of Test System

<WLAN Tx Mode>

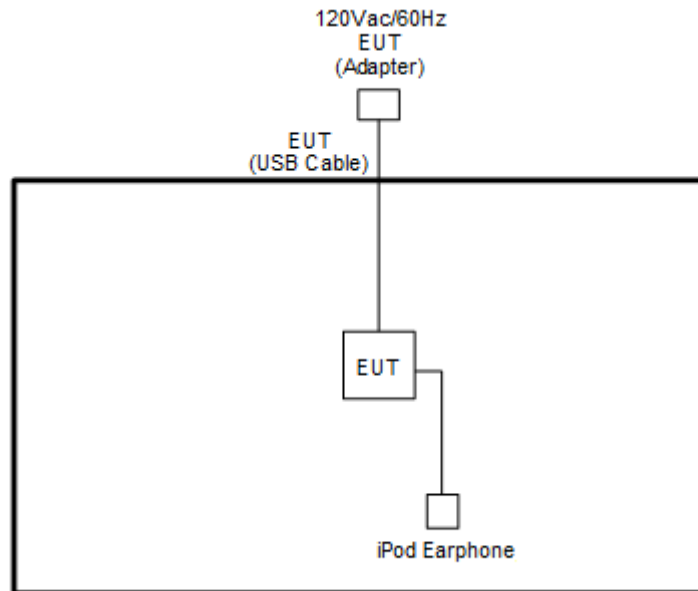

<AC Conducted Emission Mode>

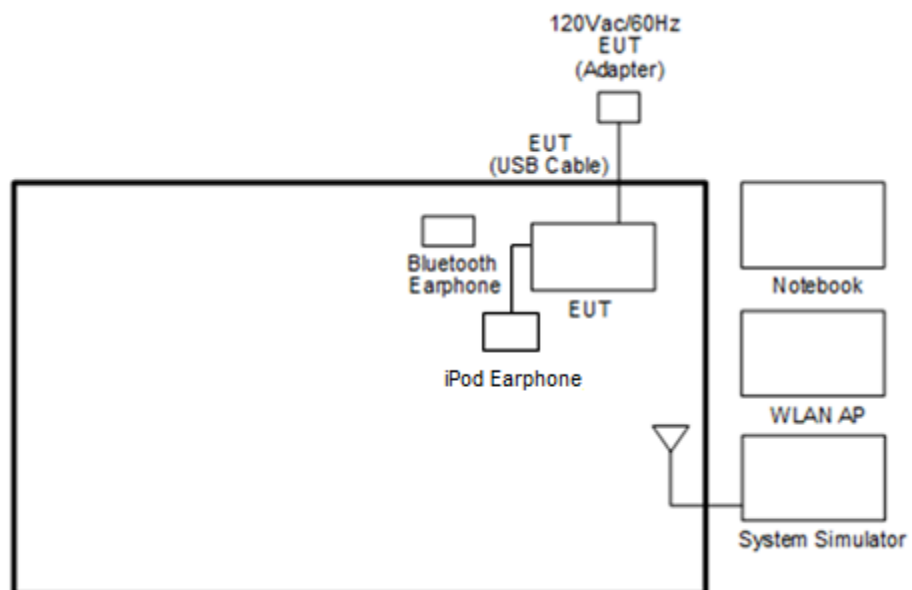



### 2.4 Support Unit used in test configuration and system

Item	Equipment	Trade Name	Model Name	FCC ID	Data Cable	Power Cord
1.	System Simulator	Anritsu	MT8820C	N/A	N/A	Unshielded, 1.8 m
2.	Bluetooth Earphone	Sony Ericsson	MW600	PY7DDA-2029	N/A	N/A
3.	WLAN AP	ASUS	RT-AC66U	MSQ-RTAC66U	N/A	Unshielded,1.8m
4.	iPod Earphone	Apple	A1285	FCC DoC	Shielded, 1.0 m	N/A
5.	Notebook	DELL	Latitude E6320	FCC DoC/ Contains FCC ID: QDS-BRCM1054	N/A	AC I/P: Unshielded, 1.2 m DC O/P: Shielded, 1.8 m
6.	SD Card	SanDisk	MicroSD HC	FCC DoC	N/A	N/A

### 2.5 EUT Operation Test Setup

The RF test items, utility “QRCT” was installed in Notebook which was programmed in order to make the EUT get into the engineering modes to provide channel selection, power level, data rate and the application type and for continuous transmitting signals.

### 2.6 Measurement Results Explanation Example

For all conducted test items:

The offset level is set in the spectrum analyzer to compensate the RF cable loss and attenuator factor between EUT conducted output port and spectrum analyzer. With the offset compensation, the spectrum analyzer reading level is exactly the EUT RF output level.

Example:

The spectrum analyzer offset is derived from RF cable loss and attenuator factor.

*Offset = RF cable loss + attenuator factor.*

Following shows an offset computation example with cable loss 4.2 dB and 10dB attenuator.

$$Offset(dB) = RF\ cable\ loss(dB) + attenuator\ factor(dB).$$

$$= 4.2 + 10 = 14.2\ (dB)$$

### 3 Test Result

#### 3.1 6dB and 99% Bandwidth Measurement

##### 3.1.1 Limit of 6dB and 99% Bandwidth

The minimum 6 dB bandwidth shall be at least 500 kHz.

##### 3.1.2 Measuring Instruments

The measuring equipment is listed in the section 4 of this test report.

##### 3.1.3 Test Procedures

1. The testing follows FCC KDB Publication No. 558074 DTS D01 Meas. Guidance v04.
2. The RF output of EUT was connected to the spectrum analyzer by RF cable and attenuator. The path loss was compensated to the results for each measurement.
3. Set to the maximum power setting and enable the EUT transmit continuously.
4. Make the measurement with the spectrum analyzer's resolution bandwidth (RBW) = 100 kHz. Set the Video bandwidth (VBW) = 300 kHz. In order to make an accurate measurement. The 6 dB bandwidth must be greater than 500 kHz.
5. For 99% Bandwidth Measurement, the spectrum analyzer's resolution bandwidth (RBW) = 1MHz and set the Video bandwidth (VBW) = 3MHz.
6. Measure and record the results in the test report.

##### 3.1.4 Test Setup





### 3.1.5 Test Result of 6dB and 99% Occupied Bandwidth

Please refer to Appendix A.

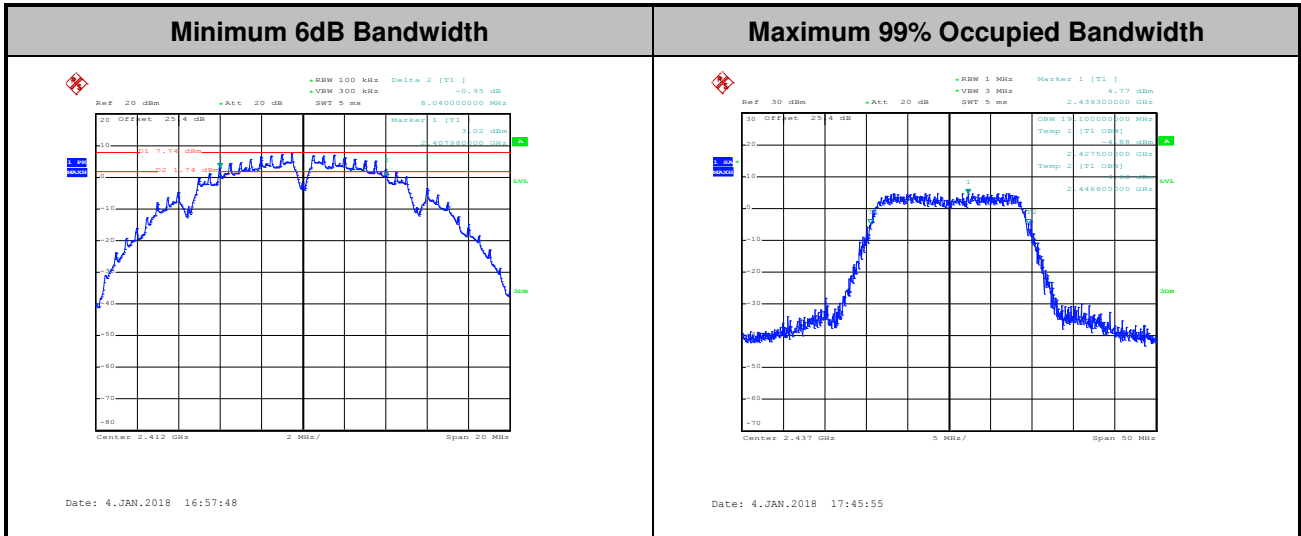

Note : The occupied channel bandwidth is maintained within the band of operation for all of the modulations.

## 3.2 Output Power Measurement

### 3.2.1 Limit of Output Power

For systems using digital modulation in the 2400-2483.5MHz, the limit for peak output power is 30dBm. If transmitting antenna with directional gain greater than 6dBi is used, the peak output power from the intentional radiator shall be reduced below the above stated value by the amount in dB that the directional gain of the antenna exceeds 6 dBi. In case of point-to-point operation, the limit has to be reduced by 1dB for every 3dB that the directional gain of the antenna exceeds 6dBi.

### 3.2.2 Measuring Instruments

The measuring equipment is listed in the section 4 of this test report.

### 3.2.3 Test Procedures

1. The testing follows the Measurement Procedure of FCC KDB No. 558074 DTS D01 Meas. Guidance v04 section 9.1.3 PKPM1 Peak power meter method.
2. The RF output of EUT was connected to the power meter by RF cable and attenuator. The path loss was compensated to the results for each measurement.
3. Set to the maximum power setting and enable the EUT transmit continuously.
4. Measure the conducted output power and record the results in the test report.

### 3.2.4 Test Setup

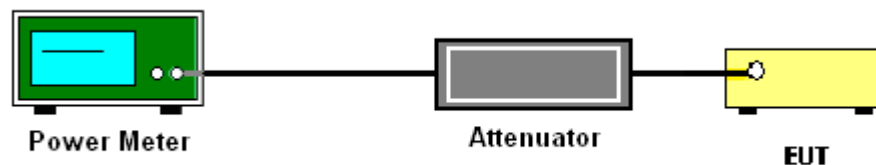

### 3.2.5 Test Result of Peak Output Power

Please refer to Appendix A.

### 3.2.6 Test Result of Average output Power (Reporting Only)

Please refer to Appendix A.

### 3.3 Power Spectral Density Measurement

#### 3.3.1 Limit of Power Spectral Density

The peak power spectral density shall not be greater than 8dBm in any 3kHz band at any time interval of continuous transmission.

#### 3.3.2 Measuring Instruments

The measuring equipment is listed in the section 4 of this test report.

#### 3.3.3 Test Procedures

1. The testing follows Measurement Procedure 10.2 Method PKPSD of FCC KDB Publication No. 558074 D01 DTS Meas. Guidance v04
2. The RF output of EUT was connected to the spectrum analyzer by RF cable and attenuator. The path loss was compensated to the results for each measurement.
3. Set to the maximum power setting and enable the EUT transmit continuously.
4. Make the measurement with the spectrum analyzer's resolution bandwidth (RBW) = 3 kHz. Video bandwidth VBW = 10 kHz In order to make an accurate measurement, set the span to 1.5 times DTS Channel Bandwidth. (6dB BW)
5. Detector = peak, Sweep time = auto couple, Trace mode = max hold, Allow trace to fully stabilize. Use the peak marker function to determine the maximum power level.
6. Measure and record the results in the test report.

#### 3.3.4 Test Setup



#### 3.3.5 Test Result of Power Spectral Density

Please refer to Appendix A.

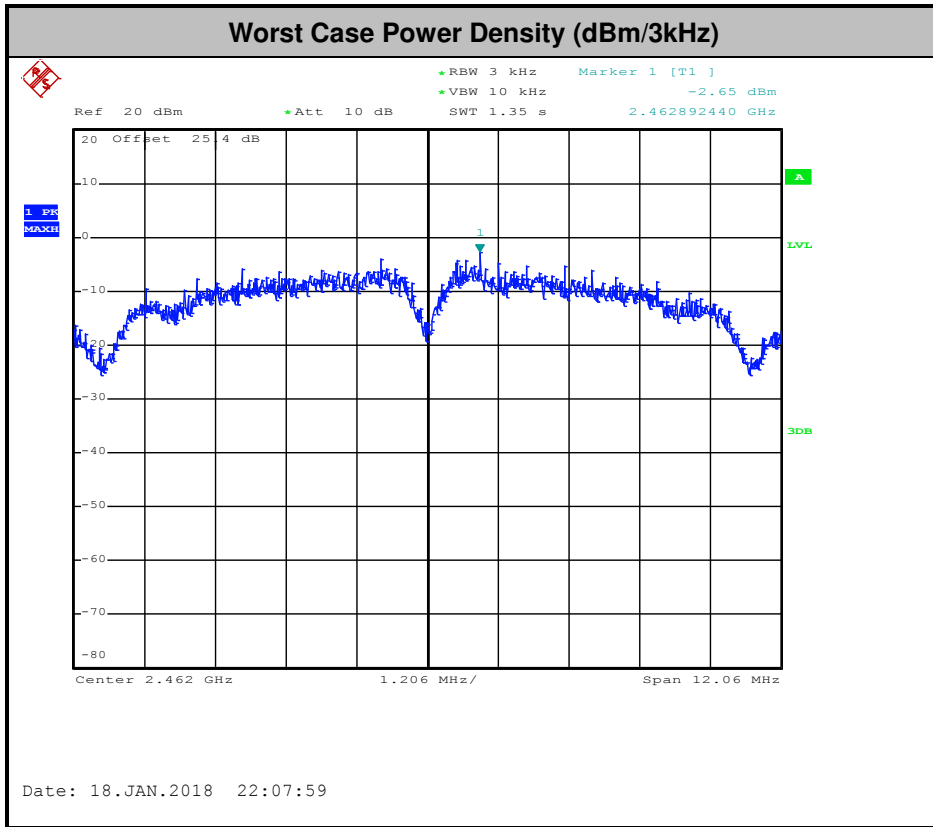



## 3.4 Conducted Band Edges and Spurious Emission Measurement

### 3.4.1 Limit of Conducted Band Edges and Spurious Emission Measurement

In any 100 kHz bandwidth outside of the authorized frequency band, the emissions which fall in the non-restricted bands shall be attenuated at least 20 dB / 30dB relative to the maximum PSD level in 100 kHz by RF conducted measurement.

### 3.4.2 Measuring Instruments

The measuring equipment is listed in the section 4 of this test report.

### 3.4.3 Test Procedures

1. The testing follows FCC KDB Publication No. 558074 D01 DTS Meas. Guidance v04.
2. The RF output of EUT was connected to the spectrum analyzer by RF cable and attenuator. The path loss was compensated to the results for each measurement.
3. Set to the maximum power setting and enable the EUT transmit continuously.
4. Set RBW = 100 kHz, VBW=300 kHz, Peak Detector. Unwanted Emissions measured in any 100 kHz bandwidth outside of the authorized frequency band shall be attenuated by at least 20 dB relative to the maximum in-band peak PSD level in 100 kHz when maximum peak conducted output power procedure is used. If the transmitter complies with the conducted power limits based on the use of RMS averaging over a time interval, the attenuation required under this paragraph shall be 30 dB instead of 20 dB per 15.247(d).
5. Measure and record the results in the test report.
6. The RF fundamental frequency should be excluded against the limit line in the operating frequency band.

### 3.4.4 Test Setup

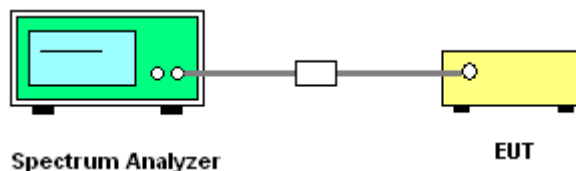



### 3.4.5 Test Result of Conducted Band Edges and Spurious Emission

Test Engineer : Derek Hsu and Reece Lin	Temperature :	21~25°C
	Relative Humidity :	51~54%

Number of TX = 1, Ant. 1 (Measured)

Test Mode :	802.11b	Test Channel :	01
-------------	---------	----------------	----

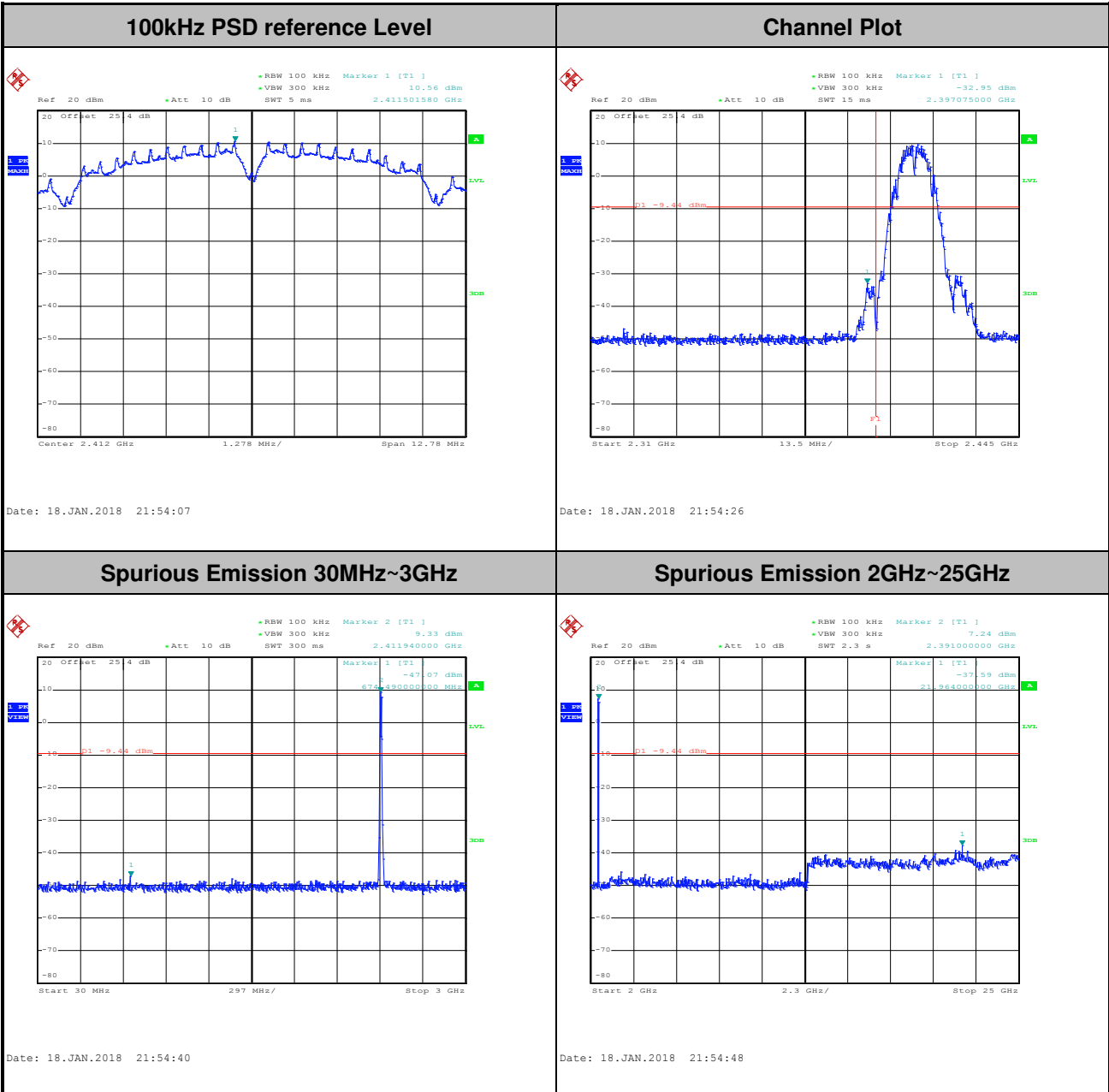



Test Mode :	802.11b	Test Channel :	06
-------------	---------	----------------	----

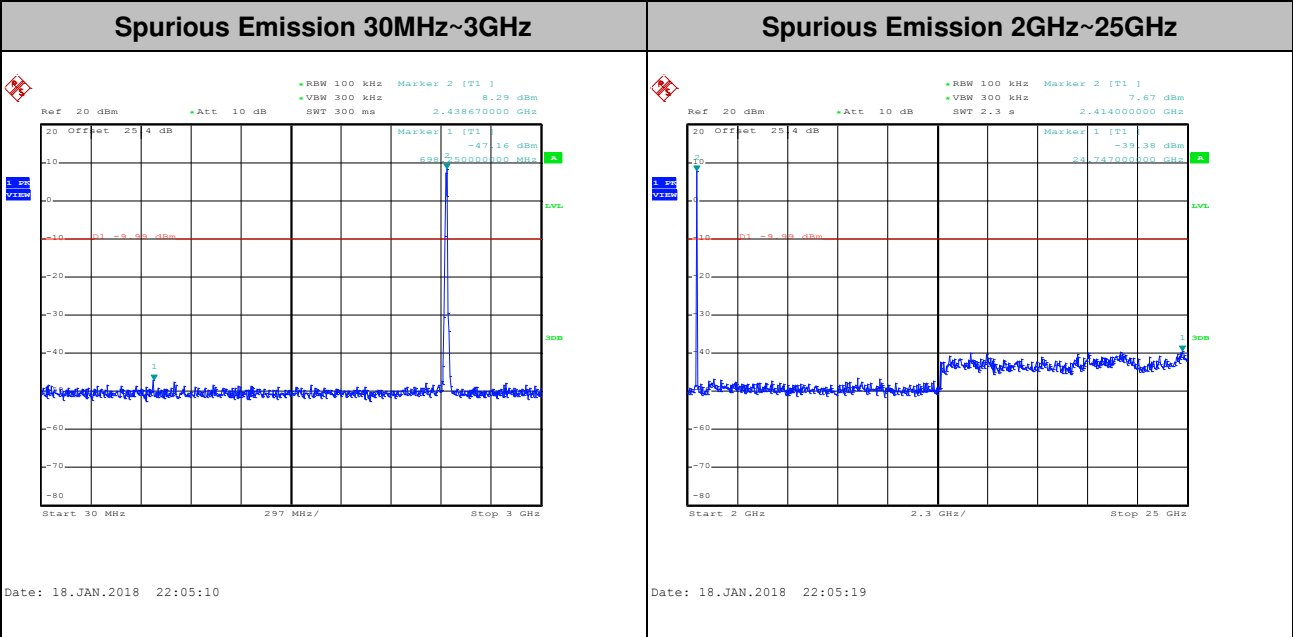
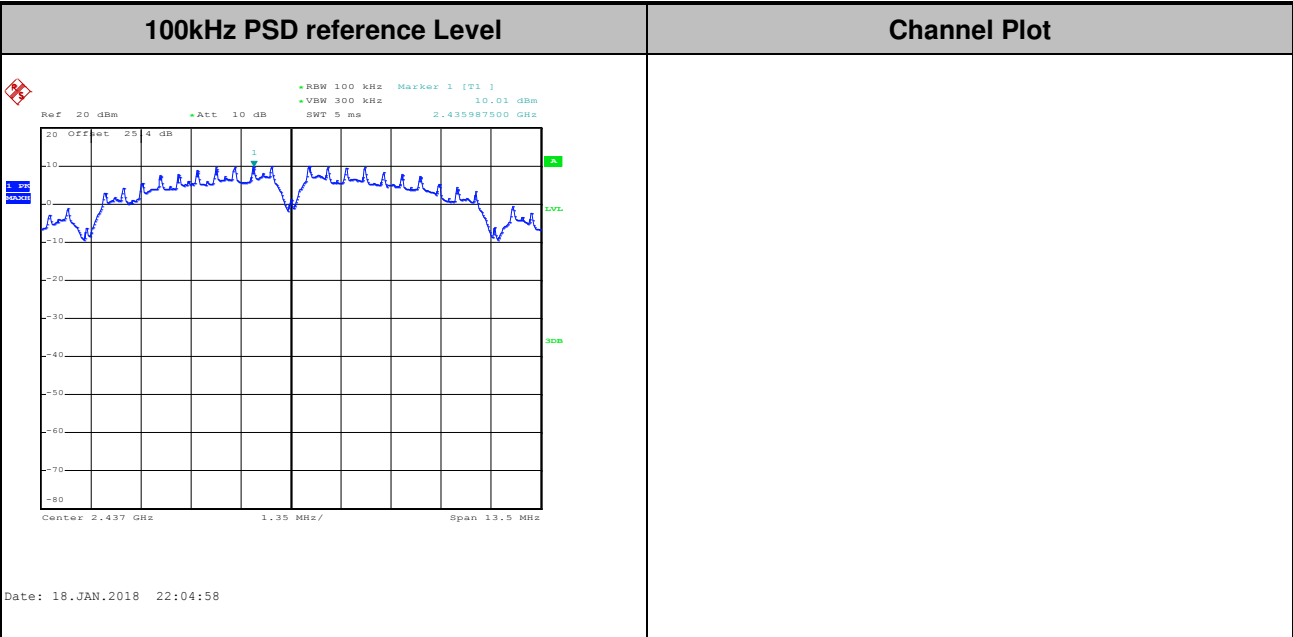



Test Mode :	802.11b	Test Channel :	11
-------------	---------	----------------	----

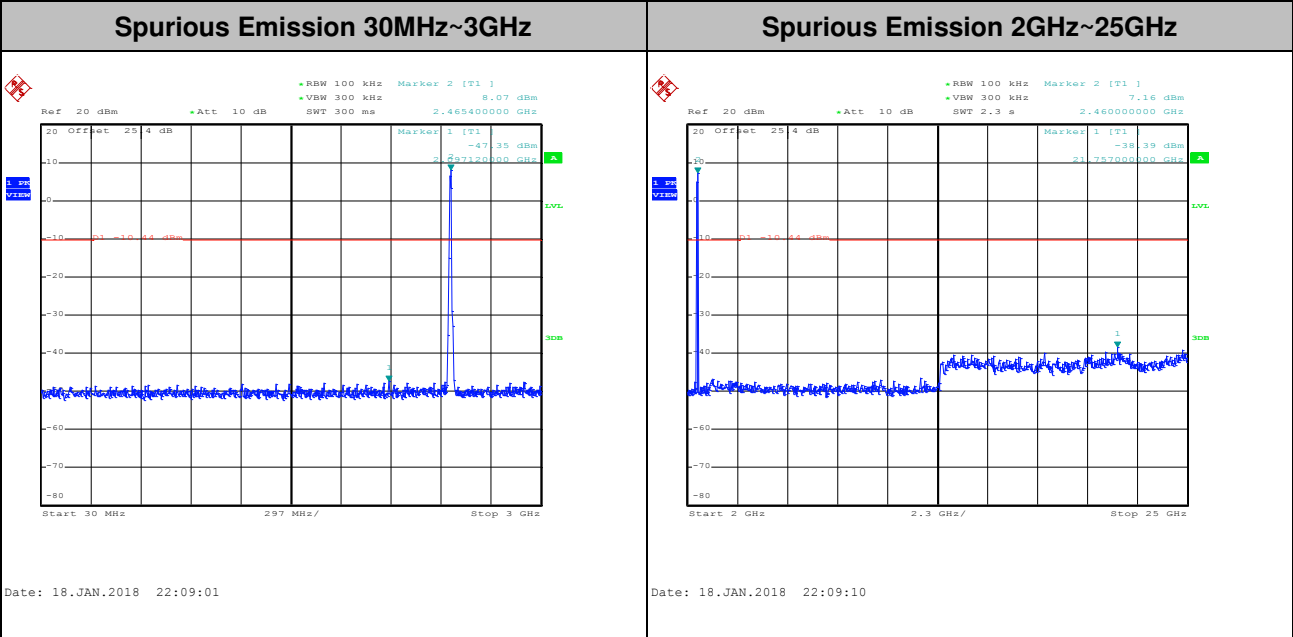
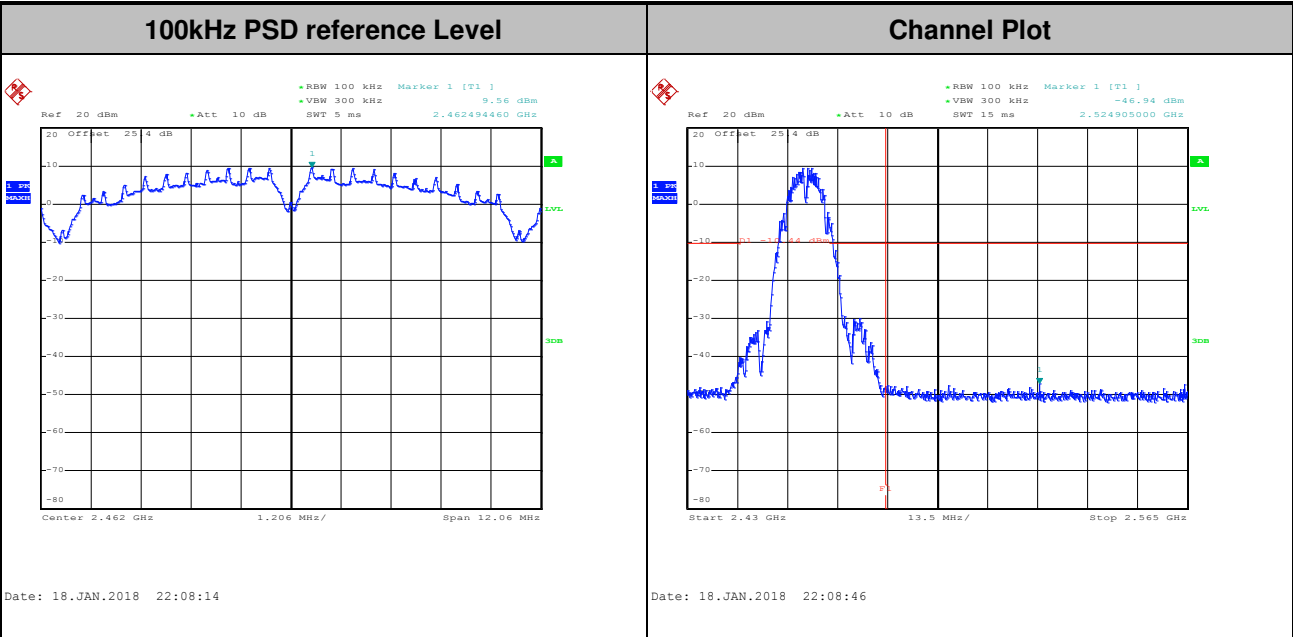



Test Mode : 802.11g Test Channel : 01

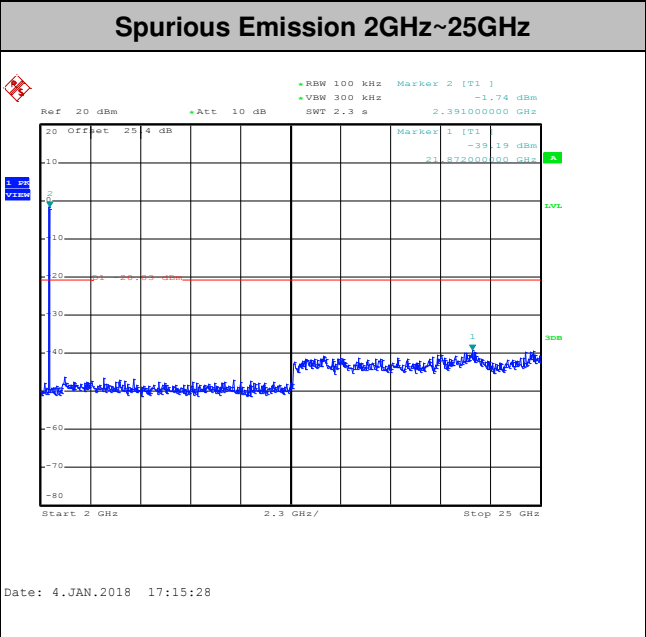
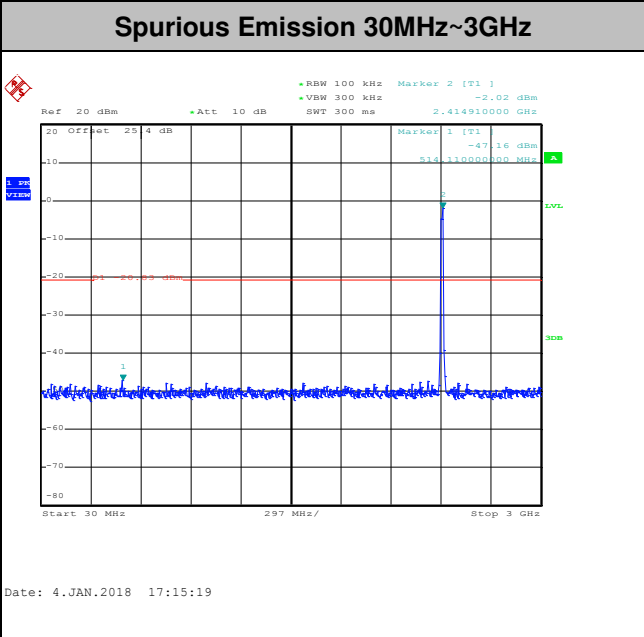
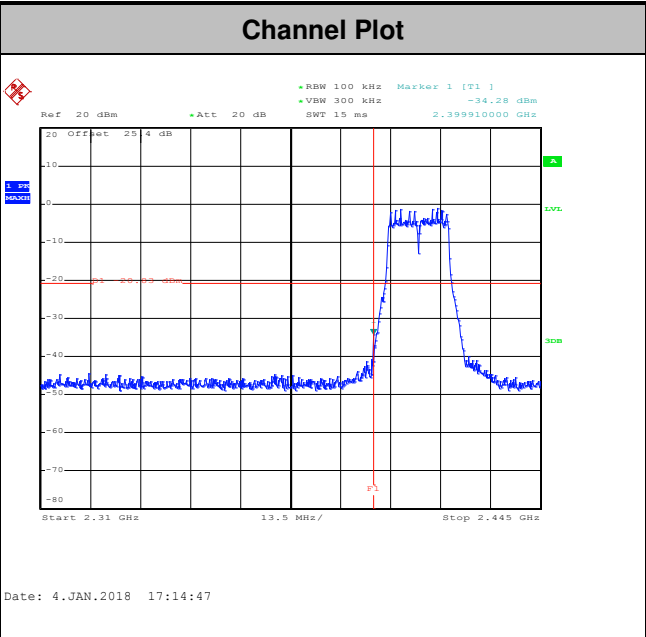
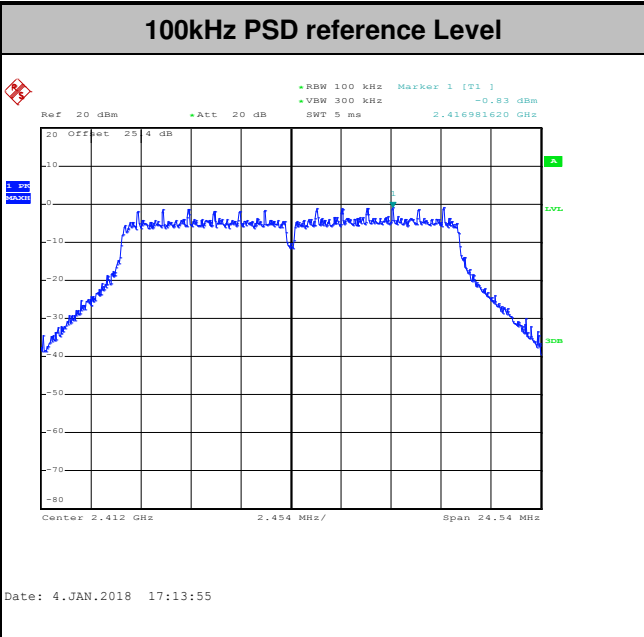



Test Mode :	802.11g	Test Channel :	06
-------------	---------	----------------	----

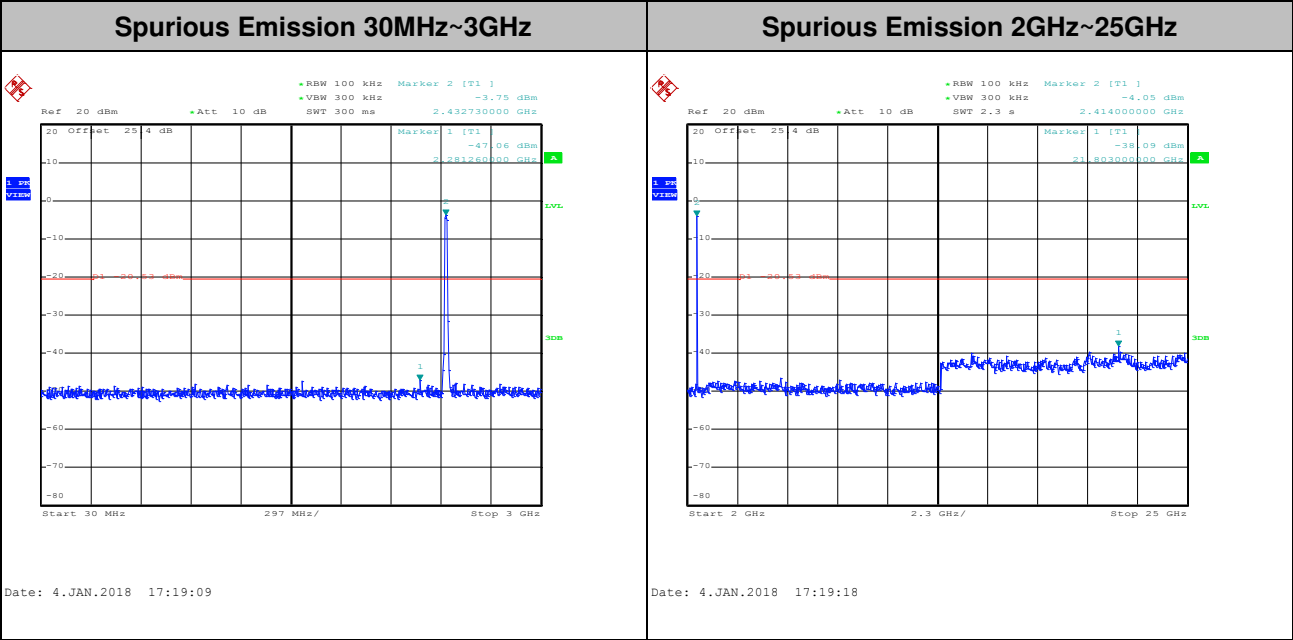
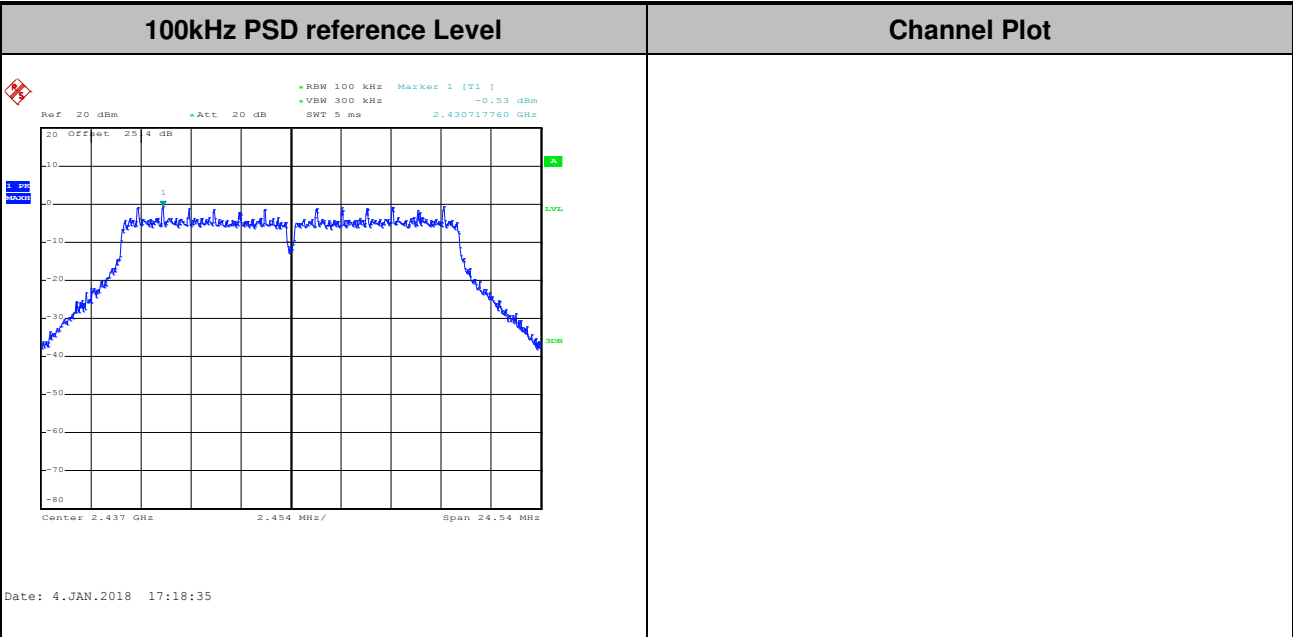



Test Mode :	802.11g	Test Channel :	11
-------------	---------	----------------	----

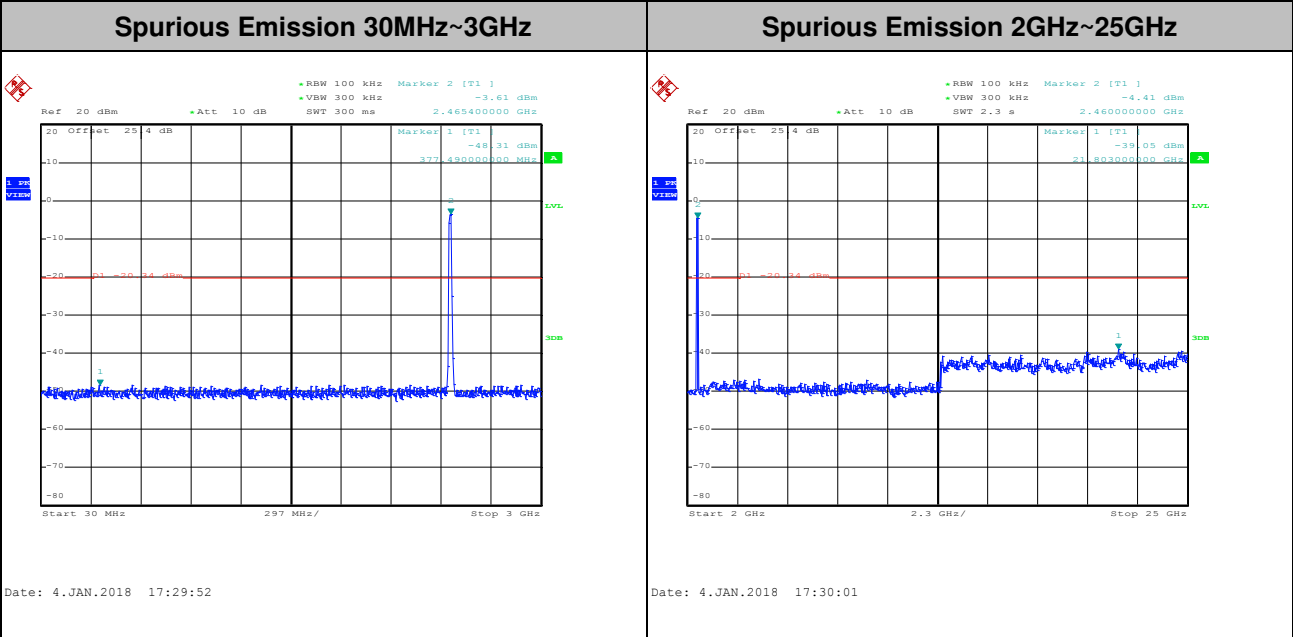
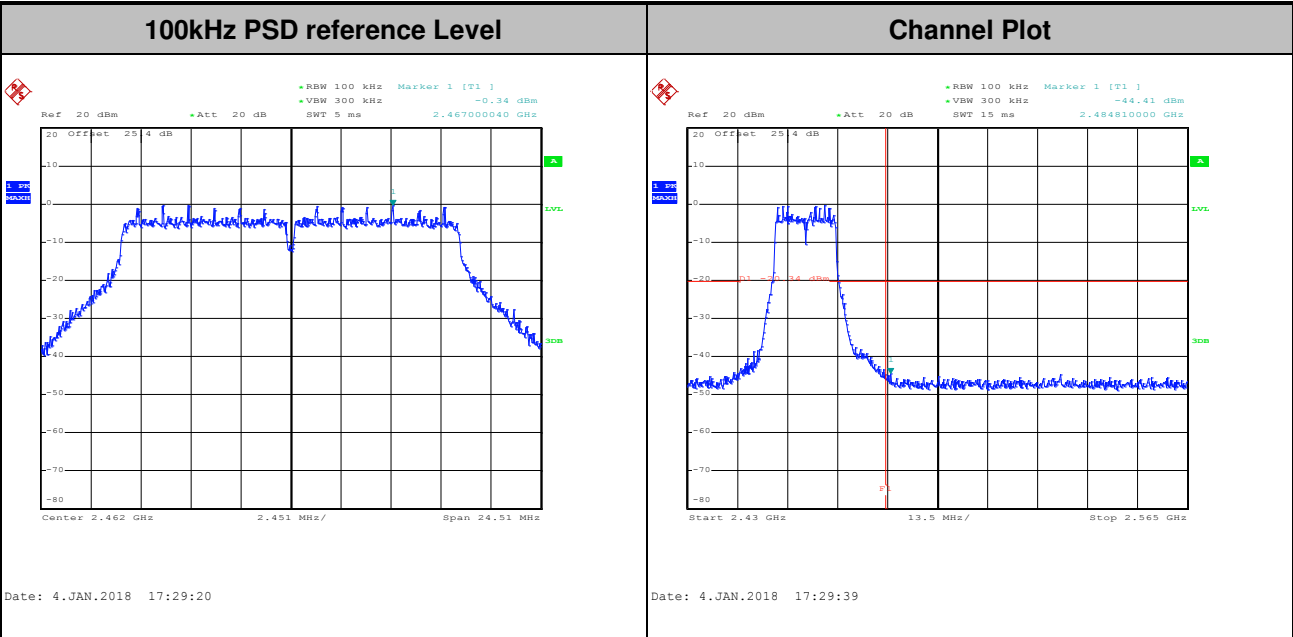



Test Mode : 802.11n HT20 Test Channel : 01

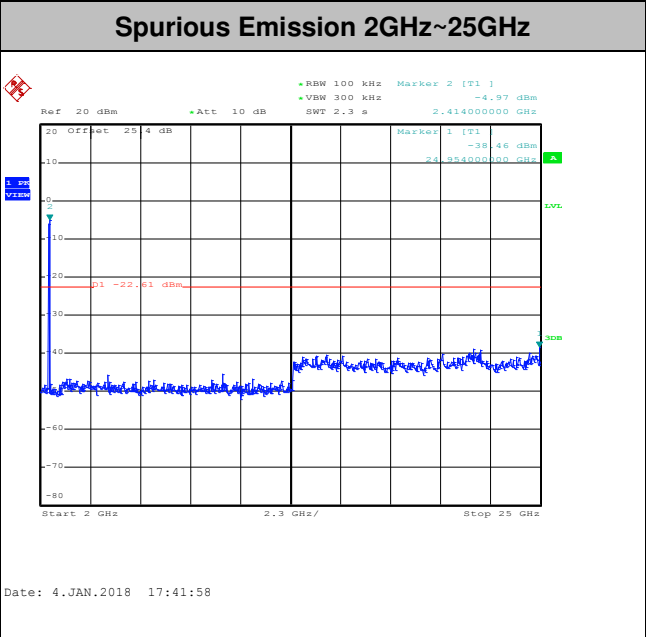
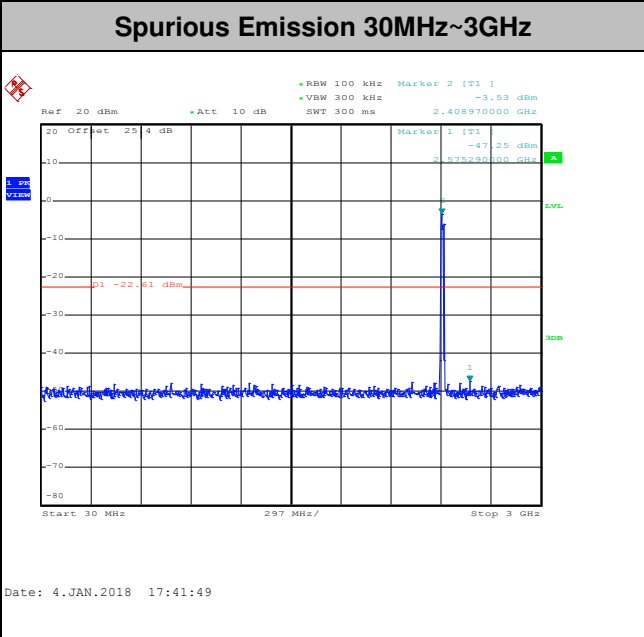
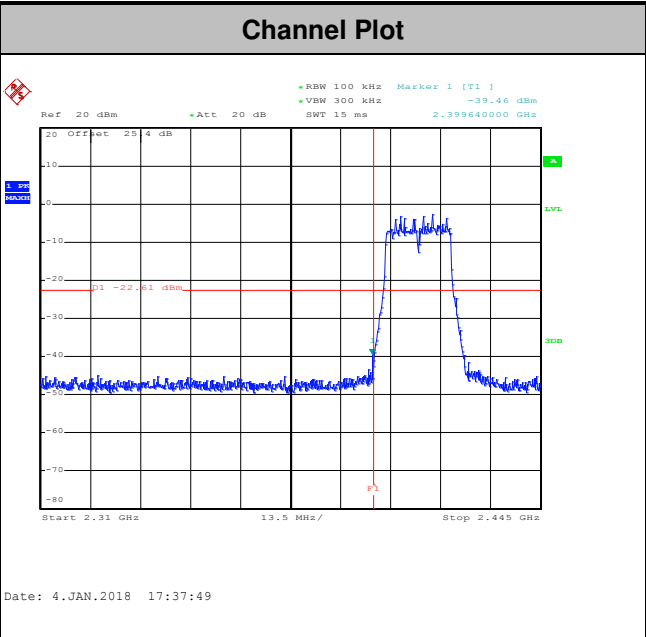
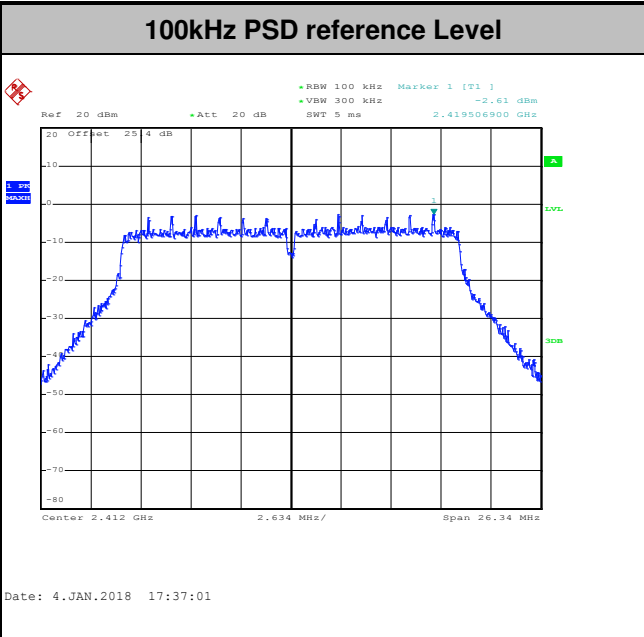





Test Mode :	802.11n HT20	Test Channel :	06
-------------	--------------	----------------	----

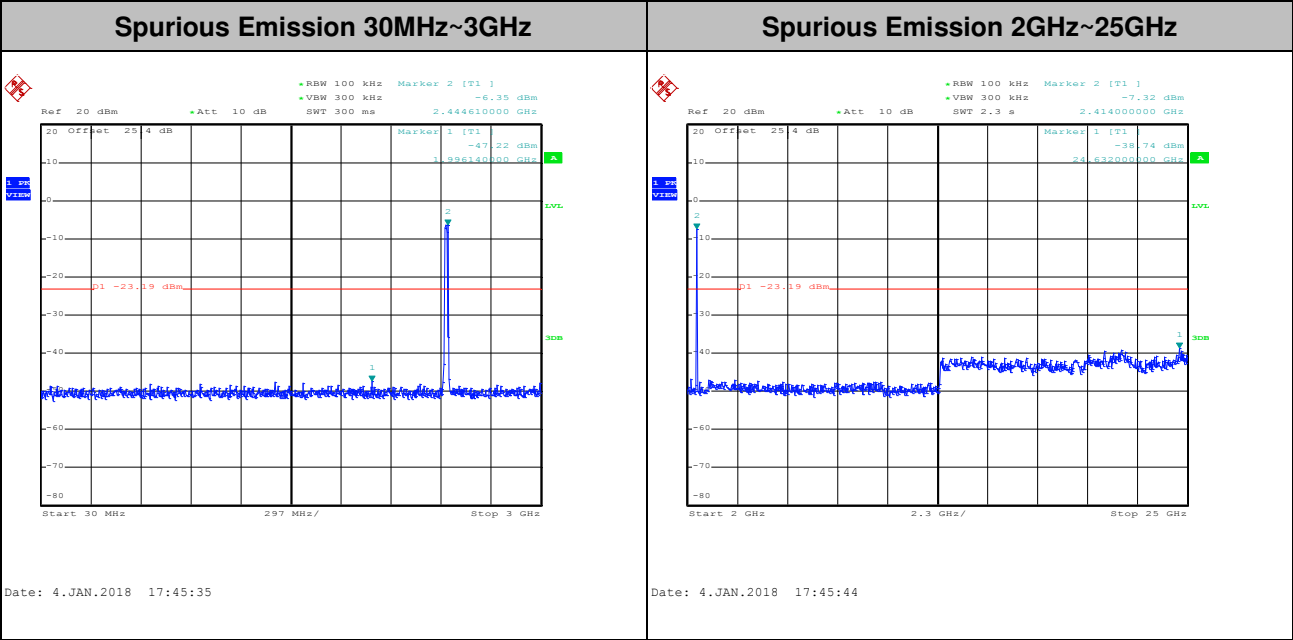
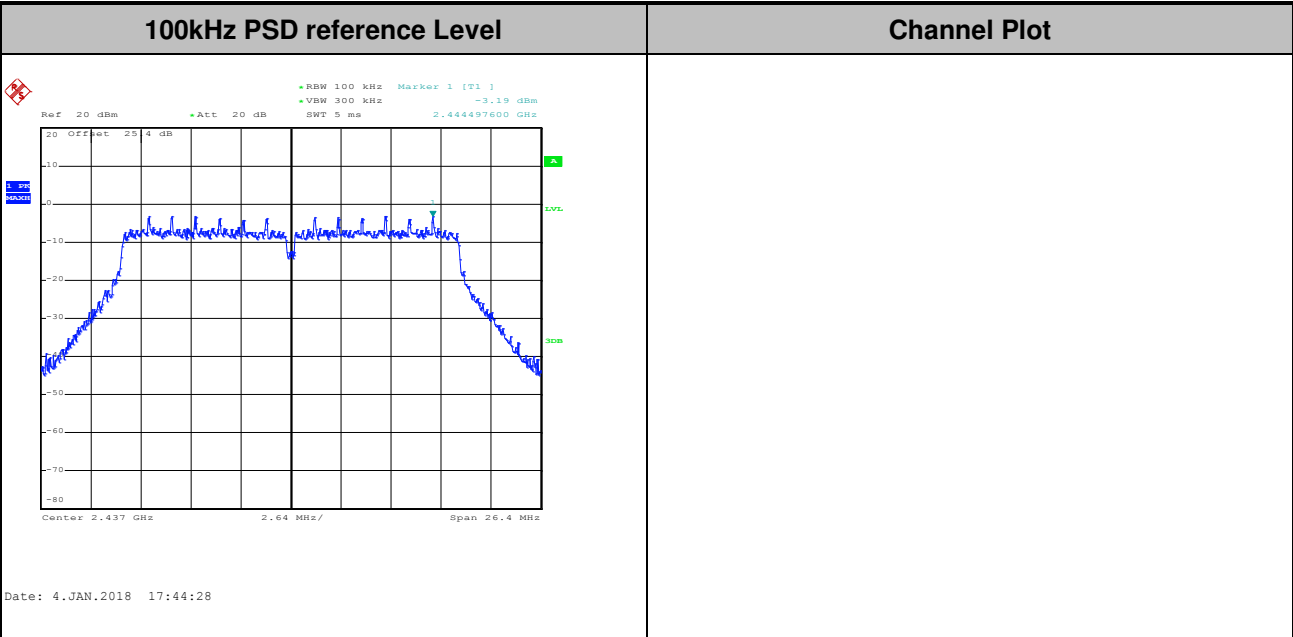



Test Mode :	802.11n HT20	Test Channel :	11
-------------	--------------	----------------	----

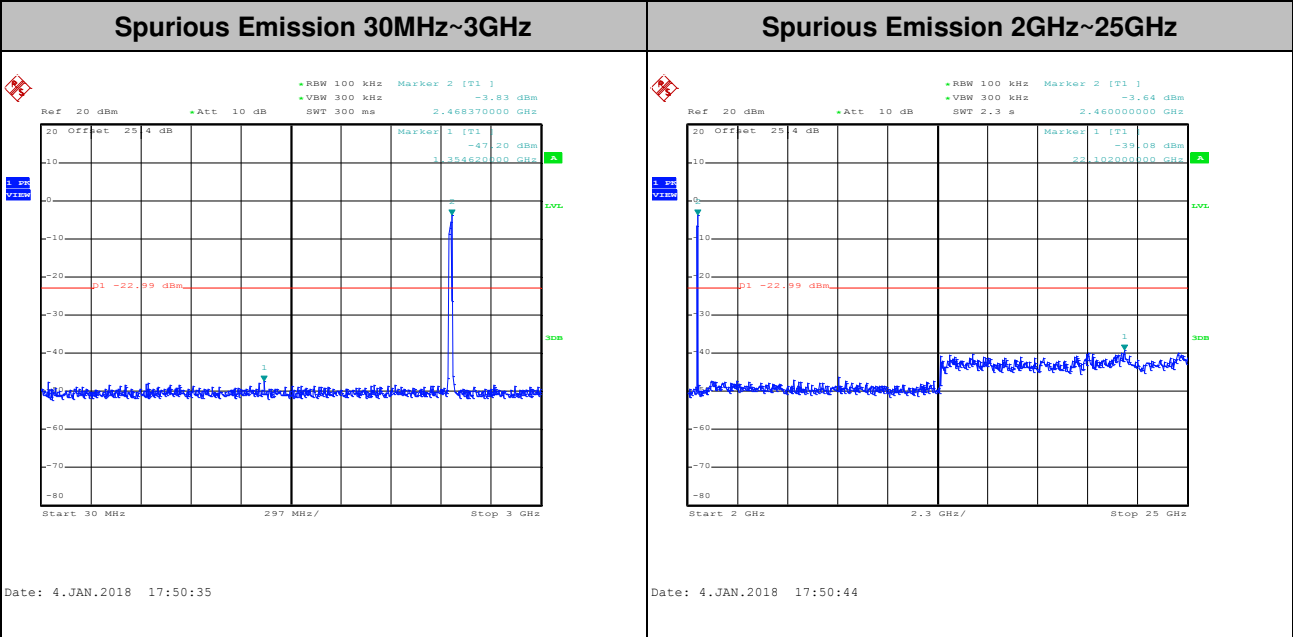
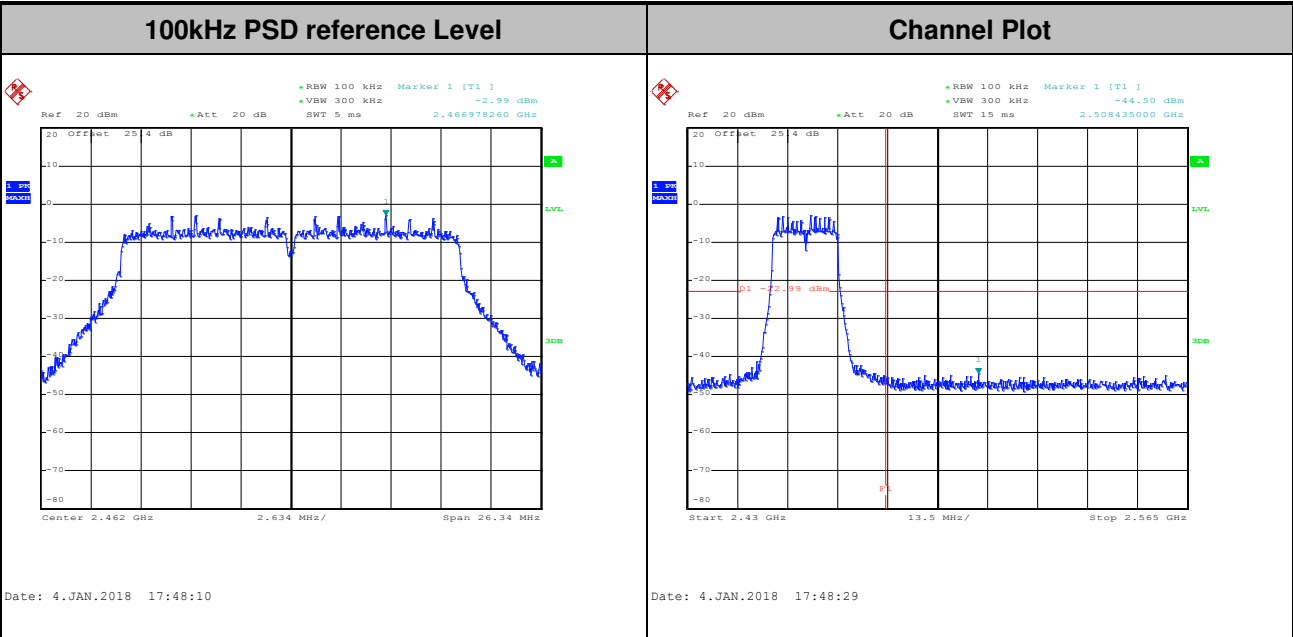



### 3.5 Radiated Band Edges and Spurious Emission Measurement

#### 3.5.1 Limit of Radiated band edge and Spurious Emission Measurement

In any 100 kHz bandwidth outside the intentional radiator frequency band, all harmonics/spurious must be at least 20 dB below the highest emission level within the authorized band. If the output power of this device was measured by spectrum analyzer, the attenuation under this paragraph shall be 30 dB instead of 20 dB. In addition, radiated emissions which fall in the restricted bands must also comply with the limits as below.

Frequency (MHz)	Field Strength (microvolts/meter)	Measurement Distance (meters)
0.009 – 0.490	2400/F(kHz)	300
0.490 – 1.705	24000/F(kHz)	30
1.705 – 30.0	30	30
30 – 88	100	3
88 – 216	150	3
216 - 960	200	3
Above 960	500	3

#### 3.5.2 Measuring Instruments

The measuring equipment is listed in the section 4 of this test report.



### 3.5.3 Test Procedures

1. The testing follows FCC KDB Publication No. 558074 D01 DTS Meas. Guidance v04.
2. The EUT was arranged to its worst case and then tune the antenna tower (from 1 m to 4 m) and turntable (from 0 degree to 360 degrees) to find the maximum reading. A pre-amp and a high pass filter are used for the test in order to get better signal level.
3. The EUT was placed on a turntable with 0.8 meter for frequency below 1GHz and 1.5 meter for frequency above 1GHz respectively above ground.
4. The EUT was set 3 meters from the interference receiving antenna, which was mounted on the top of a variable height antenna tower.
5. Corrected Reading: Antenna Factor + Cable Loss + Read Level - Preamp Factor = Level
6. For testing below 1GHz, if the emission level of the EUT in peak mode was 3 dB lower than the limit specified, then peak values of EUT will be reported, otherwise, the emissions will be repeated one by one using the CISPR quasi-peak method and reported.
7. For testing above 1GHz, the emission level of the EUT in peak mode was 20dB lower than average limit (that means the emission level in average mode also complies with the limit in average mode), then peak values of EUT will be reported, otherwise, the emissions will be measured in average mode again and reported.
8. Use the following spectrum analyzer settings:
  - (1) Span shall wide enough to fully capture the emission being measured;
  - (2) Set RBW=100 kHz for  $f < 1$  GHz; VBW  $\geq$  RBW; Sweep = auto; Detector function = peak; Trace = max hold;
  - (3) Set RBW = 1 MHz, VBW= 3MHz for  $f \geq 1$  GHz for peak measurement.  
For average measurement:
    - VBW = 10 Hz, when duty cycle is no less than 98 percent.
    - VBW  $\geq 1/T$ , when duty cycle is less than 98 percent where T is the minimum transmission duration over which the transmitter is on and is transmitting at its maximum power control level for the tested mode of operation.

### 3.5.4 Test Setup

For radiated emissions below 30MHz



For radiated emissions from 30MHz to 1GHz

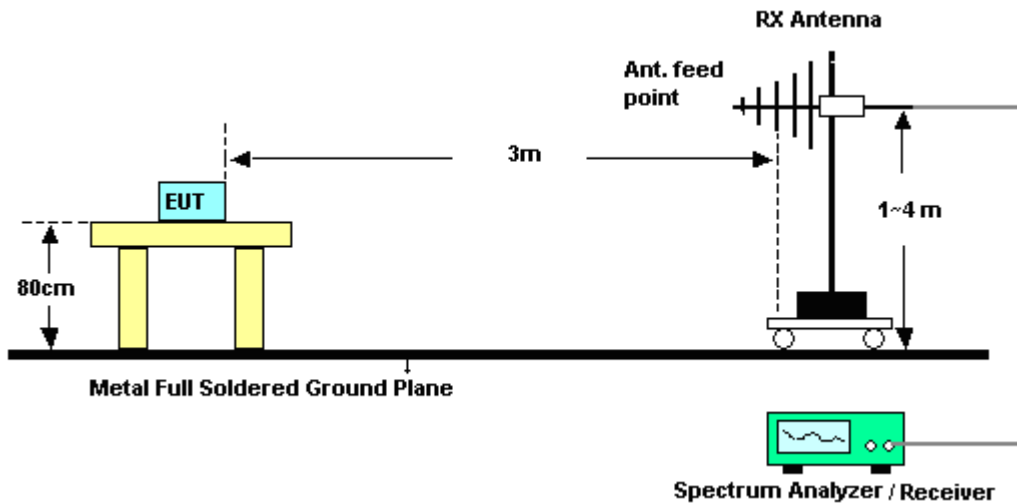

For radiated emissions above 1GHz

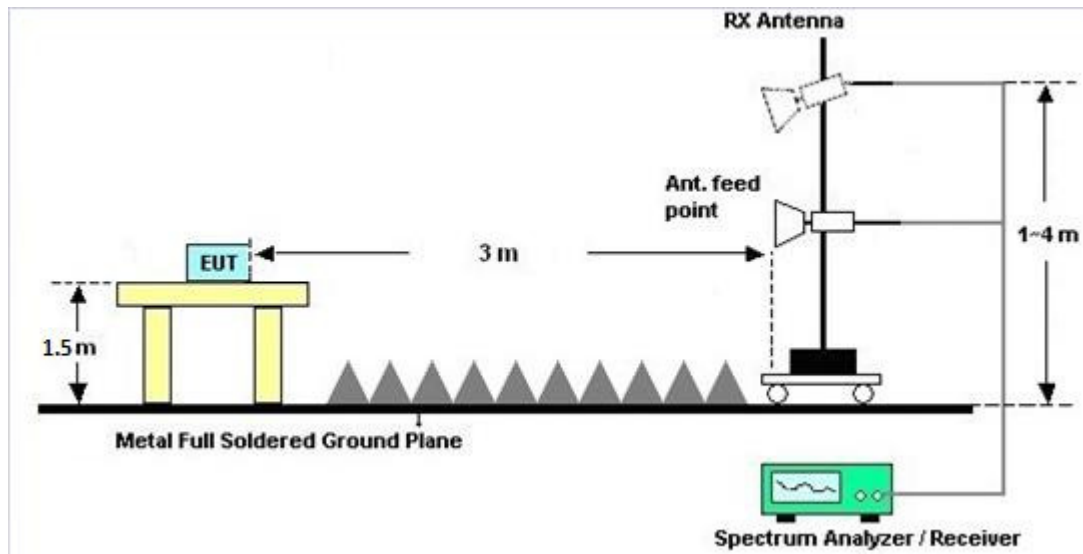

### 3.5.5 Test Results of Radiated Spurious Emissions (9kHz ~ 30MHz)

The low frequency, which started from 9 kHz to 30MHz, was pre-scanned and the result which was 20dB lower than the limit line was not reported.

There is a comparison data of both open-field test site and semi-Anechoic chamber, and the result came out very similar.

### 3.5.6 Test Result of Radiated Spurious at Band Edges

Please refer to Appendix C and D.

### 3.5.7 Duty Cycle

Please refer to Appendix E.

### 3.5.8 Test Result of Radiated Spurious Emission (30MHz ~ 10<sup>th</sup> Harmonic)

Please refer to Appendix C and D.



### 3.6 AC Conducted Emission Measurement

#### 3.6.1 Limit of AC Conducted Emission

For equipment that is designed to be connected to the public utility (AC) power line, the radio frequency voltage that is conducted back onto the AC power line on any frequency or frequencies within the band 150 kHz to 30 MHz shall not exceed the limits in the following table.

Frequency of Emission (MHz)	Conducted Limit (dB $\mu$ V)	
	Quasi-Peak	Average
0.15-0.5	66 to 56*	56 to 46*
0.5-5	56	46
5-30	60	50

\*Decreases with the logarithm of the frequency.

#### 3.6.2 Measuring Instruments

The measuring equipment is listed in the section 4 of this test report.

#### 3.6.3 Test Procedures

1. The EUT was placed 0.4 meter from the conducting wall of the shielding room, and it was kept at least 80 centimeters from any other grounded conducting surface.
2. Connect EUT to the power mains through a line impedance stabilization network (LISN).
3. All the support units are connecting to the other LISN.
4. The LISN provides 50 ohm coupling impedance for the measuring instrument.
5. The FCC states that a 50 ohm, 50 microhenry LISN should be used.
6. Both sides of AC line were checked for maximum conducted interference.
7. The frequency range from 150 kHz to 30 MHz was searched.
8. Set the test-receiver system to Peak Detect Function and specified bandwidth (IF bandwidth = 9kHz) with Maximum Hold Mode.

### 3.6.4 Test Setup

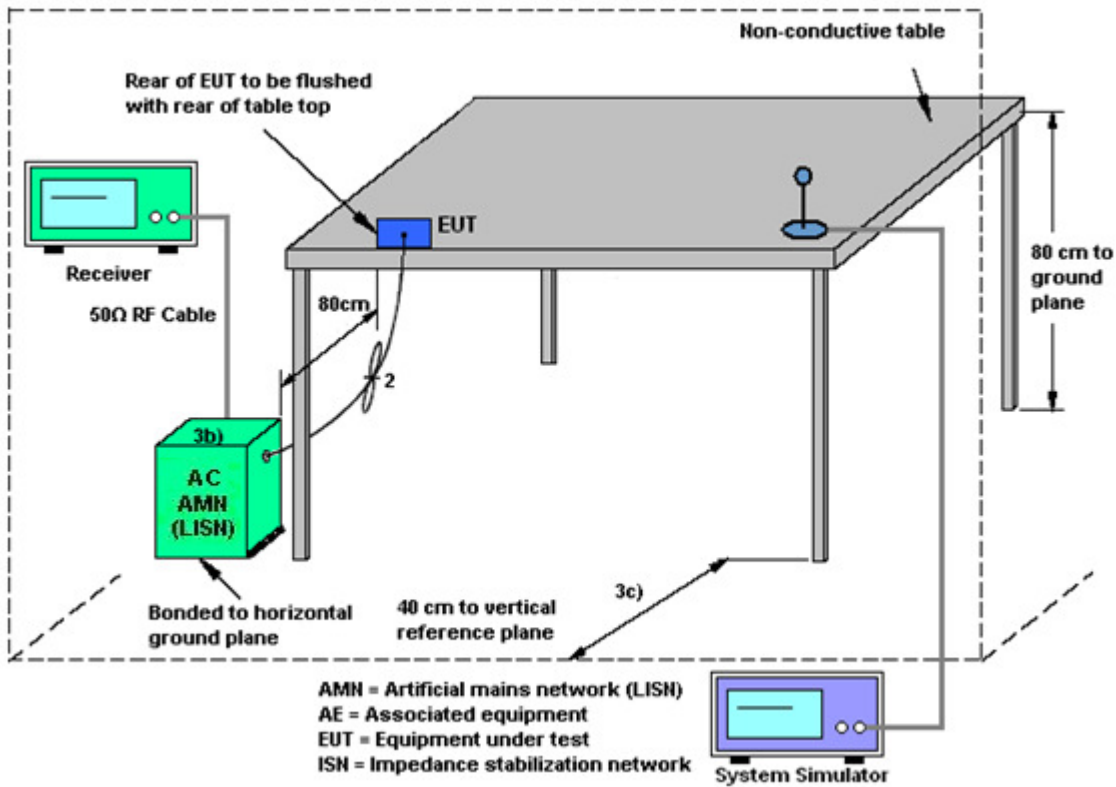

### 3.6.5 Test Result of AC Conducted Emission

Please refer to Appendix B.





## **3.7 Antenna Requirements**

### **3.7.1 Standard Applicable**

If directional gain of transmitting Antennas is greater than 6dBi, the power shall be reduced by the same level in dB comparing to gain minus 6dBi. The use of a permanently attached Antenna or of an Antenna that uses a unique coupling to the intentional radiator shall be considered sufficient to comply with the rule.

### **3.7.2 Antenna Anti-Replacement Construction**

An embedded-in antenna design is used.

### **3.7.3 Antenna Gain**

The antenna peak gain of EUT is less than 6 dBi. Therefore, it is not necessary to reduce maximum peak output power limit.



## 4 List of Measuring Equipment

Instrument	Manufacturer	Model No.	Serial No.	Characteristics	Calibration Date	Test Date	Due Date	Remark
Power Meter	Anritsu	ML2495A	0932001	N/A	Sep. 26, 2017	Dec. 21, 2017~ Jan. 18, 2018	Sep. 25, 2018	Conducted (TH05-HY)
Power Sensor	Anritsu	MA2411B	0846202	300MHz~40GHz	Sep. 26, 2017	Dec. 21, 2017~ Jan. 18, 2018	Sep. 25, 2018	Conducted (TH05-HY)
Spectrum Analyzer	Rohde & Schwarz	FSP30	101067	9kHz ~ 30GHz	Nov. 13, 2017	Dec. 21, 2017~ Jan. 18, 2018	Nov. 12, 2018	Conducted (TH05-HY)
AC Power Source	ChainTek	APC-1000W	N/A	N/A	N/A	Dec. 29, 2017	N/A	Conduction (CO05-HY)
EMI Test Receiver	Rohde & Schwarz	ESCI 7	100724	9kHz~7GHz	Sep. 20, 2017	Dec. 29, 2017	Sep. 19, 2018	Conduction (CO05-HY)
LISN	Rohde & Schwarz	ENV216	100080	9kHz~30MHz	Nov. 30, 2017	Dec. 29, 2017	Nov. 29, 2018	Conduction (CO05-HY)
Loop Antenna	Rohde & Schwarz	HFH2-Z2	100315	9 kHz~30 MHz	May 15, 2017	Dec. 25, 2017~ Jan. 16, 2018	May 14, 2019	Radiation (03CH13-HY)
Amplifier	MITEQ	TTA1840-35-HG	1871923	18GHz~40GHz, VSWR : 2.5:1 max	Jul. 18, 2017	Dec. 25, 2017~ Jan. 16, 2018	Jul. 17, 2018	Radiation (03CH13-HY)
Amplifier	Sonoma-Instrument	310 N	187282	9KHz~1GHz	Dec. 21, 2016	Dec. 25, 2017~ Jan. 16, 2018	Dec. 20, 2018	Radiation (03CH13-HY)
Bilog Antenna	TESEQ	CBL 6111D&N-6-06	35414&AT- N0602	30MHz~1GHz	Oct. 14, 2017	Dec. 25, 2017~ Jan. 16, 2018	Oct. 13, 2018	Radiation (03CH13-HY)
Horn Antenna	SCHWARZBECK	BBHA 9120 D	9120D-124 1	1GHz ~ 18GHz	Jun. 15, 2017	Dec. 25, 2017~ Jan. 16, 2018	Jun. 14, 2018	Radiation (03CH13-HY)
Preamplifier	MITEQ	AMF-7D-001 01800-30-10 P	1590074	1GHz~18GHz	May 22, 2017	Dec. 25, 2017~ Jan. 16, 2018	May 21, 2018	Radiation (03CH13-HY)
Preamplifier	Keysight	83017A	MY532702 64	1GHz ~ 26.5GHz	Dec. 05, 2017	Dec. 25, 2017~ Jan. 16, 2018	Dec. 04, 2018	Radiation (03CH13-HY)
Spectrum Analyzer	Keysight	N9010A	MY553705 26	N/A	Mar. 15, 2017	Dec. 25, 2017~ Jan. 16, 2018	Mar. 14, 2018	Radiation (03CH13-HY)
Controller	EMEC	EM1000	N/A	Control Turn table & Ant Mast	N/A	Dec. 25, 2017~ Jan. 16, 2018	N/A	Radiation (03CH13-HY)
Antenna Mast	EMEC	AM-BS-4500 -B	N/A	1m~4m	N/A	Dec. 25, 2017~ Jan. 16, 2018	N/A	Radiation (03CH13-HY)
Turn Table	EMEC	TT2000	N/A	0~360 Degree	N/A	Dec. 25, 2017~ Jan. 16, 2018	N/A	Radiation (03CH13-HY)
SHF-EHF Horn Antenna	SCHWARZBECK	BBHA 9170	BBHA9170 576	18GHz ~ 40GHz	Apr. 27, 2017	Dec. 25, 2017~ Jan. 16, 2018	Apr. 26, 2018	Radiation (03CH13-HY)
EMI Test Receiver	Keysight	N9038A(MX E)	MY554201 70	3Hz ~ 8.4GHz	Mar. 03, 2017	Dec. 25, 2017~ Jan. 16, 2018	Mar. 02, 2018	Radiation (03CH13-HY)



## 5 Uncertainty of Evaluation

### Uncertainty of Conducted Emission Measurement (150kHz ~ 30MHz)

Measuring Uncertainty for a Level of Confidence of 95% ( $U = 2Uc(y)$ )	2.70
---	------

### Uncertainty of Radiated Emission Measurement (30 MHz ~ 1000 MHz)

Measuring Uncertainty for a Level of Confidence of 95% ( $U = 2Uc(y)$ )	4.90
---	------

### Uncertainty of Radiated Emission Measurement (1000 MHz ~ 18000 MHz)

Measuring Uncertainty for a Level of Confidence of 95% ( $U = 2Uc(y)$ )	5.40
---	------

### Uncertainty of Radiated Emission Measurement (18000 MHz ~ 40000 MHz)

Measuring Uncertainty for a Level of Confidence of 95% ( $U = 2Uc(y)$ )	4.30
---	------

**Appendix A. Test Result of Conducted Test Items**

Test Engineer:	Derek Hsu/Reece Lin/Luffy Lin	Temperature:	21~25	°C
Test Date:	2017/12/21~2018/1/18	Relative Humidity:	51~54	%

**TEST RESULTS DATA**  
**6dB and 99% Occupied Bandwidth**

2.4GHz Band								
Mod.	Data Rate	N <sub>TX</sub>	CH.	Freq. (MHz)	99% Occupied BW (MHz)	6dB BW (MHz)	6dB BW Limit (MHz)	Pass/Fail
11b	1Mbps	1	1	2412	13.75	8.52	0.50	Pass
11b	1Mbps	1	6	2437	13.85	9.00	0.50	Pass
11b	1Mbps	1	11	2462	13.70	8.04	0.50	Pass
11g	6Mbps	1	1	2412	18.10	16.36	0.50	Pass
11g	6Mbps	1	6	2437	18.25	16.36	0.50	Pass
11g	6Mbps	1	11	2462	18.10	16.34	0.50	Pass
HT20	MCS0	1	1	2412	18.75	17.56	0.50	Pass
HT20	MCS0	1	6	2437	19.10	17.60	0.50	Pass
HT20	MCS0	1	11	2462	18.85	17.56	0.50	Pass

**TEST RESULTS DATA**  
**Peak Power Table**

2.4GHz Band										
Mod.	Data Rate	N <sub>TX</sub>	CH.	Freq. (MHz)	Peak Conducted Power (dBm)	Conducted Power Limit (dBm)	DG (dBi)	EIRP Power (dBm)	EIRP Power Limit (dBm)	Pass /Fail
11b	1Mbps	1	1	2412	21.17	30.00	-3.20	17.97	36.00	Pass
11b	1Mbps	1	6	2437	21.09	30.00	-3.20	17.89	36.00	Pass
11b	1Mbps	1	11	2462	20.80	30.00	-3.20	17.60	36.00	Pass
11g	6Mbps	1	1	2412	20.11	30.00	-3.20	16.91	36.00	Pass
11g	6Mbps	1	6	2437	20.54	30.00	-3.20	17.34	36.00	Pass
11g	6Mbps	1	11	2462	20.52	30.00	-3.20	17.32	36.00	Pass
HT20	MCS0	1	1	2412	18.60	30.00	-3.20	15.40	36.00	Pass
HT20	MCS0	1	6	2437	18.58	30.00	-3.20	15.38	36.00	Pass
HT20	MCS0	1	11	2462	18.45	30.00	-3.20	15.25	36.00	Pass

**TEST RESULTS DATA**  
**Average Power Table**  
***(Reporting Only)***

2.4GHz Band						
Mod.	Data Rate	N <sub>TX</sub>	CH.	Freq. (MHz)	Duty Factor (dB)	Average Conducted Power (dBm)
11b	1Mbps	1	1	2412	0.10	18.49
11b	1Mbps	1	6	2437	0.10	18.46
11b	1Mbps	1	11	2462	0.10	18.28
11g	6Mbps	1	1	2412	0.59	10.62
11g	6Mbps	1	6	2437	0.59	10.98
11g	6Mbps	1	11	2462	0.59	10.97
HT20	MCS0	1	1	2412	0.66	8.91
HT20	MCS0	1	6	2437	0.66	8.67
HT20	MCS0	1	11	2462	0.66	8.52

**TEST RESULTS DATA**  
**Peak Power Density**

2.4GHz Band								
Mod.	Data Rate	N <sub>TX</sub>	CH.	Freq. (MHz)	Peak PSD (dBm /3kHz)	DG (dBi)	Peak PSD Limit (dBm /3kHz)	Pass/Fail
11b	1Mbps	1	1	2412	-3.80	-3.20	8.00	Pass
11b	1Mbps	1	6	2437	-4.08	-3.20	8.00	Pass
11b	1Mbps	1	11	2462	-2.65	-3.20	8.00	Pass
11g	6Mbps	1	1	2412	-15.82	-3.20	8.00	Pass
11g	6Mbps	1	6	2437	-15.41	-3.20	8.00	Pass
11g	6Mbps	1	11	2462	-13.54	-3.20	8.00	Pass
HT20	MCS0	1	1	2412	-18.06	-3.20	8.00	Pass
HT20	MCS0	1	6	2437	-17.98	-3.20	8.00	Pass
HT20	MCS0	1	11	2462	-17.86	-3.20	8.00	Pass





## Appendix B. AC Conducted Emission Test Results

Test Engineer :	Blue Lan	Temperature :	24~26°C
		Relative Humidity :	63~65%

# EUT Information

Report NO : 7D2018  
 Test Mode : Mode 1  
 Test Voltage : 120Vac/60Hz  
 Phase : Line

ENV216 Auto Test FCC Power Bar - L

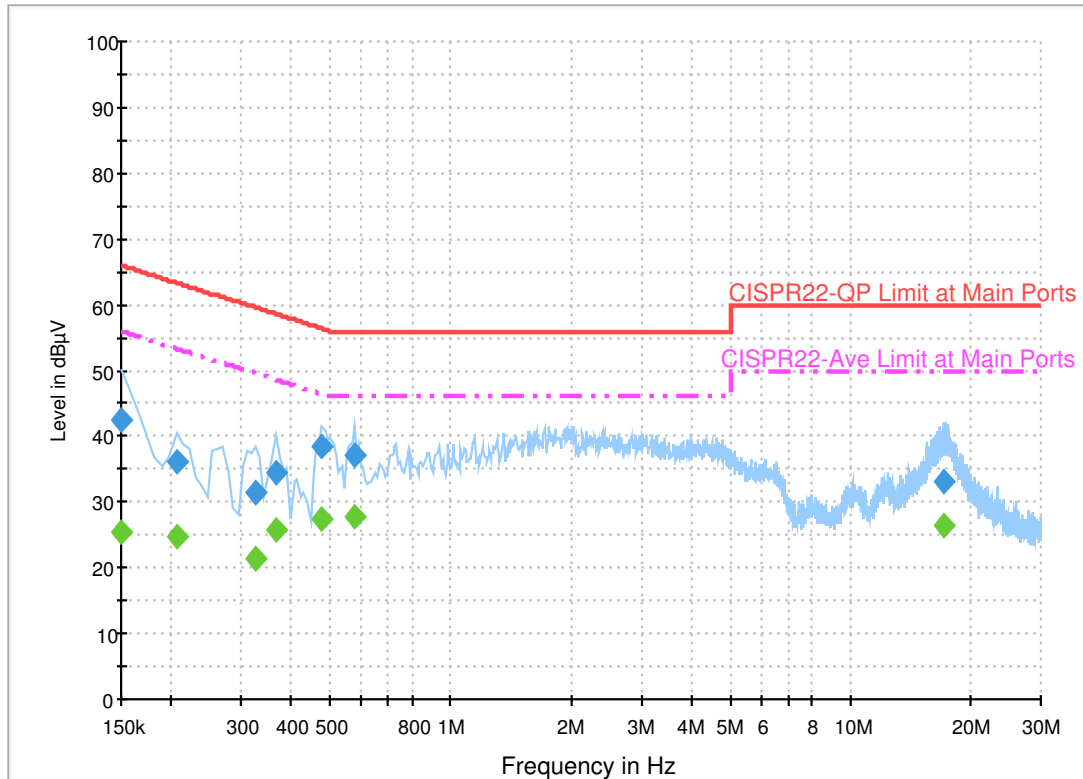

## Final Result 1

Frequency (MHz)	QuasiPeak (dBµV)	Filter	Line	Corr. (dB)	Margin (dB)	Limit (dBµV)
0.150000	42.6	Off	L1	19.5	23.4	66.0
0.206000	36.1	Off	L1	19.5	27.3	63.4
0.326000	31.5	Off	L1	19.5	28.1	59.6
0.366000	34.4	Off	L1	19.5	24.2	58.6
0.478000	38.3	Off	L1	19.5	18.1	56.4
0.574000	37.0	Off	L1	19.5	19.0	56.0
17.086000	33.2	Off	L1	19.7	26.8	60.0

## Final Result 2

Frequency (MHz)	Average (dBµV)	Filter	Line	Corr. (dB)	Margin (dB)	Limit (dBµV)
0.150000	25.5	Off	L1	19.5	30.5	56.0
0.206000	24.8	Off	L1	19.5	28.6	53.4
0.326000	21.6	Off	L1	19.5	28.0	49.6
0.366000	25.7	Off	L1	19.5	22.9	48.6
0.478000	27.6	Off	L1	19.5	18.8	46.4
0.574000	27.7	Off	L1	19.5	18.3	46.0
17.086000	26.6	Off	L1	19.7	23.4	50.0

# EUT Information

Report NO : 7D2018  
 Test Mode : Mode 1  
 Test Voltage : 120Vac/60Hz  
 Phase : Neutral

ENV216 Auto Test FCC Power Bar - N

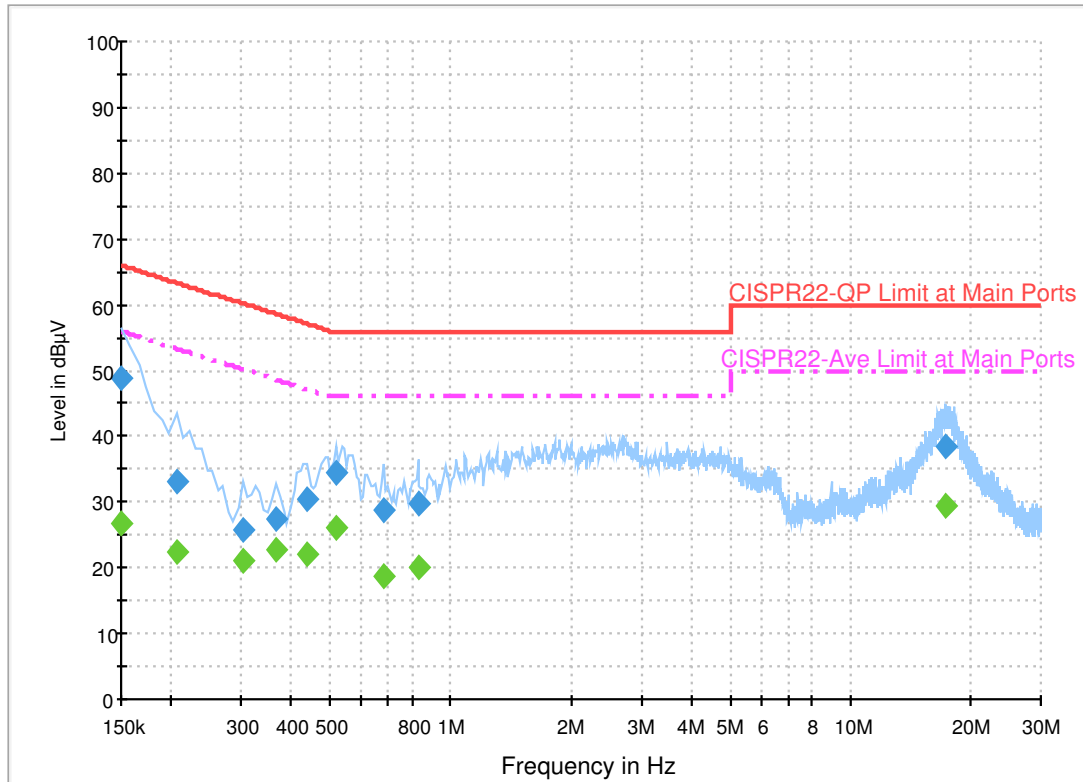

## Final Result 1

Frequency (MHz)	QuasiPeak (dBµV)	Filter	Line	Corr. (dB)	Margin (dB)	Limit (dBµV)
0.150000	49.0	Off	N	19.5	17.0	66.0
0.206000	33.0	Off	N	19.5	30.4	63.4
0.302000	25.6	Off	N	19.5	34.6	60.2
0.366000	27.5	Off	N	19.5	31.1	58.6
0.438000	30.5	Off	N	19.5	26.6	57.1
0.518000	34.4	Off	N	19.5	21.6	56.0
0.678000	28.8	Off	N	19.5	27.2	56.0
0.830000	29.9	Off	N	19.5	26.1	56.0
17.302000	38.3	Off	N	19.8	21.7	60.0

## Final Result 2

Frequency (MHz)	Average (dBµV)	Filter	Line	Corr. (dB)	Margin (dB)	Limit (dBµV)
0.150000	26.7	Off	N	19.5	29.3	56.0
0.206000	22.6	Off	N	19.5	30.8	53.4
0.302000	20.9	Off	N	19.5	29.3	50.2
0.366000	22.6	Off	N	19.5	26.0	48.6
0.438000	22.2	Off	N	19.5	24.9	47.1
0.518000	26.0	Off	N	19.5	20.0	46.0
0.678000	18.7	Off	N	19.5	27.3	46.0
0.830000	20.1	Off	N	19.5	25.9	46.0
17.302000	29.5	Off	N	19.8	20.5	50.0



## Appendix C. Radiated Spurious Emission

Test Engineer :	Alex Jheng, Bill Chang, and Wilson Wu	Temperature :	24.9~25.3°C
		Relative Humidity :	46~50%



2.4GHz 2400~2483.5MHz

WIFI 802.11b (Band Edge @ 3m)

WIFI	Note	Frequency	Level	Over	Limit	Read	Antenna	Cable	Preamp	Ant	Table	Peak	Pol.	
Ant.				Limit	Line	Level	Factor	Loss	Factor	Pos	Pos	Avg.		
1		( MHz )	( dBμV/m )	( dB )	( dBμV/m )	( dBμV )	( dB/m )	( dB )	( dB )	( cm )	( deg )	(P/A)	(H/V)	
802.11b CH 01 2412MHz		2355.465	52.28	-21.72	74	40.78	26.79	4.78	30	397	89	P	H	
		2390	42.45	-11.55	54	30.79	26.89	4.83	29.99	397	89	A	H	
	*	2412	105.78	-	-	94.03	26.94	4.87	29.99	397	89	P	H	
	*	2412	102.64	-	-	90.89	26.94	4.87	29.99	397	89	A	H	
													H	
													H	
			2374.155	52.32	-21.68	74	40.74	26.84	4.8	29.99	400	40	P	V
			2389.17	42.13	-11.87	54	30.47	26.89	4.83	29.99	400	40	A	V
	*		2412	104.07	-	-	92.32	26.94	4.87	29.99	400	40	P	V
	*		2412	100.88	-	-	89.13	26.94	4.87	29.99	400	40	A	V
													V	
													V	
802.11b CH 06 2437MHz		2384.34	52.35	-21.65	74	40.74	26.84	4.83	29.99	121	143	P	H	
		2383.92	42.48	-11.52	54	30.87	26.84	4.83	29.99	121	143	A	H	
	*	2437	106.32	-	-	94.45	27.04	4.88	29.98	121	143	P	H	
	*	2437	103.08	-	-	91.21	27.04	4.88	29.98	121	143	A	H	
			2491.95	53.5	-20.5	74	41.4	27.2	4.93	29.96	121	143	P	H
			2485.44	42.66	-11.34	54	30.62	27.15	4.93	29.97	121	143	A	H
			2379.58	52.52	-21.48	74	40.91	26.84	4.83	29.99	396	58	P	V
			2389.66	42.05	-11.95	54	30.39	26.89	4.83	29.99	396	58	A	V
	*		2437	106.63	-	-	94.76	27.04	4.88	29.98	396	58	P	V
	*		2437	103.42	-	-	91.55	27.04	4.88	29.98	396	58	A	V
			2491.74	53.47	-20.53	74	41.38	27.2	4.93	29.97	396	58	P	V
			2483.55	42.57	-11.43	54	30.53	27.15	4.93	29.97	396	58	A	V



<b>802.11b</b> <b>CH 11</b> <b>2462MHz</b>	*	2462	105.11	-	-	93.15	27.1	4.9	29.97	175	82	P	H
	*	2462	102.03	-	-	90.07	27.1	4.9	29.97	175	82	A	H
		2486.04	53.23	-20.77	74	41.19	27.15	4.93	29.97	175	82	P	H
		2487.56	44.3	-9.7	54	32.21	27.2	4.93	29.97	175	82	A	H
													H
													H
	*	2462	104.19	-	-	92.23	27.1	4.9	29.97	388	38	P	V
	*	2462	100.97	-	-	89.01	27.1	4.9	29.97	388	38	A	V
		2495.28	53.11	-20.89	74	41.01	27.2	4.93	29.96	388	38	P	V
		2487.52	43.15	-10.85	54	31.06	27.2	4.93	29.97	388	38	A	V
													V
													V
<b>Remark</b>	1. No other spurious found. 2. All results are PASS against Peak and Average limit line.												



**2.4GHz 2400~2483.5MHz  
WIFI 802.11b (Harmonic @ 3m)**

WIFI Ant. 1	Note	Frequency ( MHz )	Level ( dBμV/m )	Over Limit ( dB )	Limit Line ( dBμV/m )	Read Level ( dBμV )	Antenna Factor ( dB/m )	Cable Loss ( dB )	Preamp Factor ( dB )	Ant Pos ( cm )	Table Pos ( deg )	Peak Avg. (P/A)	Pol. (H/V)	
802.11b CH 01 2412MHz		4824	45.49	-28.51	74	63.33	31.56	7.33	57.24	100	0	P	H	
													H	
													H	
													H	
			4824	45.58	-28.42	74	63.42	31.56	7.33	57.24	100	0	P	V
														V
														V
802.11b CH 06 2437MHz		4874	41.86	-32.14	74	59.46	31.63	7.44	57.17	100	0	P	H	
		7311	43.89	-30.11	74	55.41	36.16	9.13	57.27	100	0	P	H	
													H	
													H	
			4874	41.71	-32.29	74	59.31	31.63	7.44	57.17	100	0	P	V
			7311	43.41	-30.59	74	54.93	36.16	9.13	57.27	100	0	P	V
														V
802.11b CH 11 2462MHz		4924	42.14	-31.86	74	59.52	31.7	7.52	57.1	100	0	P	H	
		7386	44.12	-29.88	74	55.57	36.31	9.18	57.38	100	0	P	H	
													H	
													H	
			4924	42.16	-31.84	74	59.54	31.7	7.52	57.1	100	0	P	V
			7386	44.12	-29.88	74	55.57	36.31	9.18	57.38	100	0	P	V
														V
Remark	1. No other spurious found.													
	2. All results are PASS against Peak and Average limit line.													



**2.4GHz 2400~2483.5MHz**  
**WIFI 802.11g (Band Edge @ 3m)**

WIFI Ant. 1	Note	Frequency ( MHz )	Level ( dBμV/m )	Over Limit ( dB )	Limit Line ( dBμV/m )	Read Level ( dBμV )	Antenna Factor ( dB/m )	Cable Loss ( dB )	Preamp Factor ( dB )	Ant Pos ( cm )	Table Pos ( deg )	Peak Avg. ( P/A )	Pol. ( H/V )	
802.11g CH 01 2412MHz		2369.22	53.89	-20.11	74	42.31	26.84	4.8	29.99	125	123	P	H	
		2387.7	42.58	-11.42	54	30.92	26.89	4.83	29.99	125	123	A	H	
	*	2412	99.12	-	-	87.37	26.94	4.87	29.99	125	123	P	H	
	*	2412	91.32	-	-	79.57	26.94	4.87	29.99	125	123	A	H	
													H	
														H
			2376.045	52.72	-21.28	74	41.11	26.84	4.83	29.99	400	58	P	V
			2389.59	42.76	-11.24	54	31.1	26.89	4.83	29.99	400	58	A	V
	*		2412	98.74	-	-	86.99	26.94	4.87	29.99	400	58	P	V
	*		2412	90.7	-	-	78.95	26.94	4.87	29.99	400	58	A	V
														V
														V
802.11g CH 06 2437MHz		2384.76	52.88	-21.12	74	41.27	26.84	4.83	29.99	117	120	P	H	
		2384.76	42.99	-11.01	54	31.38	26.84	4.83	29.99	117	120	A	H	
	*	2437	101.9	-	-	90.03	27.04	4.88	29.98	117	120	P	H	
	*	2437	93.71	-	-	81.84	27.04	4.88	29.98	117	120	A	H	
			2487.26	54.16	-19.84	74	42.12	27.15	4.93	29.97	117	120	P	H
			2488.87	44.2	-9.8	54	32.11	27.2	4.93	29.97	117	120	A	H
			2344.44	53.47	-20.53	74	42.03	26.73	4.78	30	385	63	P	V
			2381.96	42.57	-11.43	54	30.96	26.84	4.83	29.99	385	63	A	V
	*		2437	100.59	-	-	88.72	27.04	4.88	29.98	385	63	P	V
	*		2437	92.61	-	-	80.74	27.04	4.88	29.98	385	63	A	V
			2492.58	53.78	-20.22	74	41.68	27.2	4.93	29.96	385	63	P	V
			2488.8	43.64	-10.36	54	31.55	27.2	4.93	29.97	385	63	A	V





<b>802.11g CH 11 2462MHz</b>	*	2462	105.39	-	-	93.43	27.1	4.9	29.97	116	146	P	H
	*	2462	96.82	-	-	84.86	27.1	4.9	29.97	116	146	A	H
		2483.52	64.02	-9.98	74	51.98	27.15	4.93	29.97	116	146	P	H
		2483.52	48.51	-5.49	54	36.47	27.15	4.93	29.97	116	146	A	H
													H
													H
	*	2462	100.06	-	-	88.1	27.1	4.9	29.97	378	60	P	V
	*	2462	91.41	-	-	79.45	27.1	4.9	29.97	378	60	A	V
		2483.64	59.16	-14.84	74	47.12	27.15	4.93	29.97	378	60	P	V
		2483.52	45.8	-8.2	54	33.76	27.15	4.93	29.97	378	60	A	V
													V
													V
<b>Remark</b>	1. No other spurious found. 2. All results are PASS against Peak and Average limit line.												



**2.4GHz 2400~2483.5MHz  
WIFI 802.11g (Harmonic @ 3m)**

WIFI Ant. 1	Note	Frequency ( MHz )	Level ( dBμV/m )	Over Limit ( dB )	Limit Line ( dBμV/m )	Read Level ( dBμV )	Antenna Factor ( dB/m )	Cable Loss ( dB )	Preamp Factor ( dB )	Ant Pos ( cm )	Table Pos ( deg )	Peak Avg. ( P/A )	Pol. ( H/V )
802.11g CH 01 2412MHz		4824	40.07	-33.93	74	57.91	31.56	7.33	57.24	100	0	P	H
													H
													H
													H
		4824	39.29	-34.71	74	57.13	31.56	7.33	57.24	100	0	P	V
													V
													V
802.11g CH 06 2437MHz		4874	39.35	-34.65	74	56.95	31.63	7.44	57.17	100	0	P	H
		7311	43.33	-30.67	74	54.85	36.16	9.13	57.27	100	0	P	H
													H
													H
		4874	38.78	-35.22	74	56.38	31.63	7.44	57.17	100	0	P	V
		7311	43.47	-30.53	74	54.99	36.16	9.13	57.27	100	0	P	V
													V
802.11g CH 11 2462MHz		4924	38.81	-35.19	74	56.19	31.7	7.52	57.1	100	0	P	H
		7386	44.28	-29.72	74	55.73	36.31	9.18	57.38	100	0	P	H
													H
													H
		4924	38.7	-35.3	74	56.08	31.7	7.52	57.1	100	0	P	V
		7386	45	-29	74	56.45	36.31	9.18	57.38	100	0	P	V
													V
Remark	1. No other spurious found.												
	2. All results are PASS against Peak and Average limit line.												



**2.4GHz 2400~2483.5MHz  
WIFI 802.11n HT20 (Band Edge @ 3m)**

WIFI Ant. 1	Note	Frequency ( MHz )	Level ( dBμV/m )	Over Limit ( dB )	Limit Line ( dBμV/m )	Read Level ( dBμV )	Antenna Factor ( dB/m )	Cable Loss ( dB )	Preamp Factor ( dB )	Ant Pos ( cm )	Table Pos ( deg )	Peak Avg. ( P/A )	Pol. ( H/V )	
802.11n HT20 CH 01 2412MHz		2331.105	52.61	-21.39	74	41.25	26.68	4.76	30.01	131	99	P	H	
		2383.08	42.68	-11.32	54	31.07	26.84	4.83	29.99	131	99	A	H	
	*	2412	98.46	-	-	86.71	26.94	4.87	29.99	131	99	P	H	
	*	2412	90.81	-	-	79.06	26.94	4.87	29.99	131	99	A	H	
													H	
														H
			2373.735	53.43	-20.57	74	41.85	26.84	4.8	29.99	399	63	P	V
			2388.96	42.58	-11.42	54	30.92	26.89	4.83	29.99	399	63	A	V
		*	2412	96.35	-	-	84.6	26.94	4.87	29.99	399	63	P	V
		*	2412	87.78	-	-	76.03	26.94	4.87	29.99	399	63	A	V
													V	
													V	
802.11n HT20 CH 06 2437MHz		2355.08	53.1	-20.9	74	41.6	26.79	4.78	30	143	138	P	H	
		2385.6	42.74	-11.26	54	31.08	26.89	4.83	29.99	143	138	A	H	
	*	2437	98.88	-	-	87.01	27.04	4.88	29.98	143	138	P	H	
	*	2437	91.01	-	-	79.14	27.04	4.88	29.98	143	138	A	H	
			2487.68	54.92	-19.08	74	42.83	27.2	4.93	29.97	143	138	P	H
			2488.45	43.79	-10.21	54	31.7	27.2	4.93	29.97	143	138	A	H
			2379.02	53.52	-20.48	74	41.91	26.84	4.83	29.99	394	45	P	V
			2385.04	42.59	-11.41	54	30.98	26.84	4.83	29.99	394	45	A	V
		*	2437	96.44	-	-	84.57	27.04	4.88	29.98	394	45	P	V
		*	2437	88.5	-	-	76.63	27.04	4.88	29.98	394	45	A	V
		2491.74	52.92	-21.08	74	40.83	27.2	4.93	29.97	394	45	P	V	
		2488.45	43.37	-10.63	54	31.28	27.2	4.93	29.97	394	45	A	V	



<b>802.11n</b> <b>HT20</b> <b>CH 11</b> <b>2462MHz</b>	*	2462	100.07	-	-	88.11	27.1	4.9	29.97	136	143	P	H
	*	2462	90.92	-	-	78.96	27.1	4.9	29.97	136	143	A	H
		2484.96	55.66	-18.34	74	43.62	27.15	4.93	29.97	136	143	P	H
		2483.52	44.4	-9.6	54	32.36	27.15	4.93	29.97	136	143	A	H
													H
													H
	*	2462	98.46	-	-	86.5	27.1	4.9	29.97	379	63	P	V
	*	2462	89.81	-	-	77.85	27.1	4.9	29.97	379	63	A	V
		2484	55.85	-18.15	74	43.81	27.15	4.93	29.97	379	63	P	V
		2483.56	44.77	-9.23	54	32.73	27.15	4.93	29.97	379	63	A	V
													V
												V	
<b>Remark</b>	1. No other spurious found. 2. All results are PASS against Peak and Average limit line.												



**2.4GHz 2400~2483.5MHz  
WIFI 802.11n HT20 (Harmonic @ 3m)**

WIFI Ant. 1	Note	Frequency ( MHz )	Level ( dBμV/m )	Over Limit ( dB )	Limit Line ( dBμV/m )	Read Level ( dBμV )	Antenna Factor ( dB/m )	Cable Loss ( dB )	Preamp Factor ( dB )	Ant Pos ( cm )	Table Pos ( deg )	Peak Avg. ( P/A )	Pol. ( H/V )	
802.11n HT20 CH 01 2412MHz		4824	41.82	-32.18	74	59.66	31.56	7.33	57.24	100	0	P	H	
													H	
													H	
													H	
			4824	39.41	-34.59	74	57.25	31.56	7.33	57.24	100	0	P	V
														V
														V
802.11n HT20 CH 06 2437MHz		4874	38.7	-35.3	74	56.3	31.63	7.44	57.17	100	0	P	H	
		7311	43.85	-30.15	74	55.37	36.16	9.13	57.27	100	0	P	H	
													H	
													H	
			4874	38.96	-35.04	74	56.56	31.63	7.44	57.17	100	0	P	V
			7311	43.61	-30.39	74	55.13	36.16	9.13	57.27	100	0	P	V
														V
802.11n HT20 CH 11 2462MHz		4924	39.4	-34.6	74	56.78	31.7	7.52	57.1	100	0	P	H	
		7386	45.29	-28.71	74	56.74	36.31	9.18	57.38	100	0	P	H	
													H	
													H	
			4924	39.76	-34.24	74	57.14	31.7	7.52	57.1	100	0	P	V
			7386	43.81	-30.19	74	55.26	36.31	9.18	57.38	100	0	P	V
														V
Remark	1. No other spurious found.													
	2. All results are PASS against Peak and Average limit line.													



Emission below 1GHz  
2.4GHz WIFI 802.11g (LF)

WIFI	Note	Frequency	Level	Over	Limit	Read	Antenna	Cable	Preamp	Ant	Table	Peak	Pol.	
Ant.				Limit	Line	Level	Factor	Loss	Factor	Pos	Pos	Avg.		
1		( MHz )	( dBμV/m )	( dB )	( dBμV/m )	( dBμV )	( dB/m )	( dB )	( dB )	( cm )	( deg )	(P/A)	(H/V)	
2.4GHz 802.11g LF		30.81	23.66	-16.34	40	30.17	25.26	0.59	32.34			P	H	
		96.96	24.79	-18.71	43.5	40.31	15.64	1	32.29			P	H	
		143.94	24.69	-18.81	43.5	38.05	17.69	1.19	32.28			P	H	
		638.8	27.43	-18.57	46	31.16	25.87	2.48	32.19			P	H	
		801.2	30.13	-15.87	46	31.4	27.82	2.78	31.99			P	H	
		949.6	32.3	-13.7	46	29.86	30.3	3.06	31.06	100	0	P	H	
													H	
													H	
													H	
													H	
													H	
													H	
			33.78	31.37	-8.63	40	39.5	23.64	0.59	32.34	100	0	P	V
			42.96	28.78	-11.22	40	41.74	18.62	0.74	32.33			P	V
			62.94	28.15	-11.85	40	47.69	11.95	0.84	32.31			P	V
			717.2	28.71	-17.29	46	31.31	26.8	2.64	32.14			P	V
			839.7	30.91	-15.09	46	31.3	28.44	2.84	31.8			P	V
			965.7	32.79	-21.21	54	30.39	30.1	3.07	30.91			P	V
														V
														V
													V	
													V	
													V	
													V	
<b>Remark</b>	1. No other spurious found. 2. All results are PASS against limit line.													



**Note symbol**

*	<b>Fundamental Frequency</b> which can be ignored. However, the level of any unwanted emissions shall not exceed the level of the fundamental frequency.
!	Test result is <b>over limit</b> line.
P/A	<b>Peak</b> or <b>Average</b>
H/V	<b>Horizontal</b> or <b>Vertical</b>



A calculation example for radiated spurious emission is shown as below:

WIFI	Note	Frequency	Level	Over	Limit	Read	Antenna	Cable	Preamp	Ant	Table	Peak	Pol.
Ant.				Limit	Line	Level	Factor	Loss	Factor	Pos	Pos	Avg.	
1		( MHz )	( dBμV/m )	( dB )	( dBμV/m )	( dBμV )	( dB/m )	( dB )	( dB )	( cm )	( deg )	( P/A )	( H/V )
802.11b		2390	55.45	-18.55	74	54.51	32.22	4.58	35.86	103	308	P	H
CH 01													
2412MHz		2390	43.54	-10.46	54	42.6	32.22	4.58	35.86	103	308	A	H

- Level(dBμV/m) =  
Antenna Factor(dB/m) + Cable Loss(dB) + Read Level(dBμV) - Preamp Factor(dB)
- Over Limit(dB) = Level(dBμV/m) – Limit Line(dBμV/m)

**For Peak Limit @ 2390MHz:**

- Level(dBμV/m)  
= Antenna Factor(dB/m) + Cable Loss(dB) + Read Level(dBμV) - Preamp Factor(dB)  
= 32.22(dB/m) + 4.58(dB) + 54.51(dBμV) – 35.86 (dB)  
= 55.45 (dBμV/m)
- Over Limit(dB)  
= Level(dBμV/m) – Limit Line(dBμV/m)  
= 55.45(dBμV/m) – 74(dBμV/m)  
= -18.55(dB)

**For Average Limit @ 2390MHz:**

- Level(dBμV/m)  
= Antenna Factor(dB/m) + Cable Loss(dB) + Read Level(dBμV) - Preamp Factor(dB)  
= 32.22(dB/m) + 4.58(dB) + 42.6(dBμV) – 35.86 (dB)  
= 43.54 (dBμV/m)
- Over Limit(dB)  
= Level(dBμV/m) – Limit Line(dBμV/m)  
= 43.54(dBμV/m) – 54(dBμV/m)  
= -10.46(dB)

Both peak and average measured complies with the limit line, so test result is “PASS”.





## Appendix D. Radiated Spurious Emission Plots

Test Engineer :	Alex Jheng, Bill Chang, and Wilson Wu	Temperature :	24.9~25.3°C
		Relative Humidity :	46~50%

### Note symbol

-L	Low channel location
-R	High channel location

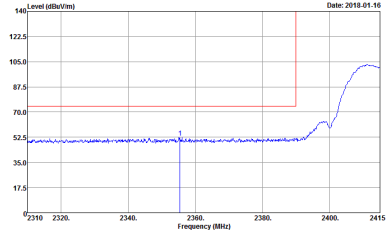
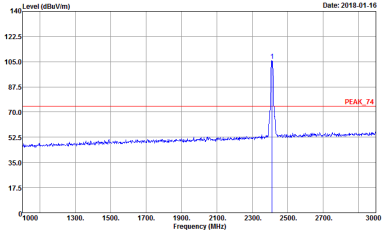
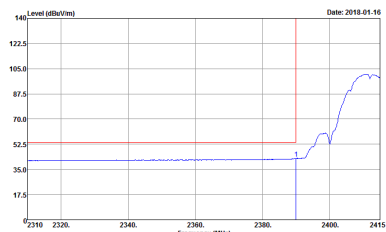
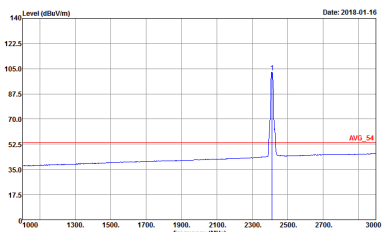

2.4GHz 2400~2483.5MHz  
WIFI 802.11b (Band Edge @ 3m)

WIFI	2.4GHz 2400~2483.5MHz Band Edge @ 3m	
ANT	802.11b CH01 2412MHz	
1	Horizontal	Fundamental
Peak	 <p>Site : 03CH13-HY Condition : PEAK_BE_74 3m HORN_91200_1241 HORIZONTAL Detector : Peak Project : 7D2018 Mode : 9</p>	 <p>Site : 03CH13-HY Condition : PEAK_74 3m HORN_91200_1241 HORIZONTAL Detector : Peak Project : 7D2018 Mode : 9</p>
Avg.	 <p>Site : 03CH13-HY Condition : AVG_BE_54 3m HORN_91200_1241 HORIZONTAL Detector : Peak Project : 7D2018 Mode : 9</p>	 <p>Site : 03CH13-HY Condition : AVG_54 3m HORN_91200_1241 HORIZONTAL Detector : Peak Project : 7D2018 Mode : 9</p>

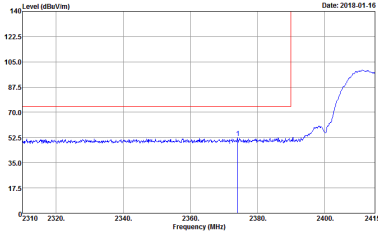
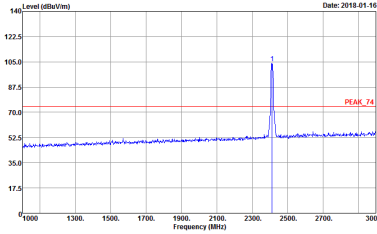
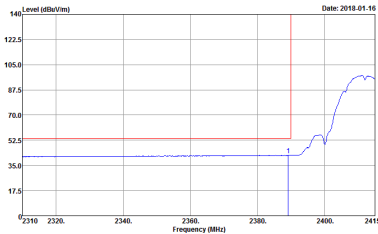
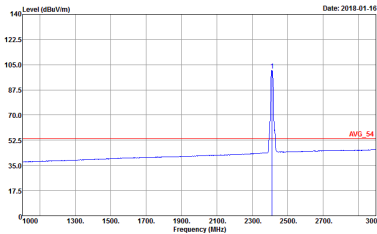

WIFI	2.4GHz 2400~2483.5MHz Band Edge @ 3m	
ANT	802.11b CH01 2412MHz	
1	Vertical	Fundamental
Peak	 <p>Site : 03CH13-HY            Condition : PEAK_BE_74 3m HORN_91200_1241 VERTICAL            RBW:1000.000KHz VBW:3000.000KHz SWT:Auto            Detector : Peak            Project : 7D2018            Mode : 9</p>	 <p>Site : 03CH13-HY            Condition : PEAK_74 3m HORN_91200_1241 VERTICAL            RBW:1000.000KHz VBW:3000.000KHz SWT:Auto            Detector : Peak            Project : 7D2018            Mode : 9</p>
Avg.	 <p>Site : 03CH13-HY            Condition : AVG_BE_54 3m HORN_91200_1241 VERTICAL            RBW:1000.000KHz VBW:0.300KHz SWT:Auto            Detector : Peak            Project : 7D2018            Mode : 9</p>	 <p>Site : 03CH13-HY            Condition : AVG_54 3m HORN_91200_1241 VERTICAL            RBW:1000.000KHz VBW:0.300KHz SWT:Auto            Detector : Peak            Project : 7D2018            Mode : 9</p>



WIFI	2.4GHz 2400~2483.5MHz Band Edge @ 3m	
ANT	802.11b CH06 2437MHz - L	
1	Horizontal	Fundamental
Peak	<p>           Site : 03CH13-HY            Condition : PEAK_BE_74 3m HORN_91200_1241 HORIZONTAL            Detector : Peak            Project : 7D2018            Mode : 10         </p>	<p>           Site : 03CH13-HY            Condition : PEAK_74 3m HORN_91200_1241 HORIZONTAL            Detector : Peak            Project : 7D2018            Mode : 10         </p>
Avg.	<p>           Site : 03CH13-HY            Condition : AVG_BE_54 3m HORN_91200_1241 HORIZONTAL            Detector : Peak            Project : 7D2018            Mode : 10         </p>	<p>           Site : 03CH13-HY            Condition : AVG_54 3m HORN_91200_1241 HORIZONTAL            Detector : Peak            Project : 7D2018            Mode : 10         </p>

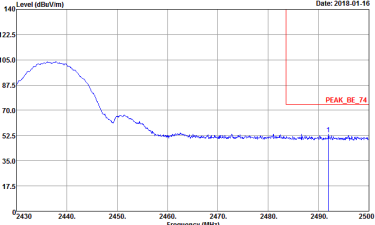
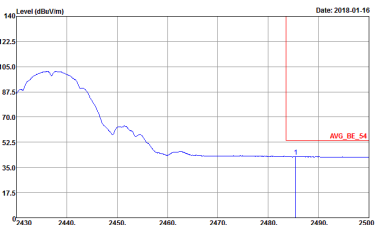

WIFI	2.4GHz 2400~2483.5MHz Band Edge @ 3m	
ANT	802.11b CH06 2437MHz - R	
1	Horizontal	Fundamental
<p><b>Peak</b></p>	 <p>Site : 03CH13-HY            Condition : PEAK_BE_74 3m HORN_9120D_1241 HORIZONTAL            RBW:1000.000kHz VBW:3000.000kHz SWF:Auto            Detector : Peak            Project : 7D2018            Mode : ID</p>	<p>Left blank</p>
<p><b>Avg.</b></p>	 <p>Site : 03CH13-HY            Condition : AVG_BE_54 3m HORN_9120D_1241 HORIZONTAL            RBW:1000.000kHz VBW:3.000kHz SWF:Auto            Detector : Peak            Project : 7D2018            Mode : ID</p>	<p>Left blank</p>

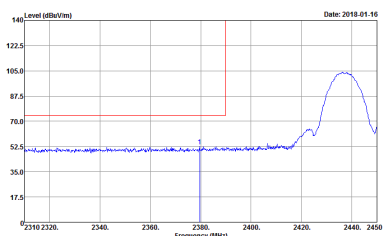
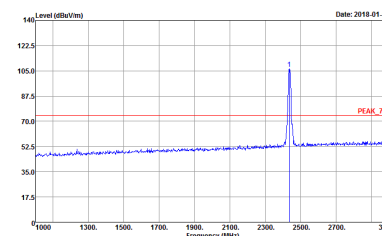
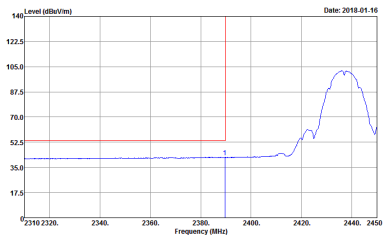
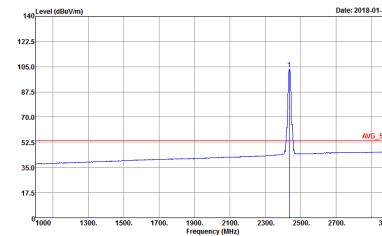

WIFI	2.4GHz 2400~2483.5MHz Band Edge @ 3m	
ANT	802.11b CH06 2437MHz - L	
1	Vertical	Fundamental
Peak	 <p>Site : 03CH13-HY            Condition : PEAK_BE_74 3m HORN_91200_1241 VERTICAL            RBW:1000.000kHz VBW:3000.000kHz SWT:Auto            Detector : Peak            Project : 7D2018            Mode : 10</p>	 <p>Site : 03CH13-HY            Condition : PEAK_74 3m HORN_91200_1241 VERTICAL            RBW:1000.000kHz VBW:3000.000kHz SWT:Auto            Detector : Peak            Project : 7D2018            Mode : 10</p>
Avg.	 <p>Site : 03CH13-HY            Condition : AVG_BE_54 3m HORN_91200_1241 VERTICAL            RBW:1000.000kHz VBW:0.300kHz SWT:Auto            Detector : Peak            Project : 7D2018            Mode : 10</p>	 <p>Site : 03CH13-HY            Condition : AVG_54 3m HORN_91200_1241 VERTICAL            RBW:1000.000kHz VBW:0.300kHz SWT:Auto            Detector : Peak            Project : 7D2018            Mode : 10</p>

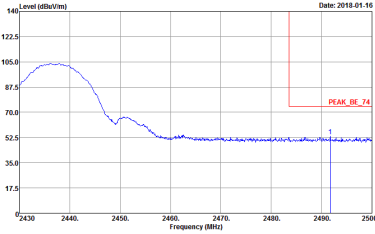
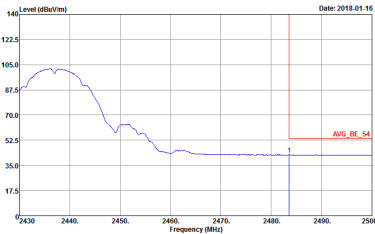

WIFI	2.4GHz 2400~2483.5MHz Band Edge @ 3m	
ANT	802.11b CH06 2437MHz - R	
1	Vertical	Fundamental
<p><b>Peak</b></p>	 <p>Site : 03CH13-HY            Condition : PEAK_BE_74 3m HORN_9120D_1241 VERTICAL            RBW:1000.000kHz VBW:3000.000kHz SWF:Auto            Detector : Peak            Project : 7D2018            Mode : ID</p>	<p>Left blank</p>
<p><b>Avg.</b></p>	 <p>Site : 03CH13-HY            Condition : AVG_BE_54 3m HORN_9120D_1241 VERTICAL            RBW:1000.000kHz VBW:3.000kHz SWF:Auto            Detector : Peak            Project : 7D2018            Mode : ID</p>	<p>Left blank</p>

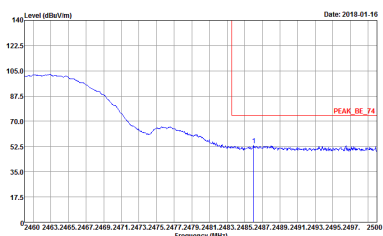
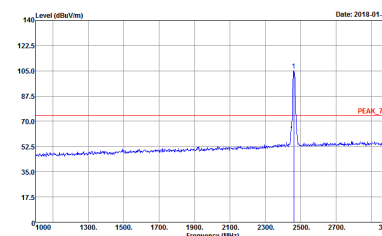
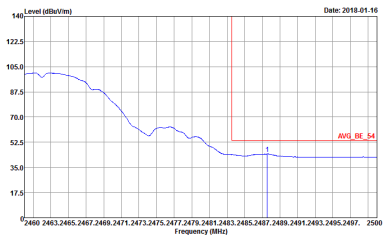
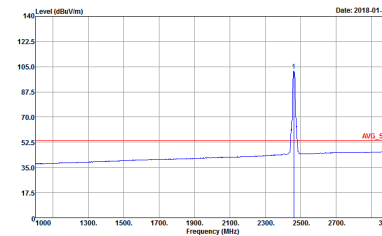

WIFI	2.4GHz 2400~2483.5MHz Band Edge @ 3m	
ANT	802.11b CH11 2462MHz	
1	Horizontal	Fundamental
<b>Peak</b>	 <p>Site : 03CH13-HY            Condition : PEAK_BE_74 3m HORN_91200_1241 HORIZONTAL            RBW:1000.000kHz VBW:3000.000kHz SWT:Auto            Detector : Peak            Project : 7D2018            Mode : II</p>	 <p>Site : 03CH13-HY            Condition : PEAK_74 3m HORN_91200_1241 HORIZONTAL            RBW:1000.000kHz VBW:3000.000kHz SWT:Auto            Detector : Peak            Project : 7D2018            Mode : II</p>
<b>Avg.</b>	 <p>Site : 03CH13-HY            Condition : AVG_BE_54 3m HORN_91200_1241 HORIZONTAL            RBW:1000.000kHz VBW:0.300kHz SWT:Auto            Detector : Peak            Project : 7D2018            Mode : II</p>	 <p>Site : 03CH13-HY            Condition : AVG_54 3m HORN_91200_1241 HORIZONTAL            RBW:1000.000kHz VBW:0.300kHz SWT:Auto            Detector : Peak            Project : 7D2018            Mode : II</p>



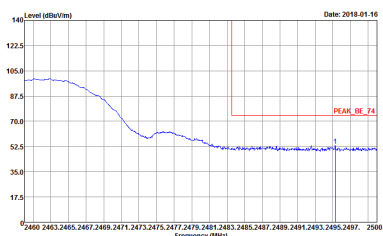
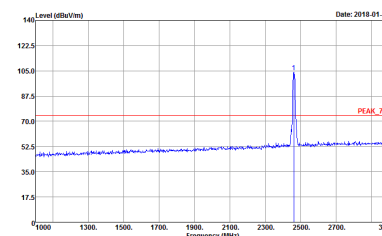
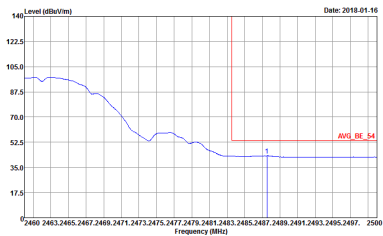
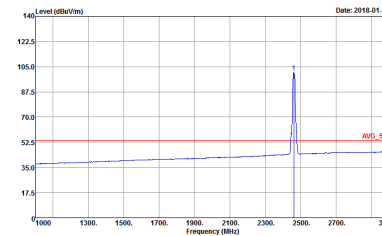

WIFI	2.4GHz 2400~2483.5MHz Band Edge @ 3m	
ANT	802.11b CH11 2462MHz	
1	Vertical	Fundamental
<b>Peak</b>	 <p>Site : 03CH13-HY            Condition : PEAK_BE_74 3m HORN_91200_1241 VERTICAL            RBW:1000.000KHz VBW:3000.000KHz SWT:Auto            Detector : Peak            Project : 7D2018            Mode : II</p>	 <p>Site : 03CH13-HY            Condition : PEAK_74 3m HORN_91200_1241 VERTICAL            RBW:1000.000KHz VBW:3000.000KHz SWT:Auto            Detector : Peak            Project : 7D2018            Mode : II</p>
<b>Avg.</b>	 <p>Site : 03CH13-HY            Condition : AVG_BE_54 3m HORN_91200_1241 VERTICAL            RBW:1000.000KHz VBW:0.300KHz SWT:Auto            Detector : Peak            Project : 7D2018            Mode : II</p>	 <p>Site : 03CH13-HY            Condition : AVG_54 3m HORN_91200_1241 VERTICAL            RBW:1000.000KHz VBW:0.300KHz SWT:Auto            Detector : Peak            Project : 7D2018            Mode : II</p>

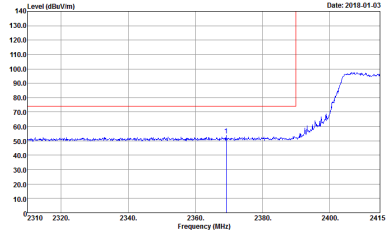
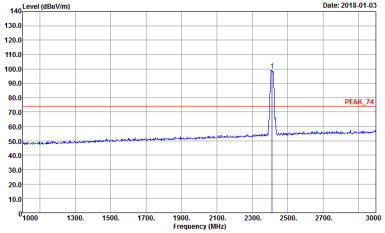
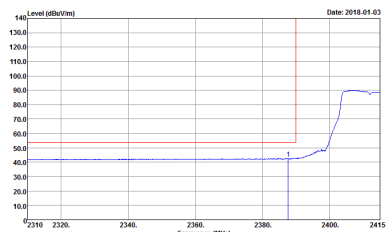
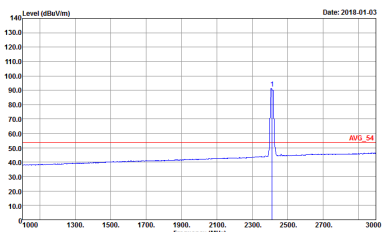

2.4GHz 2400~2483.5MHz  
 WIFI 802.11g (Band Edge @ 3m)

WIFI	2.4GHz 2400~2483.5MHz Band Edge @ 3m	
ANT	802.11g CH01 2412MHz	
1	Horizontal	Fundamental
Peak	 <p>Site : 03CH13-HY            Condition : PEAK_BE_74 3m HORN_91200_1241 HORIZONTAL            : RBW:1000.000KHz VBW:3000.000KHz SWT:Auto            Detector : Peak            Project : 7D2018            Mode : 12</p>	 <p>Site : 03CH13-HY            Condition : PEAK_74 3m HORN_91200_1241 HORIZONTAL            : RBW:1000.000KHz VBW:3000.000KHz SWT:Auto            Detector : Peak            Project : 7D2018            Mode : 12</p>
Avg.	 <p>Site : 03CH13-HY            Condition : AVG_BE_54 3m HORN_91200_1241 HORIZONTAL            : RBW:1000.000KHz VBW:1000KHz SWT:Auto            Detector : Peak            Project : 7D2018            Mode : 12</p>	 <p>Site : 03CH13-HY            Condition : AVG_54 3m HORN_91200_1241 HORIZONTAL            : RBW:1000.000KHz VBW:1000KHz SWT:Auto            Detector : Peak            Project : 7D2018            Mode : 12</p>

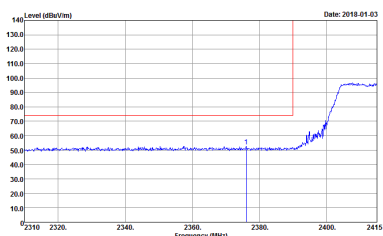
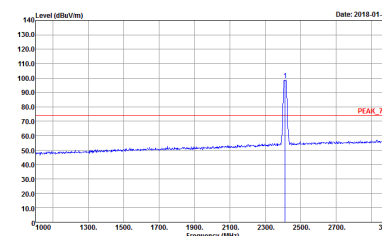
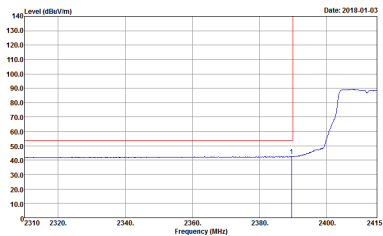
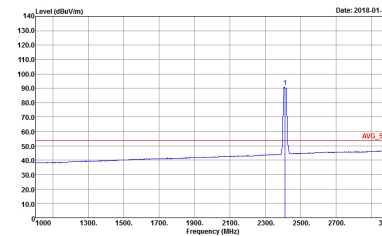

WIFI	2.4GHz 2400~2483.5MHz Band Edge @ 3m	
ANT	802.11g CH01 2412MHz	
1	Vertical	Fundamental
Peak	 <p>Site : 03CH13-HY            Condition : PEAK_BE_74 3m HORN_91200_1241 VERTICAL            RBW:1000.000KHz VBW:3000.000KHz SWT:Auto            Detector : Peak            Project : 7D2018            Mode : 12</p>	 <p>Site : 03CH13-HY            Condition : PEAK_74 3m HORN_91200_1241 VERTICAL            RBW:1000.000KHz VBW:3000.000KHz SWT:Auto            Detector : Peak            Project : 7D2018            Mode : 12</p>
Avg.	 <p>Site : 03CH13-HY            Condition : AVG_BE_54 3m HORN_91200_1241 VERTICAL            RBW:1000.000KHz VBW:1000KHz SWT:Auto            Detector : Peak            Project : 7D2018            Mode : 12</p>	 <p>Site : 03CH13-HY            Condition : AVG_54 3m HORN_91200_1241 VERTICAL            RBW:1000.000KHz VBW:1000KHz SWT:Auto            Detector : Peak            Project : 7D2018            Mode : 12</p>

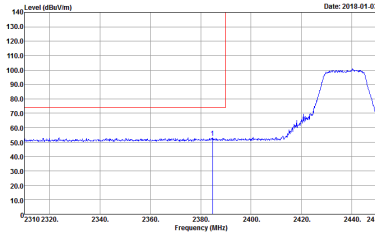
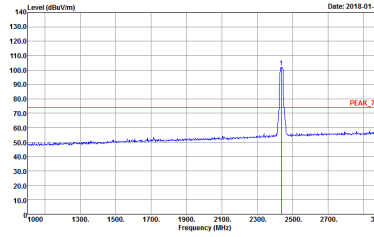
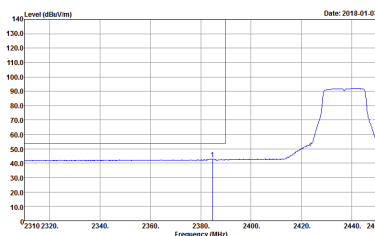
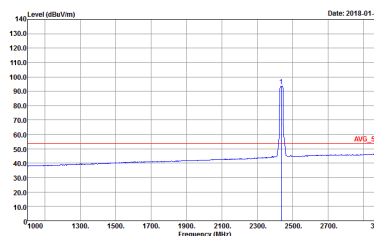

WIFI	2.4GHz 2400~2483.5MHz Band Edge @ 3m	
ANT	802.11g CH06 2437MHz - L	
1	Horizontal	Fundamental
Peak	 <p>Date: 2018-01-03</p> <p>Site : 03CH13-HY            Condition : PEAK_BE_74 3m HORN_91200_1241 HORIZONTAL            RBW:1000.000KHz VBW:3000.000KHz SWT:Auto            Detector : Peak            Project : 7D2018            Mode : 13</p>	 <p>Date: 2018-01-03</p> <p>Site : 03CH13-HY            Condition : PEAK_74 3m HORN_91200_1241 HORIZONTAL            RBW:1000.000KHz VBW:3000.000KHz SWT:Auto            Detector : Peak            Project : 7D2018            Mode : 13</p>
Avg.	 <p>Date: 2018-01-03</p> <p>Site : 03CH13-HY            Condition : AVG_BE_54 3m HORN_91200_1241 HORIZONTAL            RBW:1000.000KHz VBW:1000KHz SWT:Auto            Detector : Peak            Project : 7D2018            Mode : 13</p>	 <p>Date: 2018-01-03</p> <p>Site : 03CH13-HY            Condition : AVG_54 3m HORN_91200_1241 HORIZONTAL            RBW:1000.000KHz VBW:1000KHz SWT:Auto            Detector : Peak            Project : 7D2018            Mode : 13</p>

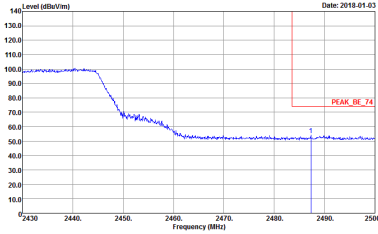
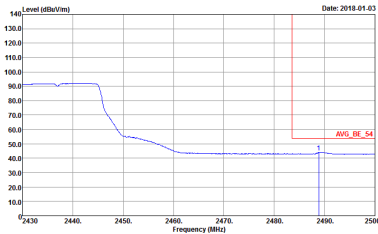

WIFI	2.4GHz 2400~2483.5MHz Band Edge @ 3m	
ANT	802.11g CH06 2437MHz - R	
1	Horizontal	Fundamental
Peak	 <p>Site : 03CH13-HY            Condition : PEAK_BE_74 3m HORN_9120D_1241 HORIZONTAL            RBW:1000.000KHz VBW:3000.000KHz SWT:Auto            Detector : Peak            Project : 7D2018            Mode : 13</p>	Left blank
Avg.	 <p>Site : 03CH13-HY            Condition : AVG_BE_54 3m HORN_9120D_1241 HORIZONTAL            RBW:1000.000KHz VBW:1.000KHz SWT:Auto            Detector : Peak            Project : 7D2018            Mode : 13</p>	Left blank



WIFI	2.4GHz 2400~2483.5MHz Band Edge @ 3m	
ANT	802.11g CH06 2437MHz - L	
1	Vertical	Fundamental
<b>Peak</b>	<p>Site : 03CH13-HY            Condition : PEAK_BE_74 3m HORN_91200_1241 VERTICAL            RBW:1000.000KHz VBW:3000.000KHz SWT:Auto            Detector : Peak            Project : 7D2018            Mode : 13</p>	<p>Site : 03CH13-HY            Condition : PEAK_74 3m HORN_91200_1241 VERTICAL            RBW:1000.000KHz VBW:3000.000KHz SWT:Auto            Detector : Peak            Project : 7D2018            Mode : 13</p>
<b>Avg.</b>	<p>Site : 03CH13-HY            Condition : AVG_BE_54 3m HORN_91200_1241 VERTICAL            RBW:1000.000KHz VBW:1000KHz SWT:Auto            Detector : Peak            Project : 7D2018            Mode : 13</p>	<p>Site : 03CH13-HY            Condition : AVG_54 3m HORN_91200_1241 VERTICAL            RBW:1000.000KHz VBW:1000KHz SWT:Auto            Detector : Peak            Project : 7D2018            Mode : 13</p>

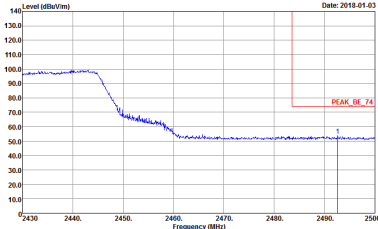
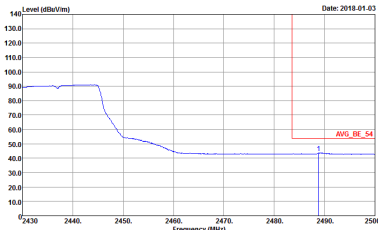

WIFI	2.4GHz 2400~2483.5MHz Band Edge @ 3m	
ANT	802.11g CH06 2437MHz - R	
1	Vertical	Fundamental
Peak	 <p>Date: 2018-01-03</p> <p>Site : 03CH13-HY            Condition : PEAK_BE_74 3m HORN_9120D_1241 VERTICAL            RBW:1000.000kHz VBW:3000.000kHz SWF:Auto            Detector : Peak            Project : 7D2018            Mode : 13</p>	Left Blank
Avg.	 <p>Date: 2018-01-03</p> <p>Site : 03CH13-HY            Condition : AVG_BE_54 3m HORN_9120D_1241 VERTICAL            RBW:1000.000kHz VBW:1.000kHz SWF:Auto            Detector : Peak            Project : 7D2018            Mode : 13</p>	Left Blank

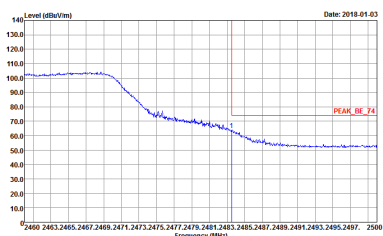
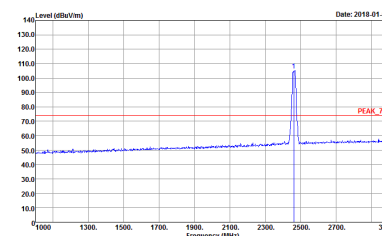
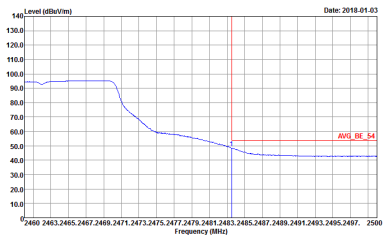
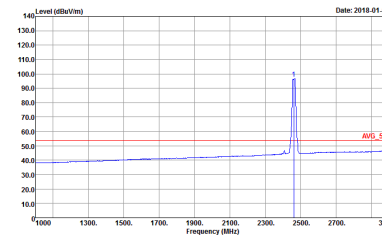

WIFI	2.4GHz 2400~2483.5MHz Band Edge @ 3m	
ANT	802.11g CH11 2462MHz	
1	Horizontal	Fundamental
Peak	 <p>Site : 03CH13-HY            Condition : PEAK_BE_74 3m HORN_91200_1241 HORIZONTAL            RBW:1000.000KHz VBW:3000.000KHz SWT:Auto            Detector : Peak            Project : 7D2018            Mode : 14</p>	 <p>Site : 03CH13-HY            Condition : PEAK_74 3m HORN_91200_1241 HORIZONTAL            RBW:1000.000KHz VBW:3000.000KHz SWT:Auto            Detector : Peak            Project : 7D2018            Mode : 14</p>
Avg.	 <p>Site : 03CH13-HY            Condition : AVG_BE_54 3m HORN_91200_1241 HORIZONTAL            RBW:1000.000KHz VBW:1000KHz SWT:Auto            Detector : Peak            Project : 7D2018            Mode : 14</p>	 <p>Site : 03CH13-HY            Condition : AVG_54 3m HORN_91200_1241 HORIZONTAL            RBW:1000.000KHz VBW:1000KHz SWT:Auto            Detector : Peak            Project : 7D2018            Mode : 14</p>



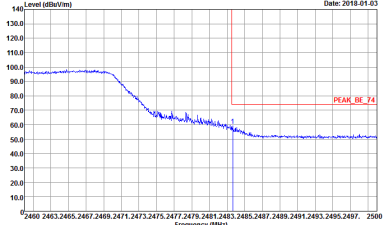
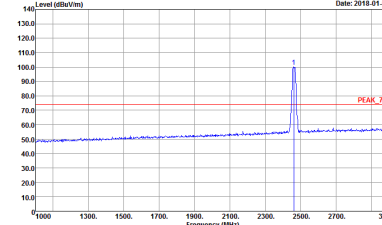
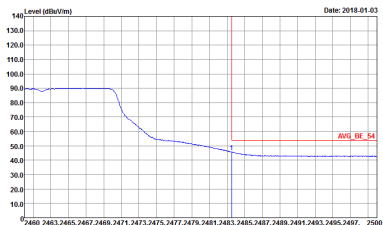
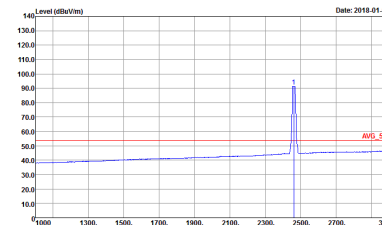

WIFI	2.4GHz 2400~2483.5MHz Band Edge @ 3m	
ANT	802.11g CH11 2462MHz	
1	Vertical	Fundamental
Peak	 <p>Site : 03CH13-HY            Condition : PEAK_BE_74 3m HORN_91200_1241 VERTICAL            RBW:1000.000KHz VBW:3000.000KHz SWT:Auto            Detector : Peak            Project : 7D2018            Mode : 14</p>	 <p>Site : 03CH13-HY            Condition : PEAK_74 3m HORN_91200_1241 VERTICAL            RBW:1000.000KHz VBW:3000.000KHz SWT:Auto            Detector : Peak            Project : 7D2018            Mode : 14</p>
Avg.	 <p>Site : 03CH13-HY            Condition : AVG_BE_54 3m HORN_91200_1241 VERTICAL            RBW:1000.000KHz VBW:1000KHz SWT:Auto            Detector : Peak            Project : 7D2018            Mode : 14</p>	 <p>Site : 03CH13-HY            Condition : AVG_54 3m HORN_91200_1241 VERTICAL            RBW:1000.000KHz VBW:1000KHz SWT:Auto            Detector : Peak            Project : 7D2018            Mode : 14</p>



2.4GHz 2400~2483.5MHz

WIFI 802.11n HT20 (Band Edge @ 3m)

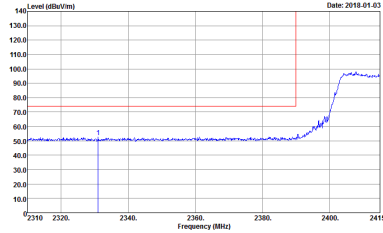
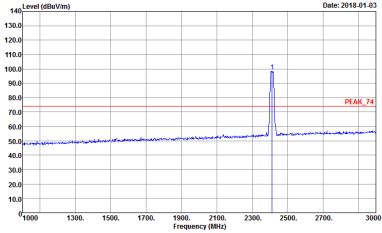
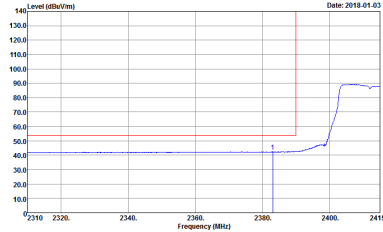
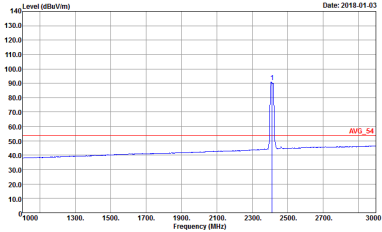
WIFI	2.4GHz 2400~2483.5MHz Band Edge @ 3m	
ANT	802.11n HT20 CH01 2412MHz	
1	Horizontal	Fundamental
Peak	 <p>Site : 03CH13-HY Condition : PEAK_BE_74 3m HORN_91200_1241 HORIZONTAL Detector : Peak Project : 7D2018 Mode : 15</p>	 <p>Site : 03CH13-HY Condition : PEAK_74 3m HORN_91200_1241 HORIZONTAL Detector : Peak Project : 7D2018 Mode : 15</p>
Avg.	 <p>Site : 03CH13-HY Condition : AVG_BE_54 3m HORN_91200_1241 HORIZONTAL Detector : Peak Project : 7D2018 Mode : 15</p>	 <p>Site : 03CH13-HY Condition : AVG_54 3m HORN_91200_1241 HORIZONTAL Detector : Peak Project : 7D2018 Mode : 15</p>

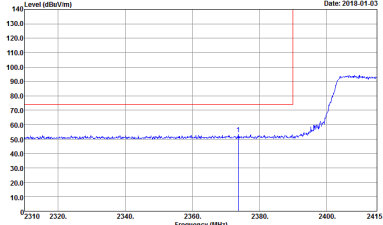
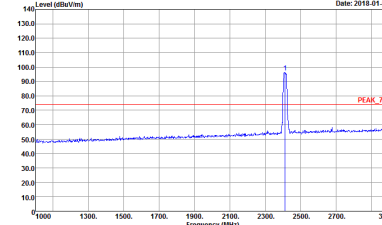
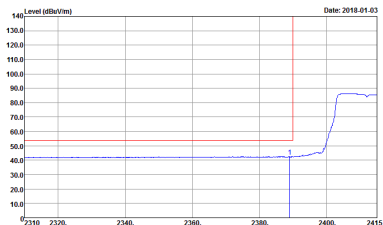
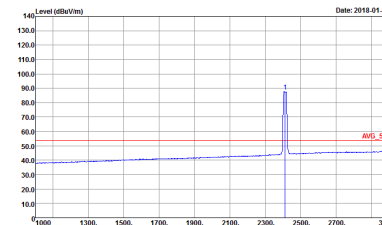

WIFI	2.4GHz 2400~2483.5MHz Band Edge @ 3m	
ANT	802.11n HT20 CH01 2412MHz	
1	Vertical	Fundamental
Peak	 <p>Site : 03CH13-HY            Condition : PEAK_BE_74 3m HORN_91200_1241 VERTICAL            RBW:1000.000KHz VBW:3000.000KHz SWT:Auto            Detector : Peak            Project : 7D2018            Mode : 15</p>	 <p>Site : 03CH13-HY            Condition : PEAK_74 3m HORN_91200_1241 VERTICAL            RBW:1000.000KHz VBW:3000.000KHz SWT:Auto            Detector : Peak            Project : 7D2018            Mode : 15</p>
Avg.	 <p>Site : 03CH13-HY            Condition : AVG_BE_54 3m HORN_91200_1241 VERTICAL            RBW:1000.000KHz VBW:1000KHz SWT:Auto            Detector : Peak            Project : 7D2018            Mode : 15</p>	 <p>Site : 03CH13-HY            Condition : AVG_54 3m HORN_91200_1241 VERTICAL            RBW:1000.000KHz VBW:1000KHz SWT:Auto            Detector : Peak            Project : 7D2018            Mode : 15</p>

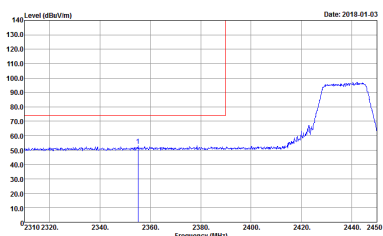
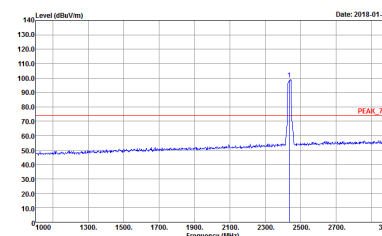
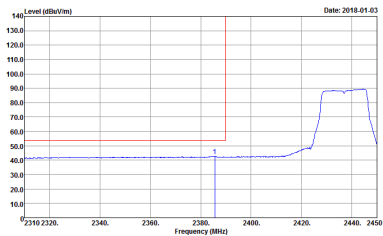
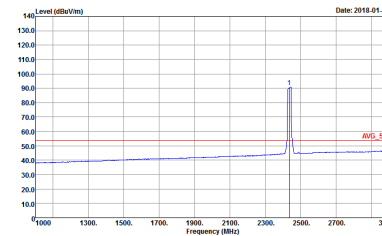

WIFI	2.4GHz 2400~2483.5MHz Band Edge @ 3m	
ANT	802.11n HT20 CH06 2437MHz - L	
1	Horizontal	Fundamental
Peak	 <p>Site : 03CH13-HY            Condition : PEAK_BE_74 3m HORN_91200_1241 HORIZONTAL            RBW:1000.000KHz VBW:3000.000KHz SWT:Auto            Detector : Peak            Project : 7D2018            Mode : 16</p>	 <p>Site : 03CH13-HY            Condition : PEAK_74 3m HORN_91200_1241 HORIZONTAL            RBW:1000.000KHz VBW:3000.000KHz SWT:Auto            Detector : Peak            Project : 7D2018            Mode : 16</p>
Avg.	 <p>Site : 03CH13-HY            Condition : AVG_BE_54 3m HORN_91200_1241 HORIZONTAL            RBW:1000.000KHz VBW:1000KHz SWT:Auto            Detector : Peak            Project : 7D2018            Mode : 16</p>	 <p>Site : 03CH13-HY            Condition : AVG_54 3m HORN_91200_1241 HORIZONTAL            RBW:1000.000KHz VBW:1000KHz SWT:Auto            Detector : Peak            Project : 7D2018            Mode : 16</p>

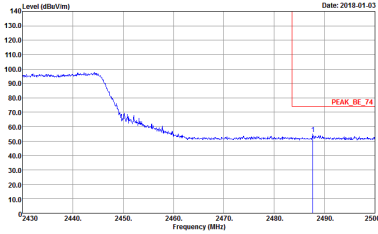
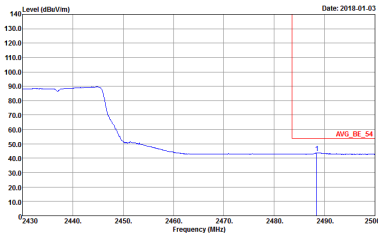

WIFI	2.4GHz 2400~2483.5MHz Band Edge @ 3m	
ANT	802.11n HT20 CH06 2437MHz - R	
1	Horizontal	Fundamental
<p><b>Peak</b></p>	 <p>Site : 03CH13-HY            Condition : PEAK_BE_74 3m HORN_9120D_1241 HORIZONTAL            RBW:1000.000kHz VBW:3000.000kHz SWF:Auto            Detector : Peak            Project : 7D2018            Mode : 16</p>	<p>Left blank</p>
<p><b>Avg.</b></p>	 <p>Site : 03CH13-HY            Condition : AVG_BE_54 3m HORN_9120D_1241 HORIZONTAL            RBW:1000.000kHz VBW:1.000kHz SWF:Auto            Detector : Peak            Project : 7D2018            Mode : 16</p>	<p>Left blank</p>

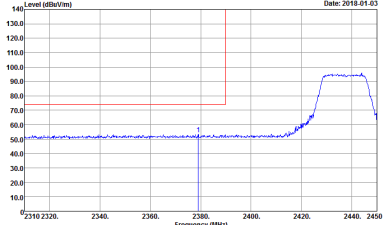
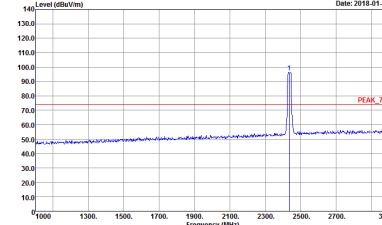
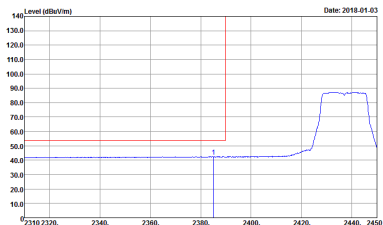
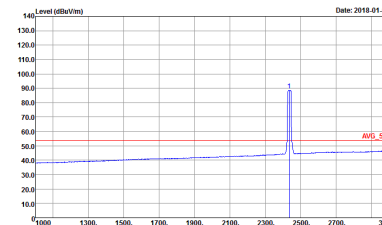

WIFI	2.4GHz 2400~2483.5MHz Band Edge @ 3m	
ANT	802.11n HT20 CH06 2437MHz - L	
1	Vertical	Fundamental
Peak	 <p>Site : 03CH13-HY            Condition : PEAK_BE_74 3m HORN_91200_1241 VERTICAL            RBW:1000.000KHz VBW:3000.000KHz SWT:Auto            Detector : Peak            Project : 7D2018            Mode : 16</p>	 <p>Site : 03CH13-HY            Condition : PEAK_74 3m HORN_91200_1241 VERTICAL            RBW:1000.000KHz VBW:3000.000KHz SWT:Auto            Detector : Peak            Project : 7D2018            Mode : 16</p>
Avg.	 <p>Site : 03CH13-HY            Condition : AVG_BE_54 3m HORN_91200_1241 VERTICAL            RBW:1000.000KHz VBW:1000KHz SWT:Auto            Detector : Peak            Project : 7D2018            Mode : 16</p>	 <p>Site : 03CH13-HY            Condition : AVG_54 3m HORN_91200_1241 VERTICAL            RBW:1000.000KHz VBW:1000KHz SWT:Auto            Detector : Peak            Project : 7D2018            Mode : 16</p>

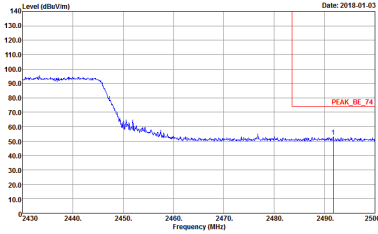
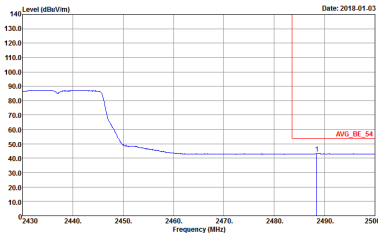

WIFI	2.4GHz 2400~2483.5MHz Band Edge @ 3m	
ANT	802.11n HT20 CH06 2437MHz - R	
1	Vertical	Fundamental
Peak	 <p>Date: 2018-01-03</p> <p>Site : 03CH13-HY            Condition : PEAK_BE_74 3m HORN_9120D_1241 VERTICAL            RBW:1000.000kHz VBW:3000.000kHz SWF:Auto            Detector : Peak            Project : 7D2018            Mode : 16</p>	Left Blank
Avg.	 <p>Date: 2018-01-03</p> <p>Site : 03CH13-HY            Condition : AVG_BE_54 3m HORN_9120D_1241 VERTICAL            RBW:1000.000kHz VBW:1.000kHz SWF:Auto            Detector : Peak            Project : 7D2018            Mode : 16</p>	Left Blank

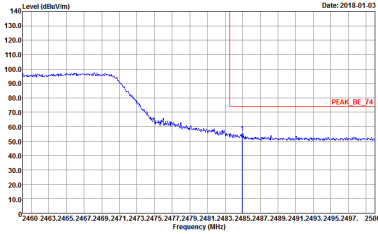
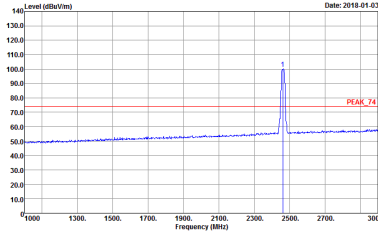
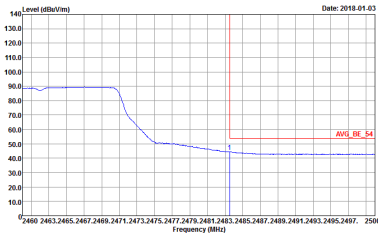
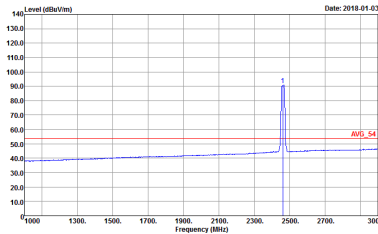

WIFI	2.4GHz 2400~2483.5MHz Band Edge @ 3m	
ANT	802.11n HT20 CH11 2462MHz	
1	Horizontal	Fundamental
Peak	 <p>Site : 03CH13-HY            Condition : PEAK_BE_74 3m HORN_91200_1241 HORIZONTAL            RBW:1000.000KHz VBW:3000.000KHz SWT:Auto            Detector : Peak            Project : 7D2018            Mode : 17</p>	 <p>Site : 03CH13-HY            Condition : PEAK_74 3m HORN_91200_1241 HORIZONTAL            RBW:1000.000KHz VBW:3000.000KHz SWT:Auto            Detector : Peak            Project : 7D2018            Mode : 17</p>
Avg.	 <p>Site : 03CH13-HY            Condition : AVG_BE_54 3m HORN_91200_1241 HORIZONTAL            RBW:1000.000KHz VBW:1000KHz SWT:Auto            Detector : Peak            Project : 7D2018            Mode : 17</p>	 <p>Site : 03CH13-HY            Condition : AVG_54 3m HORN_91200_1241 HORIZONTAL            RBW:1000.000KHz VBW:1000KHz SWT:Auto            Detector : Peak            Project : 7D2018            Mode : 17</p>



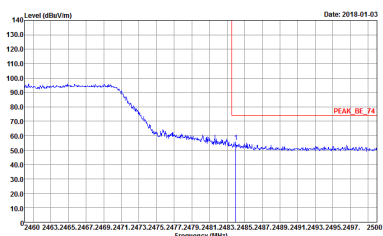
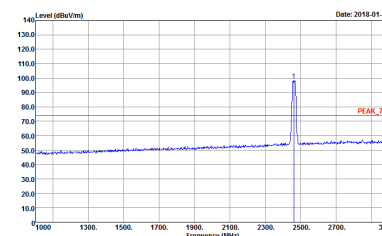
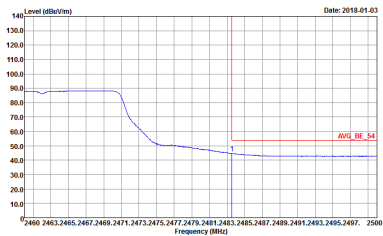
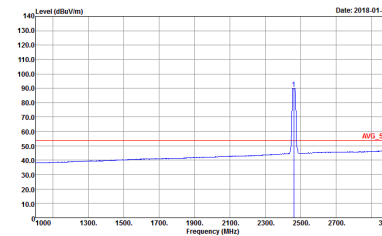

WIFI	2.4GHz 2400~2483.5MHz Fundamental @ 3m	
ANT	802.11n HT20 CH11 2462MHz	
1	Vertical	Fundamental
<b>Peak</b>	 <p>Site : 03CH13-HY            Condition : PEAK_BE_74 3m HORN_91200_1241 VERTICAL            RBW:1000.000KHz VBW:3000.000KHz SWT:Auto            Detector : Peak            Project : 7D2018            Mode : 17</p>	 <p>Site : 03CH13-HY            Condition : PEAK_74 3m HORN_91200_1241 VERTICAL            RBW:1000.000KHz VBW:3000.000KHz SWT:Auto            Detector : Peak            Project : 7D2018            Mode : 17</p>
<b>Avg.</b>	 <p>Site : 03CH13-HY            Condition : AVG_BE_54 3m HORN_91200_1241 VERTICAL            RBW:1000.000KHz VBW:1000KHz SWT:Auto            Detector : Peak            Project : 7D2018            Mode : 17</p>	 <p>Site : 03CH13-HY            Condition : AVG_54 3m HORN_91200_1241 VERTICAL            RBW:1000.000KHz VBW:1000KHz SWT:Auto            Detector : Peak            Project : 7D2018            Mode : 17</p>



2.4GHz 2400~2483.5MHz  
WIFI 802.11b (Harmonic @ 3m)

WIFI	2.4GHz 2400~2483.5MHz Harmonic @ 3m	
ANT	802.11b CH01 2412MHz	
1	Horizontal	Vertical
<p><b>Peak</b></p> <p><b>Avg.</b></p>	<p>Site : 03CH13-1FY Condition : PEAK_74 3m SHF_HORN_576 HORIZONTAL Detector : Peak Project : 7D2018 Mode : 19</p>	<p>Site : 03CH13-1FY Condition : PEAK_74 3m SHF_HORN_576 VERTICAL Detector : Peak Project : 7D2018 Mode : 19</p>

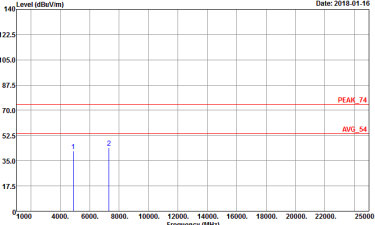
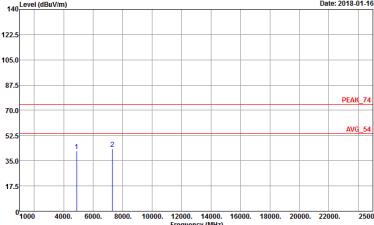

<b>WIFI</b>	<b>2.4GHz 2400~2483.5MHz Harmonic @ 3m</b>	
<b>ANT</b>	<b>802.11b CH06 2437MHz</b>	
<b>1</b>	<b>Horizontal</b>	<b>Vertical</b>
<p><b>Peak</b> <b>Avg.</b></p>	 <p>Site : 03CH13-HY Condition : PEAK_74 3m SHF_HORN_576 HORIZONTAL Detector : Peak Project : 7D2018 Mode : 10</p>	 <p>Site : 03CH13-HY Condition : PEAK_74 3m SHF_HORN_576 VERTICAL Detector : Peak Project : 7D2018 Mode : 10</p>

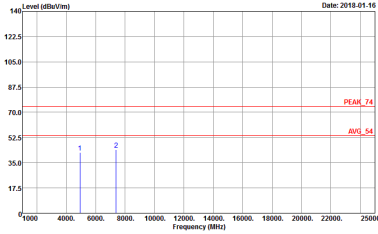
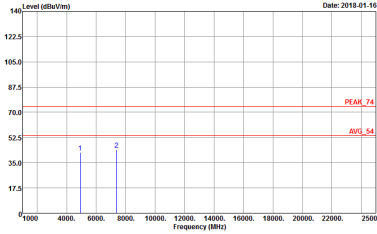

<b>WIFI</b>	<b>2.4GHz 2400~2483.5MHz Harmonic @ 3m</b>	
<b>ANT</b>	<b>802.11b CH11 2462MHz</b>	
<b>1</b>	<b>Horizontal</b>	<b>Vertical</b>
<p><b>Peak</b> <b>Avg.</b></p>	 <p>Site : 03CH13-HY Condition : PEAK_74 3m SHF_HORN_576 HORIZONTAL Detector : Peak Project : 7D2018 Mode : 11</p>	 <p>Site : 03CH13-HY Condition : PEAK_74 3m SHF_HORN_576 VERTICAL Detector : Peak Project : 7D2018 Mode : 11</p>



2.4GHz 2400~2483.5MHz  
WIFI 802.11g (Harmonic @ 3m)

WIFI	2.4GHz 2400~2483.5MHz Harmonic @ 3m	
ANT	802.11g CH01 2412MHz	
1	Horizontal	Vertical
<p><b>Peak</b></p> <p><b>Avg.</b></p>	<p>Site : 03CH13-1FY Condition : PEAK_74 3m SHF_HORN_576 HORIZONTAL Detector : Peak Project : 7D2018 Mode : 12</p>	<p>Site : 03CH13-1FY Condition : PEAK_74 3m SHF_HORN_576 VERTICAL Detector : Peak Project : 7D2018 Mode : 12</p>

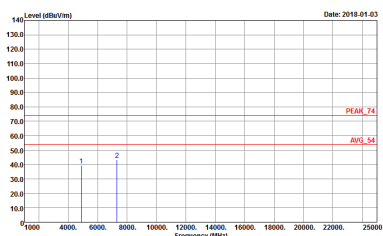
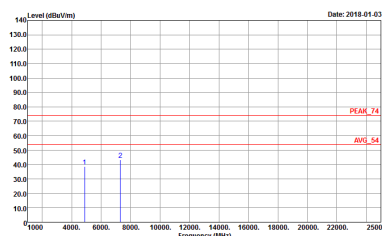

WIFI	2.4GHz 2400~2483.5MHz Harmonic @ 3m	
ANT	802.11g CH06 2437MHz	
1	Horizontal	Vertical
<p><b>Peak</b> <b>Avg.</b></p>	 <p>Site : 03CH13-HY Condition : PEAK_74 3m SHF_HORN_576 HORIZONTAL Detector : Peak Project : 7D2018 Mode : 13</p>	 <p>Site : 03CH13-HY Condition : PEAK_74 3m SHF_HORN_576 VERTICAL Detector : Peak Project : 7D2018 Mode : 13</p>

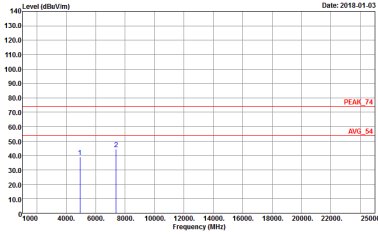
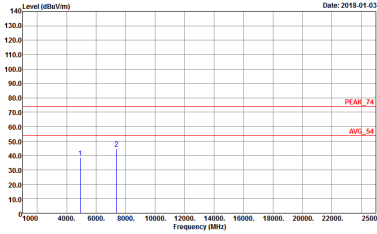

WIFI	2.4GHz 2400~2483.5MHz Harmonic @ 3m	
ANT	802.11g CH11 2462MHz	
1	Horizontal	Vertical
<p><b>Peak</b> <b>Avg.</b></p>	 <p>Site : 03CH13-HY Condition : PEAK_74 3m SHF_HORN_576 HORIZONTAL Detector : Peak Project : 7D2018 Mode : 14</p>	 <p>Site : 03CH13-HY Condition : PEAK_74 3m SHF_HORN_576 VERTICAL Detector : Peak Project : 7D2018 Mode : 14</p>



2.4GHz 2400~2483.5MHz  
 WIFI 802.11n HT20 (Harmonic @ 3m)

WIFI	2.4GHz 2400~2483.5MHz Harmonic @ 3m	
ANT	802.11n HT20 CH01 2412MHz	
1	Horizontal	Vertical
<b>Peak</b>  <b>Avg.</b>	<p>Site : 03CH13-1FY          Condition : PEAK_74 3m SHF_HORN_576 HORIZONTAL          Detector : Peak          Project : 7D2018          Mode : 15</p>	<p>Site : 03CH13-1FY          Condition : PEAK_74 3m SHF_HORN_576 VERTICAL          Detector : Peak          Project : 7D2018          Mode : 15</p>



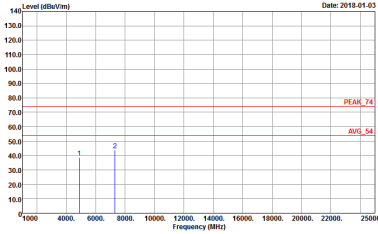
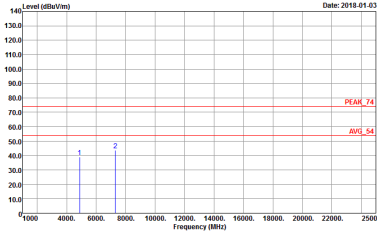

WIFI	2.4GHz 2400~2483.5MHz Harmonic @ 3m	
ANT	802.11n HT20 CH06 2437MHz	
1	Horizontal	Vertical
<p><b>Peak</b> <b>Avg.</b></p>	 <p>Site : 03CH12-HY Condition : PEAK_74 3m SHF_HORN_576 HORIZONTAL Detector : Peak Project : 7D2018 Mode : 16</p>	 <p>Site : 03CH12-HY Condition : PEAK_74 3m SHF_HORN_576 VERTICAL Detector : Peak Project : 7D2018 Mode : 16</p>

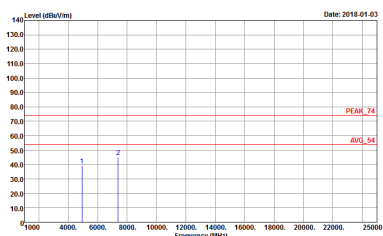
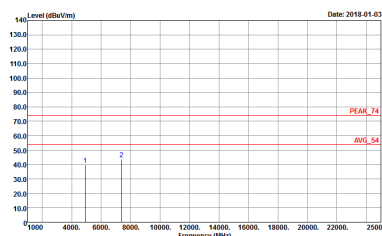

<b>WIFI</b>	<b>2.4GHz 2400~2483.5MHz Harmonic @ 3m</b>	
<b>ANT</b>	<b>802.11n HT20 CH11 2462MHz</b>	
<b>1</b>	<b>Horizontal</b>	<b>Vertical</b>
<p><b>Peak</b> <b>Avg.</b></p>	 <p>Site : 03CH13-HY Condition : PEAK_74 3m SHF_HORN_576 HORIZONTAL Detector : Peak Project : 7D2018 Mode : 17</p>	 <p>Site : 03CH13-HY Condition : PEAK_74 3m SHF_HORN_576 VERTICAL Detector : Peak Project : 7D2018 Mode : 17</p>



Emission below 1GHz  
2.4GHz WIFI 802.11g (LF)

WIFI	2.4GHz 2400~2483.5MHz	
ANT	802.11g LF	
1	Horizontal	Vertical
QP / Peak	<p>Site : 03CH13-HY Condition : QP 3m B1LOG_37059 HORIZONTAL Detector : Peak Project : 7D2018 Mode : Z1</p>	<p>Site : 03CH13-HY Condition : QP 3m B1LOG_37059 VERTICAL Detector : Peak Project : 7D2018 Mode : Z1</p>



### Appendix E. Duty Cycle Plots

Band	Duty Cycle(%)	T(us)	1/T(kHz)	VBW Setting	Duty Factor(dB)
802.11b	97.62	8200	0.12	300Hz	0.10
802.11g	87.26	1370	0.73	1kHz	0.59
2.4GHz 802.11n HT20	85.91	1280	0.52	1kHz	0.66

#### 802.11b

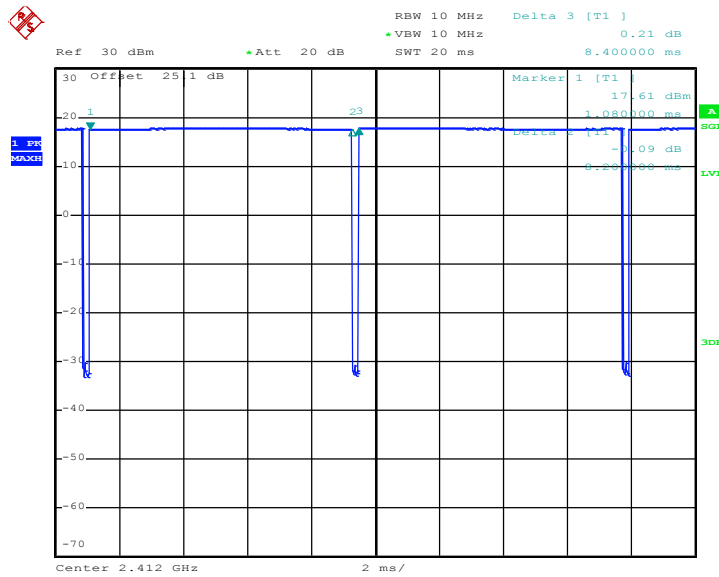

Date: 21.DEC.2017 15:10:23



### 802.11g

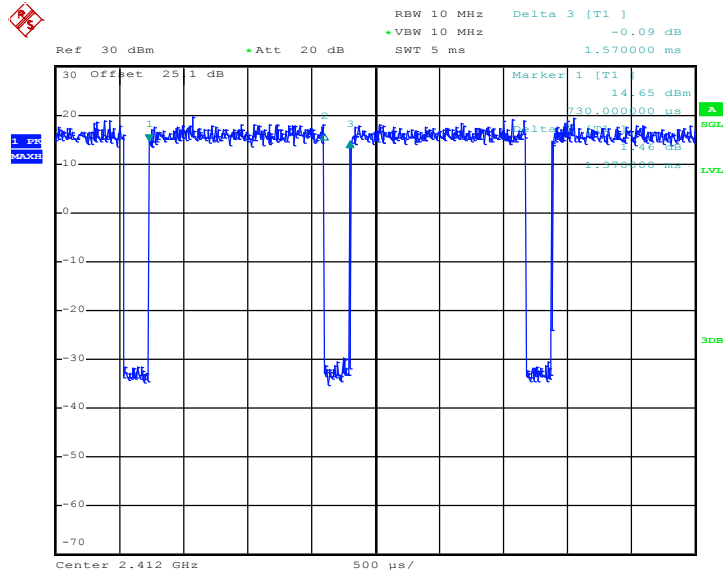

Date: 21.DEC.2017 15:13:20

### 802.11n HT20

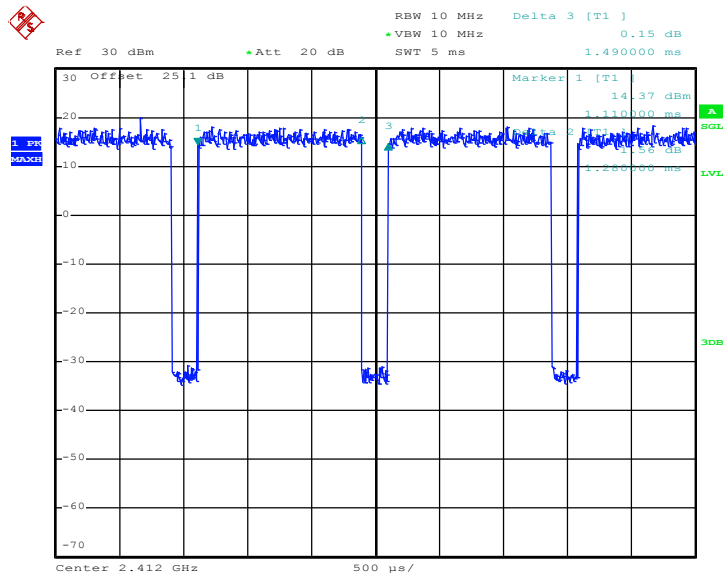

Date: 21.DEC.2017 15:14:16