



FCC RF Test Report

APPLICANT : Motorola Mobility LLC
EQUIPMENT : Mobile Cellular Phone
BRAND NAME : Motorola
MODEL NAME : XT1921-2
FCC ID : IHDT56XC4
STANDARD : FCC Part 15 Subpart E §15.407
CLASSIFICATION : (NII) Unlicensed National Information Infrastructure

This is a variant report. The product was received on Dec. 20, 2017 and testing was completed on Jan. 19, 2018. We, SPORTON INTERNATIONAL INC., would like to declare that the tested sample has been evaluated in accordance with the test procedures and has been in compliance with the applicable technical standards.

The test results in this report apply exclusively to the tested model / sample. Without written approval of SPORTON INTERNATIONAL INC., the test report shall not be reproduced except in full.

Reviewed by: Joseph Lin / Supervisor

Approved by: Jones Tsai / Manager



SPORTON INTERNATIONAL INC.

No. 52, Hwa Ya 1st Rd., Hwa Ya Technology Park, Kwei-Shan District, Tao Yuan City, Taiwan, R.O.C.

SPORTON INTERNATIONAL INC.

TEL : 886-3-327-3456

FAX : 886-3-328-4978

FCC ID : IHDT56XC4

Page Number : 1 of 18

Report Issued Date : Feb. 23, 2018

Report Version : Rev. 01

Report Template No.: BU5-FR15EWLB4 AC MA Version 1.4



TABLE OF CONTENTS

REVISION HISTORY..... 3

SUMMARY OF TEST RESULT 4

1 GENERAL DESCRIPTION 5

 1.1 Applicant 5

 1.2 Manufacturer 5

 1.3 Product Feature of Equipment Under Test..... 5

 1.4 Product Specification of Equipment Under Test..... 6

 1.5 Modification of EUT 6

 1.6 Testing Location 6

 1.7 Applicable Standards 7

2 TEST CONFIGURATION OF EQUIPMENT UNDER TEST 8

 2.1 Carrier Frequency and Channel 8

 2.2 Test Mode 8

 2.3 Connection Diagram of Test System 9

 2.4 Support Unit used in test configuration and system 9

 2.5 EUT Operation Test Setup 9

3 TEST RESULT 10

 3.1 Maximum Conducted Output Power Measurement 10

 3.2 Unwanted Emissions Measurement 11

 3.3 Antenna Requirements 16

4 LIST OF MEASURING EQUIPMENT 17

5 UNCERTAINTY OF EVALUATION 18

APPENDIX A. CONDUCTED TEST RESULTS

APPENDIX B. RADIATED SPURIOUS EMISSION

APPENDIX C. RADIATED SPURIOUS EMISSION PLOTS

APPENDIX D. DUTY CYCLE PLOTS

APPENDIX E. ORIGINAL REPORT



SUMMARY OF TEST RESULT

Report Section	FCC Rule	Description	Limit	Result	Remark
-	15.403(i)	6dB, 26dB and 99% Occupied Bandwidth	> 500kHz	Not Required	-
3.1	15.407(a)	Maximum Conducted Output Power	≤ 30 dBm	Pass	-
-	15.407(a)	Power Spectral Density	≤ 30 dBm/500kHz	Not Required	-
3.2	15.407(b)	Unwanted Emissions	15.407(b)(4)(i) & 15.209(a)	Pass	Under limit 7.24 dB at 11490.000 MHz
-	15.207	AC Conducted Emission	15.207(a)	Not Required	-
-	15.407(c)	Automatically Discontinue Transmission	Discontinue Transmission	Not Required	-
3.3	15.203 & 15.407(a)	Antenna Requirement	N/A	Pass	-

Remark:

1. This is a variant report which can be referred Product Equality Declaration. All the test cases were performed on original report which can be referred to Sporton Report Number FR7D2018E. Based on the original report, the test cases were verified.
2. Not required means after assessing, test items are not necessary to carry out.



1 General Description

1.1 Applicant

Motorola Mobility LLC
222 W. Merchandise Mart Plaza, Chicago IL 60654, USA

1.2 Manufacturer

Motorola Mobility LLC
222 W. Merchandise Mart Plaza, Chicago IL 60654, USA

1.3 Product Feature of Equipment Under Test

Product Feature	
Equipment	Mobile Cellular Phone
Brand Name	Motorola
Model Name	XT1921-2
FCC ID	IHDT56XC4
IMEI Code	351840090009741
EUT supports Radios application	GSM/EGPRS/WCDMA/HSPA/LTE/FM/GNSS WLAN 11b/g/n HT20 WLAN 11a/n HT20/HT40 Bluetooth BR/EDR/LE
HW Version	DVT1B
EUT Stage	Identical Prototype

Remark: The above EUT's information was declared by manufacturer. Please refer to the specifications or user's manual for more detailed description.

Accessory List	
AC Adapter 1	Brand Name : Motorola
	Model Name : C-P56
AC Adapter 2	Brand Name : Motorola
	Model Name : C-P56
Battery	Brand Name : Motorola
	Model Name : GK40
USB Cable	Brand Name : Saibao
	Model Name : SWT-A083A



1.4 Product Specification of Equipment Under Test

Standards-related Product Specification	
Tx/Rx Channel Frequency Range	5745 MHz ~ 5825 MHz
Maximum Output Power	802.11a : 15.98 dBm / 0.0396 W 802.11n HT20 : 10.92 dBm / 0.0124 W 802.11n HT40 : 9.93 dBm / 0.0098 W
Antenna Type / Gain	PIFA Antenna with gain -3.59 dBi
Type of Modulation	802.11a/n : OFDM (BPSK / QPSK / 16QAM / 64QAM)

1.5 Modification of EUT

No modifications are made to the EUT during all test items.

1.6 Testing Location

Sporton Lab is accredited to ISO 17025 by Taiwan Accreditation Foundation (TAF code : 1190) and the FCC designation No. TW1190 and TW0007 under the FCC 2.948(e) by Mutual Recognition Agreement (MRA) in FCC Test.

Test Site	SPORTON INTERNATIONAL INC.
Test Site Location	No. 52, Hwa Ya 1 st Rd., Hwa Ya Technology Park, Kwei-Shan District, Tao Yuan City, Taiwan, R.O.C. TEL: +886-3-327-3456 FAX: +886-3-328-4978
Test Site No.	Sporton Site No. TH05-HY

Note: The test site complies with ANSI C63.4 2014 requirement.

Test Site	SPORTON INTERNATIONAL INC.
Test Site Location	No.58, Aly. 75, Ln. 564, Wenhua 3rd Rd. Guishan Dist, Taoyuan City, Taiwan (R.O.C.) TEL: +886-3-327-0868 FAX: +886-3-327-0855
Test Site No.	Sporton Site No. 03CH11-HY

Note: The test site complies with ANSI C63.4 2014 requirement.



1.7 Applicable Standards

According to the specifications of the manufacturer, the EUT must comply with the requirements of the following standards:

- ♦ FCC Part 15 Subpart E
- ♦ FCC KDB 789033 D02 General UNII Test Procedures New Rules v02r01.
- ♦ ANSI C63.10-2013

Remark:

1. All test items were verified and recorded according to the standards and without any deviation during the test.
2. This EUT has also been tested and complied with the requirements of FCC Part 15, Subpart B, recorded in a separate test report.



2 Test Configuration of Equipment Under Test

- a. The EUT has been associated with peripherals and configuration operated in a manner tended to maximize its emission characteristics in a typical application. Frequency range investigated: radiation emission (9 kHz to the 10th harmonic of the highest fundamental frequency or to 40 GHz, whichever is lower). For radiated measurement, pre-scanned in three orthogonal panels, X, Y, Z. The worst cases (Y plane) were recorded in this report.

2.1 Carrier Frequency and Channel

Frequency Band	Channel	Freq. (MHz)	Channel	Freq. (MHz)
5725-5850 MHz Band 4 (U-NII-3)	149	5745	157	5785
	151*	5755	159*	5795
	153	5765	161	5805
	-	-	165	5825

Note: The above Frequency and Channel in "*" were 802.11n HT40 and 802.11ac VHT40.

2.2 Test Mode

Final test modes are considering the modulation and worse data rates as below table.

Modulation	Data Rate
802.11a	6 Mbps
Remark: For Radiated Test Cases, The tests were performance with Adapter 1.	

Ch. #		Band IV : 5725-5850 MHz
		802.11a
L	Low	149
M	Middle	-
H	High	-

2.3 Connection Diagram of Test System

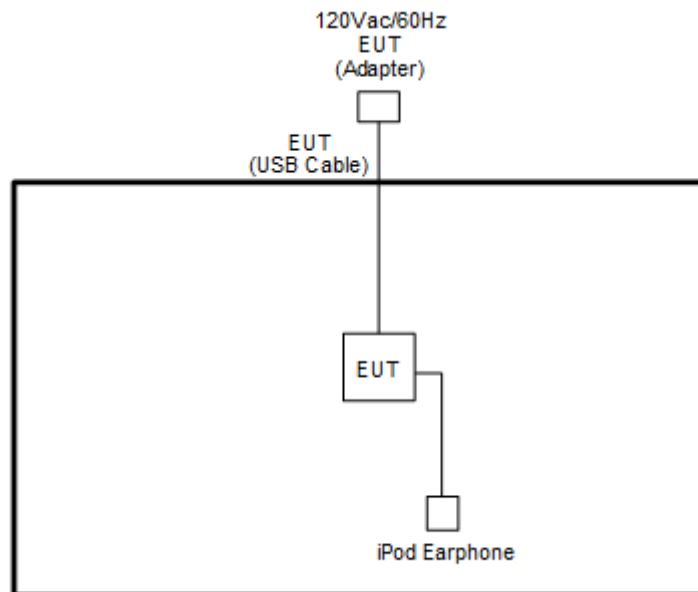

2.4 Support Unit used in test configuration and system

Equipment	Trade Name	Model Name	FCC ID	Data Cable	Power Cord
iPod Earphone	Apple	N/A	Verification	Unshielded, 1.0 m	N/A

2.5 EUT Operation Test Setup

The RF test items, utility "QRCT" was installed in Notebook which was programmed in order to make the EUT get into the engineering modes to provide channel selection, power level, data rate and the application type and for continuous transmitting signals.

3 Test Result

3.1 Maximum Conducted Output Power Measurement

3.1.1 Limit of Maximum Conducted Output Power

For the band 5.725–5.85 GHz, the maximum conducted output power over the frequency band of operation shall not exceed 1 W.

If transmitting antennas of directional gain greater than 6 dBi are used, the peak output power shall be reduced by the amount in dB that the directional gain of the antenna exceeds 6 dBi.

3.1.2 Measuring Instruments

The measuring equipment is listed in the section 4 of this test report.

3.1.3 Test Procedures

The testing follows Method PM of FCC KDB 789033 D02 General UNII Test Procedures New Rules v02r01.

Method PM (Measurement using an RF average power meter):

1. Measurement is performed using a wideband RF power meter.
2. The EUT is configured to transmit continuously with a consistent duty cycle at its maximum power control level.
3. Measure the average power of the transmitter, and the average power is corrected with duty factor, $10 \log(1/x)$, where x is the duty cycle.

3.1.4 Test Setup

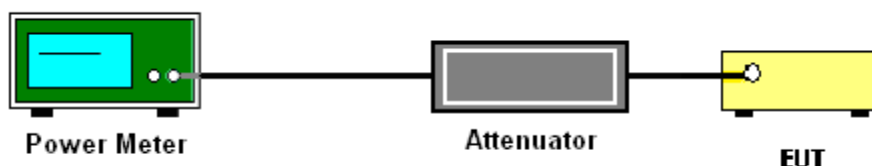

3.1.5 Test Result of Maximum Conducted Output Power

Please refer to Appendix A.



3.2 Unwanted Emissions Measurement

This section is to measure unwanted emissions through radiated measurement for band edge spurious emissions and out of band emissions measurement.

3.2.1 Limit of Unwanted Emissions

- (1) For transmitters operating in the 5.725-5.85 GHz band:
15.407(b)(4)(i) All emissions shall be limited to a level of -27 dBm/MHz at 75 MHz or more above or below the band edge increasing linearly to 10 dBm/MHz at 25 MHz above or below the band edge, and from 25 MHz above or below the band edge increasing linearly to a level of 15.6 dBm/MHz at 5 MHz above or below the band edge, and from 5 MHz above or below the band edge increasing linearly to a level of 27 dBm/MHz at the band edge.
- (2) Unwanted spurious emissions fallen in restricted bands shall comply with the general field strength limits as below table,

Frequency (MHz)	Field Strength (microvolts/meter)	Measurement Distance (meters)
0.009 – 0.490	2400/F(kHz)	300
0.490 – 1.705	24000/F(kHz)	30
1.705 – 30.0	30	30
30 – 88	100	3
88 – 216	150	3
216 - 960	200	3
Above 960	500	3

Note: The following formula is used to convert the EIRP to field strength.

$$E = \frac{1000000\sqrt{30P}}{3} \text{ } \mu\text{V/m, where P is the eirp (Watts)}$$



EIRP (dBm)	Field Strength at 3m (dBµV/m)
-17	78.3
- 27	68.3

(3) KDB789033 D02 v02r01 G)2)c)

- (i) Section 15.407(b)(1) to (b)(3) specify the unwanted emission limits for the U-NII-1 and U-NII-2 bands. As specified, emissions above 1000 MHz that are outside of the restricted bands are subject to a peak emission limit of -27 dBm/MHz.³
- (ii) Section 15.407(b)(4) specifies the unwanted emission limit for the U-NII-3 band. A band emissions mask is specified in Section 15.407(b)(4)(i). The emission limits are in terms of a Peak detector. An alternative to the band emissions mask is specified in Section 15.407(b)(4)(ii). The alternative limits are based on the highest antenna gain specified in the filing. There are also marketing and importation restrictions for the devices using the alternative limit.⁴

Note 3: An out-of-band emission that complies with both the average and peak limits of Section 15.209 is not required to satisfy the -27 dBm/MHz peak emission limit.

Note 4: Only devices with antenna gains of 10 dBi or less may be approved using the emission limits specified in Section 15.247(d) till March 2, 2018; all other devices operating in this band must use the mask specified in Section 15.407(b)(4)(i).

3.2.2 Measuring Instruments

The measuring equipment is listed in the section 4 of this test report.



3.2.3 Test Procedures

1. The testing follows FCC KDB 789033 D02 General UNII Test Procedures New Rules v02r01. Section G) Unwanted emissions measurement.
 - (1) Procedure for Unwanted Emissions Measurements Below 1000MHz
 - RBW = 120 kHz
 - VBW = 300 kHz
 - Detector = Peak
 - Trace mode = max hold
 - (2) Procedure for Peak Unwanted Emissions Measurements Above 1000 MHz
 - RBW = 1 MHz
 - VBW \geq 3 MHz
 - Detector = Peak
 - Sweep time = auto
 - Trace mode = max hold
 - (3) Procedures for Average Unwanted Emissions Measurements Above 1000MHz
 - RBW = 1 MHz
 - VBW = 10 Hz, when duty cycle is no less than 98 percent.
 - VBW \geq 1/T, when duty cycle is less than 98 percent where T is the minimum transmission duration over which the transmitter is on and is transmitting at its maximum power control level for the tested mode of operation.
2. The EUT was placed on a turntable with 0.8 meter for frequency below 1GHz and 1.5 meter for frequency above 1GHz respectively above ground.
3. The EUT was set 3 meters from the interference receiving antenna which was mounted on the top of a variable height antenna tower.
4. The antenna is a broadband antenna and its height is adjusted between one meter and four meters above ground to find the maximum value of the field strength for both horizontal polarization and vertical polarization of the antenna.
5. For each suspected emission, the EUT was arranged to its worst case and then adjust the antenna tower (from 1 m to 4 m) and turntable (from 0 degree to 360 degrees) to find the maximum reading.
6. For testing below 1GHz, if the emission level of the EUT in peak mode was 3 dB lower than the limit specified, then peak values of EUT will be reported, otherwise, the emissions will be repeated one by one using the CISPR quasi-peak method and reported.

- 7. For testing above 1GHz, the emission level of the EUT in peak mode was 20dB lower than average limit (that means the emission level in average mode also complies with the limit in average mode), then peak values of EUT will be reported, otherwise, the emissions will be measured in average mode again and reported.

3.2.4 Test Setup

For radiated emissions below 30MHz

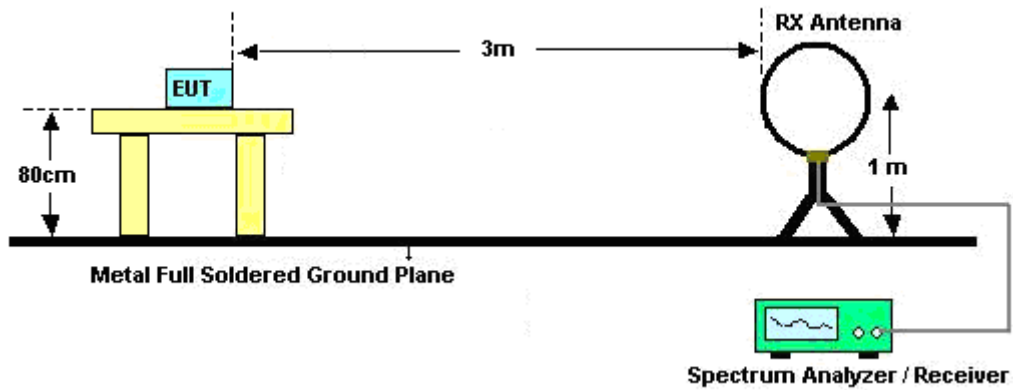

For radiated emissions from 30MHz to 1GHz

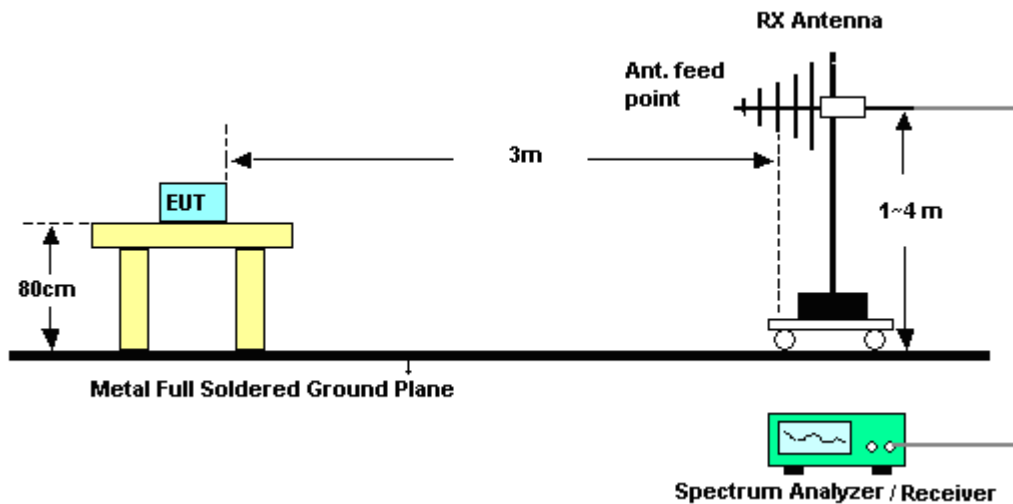

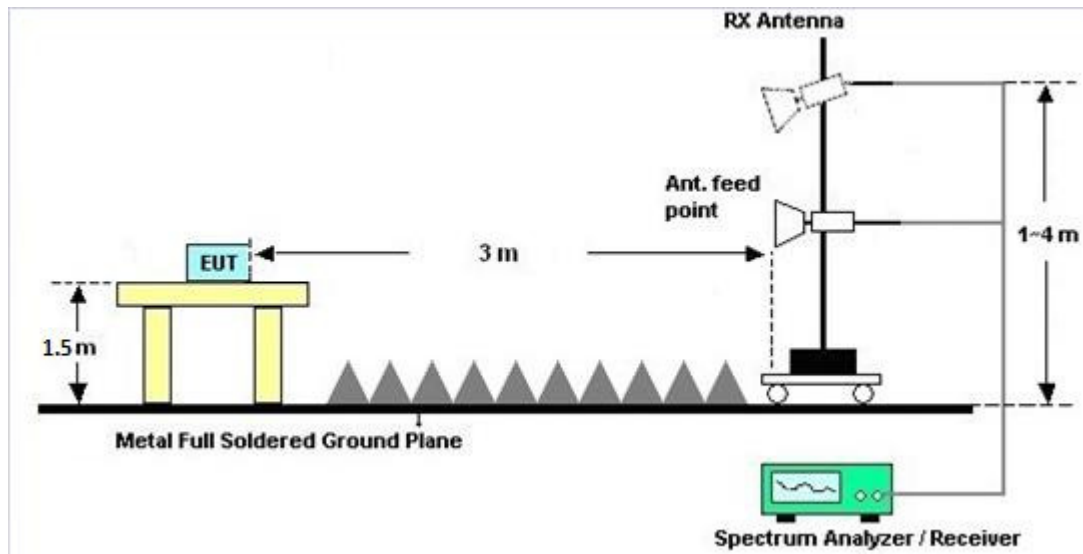
For radiated emissions above 1GHz**3.2.5 Test Results of Radiated Emissions (9 kHz ~ 30 MHz)**

The low frequency, which started from 9 kHz to 30MHz, was pre-scanned and the result which was 20dB lower than the limit line was not reported.

There is a comparison data of both open-field test site and semi-Anechoic chamber, and the result came out very similar.

3.2.6 Test Result of Radiated Band Edges

Please refer to Appendix B and C.

3.2.7 Duty Cycle

Please refer to Appendix D.

3.2.8 Test Result of Unwanted Radiated Emission (30MHz ~ 10th Harmonic)

Please refer to Appendix B and C.



3.3 Antenna Requirements

3.3.1 Standard Applicable

If transmitting antenna directional gain is greater than 6 dBi, both the peak transmit power and the peak power spectral density shall be reduced by the amount in dB that the directional gain of the antenna exceeds 6 dBi.

3.3.2 Antenna Anti-Replacement Construction

An embedded-in antenna design is used.

3.3.3 Antenna Gain

The antenna peak gain of EUT is less than 6 dBi. Therefore, it is not necessary to reduce maximum peak output power limit.



4 List of Measuring Equipment

Instrument	Manufacturer	Model No.	Serial No.	Characteristics	Calibration Date	Test Date	Due Date	Remark
Power Meter	Anritsu	ML2495A	1240001	N/A	Sep. 07, 2017	Jan. 05, 2018~ Jan. 17, 2018	Sep. 06, 2018	Conducted (TH05-HY)
Power Sensor	Anritsu	MA2411B	1207349	300MHz~40GHz	Sep. 07, 2017	Jan. 05, 2018~ Jan. 17, 2018	Sep. 06, 2018	Conducted (TH05-HY)
Spectrum Analyzer	Rohde & Schwarz	FSP40	100055	9kHz~40GHz	Jun. 20, 2017	Jan. 05, 2018~ Jan. 17, 2018	Jun. 19, 2018	Conducted (TH05-HY)
Temperature Chamber	ESPEC	SH-641	92013720	-40℃ ~90℃	Aug. 28, 2017	Jan. 05, 2018~ Jan. 17, 2018	Aug. 27, 2018	Conducted (TH05-HY)
Amplifier	MITEQ	TTA1840-3 5-HG	1871923	18GHz~40GHz,VS WR : 2.5:1 max	Jul. 18, 2017	Jan. 08, 2018 ~ Jan. 19, 2018	Jul. 17, 2018	Radiation (03CH11-HY)
Amplifier	SONOMA	310N	187312	9kHz~1GHz	Nov. 10, 2016	Jan. 08, 2018 ~ Jan. 19, 2018	Nov. 09, 2018	Radiation (03CH11-HY)
Bilog Antenna	TESEQ	CBL 6111D&N- 6-06	35414&AT- N0602	30MHz~1GHz	Oct. 14, 2017	Jan. 08, 2018 ~ Jan. 19, 2018	Oct. 13, 2018	Radiation (03CH11-HY)
Horn Antenna	SCHWARZBEC K	BBHA 9120 D	9120D-132 6	1GHz ~ 18GHz	Oct. 16, 2017	Jan. 08, 2018 ~ Jan. 19, 2018	Oct. 15, 2018	Radiation (03CH11-HY)
Loop Antenna	Rohde & Schwarz	HFH2-Z2	100488	9 kHz~30 MHz	Nov. 23, 2017	Jan. 08, 2018 ~ Jan. 19, 2018	Nov. 22, 2019	Radiation (03CH11-HY)
Preamplifier	Keysight	83017A	MY532700 80	1GHz~26.5GHz	Nov. 10, 2016	Jan. 08, 2018 ~ Jan. 19, 2018	Nov. 09, 2018	Radiation (03CH11-HY)
Spectrum Analyzer	Keysight	N9010A	MY542004 86	10Hz ~ 44GHz	Oct. 19, 2017	Jan. 08, 2018 ~ Jan. 19, 2018	Oct. 18, 2018	Radiation (03CH11-HY)
Antenna Mast	EMEC	AM-BS-45 00-B	N/A	1~4m	N/A	Jan. 08, 2018 ~ Jan. 19, 2018	N/A	Radiation (03CH11-HY)
Turn Table	EMEC	TT 2000	N/A	0~360 Degree	N/A	Jan. 08, 2018 ~ Jan. 19, 2018	N/A	Radiation (03CH11-HY)
SHF-EHF Horn Antenna	SCHWARZBEC K	BBHA 9170	BBHA9170 584	18GHz- 40GHz	Nov. 27, 2017	Jan. 08, 2018 ~ Jan. 19, 2018	Nov. 26, 2018	Radiation (03CH11-HY)
Preamplifier	MITEQ	AMF-7D-0 0101800	2025787	1GHz~18GHz	Feb. 13, 2017	Jan. 08, 2018 ~ Jan. 19, 2018	Feb. 12, 2018	Radiation (03CH11-HY)



5 Uncertainty of Evaluation

Uncertainty of Radiated Emission Measurement (30 MHz ~ 1000 MHz)

Measuring Uncertainty for a Level of Confidence of 95% ($U = 2Uc(y)$)	5.20
---	------

Uncertainty of Radiated Emission Measurement (1000 MHz ~ 18000 MHz)

Measuring Uncertainty for a Level of Confidence of 95% ($U = 2Uc(y)$)	5.50
---	------

Uncertainty of Radiated Emission Measurement (18000 MHz ~ 40000 MHz)

Measuring Uncertainty for a Level of Confidence of 95% ($U = 2Uc(y)$)	5.20
---	------

Appendix A. Test Result of Conducted Test Items

Test Engineer:	White Lin/Reece Lin	Temperature:	21~25	°C
Test Date:	2018/01/05~2018/01/17	Relative Humidity:	51~54	%

TEST RESULTS DATA
Average Power Table

Band IV										
Mod.	Data Rate	NTX	CH.	Freq. (MHz)	Duty Factor (dB)	Average Conducted Power (dBm)	FCC Conducted Power Limit (dBm)	DG (dBi)		Pass/Fail
11a	6M bps	1	149	5745	0.59	15.98	30.00	-3.59		Pass
11a	6Mbps	1	157	5785	0.59	15.89	30.00	-3.59		Pass
11a	6Mbps	1	165	5825	0.59	15.87	30.00	-3.59		Pass
HT20	MCS 0	1	149	5745	0.63	10.92	30.00	-3.59		Pass
HT20	MCS 0	1	157	5785	0.63	10.87	30.00	-3.59		Pass
HT20	MCS 0	1	165	5825	0.63	10.91	30.00	-3.59		Pass
HT40	MCS 0	1	151	5755	0.59	9.93	30.00	-3.59		Pass
HT40	MCS 0	1	159	5795	0.59	9.73	30.00	-3.59		Pass



Appendix B. Radiated Spurious Emission

Test Engineer :	Hao Hsu, Jacky Hung, and Ken Wu	Temperature :	23~26°C
		Relative Humidity :	50~55%

Band 4 - 5725~5850MHz

WIFI 802.11a (Band Edge @ 3m)

WIFI	Note	Frequency (MHz)	Level (dBμV/m)	Over Limit (dB)	Limit Line (dBμV/m)	Read Level (dBμV)	Antenna Factor (dB/m)	Cable Loss (dB)	Preamp Factor (dB)	Ant Pos (cm)	Table Pos (deg)	Peak Avg. (P/A)	Pol. (H/V)	
802.11a CH 149 5745MHz		5644.6	49.3	-18.9	68.2	40.44	32.35	9.61	33.1	189	61	P	H	
		5699.8	53.2	-51.85	105.05	44.13	32.44	9.75	33.12	189	61	P	H	
		5719.6	62.32	-48.37	110.69	53.14	32.5	9.81	33.13	189	61	P	H	
		5723.8	73.76	-45.7	119.46	64.58	32.5	9.81	33.13	189	61	P	H	
	*	5745	110.48	-	-	101.22	32.53	9.88	33.15	189	61	P	H	
	*	5745	101.66	-	-	92.4	32.53	9.88	33.15	189	61	A	H	
														H
														H
			5612.4	50.5	-17.7	68.2	41.74	32.29	9.55	33.08	298	93	P	V
			5692.2	50.88	-48.57	99.45	41.81	32.44	9.75	33.12	298	93	P	V
			5719.4	57.92	-52.71	110.63	48.74	32.5	9.81	33.13	298	93	P	V
			5725	72.42	-49.78	122.2	63.24	32.5	9.81	33.13	298	93	P	V
	*		5745	107.06	-	-	97.8	32.53	9.88	33.15	298	93	P	V
	*		5745	98.66	-	-	89.4	32.53	9.88	33.15	298	93	A	V
														V
														V



Band 4 5725~5850MHz

WIFI 802.11a (Harmonic @ 3m)

WIFI	Note	Frequency (MHz)	Level (dBμV/m)	Over Limit (dB)	Limit Line (dBμV/m)	Read Level (dBμV)	Antenna Factor (dB/m)	Cable Loss (dB)	Preamp Factor (dB)	Ant Pos (cm)	Table Pos (deg)	Peak Avg. (P/A)	Pol. (H/V)	
802.11a CH 149 5745MHz		11490	48.42	-25.58	74	58.09	40	15.44	65.39	100	0	P	H	
		17235	47.71	-20.49	68.2	51.84	40.54	19.24	64.27	100	0	P	H	
													H	
													H	
			11490	51.51	-22.49	74	61.18	40	15.44	65.39	103	4	P	V
			11490	46.76	-7.24	54	56.43	40	15.44	65.39	103	4	A	V
			17235	47.32	-20.88	68.2	51.45	40.54	19.24	64.27	100	0	P	V
														V
Remark	1. No other spurious found. 2. All results are PASS against Peak and Average limit line.													



Emission below 1GHz
5GHz WIFI 802.11a (LF @ 3m)

WIFI	Note	Frequency	Level	Over	Limit	Read	Antenna	Cable	Preamp	Ant	Table	Peak	Pol.	
		(MHz)	(dBμV/m)	(dB)	(dBμV/m)	(dBμV)	(dB/m)	(dB)	(dB)	(cm)	(deg)	(P/A)	(H/V)	
5GHz 802.11a LF		40.8	23.59	-16.41	40	36.57	18.68	0.82	32.49	-	-	P	H	
		52.68	30.47	-9.53	40	48.59	13.34	1.02	32.49	100	223	P	H	
		122.88	22.29	-21.21	43.5	35.94	17.26	1.51	32.46	-	-	P	H	
		456.8	24.54	-21.46	46	31.06	23.1	2.7	32.36	-	-	P	H	
		731.9	29.25	-16.75	46	30.71	27.39	3.4	32.38	-	-	P	H	
		947.5	33.62	-12.38	46	30.4	30.46	3.82	31.23	-	-	P	H	
													H	
													H	
													H	
													H	
													H	
													H	
			39.18	28.24	-11.76	40	40.16	19.74	0.82	32.49	-	-	P	V
			52.41	32.23	-7.77	40	50.35	13.34	1.02	32.49	100	191	P	V
			85.89	25.27	-14.73	40	42.52	13.99	1.22	32.48	-	-	P	V
			426	23.97	-22.03	46	31.04	22.59	2.63	32.34	-	-	P	V
			759.2	30.38	-15.62	46	31.2	27.9	3.44	32.3	-	-	P	V
			958.7	33.62	-12.38	46	29.64	31.02	3.9	31.12	-	-	P	V
														V
														V
													V	
													V	
													V	
													V	
Remark	1. No other spurious found. 2. All results are PASS against limit line.													



Note symbol

*	Fundamental Frequency which can be ignored. However, the level of any unwanted emissions shall not exceed the level of the fundamental frequency.
!	Test result is over limit line.
P/A	Peak or Average
H/V	Horizontal or Vertical



A calculation example for radiated spurious emission is shown as below:

WIFI	Note	Frequency	Level	Over	Limit	Read	Antenna	Cable	Preamp	Ant	Table	Peak	Pol.
Ant.				Limit	Line	Level	Factor	Loss	Factor	Pos	Pos	Avg.	
1		(MHz)	(dBμV/m)	(dB)	(dBμV/m)	(dBμV)	(dB/m)	(dB)	(dB)	(cm)	(deg)	(P/A)	(H/V)
802.11b		2390	55.45	-18.55	74	54.51	32.22	4.58	35.86	103	308	P	H
CH 01													
2412MHz		2390	43.54	-10.46	54	42.6	32.22	4.58	35.86	103	308	A	H

- Level(dBμV/m) =
Antenna Factor(dB/m) + Cable Loss(dB) + Read Level(dBμV) - Preamp Factor(dB)
- Over Limit(dB) = Level(dBμV/m) – Limit Line(dBμV/m)

For Peak Limit @ 2390MHz:

- Level(dBμV/m)
= Antenna Factor(dB/m) + Cable Loss(dB) + Read Level(dBμV) - Preamp Factor(dB)
= 32.22(dB/m) + 4.58(dB) + 54.51(dBμV) – 35.86 (dB)
= 55.45 (dBμV/m)
- Over Limit(dB)
= Level(dBμV/m) – Limit Line(dBμV/m)
= 55.45(dBμV/m) – 74(dBμV/m)
= -18.55(dB)

For Average Limit @ 2390MHz:

- Level(dBμV/m)
= Antenna Factor(dB/m) + Cable Loss(dB) + Read Level(dBμV) - Preamp Factor(dB)
= 32.22(dB/m) + 4.58(dB) + 42.6(dBμV) – 35.86 (dB)
= 43.54 (dBμV/m)
- Over Limit(dB)
= Level(dBμV/m) – Limit Line(dBμV/m)
= 43.54(dBμV/m) – 54(dBμV/m)
= -10.46(dB)

Both peak and average measured complies with the limit line, so test result is “PASS”.



Appendix C. Radiated Spurious Emission Plots

Test Engineer :	Hao Hsu, Jacky Hung, and Ken Wu	Temperature :	23~26°C
		Relative Humidity :	50~55%

Note symbol

-L	Low channel location
-R	High channel location

Band 4 - 5725~5850MHz
WIFI 802.11a (Band Edge @ 3m)

WIFI	Band 4 5725~5850MHz Band Edge @ 3m	
	802.11a CH149 5745MHz	
	Horizontal	Fundamental
Peak	<p>Site : 03CH11-HY Condition : PEAK_BE(84)_16-24 3m HORN 9120D-HF HORIZONTAL Detector : Peak Project : 7D2018-02 Setting : B/-1</p>	<p>Site : 03CH11-HY Condition : PEAK(LINII) 3m HORN 9120D-HF HORIZONTAL Detector : Peak Project : 7D2018-02 Setting : B/-1</p>

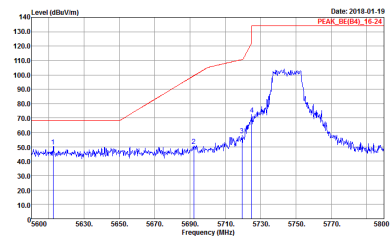
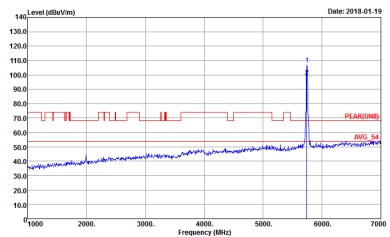

WIFI	Band 4 5725~5850MHz Band Edge @ 3m	
802.11a CH149 5745MHz		
Vertical		Fundamental
Peak	 <p>Date: 2018-01-19 PEAK_BE[04]_16-24</p> <p>Site : 03CH11-14Y Condition : PEAK_BE[04]_16-24 3m HORN 9120D-HF VERTICAL RBW:1000.000KHz VBW:3000.000KHz SWT:Auto Detector : Peak Project : 7D2018-02 Setting : 8/0</p>	 <p>Date: 2018-01-19 PEAKUNB</p> <p>Site : 03CH11-14Y Condition : PEAKUNB[1] 3m HORN 9120D-HF VERTICAL RBW:1000.000KHz VBW:3000.000KHz SWT:Auto Detector : Peak Project : 7D2018-02 Setting : 8/0</p>



Band 4 - 5725~5850MHz
WIFI 802.11a (Harmonic @ 3m)

Table with 2 columns: Horizontal and Vertical. Each column contains a spectral plot showing Level (dBuV/m) vs Frequency (MHz) with peak and average markers. Includes site and condition details for both orientations.



Emission below 1GHz

5GHz WIFI 802.11a (LF)

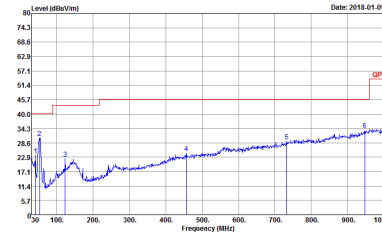
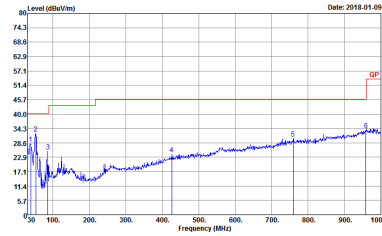
WIFI	5GHz 5725~5850MHz	
	802.11a LF	
	Horizontal	Vertical
<p>QP / Peak</p>	 <p>Site : 03CH11-HY Condition : QP 3m BE-LOG 6111D_LF_ETC HORIZONTAL Detector : Peak Project : 7D2018-02</p>	 <p>Site : 03CH11-HY Condition : QP 3m BE-LOG 6111D_LF_ETC VERTICAL Detector : Peak Project : 7D2018-02</p>



Appendix D. Duty Cycle Plots

Band	Duty Cycle (%)	T(us)	1/T(kHz)	VBW Setting
5GHz 802.11a	87.26	1370.00	0.73	1kHz

802.11a

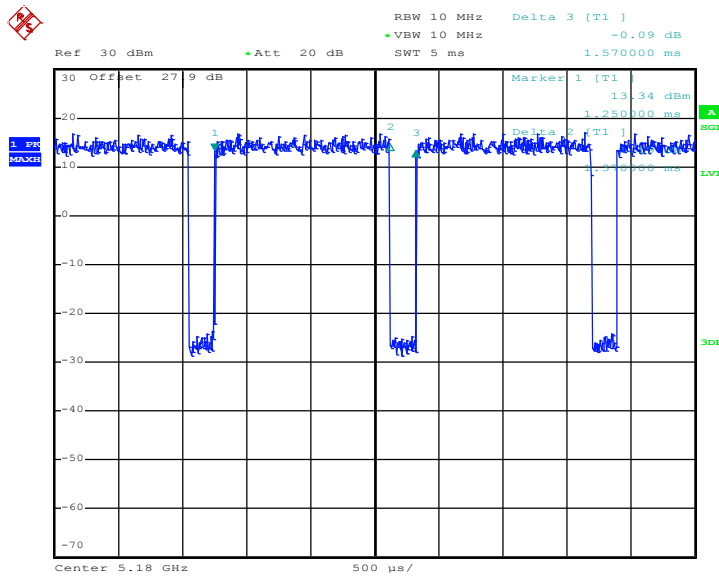

Date: 5.JAN.2018 14:40:27



Appendix E. Original Report

Please refer to Sporton report number FR7D2018E.