



# FCC RF Test Report

**APPLICANT** : Motorola Mobility LLC  
**EQUIPMENT** : Mobile Cellular Phone  
**BRAND NAME** : Motorola  
**MODEL NAME** : XT1921-5, XT1921-3  
**FCC ID** : IHDT56XC2  
**STANDARD** : FCC Part 15 Subpart C §15.247  
**CLASSIFICATION** : (DTS) Digital Transmission System

The product was received on Dec. 20, 2017 and testing was completed on Jan. 03, 2018. We, SPORTON INTERNATIONAL INC., would like to declare that the tested sample has been evaluated in accordance with the test procedures and has been in compliance with the applicable technical standards.

The test results in this report apply exclusively to the tested model / sample. Without written approval of SPORTON INTERNATIONAL INC., the test report shall not be reproduced except in full.

Reviewed by: Joseph Lin / Supervisor

Approved by: Jones Tsai / Manager



## **SPORTON INTERNATIONAL INC.**

**No. 52, Hwa Ya 1<sup>st</sup> Rd., Hwa Ya Technology Park, Kwei-Shan District, Tao Yuan City, Taiwan, R.O.C.**



# TABLE OF CONTENTS

**REVISION HISTORY.....3**

**SUMMARY OF TEST RESULT .....4**

**1 GENERAL DESCRIPTION.....5**

    1.1 Applicant .....5

    1.2 Manufacturer.....5

    1.3 Product Feature of Equipment Under Test.....5

    1.4 Product Specification of Equipment Under Test.....6

    1.5 Modification of EUT .....6

    1.6 Testing Location .....6

    1.7 Applicable Standards.....7

**2 TEST CONFIGURATION OF EQUIPMENT UNDER TEST.....8**

    2.1 Carrier Frequency Channel .....8

    2.2 Test Mode.....9

    2.3 Connection Diagram of Test System.....10

    2.4 Support Unit used in test configuration and system .....11

    2.5 EUT Operation Test Setup .....11

    2.6 Measurement Results Explanation Example.....11

**3 TEST RESULT .....12**

    3.1 6dB and 99% Bandwidth Measurement .....12

    3.2 Output Power Measurement.....17

    3.3 Power Spectral Density Measurement .....18

    3.4 Conducted Band Edges and Spurious Emission Measurement .....23

    3.5 Radiated Band Edges and Spurious Emission Measurement .....28

    3.6 AC Conducted Emission Measurement.....32

    3.7 Antenna Requirements.....34

**4 LIST OF MEASURING EQUIPMENT.....35**

**5 UNCERTAINTY OF EVALUATION.....36**

**APPENDIX A. CONDUCTED TEST RESULTS**

**APPENDIX B. AC CONDUCTED EMISSION TEST RESULT**

**APPENDIX C. RADIATED SPURIOUS EMISSION**

**APPENDIX D. RADIATED SPURIOUS EMISSION PLOTS**

**APPENDIX E. DUTY CYCLE PLOTS**





### SUMMARY OF TEST RESULT

Report Section	FCC Rule	Description	Limit	Result	Remark
3.1	15.247(a)(2)	6dB Bandwidth	$\geq 0.5\text{MHz}$	Pass	-
3.1	-	99% Bandwidth	-	Pass	-
3.2	15.247(b)(3)	Peak Output Power	$\leq 30\text{dBm}$	Pass	-
3.3	15.247(e)	Power Spectral Density	$\leq 8\text{dBm}/3\text{kHz}$	Pass	-
3.4	15.247(d)	Conducted Band Edges and Spurious Emission	$\leq 20\text{dBc}$	Pass	-
3.5	15.247(d)	Radiated Band Edges and Spurious Emission	15.209(a) & 15.247(d)	Pass	Under limit 3.73 dB at 31.350 MHz
3.6	15.207	AC Conducted Emission	15.207(a)	Pass	Under limit 17.00 dB at 0.150 MHz
3.7	15.203 & 15.247(b)	Antenna Requirement	N/A	Pass	-



# 1 General Description

## 1.1 Applicant

Motorola Mobility LLC  
222 W. Merchandise Mart Plaza, Chicago IL 60654, USA

## 1.2 Manufacturer

Motorola Mobility LLC  
222 W. Merchandise Mart Plaza, Chicago IL 60654, USA

## 1.3 Product Feature of Equipment Under Test

Product Feature	
Equipment	Mobile Cellular Phone
Brand Name	Motorola
Model Name	XT1921-5, XT1921-3
FCC ID	IHDT56XC2
IMEI Code	990005440074244 (for Radiation) 990005440016179 (for Conduction)
EUT supports Radios application	CDMA/EV-DO/GSM/EGPRS/WCDMA/HSPA/LTE/FM/GNSS WLAN 11b/g/n HT20 WLAN 11a/n HT20/HT40 Bluetooth BR/EDR/LE
HW Version	DVT1B
EUT Stage	Identical Prototype

Remark: The above EUT's information was declared by manufacturer. Please refer to the specifications or user's manual for more detailed description.

Accessory List	
AC Adapter 1	Brand Name : Motorola
	Model Name : C-P35
AC Adapter 2	Brand Name : Motorola
	Model Name : SSW-2919UMTJ C-P35 SPN5945A
AC Adapter 3	Brand Name : Motorola
	Model Name : C-P56
AC Adapter 4	Brand Name : Motorola
	Model Name : C-P56
Battery	Brand Name : Motorola
	Model Name : GK40
USB Cable	Brand Name : Saibao
	Model Name : SWT-A083A



### 1.4 Product Specification of Equipment Under Test

Standards-related Product Specification	
Tx/Rx Frequency Range	2402 MHz ~ 2480 MHz
Number of Channels	40
Carrier Frequency of Each Channel	40 Channel(37 hopping + 3 advertising channel)
Maximum Output Power to Antenna	3.35 dBm (0.0022 W)
99% Occupied Bandwidth	1.058MHz
Antenna Type / Gain	PIFA Antenna type with gain -3.2 dBi
Type of Modulation	Bluetooth LE : GFSK

### 1.5 Modification of EUT

No modifications are made to the EUT during all test items.

### 1.6 Testing Location

Sporton Lab is accredited to ISO 17025 by Taiwan Accreditation Foundation (TAF code : 1190) and the FCC designation No. TW1190 and TW0007 under the FCC 2.948(e) by Mutual Recognition Agreement (MRA) in FCC Test.

Test Site	SPORTON INTERNATIONAL INC.	
Test Site Location	No. 52, Hwa Ya 1 <sup>st</sup> Rd., Hwa Ya Technology Park, Kwei-Shan District, Tao Yuan City, Taiwan, R.O.C. TEL: +886-3-327-3456 FAX: +886-3-328-4978	
Test Site No.	<b>Sporton Site No.</b>	
	TH05-HY	CO05-HY

**Note:** The test site complies with ANSI C63.4 2014 requirement.

Test Site	SPORTON INTERNATIONAL INC.	
Test Site Location	No.58, Aly. 75, Ln. 564, Wenhua 3rd Rd., Kwei-Shan District, Tao Yuan City, Taiwan R.O.C. TEL: +886-3-327-0868 FAX: +886-3-327-0855	
Test Site No.	<b>Sporton Site No. :</b>	
	03CH13-HY	

**Note:** The test site complies with ANSI C63.4 2014 requirement.



## 1.7 Applicable Standards

According to the specifications of the manufacturer, the EUT must comply with the requirements of the following standards:

- ♦ FCC Part 15 Subpart C §15.247
- ♦ FCC KDB Publication No. 558074 D01 DTS Meas. Guidance v04
- ♦ ANSI C63.10-2013

### **Remark:**

1. All test items were verified and recorded according to the standards and without any deviation during the test.
2. This EUT has also been tested and complied with the requirements of FCC Part 15, Subpart B, recorded in a separate test report.



## 2 Test Configuration of Equipment Under Test

### 2.1 Carrier Frequency Channel

Frequency Band	Channel	Freq. (MHz)	Channel	Freq. (MHz)
2400-2483.5 MHz	0	2402	21	2444
	1	2404	22	2446
	2	2406	23	2448
	3	2408	24	2450
	4	2410	25	2452
	5	2412	26	2454
	6	2414	27	2456
	7	2416	28	2458
	8	2418	29	2460
	9	2420	30	2462
	10	2422	31	2464
	11	2424	32	2466
	12	2426	33	2468
	13	2428	34	2470
	14	2430	35	2472
	15	2432	36	2474
	16	2434	37	2476
	17	2436	38	2478
	18	2438	39	2480
	19	2440	-	-
20	2442	-	-	



## 2.2 Test Mode

- a. The EUT has been associated with peripherals and configuration operated in a manner tended to maximize its emission characteristics in a typical application. Frequency range investigated: conduction (150 kHz to 30 MHz), radiation (9 kHz to the 10th harmonic of the highest fundamental frequency or to 40 GHz, whichever is lower). Pre-scanned tests, X, Y, Z in three orthogonal panels to determine the final configuration (Z plane as worst plane) from all possible combinations.
- b. AC power line Conducted Emission was tested under maximum output power.

The following summary table is showing all test modes to demonstrate in compliance with the standard.

Summary table of Test Cases	
Test Item	Data Rate / Modulation
	Bluetooth – LE / GFSK
Conducted TCs	Mode 1: Bluetooth Tx CH00_2402 MHz_1Mbps Mode 2: Bluetooth Tx CH19_2440 MHz_1Mbps Mode 3: Bluetooth Tx CH39_2480 MHz_1Mbps
Radiated TCs	Mode 1: Bluetooth Tx CH00_2402 MHz_1Mbps Mode 2: Bluetooth Tx CH19_2440 MHz_1Mbps Mode 3: Bluetooth Tx CH39_2480 MHz_1Mbps
AC Conducted Emission	Mode 1: GSM850 Idle + Bluetooth Link + WLAN (2.4GHz) Link + MP3 + SD Card + USB Cable (Charging from Adapter 1) + Earphone
<b>Remark:</b> All the radiated test cases were performance with Adapter 1.	

## 2.3 Connection Diagram of Test System

<Bluetooth-LE Tx Mode>

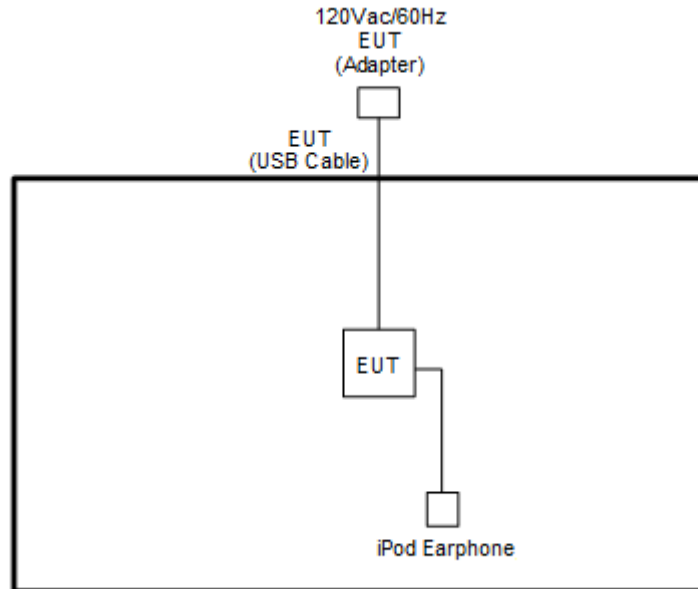

<AC Conducted Emission Mode>

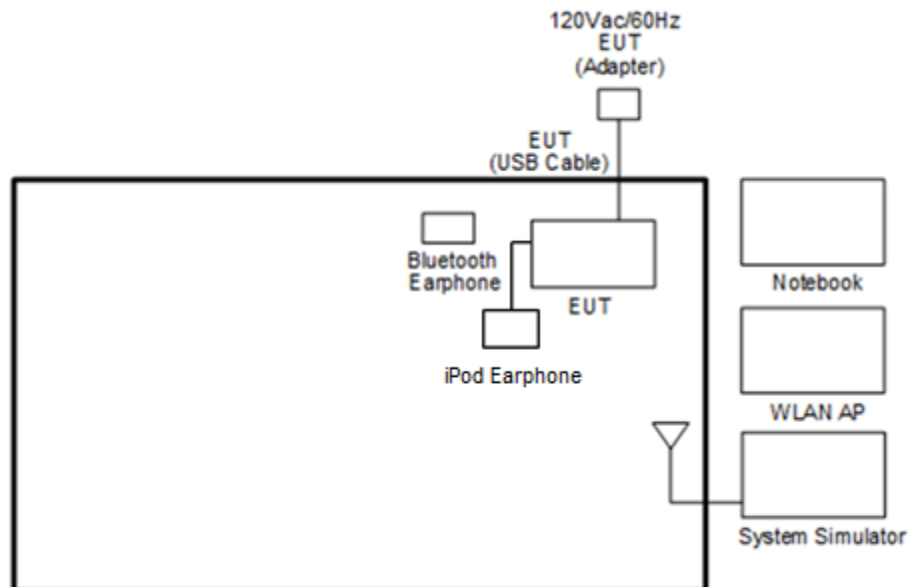



## 2.4 Support Unit used in test configuration and system

Item	Equipment	Trade Name	Model Name	FCC ID	Data Cable	Power Cord
1.	System Simulator	Anritsu	MT8820C	N/A	N/A	Unshielded, 1.8 m
2.	Bluetooth Earphone	Sony Ericsson	MW600	PY7DDA-2029	N/A	N/A
3.	WLAN AP	ASUS	RT-AC66U	MSQ-RTAC66U	N/A	Unshielded, 1.8m
4.	iPod Earphone	Apple	A1285	FCC DoC	Shielded, 1.0 m	N/A
5.	Notebook	DELL	Latitude E6320	FCC DoC/ Contains FCC ID: QDS-BRCM1054	N/A	AC I/P: Unshielded, 1.2 m DC O/P: Shielded, 1.8 m
6.	SD Card	SanDisk	MicroSD HC	FCC DoC	N/A	N/A

## 2.5 EUT Operation Test Setup

The RF test items, utility “QRCT” was installed in Notebook which was programmed in order to make the EUT get into the engineering modes to provide channel selection, power level, data rate and the application type and for continuous transmitting signals.

## 2.6 Measurement Results Explanation Example

For all conducted test items:

The offset level is set in the spectrum analyzer to compensate the RF cable loss and attenuator factor between EUT conducted output port and spectrum analyzer. With the offset compensation, the spectrum analyzer reading level is exactly the EUT RF output level.

Example :

The spectrum analyzer offset is derived from RF cable loss and attenuator factor.

*Offset = RF cable loss + attenuator factor.*

Following shows an offset computation example with cable loss 4.2 dB and 10dB attenuator.

$$\begin{aligned} \text{Offset(dB)} &= \text{RF cable loss(dB)} + \text{attenuator factor(dB)}. \\ &= 4.2 + 10 = 14.2 \text{ (dB)} \end{aligned}$$

### 3 Test Result

#### 3.1 6dB and 99% Bandwidth Measurement

##### 3.1.1 Limit of 6dB and 99% Bandwidth

The minimum 6 dB bandwidth shall be at least 500 kHz.

##### 3.1.2 Measuring Instruments

The section 4.0 of List of Measuring Equipment of this test report is used for test.

##### 3.1.3 Test Procedures

1. The testing follows FCC KDB Publication No. 558074 D01 DTS Meas. Guidance v04.
2. The RF output of EUT was connected to the spectrum analyzer by RF cable and attenuator. The path loss was compensated to the results for each measurement.
3. Set to the maximum power setting and enable the EUT transmit continuously.
4. Make the measurement with the spectrum analyzer's resolution bandwidth (RBW) = 100 kHz. Set the Video bandwidth (VBW) = 300 kHz. In order to make an accurate measurement. The 6 dB bandwidth must be greater than 500 kHz.
5. For 99% Bandwidth Measurement, the spectrum analyzer's resolution bandwidth (RBW) is set 30kHz and set the Video bandwidth (VBW) = 100kHz.
6. Measure and record the results in the test report.

##### 3.1.4 Test Setup

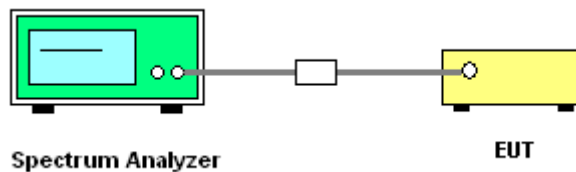



### 3.1.5 Test Result of 6dB Bandwidth

Please refer to Appendix A.

6 dB Bandwidth Plot on Channel 00

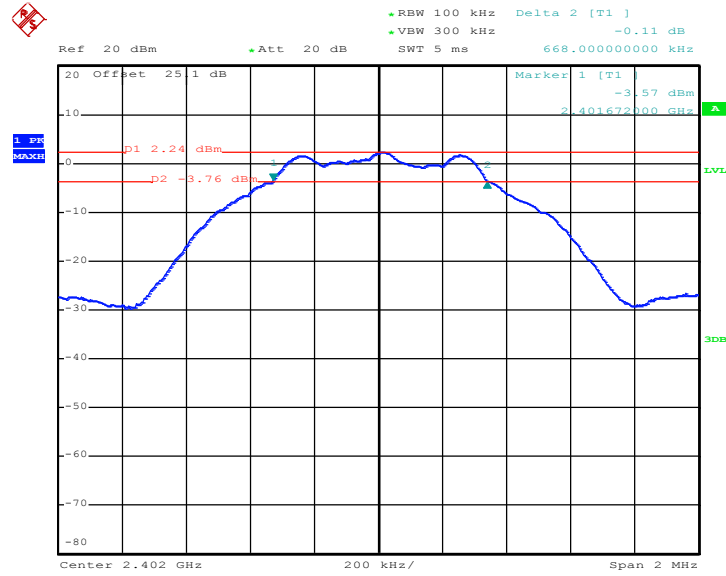

Date: 22.DEC.2017 22:44:43



6 dB Bandwidth Plot on Channel 19

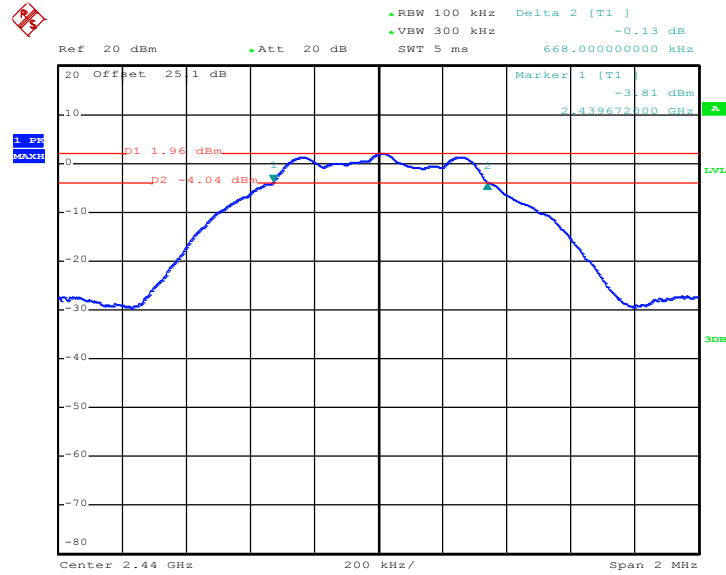

Date: 22.DEC.2017 22:51:26

6 dB Bandwidth Plot on Channel 39

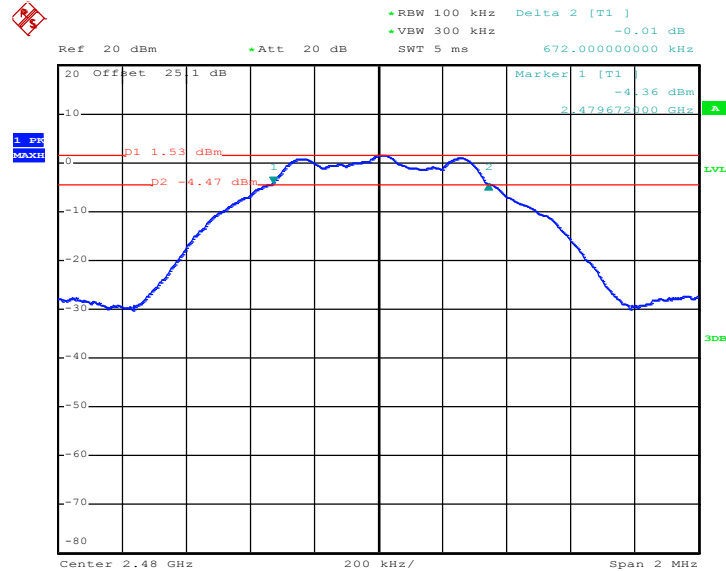

Date: 22.DEC.2017 22:54:14



### 3.1.6 Test Result of 99% Occupied Bandwidth

Please refer to Appendix A.

99% Bandwidth Plot on Channel 00

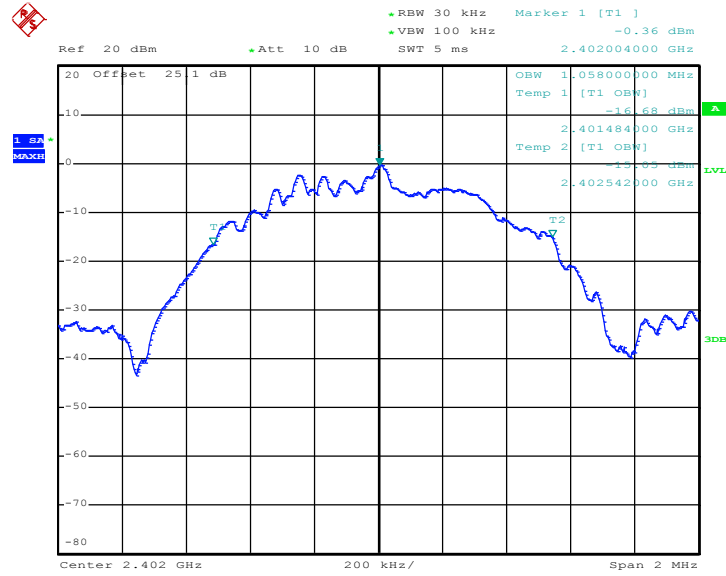

Date: 22.DEC.2017 22:48:28



99% Occupied Bandwidth Plot on Channel 19

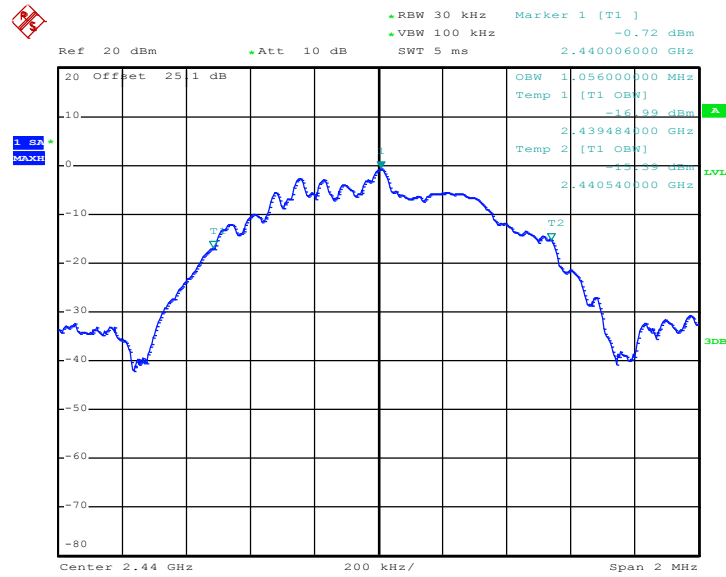

Date: 22.DEC.2017 22:53:03

99% Occupied Bandwidth Plot on Channel 39

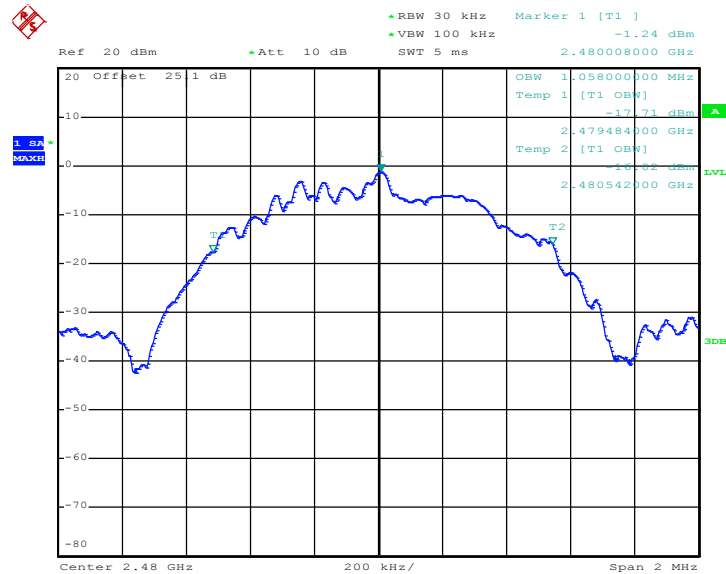

Date: 22.DEC.2017 22:56:02

Note : The occupied channel bandwidth is maintained within the band of operation for all of the modulations.

## 3.2 Output Power Measurement

### 3.2.1 Limit of Output Power

For systems using digital modulation in the 2400-2483.5MHz, the limit for peak output power is 30dBm. If transmitting antenna of directional gain greater than 6dBi is used, the peak output power from the intentional radiator shall be reduced below the above stated value by the amount in dB that the directional gain of the antenna exceeds 6 dBi. In case of point-to-point operation, the limit has to be reduced by 1dB for every 3dB that the directional gain of the antenna exceeds 6dBi.

### 3.2.2 Measuring Instruments

The section 4.0 of List of Measuring Equipment of this test report is used for test.

### 3.2.3 Test Procedures

1. The testing follows the Measurement Procedure of FCC KDB No. 558074 DTS D01 Meas. Guidance v04 section 9.1.3 PKPM1 Peak power meter method.
2. The RF output of EUT was connected to the power meter by RF cable and attenuator. The path loss was compensated to the results for each measurement.
3. Set to the maximum power setting and enable the EUT transmit continuously.
4. Measure the conducted output power and record the results in the test report.

### 3.2.4 Test Setup

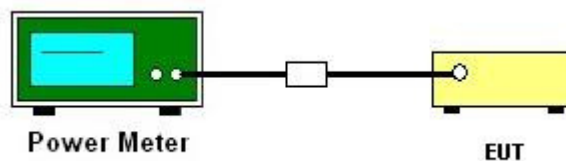

### 3.2.5 Test Result of Peak Output Power

Please refer to Appendix A.

### 3.2.6 Test Result of Average Output Power (Reporting Only)

Please refer to Appendix A.

### 3.3 Power Spectral Density Measurement

#### 3.3.1 Limit of Power Spectral Density

The peak power spectral density shall not be greater than 8dBm in any 3kHz band at any time interval of continuous transmission.

#### 3.3.2 Measuring Instruments

The section 4.0 of List of Measuring Equipment of this test report is used for test.

#### 3.3.3 Test Procedures

1. The testing follows Measurement Procedure 10.2 Method PKPSD of FCC KDB Publication No. 558074 D01 DTS Meas. Guidance v04
2. The RF output of EUT was connected to the spectrum analyzer by RF cable and attenuator. The path loss was compensated to the results for each measurement.
3. Set to the maximum power setting and enable the EUT transmit continuously.
4. Make the measurement with the spectrum analyzer's resolution bandwidth (RBW) = 3 kHz. Video bandwidth VBW = 10 kHz In order to make an accurate measurement, set the span to 1.5 times DTS Channel Bandwidth. (6dB BW)
5. Detector = peak, Sweep time = auto couple, Trace mode = max hold, Allow trace to fully stabilize. Use the peak marker function to determine the maximum power level.
6. Measure and record the results in the test report.
7. The Measured power density (dBm)/ 100kHz is a reference level and used as 20dBc down limit line for Conducted Band Edges and Conducted Spurious Emission.

#### 3.3.4 Test Setup

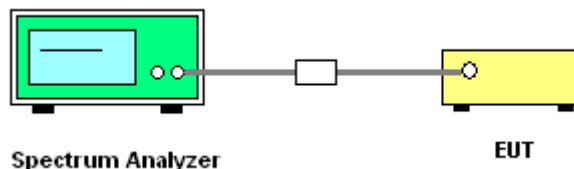

#### 3.3.5 Test Result of Power Spectral Density

Please refer to Appendix A.



### 3.3.6 Test Result of Power Spectral Density Plots (100kHz)

PSD 100kHz Plot on Channel 00

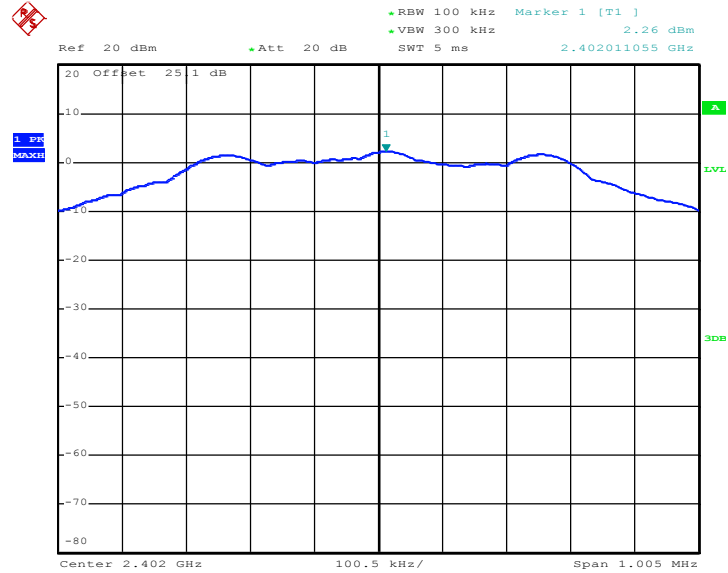

Date: 22.DEC.2017 22:46:05



PSD 100kHz Plot on Channel 19

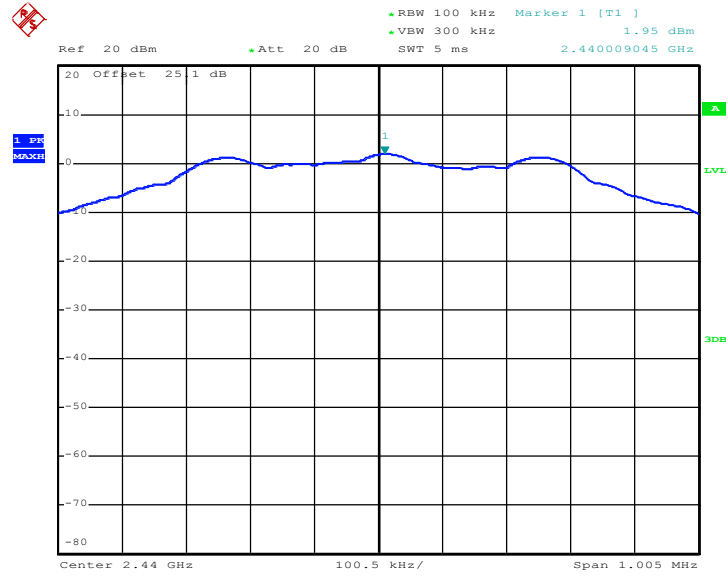

Date: 22.DEC.2017 22:52:19

PSD 100kHz Plot on Channel 39

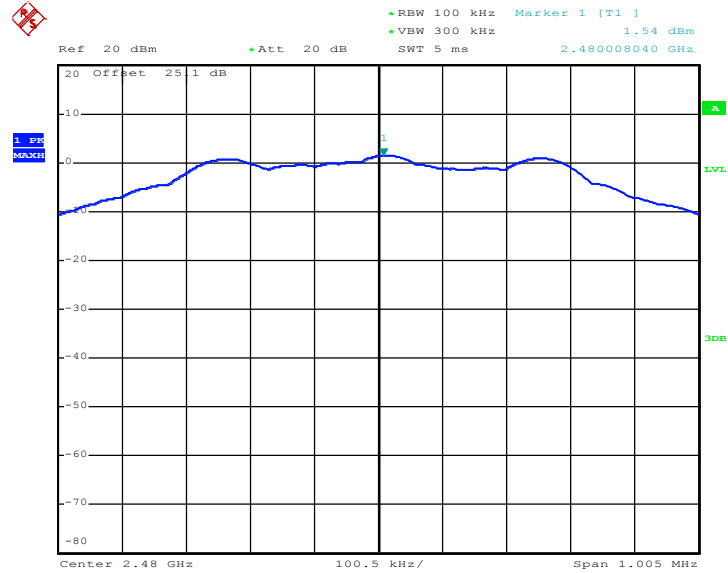

Date: 22.DEC.2017 22:55:01



### 3.3.7 Test Result of Power Spectral Density Plots (3kHz)

PSD 3kHz Plot on Channel 00

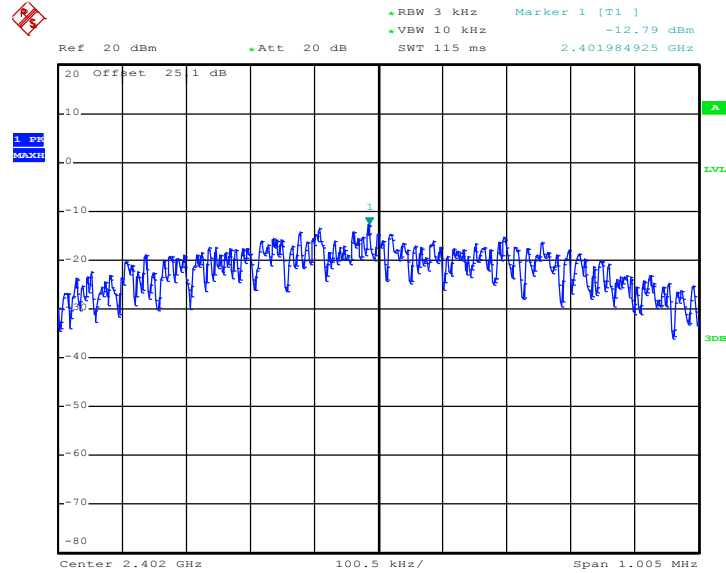

Date: 22.DEC.2017 22:45:27



PSD 3kHz Plot on Channel 19

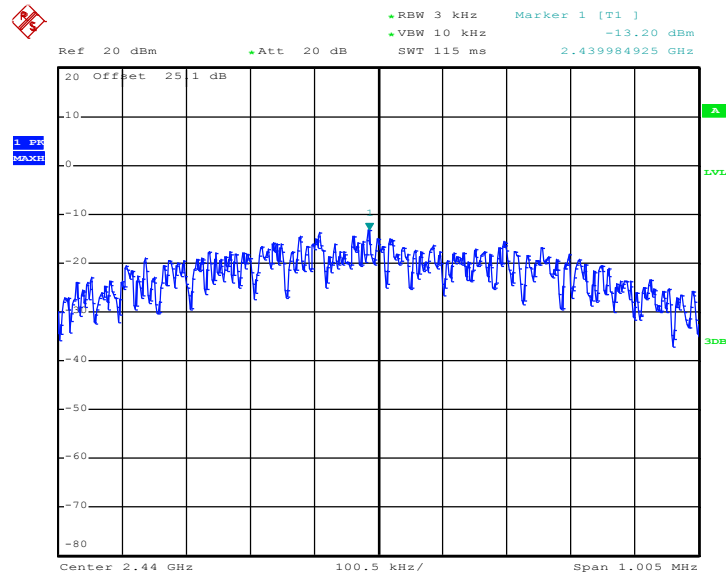

Date: 22.DEC.2017 22:51:55

PSD 3kHz Plot on Channel 39

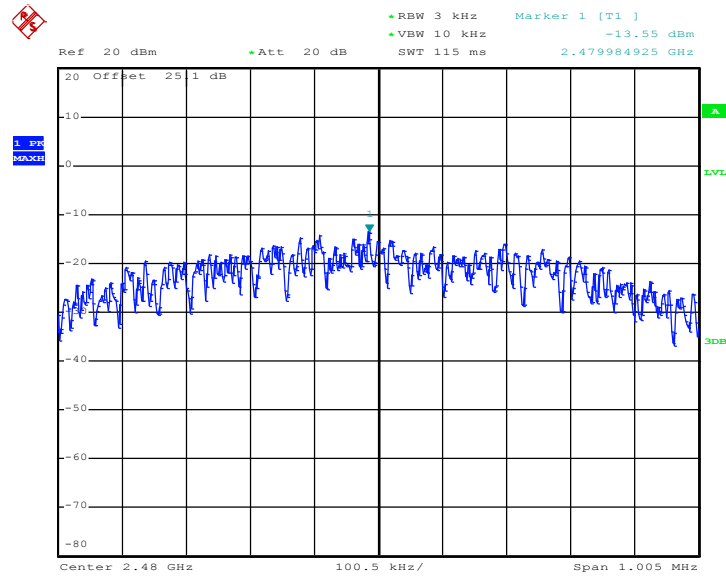

Date: 22.DEC.2017 22:54:41

### 3.4 Conducted Band Edges and Spurious Emission Measurement

#### 3.4.1 Limit of Conducted Band Edges and Spurious Emission

All harmonics/spurious must be at least 20 dB down from the highest emission level within the authorized band.

#### 3.4.2 Measuring Instruments

The section 4.0 of List of Measuring Equipment of this test report is used for test.

#### 3.4.3 Test Procedure

1. The testing follows FCC KDB Publication No. 558074 D01 DTS Meas. Guidance v04.
2. The RF output of EUT was connected to the spectrum analyzer by RF cable and attenuator. The path loss was compensated to the results for each measurement.
3. Set to the maximum power setting and enable the EUT transmit continuously.
4. Set RBW = 100 kHz, VBW=300 kHz, Peak Detector. Unwanted Emissions measured in any 100 kHz bandwidth outside of the authorized frequency band shall be attenuated by at least 20 dB relative to the maximum in-band peak PSD level in 100 kHz when maximum peak conducted output power procedure is used. If the transmitter complies with the conducted power limits based on the use of RMS averaging over a time interval, the attenuation required under this paragraph shall be 30 dB instead of 20 dB.
5. Measure and record the results in the test report.
6. The RF fundamental frequency should be excluded against the limit line in the operating frequency band.

#### 3.4.4 Test Setup

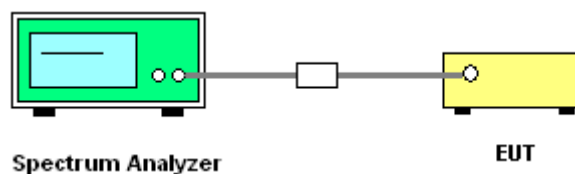



### 3.4.5 Test Result of Conducted Band Edges Plots

#### Low Band Edge Plot on Channel 00

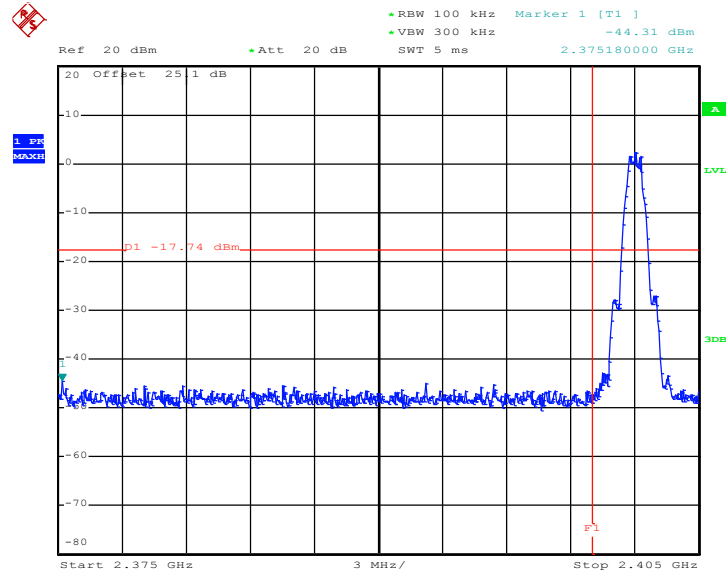

Date: 22.DEC.2017 22:46:31

#### High Band Edge Plot on Channel 39

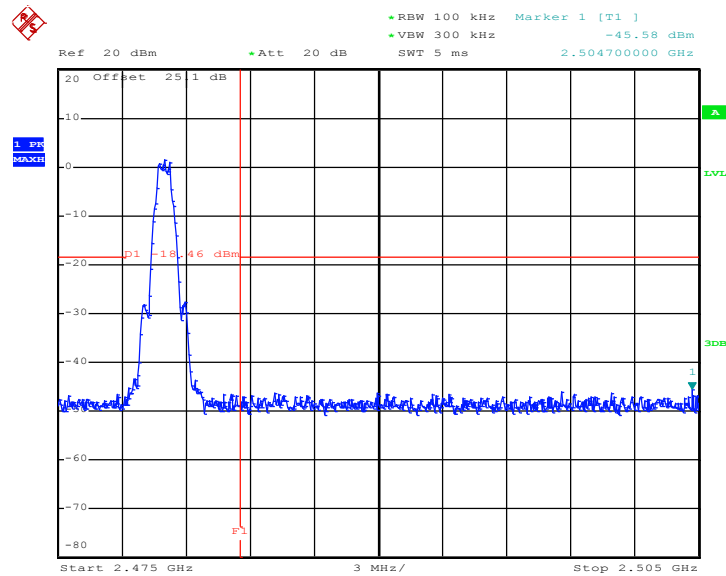

Date: 22.DEC.2017 22:55:16





### Conducted Spurious Emission Plot on Bluetooth LE 1Mbps GFSK Channel 19

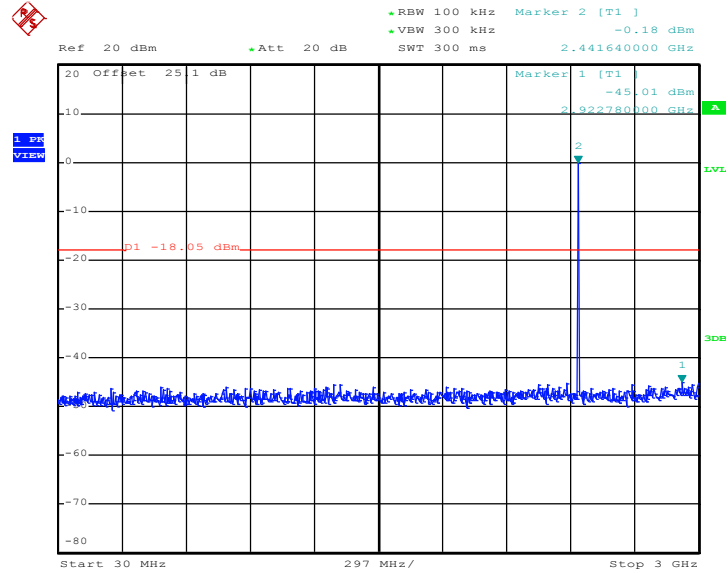

Date: 22.DEC.2017 22:52:31

### Conducted Spurious Emission Plot on Bluetooth LE 1Mbps GFSK Channel 19

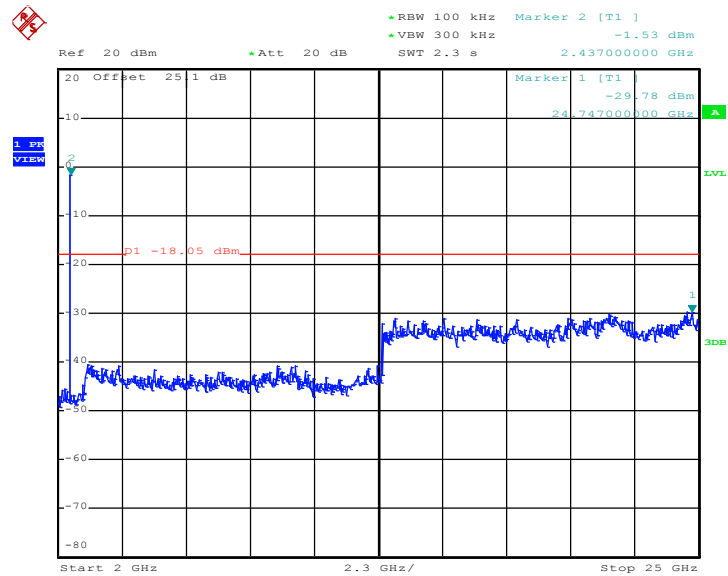

Date: 22.DEC.2017 22:52:40





### 3.5 Radiated Band Edges and Spurious Emission Measurement

#### 3.5.1 Limit of Radiated Band Edges and Spurious Emission

In any 100 kHz bandwidth outside the intentional radiator frequency band, all harmonics/spurious must be at least 20 dB below the highest emission level within the authorized band. If the output power of this device was measured by spectrum analyzer, the attenuation under this paragraph shall be 30 dB instead of 20 dB. In addition, radiated emissions which fall in the restricted bands must also comply with the limits as below.

Frequency (MHz)	Field Strength (microvolts/meter)	Measurement Distance (meters)
0.009 – 0.490	2400/F(kHz)	300
0.490 – 1.705	24000/F(kHz)	30
1.705 – 30.0	30	30
30 – 88	100	3
88 – 216	150	3
216 - 960	200	3
Above 960	500	3

#### 3.5.2 Measuring Instruments

The section 4.0 of List of Measuring Equipment of this test report is used for test.



### 3.5.3 Test Procedures

1. The testing follows FCC KDB Publication No. 558074 D01 DTS Meas. Guidance v04.
2. The EUT was arranged to its worst case and then tune the antenna tower (from 1 m to 4 m) and turntable (from 0 degree to 360 degrees) to find the maximum reading. A pre-amp and a high pass filter are used for the test in order to get better signal level.
3. The EUT was placed on a turntable with 0.8 meter for frequency below 1GHz and 1.5 meter for frequency above 1GHz respectively above ground.
4. The EUT was set 3 meters from the interference receiving antenna, which was mounted on the top of a variable height antenna tower.
5. Corrected Reading: Antenna Factor + Cable Loss + Read Level - Preamp Factor = Level
6. For testing below 1GHz, if the emission level of the EUT in peak mode was 3 dB lower than the limit specified, then peak values of EUT will be reported, otherwise, the emissions will be repeated one by one using the CISPR quasi-peak method and reported.
7. For testing above 1GHz, the emission level of the EUT in peak mode was 20dB lower than average limit (that means the emission level in average mode also complies with the limit in average mode), then peak values of EUT will be reported, otherwise, the emissions will be measured in average mode again and reported.
8. Use the following spectrum analyzer settings:
  - (1) Span shall wide enough to fully capture the emission being measured;
  - (2) Set RBW=100 kHz for  $f < 1$  GHz; VBW  $\geq$  RBW; Sweep = auto; Detector function = peak; Trace = max hold;
  - (3) Set RBW = 1 MHz, VBW= 3MHz for  $f \geq 1$  GHz for peak measurement.  
For average measurement:
    - VBW = 10 Hz, when duty cycle is no less than 98 percent.
    - VBW  $\geq 1/T$ , when duty cycle is less than 98 percent where T is the minimum transmission duration over which the transmitter is on and is transmitting at its maximum power control level for the tested mode of operation.

### 3.5.4 Test Setup

For radiated emissions below 30MHz

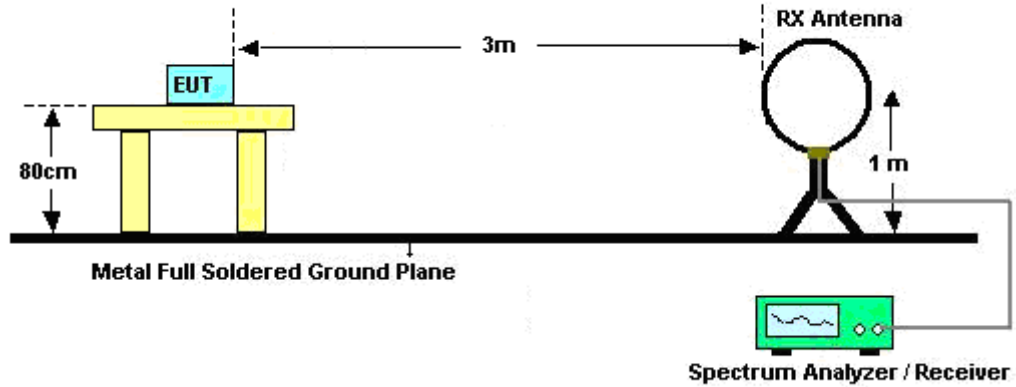

For radiated emissions from 30MHz to 1GHz

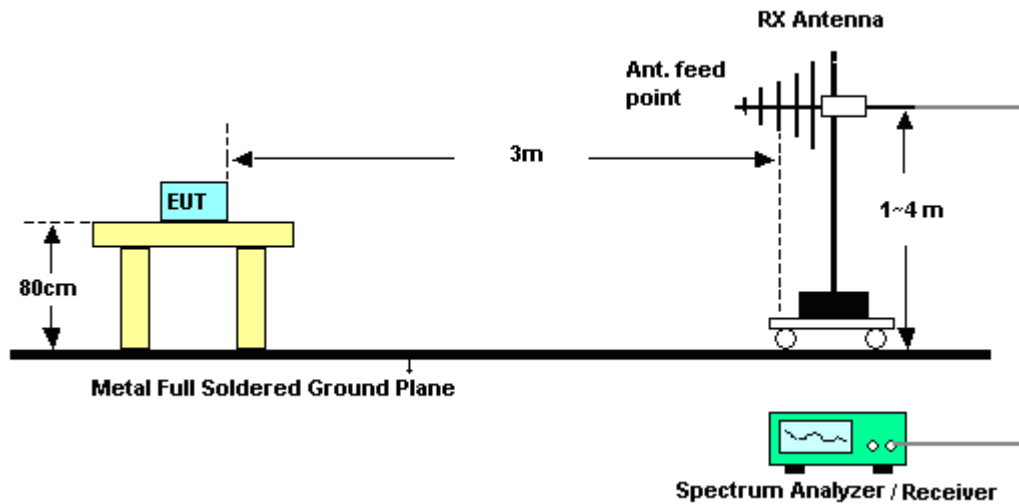

For radiated emissions above 1GHz

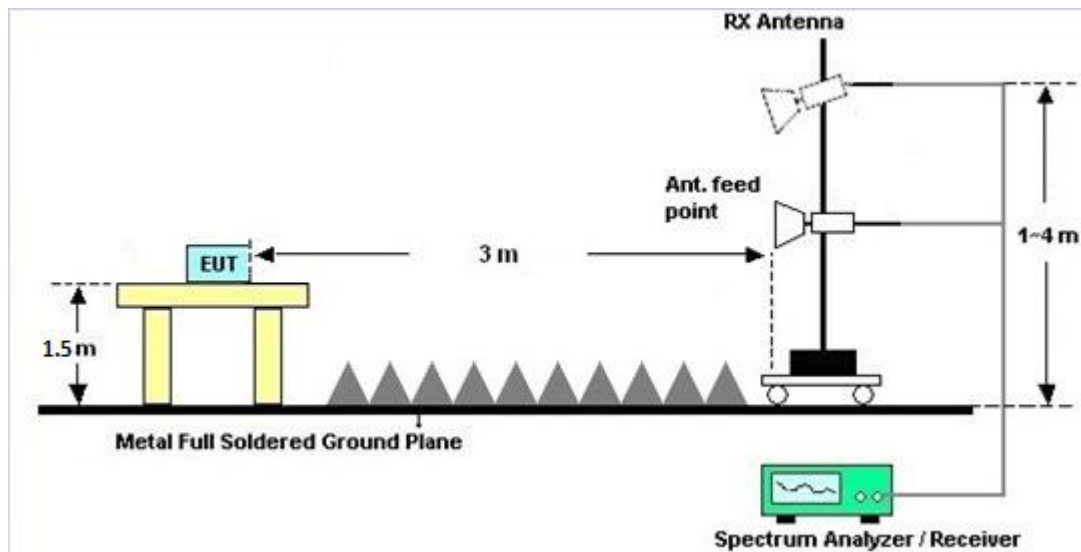

### 3.5.5 Test Results of Radiated Spurious Emissions (9 kHz ~ 30 MHz)

The low frequency, which started from 9 kHz to 30MHz, was pre-scanned and the result which was 20dB lower than the limit line was not reported.

There is a comparison data of both open-field test site and semi-Anechoic chamber, and the result came out very similar.

### 3.5.6 Test Result of Radiated Spurious at Band Edges

Please refer to Appendix C and D.

### 3.5.7 Duty Cycle

Please refer to Appendix E.

### 3.5.8 Test Result of Radiated Spurious Emission (30MHz ~ 10th Harmonic)

Please refer to Appendix C and D.



### 3.6 AC Conducted Emission Measurement

#### 3.6.1 Limit of AC Conducted Emission

For equipment that is designed to be connected to the public utility (AC) power line, the radio frequency voltage that is conducted back onto the AC power line on any frequency or frequencies within the band 150 kHz to 30 MHz shall not exceed the limits in the following table.

Frequency of emission (MHz)	Conducted limit (dBµV)	
	Quasi-peak	Average
0.15-0.5	66 to 56*	56 to 46*
0.5-5	56	46
5-30	60	50

\*Decreases with the logarithm of the frequency.

#### 3.6.2 Measuring Instruments

The section 4.0 of List of Measuring Equipment of this test report is used for test.

#### 3.6.3 Test Procedures

1. The EUT was placed 0.4 meter from the conducting wall of the shielding room was kept at least 80 centimeters from any other grounded conducting surface.
2. Connect EUT to the power mains through a line impedance stabilization network (LISN).
3. All the support units are connecting to the other LISN.
4. The LISN provides 50 ohm coupling impedance for the measuring instrument.
5. The FCC states that a 50 ohm, 50 microhenry LISN should be used.
6. Both sides of AC line were checked for maximum conducted interference.
7. The frequency range from 150 kHz to 30 MHz was searched.
8. Set the test-receiver system to Peak Detect Function and specified bandwidth (IF Bandwidth = 9kHz) with Maximum Hold Mode. Then measurement is also conducted by Average Detector and Quasi-Peak Detector Function respectively.

### 3.6.4 Test Setup

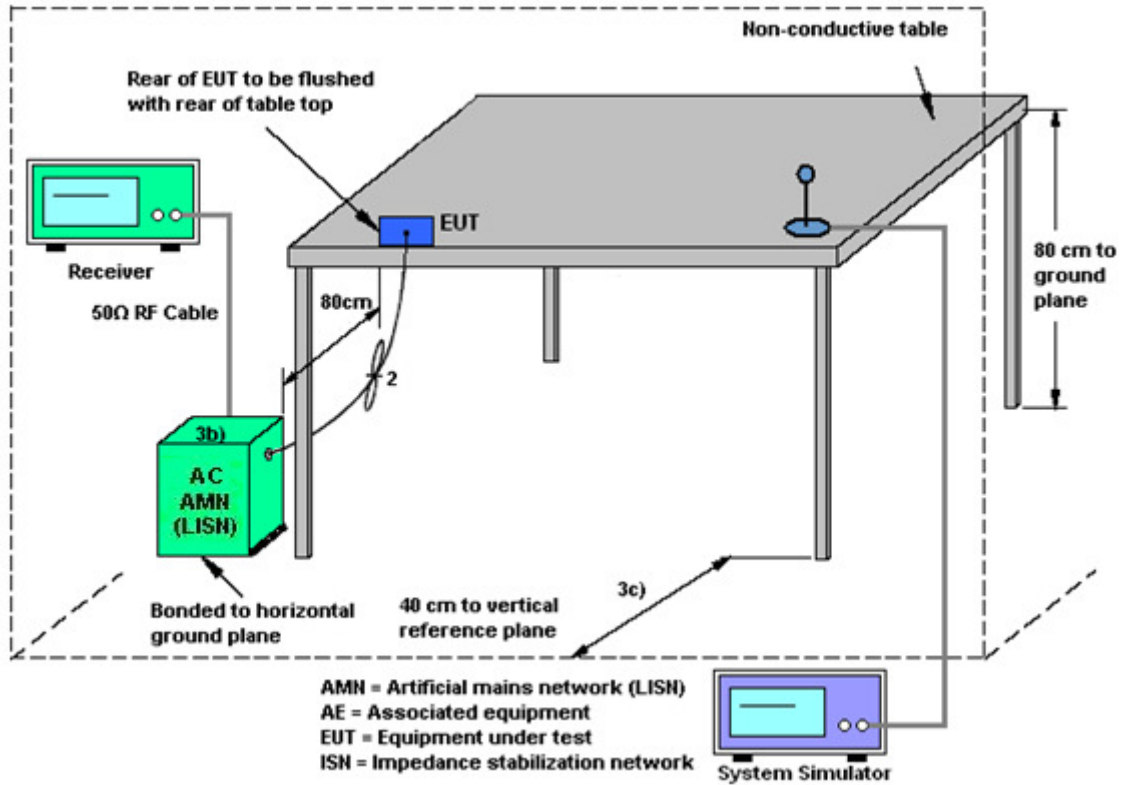

### 3.6.5 Test Result of AC Conducted Emission

Please refer to Appendix B.



## **3.7 Antenna Requirements**

### **3.7.1 Standard Applicable**

If directional gain of transmitting antennas is greater than 6dBi, the power shall be reduced by the same level in dB comparing to gain minus 6dBi. The use of a permanently attached antenna or of an antenna that uses a unique coupling to the intentional radiator shall be considered sufficient to comply with the rule.

### **3.7.2 Antenna Anti-Replacement Construction**

An embedded-in antenna design is used.

### **3.7.3 Antenna Gain**

The antenna peak gain of EUT is less than 6 dBi. Therefore, it is not necessary to reduce maximum peak output power limit.



## 4 List of Measuring Equipment

Instrument	Manufacturer	Model No.	Serial No.	Characteristics	Calibration Date	Test Date	Due Date	Remark
Power Meter	Anritsu	ML2495A	0932001	N/A	Sep. 26, 2017	Dec. 21, 2017~ Dec. 22, 2017	Sep. 25, 2018	Conducted (TH05-HY)
Power Sensor	Anritsu	MA2411B	0846202	300MHz~40GHz	Sep. 26, 2017	Dec. 21, 2017~ Dec. 22, 2017	Sep. 25, 2018	Conducted (TH05-HY)
Spectrum Analyzer	Rohde & Schwarz	FSP30	101067	9kHz ~ 30GHz	Nov. 13, 2017	Dec. 21, 2017~ Dec. 22, 2017	Nov. 12, 2018	Conducted (TH05-HY)
AC Power Source	ChainTek	APC-1000W	N/A	N/A	N/A	Dec. 29, 2017	N/A	Conduction (CO05-HY)
EMI Test Receiver	Rohde & Schwarz	ESCI 7	100724	9kHz~7GHz	Sep. 20, 2017	Dec. 29, 2017	Sep. 19, 2018	Conduction (CO05-HY)
LISN	Rohde & Schwarz	ENV216	100080	9kHz~30MHz	Nov. 30, 2017	Dec. 29, 2017	Nov. 29, 2018	Conduction (CO05-HY)
Loop Antenna	Rohde & Schwarz	HFH2-Z2	100315	9 kHz~30 MHz	May 15, 2017	Dec. 30, 2017~ Jan. 03, 2018	May 14, 2019	Radiation (03CH13-HY)
Amplifier	MITEQ	TTA1840-35-HG	1871923	18GHz~40GHz,V SWR : 2.5:1 max	Jul. 18, 2017	Dec. 30, 2017~ Jan. 03, 2018	Jul. 17, 2018	Radiation (03CH13-HY)
Amplifier	Sonoma-Instrument	310 N	187282	9KHz~1GHz	Dec. 21, 2016	Dec. 30, 2017~ Jan. 03, 2018	Dec. 20, 2018	Radiation (03CH13-HY)
Bilog Antenna	TESEQ	CBL 6111D&00800 N1D01N-06	40103&04	30MHz to 1GHz	Jan. 07, 2017	Dec. 30, 2017~ Jan. 03, 2018	Jan. 06, 2018	Radiation (03CH13-HY)
Horn Antenna	SCHWARZBECK	BBHA 9120 D	9120D-1241	1GHz ~ 18GHz	Jun. 15, 2017	Dec. 30, 2017~ Jan. 03, 2018	Jun. 14, 2018	Radiation (03CH13-HY)
Preamplifier	MITEQ	AMF-7D-0010 1800-30-10P	1590074	1GHz~18GHz	May 22, 2017	Dec. 30, 2017~ Jan. 03, 2018	May 21, 2018	Radiation (03CH13-HY)
Preamplifier	Keysight	83017A	MY53270147	1GHz~26.5GHz	Jan. 09, 2017	Dec. 30, 2017~ Jan. 03, 2018	Jan. 08, 2018	Radiation (03CH13-HY)
Spectrum Analyzer	Keysight	N9010A	MY55370526	N/A	Mar. 15, 2017	Dec. 30, 2017~ Jan. 03, 2018	Mar. 14, 2018	Radiation (03CH13-HY)
Antenna Mast	EMEC	AM-BS-4 500-B	N/A	1m~4m	N/A	Dec. 30, 2017~ Jan. 03, 2018	N/A	Radiation (03CH13-HY)
Turn Table	EMEC	TT2000	N/A	0~360 Degree	N/A	Dec. 30, 2017~ Jan. 03, 2018	N/A	Radiation (03CH13-HY)
SHF-EHF Horn Antenna	SCHWARZBECK	BBHA 9170	BBHA9170576	18GHz ~ 40GHz	Apr. 27, 2017	Dec. 30, 2017~ Jan. 03, 2018	Apr. 26, 2018	Radiation (03CH13-HY)
EMI Test Receiver	Agilent	N9038A (MXE)	MY53290053	20Hz to 26.5GHz	Jan. 12, 2017	Dec. 30, 2017~ Jan. 03, 2018	Jan. 11, 2018	Radiation (03CH13-HY)



## 5 Uncertainty of Evaluation

### Uncertainty of Conducted Emission Measurement (150 kHz ~ 30 MHz)

Measuring Uncertainty for a Level of Confidence of 95% ( $U = 2Uc(y)$ )	2.70
---	------

### Uncertainty of Radiated Emission Measurement (30 MHz ~ 1000 MHz)

Measuring Uncertainty for a Level of Confidence of 95% ( $U = 2Uc(y)$ )	4.90
---	------

### Uncertainty of Radiated Emission Measurement (1000 MHz ~ 18000 MHz)

Measuring Uncertainty for a Level of Confidence of 95% ( $U = 2Uc(y)$ )	5.40
---	------

### Uncertainty of Radiated Emission Measurement (18000 MHz ~ 40000 MHz)

Measuring Uncertainty for a Level of Confidence of 95% ( $U = 2Uc(y)$ )	4.30
---	------

**Appendix A. Test Result of Conducted Test Items**

Test Engineer:	Shiming Liu	Temperature:	21~25	°C
Test Date:	2017/12/21~2017/12/22	Relative Humidity:	51~54	%

**TEST RESULTS DATA**  
**6dB and 99% Occupied Bandwidth**

Mod.	Data Rate	NTX	CH.	Freq. (MHz)	99% Occupied BW (MHz)	6dB BW (MHz)	6dB BW Limit (MHz)	Pass/Fail
BLE	1Mbps	1	0	2402	1.058	0.668	0.50	Pass
BLE	1Mbps	1	19	2440	1.056	0.668	0.50	Pass
BLE	1Mbps	1	39	2480	1.058	0.672	0.50	Pass

**TEST RESULTS DATA**  
**Peak Power Table**

Mod.	Data Rate	NTX	CH.	Freq. (MHz)	Peak Conducted Power (dBm)	Conducted Power Limit (dBm)	DG (dBi)	EIRP Power (dBm)	EIRP Power Limit (dBm)	Pass /Fail
BLE	1Mbps	1	0	2402	3.35	30.00	-3.20	0.15	36.00	Pass
BLE	1Mbps	1	19	2440	2.60	30.00	-3.20	-0.60	36.00	Pass
BLE	1Mbps	1	39	2480	2.37	30.00	-3.20	-0.83	36.00	Pass

**TEST RESULTS DATA**  
**Average Power Table**  
**(Reporting Only)**

Mod.	Data Rate	NTX	CH.	Freq. (MHz)	Duty Factor (dB)	Average Conducted Power (dBm)
BLE	1Mbps	1	0	2402	2.06	2.89
BLE	1Mbps	1	19	2440	2.06	2.11
BLE	1Mbps	1	39	2480	2.06	1.85

**TEST RESULTS DATA**  
**Peak Power Density**

Mod.	Data Rate	NTX	CH.	Freq. (MHz)	Peak PSD (dBm /100kHz)	Peak PSD (dBm /3kHz)	DG (dBi)	Peak PSD Limit (dBm /3kHz)	Pass/Fail
BLE	1Mbps	1	0	2402	2.26	-12.79	-3.20	8.00	Pass
BLE	1Mbps	1	19	2440	1.95	-13.20	-3.20	8.00	Pass
BLE	1Mbps	1	39	2480	1.54	-13.55	-3.20	8.00	Pass

Note: PSD (dBm/ 100kHz) is a reference level used for Conducted Band Edges and Conducted Spurious Emission 20dBc limit.



## Appendix B. AC Conducted Emission Test Results

Test Engineer :	Blue Lan	Temperature :	24~26°C
		Relative Humidity :	63~65%

# EUT Information

Report NO : 7D2018  
 Test Mode : Mode 1  
 Test Voltage : 120Vac/60Hz  
 Phase : Line

ENV216 Auto Test FCC Power Bar - L

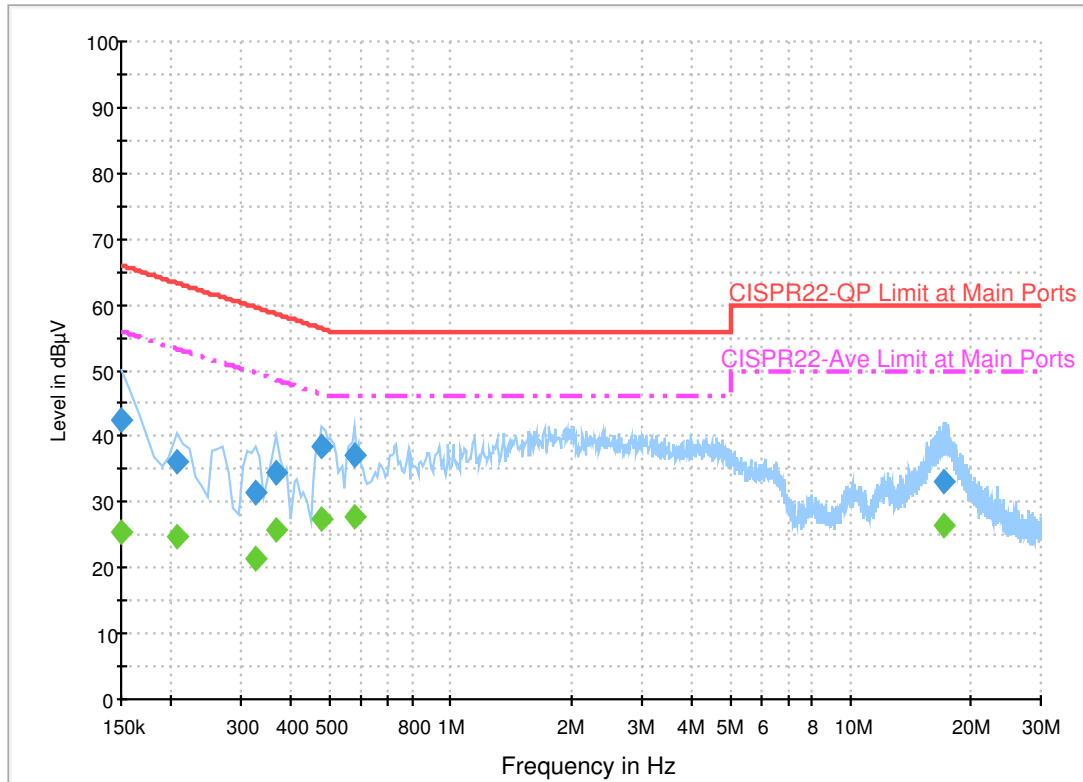

## Final Result 1

Frequency (MHz)	QuasiPeak (dBµV)	Filter	Line	Corr. (dB)	Margin (dB)	Limit (dBµV)
0.150000	42.6	Off	L1	19.5	23.4	66.0
0.206000	36.1	Off	L1	19.5	27.3	63.4
0.326000	31.5	Off	L1	19.5	28.1	59.6
0.366000	34.4	Off	L1	19.5	24.2	58.6
0.478000	38.3	Off	L1	19.5	18.1	56.4
0.574000	37.0	Off	L1	19.5	19.0	56.0
17.086000	33.2	Off	L1	19.7	26.8	60.0

## Final Result 2

Frequency (MHz)	Average (dBµV)	Filter	Line	Corr. (dB)	Margin (dB)	Limit (dBµV)
0.150000	25.5	Off	L1	19.5	30.5	56.0
0.206000	24.8	Off	L1	19.5	28.6	53.4
0.326000	21.6	Off	L1	19.5	28.0	49.6
0.366000	25.7	Off	L1	19.5	22.9	48.6
0.478000	27.6	Off	L1	19.5	18.8	46.4
0.574000	27.7	Off	L1	19.5	18.3	46.0
17.086000	26.6	Off	L1	19.7	23.4	50.0

# EUT Information

Report NO : 7D2018  
 Test Mode : Mode 1  
 Test Voltage : 120Vac/60Hz  
 Phase : Neutral

ENV216 Auto Test FCC Power Bar - N

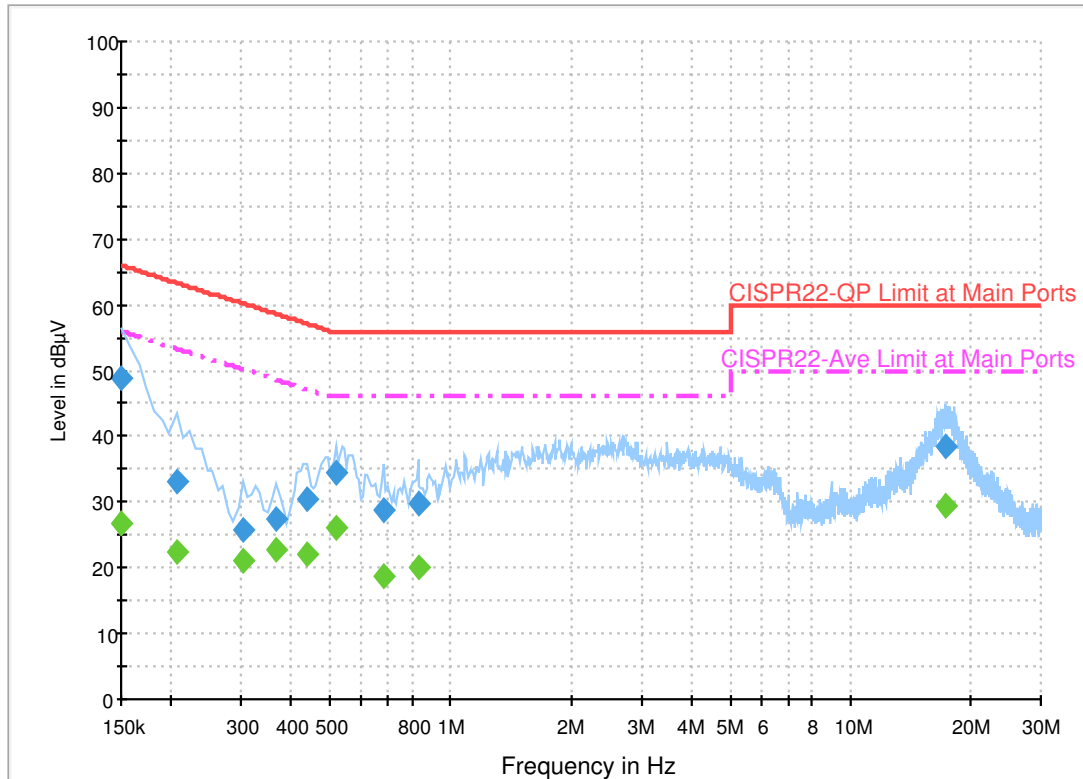

## Final Result 1

Frequency (MHz)	QuasiPeak (dBµV)	Filter	Line	Corr. (dB)	Margin (dB)	Limit (dBµV)
0.150000	49.0	Off	N	19.5	17.0	66.0
0.206000	33.0	Off	N	19.5	30.4	63.4
0.302000	25.6	Off	N	19.5	34.6	60.2
0.366000	27.5	Off	N	19.5	31.1	58.6
0.438000	30.5	Off	N	19.5	26.6	57.1
0.518000	34.4	Off	N	19.5	21.6	56.0
0.678000	28.8	Off	N	19.5	27.2	56.0
0.830000	29.9	Off	N	19.5	26.1	56.0
17.302000	38.3	Off	N	19.8	21.7	60.0

## Final Result 2

Frequency (MHz)	Average (dBµV)	Filter	Line	Corr. (dB)	Margin (dB)	Limit (dBµV)
0.150000	26.7	Off	N	19.5	29.3	56.0
0.206000	22.6	Off	N	19.5	30.8	53.4
0.302000	20.9	Off	N	19.5	29.3	50.2
0.366000	22.6	Off	N	19.5	26.0	48.6
0.438000	22.2	Off	N	19.5	24.9	47.1
0.518000	26.0	Off	N	19.5	20.0	46.0
0.678000	18.7	Off	N	19.5	27.3	46.0
0.830000	20.1	Off	N	19.5	25.9	46.0
17.302000	29.5	Off	N	19.8	20.5	50.0



## Appendix C. Radiated Spurious Emission

Test Engineer :	Alex Jheng, Bill Chang, and Wilson Wu	Temperature :	24.9~25.3°C
		Relative Humidity :	46~50%

### 2.4GHz 2400~2483.5MHz

#### BLE (Band Edge @ 3m)

BLE	Note	Frequency	Level	Over	Limit	Read	Antenna	Cable	Preamp	Ant	Table	Peak	Pol.	
		( MHz )	( dBµV/m )	( dB )	( dBµV/m )	( dBµV )	( dB/m )	( dB )	( dB )	( cm )	( deg )	( P/A )	( H/V )	
BLE CH 00 2402MHz		2363.445	51.14	-22.86	74	40.61	26.79	4.8	30.99	164	317	P	H	
		2382.765	41.93	-12.07	54	31.32	26.84	4.83	30.99	164	317	A	H	
	*	2402	92.99	-	-	82.31	26.89	4.85	30.99	164	317	P	H	
	*	2402	91.99	-	-	81.31	26.89	4.85	30.99	164	317	A	H	
													H	
														H
			2355.675	51.43	-22.57	74	40.93	26.79	4.78	31	123	237	P	V
			2389.38	42.07	-11.93	54	31.41	26.89	4.83	30.99	123	237	A	V
	*		2402	94.41	-	-	83.73	26.89	4.85	30.99	123	237	P	V
	*		2402	93.87	-	-	83.19	26.89	4.85	30.99	123	237	A	V
														V
														V
BLE CH 19 2440MHz		2363.34	51.11	-22.89	74	40.58	26.79	4.8	30.99	153	321	P	H	
		2386.86	41.79	-12.21	54	31.13	26.89	4.83	30.99	153	321	A	H	
	*	2440	93.04	-	-	82.16	27.04	4.88	30.97	153	321	P	H	
	*	2440	92.48	-	-	81.6	27.04	4.88	30.97	153	321	A	H	
			2490.41	51.09	-22.91	74	39.99	27.2	4.93	30.96	153	321	P	H
			2494.75	42.4	-11.6	54	31.3	27.2	4.93	30.96	153	321	A	H
			2378.04	51.04	-22.96	74	40.43	26.84	4.83	30.99	117	239	P	V
			2362.08	41.81	-12.19	54	31.29	26.79	4.8	31	117	239	A	V
	*		2440	94.7	-	-	83.82	27.04	4.88	30.97	117	239	P	V
	*		2440	93.95	-	-	83.07	27.04	4.88	30.97	117	239	A	V
			2494.05	52	-22	74	40.9	27.2	4.93	30.96	117	239	P	V
			2491.81	42.34	-11.66	54	31.24	27.2	4.93	30.96	117	239	A	V



<b>BLE CH 39 2480MHz</b>	*	2480	92.04	-	-	81.01	27.15	4.92	30.97	109	312	P	H
	*	2480	91.52	-	-	80.49	27.15	4.92	30.97	109	312	A	H
		2485.28	51.67	-22.33	74	40.63	27.15	4.93	30.97	109	312	P	H
		2483.72	42.35	-11.65	54	31.31	27.15	4.93	30.97	109	312	A	H
													H
													H
	*	2480	93.93	-	-	82.9	27.15	4.92	30.97	150	280	P	V
	*	2480	92.95	-	-	81.92	27.15	4.92	30.97	150	280	A	V
		2490.4	52.3	-21.7	74	41.2	27.2	4.93	30.96	150	280	P	V
		2493.6	42.24	-11.76	54	31.14	27.2	4.93	30.96	150	280	A	V
													V
													V
<b>Remark</b>	1. No other spurious found. 2. All results are PASS against Peak and Average limit line.												



2.4GHz 2400~2483.5MHz  
BLE (Harmonic @ 3m)

BLE	Note	Frequency ( MHz )	Level ( dBμV/m )	Over Limit ( dB )	Limit Line ( dBμV/m )	Read Level ( dBμV )	Antenna Factor ( dB/m )	Cable Loss ( dB )	Preamp Factor ( dB )	Ant Pos ( cm )	Table Pos ( deg )	Peak Avg. ( P/A )	Pol. ( H/V )	
BLE CH 00 2402MHz		4804	37.9	-36.1	74	55.82	31.53	7.3	57.27	100	0	P	H	
													H	
													H	
													H	
			4804	38.17	-35.83	74	56.09	31.53	7.3	57.27	100	0	P	V
														V
														V
BLE CH 19 2440MHz		4880	38.35	-35.65	74	55.95	31.63	7.44	57.17	100	0	P	H	
		7320	43.53	-30.47	74	55.03	36.19	9.14	57.29	100	0	P	H	
													H	
													H	
			4880	39.22	-34.78	74	56.82	31.63	7.44	57.17	100	0	P	V
			7320	43.22	-30.78	74	54.72	36.19	9.14	57.29	100	0	P	V
														V
BLE CH 39 2480MHz		4960	38.49	-35.51	74	55.71	31.75	7.59	57.05	100	0	P	H	
		7440	43.32	-30.68	74	54.68	36.41	9.21	57.44	100	0	P	H	
													H	
													H	
			4960	38.52	-35.48	74	55.74	31.75	7.59	57.05	100	0	P	V
			7440	43.25	-30.75	74	54.61	36.41	9.21	57.44	100	0	P	V
														V
Remark	1. No other spurious found.													
	2. All results are PASS against Peak and Average limit line.													



Emission below 1GHz

2.4GHz BLE (LF)

BLE	Note	Frequency	Level	Over	Limit	Read	Antenna	Cable	Preamp	Ant	Table	Peak	Pol.	
		( MHz )	( dBμV/m )	( dB )	( dBμV/m )	( dBμV )	( dB/m )	( dB )	( dB )	( cm )	( deg )	( P/A )	( H/V )	
2.4GHz BLE LF		30	30.52	-9.48	40	38.12	24.17	0.59	32.34	100	0	P	H	
		59.97	21.39	-18.61	40	41.38	11.5	0.84	32.31	-	-	P	H	
		241.14	24.61	-21.39	46	37.9	17.25	1.59	32.21	-	-	P	H	
		504.4	25.11	-20.89	46	31.32	23.71	2.2	32.2	-	-	P	H	
		759.9	29.71	-16.29	46	31.06	27.9	2.71	32.06	-	-	P	H	
		948.9	32.9	-13.1	46	30.25	30.51	3.06	31.06	-	-	P	H	
														H
														H
														H
														H
														H
														H
			31.35	36.27	-3.73	40	44.34	23.7	0.59	32.34	100	0	P	V
			59.97	29.49	-10.51	40	49.48	11.5	0.84	32.31	-	-	P	V
			119.91	25.7	-17.8	43.5	39.51	17.33	1.09	32.29	-	-	P	V
			570.2	27.05	-18.95	46	31.05	25.75	2.36	32.21	-	-	P	V
			742.4	30.21	-15.79	46	31.78	27.74	2.68	32.09	-	-	P	V
			943.3	33.05	-12.95	46	30.72	30.25	3.06	31.12	-	-	P	V
														V
														V
													V	
													V	
													V	
													V	
Remark	1. No other spurious found. 2. All results are PASS against limit line.													



**Note symbol**

*	<b>Fundamental Frequency</b> which can be ignored. However, the level of any unwanted emissions shall not exceed the level of the fundamental frequency.
!	Test result is <b>over limit</b> line.
P/A	<b>Peak</b> or <b>Average</b>
H/V	<b>Horizontal</b> or <b>Vertical</b>



A calculation example for radiated spurious emission is shown as below:

WIFI	Note	Frequency	Level	Over	Limit	Read	Antenna	Cable	Preamp	Ant	Table	Peak	Pol.
Ant.				Limit	Line	Level	Factor	Loss	Factor	Pos	Pos	Avg.	
1+2		( MHz )	( dBμV/m )	( dB )	( dBμV/m )	( dBμV )	( dB/m )	( dB )	( dB )	( cm )	( deg )	( P/A )	( H/V )
802.11b		2390	55.45	-18.55	74	54.51	32.22	4.58	35.86	103	308	P	H
CH 01													
2412MHz		2390	43.54	-10.46	54	42.6	32.22	4.58	35.86	103	308	A	H

- Level(dBμV/m) =  
Antenna Factor(dB/m) + Cable Loss(dB) + Read Level(dBμV) - Preamp Factor(dB)
- Over Limit(dB) = Level(dBμV/m) – Limit Line(dBμV/m)

**For Peak Limit @ 2390MHz:**

- Level(dBμV/m)  
= Antenna Factor(dB/m) + Cable Loss(dB) + Read Level(dBμV) - Preamp Factor(dB)  
= 32.22(dB/m) + 4.58(dB) + 54.51(dBμV) – 35.86 (dB)  
= 55.45 (dBμV/m)
- Over Limit(dB)  
= Level(dBμV/m) – Limit Line(dBμV/m)  
= 55.45(dBμV/m) – 74(dBμV/m)  
= -18.55(dB)

**For Average Limit @ 2390MHz:**

- Level(dBμV/m)  
= Antenna Factor(dB/m) + Cable Loss(dB) + Read Level(dBμV) - Preamp Factor(dB)  
= 32.22(dB/m) + 4.58(dB) + 42.6(dBμV) – 35.86 (dB)  
= 43.54 (dBμV/m)
- Over Limit(dB)  
= Level(dBμV/m) – Limit Line(dBμV/m)  
= 43.54(dBμV/m) – 54(dBμV/m)  
= -10.46(dB)

Both peak and average measured complies with the limit line, so test result is “PASS”.



## Appendix D. Radiated Spurious Emission Plots

Test Engineer :	Alex Jheng, Bill Chang, and Wilson Wu	Temperature :	24.9~25.3°C
		Relative Humidity :	46~50%

**Note symbol**

-L	Low channel location
-R	High channel location



2.4GHz 2400~2483.5MHz

BLE (Band Edge @ 3m)

BLE	2.4GHz 2400~2483.5MHz Band Edge @ 3m	
ANT	BLE CH00 2402MHz	
1	Horizontal	Fundamental
Peak	<p>Site : 03CH13-HY            Condition : PEAK_BE_74 3m HORN_91200_1241 HORIZONTAL            Detector : Peak            Project : 7D2018            Mode : 5</p>	<p>Site : 03CH13-HY            Condition : PEAK_74 3m HORN_91200_1241 HORIZONTAL            Detector : Peak            Project : 7D2018            Mode : 5</p>
Avg.	<p>Site : 03CH13-HY            Condition : AVG_BE_54 3m HORN_91200_1241 HORIZONTAL            Detector : Peak            Project : 7D2018            Mode : 5</p>	<p>Site : 03CH13-HY            Condition : AVG_54 3m HORN_91200_1241 HORIZONTAL            Detector : Peak            Project : 7D2018            Mode : 5</p>

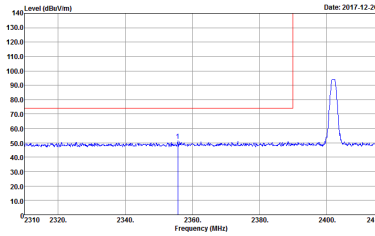
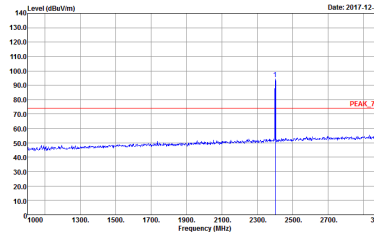
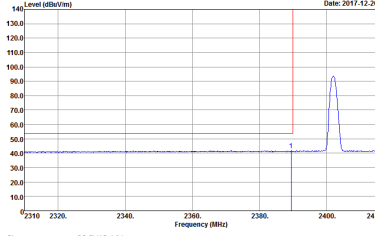
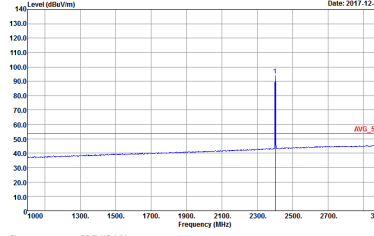

BLE	2.4GHz 2400~2483.5MHz Band Edge @ 3m	
ANT	BLE CH00 2402MHz	
1	Vertical	Fundamental
Peak	 <p>Site : 03CH13-IHY            Condition : PEAK_BE_74 3m HORN_9120D_1241 VERTICAL            Detector : Peak            Project : 7D2018            Mode : 5</p>	 <p>Site : 03CH13-IHY            Condition : PEAK_74 3m HORN_9120D_1241 VERTICAL            Detector : Peak            Project : 7D2018            Mode : 5</p>
Avg	 <p>Site : 03CH13-IHY            Condition : AVG_BE_54 3m HORN_9120D_1241 VERTICAL            Detector : Peak            Project : 7D2018            Mode : 5</p>	 <p>Site : 03CH13-IHY            Condition : AVG_54 3m HORN_9120D_1241 VERTICAL            Detector : Peak            Project : 7D2018            Mode : 5</p>

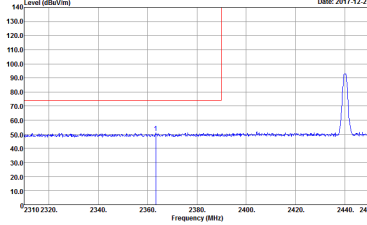
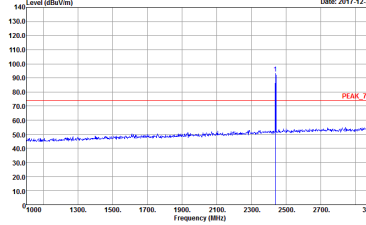
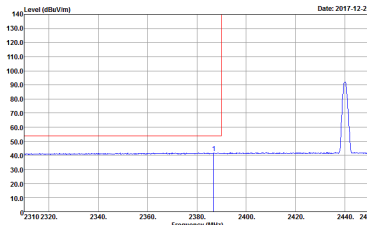
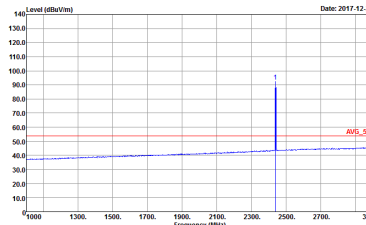

BLE	2.4GHz 2400~2483.5MHz Band Edge @ 3m	
ANT	BLE CH19 2440MHz - L	
1	Horizontal	Fundamental
Peak	 <p>Site : 03CH13-HY            Condition : PEAK_BE_74 3m HORN_9120D_1241 HORIZONTAL            Detector : Peak            Project : 7D2018            Mode : 6</p>	 <p>Site : 03CH13-HY            Condition : PEAK_74 3m HORN_9120D_1241 HORIZONTAL            Detector : Peak            Project : 7D2018            Mode : 6</p>
Avg.	 <p>Site : 03CH13-HY            Condition : AVG_BE_54 3m HORN_9120D_1241 HORIZONTAL            Detector : Peak            Project : 7D2018            Mode : 6</p>	 <p>Site : 03CH13-HY            Condition : AVG_54 3m HORN_9120D_1241 HORIZONTAL            Detector : Peak            Project : 7D2018            Mode : 6</p>

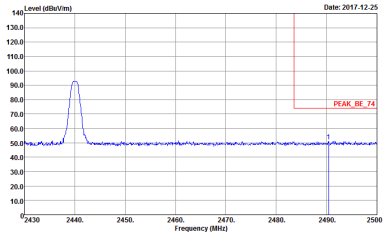
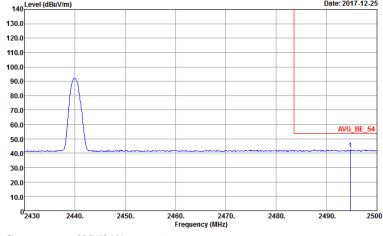

BLE	2.4GHz 2400~2483.5MHz Band Edge @ 3m	
ANT	BLE CH19 2440MHz - R	
1	Horizontal	Fundamental
<p><b>Peak</b></p>	 <p>Site : 03CH13-HY            Condition : PEAK_BE_74 3m HORN_9120D_1241 HORIZONTAL            RBW:1000.000KHz VBW:3000.000KHz SWT:Auto            Detector : Peak            Project : 7D2018            Mode : 6</p>	<p>Left blank</p>
<p><b>Avg.</b></p>	 <p>Site : 03CH13-HY            Condition : AVG_BE_54 3m HORN_9120D_1241 HORIZONTAL            RBW:1000.000KHz VBW:3.000KHz SWT:Auto            Detector : Peak            Project : 7D2018            Mode : 6</p>	<p>Left blank</p>

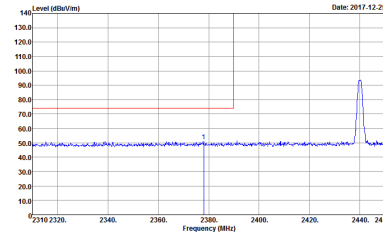
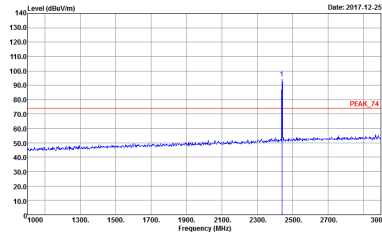
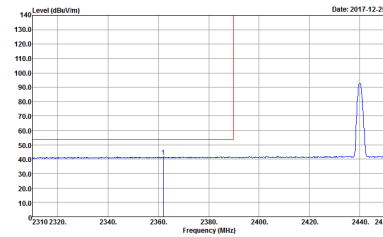
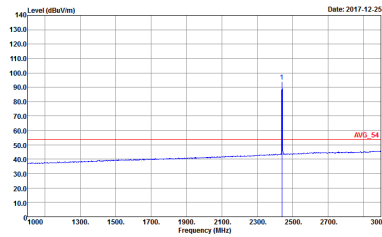

BLE	2.4GHz 2400~2483.5MHz Band Edge @ 3m	
ANT	BLE CH19 2440MHz - L	
1	Vertical	Fundamental
Peak	 <p>Site : 03CH13-IHY            Condition : PEAK_BE_74 3m HORN_9120D_1241 VERTICAL            Detector : Peak            Project : 7D2018            Mode : 6</p>	 <p>Site : 03CH13-IHY            Condition : PEAK_74 3m HORN_9120D_1241 VERTICAL            Detector : Peak            Project : 7D2018            Mode : 6</p>
Avg.	 <p>Site : 03CH13-IHY            Condition : AVG_BE_54 3m HORN_9120D_1241 VERTICAL            Detector : Peak            Project : 7D2018            Mode : 6</p>	 <p>Site : 03CH13-IHY            Condition : AVG_54 3m HORN_9120D_1241 VERTICAL            Detector : Peak            Project : 7D2018            Mode : 6</p>

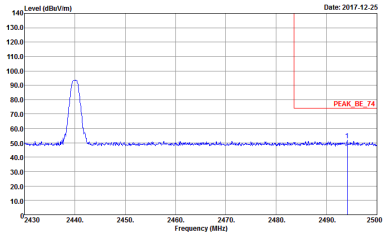
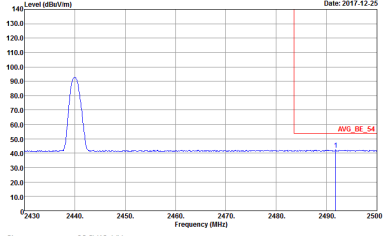

BLE	2.4GHz 2400~2483.5MHz Band Edge @ 3m	
ANT	BLE CH19 2440MHz - R	
1	Vertical	Fundamental
<p><b>Peak</b></p>	 <p>Site : 03CH13-HY            Condition : PEAK_BE_74 3m HORN_9120D_1241 VERTICAL            RBW:1000.000KHz VBW:3000.000KHz SWT:Auto            Detector : Peak            Project : 7D2018            Mode : 6</p>	<p>Left blank</p>
<p><b>Avg.</b></p>	 <p>Site : 03CH13-HY            Condition : AVG_BE_54 3m HORN_9120D_1241 VERTICAL            RBW:1000.000KHz VBW:3.000KHz SWT:Auto            Detector : Peak            Project : 7D2018            Mode : 6</p>	<p>Left blank</p>

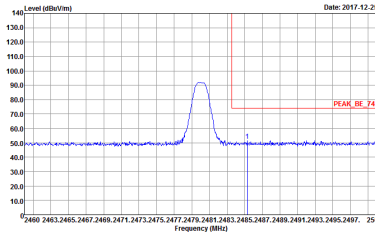
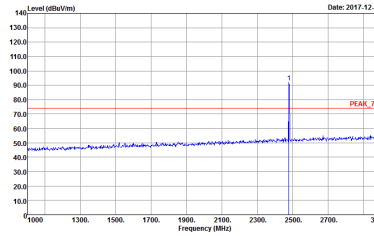
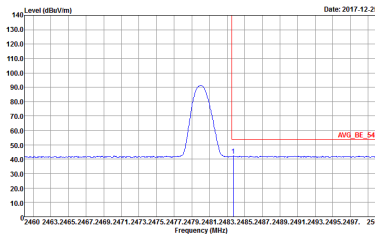
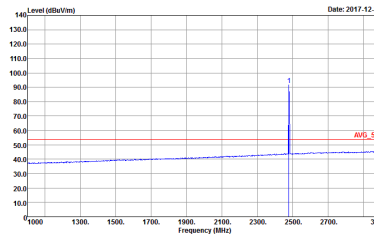

BLE	2.4GHz 2400~2483.5MHz Band Edge @ 3m	
ANT	BLE CH39 2480MHz	
1	Horizontal	Fundamental
<p><b>Peak</b></p>	 <p>Site : 03CH13-1HY            Condition : PEAK_BE_74 3m HORN_9120D_1241 HORIZONTAL            Detector : Peak            Project : 7D2018            Mode : 7</p>	 <p>Site : 03CH13-1HY            Condition : PEAK_74 3m HORN_9120D_1241 HORIZONTAL            Detector : Peak            Project : 7D2018            Mode : 7</p>
<p><b>Avg.</b></p>	 <p>Site : 03CH13-1HY            Condition : AVG_BE_54 3m HORN_9120D_1241 HORIZONTAL            Detector : Peak            Project : 7D2018            Mode : 7</p>	 <p>Site : 03CH13-1HY            Condition : AVG_54 3m HORN_9120D_1241 HORIZONTAL            Detector : Peak            Project : 7D2018            Mode : 7</p>



BLE	2.4GHz 2400~2483.5MHz Band Edge @ 3m	
ANT	BLE CH39 2480MHz	
1	Vertical	Fundamental
<p><b>Peak</b></p>	<p>Site : 03CH13-HY            Condition : PEAK_BE_74 3m HORN_9120D_1241 VERTICAL            Detector : Peak            Project : 7D2018            Mode : 7</p>	<p>Site : 03CH13-HY            Condition : PEAK_74 3m HORN_9120D_1241 VERTICAL            Detector : Peak            Project : 7D2018            Mode : 7</p>
<p><b>Avg.</b></p>	<p>Site : 03CH13-HY            Condition : AVG_BE_54 3m HORN_9120D_1241 VERTICAL            Detector : Peak            Project : 7D2018            Mode : 7</p>	<p>Site : 03CH13-HY            Condition : AVG_54 3m HORN_9120D_1241 VERTICAL            Detector : Peak            Project : 7D2018            Mode : 7</p>



2.4GHz 2400~2483.5MHz

BLE (Harmonic @ 3m)

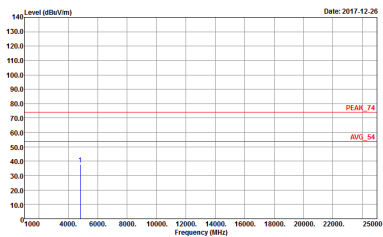
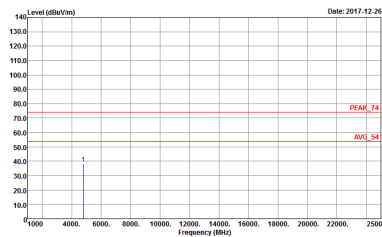
BLE	2.4GHz 2400~2483.5MHz Harmonic @ 3m	
ANT	BLE CH00 2402MHz	
1	Horizontal	Vertical
<p><b>Peak</b></p> <p><b>Avg.</b></p>	 <p>Site : 03CH13-HY            Condition : PEAK_74 3m SHF_HORN_576 HORIZONTAL            Detector : Peak            Project : 7D2018            Mode : 5</p>	 <p>Site : 03CH13-HY            Condition : PEAK_74 3m SHF_HORN_576 VERTICAL            Detector : Peak            Project : 7D2018            Mode : 5</p>

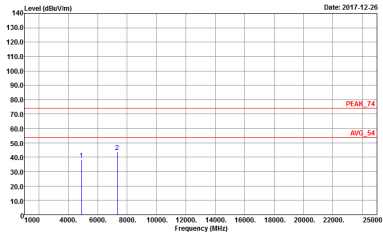
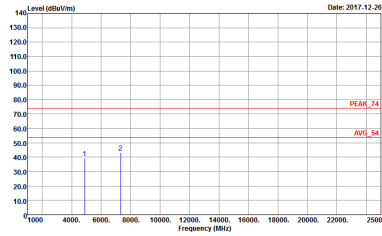

BLE	2.4GHz 2400~2483.5MHz Harmonic @ 3m	
ANT	BLE CH19 2440MHz	
1	Horizontal	Vertical
<p>Peak Avg.</p>	 <p>Site : 03CH13-11Y Condition : PEAK_74 3m SHF_HORN_576 HORIZONTAL Detector : Peak Project : 7D2018 Mode : -6</p>	 <p>Site : 03CH13-11Y Condition : PEAK_74 3m SHF_HORN_576 VERTICAL Detector : Peak Project : 7D2018 Mode : -6</p>

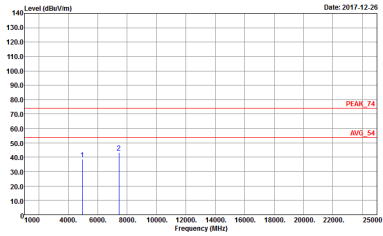
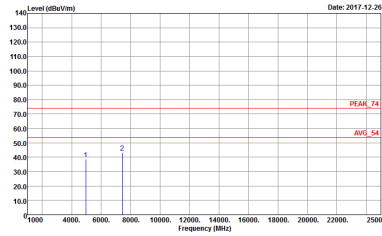

BLE	2.4GHz 2400~2483.5MHz Harmonic @ 3m	
ANT	BLE CH39 2480MHz	
1	Horizontal	Vertical
Peak	 <p>Site : 03CH13-11Y          Condition : PEAK_74 3m SHF_HORN_576 HORIZONTAL          Detector : Peak          Project : 7D2018          Mode : 7</p>	 <p>Site : 03CH13-11Y          Condition : PEAK_74 3m SHF_HORN_576 VERTICAL          Detector : Peak          Project : 7D2018          Mode : 7</p>



Emission below 1GHz

2.4GHz BLE (LF)

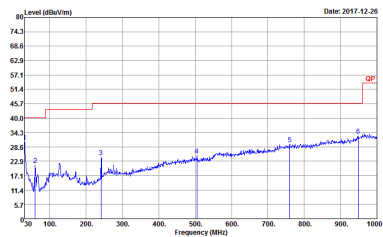
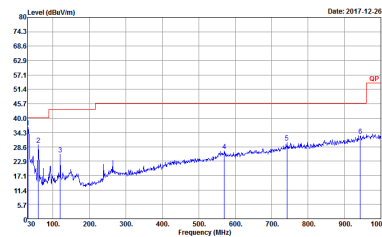
BLE	2.4GHz 2400~2483.5MHz	
ANT	BLE LF	
1	Horizontal	Vertical
<p>QP / Peak</p>	 <p>Site : 03CH13-HY            Condition : QP 3m BIL06_35414 HORIZONTAL            Detector : Peak            Project : 7D2018            Mode : 8</p>	 <p>Site : 03CH13-HY            Condition : QP 3m BIL06_35414 VERTICAL            Detector : Peak            Project : 7D2018            Mode : 8</p>

## Appendix E. Duty Cycle Plots

Band	Duty Cycle(%)	T(us)	1/T(kHz)	VBW Setting	Duty Factor(dB)
Bluetooth -LE	62.18	388	2.58	3kHz	2.06

### Bluetooth - LE

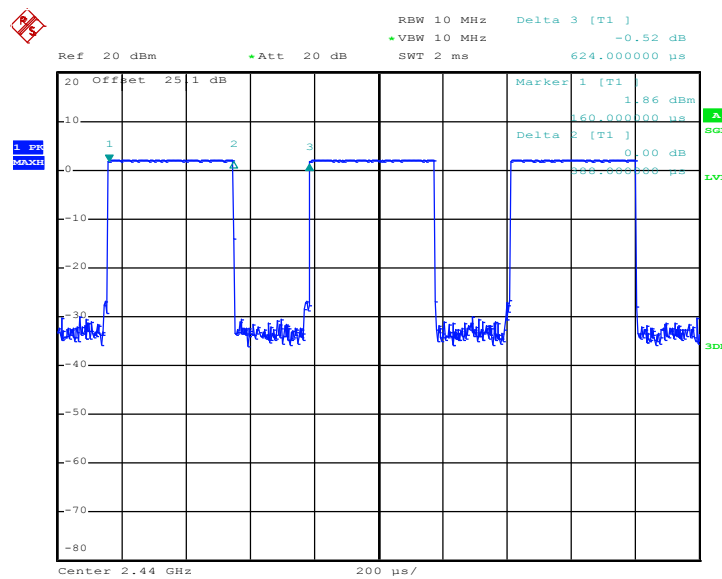

Date: 21.DEC.2017 20:56:14