



# FCC RF Test Report

**APPLICANT** : Motorola Mobility LLC  
**EQUIPMENT** : Mobile Cellular Phone  
**BRAND NAME** : Motorola  
**MODEL NAME** : XT1921-5, XT1921-3  
**FCC ID** : IHDT56XC2  
**STANDARD** : FCC 47 CFR Part 2, and 90(S)  
**CLASSIFICATION** : PCS Licensed Transmitter Held to Ear (PCE)

The product was received on Dec. 20, 2017 and testing was completed on Jan. 08, 2018. We, SPORTON INTERNATIONAL INC., would like to declare that the tested sample has been evaluated in accordance with the procedures given in ANSI / TIA-603-E and shown compliance with the applicable technical standards.

The test results in this report apply exclusively to the tested model / sample. Without written approval of SPORTON INTERNATIONAL INC., the test report shall not be reproduced except in full.

Reviewed by: Joseph Lin / Supervisor

Approved by: Jones Tsai / Manager



## **SPORTON INTERNATIONAL INC.**

No. 52, Hwa Ya 1<sup>st</sup> Rd., Hwa Ya Technology Park, Kwei-Shan District, Tao Yuan City, Taiwan, R.O.C.



# TABLE OF CONTENTS

**REVISION HISTORY..... 3**

**SUMMARY OF TEST RESULT ..... 4**

**1 GENERAL DESCRIPTION ..... 5**

    1.1 Applicant..... 5

    1.2 Manufacturer ..... 5

    1.3 Feature of Equipment Under Test..... 5

    1.4 Product Specification of Equipment Under Test ..... 5

    1.5 Modification of EUT ..... 6

    1.6 Maximum Conducted Power, Frequency Tolerance, and Emission Designator..... 6

    1.7 Testing Site..... 7

    1.8 Applied Standards ..... 7

**2 TEST CONFIGURATION OF EQUIPMENT UNDER TEST ..... 8**

    2.1 Test Mode..... 8

    2.2 Connection Diagram of Test System ..... 8

    2.3 Support Unit used in test configuration ..... 9

    2.4 Measurement Results Explanation Example ..... 9

    2.5 Frequency List of Low/Middle/High Channels..... 9

**3 TEST RESULT ..... 10**

    3.1 Conducted Output Power Measurement..... 10

    3.2 Bandwidth Limitations Measurement ..... 11

    3.3 Emissions Mask Measurement ..... 12

    3.4 Emissions Mask – Out Of Band Emissions Measurement..... 13

    3.5 Field Strength of Spurious Radiation Measurement ..... 15

    3.6 Frequency Stability Measurement..... 18

**4 LIST OF MEASURING EQUIPMENT ..... 20**

**5 UNCERTAINTY OF EVALUATION ..... 21**

**APPENDIX A. TEST RESULTS OF CONDUCTED TEST**

**APPENDIX B. TEST RESULTS OF ERP/EIRP AND RADIATED TEST**





### SUMMARY OF TEST RESULT

Report Section	FCC Rule	Description	Limit	Result	Remark
3.1	§2.1046 §90.635	Conducted Output Power	< 100 Watts	PASS	-
3.2	§2.1049 §90.209	Bandwidth limitations	N/A (Reporting only)	PASS	-
3.3	§2.1051 §90.691	Emission masks – In-band emissions	< 50+10log <sub>10</sub> (P[Watts])	PASS	-
3.4	§2.1051 §90.691	Emission masks – Out of band emissions	< 43+10log <sub>10</sub> (P[Watts])	PASS	-
3.5	§2.1053 §90.691	Field Strength of Spurious Radiation	< 43+10log <sub>10</sub> (P[Watts])	PASS	Under limit 44.91 dB at 2472.000 MHz
3.6	§2.1055 §90.213	Frequency Stability for Temperature & Voltage	< 2.5 ppm	PASS	-



# 1 General Description

## 1.1 Applicant

**Motorola Mobility LLC**  
222 W. Merchandise Mart Plaza, Chicago IL 60654, USA

## 1.2 Manufacturer

**Motorola Mobility LLC**  
222 W. Merchandise Mart Plaza, Chicago IL 60654, USA

## 1.3 Feature of Equipment Under Test

Product Feature	
<b>Equipment</b>	Mobile Cellular Phone
<b>Brand Name</b>	Motorola
<b>Model Name</b>	XT1921-5, XT1921-3
<b>FCC ID</b>	IHDT56XC2
<b>IMEI Code</b>	990005440085216 (for Radiation) 990005440087469 (for Conducted)
<b>EUT supports Radios application</b>	CDMA/EV-DO/GSM/EGPRS/WCDMA/HSPA/LTE/FM/GNSS WLAN 11b/g/n HT20 WLAN 11a/n HT20/HT40 Bluetooth BR/EDR/LE
<b>HW Version</b>	DVT1B
<b>EUT Stage</b>	Identical Prototype

**Remark:** The above EUT's information was declared by manufacturer. Please refer to the specifications or user's manual for more detailed description.

Accessory List	
<b>AC Adapter 1</b>	Brand Name : Motorola
	Model Name : C-P35
<b>AC Adapter 2</b>	Brand Name : Motorola
	Model Name : SSW-2919UMTJ C-P35 SPN5945A
<b>AC Adapter 3</b>	Brand Name : Motorola
	Model Name : C-P56
<b>AC Adapter 4</b>	Brand Name : Motorola
	Model Name : C-P56
<b>Battery</b>	Brand Name : Motorola
	Model Name : GK40
<b>USB Cable</b>	Brand Name : Saibao
	Model Name : SWT-A083A



### 1.4 Product Specification of Equipment Under Test

Product Specification subjective to this standard	
Tx Frequency	817.9 MHz ~ 823.1 MHz
Rx Frequency	862.9 MHz ~ 868.1 MHz
Maximum Output Power to Antenna	24.06 dBm
Antenna Type	PIFA Antenna and Coupling Type (LDS) Antenna
Antenna Gain	-0.59 dBi
Type of Modulation	CDMA2000 1xRTT: QPSK CDMA2000 1xEV-DO : QPSK/8PSK

### 1.5 Modification of EUT

No modifications are made to the EUT during all test items.

### 1.6 Maximum Conducted Power, Frequency Tolerance, and Emission Designator

FCC Rule	Frequency Range (MHz)	System	Type of Modulation	Frequency Tolerance (ppm)	Emission Designator
Part 90(S)	817.9 ~ 823.1	CDMA2000 BC10 1xRTT	QPSK	0.0427 ppm	1M43F9W
Part 90(S)	817.9 ~ 823.1	CDMA2000 BC10 1xEV-DO	QPSK	0.0451 ppm	1M43F9W



### 1.7 Testing Site

Sporton Lab is accredited to ISO 17025 by Taiwan Accreditation Foundation (TAF code : 1190) and the FCC designation No. TW1190 and TW0007 under the FCC 2.948(e) by Mutual Recognition Agreement (MRA) in FCC Test.

<b>Test Site</b>	SPORTON INTERNATIONAL INC.
<b>Test Site Location</b>	No. 52, Hwa Ya 1 <sup>st</sup> Rd., Hwa Ya Technology Park, Kwei-Shan District, Tao Yuan City, Taiwan, R.O.C. TEL: +886-3-327-3456 FAX: +886-3-328-4978
<b>Test Site No.</b>	<b>Sporton Site No.</b>
	TH03-HY

<b>Test Site</b>	SPORTON INTERNATIONAL INC.
<b>Test Site Location</b>	No.58, Aly. 75, Ln. 564, Wenhua 3rd Rd., Kwei-Shan District, Tao Yuan City, Taiwan R.O.C. TEL: +886-3-327-0868 FAX: +886-3-327-0855
<b>Test Site No.</b>	<b>Sporton Site No. :</b>
	03CH12-HY

### 1.8 Applied Standards

According to the specifications of the manufacturer, the EUT must comply with the requirements of the following standards:

- ♦ FCC 47 CFR Part 2, 90
- ♦ ANSI / TIA-603-E
- ♦ FCC KDB 971168 D01 Power Meas. License Digital Systems v03

**Remark:**

1. All test items were verified and recorded according to the standards and without any deviation during the test.
2. This EUT has also been tested and complied with the requirements of FCC Part 15, Subpart B, recorded in a separate test report.

## 2 Test Configuration of Equipment Under Test

### 2.1 Test Mode

Antenna port conducted and radiated test items were performed according to KDB 971168 D01 Power Meas. License Digital Systems v03 with maximum output power.

Radiated measurements were performed with rotating EUT in different three orthogonal test planes to find the maximum emission.

Frequency range investigated for radiated emission is 30 MHz to 9000 MHz for CDMA2000 BC10.

Test Modes		
Band	Radiated TCs	Conducted TCs
CDMA2000 BC10	<ul style="list-style-type: none"> <li>■ 1xRTT Link</li> <li>■ 1xEV-DO Link</li> </ul>	<ul style="list-style-type: none"> <li>■ 1xRTT Link</li> <li>■ 1xEV-DO Link</li> </ul>

**Remark:** All the radiated test cases were performance with Adapter 1.

### 2.2 Connection Diagram of Test System

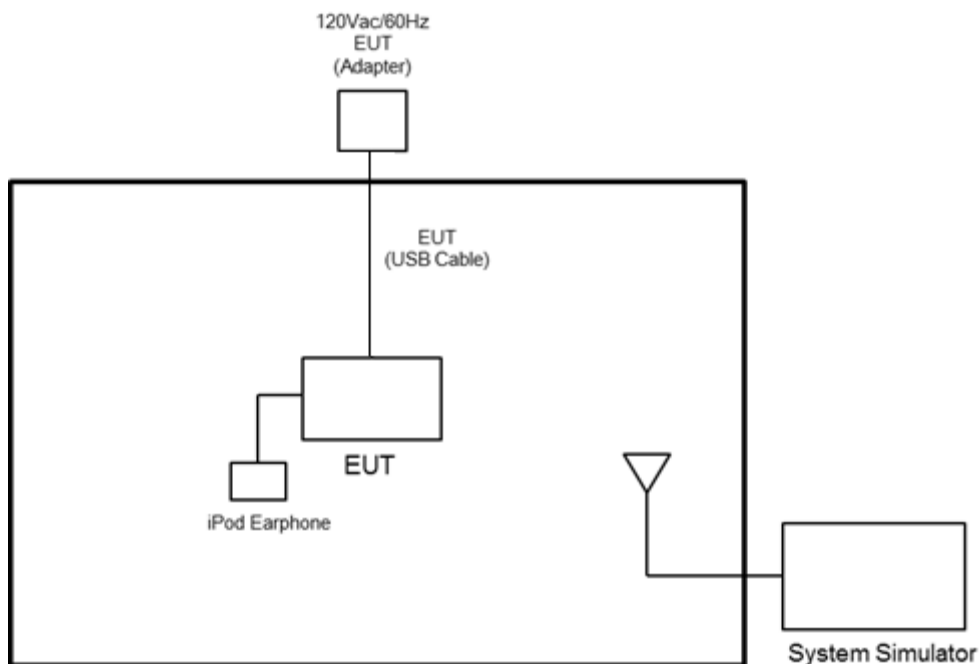



### 2.3 Support Unit used in test configuration

Item	Equipment	Trade Name	Model No.	FCC ID	Data Cable	Power Cord
1.	System Simulator	R&S	CMU 200	N/A	N/A	Unshielded, 1.8 m
2.	iPod Earphone	Apple	N/A	N/A	N/A	N/A

### 2.4 Measurement Results Explanation Example

For all conducted test items:

The offset level is set in the spectrum analyzer to compensate the RF cable loss and attenuator factor between RF conducted output port and spectrum analyzer. With the offset compensation, the spectrum analyzer reading level will be exactly the RF output level.

The spectrum analyzer offset is derived from RF cable loss and attenuator factor.

*Offset = RF cable loss + attenuator factor.*

The following shows an offset computation example with RF cable loss 4.2 dB and a 10dB attenuator.

Example :

$$\begin{aligned}
 \text{Offset(dB)} &= \text{RF cable loss(dB)} + \text{attenuator factor(dB)}. \\
 &= 4.2 + 10 = 14.2 \text{ (dB)}
 \end{aligned}$$

### 2.5 Frequency List of Low/Middle/High Channels

Frequency List				
Band	Channel/Frequency(MHz)	Lowest	Middle	Highest
CDMA200 BC10	Channel	476	580	684
	Frequency	817.9	820.5	823.1

### **3 Test Result**

#### **3.1 Conducted Output Power Measurement**

##### **3.1.1 Description of the Conducted Output Power Measurement**

A system simulator was used to establish communication with the EUT. Its parameters were set to enforce EUT transmitting at the maximum power. The measured power in the radio frequency on the transmitter output terminals shall be reported.

##### **3.1.2 Measuring Instruments**

The measuring equipment is listed in the section 4 of this test report.

##### **3.1.3 Test Procedures**

1. The transmitter output port was connected to the system simulator.
2. Set EUT at maximum power through system simulator.
3. Select lowest, middle, and highest channels for each band and different modulation.
4. Measure the maximum burst average power for GSM and maximum average power for other modulation signal.

##### **3.1.4 Test Setup**

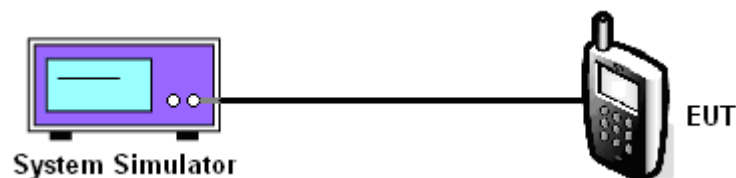

##### **3.1.5 Test Result of Conducted Output Power**

Please refer to Appendix A.

## 3.2 Bandwidth Limitations Measurement

### 3.2.1 Description of (Occupied) Bandwidth Limitations Measurement

The 99% occupied bandwidth is the width of a frequency band such that, below the lower and above the upper frequency limits, the mean powers emitted are each equal to a specified percentage 0.5% of the total mean transmitted power.

The emission bandwidth is defined as the width of the signal between two points, located at the 2 sides of the carrier frequency, outside of which all emissions are attenuated at least 26 dB below the transmitter power.

### 3.2.2 Measuring Instruments

The measuring equipment is listed in the section 4 of this test report.

### 3.2.3 Test Procedures

1. The EUT was connected to the spectrum analyzer and system simulator via a power divider.
2. The RF output of the EUT was connected to the spectrum analyzer by RF cable and attenuator. The path loss was compensated to the results for each measurement.
3. The 99% occupied bandwidth were measured, set RBW= 1% of span, VBW $\geq$  3\*RBW, sample detector, trace maximum hold.
4. The 26dB bandwidth were measured, set RBW= 1% of EBW, VBW $\geq$  3\*RBW, peak detector, trace maximum hold.

### 3.2.4 Test Setup

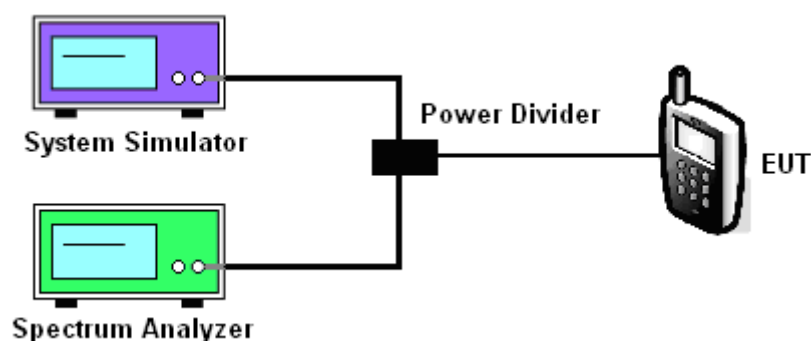

### 3.2.5 Test Result of Occupied Bandwidth and 26dB Bandwidth

Please refer to Appendix A.

### 3.3 Emissions Mask Measurement

#### 3.3.1 Description of Emissions Mask Measurement

Equipment used in this licensed to EA or non-EA systems shall comply with the emission mask provisions of FCC Part 90.691.(a)(1)

(a). Out-of-band emission requirement shall apply only to the “outer” channels included in an EA license and to spectrum adjacent to interior channels used by incumbent licensees. The emission limits are as follows:

- (1) For any frequency removed from the EA licensee's frequency block by up to and including 37.5 kHz, the power of any emission shall be attenuated below the transmitter power (P) in watts by at least  $116 \text{ Log}_{10}(f/6.1)$  decibels or  $50 + 10 \text{ Log}_{10}(P)$  decibels or 80 decibels, whichever is the lesser attenuation, where f is the frequency removed from the center of the outer channel in the block in kilohertz and where f is greater than 12.5 kHz.

#### 3.3.2 Measuring Instruments

The measuring equipment is listed in the section 4 of this test report.

#### 3.3.3 Test Procedures

1. The EUT was connected to spectrum analyzer and system simulator via power divider.
2. The emissions mask of low and high channels for the highest RF powers were measured.
3. The measured RBW and the VBW set 3 times of RBW are then set in spectrum analyzer, and the RBW correction factor  $10\log(1\% \text{ of OBW}/\text{measured RBW})(\text{dB})$  was compensated, if required.
4. The test results were shown below plots with a correction offset factor including cable loss, insertion loss of power divider.

#### 3.3.4 Test Setup

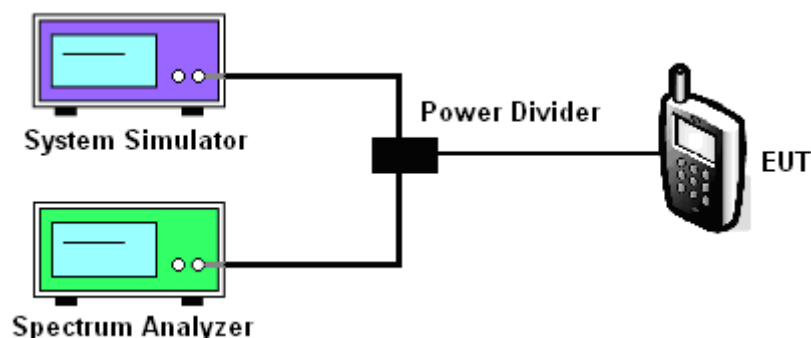

#### 3.3.5 Test Result (Plots) of Conducted Emissions Mask

Please refer to Appendix A.



### 3.4 Emissions Mask – Out Of Band Emissions Measurement

#### 3.4.1 Description of Conducted Spurious Emissions Out of band emissions measurement

The power of any emission FCC Part 90.691 (a)(2) on any frequency removed from the assigned frequency by more than 250 percent of the authorized bandwidth at least  $43 + 10 \log (P)$  dB.

It is measured by means of a calibrated spectrum analyzer and scanned from 30 MHz up to a frequency including its 10th harmonic.

#### 3.4.2 Measuring Instruments

The measuring equipment is listed in the section 4 of this test report.

#### 3.4.3 Test Procedures

1. The EUT was connected to the spectrum analyzer and system simulator via a power divider.
2. The RF output of EUT was connected to the spectrum analyzer by an RF cable and attenuator. The path loss was compensated to the results for each measurement.
3. The middle channel for the highest RF power within the transmitting frequency was measured.
4. The conducted spurious emission for the whole frequency range was taken.
5. The RF fundamental frequency should be excluded against the limit line in the operating frequency band.
6. The limit line is derived from  $43 + 10\log(P)$  dB below the transmitter power P(Watts)

### 3.4.4 Test Setup

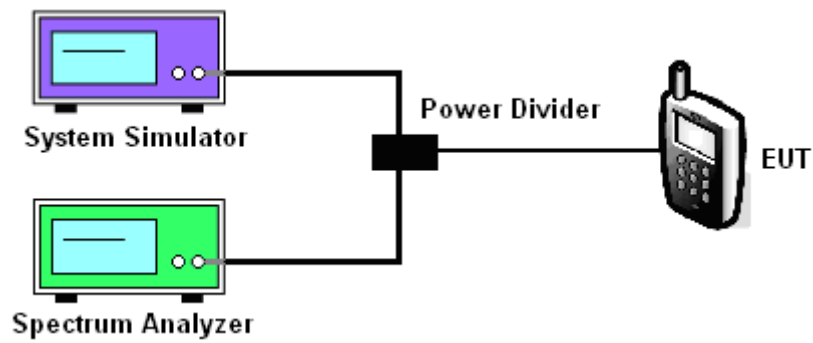

### 3.4.5 Test Result (Plots) of Conducted Spurious Emission

Please refer to Appendix A.



## **3.5 Field Strength of Spurious Radiation Measurement**

### **3.5.1 Description of Field Strength of Spurious Radiated Measurement**

The radiated spurious emission was measured by substitution method according to ANSI / TIA-603-E. The power of any emission FCC Part 90.691 on any frequency removed from the assigned frequency by more than 250 percent of the authorized bandwidth at least  $43 + 10 \log (P)$  dB. The spectrum is scanned from 30 MHz up to a frequency including its 10th harmonic.

The power of any emission outside of the authorized operating frequency ranges must be attenuated below the transmitter power (P) by a factor of at least  $43+10\log_{10}(P[\text{Watts}])$  dB. The spectrum is scanned from 30 MHz up to a frequency including its 10th harmonic.

### **3.5.2 Measuring Instruments**

The measuring equipment is listed in the section 4 of this test report.



### **3.5.3 Test Procedures**

1. The EUT was placed on a turntable with 0.8 meter for frequency below 1GHz and 1.5 meter for frequency above 1GHz respectively above ground.
2. The EUT was set 3 meters from the receiving antenna, which was mounted on the antenna tower.
3. The table was rotated 360 degrees to determine the position of the highest spurious emission.
4. The height of the receiving antenna is varied between one meter and four meters to search the maximum spurious emission for both horizontal and vertical polarizations.
5. Make the measurement with the spectrum analyzer's RBW = 1MHz, VBW = 3MHz, Sweep = 500ms, Taking the record of maximum spurious emission.
6. A horn antenna was substituted in place of the EUT and was driven by a signal generator.
7. Tune the output power of signal generator to the same emission level with EUT maximum spurious emission.
8. Taking the record of output power at antenna port.
9. Repeat step 7 to step 8 for another polarization.
10.  $EIRP \text{ (dBm)} = S.G. \text{ Power} - Tx \text{ Cable Loss} + Tx \text{ Antenna Gain}$
11.  $ERP \text{ (dBm)} = EIRP - 2.15$
12. The RF fundamental frequency should be excluded against the limit line in the operating frequency band.
13. The limit line is derived from  $43 + 10\log(P)$  dB below the transmitter power P(Watts)

### 3.5.4 Test Setup

For radiated emissions from 30MHz to 1GHz

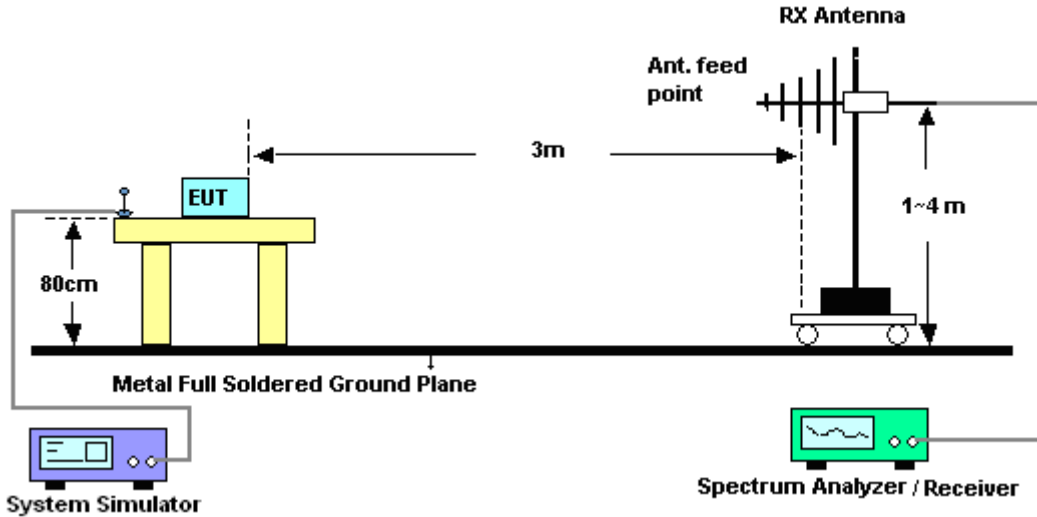

For radiated emissions above 1GHz

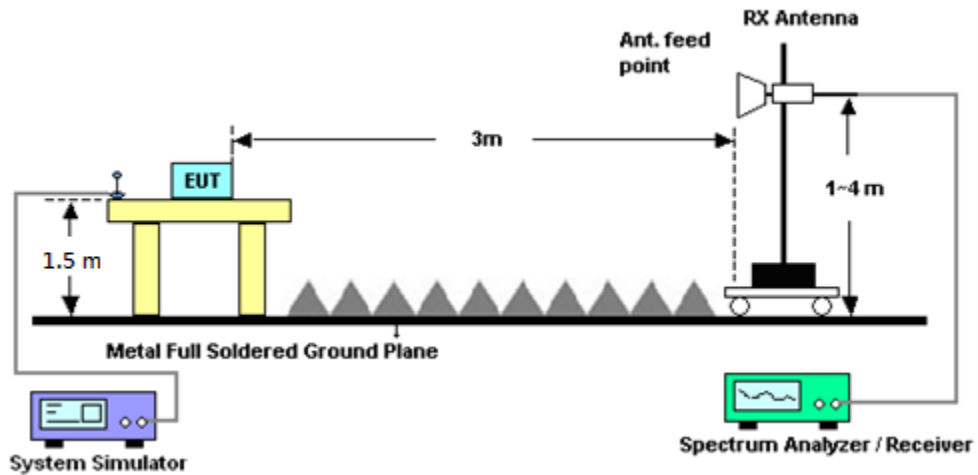

### 3.5.5 Test Result of Field Strength of Spurious Radiated

Please refer to Appendix B.



## **3.6 Frequency Stability Measurement**

### **3.6.1 Description of Frequency Stability Measurement**

The frequency stability shall be measured by variation of ambient temperature and variation of primary supply voltage to ensure that the fundamental emission stays within the authorized frequency block. The frequency stability of the transmitter shall be maintained within  $\pm 0.00025\%$  ( $\pm 2.5\text{ppm}$ ) of the center frequency according to FCC Part 90.213.

### **3.6.2 Measuring Instruments**

The measuring equipment is listed in the section 4 of this test report.

### **3.6.3 Test Procedures for Temperature Variation**

1. The EUT was set up in the thermal chamber and connected with the base station.
2. With power OFF, the temperature was decreased to  $-30^{\circ}\text{C}$  and the EUT was stabilized for three hours. Power was applied and the maximum change in frequency was recorded within one minute.
3. With power OFF, the temperature was raised in  $10^{\circ}\text{C}$  step up to  $50^{\circ}\text{C}$ . The EUT was stabilized at each step for at least half an hour. Power was applied and the maximum frequency change was recorded within one minute.

### **3.6.4 Test Procedures for Voltage Variation**

1. The EUT was placed in a temperature chamber at  $25\pm 5^{\circ}\text{C}$  and connected with the base station.
2. The power supply voltage to the EUT was varied from BEP to 115% of the nominal value measured at the input to the EUT.
3. The variation in frequency was measured for the worst case.

### 3.6.5 Test Setup

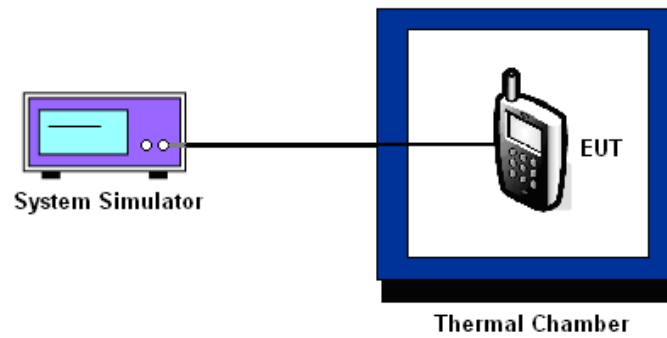

### 3.6.6 Test Result of Temperature Variation

Please refer to Appendix A.



## 4 List of Measuring Equipment

Instrument	Manufacturer	Model No.	Serial No.	Characteristics	Calibration Date	Test Date	Due Date	Remark
Spectrum Analyzer	Rohde & Schwarz	FSP30	101329	9kHz~30GHz	Jun. 26, 2017	Dec. 27, 2017~ Dec. 29, 2017	Jun. 25, 2018	Conducted (TH03-HY)
Temperature Chamber	ESPEC	SU-641	92013721	-30°C ~70°C	Nov. 16, 2016	Dec. 27, 2017~ Dec. 29, 2017	Nov. 15, 2018	Conducted (TH03-HY)
Programmable Power Supply	GW Instek	PSS-2005	EL883644	Voltage:0~20V;Current:0~5A	Nov. 22, 2016	Dec. 27, 2017~ Dec. 29, 2017	Nov. 21, 2018	Conducted (TH03-HY)
Base Station (Measure)	Rohde & Schwarz	CMU200	117995	GSM / GPRS / WCDMA / CDMA	Aug. 09, 2017	Dec. 27, 2017~ Dec. 29, 2017	Aug. 08, 2018	Conducted (TH03-HY)
Amplifier	MITEQ	TTA1840-35-HG	1871923	18GHz~40GHz, VSWR : 2.5:1 max	Jul. 18, 2017	Dec. 25, 2017~ Jan. 08, 2018	Jul. 17, 2018	Radiation (03CH12-HY)
Bilog Antenna	TESEQ	CBL 6111D&00800 N1D01N-06	35413&02	30MHz~1GHz	Dec. 18, 2017	Dec. 25, 2017~ Jan. 08, 2018	Dec. 17, 2018	Radiation (03CH12-HY)
Horn Antenna	SCHWARZBECK	BBHA 9120D	9120D-1328	1GHz ~ 18GHz	Oct. 20, 2017	Dec. 25, 2017~ Jan. 08, 2018	Oct. 19, 2018	Radiation (03CH12-HY)
Preamplifier	COM-POWER	PA-103	161075	10MHz~1GHz	Mar. 23, 2017	Dec. 25, 2017~ Jan. 08, 2018	Mar. 22, 2018	Radiation (03CH12-HY)
Preamplifier	Keysight	83017A	MY53270148	1GHz~26.5GHz	Jan. 12, 2017	Dec. 25, 2017~ Jan. 08, 2018	Jan. 11, 2018	Radiation (03CH12-HY)
Antenna Mast	EMEC	AM-BS-4500-B	N/A	1m~4m	N/A	Dec. 25, 2017~ Jan. 08, 2018	N/A	Radiation (03CH12-HY)
Turn Table	EMEC	TT2000	N/A	0~360 Degree	N/A	Dec. 25, 2017~ Jan. 08, 2018	N/A	Radiation (03CH12-HY)
SHF-EHF Horn Antenna	SCHWARZBECK	BBHA 9170	BBHA9170576	18GHz ~ 40GHz	Apr. 27, 2017	Dec. 25, 2017~ Jan. 08, 2018	Apr. 26, 2018	Radiation (03CH12-HY)
Spectrum Analyzer	Agilent	N9030A	MY52350276	3Hz~44GHz	Mar. 23, 2017	Dec. 25, 2017~ Jan. 08, 2018	Mar. 22, 2018	Radiation (03CH12HY)
Horn Antenna	SCHWARZBECK	BBHA 9120 D	BBHA 9120 D 1212	1GHz ~ 18GHz	Mar. 17, 2017	Dec. 25, 2017~ Jan. 08, 2018	Mar. 16, 2018	Radiation (03CH12-HY)
SHF-EHF Horn Antenna	SCHWARZBECK	BBHA 9170	BBHA9170584	18GHz- 40GHz	Nov. 27, 2017	Dec. 25, 2017~ Jan. 08, 2018	Nov. 26, 2018	Radiation (03CH12-HY)
Signal Generator	Rohde & Schwarz	SMF100A	101107	100kHz~40GHz	May 22, 2017	Dec. 25, 2017~ Jan. 08, 2018	May 21, 2018	Radiation (03CH12-HY)



## 5 Uncertainty of Evaluation

### Uncertainty of Radiated Emission Measurement (30 MHz ~ 1000 MHz)

Measuring Uncertainty for a Level of Confidence of 95% ( $U = 2Uc(y)$ )	5.1
---	-----

### Uncertainty of Radiated Emission Measurement (1 GHz ~ 18 GHz)

Measuring Uncertainty for a Level of Confidence of 95% ( $U = 2Uc(y)$ )	5.2
---	-----

### Uncertainty of Radiated Emission Measurement (18 GHz ~ 40 GHz)

Measuring Uncertainty for a Level of Confidence of 95% ( $U = 2Uc(y)$ )	4.7
---	-----



## Appendix A. Test Results of Conducted Test

### Conducted Output Power(Average power)

Conducted Power (*Unit: dBm)			
Band Channel	CDMA 2000 BC10		
	476	580	684
Frequency	817.9	820.5	823.1
1xRTT RC1 SO55	23.81	23.92	23.95
1xRTT RC3 SO55	23.89	23.94	24.06
1xRTT RC3 SO32 (+ F-SCH)	23.83	23.91	23.94
1xRTT RC3 SO32 (+SCH)	23.81	23.89	23.90
1xEVDO RTAP 153.6Kbps	23.88	23.93	24.05
1xEVDO RETAP 4096Bits	23.86	23.91	24.02



## A2. CDMA

### Peak-to-Average Ratio

Mode	CDMA BC10	CDMA BC10	Limit: 13dB
Mod.	1xRTT	1xEV-DO Rev. 0	Result
Lowest CH	3.40	3.44	PASS
Middle CH	3.52	3.48	
Highest CH	3.36	3.40	

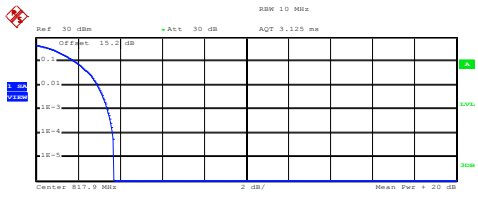
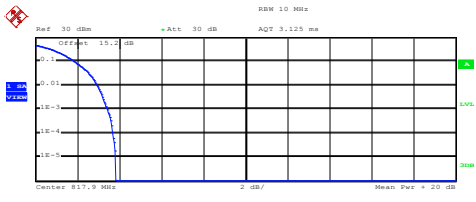
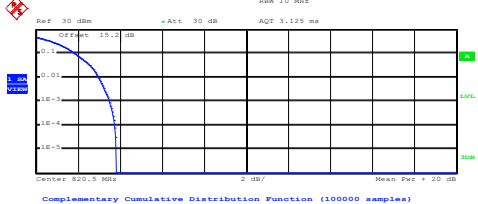
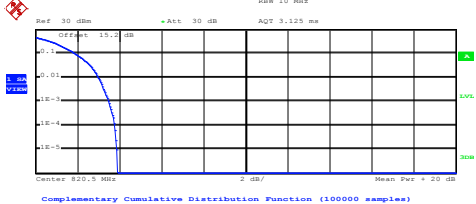
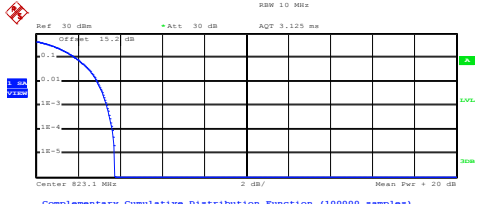
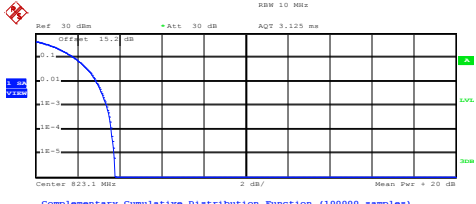

CDMA BC10 (1xRTT)	CDMA BC10 (1xEV-DO Rev. 0)
<p align="center"><b>Lowest Channel</b></p>  <p>Center 817.9 MHz      2 dB/      Mean Pwr + 20 dB</p> <p>Complementary Cumulative Distribution Function (100000 samples) Trace 1</p> <p>Mean    23.15 dBm Peak    26.86 dBm Crest    3.71 dB</p> <p>10 %    1.84 dB 1 %     2.92 dB .1 %    3.40 dB .01 %   3.64 dB</p> <p>Date: 29.DEC.2017 11:33:43</p>	<p align="center"><b>Lowest Channel</b></p>  <p>Center 817.9 MHz      2 dB/      Mean Pwr + 20 dB</p> <p>Complementary Cumulative Distribution Function (100000 samples) Trace 1</p> <p>Mean    23.04 dBm Peak    26.86 dBm Crest    3.83 dB</p> <p>10 %    1.88 dB 1 %     2.96 dB .1 %    3.44 dB .01 %   3.68 dB</p> <p>Date: 29.DEC.2017 11:31:20</p>
<p align="center"><b>Middle Channel</b></p>  <p>Center 820.5 MHz      2 dB/      Mean Pwr + 20 dB</p> <p>Complementary Cumulative Distribution Function (100000 samples) Trace 1</p> <p>Mean    23.04 dBm Peak    26.86 dBm Crest    3.82 dB</p> <p>10 %    1.88 dB 1 %     3.00 dB .1 %    3.52 dB .01 %   3.76 dB</p> <p>Date: 29.DEC.2017 11:34:01</p>	<p align="center"><b>Middle Channel</b></p>  <p>Center 820.5 MHz      2 dB/      Mean Pwr + 20 dB</p> <p>Complementary Cumulative Distribution Function (100000 samples) Trace 1</p> <p>Mean    22.95 dBm Peak    26.86 dBm Crest    3.91 dB</p> <p>10 %    1.92 dB 1 %     3.00 dB .1 %    3.48 dB .01 %   3.76 dB</p> <p>Date: 29.DEC.2017 11:31:45</p>
<p align="center"><b>Highest Channel</b></p>  <p>Center 823.1 MHz      2 dB/      Mean Pwr + 20 dB</p> <p>Complementary Cumulative Distribution Function (100000 samples) Trace 1</p> <p>Mean    23.11 dBm Peak    26.86 dBm Crest    3.75 dB</p> <p>10 %    1.88 dB 1 %     2.92 dB .1 %    3.36 dB .01 %   3.64 dB</p> <p>Date: 29.DEC.2017 11:34:13</p>	<p align="center"><b>Highest Channel</b></p>  <p>Center 823.1 MHz      2 dB/      Mean Pwr + 20 dB</p> <p>Complementary Cumulative Distribution Function (100000 samples) Trace 1</p> <p>Mean    23.08 dBm Peak    26.86 dBm Crest    3.78 dB</p> <p>10 %    1.84 dB 1 %     2.88 dB .1 %    3.40 dB .01 %   3.60 dB</p> <p>Date: 29.DEC.2017 11:32:11</p>



**26dB Bandwidth**

Mode	CDMA BC10	CDMA BC10
Mod.	1xRTT	1xEV-DO Rev. 0
Lowest CH	1.42	1.42
Middle CH	1.43	1.42
Highest CH	1.42	1.43



CDMA BC10 (1xRTT)

Lowest Channel

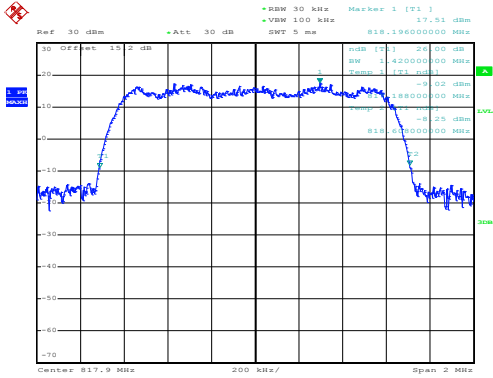

Date: 29.DEC.2017 10:43:24

CDMA BC10 (1xEV-DO Rev. 0)

Lowest Channel

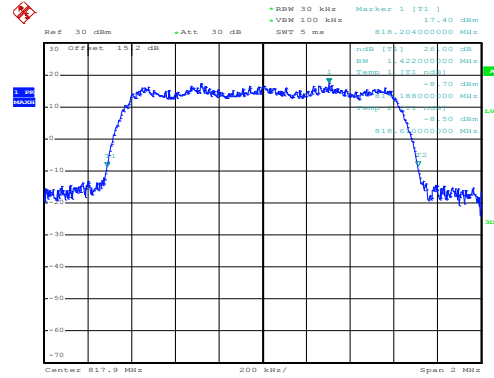

Date: 29.DEC.2017 11:09:06

Middle Channel

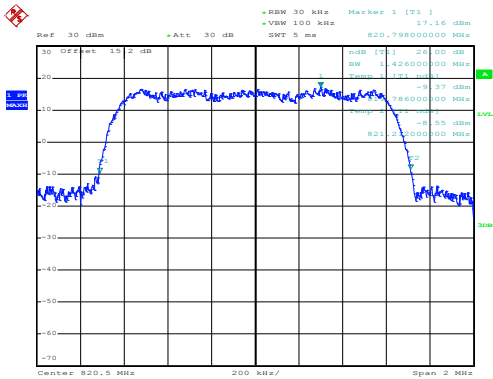

Date: 29.DEC.2017 10:43:56

Middle Channel

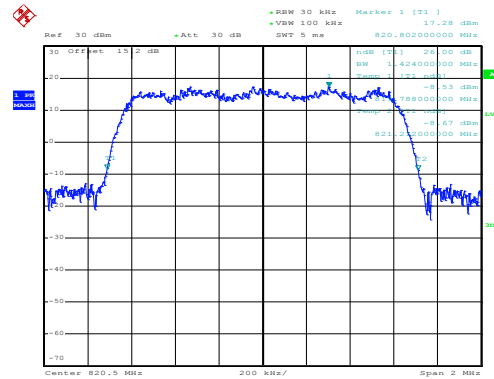

Date: 29.DEC.2017 11:09:39

Highest Channel

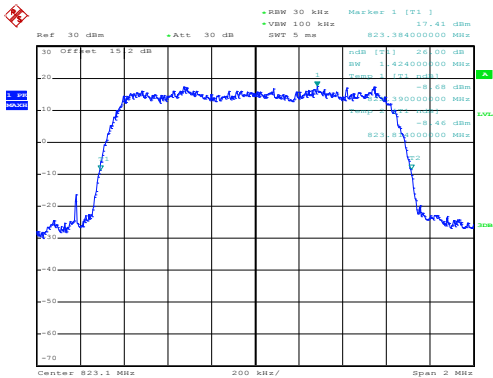

Date: 29.DEC.2017 10:44:28

Highest Channel

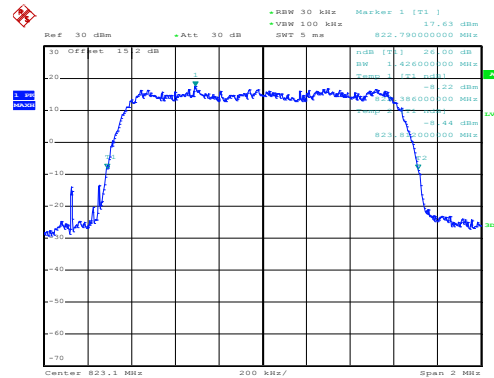

Date: 29.DEC.2017 11:10:12



## Occupied Bandwidth

Mode	CDMA BC10	CDMA BC10
Mod.	1xRTT	1xEV-DO Rev. 0
Lowest CH	1.27	1.28
Middle CH	1.28	1.27
Highest CH	1.27	1.28



CDMA BC10 (1xRTT)

Lowest Channel

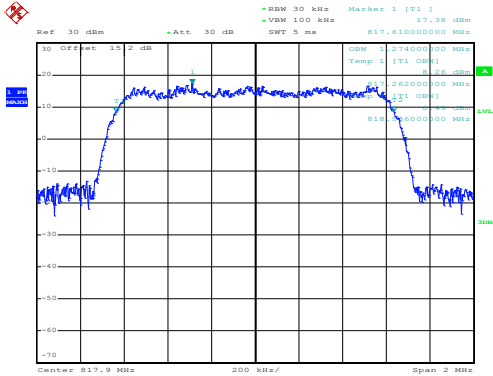

Date: 29.DEC.2017 10:45:06

CDMA BC10 (1xEV-DO Rev. 0)

Lowest Channel

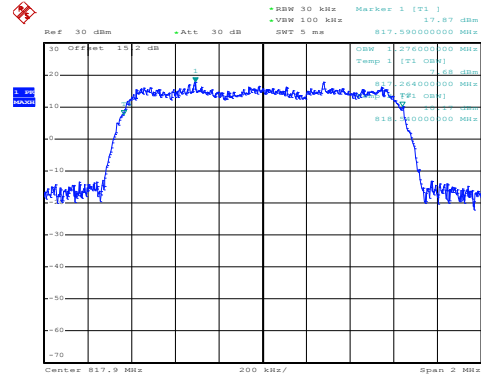

Date: 29.DEC.2017 11:10:48

Middle Channel

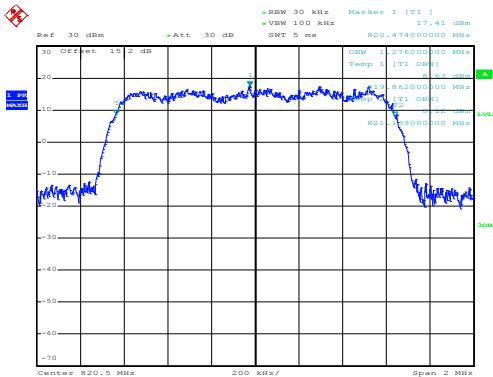

Date: 29.DEC.2017 10:45:38

Middle Channel

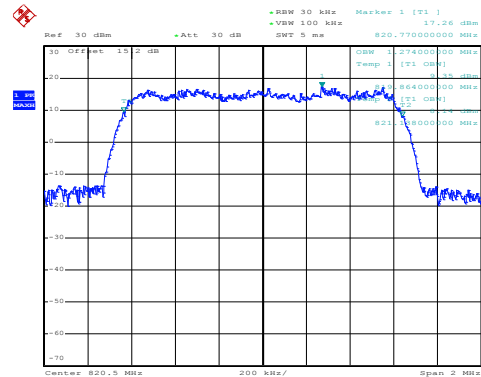

Date: 29.DEC.2017 11:11:19

Highest Channel

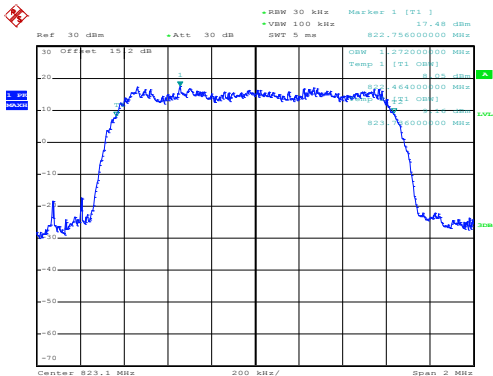

Date: 29.DEC.2017 10:46:12

Highest Channel

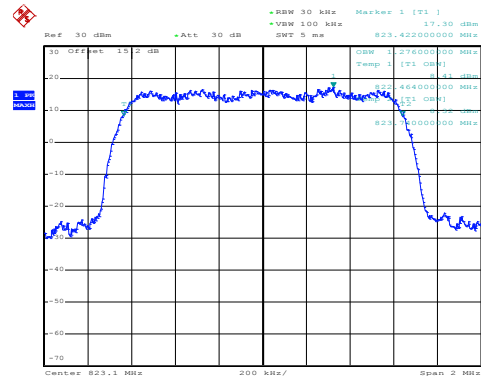

Date: 29.DEC.2017 11:11:53



# Conducted Band Edge

## CDMA BC10 (1xRTT)

### Lowest Band Edge

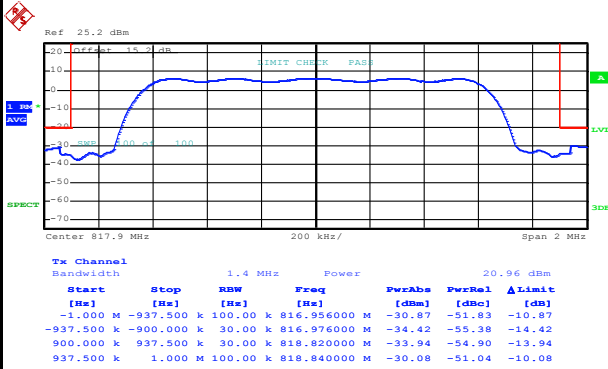

Date: 29.DEC.2017 10:48:59

### Highest Band Edge

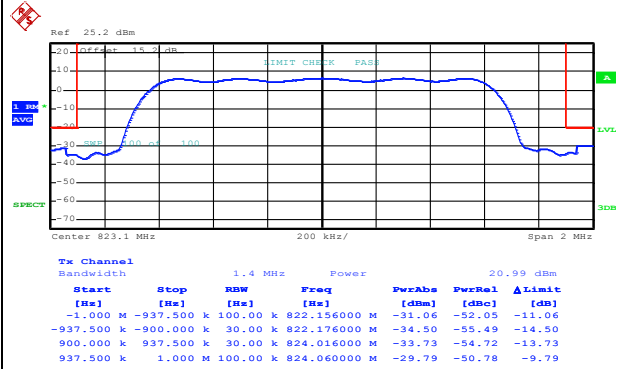

Date: 29.DEC.2017 10:51:47

## CDMA BC10 (1xEV-DO Rev. 0)

### Lowest Band Edge

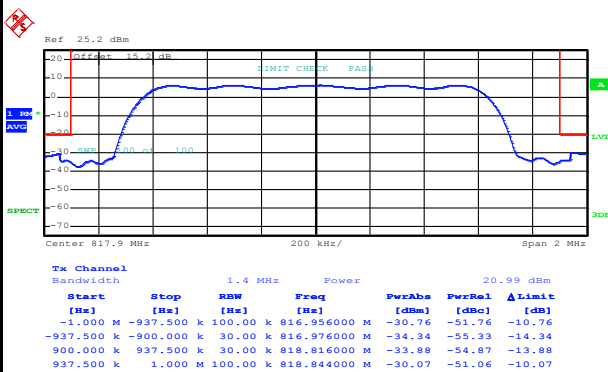

Date: 29.DEC.2017 11:14:41

### Highest Band Edge

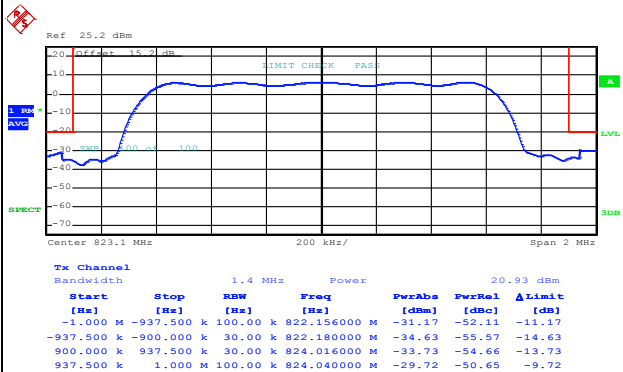

Date: 29.DEC.2017 11:17:28

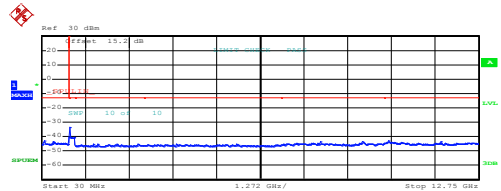
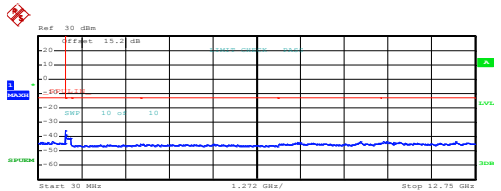
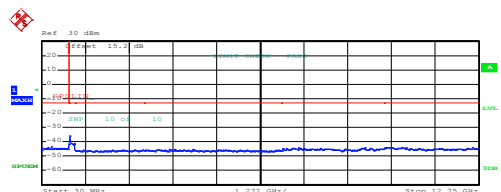
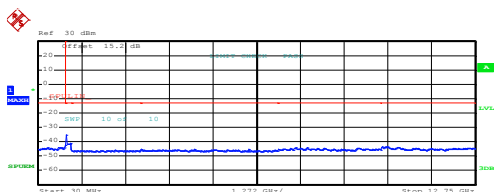
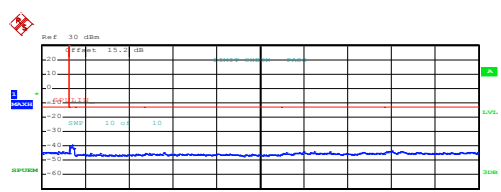
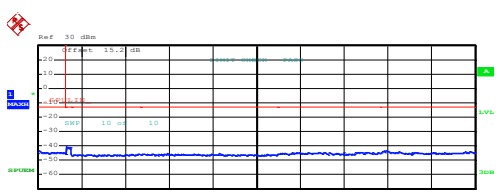

# Conducted Spurious Emission

CDMA BC10 (1xRTT)	CDMA BC10 (1xEV-DO Rev. 0)																																																																																				
Lowest Channel	Lowest Channel																																																																																				
 <table border="1"> <thead> <tr> <th>Start [Hz]</th> <th>Stop [Hz]</th> <th>RBW [Hz]</th> <th>Freq [Hz]</th> <th>PwrAbs [dBm]</th> <th>ΔLimit [dB]</th> </tr> </thead> <tbody> <tr> <td>30,000 M</td> <td>813,250 M</td> <td>100.00 k</td> <td>810,990000 M</td> <td>-40.92</td> <td>-27.32</td> </tr> <tr> <td>827,750 M</td> <td>1,000 G</td> <td>100.00 k</td> <td>828,783500 M</td> <td>-33.70</td> <td>-20.70</td> </tr> <tr> <td>1,000 G</td> <td>3,000 G</td> <td>100.00 k</td> <td>1,534000 G</td> <td>-44.89</td> <td>-31.89</td> </tr> <tr> <td>3,000 G</td> <td>7,000 G</td> <td>100.00 k</td> <td>5,700000 G</td> <td>-45.24</td> <td>-32.34</td> </tr> <tr> <td>7,000 G</td> <td>10,000 G</td> <td>100.00 k</td> <td>9,356500 G</td> <td>-43.47</td> <td>-30.47</td> </tr> <tr> <td>10,000 G</td> <td>12,750 G</td> <td>100.00 k</td> <td>10,121000 G</td> <td>-43.05</td> <td>-30.05</td> </tr> </tbody> </table> <p>Date: 29.DEC.2017 10:52:44</p>	Start [Hz]	Stop [Hz]	RBW [Hz]	Freq [Hz]	PwrAbs [dBm]	ΔLimit [dB]	30,000 M	813,250 M	100.00 k	810,990000 M	-40.92	-27.32	827,750 M	1,000 G	100.00 k	828,783500 M	-33.70	-20.70	1,000 G	3,000 G	100.00 k	1,534000 G	-44.89	-31.89	3,000 G	7,000 G	100.00 k	5,700000 G	-45.24	-32.34	7,000 G	10,000 G	100.00 k	9,356500 G	-43.47	-30.47	10,000 G	12,750 G	100.00 k	10,121000 G	-43.05	-30.05	 <table border="1"> <thead> <tr> <th>Start [Hz]</th> <th>Stop [Hz]</th> <th>RBW [Hz]</th> <th>Freq [Hz]</th> <th>PwrAbs [dBm]</th> <th>ΔLimit [dB]</th> </tr> </thead> <tbody> <tr> <td>30,000 M</td> <td>813,250 M</td> <td>100.00 k</td> <td>812,958375 M</td> <td>-39.98</td> <td>-22.58</td> </tr> <tr> <td>827,750 M</td> <td>1,000 G</td> <td>100.00 k</td> <td>833,348125 M</td> <td>-38.48</td> <td>-25.48</td> </tr> <tr> <td>1,000 G</td> <td>3,000 G</td> <td>100.00 k</td> <td>2,372000 G</td> <td>-45.48</td> <td>-32.48</td> </tr> <tr> <td>3,000 G</td> <td>7,000 G</td> <td>100.00 k</td> <td>5,136000 G</td> <td>-43.36</td> <td>-32.36</td> </tr> <tr> <td>7,000 G</td> <td>10,000 G</td> <td>100.00 k</td> <td>9,422500 G</td> <td>-43.38</td> <td>-30.38</td> </tr> <tr> <td>10,000 G</td> <td>12,750 G</td> <td>100.00 k</td> <td>10,075625 G</td> <td>-43.41</td> <td>-30.41</td> </tr> </tbody> </table> <p>Date: 29.DEC.2017 11:18:36</p>	Start [Hz]	Stop [Hz]	RBW [Hz]	Freq [Hz]	PwrAbs [dBm]	ΔLimit [dB]	30,000 M	813,250 M	100.00 k	812,958375 M	-39.98	-22.58	827,750 M	1,000 G	100.00 k	833,348125 M	-38.48	-25.48	1,000 G	3,000 G	100.00 k	2,372000 G	-45.48	-32.48	3,000 G	7,000 G	100.00 k	5,136000 G	-43.36	-32.36	7,000 G	10,000 G	100.00 k	9,422500 G	-43.38	-30.38	10,000 G	12,750 G	100.00 k	10,075625 G	-43.41	-30.41
Start [Hz]	Stop [Hz]	RBW [Hz]	Freq [Hz]	PwrAbs [dBm]	ΔLimit [dB]																																																																																
30,000 M	813,250 M	100.00 k	810,990000 M	-40.92	-27.32																																																																																
827,750 M	1,000 G	100.00 k	828,783500 M	-33.70	-20.70																																																																																
1,000 G	3,000 G	100.00 k	1,534000 G	-44.89	-31.89																																																																																
3,000 G	7,000 G	100.00 k	5,700000 G	-45.24	-32.34																																																																																
7,000 G	10,000 G	100.00 k	9,356500 G	-43.47	-30.47																																																																																
10,000 G	12,750 G	100.00 k	10,121000 G	-43.05	-30.05																																																																																
Start [Hz]	Stop [Hz]	RBW [Hz]	Freq [Hz]	PwrAbs [dBm]	ΔLimit [dB]																																																																																
30,000 M	813,250 M	100.00 k	812,958375 M	-39.98	-22.58																																																																																
827,750 M	1,000 G	100.00 k	833,348125 M	-38.48	-25.48																																																																																
1,000 G	3,000 G	100.00 k	2,372000 G	-45.48	-32.48																																																																																
3,000 G	7,000 G	100.00 k	5,136000 G	-43.36	-32.36																																																																																
7,000 G	10,000 G	100.00 k	9,422500 G	-43.38	-30.38																																																																																
10,000 G	12,750 G	100.00 k	10,075625 G	-43.41	-30.41																																																																																
Middle Channel	Middle Channel																																																																																				
 <table border="1"> <thead> <tr> <th>Start [Hz]</th> <th>Stop [Hz]</th> <th>RBW [Hz]</th> <th>Freq [Hz]</th> <th>PwrAbs [dBm]</th> <th>ΔLimit [dB]</th> </tr> </thead> <tbody> <tr> <td>30,000 M</td> <td>813,250 M</td> <td>100.00 k</td> <td>811,291875 M</td> <td>-41.69</td> <td>-28.69</td> </tr> <tr> <td>827,750 M</td> <td>1,000 G</td> <td>100.00 k</td> <td>829,538625 M</td> <td>-35.79</td> <td>-22.79</td> </tr> <tr> <td>1,000 G</td> <td>3,000 G</td> <td>100.00 k</td> <td>2,598000 G</td> <td>-45.26</td> <td>-32.26</td> </tr> <tr> <td>3,000 G</td> <td>7,000 G</td> <td>100.00 k</td> <td>4,438000 G</td> <td>-45.26</td> <td>-32.26</td> </tr> <tr> <td>7,000 G</td> <td>10,000 G</td> <td>100.00 k</td> <td>7,519000 G</td> <td>-43.73</td> <td>-30.73</td> </tr> <tr> <td>10,000 G</td> <td>12,750 G</td> <td>100.00 k</td> <td>10,118875 G</td> <td>-43.77</td> <td>-30.77</td> </tr> </tbody> </table> <p>Date: 29.DEC.2017 10:53:34</p>	Start [Hz]	Stop [Hz]	RBW [Hz]	Freq [Hz]	PwrAbs [dBm]	ΔLimit [dB]	30,000 M	813,250 M	100.00 k	811,291875 M	-41.69	-28.69	827,750 M	1,000 G	100.00 k	829,538625 M	-35.79	-22.79	1,000 G	3,000 G	100.00 k	2,598000 G	-45.26	-32.26	3,000 G	7,000 G	100.00 k	4,438000 G	-45.26	-32.26	7,000 G	10,000 G	100.00 k	7,519000 G	-43.73	-30.73	10,000 G	12,750 G	100.00 k	10,118875 G	-43.77	-30.77	 <table border="1"> <thead> <tr> <th>Start [Hz]</th> <th>Stop [Hz]</th> <th>RBW [Hz]</th> <th>Freq [Hz]</th> <th>PwrAbs [dBm]</th> <th>ΔLimit [dB]</th> </tr> </thead> <tbody> <tr> <td>30,000 M</td> <td>813,250 M</td> <td>100.00 k</td> <td>810,117000 M</td> <td>-42.46</td> <td>-29.46</td> </tr> <tr> <td>827,750 M</td> <td>1,000 G</td> <td>100.00 k</td> <td>829,538625 M</td> <td>-34.91</td> <td>-21.91</td> </tr> <tr> <td>1,000 G</td> <td>3,000 G</td> <td>100.00 k</td> <td>2,737000 G</td> <td>-43.02</td> <td>-30.02</td> </tr> <tr> <td>3,000 G</td> <td>7,000 G</td> <td>100.00 k</td> <td>4,572000 G</td> <td>-45.28</td> <td>-32.28</td> </tr> <tr> <td>7,000 G</td> <td>10,000 G</td> <td>100.00 k</td> <td>7,938500 G</td> <td>-44.14</td> <td>-31.14</td> </tr> <tr> <td>10,000 G</td> <td>12,750 G</td> <td>100.00 k</td> <td>10,119500 G</td> <td>-43.23</td> <td>-30.23</td> </tr> </tbody> </table> <p>Date: 29.DEC.2017 11:19:27</p>	Start [Hz]	Stop [Hz]	RBW [Hz]	Freq [Hz]	PwrAbs [dBm]	ΔLimit [dB]	30,000 M	813,250 M	100.00 k	810,117000 M	-42.46	-29.46	827,750 M	1,000 G	100.00 k	829,538625 M	-34.91	-21.91	1,000 G	3,000 G	100.00 k	2,737000 G	-43.02	-30.02	3,000 G	7,000 G	100.00 k	4,572000 G	-45.28	-32.28	7,000 G	10,000 G	100.00 k	7,938500 G	-44.14	-31.14	10,000 G	12,750 G	100.00 k	10,119500 G	-43.23	-30.23
Start [Hz]	Stop [Hz]	RBW [Hz]	Freq [Hz]	PwrAbs [dBm]	ΔLimit [dB]																																																																																
30,000 M	813,250 M	100.00 k	811,291875 M	-41.69	-28.69																																																																																
827,750 M	1,000 G	100.00 k	829,538625 M	-35.79	-22.79																																																																																
1,000 G	3,000 G	100.00 k	2,598000 G	-45.26	-32.26																																																																																
3,000 G	7,000 G	100.00 k	4,438000 G	-45.26	-32.26																																																																																
7,000 G	10,000 G	100.00 k	7,519000 G	-43.73	-30.73																																																																																
10,000 G	12,750 G	100.00 k	10,118875 G	-43.77	-30.77																																																																																
Start [Hz]	Stop [Hz]	RBW [Hz]	Freq [Hz]	PwrAbs [dBm]	ΔLimit [dB]																																																																																
30,000 M	813,250 M	100.00 k	810,117000 M	-42.46	-29.46																																																																																
827,750 M	1,000 G	100.00 k	829,538625 M	-34.91	-21.91																																																																																
1,000 G	3,000 G	100.00 k	2,737000 G	-43.02	-30.02																																																																																
3,000 G	7,000 G	100.00 k	4,572000 G	-45.28	-32.28																																																																																
7,000 G	10,000 G	100.00 k	7,938500 G	-44.14	-31.14																																																																																
10,000 G	12,750 G	100.00 k	10,119500 G	-43.23	-30.23																																																																																
Highest Channel	Highest Channel																																																																																				
 <table border="1"> <thead> <tr> <th>Start [Hz]</th> <th>Stop [Hz]</th> <th>RBW [Hz]</th> <th>Freq [Hz]</th> <th>PwrAbs [dBm]</th> <th>ΔLimit [dB]</th> </tr> </thead> <tbody> <tr> <td>30,000 M</td> <td>813,250 M</td> <td>100.00 k</td> <td>911,613000 M</td> <td>-42.83</td> <td>-30.83</td> </tr> <tr> <td>827,750 M</td> <td>1,000 G</td> <td>100.00 k</td> <td>911,032875 M</td> <td>-39.56</td> <td>-26.56</td> </tr> <tr> <td>1,000 G</td> <td>3,000 G</td> <td>100.00 k</td> <td>1,744000 G</td> <td>-45.19</td> <td>-32.19</td> </tr> <tr> <td>3,000 G</td> <td>7,000 G</td> <td>100.00 k</td> <td>3,600000 G</td> <td>-44.73</td> <td>-31.73</td> </tr> <tr> <td>7,000 G</td> <td>10,000 G</td> <td>100.00 k</td> <td>8,419000 G</td> <td>-44.19</td> <td>-31.19</td> </tr> <tr> <td>10,000 G</td> <td>12,750 G</td> <td>100.00 k</td> <td>10,237875 G</td> <td>-43.56</td> <td>-30.56</td> </tr> </tbody> </table> <p>Date: 29.DEC.2017 10:54:24</p>	Start [Hz]	Stop [Hz]	RBW [Hz]	Freq [Hz]	PwrAbs [dBm]	ΔLimit [dB]	30,000 M	813,250 M	100.00 k	911,613000 M	-42.83	-30.83	827,750 M	1,000 G	100.00 k	911,032875 M	-39.56	-26.56	1,000 G	3,000 G	100.00 k	1,744000 G	-45.19	-32.19	3,000 G	7,000 G	100.00 k	3,600000 G	-44.73	-31.73	7,000 G	10,000 G	100.00 k	8,419000 G	-44.19	-31.19	10,000 G	12,750 G	100.00 k	10,237875 G	-43.56	-30.56	 <table border="1"> <thead> <tr> <th>Start [Hz]</th> <th>Stop [Hz]</th> <th>RBW [Hz]</th> <th>Freq [Hz]</th> <th>PwrAbs [dBm]</th> <th>ΔLimit [dB]</th> </tr> </thead> <tbody> <tr> <td>30,000 M</td> <td>813,250 M</td> <td>100.00 k</td> <td>58,197000 M</td> <td>-43.65</td> <td>-30.65</td> </tr> <tr> <td>827,750 M</td> <td>1,000 G</td> <td>100.00 k</td> <td>830,592125 M</td> <td>-40.41</td> <td>-27.41</td> </tr> <tr> <td>1,000 G</td> <td>3,000 G</td> <td>100.00 k</td> <td>1,333000 G</td> <td>-45.57</td> <td>-32.57</td> </tr> <tr> <td>3,000 G</td> <td>7,000 G</td> <td>100.00 k</td> <td>3,750000 G</td> <td>-45.22</td> <td>-32.22</td> </tr> <tr> <td>7,000 G</td> <td>10,000 G</td> <td>100.00 k</td> <td>7,421500 G</td> <td>-44.30</td> <td>-31.30</td> </tr> <tr> <td>10,000 G</td> <td>12,750 G</td> <td>100.00 k</td> <td>10,112750 G</td> <td>-43.46</td> <td>-30.46</td> </tr> </tbody> </table> <p>Date: 29.DEC.2017 11:20:17</p>	Start [Hz]	Stop [Hz]	RBW [Hz]	Freq [Hz]	PwrAbs [dBm]	ΔLimit [dB]	30,000 M	813,250 M	100.00 k	58,197000 M	-43.65	-30.65	827,750 M	1,000 G	100.00 k	830,592125 M	-40.41	-27.41	1,000 G	3,000 G	100.00 k	1,333000 G	-45.57	-32.57	3,000 G	7,000 G	100.00 k	3,750000 G	-45.22	-32.22	7,000 G	10,000 G	100.00 k	7,421500 G	-44.30	-31.30	10,000 G	12,750 G	100.00 k	10,112750 G	-43.46	-30.46
Start [Hz]	Stop [Hz]	RBW [Hz]	Freq [Hz]	PwrAbs [dBm]	ΔLimit [dB]																																																																																
30,000 M	813,250 M	100.00 k	911,613000 M	-42.83	-30.83																																																																																
827,750 M	1,000 G	100.00 k	911,032875 M	-39.56	-26.56																																																																																
1,000 G	3,000 G	100.00 k	1,744000 G	-45.19	-32.19																																																																																
3,000 G	7,000 G	100.00 k	3,600000 G	-44.73	-31.73																																																																																
7,000 G	10,000 G	100.00 k	8,419000 G	-44.19	-31.19																																																																																
10,000 G	12,750 G	100.00 k	10,237875 G	-43.56	-30.56																																																																																
Start [Hz]	Stop [Hz]	RBW [Hz]	Freq [Hz]	PwrAbs [dBm]	ΔLimit [dB]																																																																																
30,000 M	813,250 M	100.00 k	58,197000 M	-43.65	-30.65																																																																																
827,750 M	1,000 G	100.00 k	830,592125 M	-40.41	-27.41																																																																																
1,000 G	3,000 G	100.00 k	1,333000 G	-45.57	-32.57																																																																																
3,000 G	7,000 G	100.00 k	3,750000 G	-45.22	-32.22																																																																																
7,000 G	10,000 G	100.00 k	7,421500 G	-44.30	-31.30																																																																																
10,000 G	12,750 G	100.00 k	10,112750 G	-43.46	-30.46																																																																																



Frequency Stability

Test Conditions	Middle Channel	CDMA BC10 (1xRTT)	Limit Note 2.
Temperature (°C)	Voltage (Volt)	Deviation (ppm)	Result
50	Normal Voltage	0.0061	PASS
40	Normal Voltage	0.0073	
30	Normal Voltage	0.0427	
20(Ref.)	Normal Voltage	0.0000	
10	Normal Voltage	0.0414	
0	Normal Voltage	0.0000	
-10	Normal Voltage	0.0012	
-20	Normal Voltage	0.0037	
-30	Normal Voltage	0.0012	
20	Maximum Voltage	0.0073	
20	Normal Voltage	0.0000	
20	Battery End Point	0.0061	

Test Conditions	Middle Channel	CDMA BC10 (EVDO)	Limit Note 2.
Temperature (°C)	Voltage (Volt)	Deviation (ppm)	Result
50	Normal Voltage	0.0061	PASS
40	Normal Voltage	0.0012	
30	Normal Voltage	0.0037	
20(Ref.)	Normal Voltage	0.0000	
10	Normal Voltage	0.0451	
0	Normal Voltage	0.0012	
-10	Normal Voltage	0.0024	
-20	Normal Voltage	0.0037	
-30	Normal Voltage	0.0061	
20	Maximum Voltage	0.0049	
20	Normal Voltage	0.0098	
20	Battery End Point	0.0037	

Note:

1. Normal Voltage = 3.8V. ; Battery End Point (BEP) = 3.5 V. ; Maximum Voltage =4.4 V
2. The frequency fundamental emissions stay within the authorized frequency block.



## Appendix B. Test Results of ERP/EIRP and Radiated Test

### ERP/EIRP

Channel	Mode	Conducted		EIRP	
		Power (dBm)	Power (Watts)	EIRP(dBm)	EIRP(W)
Lowest	CDMA BC10	23.89	0.2449	23.30	0.2138
Middle	1xRTT	23.94	0.2477	23.35	0.2163
Highest	GT - LC = -0.59 dB	24.06	0.2547	23.47	0.2223
Lowest	CDMA BC10	23.88	0.2443	23.29	0.2133
Middle	1xEV-DO	23.93	0.2472	23.34	0.2158
Highest	GT - LC = -0.59 dB	24.05	0.2541	23.46	0.2218
Limit	EIRP < 2W	Result		PASS	



**Radiated Spurious Emission**

**Part90S CDMA BC10 1xRTT**

Mode 4_CDMA 1900 1xRTT									
Channel	Frequency ( MHz )	EIRP ( dBm )	Limit ( dBm )	Over Limit ( dB )	SPA Reading (dBm)	S.G. Power ( dBm )	TX Cable loss ( dB )	TX Antenna Gain (dBi)	Polarization (H/V)
Lowest	1632	-65.18	-13	-52.18	-74.74	-70.51	1.22	8.70	H
	2456	-62.61	-13	-49.61	-75.26	-69.49	1.43	10.46	H
	3272	-60.77	-13	-47.77	-75.62	-68.65	1.68	11.72	H
									H
									H
									H
									H
	1632	-66.25	-13	-53.25	-74.69	-71.58	1.22	8.70	V
	2456	-62.60	-13	-49.60	-74.95	-69.48	1.43	10.46	V
	3272	-60.74	-13	-47.74	-75.38	-68.62	1.68	11.72	V
									V
									V
									V
									V
Middle	1640	-64.72	-13	-51.72	-74.18	-70.08	1.22	8.73	H
	2464	-60.36	-13	-47.36	-73.01	-67.25	1.43	10.47	H
	3280	-60.65	-13	-47.65	-75.5	-68.55	1.69	11.74	H
									H
									H
									H
									H
	1640	-65.48	-13	-52.48	-73.96	-70.84	1.22	8.73	V
	2464	-62.11	-13	-49.11	-74.46	-69.00	1.43	10.47	V
	3280	-60.85	-13	-47.85	-75.49	-68.75	1.69	11.74	V
									V
									V
									V
									V



Highest	1648	-65.33	-13	-52.33	-74.79	-70.72	1.23	8.76	H
	2472	-62.85	-13	-49.85	-75.43	-69.74	1.44	10.48	H
	3288	-60.52	-13	-47.52	-75.31	-68.44	1.70	11.76	H
									H
									H
									H
									H
	1648	-66.11	-13	-53.11	-74.59	-71.50	1.23	8.76	V
	2472	-63.38	-13	-50.38	-75.63	-70.27	1.44	10.48	V
	3288	-60.75	-13	-47.75	-75.34	-68.67	1.70	11.76	V
									V
									V
									V
									V

Remark: Spurious emissions within 30-1000MHz were found more than 20dB below limit line.



**Part90S CDMA BC10 1xEVDO**

Mode 5_ 1900 1xEVDO									
Channel	Frequency ( MHz )	EIRP ( dBm )	Limit ( dBm )	Over Limit ( dB )	SPA Reading (dBm)	S.G. Power ( dBm )	TX Cable loss ( dB )	TX Antenna Gain (dBi)	Polarization (H/V)
Lowest	1632	-64.81	-13	-51.81	-74.37	-70.14	1.22	8.70	H
	2456	-62.29	-13	-49.29	-74.94	-69.17	1.43	10.46	H
	3272	-60.43	-13	-47.43	-75.28	-68.31	1.68	11.72	H
									H
									H
									H
									H
	1632	-65.83	-13	-52.83	-74.27	-71.16	1.22	8.70	V
	2456	-62.79	-13	-49.79	-75.14	-69.67	1.43	10.46	V
	3272	-60.67	-13	-47.67	-75.31	-68.55	1.68	11.72	V
									V
									V
									V
									V
Middle	1640	-64.77	-13	-51.77	-74.23	-70.13	1.22	8.73	H
	2464	-62.54	-13	-49.54	-75.19	-69.43	1.43	10.47	H
	3280	-60.26	-13	-47.26	-75.11	-68.16	1.69	11.74	H
									H
									H
									H
									H
	1640	-65.92	-13	-52.92	-74.4	-71.28	1.22	8.73	V
	2464	-62.79	-13	-49.79	-75.14	-69.68	1.43	10.47	V
	3280	-60.31	-13	-47.31	-74.95	-68.21	1.69	11.74	V
									V
									V
									V
									V



Highest	1648	-65.38	-13	-52.38	-74.84	-70.77	1.23	8.76	H
	2472	-57.91	-13	-44.91	-70.49	-64.80	1.44	10.48	H
	3288	-60.61	-13	-47.61	-75.4	-68.53	1.70	11.76	H
									H
									H
									H
									H
	1648	-73.60	-13	-60.60	-74.6	-78.99	1.23	8.76	V
	2472	-74.08	-13	-61.08	-75.08	-80.97	1.44	10.48	V
	3288	-74.13	-13	-61.13	-75.13	-82.05	1.70	11.76	V
									V
									V
									V
									V

Remark: Spurious emissions within 30-1000MHz were found more than 20dB below limit line.