



FCC RF Test Report

APPLICANT : Motorola Mobility LLC
EQUIPMENT : Mobile Cellular Phone
BRAND NAME : Motorola
MODEL NAME : XT1921-6, XT1921-1
FCC ID : IHDT56XC1
STANDARD : FCC Part 15 Subpart E §15.407
CLASSIFICATION : (NII) Unlicensed National Information Infrastructure

The product was received on Dec. 20, 2017 and testing was completed on Jan. 21, 2018. We, SPORTON INTERNATIONAL INC., would like to declare that the tested sample has been evaluated in accordance with the test procedures and has been in compliance with the applicable technical standards.

The test results in this report apply exclusively to the tested model / sample. Without written approval of SPORTON INTERNATIONAL INC., the test report shall not be reproduced except in full.

Reviewed by: Joseph Lin / Supervisor

Approved by: Jones Tsai / Manager



SPORTON INTERNATIONAL INC.

No. 52, Hwa Ya 1st Rd., Hwa Ya Technology Park, Kwei-Shan District, Tao Yuan City, Taiwan, R.O.C.

SPORTON INTERNATIONAL INC.

TEL : 886-3-327-3456

FAX : 886-3-328-4978

FCC ID: IHDT56XC1

Page Number : 1 of 28

Report Issued Date : Feb. 22, 2018

Report Version : Rev. 01

Report Template No.: BU5-FR15EWLB4 AC MA Version 1.4



TABLE OF CONTENTS

REVISION HISTORY.....3

SUMMARY OF TEST RESULT4

1 GENERAL DESCRIPTION5

 1.1 Applicant5

 1.2 Manufacturer5

 1.3 Product Feature of Equipment Under Test.....5

 1.4 Product Specification of Equipment Under Test.....6

 1.5 Modification of EUT6

 1.6 Testing Location7

 1.7 Applicable Standards7

2 TEST CONFIGURATION OF EQUIPMENT UNDER TEST8

 2.1 Carrier Frequency and Channel8

 2.2 Test Mode9

 2.3 Connection Diagram of Test System10

 2.4 Support Unit used in test configuration and system11

 2.5 EUT Operation Test Setup11

 2.6 Measurement Results Explanation Example11

3 TEST RESULT12

 3.1 6dB and 26dB and 99% Occupied Bandwidth Measurement12

 3.2 Maximum Conducted Output Power Measurement15

 3.3 Power Spectral Density Measurement16

 3.4 Unwanted Emissions Measurement18

 3.5 AC Conducted Emission Measurement.....23

 3.6 Automatically Discontinue Transmission25

 3.7 Antenna Requirements26

4 LIST OF MEASURING EQUIPMENT27

5 UNCERTAINTY OF EVALUATION28

APPENDIX A. CONDUCTED TEST RESULTS

APPENDIX B. AC CONDUCTED EMISSION TEST RESULT

APPENDIX C. RADIATED SPURIOUS EMISSION

APPENDIX D. RADIATED SPURIOUS EMISSION PLOTS

APPENDIX E. DUTY CYCLE PLOTS



REVISION HISTORY

REPORT NO.	VERSION	DESCRIPTION	ISSUED DATE
FR7D2018-03E	Rev. 01	Initial issue of report	Feb. 22, 2018



SUMMARY OF TEST RESULT

Report Section	FCC Rule	Description	Limit	Result	Remark
3.1	15.403(i)	6dB, 26dB and 99% Occupied Bandwidth	> 500kHz	Pass	-
3.2	15.407(a)	Maximum Conducted Output Power	≤ 30 dBm	Pass	-
3.3	15.407(a)	Power Spectral Density	≤ 30 dBm/500kHz	Pass	-
3.4	15.407(b)	Unwanted Emissions	15.407(b)(4)(i) & 15.209(a)	Pass	Under limit 12.21 dB at 36.750 MHz
3.5	15.207	AC Conducted Emission	15.207(a)	Pass	Under limit 17.70 dB at 0.150 MHz
3.6	15.407(c)	Automatically Discontinue Transmission	Discontinue Transmission	Pass	-
3.7	15.203 & 15.407(a)	Antenna Requirement	N/A	Pass	-



1 General Description

1.1 Applicant

Motorola Mobility LLC
222 W. Merchandise Mart Plaza, Chicago IL 60654, USA

1.2 Manufacturer

Motorola Mobility LLC
222 W. Merchandise Mart Plaza, Chicago IL 60654, USA

1.3 Product Feature of Equipment Under Test

Product Feature	
Equipment	Mobile Cellular Phone
Brand Name	Motorola
Model Name	XT1921-6, XT1921-1
FCC ID	IHDT56XC1
IMEI Code	351838090014406 (for Radiation) 351838090015015 (for Conduction)
EUT supports Radios application	CDMA/EV-DO/GSM/EGPRS/WCDMA/HSPA/LTE/FM/GNSS WLAN 11b/g/n HT20 WLAN 11a/n HT20/HT40 Bluetooth BR/EDR/LE
HW Version	DVT1B
EUT Stage	Identical Prototype

Remark: The above EUT's information was declared by manufacturer. Please refer to the specifications or user's manual for more detailed description.

Accessory List	
AC Adapter 1	Brand Name : Motorola
	Model Name : C-P35
AC Adapter 2	Brand Name : Motorola
	Model Name : SSW-2919UMTJ C-P35 SPN5945A
AC Adapter 3	Brand Name : Motorola
	Model Name : C-P56
AC Adapter 4	Brand Name : Motorola
	Model Name : C-P56
Battery	Brand Name : Motorola
	Model Name : GK40
USB Cable	Brand Name : Saibao
	Model Name : SWT-A083A



1.4 Product Specification of Equipment Under Test

Standards-related Product Specification	
Tx/Rx Channel Frequency Range	5745 MHz ~ 5825 MHz
Maximum Output Power	802.11a : 15.99 dBm / 0.0397 W 802.11n HT20 : 9.98 dBm / 0.0100 W 802.11n HT40 : 9.99 dBm / 0.0100 W
99% Occupied Bandwidth	802.11a : 20.75 MHz 802.11n HT20 : 19.25 MHz 802.11n HT40 : 36.80 MHz
Antenna Type / Gain	PIFA Antenna with gain -3.59 dBi
Type of Modulation	802.11a/n : OFDM (BPSK / QPSK / 16QAM / 64QAM)

1.5 Modification of EUT

No modifications are made to the EUT during all test items.



1.6 Testing Location

Sporton Lab is accredited to ISO 17025 by Taiwan Accreditation Foundation (TAF code : 1190) and the FCC designation No. TW1190 and TW0007 under the FCC 2.948(e) by Mutual Recognition Agreement (MRA) in FCC Test.

Test Site	SPORTON INTERNATIONAL INC.	
Test Site Location	No. 52, Hwa Ya 1 st Rd., Hwa Ya Technology Park, Kwei-Shan District, Tao Yuan City, Taiwan, R.O.C. TEL: +886-3-327-3456 FAX: +886-3-328-4978	
Test Site No.	Sporton Site No.	
	TH05-HY	CO05-HY

Note: The test site complies with ANSI C63.4 2014 requirement.

Test Site	SPORTON INTERNATIONAL INC.	
Test Site Location	No.58, Aly. 75, Ln. 564, Wenhua 3rd Rd. Guishan Dist, Taoyuan City, Taiwan (R.O.C.) TEL: +886-3-327-0868 FAX: +886-3-327-0855	
Test Site No.	Sporton Site No.	
	03CH10-HY	

Note: The test site complies with ANSI C63.4 2014 requirement.

1.7 Applicable Standards

According to the specifications of the manufacturer, the EUT must comply with the requirements of the following standards:

- ♦ FCC Part 15 Subpart E
- ♦ FCC KDB 789033 D02 General UNII Test Procedures New Rules v02r01.
- ♦ ANSI C63.10-2013

Remark:

1. All test items were verified and recorded according to the standards and without any deviation during the test.
2. This EUT has also been tested and complied with the requirements of FCC Part 15, Subpart B, recorded in a separate test report.



2 Test Configuration of Equipment Under Test

- a. The EUT has been associated with peripherals and configuration operated in a manner tended to maximize its emission characteristics in a typical application. Frequency range investigated: conduction emission (150 kHz to 30 MHz), radiation emission (9 kHz to the 10th harmonic of the highest fundamental frequency or to 40 GHz, whichever is lower). For radiated measurement, pre-scanned in three orthogonal panels, X, Y, Z. The worst cases (Y plane) were recorded in this report.

- b. AC power line Conducted Emission was tested under maximum output power.

2.1 Carrier Frequency and Channel

Frequency Band	Channel	Freq. (MHz)	Channel	Freq. (MHz)
5725-5850 MHz Band 4 (U-NII-3)	149	5745	157	5785
	151*	5755	159*	5795
	153	5765	161	5805
	-	-	165	5825

Note: The above Frequency and Channel in "*" were 802.11n HT40.



2.2 Test Mode

Final test modes are considering the modulation and worse data rates as below table.

Modulation	Data Rate
802.11a	6 Mbps
802.11n HT20	MCS0
802.11n HT40	MCS0

AC Conducted Emission	Mode 1 : GSM 1900 Idle + Bluetooth Link + WLAN (5GHz) Link + SD Card + MP3 + Earphone + USB Cable (Charging from Adapter 1)
Remark: For Radiated Test Cases, The tests were performed with Adapter 1.	

Ch. #		Band IV : 5725-5850 MHz		
		802.11a	802.11n HT20	802.11n HT40
L	Low	149	149	151
M	Middle	157	157	-
H	High	165	165	159

2.3 Connection Diagram of Test System

<WLAN Tx Mode>

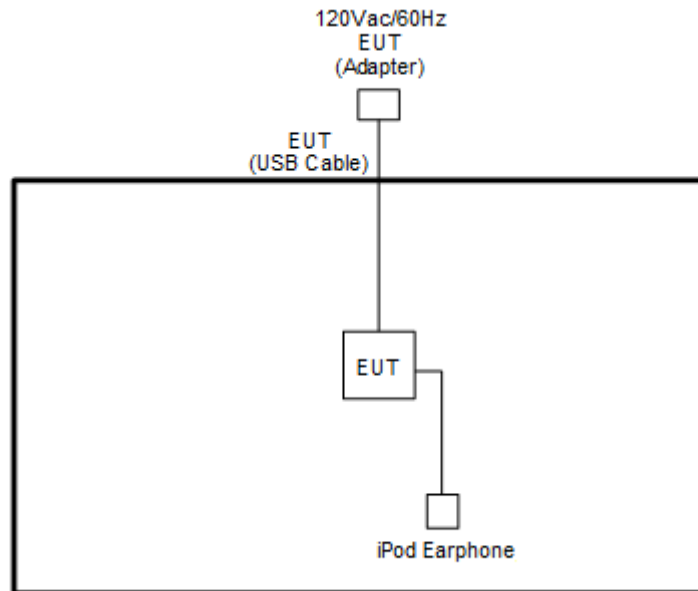

<AC Conducted Emission Mode>

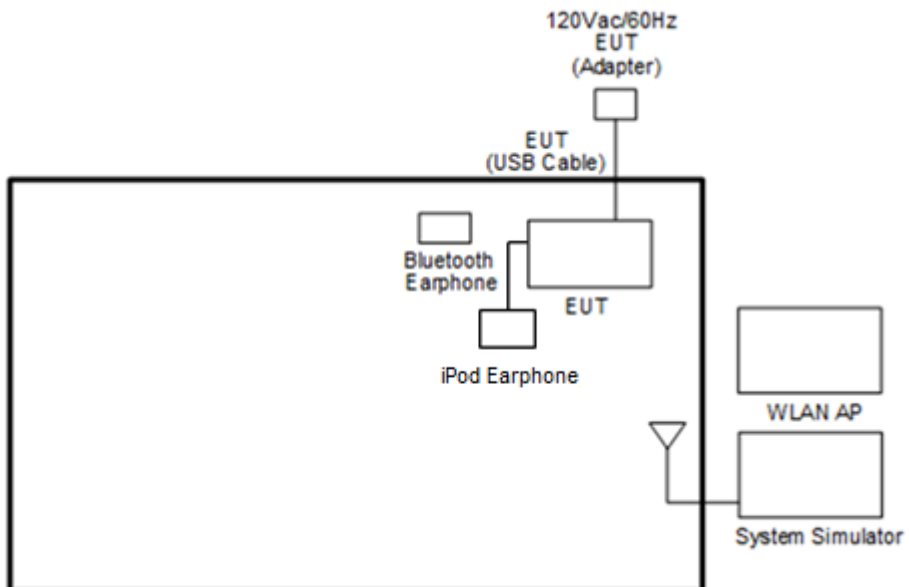



2.4 Support Unit used in test configuration and system

Item	Equipment	Trade Name	Model Name	FCC ID	Data Cable	Power Cord
1.	System Simulator	Anritsu	MT8820C	N/A	N/A	Unshielded, 1.8 m
2.	WLAN AP	ASUS	RT-AC66U	MSQ-RTAC66U	N/A	Unshielded, 1.8 m
3.	iPod Earphone	Apple	N/A	Verification	Unshielded, 1.0 m	N/A
4.	Bluetooth Earphone	Lenovo	LBH 301	FCC DoC	N/A	N/A
5.	SD Card	SanDisk	MicroSD HC	FCC DoC	N/A	N/A

2.5 EUT Operation Test Setup

The RF test items, utility “QRCT” was installed in Notebook which was programmed in order to make the EUT get into the engineering modes to provide channel selection, power level, data rate and the application type and for continuous transmitting signals.

2.6 Measurement Results Explanation Example

For all conducted test items:

The offset level is set in the spectrum analyzer to compensate the RF cable loss and attenuator factor between EUT conducted output port and spectrum analyzer. With the offset compensation, the spectrum analyzer reading level is exactly the EUT RF output level.

Example :

The spectrum analyzer offset is derived from RF cable loss and attenuator factor.

Offset = RF cable loss + attenuator factor.

Following shows an offset computation example with cable loss 4.2 dB and 10dB attenuator.

$$\begin{aligned} \text{Offset(dB)} &= \text{RF cable loss(dB)} + \text{attenuator factor(dB)}. \\ &= 4.2 + 10 = 14.2 \text{ (dB)} \end{aligned}$$

3 Test Result

3.1 6dB and 26dB and 99% Occupied Bandwidth Measurement

3.1.1 Description of 6dB and 26dB and 99% Occupied Bandwidth

The minimum 6 dB bandwidth shall be at least 500 kHz.

26dB and 99% Occupied bandwidth are reporting only.

3.1.2 Measuring Instruments

The measuring equipment is listed in the section 4 of this test report.

3.1.3 Test Procedures

1. The testing follows FCC KDB 789033 D02 General UNII Test Procedures New Rules v02r01. Section C) Emission bandwidth for the band 5.725-5.85GHz
2. Set RBW = 100kHz.
3. Set the VBW $\geq 3 \times$ RBW.
4. Detector = Peak.
5. Trace mode = max hold
6. Measure the maximum width of the emission that is 6 dB down from the peak of the emission.
7. Measure and record the results in the test report.

3.1.4 Test Setup

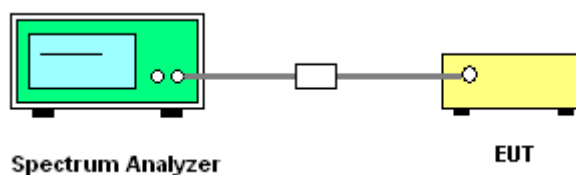

3.1.5 Test Result of 6dB Bandwidth

Please refer to Appendix A.

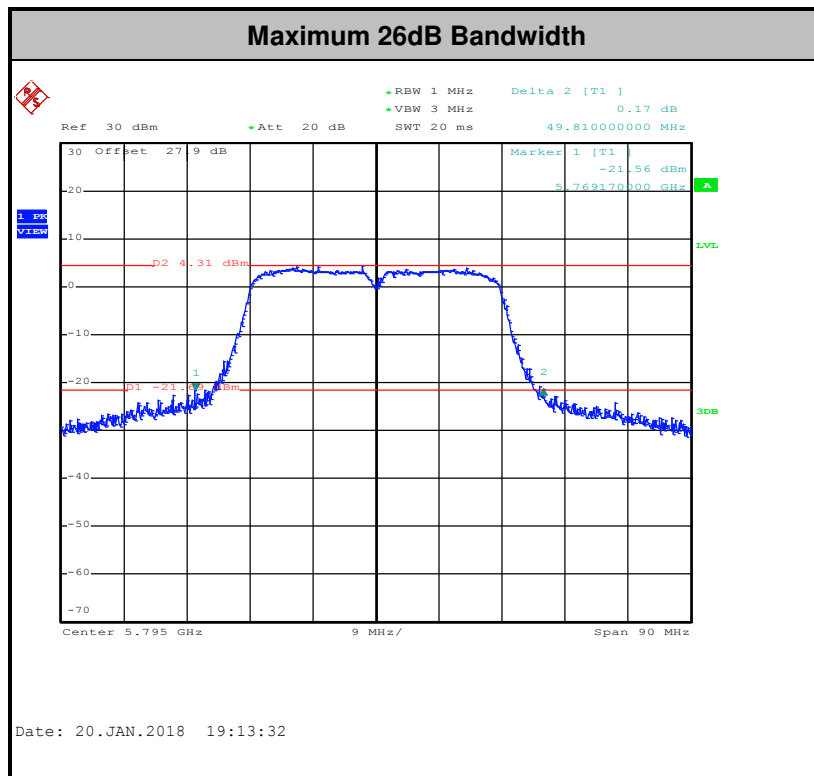
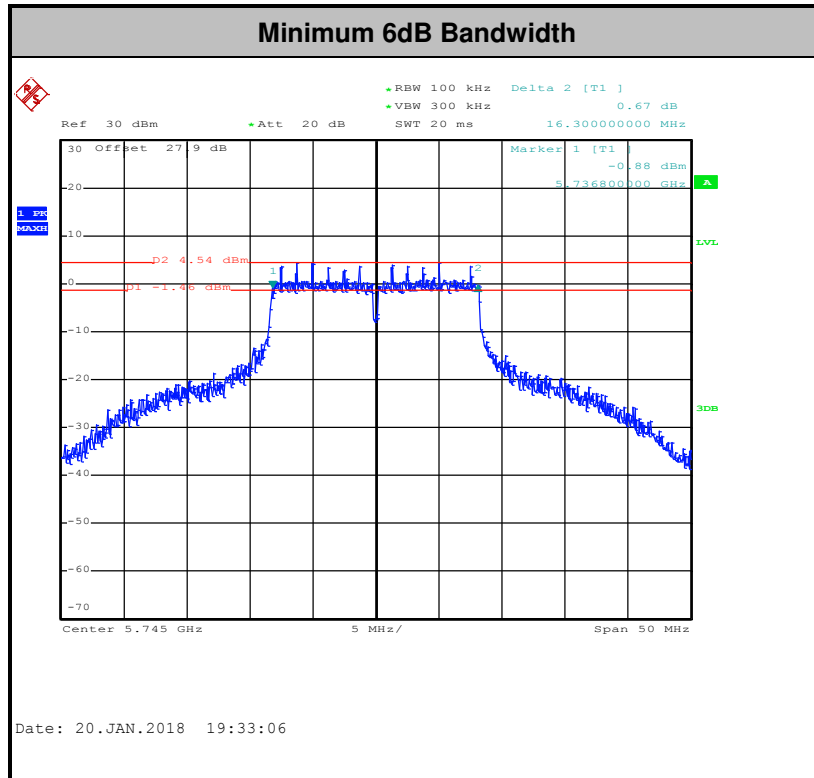

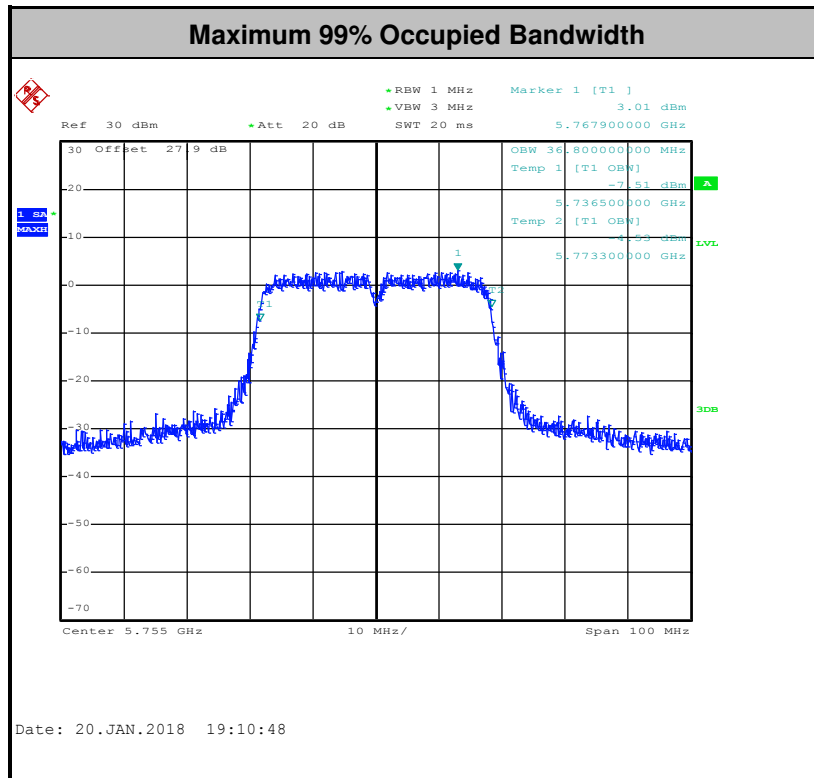

Note: The occupied channel bandwidth is maintained within the band of operation for all of the modulations.

3.2 Maximum Conducted Output Power Measurement

3.2.1 Limit of Maximum Conducted Output Power

For the band 5.725–5.85 GHz, the maximum conducted output power over the frequency band of operation shall not exceed 1 W.

If transmitting antennas of directional gain greater than 6 dBi are used, the peak output power shall be reduced by the amount in dB that the directional gain of the antenna exceeds 6 dBi.

3.2.2 Measuring Instruments

The measuring equipment is listed in the section 4 of this test report.

3.2.3 Test Procedures

The testing follows Method PM of FCC KDB 789033 D02 General UNII Test Procedures New Rules v02r01.

Method PM (Measurement using an RF average power meter):

1. Measurement is performed using a wideband RF power meter.
2. The EUT is configured to transmit continuously with a consistent duty cycle at its maximum power control level.
3. Measure the average power of the transmitter, and the average power is corrected with duty factor, $10 \log(1/x)$, where x is the duty cycle.

3.2.4 Test Setup

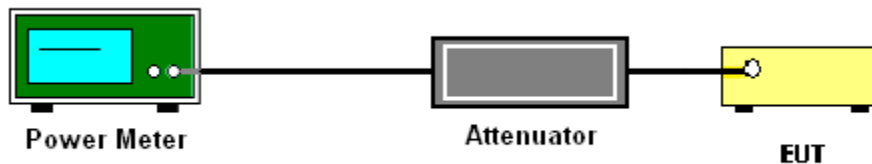

3.2.5 Test Result of Maximum Conducted Output Power

Please refer to Appendix A.



3.3 Power Spectral Density Measurement

3.3.1 Limit of Power Spectral Density

For the band 5.725–5.85 GHz, the maximum power spectral density shall not exceed 30 dBm in any 500-kHz band.

If transmitting antennas of directional gain greater than 6 dBi are used, the peak output power shall be reduced by the amount in dB that the directional gain of the antenna exceeds 6 dBi.

3.3.2 Measuring Instruments

The measuring equipment is listed in the section 4 of this test report.

3.3.3 Test Procedures

The testing follows FCC KDB 789033 D02 General UNII Test Procedures New Rules v02r01. Section F) Maximum power spectral density.

Method SA-2

(trace averaging across on and off times of the EUT transmissions, followed by duty cycle correction).

- Measure the duty cycle.
 - Set span to encompass the entire emission bandwidth (EBW) of the signal.
 - Set RBW = 300 kHz.
 - Set VBW \geq 1 MHz.
 - Number of points in sweep \geq 2 Span / RBW.
 - Sweep time = auto.
 - Detector = RMS
 - Trace average at least 100 traces in power averaging mode.
 - Add $10 \log(500\text{kHz}/\text{RBW})$ to the test result.
 - Add $10 \log(1/x)$, where x is the duty cycle, to the measured power in order to compute the average power during the actual transmission times. For example, add $10 \log(1/0.25) = 6$ dB if the duty cycle is 25 percent.
1. The RF output of EUT was connected to the spectrum analyzer by a low loss cable.
 2. Each plot has already offset with cable loss, and attenuator loss. Measure the PPSD and record it.

3.3.4 Test Setup

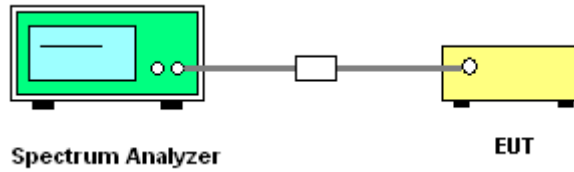

3.3.5 Test Result of Power Spectral Density

Please refer to Appendix A.

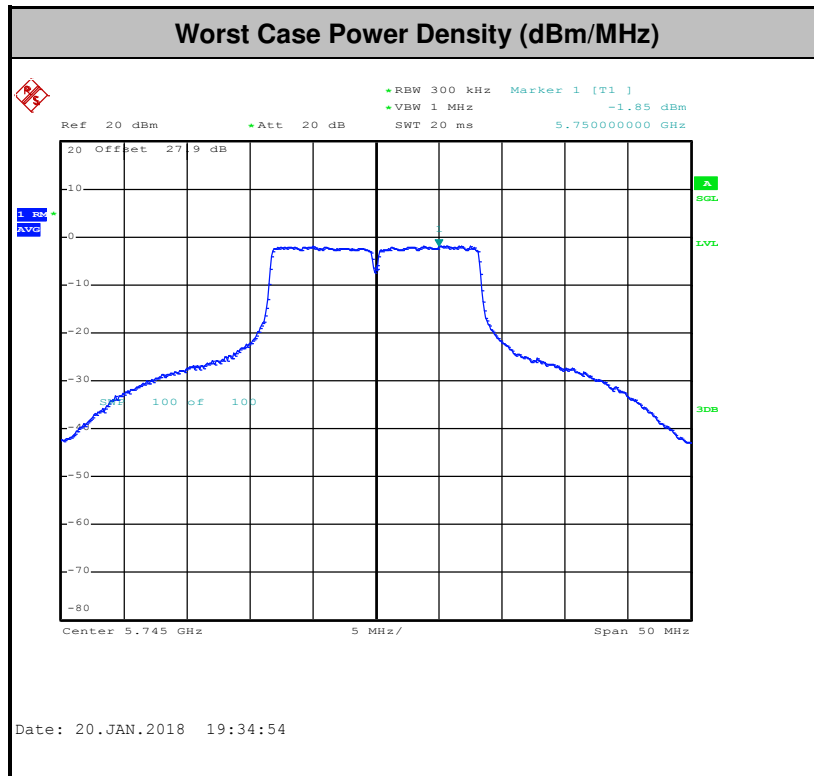



3.4 Unwanted Emissions Measurement

This section is to measure unwanted emissions through radiated measurement for band edge spurious emissions and out of band emissions measurement.

3.4.1 Limit of Unwanted Emissions

(1) For transmitters operating in the 5.725-5.85 GHz band:

15.407(b)(4)(i) All emissions shall be limited to a level of -27 dBm/MHz at 75 MHz or more above or below the band edge increasing linearly to 10 dBm/MHz at 25 MHz above or below the band edge, and from 25 MHz above or below the band edge increasing linearly to a level of 15.6 dBm/MHz at 5 MHz above or below the band edge, and from 5 MHz above or below the band edge increasing linearly to a level of 27 dBm/MHz at the band edge.

(2) Unwanted spurious emissions fallen in restricted bands shall comply with the general field strength limits as below table,

Frequency (MHz)	Field Strength (microvolts/meter)	Measurement Distance (meters)
0.009 – 0.490	2400/F(kHz)	300
0.490 – 1.705	24000/F(kHz)	30
1.705 – 30.0	30	30
30 – 88	100	3
88 – 216	150	3
216 - 960	200	3
Above 960	500	3

Note: The following formula is used to convert the EIRP to field strength.

$$E = \frac{1000000\sqrt{30P}}{3} \mu\text{V/m, where P is the eirp (Watts)}$$



EIRP (dBm)	Field Strength at 3m (dBμV/m)
-17	78.3
- 27	68.3

(3) KDB789033 D02 v02r01 G)2)c)

- (i) Section 15.407(b)(1) to (b)(3) specify the unwanted emission limits for the U-NII-1 and U-NII-2 bands. As specified, emissions above 1000 MHz that are outside of the restricted bands are subject to a peak emission limit of -27 dBm/MHz.³
- (ii) Section 15.407(b)(4) specifies the unwanted emission limit for the U-NII-3 band. A band emissions mask is specified in Section 15.407(b)(4)(i). The emission limits are in terms of a Peak detector. An alternative to the band emissions mask is specified in Section 15.407(b)(4)(ii). The alternative limits are based on the highest antenna gain specified in the filing. There are also marketing and importation restrictions for the devices using the alternative limit.⁴

Note 3: An out-of-band emission that complies with both the average and peak limits of Section 15.209 is not required to satisfy the -27 dBm/MHz peak emission limit.

Note 4: Only devices with antenna gains of 10 dBi or less may be approved using the emission limits specified in Section 15.247(d) till March 2, 2018; all other devices operating in this band must use the mask specified in Section 15.407(b)(4)(i).

3.4.2 Measuring Instruments

The measuring equipment is listed in the section 4 of this test report.



3.4.3 Test Procedures

1. The testing follows FCC KDB 789033 D02 General UNII Test Procedures New Rules v02r01. Section G) Unwanted emissions measurement.
 - (1) Procedure for Unwanted Emissions Measurements Below 1000MHz
 - RBW = 120 kHz
 - VBW = 300 kHz
 - Detector = Peak
 - Trace mode = max hold
 - (2) Procedure for Peak Unwanted Emissions Measurements Above 1000 MHz
 - RBW = 1 MHz
 - VBW \geq 3 MHz
 - Detector = Peak
 - Sweep time = auto
 - Trace mode = max hold
 - (3) Procedures for Average Unwanted Emissions Measurements Above 1000MHz
 - RBW = 1 MHz
 - VBW = 10 Hz, when duty cycle is no less than 98 percent.
 - VBW \geq 1/T, when duty cycle is less than 98 percent where T is the minimum transmission duration over which the transmitter is on and is transmitting at its maximum power control level for the tested mode of operation.
2. The EUT was placed on a turntable with 0.8 meter for frequency below 1GHz and 1.5 meter for frequency above 1GHz respectively above ground.
3. The EUT was set 3 meters from the interference receiving antenna which was mounted on the top of a variable height antenna tower.
4. The antenna is a broadband antenna and its height is adjusted between one meter and four meters above ground to find the maximum value of the field strength for both horizontal polarization and vertical polarization of the antenna.
5. For each suspected emission, the EUT was arranged to its worst case and then adjust the antenna tower (from 1 m to 4 m) and turntable (from 0 degree to 360 degrees) to find the maximum reading.
6. For testing below 1GHz, if the emission level of the EUT in peak mode was 3 dB lower than the limit specified, then peak values of EUT will be reported, otherwise, the emissions will be repeated one by one using the CISPR quasi-peak method and reported.

- 7. For testing above 1GHz, the emission level of the EUT in peak mode was 20dB lower than average limit (that means the emission level in average mode also complies with the limit in average mode), then peak values of EUT will be reported, otherwise, the emissions will be measured in average mode again and reported.

3.4.4 Test Setup

For radiated emissions below 30MHz

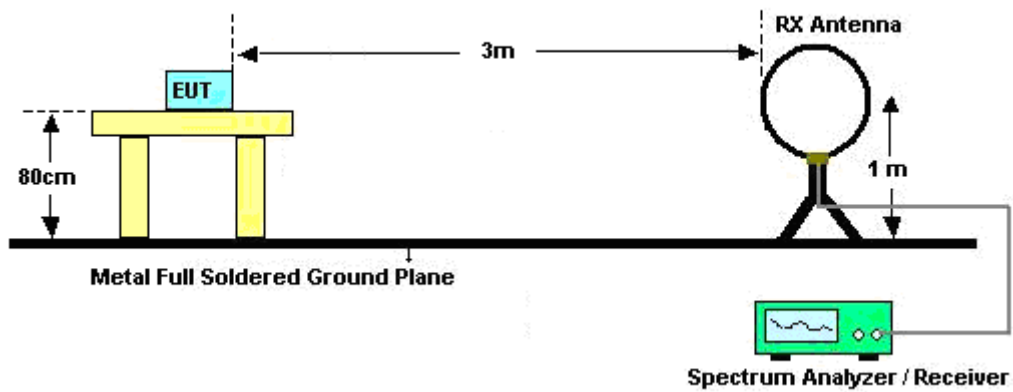

For radiated emissions from 30MHz to 1GHz

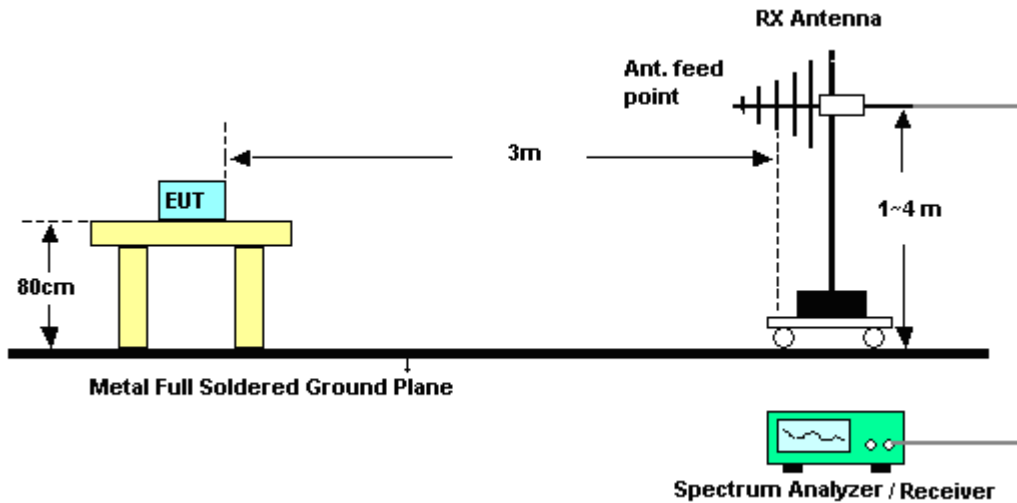

For radiated emissions above 1GHz

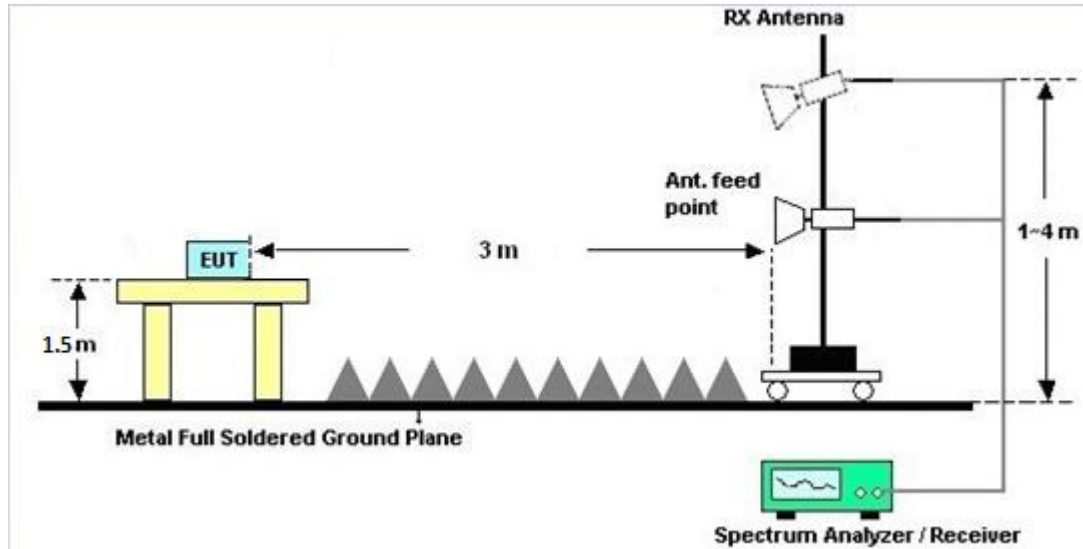

3.4.5 Test Results of Radiated Emissions (9 kHz ~ 30 MHz)

The low frequency, which started from 9 kHz to 30MHz, was pre-scanned and the result which was 20dB lower than the limit line was not reported.

There is a comparison data of both open-field test site and semi-Anechoic chamber, and the result came out very similar.

3.4.6 Test Result of Radiated Band Edges

Please refer to Appendix C and D.

3.4.7 Duty Cycle

Please refer to Appendix E.

3.4.8 Test Result of Unwanted Radiated Emission (30MHz ~ 10th Harmonic)

Please refer to Appendix C and D.



3.5 AC Conducted Emission Measurement

3.5.1 Limit of AC Conducted Emission

For equipment that is designed to be connected to the public utility (AC) power line, the radio frequency voltage that is conducted back onto the AC power line on any frequency or frequencies within the band 150 kHz to 30 MHz shall not exceed the limits in the following table.

Frequency of emission (MHz)	Conducted limit (dB μ V)	
	Quasi-peak	Average
0.15-0.5	66 to 56*	56 to 46*
0.5-5	56	46
5-30	60	50

*Decreases with the logarithm of the frequency.

3.5.2 Measuring Instruments

The measuring equipment is listed in the section 4 of this test report.

3.5.3 Test Procedures

1. The EUT was placed 0.4 meter from the conducting wall of the shielding room was kept at least 80 centimeters from any other grounded conducting surface.
2. Connect EUT to the power mains through a line impedance stabilization network (LISN).
3. All the support units are connecting to the other LISN.
4. The LISN provides 50 ohm coupling impedance for the measuring instrument.
5. The FCC states that a 50 ohm, 50 microhenry LISN should be used.
6. Both sides of AC line were checked for maximum conducted interference.
7. The frequency range from 150 kHz to 30 MHz was searched.
8. Set the test-receiver system to Peak Detect Function and specified bandwidth with Maximum Hold Mode.

3.5.4 Test Setup

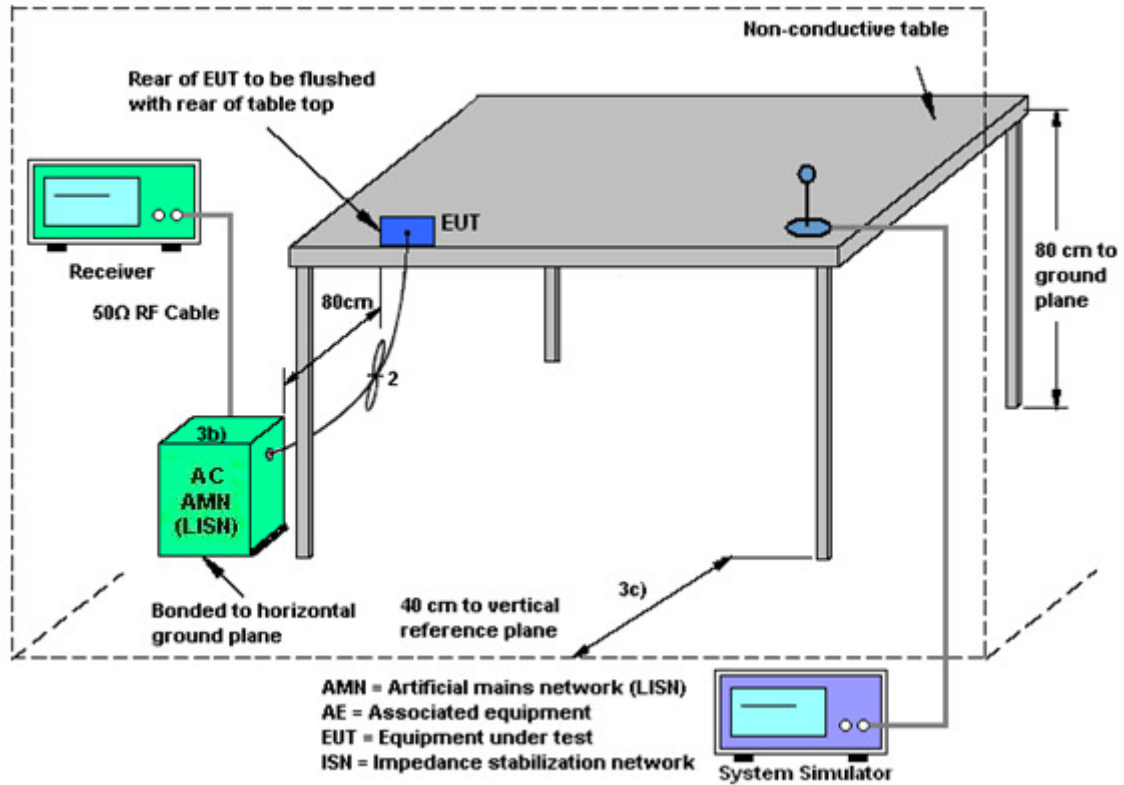

3.5.5 Test Result of AC Conducted Emission

Please refer to Appendix B.



3.6 Automatically Discontinue Transmission

3.6.1 Limit of Automatically Discontinue Transmission

The device shall automatically discontinue transmission in case of either absence of information to transmit or operational failure. These provisions are not intended to preclude the transmission of control or signaling information or the use of repetitive codes used by certain digital technologies to complete frame or burst intervals. Applicants shall include in their application for equipment authorization to describe how this requirement is met.

3.6.2 Measuring Instruments

The measuring equipment is listed in the section 4 of this test report.

3.6.3 Test Result of Automatically Discontinue Transmission

While the EUT is not transmitting any information, the EUT can automatically discontinue transmission and become standby mode for power saving. The EUT can detect the controlling signal of ACK message transmitting from remote device and verify whether it shall resend or discontinue transmission.



3.7 Antenna Requirements

3.7.1 Standard Applicable

If transmitting antenna directional gain is greater than 6 dBi, both the peak transmit power and the peak power spectral density shall be reduced by the amount in dB that the directional gain of the antenna exceeds 6 dBi.

3.7.2 Antenna Anti-Replacement Construction

An embedded-in antenna design is used.

3.7.3 Antenna Gain

The antenna peak gain of EUT is less than 6 dBi. Therefore, it is not necessary to reduce maximum peak output power limit.



4 List of Measuring Equipment

Instrument	Manufacturer	Model No.	Serial No.	Characteristics	Calibration Date	Test Date	Due Date	Remark
Power Meter	Anritsu	ML2495A	1240001	N/A	Sep. 07, 2017	Jan. 04, 2018~ Jan. 20, 2018	Sep. 06, 2018	Conducted (TH05-HY)
Power Sensor	Anritsu	MA2411B	1207349	300MHz~40GHz	Sep. 07, 2017	Jan. 04, 2018~ Jan. 20, 2018	Sep. 06, 2018	Conducted (TH05-HY)
Spectrum Analyzer	Rohde & Schwarz	FSP40	100055	9kHz~40GHz	Jun. 20, 2017	Jan. 04, 2018~ Jan. 20, 2018	Jun. 19, 2018	Conducted (TH02-HY)
AC Power Source	ChainTek	APC-1000W	N/A	N/A	N/A	Jan. 09, 2018	N/A	Conduction (CO05-HY)
EMI Test Receiver	Rohde & Schwarz	ESCI 7	100724	9kHz~7GHz	Sep. 20, 2017	Jan. 09, 2018	Sep. 19, 2018	Conduction (CO05-HY)
LISN	Rohde & Schwarz	ENV216	100080	9kHz~30MHz	Nov. 30, 2017	Jan. 09, 2018	Nov. 29, 2018	Conduction (CO05-HY)
Loop Antenna	Rohde & Schwarz	HFH2-Z2	100315	9 kHz~30 MHz	May 15, 2017	Jan. 04, 2018~ Jan. 21, 2018	May 14, 2019	Radiation (03CH10-HY)
Amplifier	SONOMA	310N	187311	9kHz~1GHz	Oct. 19, 2017	Jan. 04, 2018~ Jan. 21, 2018	Oct. 18, 2018	Radiation (03CH10-HY)
Amplifier	MITEQ	TTA1840-35-HG	1871923	18GHz~40GHz, VSWR : 2.5:1 max	Jul. 18, 2017	Jan. 04, 2018~ Jan. 21, 2018	Jul. 17, 2018	Radiation (03CH10-HY)
Bilog Antenna	TESEQ	CBL 6111D&N-6-0 6	35414&AT- N0602	30MHz~1GHz	Oct. 14, 2017	Jan. 04, 2018~ Jan. 21, 2018	Oct. 13, 2018	Radiation (03CH10-HY)
Horn Antenna	SCHWARZBE CK	BBHA 9120 D	9120D-132 5	1GHz ~ 18GHz	Sep. 27, 2017	Jan. 04, 2018~ Jan. 21, 2018	Sep. 26, 2018	Radiation (03CH10-HY)
Preamplifier	Keysight	83017A	MY532700 78	1GHz~26.5GHz	Oct. 25, 2017	Jan. 04, 2018~ Jan. 21, 2018	Oct. 24, 2018	Radiation (03CH10-HY)
Spectrum Analyzer	Keysight	N9010A	MY542004 85	10Hz ~ 44GHz	Oct. 31, 2017	Jan. 04, 2018~ Jan. 21, 2018	Oct. 30, 2018	Radiation (03CH10-HY)
Preamplifier	MITEQ	AMF-7D-0010 1800	2025787	1GHZ~18GHZ	Feb.13, 2017	Jan. 04, 2018~ Jan. 21, 2018	Feb. 12, 2018	Radiation (03CH10-HY)
Antenna Mast	EMEC	AM-BS-4500- B	N/A	1~4m	N/A	Jan. 04, 2018~ Jan. 21, 2018	N/A	Radiation (03CH10-HY)
Turn Table	EMEC	TT 2200	N/A	0~360 Degree	N/A	Jan. 04, 2018~ Jan. 21, 2018	N/A	Radiation (03CH10-HY)
EMI Test Receiver	Agilent	N9038A (MXE)	MY54201 70	20Hz to 26.5GHz	Mar. 03, 2017	Jan. 04, 2018~ Jan. 21, 2018	Mar. 02, 2018	Radiation (03CH10-HY)
SHF-EHF Horn Antenna	SCHWARZBE CK	BBHA 9170	BBHA9170 584	18GHz- 40GHz	Nov. 27, 2017	Jan. 04, 2018~ Jan. 21, 2018	Nov. 26, 2018	Radiation (03CH10-HY)



5 Uncertainty of Evaluation

Uncertainty of Conducted Emission Measurement (150kHz ~ 30MHz)

Measuring Uncertainty for a Level of Confidence of 95% ($U = 2Uc(y)$)	2.70
---	------

Uncertainty of Radiated Emission Measurement (30 MHz ~ 1000 MHz)

Measuring Uncertainty for a Level of Confidence of 95% ($U = 2Uc(y)$)	5.60
---	------

Uncertainty of Radiated Emission Measurement (1000 MHz ~ 18000 MHz)

Measuring Uncertainty for a Level of Confidence of 95% ($U = 2Uc(y)$)	5.90
---	------

Uncertainty of Radiated Emission Measurement (18000 MHz ~ 40000 MHz)

Measuring Uncertainty for a Level of Confidence of 95% ($U = 2Uc(y)$)	5.20
---	------

Appendix A. Test Result of Conducted Test Items

Test Engineer:	Reece Lin / Kai Liao	Temperature:	21~25	°C
Test Date:	2018/1/4 ~ 2018/01/20	Relative Humidity:	51~54	%

TEST RESULTS DATA
6dB and 26dB EBW and 99% OBW

Band IV									
Mod.	Data Rate	NTX	CH.	Freq. (MHz)	99% Bandwidth (MHz)	26 dB Bandwidth (MHz)	6 dB Bandwidth (MHz)	6dB Bandwidth min. Limit (MHz)	Pass/Fail
11a	6M bps	1	149	5745	20.05	43.15	16.30	0.5	Pass
11a	6Mbps	1	157	5785	20.75	44.95	16.30	0.5	Pass
11a	6Mbps	1	165	5825	19.95	44.10	16.30	0.5	Pass
HT20	MCS 0	1	149	5745	19.10	25.20	17.55	0.5	Pass
HT20	MCS 0	1	157	5785	19.25	30.90	17.50	0.5	Pass
HT20	MCS 0	1	165	5825	19.25	25.10	17.50	0.5	Pass
HT40	MCS 0	1	151	5755	36.80	46.51	35.10	0.5	Pass
HT40	MCS 0	1	159	5795	36.50	49.81	34.92	0.5	Pass

TEST RESULTS DATA
Average Power Table

Band IV										
Mod.	Data Rate	NTX	CH.	Freq. (MHz)	Duty Factor (dB)	Average Conducted Power (dBm)	FCC Conducted Power Limit (dBm)	DG (dBi)		Pass/Fail
11a	6M bps	1	149	5745	0.59	15.95	30.00	-3.59		Pass
11a	6Mbps	1	157	5785	0.59	15.93	30.00	-3.59		Pass
11a	6Mbps	1	165	5825	0.59	15.99	30.00	-3.59		Pass
HT20	MCS 0	1	149	5745	0.63	9.86	30.00	-3.59		Pass
HT20	MCS 0	1	157	5785	0.63	9.98	30.00	-3.59		Pass
HT20	MCS 0	1	165	5825	0.63	9.96	30.00	-3.59		Pass
HT40	MCS 0	1	151	5755	0.47	9.92	30.00	-3.59		Pass
HT40	MCS 0	1	159	5795	0.47	9.99	30.00	-3.59		Pass

TEST RESULTS DATA
Power Spectral Density

Band IV										
Mod.	Data Rate	NTX	CH.	Freq. (MHz)	Duty Factor (dB)	10log (500kHz /RBW) Factor (dB)	Average Power Density (dBm/500kHz)	Average PSD Limit (dBm/500kHz)	DG (dBi)	Pass/Fail
11a	6M bps	1	149	5745	0.59	2.22	0.96	30.00	-3.59	Pass
11a	6Mbps	1	157	5785	0.59	2.22	0.84	30.00	-3.59	Pass
11a	6Mbps	1	165	5825	0.59	2.22	0.70	30.00	-3.59	Pass
HT20	MCS 0	1	149	5745	0.63	2.22	-5.07	30.00	-3.59	Pass
HT20	MCS 0	1	157	5785	0.63	2.22	-5.22	30.00	-3.59	Pass
HT20	MCS 0	1	165	5825	0.63	2.22	-5.47	30.00	-3.59	Pass
HT40	MCS 0	1	151	5755	0.47	2.22	-7.97	30.00	-3.59	Pass
HT40	MCS 0	1	159	5795	0.47	2.22	-7.78	30.00	-3.59	Pass



Appendix B. AC Conducted Emission Test Results

Test Engineer :	Blue Lan	Temperature :	24~25°C
		Relative Humidity :	46~48%

EUT Information

Report NO : 7D2018-03
 Test Mode : Mode 1
 Test Voltage : 120Vac/60Hz
 Phase : Line

ENV216 Auto Test FCC Power Bar - L

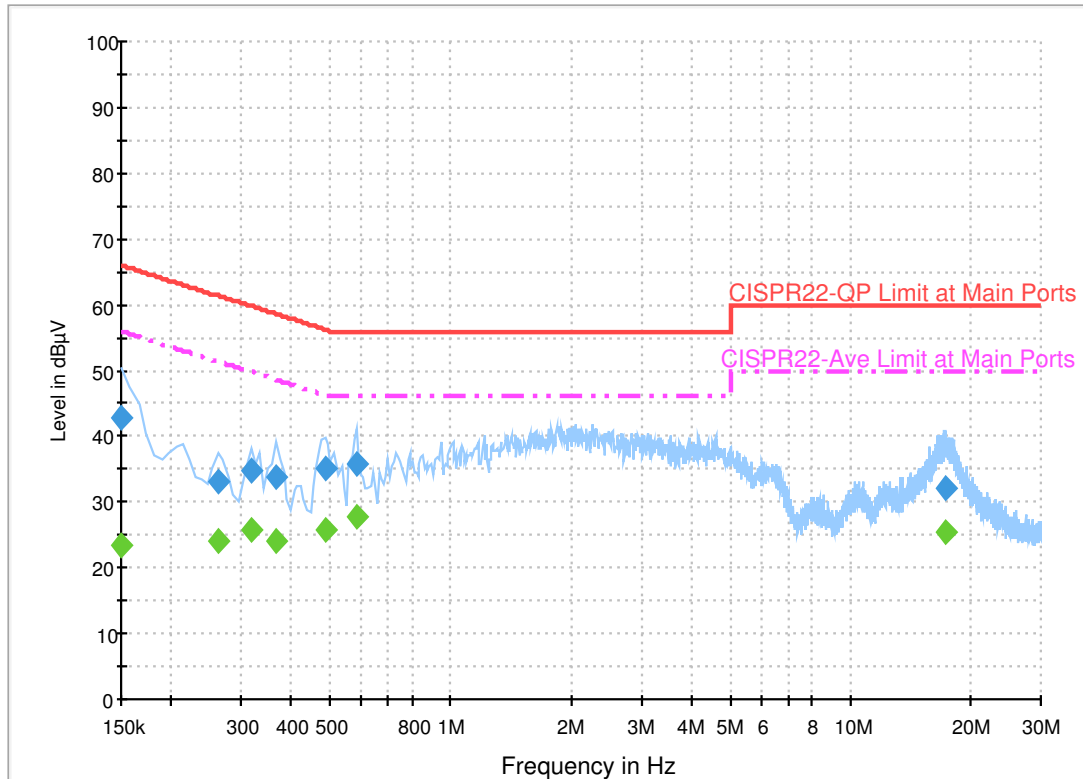

Final Result 1

Frequency (MHz)	QuasiPeak (dBµV)	Filter	Line	Corr. (dB)	Margin (dB)	Limit (dBµV)
0.150000	43.0	Off	L1	19.5	23.0	66.0
0.262000	33.1	Off	L1	19.5	28.3	61.4
0.318000	34.7	Off	L1	19.5	25.1	59.8
0.366000	33.8	Off	L1	19.5	24.8	58.6
0.486000	35.2	Off	L1	19.5	21.0	56.2
0.582000	35.9	Off	L1	19.5	20.1	56.0
17.294000	32.0	Off	L1	19.8	28.0	60.0

Final Result 2

Frequency (MHz)	Average (dBµV)	Filter	Line	Corr. (dB)	Margin (dB)	Limit (dBµV)
0.150000	23.5	Off	L1	19.5	32.5	56.0
0.262000	24.2	Off	L1	19.5	27.2	51.4
0.318000	25.7	Off	L1	19.5	24.1	49.8
0.366000	24.0	Off	L1	19.5	24.6	48.6
0.486000	25.7	Off	L1	19.5	20.5	46.2
0.582000	27.8	Off	L1	19.5	18.2	46.0
17.294000	25.5	Off	L1	19.8	24.5	50.0

EUT Information

Report NO : 7D2018-03
 Test Mode : Mode 1
 Test Voltage : 120Vac/60Hz
 Phase : Neutral

ENV216 Auto Test FCC Power Bar - N

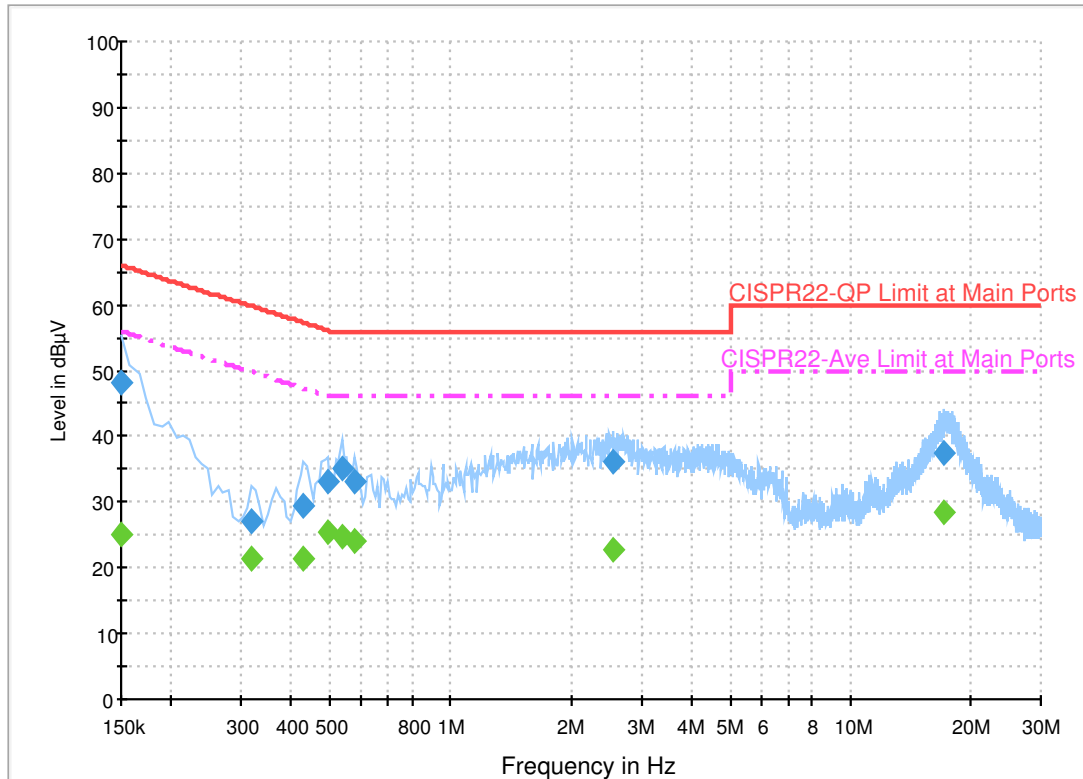

Final Result 1

Frequency (MHz)	QuasiPeak (dBµV)	Filter	Line	Corr. (dB)	Margin (dB)	Limit (dBµV)
0.150000	48.3	Off	N	19.5	17.7	66.0
0.318000	27.2	Off	N	19.5	32.6	59.8
0.430000	29.4	Off	N	19.5	27.9	57.3
0.494000	33.0	Off	N	19.5	23.1	56.1
0.534000	35.2	Off	N	19.5	20.8	56.0
0.574000	33.1	Off	N	19.5	22.9	56.0
2.558000	36.1	Off	N	19.5	19.9	56.0
17.078000	37.4	Off	N	19.8	22.6	60.0

Final Result 2

Frequency (MHz)	Average (dBµV)	Filter	Line	Corr. (dB)	Margin (dB)	Limit (dBµV)
0.150000	25.1	Off	N	19.5	30.9	56.0
0.318000	21.5	Off	N	19.5	28.3	49.8
0.430000	21.5	Off	N	19.5	25.8	47.3
0.494000	25.6	Off	N	19.5	20.5	46.1
0.534000	24.7	Off	N	19.5	21.3	46.0
0.574000	24.0	Off	N	19.5	22.0	46.0
2.558000	22.6	Off	N	19.5	23.4	46.0
17.078000	28.6	Off	N	19.8	21.4	50.0



Appendix C. Radiated Spurious Emission

Test Engineer :	Lance Chiang and Yun Huang	Temperature :	22~24°C
		Relative Humidity :	52~58%

Band 4 - 5725~5850MHz
WIFI 802.11a (Band Edge @ 3m)

WIFI	Note	Frequency	Level	Over	Limit	Read	Antenna	Cable	Preamp	Ant	Table	Peak	Pol.	
Ant.				Limit	Line	Level	Factor	Loss	Factor	Pos	Pos	Avg.		
1		(MHz)	(dBμV/m)	(dB)	(dBμV/m)	(dBμV)	(dB/m)	(dB)	(dB)	(cm)	(deg)	(P/A)	(H/V)	
802.11a CH 149 5745MHz		5641.4	48.48	-19.72	68.2	40.09	32.24	8.7	32.55	118	274	P	H	
		5691.8	49.33	-49.82	99.15	40.72	32.29	8.89	32.57	118	274	P	H	
		5719.4	58.82	-51.81	110.63	50.07	32.32	9.01	32.58	118	274	P	H	
		5724.6	68.32	-52.97	121.29	59.57	32.32	9.01	32.58	118	274	P	H	
	*	5745	106.81	-	-	97.99	32.34	9.07	32.59	118	274	P	H	
	*	5745	99.49	-	-	90.67	32.34	9.07	32.59	118	274	A	H	
														H
														H
			5608.8	48.4	-19.8	68.2	40.16	32.2	8.58	32.54	107	324	P	V
			5680	48.84	-41.6	90.44	40.31	32.27	8.83	32.57	107	324	P	V
			5719.8	57.13	-53.61	110.74	48.38	32.32	9.01	32.58	107	324	P	V
			5724.4	68.52	-52.31	120.83	59.77	32.32	9.01	32.58	107	324	P	V
	*		5745	102.73	-	-	93.91	32.34	9.07	32.59	107	324	P	V
	*		5745	94.76	-	-	85.94	32.34	9.07	32.59	107	324	A	V
														V
													V	



WIFI Ant. 1	Note	Frequency (MHz)	Level (dBμV/m)	Over Limit (dB)	Limit Line (dBμV/m)	Read Level (dBμV)	Antenna Factor (dB/m)	Cable Loss (dB)	Preamp Factor (dB)	Ant Pos (cm)	Table Pos (deg)	Peak Avg. (P/A)	Pol. (H/V)
		5648.2	47.96	-20.24	68.2	39.5	32.24	8.77	32.55	102	279	P	H
		5694.6	49.52	-51.7	101.22	40.91	32.29	8.89	32.57	102	279	P	H
		5707	48.21	-58.95	107.16	39.53	32.31	8.95	32.58	102	279	P	H
		5723.4	47.62	-70.93	118.55	38.87	32.32	9.01	32.58	102	279	P	H
	*	5785	108.44	-	-	99.47	32.38	9.2	32.61	102	279	P	H
	*	5785	100.98	-	-	92.01	32.38	9.2	32.61	102	279	A	H
		5851.2	49.49	-69.97	119.46	40.52	32.44	9.16	32.63	102	279	P	H
		5874.8	49.09	-56.17	105.26	40.12	32.48	9.13	32.64	102	279	P	H
		5881.6	49.36	-50.94	100.3	40.42	32.48	9.1	32.64	102	279	P	H
		5931	48.85	-19.35	68.2	39.93	32.53	9.04	32.65	102	279	P	H
													H
													H
802.11a													
CH 157													
5785MHz		5622.2	47.61	-20.59	68.2	39.29	32.22	8.64	32.54	100	324	P	V
		5653.6	48.81	-22.06	70.87	40.33	32.26	8.77	32.55	100	324	P	V
		5711.6	48.6	-59.85	108.45	39.92	32.31	8.95	32.58	100	324	P	V
		5723.8	46.67	-72.79	119.46	37.92	32.32	9.01	32.58	100	324	P	V
	*	5785	102.47	-	-	93.5	32.38	9.2	32.61	100	324	P	V
	*	5785	95.15	-	-	86.18	32.38	9.2	32.61	100	324	A	V
		5852.2	49.13	-68.05	117.18	40.16	32.44	9.16	32.63	100	324	P	V
		5862	48.95	-59.89	108.84	40	32.46	9.13	32.64	100	324	P	V
		5882.6	48.67	-50.89	99.56	39.73	32.48	9.1	32.64	100	324	P	V
		5948.4	48.61	-19.59	68.2	39.71	32.55	9.01	32.66	100	324	P	V
													V
													V



WiFi Ant. 1	Note	Frequency (MHz)	Level (dBμV/m)	Over Limit (dB)	Limit Line (dBμV/m)	Read Level (dBμV)	Antenna Factor (dB/m)	Cable Loss (dB)	Preamp Factor (dB)	Ant Pos (cm)	Table Pos (deg)	Peak Avg. (P/A)	Pol. (H/V)	
802.11a CH 165 5825MHz	*	5825	109.27	-	-	100.23	32.43	9.23	32.62	100	277	P	H	
	*	5825	101.57	-	-	92.53	32.43	9.23	32.62	100	277	A	H	
		5850	63.9	-58.3	122.2	54.93	32.44	9.16	32.63	100	277	P	H	
		5855	60.22	-50.58	110.8	51.23	32.46	9.16	32.63	100	277	P	H	
		5877.4	53.81	-49.61	103.42	44.84	32.48	9.13	32.64	100	277	P	H	
		5925.2	48.82	-19.38	68.2	39.9	32.53	9.04	32.65	100	277	P	H	
														H
														H
	*	5825	103.16	-	-	94.12	32.43	9.23	32.62	100	320	320	P	V
	*	5825	95.63	-	-	86.59	32.43	9.23	32.62	100	320	320	A	V
		5854.8	57.67	-53.59	111.26	48.68	32.46	9.16	32.63	100	320	320	P	V
		5859.6	54.59	-54.92	109.51	45.61	32.46	9.16	32.64	100	320	320	P	V
		5878	51.27	-51.7	102.97	42.3	32.48	9.13	32.64	100	320	320	P	V
		5933.8	48.91	-19.29	68.2	40.02	32.53	9.01	32.65	100	320	320	P	V
														V
														V
													V	
Remark	1. No other spurious found. 2. All results are PASS against Peak and Average limit line.													



Band 4 5725~5850MHz
WIFI 802.11a (Harmonic @ 3m)

WIFI Ant. 1	Note	Frequency (MHz)	Level (dBμV/m)	Over Limit (dB)	Limit Line (dBμV/m)	Read Level (dBμV)	Antenna Factor (dB/m)	Cable Loss (dB)	Preamp Factor (dB)	Ant Pos (cm)	Table Pos (deg)	Peak Avg. (P/A)	Pol. (H/V)
802.11a CH 149 5745MHz		11490	45.16	-28.84	74	58	39.81	12.74	65.39	100	0	P	H
		17235	47.71	-20.49	68.2	54.2	41.02	16.76	64.27	100	0	P	H
													H
													H
		11490	45.94	-28.06	74	58.78	39.81	12.74	65.39	100	0	P	V
		17235	48.62	-19.58	68.2	55.11	41.02	16.76	64.27	100	0	P	V
													V
													V
802.11a CH 157 5785MHz		11570	44.97	-29.03	74	57.85	39.69	12.8	65.37	100	0	P	H
		17355	45.94	-22.26	68.2	51.61	41.58	16.86	64.11	100	0	P	H
													H
													H
		11570	47.1	-26.9	74	59.98	39.69	12.8	65.37	100	0	P	V
		17355	46.61	-21.59	68.2	52.28	41.58	16.86	64.11	100	0	P	V
													V
													V
802.11a CH 165 5825MHz		11650	44.84	-29.16	74	57.73	39.58	12.87	65.34	100	0	P	H
		17475	47.97	-20.23	68.2	52.82	42.14	16.96	63.95	100	0	P	H
													H
													H
		11650	46.5	-27.5	74	59.39	39.58	12.87	65.34	100	0	P	V
		17475	47.52	-20.68	68.2	52.37	42.14	16.96	63.95	100	0	P	V
													V
													V
Remark	1. No other spurious found. 2. All results are PASS against Peak and Average limit line.												



Band 4 5725~5850MHz
WIFI 802.11n HT20 (Band Edge @ 3m)

WIFI Ant. 1	Note	Frequency (MHz)	Level (dBμV/m)	Over Limit (dB)	Limit Line (dBμV/m)	Read Level (dBμV)	Antenna Factor (dB/m)	Cable Loss (dB)	Preamp Factor (dB)	Ant Pos (cm)	Table Pos (deg)	Peak Avg. (P/A)	Pol. (H/V)	
802.11n HT20 CH 149 5745MHz		5626	49.03	-19.17	68.2	40.71	32.22	8.64	32.54	300	62	P	H	
		5695.4	48.81	-53	101.81	40.2	32.29	8.89	32.57	300	62	P	H	
		5720	55.91	-54.89	110.8	47.16	32.32	9.01	32.58	300	62	P	H	
		5724.4	61.83	-59	120.83	53.08	32.32	9.01	32.58	300	62	P	H	
	*	5745	100.61	-	-	91.79	32.34	9.07	32.59	300	62	P	H	
	*	5745	92.02	-	-	83.2	32.34	9.07	32.59	300	62	A	H	
														H
														H
			5609.2	48.64	-19.56	68.2	40.4	32.2	8.58	32.54	302	108	P	V
			5684.4	47.85	-45.84	93.69	39.24	32.29	8.89	32.57	302	108	P	V
			5720	50.85	-59.95	110.8	42.1	32.32	9.01	32.58	302	108	P	V
			5723.8	60.76	-58.7	119.46	52.01	32.32	9.01	32.58	302	108	P	V
	*		5745	100.88	-	-	92.06	32.34	9.07	32.59	302	108	P	V
	*		5745	92.55	-	-	83.73	32.34	9.07	32.59	302	108	A	V
														V
														V



WIFI Ant. 1	Note	Frequency (MHz)	Level (dBμV/m)	Over Limit (dB)	Limit Line (dBμV/m)	Read Level (dBμV)	Antenna Factor (dB/m)	Cable Loss (dB)	Preamp Factor (dB)	Ant Pos (cm)	Table Pos (deg)	Peak Avg. (P/A)	Pol. (H/V)
		5628.4	48.65	-19.55	68.2	40.28	32.22	8.7	32.55	298	62	P	H
		5684	49.03	-44.37	93.4	40.42	32.29	8.89	32.57	298	62	P	H
		5701.8	47.97	-57.73	105.7	39.28	32.31	8.95	32.57	298	62	P	H
		5721.2	47.21	-66.33	113.54	38.46	32.32	9.01	32.58	298	62	P	H
	*	5785	100.86	-	-	91.89	32.38	9.2	32.61	298	62	P	H
	*	5785	92.07	-	-	83.1	32.38	9.2	32.61	298	62	A	H
		5854.4	47.05	-65.12	112.17	38.06	32.46	9.16	32.63	298	62	P	H
		5874	48.08	-57.4	105.48	39.11	32.48	9.13	32.64	298	62	P	H
		5891.4	48.84	-44.19	93.03	39.88	32.5	9.1	32.64	298	62	P	H
		5925.8	47.59	-20.61	68.2	38.67	32.53	9.04	32.65	298	62	P	H
802.11n													H
HT20													H
CH 157		5609.8	47.89	-20.31	68.2	39.59	32.2	8.64	32.54	301	112	P	V
5785MHz		5653.6	49.05	-21.82	70.87	40.57	32.26	8.77	32.55	301	112	P	V
		5715.6	48.4	-61.17	109.57	39.72	32.31	8.95	32.58	301	112	P	V
		5721.8	46.8	-68.1	114.9	38.05	32.32	9.01	32.58	301	112	P	V
	*	5785	99.45	-	-	90.48	32.38	9.2	32.61	301	112	P	V
	*	5785	91.51	-	-	82.54	32.38	9.2	32.61	301	112	A	V
		5852.2	48.39	-68.79	117.18	39.42	32.44	9.16	32.63	301	112	P	V
		5862	49.33	-59.51	108.84	40.38	32.46	9.13	32.64	301	112	P	V
		5892.6	48.38	-43.76	92.14	39.42	32.5	9.1	32.64	301	112	P	V
		5932.8	48.82	-19.38	68.2	39.9	32.53	9.04	32.65	301	112	P	V
													V
													V



WIFI Ant. 1	Note	Frequency (MHz)	Level (dBμV/m)	Over Limit (dB)	Limit Line (dBμV/m)	Read Level (dBμV)	Antenna Factor (dB/m)	Cable Loss (dB)	Preamp Factor (dB)	Ant Pos (cm)	Table Pos (deg)	Peak Avg. (P/A)	Pol. (H/V)	
802.11n HT20 CH 165 5825MHz	*	5825	101.1	-	-	92.06	32.43	9.23	32.62	302	64	P	H	
	*	5825	93.47	-	-	84.43	32.43	9.23	32.62	302	64	A	H	
		5852.4	52.73	-64	116.73	43.76	32.44	9.16	32.63	302	64	P	H	
		5855.2	50.68	-60.06	110.74	41.69	32.46	9.16	32.63	302	64	P	H	
		5876.8	50.71	-53.15	103.86	41.74	32.48	9.13	32.64	302	64	P	H	
		5937	48.84	-19.36	68.2	39.96	32.53	9.01	32.66	302	64	P	H	
														H
														H
	*	5825	99.7	-	-	90.66	32.43	9.23	32.62	297	112	P	V	
	*	5825	91.56	-	-	82.52	32.43	9.23	32.62	297	112	A	V	
		5850.2	52.35	-69.39	121.74	43.38	32.44	9.16	32.63	297	112	P	V	
		5869.4	48.6	-58.17	106.77	39.65	32.46	9.13	32.64	297	112	P	V	
		5878.6	48.97	-53.56	102.53	40	32.48	9.13	32.64	297	112	P	V	
		5927	49.02	-19.18	68.2	40.1	32.53	9.04	32.65	297	112	P	V	
														V
													V	
Remark	1. No other spurious found. 2. All results are PASS against Peak and Average limit line.													



Band 4 5725~5850MHz
WIFI 802.11n HT20 (Harmonic @ 3m)

WIFI Ant. 1	Note	Frequency (MHz)	Level (dBμV/m)	Over Limit (dB)	Limit Line (dBμV/m)	Read Level (dBμV)	Antenna Factor (dB/m)	Cable Loss (dB)	Preamp Factor (dB)	Ant Pos (cm)	Table Pos (deg)	Peak Avg. (P/A)	Pol. (H/V)	
802.11n HT20 CH 149 5745MHz		11490	46.53	-27.47	74	59.37	39.81	12.74	65.39	100	0	P	H	
		17235	48.19	-20.01	68.2	54.68	41.02	16.76	64.27	100	0	P	H	
													H	
													H	
			11490	47.63	-26.37	74	60.47	39.81	12.74	65.39	100	0	P	V
			17235	48.74	-19.46	68.2	55.23	41.02	16.76	64.27	100	0	P	V
														V
802.11n HT20 CH 157 5785MHz		11570	46.65	-27.35	74	59.53	39.69	12.8	65.37	100	0	P	H	
		17355	47.31	-20.89	68.2	52.98	41.58	16.86	64.11	100	0	P	H	
													H	
													H	
			11570	46.71	-27.29	74	59.59	39.69	12.8	65.37	100	0	P	V
			17355	46.64	-21.56	68.2	52.31	41.58	16.86	64.11	100	0	P	V
														V
802.11n HT20 CH 165 5825MHz		11650	48.57	-25.43	74	61.46	39.58	12.87	65.34	100	0	P	H	
		17475	47.86	-20.34	68.2	52.71	42.14	16.96	63.95	100	0	P	H	
													H	
													H	
			11650	47.19	-26.81	74	60.08	39.58	12.87	65.34	100	0	P	V
			17475	47.44	-20.76	68.2	52.29	42.14	16.96	63.95	100	0	P	V
														V
Remark	1. No other spurious found.													
	2. All results are PASS against Peak and Average limit line.													



Band 4 5725~5850MHz
WIFI 802.11n HT40 (Band Edge @ 3m)

WIFI Ant. 1	Note	Frequency (MHz)	Level (dBμV/m)	Over Limit (dB)	Limit Line (dBμV/m)	Read Level (dBμV)	Antenna Factor (dB/m)	Cable Loss (dB)	Preamp Factor (dB)	Ant Pos (cm)	Table Pos (deg)	Peak Avg. (P/A)	Pol. (H/V)
		5637.2	48.79	-19.41	68.2	40.4	32.24	8.7	32.55	303	63	P	H
		5699.2	48.63	-55.98	104.61	40.02	32.29	8.89	32.57	303	63	P	H
		5719.4	60.85	-49.78	110.63	52.1	32.32	9.01	32.58	303	63	P	H
		5724.6	62.85	-58.44	121.29	54.1	32.32	9.01	32.58	303	63	P	H
	*	5755	98.7	-	-	89.79	32.36	9.14	32.59	303	63	P	H
	*	5755	90.13	-	-	81.22	32.36	9.14	32.59	303	63	A	H
		5854.6	49.37	-62.34	111.71	40.38	32.46	9.16	32.63	303	63	P	H
		5862	49.15	-59.69	108.84	40.2	32.46	9.13	32.64	303	63	P	H
		5898.4	48.94	-38.91	87.85	40.01	32.5	9.07	32.64	303	63	P	H
		5938.6	48.76	-19.44	68.2	39.86	32.55	9.01	32.66	303	63	P	H
802.11n													H
HT40													H
CH 151		5647.6	48.89	-19.31	68.2	40.43	32.24	8.77	32.55	284	114	P	V
5755MHz		5693	48.52	-51.52	100.04	39.91	32.29	8.89	32.57	284	114	P	V
		5719	58.62	-51.9	110.52	49.87	32.32	9.01	32.58	284	114	P	V
		5721.2	59.94	-53.6	113.54	51.19	32.32	9.01	32.58	284	114	P	V
	*	5755	97.24	-	-	88.33	32.36	9.14	32.59	284	114	P	V
	*	5755	87.86	-	-	78.95	32.36	9.14	32.59	284	114	A	V
		5851	49.33	-70.59	119.92	40.36	32.44	9.16	32.63	284	114	P	V
		5866.4	49.43	-58.18	107.61	40.48	32.46	9.13	32.64	284	114	P	V
		5899	49.01	-38.39	87.4	40.08	32.5	9.07	32.64	284	114	P	V
		5942	48.18	-20.02	68.2	39.28	32.55	9.01	32.66	284	114	P	V
													V
													V



WIFI Ant. 1	Note	Frequency (MHz)	Level (dBμV/m)	Over Limit (dB)	Limit Line (dBμV/m)	Read Level (dBμV)	Antenna Factor (dB/m)	Cable Loss (dB)	Preamp Factor (dB)	Ant Pos (cm)	Table Pos (deg)	Peak Avg. (P/A)	Pol. (H/V)
		5606.8	49.16	-19.04	68.2	40.92	32.2	8.58	32.54	301	62	P	H
		5687.6	49.03	-47.02	96.05	40.42	32.29	8.89	32.57	301	62	P	H
		5715.4	48.81	-60.7	109.51	40.13	32.31	8.95	32.58	301	62	P	H
		5722	48.7	-66.66	115.36	39.95	32.32	9.01	32.58	301	62	P	H
	*	5795	99.23	-	-	90.19	32.39	9.26	32.61	301	62	P	H
	*	5795	89.28	-	-	80.24	32.39	9.26	32.61	301	62	A	H
		5854.4	48.85	-63.32	112.17	39.86	32.46	9.16	32.63	301	62	P	H
		5866.4	49.2	-58.41	107.61	40.25	32.46	9.13	32.64	301	62	P	H
		5901.6	49.21	-36.27	85.48	40.28	32.5	9.07	32.64	301	62	P	H
		5948.6	48.55	-19.65	68.2	39.65	32.55	9.01	32.66	301	62	P	H
802.11n													H
HT40													H
CH 159		5601.8	48.25	-19.95	68.2	40.01	32.2	8.58	32.54	301	107	P	V
5795MHz		5687.6	49.35	-46.7	96.05	40.74	32.29	8.89	32.57	301	107	P	V
		5702.6	47.77	-58.16	105.93	39.08	32.31	8.95	32.57	301	107	P	V
		5723.6	48.02	-70.99	119.01	39.27	32.32	9.01	32.58	301	107	P	V
	*	5795	97	-	-	87.96	32.39	9.26	32.61	301	107	P	V
	*	5795	87.28	-	-	78.24	32.39	9.26	32.61	301	107	A	V
		5851.4	48.6	-70.41	119.01	39.63	32.44	9.16	32.63	301	107	P	V
		5866.6	48.75	-58.8	107.55	39.8	32.46	9.13	32.64	301	107	P	V
		5876.6	48.79	-55.22	104.01	39.82	32.48	9.13	32.64	301	107	P	V
		5933	49.74	-18.46	68.2	40.82	32.53	9.04	32.65	301	107	P	V
													V
													V
Remark	1. No other spurious found. 2. All results are PASS against Peak and Average limit line.												



Band 4 5725~5850MHz
WIFI 802.11n HT40 (Harmonic @ 3m)

WIFI Ant. 1	Note	Frequency (MHz)	Level (dBμV/m)	Over Limit (dB)	Limit Line (dBμV/m)	Read Level (dBμV)	Antenna Factor (dB/m)	Cable Loss (dB)	Preamp Factor (dB)	Ant Pos (cm)	Table Pos (deg)	Peak Avg. (P/A)	Pol. (H/V)
802.11n HT40 CH 151 5755MHz		11510	46.69	-27.31	74	59.54	39.8	12.75	65.4	100	0	P	H
		17265	47.18	-21.02	68.2	53.44	41.18	16.79	64.23	100	0	P	H
													H
													H
		11510	48.2	-25.8	74	61.05	39.8	12.75	65.4	100	0	P	V
		17265	46.99	-21.21	68.2	53.25	41.18	16.79	64.23	100	0	P	V
													V
													V
802.11n HT40 CH 159 5795MHz		11590	47.11	-26.89	74	60.01	39.66	12.81	65.37	100	0	P	H
		17385	47.91	-20.29	68.2	53.34	41.74	16.89	64.06	100	0	P	H
													H
													H
		11590	46.75	-27.25	74	59.65	39.66	12.81	65.37	100	0	P	V
		17385	48.84	-19.36	68.2	54.27	41.74	16.89	64.06	100	0	P	V
													V
													V
Remark	1. No other spurious found. 2. All results are PASS against Peak and Average limit line.												



Emission below 1GHz

5GHz WIFI 802.11n HT40 (LF @ 3m)

WIFI	Note	Frequency	Level	Over	Limit	Read	Antenna	Cable	Preamp	Ant	Table	Peak	Pol.	
Ant.				Limit	Line	Level	Factor	Loss	Factor	Pos	Pos	Avg.		
1		(MHz)	(dBμV/m)	(dB)	(dBμV/m)	(dBμV)	(dB/m)	(dB)	(dB)	(cm)	(deg)	(P/A)	(H/V)	
5GHz 802.11n HT40 LF		128.28	21.85	-21.65	43.5	35.54	17.57	1.15	32.69	-	-	P	H	
		146.37	24.67	-18.83	43.5	38.52	17.23	1.24	32.68	-	-	P	H	
		173.37	21.9	-21.6	43.5	37.28	15.44	1.41	32.66	-	-	P	H	
		568.8	26.82	-19.18	46	30.62	25.87	2.51	32.76	-	-	P	H	
		751.5	30.4	-15.6	46	31.33	28.28	2.9	32.71	-	-	P	H	
		918.1	32.57	-13.43	46	31.2	29.29	3.22	31.89	100	0	P	H	
														H
														H
														H
														H
														H
														H
			36.75	27.79	-12.21	40	38.82	21.04	0.6	32.77	100	0	P	V
			108.03	21.83	-21.67	43.5	36.49	16.75	1.05	32.7	-	-	P	V
			148.8	21.97	-21.53	43.5	35.81	17.14	1.33	32.68	-	-	P	V
			754.3	30.3	-15.7	46	31.2	28.31	2.9	32.71	-	-	P	V
			955.2	32.91	-13.09	46	29.38	30.9	3.29	31.47	-	-	P	V
			971.3	34.21	-19.79	54	30.36	31.01	3.32	31.29	-	-	P	V
													V	
													V	
													V	
													V	
													V	
													V	
Remark	1. No other spurious found. 2. All results are PASS against limit line.													



Note symbol

*	Fundamental Frequency which can be ignored. However, the level of any unwanted emissions shall not exceed the level of the fundamental frequency.
!	Test result is over limit line.
P/A	Peak or Average
H/V	Horizontal or Vertical



A calculation example for radiated spurious emission is shown as below:

WIFI	Note	Frequency	Level	Over	Limit	Read	Antenna	Cable	Preamp	Ant	Table	Peak	Pol.
Ant.				Limit	Line	Level	Factor	Loss	Factor	Pos	Pos	Avg.	
1		(MHz)	(dBμV/m)	(dB)	(dBμV/m)	(dBμV)	(dB/m)	(dB)	(dB)	(cm)	(deg)	(P/A)	(H/V)
802.11b		2390	55.45	-18.55	74	54.51	32.22	4.58	35.86	103	308	P	H
CH 01													
2412MHz		2390	43.54	-10.46	54	42.6	32.22	4.58	35.86	103	308	A	H

- Level(dBμV/m) =
Antenna Factor(dB/m) + Cable Loss(dB) + Read Level(dBμV) - Preamp Factor(dB)
- Over Limit(dB) = Level(dBμV/m) – Limit Line(dBμV/m)

For Peak Limit @ 2390MHz:

- Level(dBμV/m)
= Antenna Factor(dB/m) + Cable Loss(dB) + Read Level(dBμV) - Preamp Factor(dB)
= 32.22(dB/m) + 4.58(dB) + 54.51(dBμV) – 35.86 (dB)
= 55.45 (dBμV/m)
- Over Limit(dB)
= Level(dBμV/m) – Limit Line(dBμV/m)
= 55.45(dBμV/m) – 74(dBμV/m)
= -18.55(dB)

For Average Limit @ 2390MHz:

- Level(dBμV/m)
= Antenna Factor(dB/m) + Cable Loss(dB) + Read Level(dBμV) - Preamp Factor(dB)
= 32.22(dB/m) + 4.58(dB) + 42.6(dBμV) – 35.86 (dB)
= 43.54 (dBμV/m)
- Over Limit(dB)
= Level(dBμV/m) – Limit Line(dBμV/m)
= 43.54(dBμV/m) – 54(dBμV/m)
= -10.46(dB)

Both peak and average measured complies with the limit line, so test result is “PASS”.



Appendix D. Radiated Spurious Emission Plots

Test Engineer :	Lance Chiang and Yun Huang	Temperature :	22~24°C
		Relative Humidity :	52~58%

Note symbol

-L	Low channel location
-R	High channel location



Band 4 - 5725~5850MHz
WIFI 802.11a (Band Edge @ 3m)

WIFI	Band 4 5725~5850MHz Band Edge @ 3m	
ANT	802.11a CH149 5745MHz	
1	Horizontal	Fundamental
Peak	<p> Site : 03CH10-HY Condition : PEAK_BE(B4)_16-24 3m HORN 91200-HF HORIZONTAL Detector : Peak Project : 7D2018-03 Mode : Z7 Setting : 7/0 </p>	<p> Site : 03CH10-HY Condition : PEAK(LUNII) 3m HORN 91200-HF HORIZONTAL Detector : Peak Project : 7D2018-03 Mode : Z7 Setting : 7/0 </p>
	<p> Site : 03CH10-HY Condition : PEAK(LUNII) 3m HORN 91200-HF HORIZONTAL Detector : Peak Project : 7D2018-03 Mode : Z7 Setting : 7/0 </p>	<p> Site : 03CH10-HY Condition : PEAK(LUNII) 3m HORN 91200-HF HORIZONTAL Detector : Peak Project : 7D2018-03 Mode : Z7 Setting : 7/0 </p>

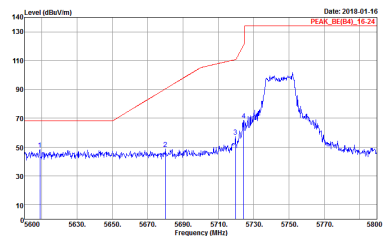
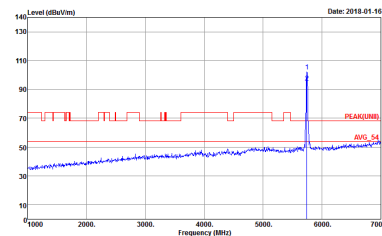

WIFI	Band 4 5725~5850MHz Band Edge @ 3m	
ANT	802.11a CH149 5745MHz	
1	Vertical	Fundamental
Peak	 <p>Date: 2018-01-16 PEAK: 85(45), 132</p> <p>Site : 03CH10-HY Condition : PEAK_8E(84)_16-24 3m HORN 9120D-HF VERTICAL RBW:1000.000KHz VBW:3000.000KHz SWT:Auto Detector : Peak Project : 7D2018-03 Mode : 27 Setting : 7/0</p>	 <p>Date: 2018-01-16 PEAK: 8(45), 75</p> <p>Site : 03CH10-HY Condition : PEAK(UNII) 3m HORN 9120D-HF VERTICAL RBW:1000.000KHz VBW:3000.000KHz SWT:Auto Detector : Peak Project : 7D2018-03 Mode : 27 Setting : 7/0</p>



WIFI	Band 4 5725~5850MHz Band Edge @ 3m	
ANT	802.11a CH157 5785MHz	
1	Horizontal	Fundamental
Peak	<p>Site : 03CH10-HY Condition : PEAK_BE(B4)_16-24 3m HORN 9120D-HF HORIZONTAL Detector : Peak Project : 7D2018-03 Mode : 28 Setting : 7/1</p>	<p>Site : 03CH10-HY Condition : PEAK(UNII) 3m HORN 9120D-HF HORIZONTAL Detector : Peak Project : 7D2018-03 Mode : 28 Setting : 7/1</p>
Peak	<p>Site : 03CH10-HY Condition : PEAK_BE(B4)_16-24 3m HORN 9120D-HF HORIZONTAL Detector : Peak Project : 7D2018-03 Mode : 28 Setting : 7/1</p>	Left blank



WIFI	Band 4 5725~5850MHz Band Edge @ 3m	
ANT	802.11a CH157 5785MHz	
1	Vertical	Fundamental
Peak	<p>Site : 03CH10-HY Condition : PEAK_BE(B4)_16-24 3m HORN 9120D-HF VERTICAL Detector : Peak Project : 7D2018-03 Mode : 28 Setting : 771</p>	<p>Site : 03CH10-HY Condition : PEAK(UNII) 3m HORN 9120D-HF VERTICAL Detector : Peak Project : 7D2018-03 Mode : 28 Setting : 771</p>
Peak	<p>Site : 03CH10-HY Condition : PEAK_BE(B4)_16-24 3m HORN 9120D-HF VERTICAL Detector : Peak Project : 7D2018-03 Mode : 28 Setting : 771</p>	Left blank



WIFI	Band 4 5725~5850MHz Band Edge @ 3m	
ANT	802.11a CH165 5825MHz	
1	Horizontal	Fundamental
Peak	<p>Site : 03CH10-IHV Condition : PEAK_BE(B4)_16-24 3m HORN 9120D-HF HORIZONTAL Detector : Peak Project : 7D2018-03 Mode : 29 Setting : 7/2</p>	<p>Site : 03CH10-IHV Condition : PEAK(UNI) 3m HORN 9120D-HF HORIZONTAL Detector : Peak Project : 7D2018-03 Mode : 29 Setting : 7/2</p>



WIFI	Band 4 5725~5850MHz Band Edge @ 3m	
ANT	802.11a CH165 5825MHz	
1	Vertical	Fundamental
Peak	<p> Site : 03CH10-IHV Condition : PEAK_BE(B4)_16-24 3m HORN 9120D-HF VERTICAL Detector : Peak Project : 7D2018-03 Mode : 29 Setting : 7/2 </p>	<p> Site : 03CH10-IHV Condition : PEAK(UNII) 3m HORN 9120D-HF VERTICAL Detector : Peak Project : 7D2018-03 Mode : 29 Setting : 7/2 </p>



**Band 4 5725~5850MHz
WIFI 802.11n HT20 (Band Edge @ 3m)**

WIFI	Band 4 5725~5850MHz Band Edge @ 3m	
ANT	802.11n HT20 CH149 5745MHz	
1	Horizontal	Fundamental
Peak	<p>Site : 03CH10-HY Condition : PEAK_BE(B4)_16-24 3m HORN 91200-HF HORIZONTAL Detector : Peak Project : 7D2018-03 Mode : 30</p>	<p>Site : 03CH10-HY Condition : PEAK(UNIT) 3m HORN 91200-HF HORIZONTAL Detector : Peak Project : 7D2018-03 Mode : 30</p>



WIFI	Band 4 5725~5850MHz Band Edge @ 3m	
ANT	802.11n HT20 CH149 5745MHz	
1	Vertical	Fundamental
Peak	<p> Date: 2018-01-06 PEAK: 85.045, 135.21 </p> <p> Site : 03CH10-IHV Condition : PEAK_BE(B4)_16-24 3m HORN 9120D-HF VERTICAL RBW:1000.000KHz VBW:3000.000KHz SWT:Auto Detector : Peak Project : 7D2018-03 Mode : 30 </p>	<p> Date: 2018-01-06 PEAK: 85.045, 135.21 </p> <p> Site : 03CH10-IHV Condition : PEAK(UNII) 3m HORN 9120D-HF VERTICAL RBW:1000.000KHz VBW:3000.000KHz SWT:Auto Detector : Peak Project : 7D2018-03 Mode : 30 </p>



WIFI	Band 4 5725~5850MHz Band Edge @ 3m	
ANT	802.11n HT20 CH157 5785MHz	
1	Horizontal	Fundamental
Peak	<p>Site : 03CH10-HY Condition : PEAK_BE(B4)_16-24 3m HORN 9120D-HF HORIZONTAL Detector : Peak Project : 7D2018-03 Mode : 31</p>	<p>Site : 03CH10-HY Condition : PEAK(UNII) 3m HORN 9120D-HF HORIZONTAL Detector : Peak Project : 7D2018-03 Mode : 31</p>
Peak	<p>Site : 03CH10-HY Condition : PEAK_BE(B4)_16-24 3m HORN 9120D-HF HORIZONTAL Detector : Peak Project : 7D2018-03 Mode : 31</p>	Left blank



WIFI	Band 4 5725~5850MHz Band Edge @ 3m	
ANT	802.11n HT20 CH157 5785MHz	
1	Vertical	Fundamental
Peak	<p>Site : 03CH10-HY Condition : PEAK_BE(84)_16-24 3m HORN 9120D-HF VERTICAL Detector : Peak Project : 7D2018-03 Mode : 31</p>	<p>Site : 03CH10-HY Condition : PEAK(UNII) 3m HORN 9120D-HF VERTICAL Detector : Peak Project : 7D2018-03 Mode : 31</p>
Peak	<p>Site : 03CH10-HY Condition : PEAK_BE(84)_16-24 3m HORN 9120D-HF VERTICAL Detector : Peak Project : 7D2018-03 Mode : 31</p>	Left blank



WIFI	Band 4 5725~5850MHz Band Edge @ 3m	
ANT	802.11n HT20 CH165 5825MHz	
1	Horizontal	Fundamental
Peak	<p>Site : 03CH10-IHV Condition : PEAK_BE(B4)_16-24 3m HORN 9120D-HF HORIZONTAL Detector : Peak Project : 7D2018-03 Mode : 32</p>	<p>Site : 03CH10-IHV Condition : PEAK(UNII) 3m HORN 9120D-HF HORIZONTAL Detector : Peak Project : 7D2018-03 Mode : 32</p>

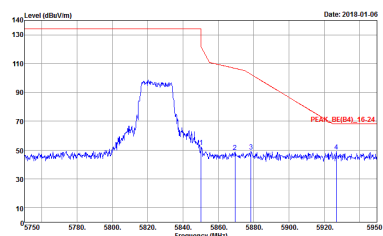
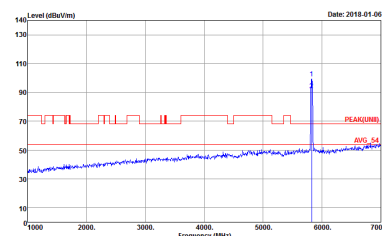

WIFI	Band 4 5725~5850MHz Band Edge @ 3m	
ANT	802.11n HT20 CH165 5825MHz	
1	Vertical	Fundamental
Peak	 <p>Site : 03CH10-IHV Condition : PEAK_BE(B4)_16-24 3m HORN 91200-HF VERTICAL RBW:1000.000KHz VBW:3000.000KHz SWT:Auto Detector : Peak Project : 7D2018-03 Mode : 32</p>	 <p>Site : 03CH10-IHV Condition : PEAK(UNII) 3m HORN 91200-HF VERTICAL RBW:1000.000KHz VBW:3000.000KHz SWT:Auto Detector : Peak Project : 7D2018-03 Mode : 32</p>



Band 4 5725~5850MHz
WIFI 802.11n HT40 (Band Edge @ 3m)

WIFI	Band 4 5725~5850MHz Band Edge @ 3m	
ANT	802.11n HT40 CH151 5755MHz	
1	Horizontal	Fundamental
Peak	<p>Site : 03CH10-HY Condition : PEAK_BE(84)_16-24 3m HORN 91200-HF HORIZONTAL Detector : Peak Project : 7D2018-03 Mode : 33</p>	<p>Site : 03CH10-HY Condition : PEAK(UNIT) 3m HORN 91200-HF HORIZONTAL Detector : Peak Project : 7D2018-03 Mode : 33</p>
Peak	<p>Site : 03CH10-HY Condition : PEAK_BE(84)_16-24 3m HORN 91200-HF HORIZONTAL Detector : Peak Project : 7D2018-03 Mode : 33</p>	Left blank



WIFI	Band 4 5725~5850MHz Band Edge @ 3m	
ANT	802.11n HT40 CH151 5755MHz	
1	Vertical	Fundamental
Peak	<p>Site : 03CH10-HY Condition : PEAK_BE(B4)_16-24 3m HORN 91200-HF VERTICAL Detector : Peak Project : 7D2018-03 Mode : 33</p>	<p>Site : 03CH10-HY Condition : PEAK(UNII) 3m HORN 91200-HF VERTICAL Detector : Peak Project : 7D2018-03 Mode : 33</p>
Peak	<p>Site : 03CH10-HY Condition : PEAK_BE(B4)_16-24 3m HORN 91200-HF VERTICAL Detector : Peak Project : 7D2018-03 Mode : 33</p>	Left blank



WIFI	Band 4 5725~5850MHz Band Edge @ 3m	
ANT	802.11n HT40 CH159 5795MHz	
1	Horizontal	Fundamental
Peak	<p>Site : 03CH10-HY Condition : PEAK_BE(B4)_16-24 3m HORN 9120D-HF HORIZONTAL Detector : Peak Project : 7D2018-03 Mode : 34</p>	<p>Site : 03CH10-HY Condition : PEAK(UNII) 3m HORN 9120D-HF HORIZONTAL Detector : Peak Project : 7D2018-03 Mode : 34</p>
Peak	<p>Site : 03CH10-HY Condition : PEAK_BE(B4)_16-24 3m HORN 9120D-HF HORIZONTAL Detector : Peak Project : 7D2018-03 Mode : 34</p>	Left blank



WIFI	Band 4 5725~5850MHz Band Edge @ 3m	
ANT	802.11n HT40 CH159 5795MHz	
1	Vertical	Fundamental
Peak	<p>Site : 03CH10-HY Condition : PEAK_BE(B4)_16-24 3m HORN 91200-HF VERTICAL Detector : Peak Project : 7D2018-03 Mode : 34</p>	<p>Site : 03CH10-HY Condition : PEAK(UNII) 3m HORN 91200-HF VERTICAL Detector : Peak Project : 7D2018-03 Mode : 34</p>
Peak	<p>Site : 03CH10-HY Condition : PEAK_BE(B4)_16-24 3m HORN 91200-HF VERTICAL Detector : Peak Project : 7D2018-03 Mode : 34</p>	Left blank



Band 4 - 5725~5850MHz
WIFI 802.11a (Harmonic @ 3m)

WIFI	Band 4 5725~5850MHz Harmonic @ 3m	
ANT	802.11a CH149 5745MHz	
1	Horizontal	Vertical
Peak Avg.	<p>Site : 03CH10-HY Condition : PEAK(LINEI) 3m HORN 9120D-HF HORIZONTAL Detector : Peak Project : 7D2018-03 Mode : 27</p>	<p>Site : 03CH10-HY Condition : PEAK(LINEI) 3m HORN 9120D-HF VERTICAL Detector : Peak Project : 7D2018-03 Mode : 27</p>



WIFI	Band 4 5725~5850MHz Harmonic @ 3m	
ANT	802.11a CH157 5785MHz	
1	Horizontal	Vertical
Peak Avg.	<p>Site : 03CH10-IHV Condition : PEAK(UNII) 3m HORN 91200-HF HORIZONTAL Detector : Peak Project : 7D2018-03 Mode : 2B</p>	<p>Site : 03CH10-IHV Condition : PEAK(UNII) 3m HORN 91200-HF VERTICAL Detector : Peak Project : 7D2018-03 Mode : 2B</p>

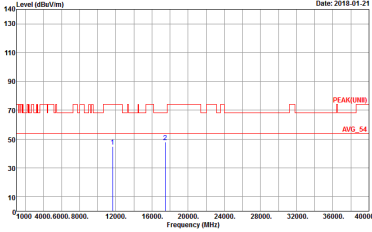
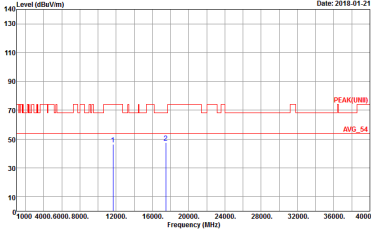

WIFI	Band 4 5725~5850MHz Harmonic @ 3m	
ANT	802.11a CH165 5825MHz	
1	Horizontal	Vertical
<p>Peak Avg.</p>	 <p>Site : 03CH10-HV Condition : PEAK(UNII) 3m HORN 91200-HF HORIZONTAL Detector : Peak Project : 7D2018-03 Mode : 29</p>	 <p>Site : 03CH10-HV Condition : PEAK(UNII) 3m HORN 91200-HF VERTICAL Detector : Peak Project : 7D2018-03 Mode : 29</p>



**Band 4 5725~5850MHz
WIFI 802.11n HT20 (Harmonic @ 3m)**

WIFI	Band 4 5725~5850MHz Harmonic @ 3m	
ANT	802.11n HT20 CH149 5745MHz	
1	Horizontal	Vertical
Peak Avg.	<p>Site : 03CH10-HY Condition : PEAK(LINE) 3m HORN 91200-HF HORIZONTAL Detector : Peak Project : 7D2018-03 Mode : 30</p>	<p>Site : 03CH10-HY Condition : PEAK(LINE) 3m HORN 91200-HF VERTICAL Detector : Peak Project : 7D2018-03 Mode : 30</p>



WIFI	Band 4 5725~5850MHz Harmonic @ 3m	
ANT	802.11n HT20 CH157 5785MHz	
1	Horizontal	Vertical
Peak Avg.	<p>Site : 03CH10-14Y Condition : PEAK(UNID) 3m HORN 9120D-HF HORIZONTAL Detector : Peak Project : 7D2018-03 Mode : 31</p>	<p>Site : 03CH10-14Y Condition : PEAK(UNID) 3m HORN 9120D-HF VERTICAL Detector : Peak Project : 7D2018-03 Mode : 31</p>



WIFI	Band 4 5725~5850MHz Harmonic @ 3m	
ANT	802.11n HT20 CH165 5825MHz	
1	Horizontal	Vertical
Peak Avg.	<p>Site : 03CH10-HV Condition : PEAK(UNID) 3m HORN 9120D-HF HORIZONTAL Detector : Peak Project : 7D2018-03 Mode : 32</p>	<p>Site : 03CH10-HV Condition : PEAK(UNID) 3m HORN 9120D-HF VERTICAL Detector : Peak Project : 7D2018-03 Mode : 32</p>



Band 4 5725~5850MHz
WIFI 802.11n HT40 (Harmonic @ 3m)

Table with 2 columns: WIFI (Band 4 5725~5850MHz Harmonic @ 3m), ANT (802.11n HT40 CH151 5755MHz). Row 1: 1, Horizontal, Vertical. Each plot shows Level (dBu/m) vs Frequency (MHz) with Peak and Avg markers.

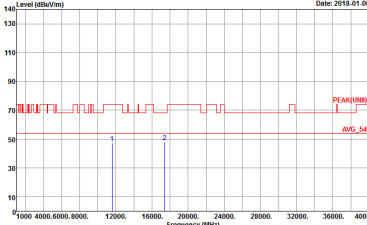
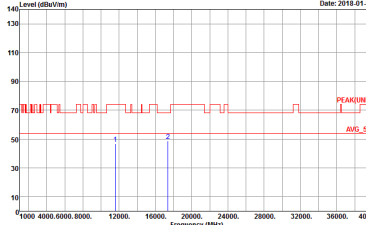

WIFI	Band 4 5725~5850MHz Harmonic @ 3m	
ANT	802.11n HT40 CH159 5795MHz	
1	Horizontal	Vertical
<p>Peak Avg.</p>	 <p>Site : 03CH10-HV Condition : PEAK(UNII) 3m HORN 9120D-HF HORIZONTAL Detector : Peak Project : 7D2018-03 Mode : 34</p>	 <p>Site : 03CH10-HV Condition : PEAK(UNII) 3m HORN 9120D-HF VERTICAL Detector : Peak Project : 7D2018-03 Mode : 34</p>



Emission below 1GHz
5GHz WIFI 802.11n HT40 (LF)

Table with 2 columns: Horizontal and Vertical. Each column contains a spectral plot of Level (dBuV/m) vs Frequency (MHz) from 50 to 1000 MHz. The plots show a blue signal line with several peaks and a red step function. A 'QP' label is present in the top right of each plot. Below each plot is a metadata block with fields: Site, Condition, Detector, Project, and Mode.

QP / Peak

Appendix E. Duty Cycle Plots

Band	Duty Cycle(%)	T(us)	1/T(kHz)	VBW Setting	Duty Factor(dB)
802.11a	87.26	1370.00	0.73	1kHz	0.59
5GHz 802.11n HT20	86.49	1280.00	0.78	1kHz	0.63
5GHz 802.11n HT40	89.66	1820.00	0.55	1kHz	0.47

802.11a

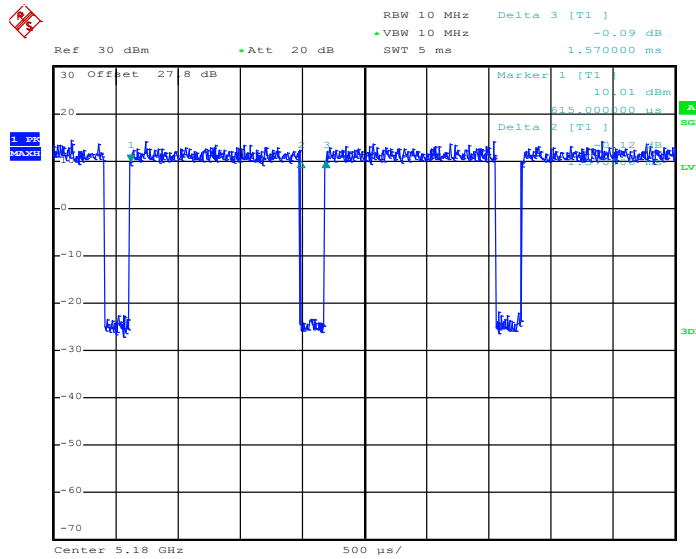

Date: 4.JAN.2018 15:02:24



802.11n HT20

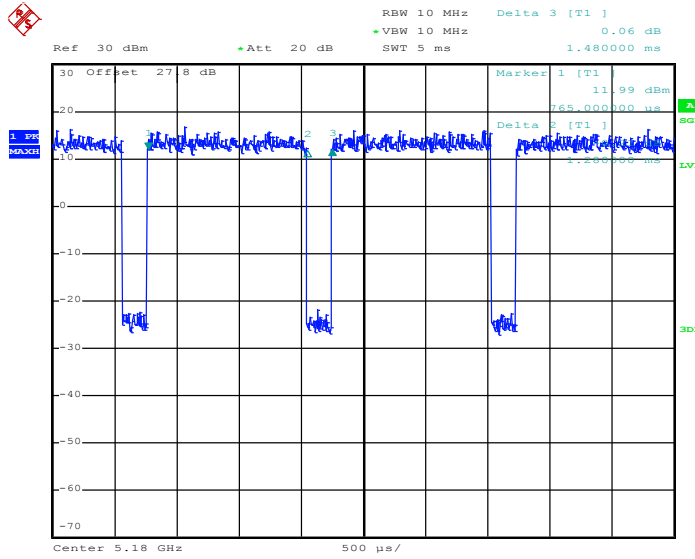

Date: 4.JAN.2018 15:50:44

802.11n HT40

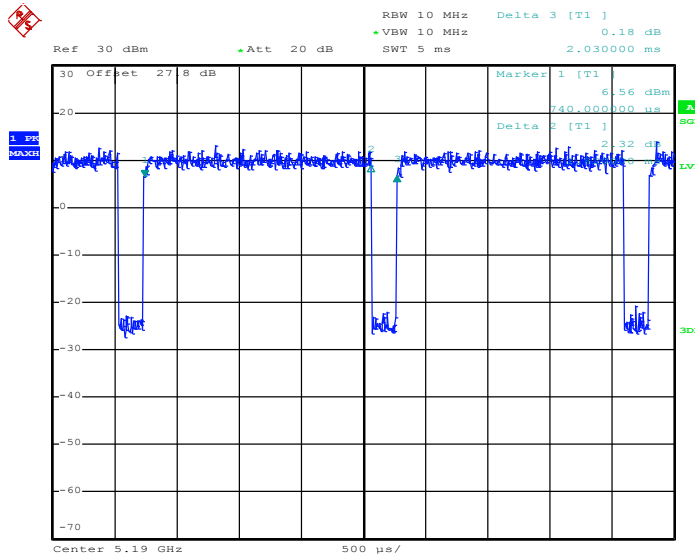

Date: 4.JAN.2018 16:27:32