



FCC RF Test Report

APPLICANT : Motorola Mobility LLC
EQUIPMENT : Mobile Cellular Phone
BRAND NAME : Motorola
MODEL NAME : XT1921-6, XT1921-1
FCC ID : IHDT56XC1
STANDARD : 47 CFR Part 2, 22(H), 24(E), 27
CLASSIFICATION : PCS Licensed Transmitter Held to Ear (PCE)

The product was received on Dec. 20, 2017 and completely tested on Jan. 29, 2018. We, SPORTON INTERNATIONAL Inc., would like to declare that the tested sample has been evaluated in accordance with the test procedures given in ANSI / TIA-603-E and the testing has shown the tested sample to be in compliance with the applicable technical standards.

The test results in this report apply exclusively to the tested model / sample. Without written approval of SPORTON INTERNATIONAL INC., the test report shall not be reproduced except in full.

Reviewed by: Joseph Lin / Supervisor

Approved by: Jones Tsai / Manager



SPORTON INTERNATIONAL INC.

No. 52, Hwa Ya 1st Rd., Hwa Ya Technology Park, Kwei-Shan District, Tao Yuan City, Taiwan, R.O.C.

SPORTON INTERNATIONAL INC.

TEL : 886-3-327-3456

FAX : 886-3-328-4978

FCC ID: IHDT56XC1

Page Number : 1 of 34

Report Issued Date : Feb. 22, 2018

Report Version : Rev. 01

Report Template No.: BU5-FGLTE Version 2.0



TABLE OF CONTENTS

REVISION HISTORY..... 3

SUMMARY OF TEST RESULT 4

1 GENERAL DESCRIPTION 6

 1.1 Applicant 6

 1.2 Manufacturer 6

 1.3 Product Feature of Equipment Under Test..... 6

 1.4 Product Specification of Equipment Under Test..... 7

 1.5 Modification of EUT 8

 1.6 Emission Designator 9

 1.7 Testing Location 12

 1.8 Applicable Standards..... 12

2 TEST CONFIGURATION OF EQUIPMENT UNDER TEST 13

 2.1 Test Mode 13

 2.2 Connection Diagram of Test System 17

 2.3 Support Unit used in test configuration and system 17

 2.4 Measurement Results Explanation Example 18

 2.5 Frequency List of Low/Middle/High Channels 18

3 CONDUCTED TEST ITEMS 23

 3.1 Measuring Instruments 23

 3.2 Test Setup 23

 3.3 Test Result of Conducted Test 23

 3.4 Conducted Output Power and ERP/EIRP 24

 3.5 Peak-to-Average Ratio 25

 3.6 Occupied Bandwidth 26

 3.7 Conducted Band Edge 27

 3.8 Conducted Spurious Emission 29

 3.9 Frequency Stability 30

4 RADIATED TEST ITEMS 31

 4.1 Measuring Instruments 31

 4.2 Test Setup 31

 4.3 Test Result of Radiated Test 31

 4.4 Radiated Spurious Emission 32

5 LIST OF MEASURING EQUIPMENT 33

6 UNCERTAINTY OF EVALUATION 34

APPENDIX A. TEST RESULTS OF CONDUCTED TEST

APPENDIX B. TEST RESULTS OF ERP/EIRP AND RADIATED TEST



REVISION HISTORY

REPORT NO.	VERSION	DESCRIPTION	ISSUED DATE
FG7D2018-03C	Rev. 01	Initial issue of report	Feb. 22, 2018



SUMMARY OF TEST RESULT

Report Section	FCC Rule	Description	Limit	Result	Remark
3.4	§2.1046	Conducted Output Power	Reporting Only	PASS	-
	§22.913(a)(2)	Effective Radiated Power (Band 5) (Band 26)	ERP < 7 Watt		
	§27.50(b)(10) §27.50(c)(10)	Effective Radiated Power (Band 12) (Band 13) (Band 17)	ERP < 3 Watt		
	§24.232(c) §27.50(h)(2)	Equivalent Isotropic Radiated Power (Band 2) (Band 25) (Band 7) (Band 38) (Band 41)	EIRP < 2Watt		
	§27.50(d)(4)	Equivalent Isotropic Radiated Power (Band 4) (Band 66)	EIRP < 1Watt		
3.5	§24.232(d)	Peak-to-Average Ratio	<13 dB	PASS	-
3.6	§2.1049	Occupied Bandwidth	Reporting Only	PASS	-
3.7	§2.1051 §22.917(a) §24.238(a) §27.53(c)(2)(4) §27.53(g) §27.53(h)	Conducted Band Edge Measurement (Band 2) (Band 4) (Band 5) (Band 12) (Band 13) (Band 17) (Band 25) (Band 26) (Band 66)	< 43+10log ₁₀ (P[Watts])	PASS	-
	§27.53(m)(4)	Conducted Band Edge Measurement (Band 7) (Band 38) (Band 41)	§27.53(m)(4)		
3.8	§2.1051 §22.917(a) §24.238(a) §27.53(c)(2) §27.53(g) §27.53(h)	Conducted Spurious Emission (Band 2) (Band 4) (Band 5) (Band 12) (Band 13) (Band 17) (Band 25) (Band 26) (Band 66)	< 43+10log ₁₀ (P[Watts])	PASS	-
	§2.1051 §27.53(m)(4)	Conducted Spurious Emission (Band 7) (Band 38) (Band 41)	< 55+10log ₁₀ (P[Watts])		
3.9	§2.1055 §22.355	Frequency Stability Temperature & Voltage	< 2.5 ppm for Part 22	PASS	-
	§2.1055 §24.235 §27.54		Within Authorized Band		



Report Section	FCC Rule	Description	Limit	Result	Remark
4.4	§2.1053 §22.917(a) §24.238(a) §27.53(c)(2) §27.53(f) §27.53(g) §27.53(h)	Radiated Spurious Emission (Band 2) (Band 4) (Band 5) (Band 12) (Band 13) (Band 17) (Band 25) (Band 26) (Band 66)	$< 43 + 10 \log_{10}(P[\text{Watts}])$	PASS	Under limit 10.84 dB at 1568.000 MHz
	§2.1053 §27.53(m)(4)	Radiated Spurious Emission (Band 7) (Band 38) (Band 41)	$< 55 + 10 \log_{10}(P[\text{Watts}])$		



1 General Description

1.1 Applicant

Motorola Mobility LLC
222 W. Merchandise Mart Plaza, Chicago IL 60654, USA

1.2 Manufacturer

Motorola Mobility LLC
222 W. Merchandise Mart Plaza, Chicago IL 60654, USA

1.3 Product Feature of Equipment Under Test

Product Feature	
Equipment	Mobile Cellular Phone
Brand Name	Motorola
Model Name	XT1921-6, XT1921-1
FCC ID	IHDT56XC1
IMEI Code	351838090014992 (for Radiation) 351838090015965 (for Conducted)
EUT supports Radios application	CDMA/EV-DO/GSM/EGPRS/WCDMA/HSPA/LTE/FM/GNSS WLAN 11b/g/n HT20 WLAN 11a/n HT20/HT40 Bluetooth BR/EDR/LE
HW Version	DVT1B
EUT Stage	Identical Prototype

Remark: The above EUT's information was declared by manufacturer. Please refer to the specifications or user's manual for more detailed description.

Accessory List	
AC Adapter 1	Brand Name : Motorola
	Model Name : C-P35
AC Adapter 2	Brand Name : Motorola
	Model Name : SSW-2919UMTJ C-P35 SPN5945A
AC Adapter 3	Brand Name : Motorola
	Model Name : C-P56
AC Adapter 4	Brand Name : Motorola
	Model Name : C-P56
Battery	Brand Name : Motorola
	Model Name : GK40
USB Cable	Brand Name : Saibao
	Model Name : SWT-A083A



1.4 Product Specification of Equipment Under Test

Standards-related Product Specification	
Tx Frequency	LTE Band 2 : 1850.7 MHz ~ 1909.3 MHz LTE Band 4 : 1710.7 MHz ~ 1754.3 MHz LTE Band 5 : 824.7 MHz ~ 848.3 MHz LTE Band 7 : 2502.5 MHz ~ 2567.5 MHz LTE Band 12 : 699.7 MHz ~ 715.3 MHz LTE Band 13 : 779.5 MHz ~ 784.5 MHz LTE Band 17 : 706.5 MHz ~ 713.5 MHz LTE Band 25 : 1850.7MHz ~ 1914.3 MHz LTE Band 26 : 824.7MHz ~ 848.3 MHz LTE Band 38 : 2572.5MHz ~ 2617.5MHz LTE Band 41 : 2498.5 MHz ~ 2687.5 MHz LTE Band 66 : 1710.7 MHz ~ 1754.3 MHz
Rx Frequency	LTE Band 2 : 1930.7 MHz ~ 1989.3 MHz LTE Band 4 : 2110.7 MHz ~ 2154.3 MHz LTE Band 5 : 869.7 MHz ~ 893.3 MHz LTE Band 7 : 2622.5MHz ~ 2687.5 MHz LTE Band 12 : 729.7 MHz ~ 745.3 MHz LTE Band 13 : 748.5 MHz ~ 753.5 MHz LTE Band 17 : 736.5 MHz ~ 743.5 MHz LTE Band 25 : 1930.7MHz ~ 1994.3 MHz LTE Band 26 : 869.7MHz ~ 893.3MHz LTE Band 38 : 2572.5MHz ~ 2617.5MHz LTE Band 41 : 2498.5 MHz ~ 2687.5 MHz LTE Band 66 : 2110.7 MHz ~ 2154.3 MHz
Bandwidth	LTE Band 2 : 1.4MHz / 3MHz / 5MHz / 10MHz / 15MHz / 20MHz LTE Band 4 : 1.4MHz / 3MHz / 5MHz / 10MHz / 15MHz / 20MHz LTE Band 5 : 1.4MHz / 3MHz / 5MHz / 10MHz LTE Band 7 : 5MHz / 10MHz / 15MHz / 20MHz LTE Band 12 : 1.4MHz / 3MHz / 5MHz / 10MHz LTE Band 13 : 5MHz / 10MHz LTE Band 17 : 5MHz / 10MHz LTE Band 25 : 1.4MHz / 3MHz / 5MHz / 10MHz / 15MHz / 20MHz LTE Band 26 : 1.4MHz / 3MHz / 5MHz / 10MHz / 15MHz LTE Band 38 : 5MHz / 10MHz / 15MHz / 20MHz LTE Band 41 : 5MHz / 10MHz / 15MHz / 20MHz LTE Band 66 : 1.4MHz / 3MHz / 5MHz / 10MHz / 15MHz / 20MHz
Maximum Output Power to Antenna	LTE Band 2 : 23.36 dBm LTE Band 4 : 23.48 dBm LTE Band 5 : 23.21 dBm LTE Band 7 : 23.10 dBm LTE Band 12 : 22.97 dBm LTE Band 13 : 23.32 dBm LTE Band 17 : 23.35 dBm LTE Band 25 : 23.42 dBm LTE Band 26 : 23.40 dBm LTE Band 38 : 23.21 dBm LTE Band 41 : 23.48 dBm LTE Band 66 : 23.38 dBm



Standards-related Product Specification	
Antenna Gain	LTE Band 2 : 0.982 dBi LTE Band 4 : 0.122 dBi LTE Band 5 : -0.105 dBi LTE Band 7 : 1.55 dBi LTE Band 12 : -2.04 dBi LTE Band 13 : -0.214 dBi LTE Band 17 : -2.04 dBi LTE Band 25 : 0.982 dBi LTE Band 26 : -0.105 dBi LTE Band 38 : 1.64 dBi LTE Band 41 : 1.64 dBi LTE Band 66 : 0.122 dBi
Type of Modulation	QPSK / 16QAM

1.5 Modification of EUT

No modifications are made to the EUT during all test items.



1.6 Emission Designator

LTE Band 2		QPSK			16QAM		
BW (MHz)	Frequency Range (MHz)	Emission Designator (99%OBW)	Frequency Tolerance (ppm)	Maximum EIRP(W)	Emission Designator (99%OBW)	Frequency Tolerance (ppm)	Maximum EIRP(W)
1.4	1850.7 ~ 1909.3	1M10G7D	-	0.2699	1M10W7D	-	0.2100
3	1851.5 ~ 1908.5	2M72G7D	-	0.2578	2M72W7D	-	0.2164
5	1852.5 ~ 1907.5	4M50G7D	-	0.2674	4M51W7D	-	0.1906
10	1855.0 ~ 1905.0	9M13G7D	0.0020	0.2705	9M05W7D	-	0.2076
15	1857.5 ~ 1902.5	13M4G7D	-	0.2693	13M5W7D	-	0.2154
20	1860.0 ~ 1900.0	18M5G7D	-	0.2718	18M4W7D	-	0.1933
LTE Band 25		QPSK			16QAM		
BW (MHz)	Frequency Range (MHz)	Emission Designator (99%OBW)	Frequency Tolerance (ppm)	Maximum EIRP(W)	Emission Designator (99%OBW)	Frequency Tolerance (ppm)	Maximum EIRP(W)
1.4	1850.7 ~ 1914.3	1M10G7D	-	0.2625	1M10W7D	-	0.2047
3	1851.5 ~ 1913.5	2M72G7D	-	0.2631	2M74W7D	-	0.2076
5	1852.5 ~ 1912.5	4M52G7D	-	0.2589	4M50W7D	-	0.2024
10	1855.0 ~ 1910.0	9M05G7D	0.0017	0.2687	9M01W7D	-	0.2052
15	1857.5 ~ 1907.5	13M4G7D	-	0.2693	13M4W7D	-	0.2100
20	1860.0 ~ 1905.0	18M5G7D	-	0.2755	18M4W7D	-	0.2033
LTE Band 4		QPSK			16QAM		
BW (MHz)	Frequency Range (MHz)	Emission Designator (99%OBW)	Frequency Tolerance (ppm)	Maximum EIRP(W)	Emission Designator (99%OBW)	Frequency Tolerance (ppm)	Maximum EIRP(W)
1.4	1710.7 ~ 1754.3	1M10G7D	-	0.2224	1M10W7D	-	0.1672
3	1711.5 ~ 1753.5	2M74G7D	-	0.2124	2M72W7D	-	0.1800
5	1712.5 ~ 1752.5	4M49G7D	-	0.2255	4M49W7D	-	0.1731
10	1715.0 ~ 1750.0	9M05G7D	0.0008	0.2255	9M05W7D	-	0.1787
15	1717.5 ~ 1747.5	13M5G7D	-	0.2189	13M4W7D	-	0.1668
20	1720.0 ~ 1745.0	18M4G7D	-	0.2292	18M4W7D	-	0.1695
LTE Band 5		QPSK			16QAM		
BW (MHz)	Frequency Range (MHz)	Emission Designator (99%OBW)	Frequency Tolerance (ppm)	Maximum ERP(W)	Emission Designator (99%OBW)	Frequency Tolerance (ppm)	Maximum ERP(W)
1.4	824.7 ~ 848.3	1M10G7D	-	0.1237	1M10W7D	-	0.1053
3	825.5 ~ 847.5	2M73G7D	-	0.1237	2M72W7D	-	0.0894
5	826.5 ~ 846.5	4M49G7D	-	0.1220	4M52W7D	-	0.1032
10	829.0 ~ 844.0	9M03G7D	0.0056	0.1246	9M05W7D	-	0.0917



LTE Band 7		QPSK			16QAM		
BW (MHz)	Frequency Range (MHz)	Emission Designator (99%OBW)	Frequency Tolerance (ppm)	Maximum EIRP(W)	Emission Designator (99%OBW)	Frequency Tolerance (ppm)	Maximum EIRP(W)
5	2502.5 ~ 2567.5	4M51G7D	-	0.2812	4M49W7D	-	0.2094
10	2505.0 ~ 2565.0	9M05G7D	0.0022	0.2864	9M05W7D	-	0.2265
15	2507.5 ~ 2562.5	13M4G7D	-	0.2897	13M5W7D	-	0.2518
20	2510.0 ~ 2560.0	18M3G7D	-	0.2917	18M4W7D	-	0.2089
LTE Band 12		QPSK			16QAM		
BW (MHz)	Frequency Range (MHz)	Emission Designator (99%OBW)	Frequency Tolerance (ppm)	Maximum ERP(W)	Emission Designator (99%OBW)	Frequency Tolerance (ppm)	Maximum ERP(W)
1.4	699.7 ~ 715.3	1M09G7D	-	0.0738	1M10W7D	-	0.0608
3	700.5 ~ 714.5	2M72G7D	-	0.0721	2M73W7D	-	0.0564
5	701.5 ~ 713.5	4M51G7D	-	0.0735	4M49W7D	-	0.0600
10	704.0 ~ 711.0	8M99G7D	0.0016	0.0755	9M03W7D	-	0.0608
LTE Band 13		QPSK			16QAM		
BW (MHz)	Frequency Range (MHz)	Emission Designator (99%OBW)	Frequency Tolerance (ppm)	Maximum ERP(W)	Emission Designator (99%OBW)	Frequency Tolerance (ppm)	Maximum ERP(W)
5	779.5 ~ 784.5	4M50G7D	-	0.1241	4M51W7D	-	0.0997
10	782.0	9M03G7D	0.0017	0.1246	9M03W7D	-	0.0882
LTE Band 17		QPSK			16QAM		
BW (MHz)	Frequency Range (MHz)	Emission Designator (99%OBW)	Frequency Tolerance (ppm)	Maximum ERP(W)	Emission Designator (99%OBW)	Frequency Tolerance (ppm)	Maximum ERP(W)
5	706.5 ~ 713.5	4M51G7D	-	0.0820	4M49W7D	-	0.0673
10	709.0 ~ 711.0	9M05G7D	0.0030	0.0824	9M03W7D	-	0.0676
LTE Band 26		QPSK			16QAM		
BW (MHz)	Frequency Range (MHz)	Emission Designator (99%OBW)	Frequency Tolerance (ppm)	Maximum EIRP(W)	Emission Designator (99%OBW)	Frequency Tolerance (ppm)	Maximum EIRP(W)
1.4	824.7 ~ 848.3	1M19G7D	-	0.1266	1M10W7D	-	0.1041
3	825.5 ~ 847.5	2M73G7D	-	0.1215	2M74W7D	-	0.0999
5	826.5 ~ 846.5	4M52G7D	-	0.1275	4M51W7D	-	0.0983
10	829.0 ~ 844.0	9M05G7D	0.0019	0.1284	9M05W7D	-	0.1080
15	831.5 ~ 841.5	13M5G7D	-	0.1302	13M5W7D	-	0.1041



LTE Band 38		QPSK			16QAM		
BW (MHz)	Frequency Range (MHz)	Emission Designator (99%OBW)	Frequency Tolerance (ppm)	Maximum EIRP(W)	Emission Designator (99%OBW)	Frequency Tolerance (ppm)	Maximum EIRP(W)
5	2572.5 ~ 2617.5	4M52G7D	-	0.2924	4M51W7D	-	0.2312
10	2575.0 ~ 2615.0	9M07G7D	0.0021	0.2972	9M03W7D	-	0.2312
15	2577.5 ~ 2612.5	13M5G7D	-	0.2999	13M5W7D	-	0.2477
20	2580.0 ~ 2610.0	18M3G7D	-	0.3055	18M5W7D	-	0.2301
LTE Band 41		QPSK			16QAM		
BW (MHz)	Frequency Range (MHz)	Emission Designator (99%OBW)	Frequency Tolerance (ppm)	Maximum EIRP(W)	Emission Designator (99%OBW)	Frequency Tolerance (ppm)	Maximum EIRP(W)
5	2498.5 ~ 2687.5	4M50G7D	-	0.3083	4M50W7D	-	0.2213
10	2501.0 ~ 2685.0	9M05G7D	0.0016	0.3177	9M01W7D	-	0.2265
15	2503.5 ~ 2682.5	13M5G7D	-	0.3221	13M5W7D	-	0.2393
20	2506.0 ~ 2680.0	18M5G7D	-	0.3251	18M3W7D	-	0.2350
LTE Band 66		QPSK			16QAM		
BW (MHz)	Frequency Range (MHz)	Emission Designator (99%OBW)	Frequency Tolerance (ppm)	Maximum EIRP(W)	Emission Designator (99%OBW)	Frequency Tolerance (ppm)	Maximum EIRP(W)
1.4	1710.7 ~ 1779.3	1M10G7D	-	0.2199	1M10W7D	-	0.1771
3	1711.5 ~ 1778.5	2M73G7D	-	0.2199	2M74W7D	-	0.1804
5	1712.5 ~ 1777.5	4M50G7D	-	0.2209	4M50W7D	-	0.1699
10	1715 ~ 1775	9M05G7D	0.0020	0.2179	9M09W7D	-	0.1771
15	1717.5 ~ 1772.5	13M5G7D	-	0.2204	13M5W7D	-	0.1787
20	1720.0 ~ 1770.0	18M3G7D	-	0.2240	18M3W7D	-	0.1695



1.7 Testing Location

Sporton Lab is accredited to ISO 17025 by Taiwan Accreditation Foundation (TAF code : 1190) and the FCC designation No. TW1190 and TW0007 under the FCC 2.948(e) by Mutual Recognition Agreement (MRA) in FCC Test.

Test Site	SPORTON INTERNATIONAL INC.
Test Site Location	No. 52, Hwa Ya 1 st Rd., Hwa Ya Technology Park, Kwei-Shan District, Tao Yuan City, Taiwan, R.O.C. TEL: +886-3-327-3456 FAX: +886-3-328-4978
Test Site No.	Sporton Site No. TH05-HY

Test Site	SPORTON INTERNATIONAL INC.
Test Site Location	No.58, Aly. 75, Ln. 564, Wenhua 3rd Rd. Guishan Dist, Taoyuan City, Taiwan (R.O.C.) TEL: +886-3-327-0868 FAX: +886-3-327-0855
Test Site No.	Sporton Site No. 03CH13-HY

1.8 Applicable Standards

According to the specifications of the manufacturer, the EUT must comply with the requirements of the following standards:

- 47 CFR Part 2, 22(H), 24(E), 27
- ANSI / TIA-603-E
- FCC KDB 971168 D01 Power Meas. License Digital Systems v03
- FCC KDB 412172 D01 Determining ERP and EIRP v01r01

Remark:

1. All test items were verified and recorded according to the standards and without any deviation during the test.
2. This EUT has also been tested and complied with the requirements of FCC Part 15, Subpart B, Subpart B, recorded in a separate test report.



2 Test Configuration of Equipment Under Test

2.1 Test Mode

Antenna port conducted and radiated test items listed below are performed according to KDB 971168 D01 Power Meas. License Digital Systems v03 with maximum output power.

Radiated measurements are performed by rotating the EUT in three different orthogonal test planes to find the maximum emission.

Test Items	Band	Bandwidth (MHz)						Modulation		RB #			Test Channel			
		1.4	3	5	10	15	20	QPSK	16QAM	1	Half	Full	L	M	H	
Max. Output Power	2	✓	✓	✓	✓	✓	✓	✓	✓	✓	✓	✓	✓	✓	✓	
	4	✓	✓	✓	✓	✓	✓	✓	✓	✓	✓	✓	✓	✓	✓	
	5	✓	✓	✓	✓	-	-	✓	✓	✓	✓	✓	✓	✓	✓	
	7	-	-	✓	✓	✓	✓	✓	✓	✓	✓	✓	✓	✓	✓	
	12	✓	✓	✓	✓	-	-	✓	✓	✓	✓	✓	✓	✓	✓	
	13	-	-	✓	✓	-	-	✓	✓	✓	✓	✓	✓	✓	✓	
	17	-	-	✓	✓	-	-	✓	✓	✓	✓	✓	✓	✓	✓	
	25	✓	✓	✓	✓	✓	✓	✓	✓	✓	✓	✓	✓	✓	✓	
	26	✓	✓	✓	✓	✓	-	✓	✓	✓	✓	✓	✓	✓	✓	
	38	-	-	✓	✓	✓	✓	✓	✓	✓	✓	✓	✓	✓	✓	
	41	-	-	✓	✓	✓	✓	✓	✓	✓	✓	✓	✓	✓	✓	
66	✓	✓	✓	✓	✓	✓	✓	✓	✓	✓	✓	✓	✓	✓		
Peak-to-Average Ratio	2						✓	✓	✓	✓		✓	✓	✓	✓	
	4						✓	✓	✓	✓		✓	✓	✓	✓	
	5				✓	-	-	✓	✓	✓		✓	✓	✓	✓	
	7	-	-				✓	✓	✓	✓		✓	✓	✓	✓	
	12				✓	-	-	✓	✓	✓		✓	✓	✓	✓	
	13	-	-		✓	-	-	✓	✓	✓		✓	✓	✓	✓	
	17	-	-		✓	-	-	✓	✓	✓		✓	✓	✓	✓	
	25							✓	✓	✓	✓		✓	✓	✓	
	26				✓			-	✓	✓	✓		✓	✓	✓	✓
	38	-	-					✓	✓	✓	✓		✓	✓	✓	✓
	41	-	-					✓	✓	✓	✓		✓	✓	✓	✓
66							✓	✓	✓	✓		✓	✓	✓	✓	



Test Items	Band	Bandwidth (MHz)						Modulation		RB #			Test Channel		
		1.4	3	5	10	15	20	QPSK	16QAM	1	Half	Full	L	M	H
26dB and 99% Bandwidth	2	v	v	v	v	v	v	v	v			v	v	v	v
	4	v	v	v	v	v	v	v	v			v	v	v	v
	5	v	v	v	v	-	-	v	v			v	v	v	v
	7	-	-	v	v	v	v	v	v			v	v	v	v
	12	v	v	v	v	-	-	v	v			v	v	v	v
	13	-	-	v	v	-	-	v	v			v	v	v	v
	17	-	-	v	v	-	-	v	v			v	v	v	v
	25	v	v	v	v	v	v	v	v			v	v	v	v
	26	v	v	v	v	v	-	v	v			v	v	v	v
	38	-	-	v	v	v	v	v	v			v	v	v	v
	41	-	-	v	v	v	v	v	v			v	v	v	v
66	v	v	v	v	v	v	v	v			v	v	v	v	
Conducted Band Edge	2	v	v	v	v	v	v	v	v	v		v	v		v
	4	v	v	v	v	v	v	v	v	v		v	v		v
	5	v	v	v	v	-	-	v	v	v		v	v		v
	7	-	-	v	v	v	v	v	v	v		v	v		v
	12	v	v	v	v	-	-	v	v	v		v	v		v
	13	-	-	v	v	-	-	v	v	v		v	v		v
	17	-	-	v	v	-	-	v	v	v		v	v		v
	25	v	v	v	v	v	v	v	v	v		v	v		v
	26	v	v	v	v	v	-	v	v	v		v	v		v
	38	-	-	v	v	v	v	v	v	v		v	v		v
	41	-	-	v	v	v	v	v	v	v		v	v		v
66	v	v	v	v	v	v	v	v	v		v	v		v	



Test Items	Band	Bandwidth (MHz)						Modulation		RB #			Test Channel		
		1.4	3	5	10	15	20	QPSK	16QAM	1	Half	Full	L	M	H
Conducted Spurious Emission	2	✓	✓	✓	✓	✓	✓	✓	✓	✓			✓	✓	✓
	4	✓	✓	✓	✓	✓	✓	✓	✓	✓			✓	✓	✓
	5	✓	✓	✓	✓	-	-	✓	✓	✓			✓	✓	✓
	7	-	-	✓	✓	✓	✓	✓	✓	✓			✓	✓	✓
	12	✓	✓	✓	✓	-	-	✓	✓	✓			✓	✓	✓
	13	-	-	✓	✓	-	-	✓	✓	✓			✓	✓	✓
	17	-	-	✓	✓	-	-	✓	✓	✓			✓	✓	✓
	25	✓	✓	✓	✓	✓	✓	✓	✓	✓			✓	✓	✓
	26	✓	✓	✓	✓	✓	-	✓	✓	✓			✓	✓	✓
	38	-	-	✓	✓	✓	✓	✓	✓	✓			✓	✓	✓
	41	-	-	✓	✓	✓	✓	✓	✓	✓			✓	✓	✓
66	✓	✓	✓	✓	✓	✓	✓	✓	✓			✓	✓	✓	
Frequency Stability	2				✓			✓				✓		✓	
	4				✓			✓				✓		✓	
	5				✓	-	-	✓				✓		✓	
	7	-	-		✓			✓				✓		✓	
	12				✓	-	-	✓				✓		✓	
	13	-	-		✓	-	-	✓				✓		✓	
	17	-	-		✓	-	-	✓				✓		✓	
	25				✓			✓				✓		✓	
	26				✓		-	✓				✓		✓	
	38	-	-		✓			✓				✓		✓	
	41	-	-		✓			✓				✓		✓	
66				✓			✓				✓		✓		



Test Items	Band	Bandwidth (MHz)						Modulation		RB #			Test Channel		
		1.4	3	5	10	15	20	QPSK	16QAM	1	Half	Full	L	M	H
E.R.P/ E.I.R.P.	2	v	v	v	v	v	v	v	v	v	v		v	v	v
	4	v	v	v	v	v	v	v	v	v	v		v	v	v
	5	v	v	v	v	-	-	v	v	v	v		v	v	v
	7	-	-	v	v	v	v	v	v	v			v	v	v
	12	v	v	v	v	v	v	v	v	v			v	v	v
	13	-	-	v	v	v	v	v	v	v			v	v	v
	17	-	-	v	v	-	-	v	v	v			v	v	v
	25	v	v	v	v	v	v	v	v	v	v		v	v	v
	26	v	v	v	v	v	-	v	v	v	v		v	v	v
	38	-	-	v	v	v	v	v	v	v			v	v	v
	41	-	-	v	v	v	v	v	v	v			v	v	v
	66	v	v	v	v	v	v	v	v	v	v		v	v	v
Radiated Spurious Emission	2	Worst case											v	v	v
	4	Worst case											v	v	v
	5	Worst case											v	v	v
	7	Worst case											v	v	v
	12	Worst case											v	v	v
	13	Worst case											v	v	v
	17	Worst case											v	v	v
	25	Worst case											v	v	v
	26	Worst case											v	v	v
	38	Worst case											v	v	v
	41	Worst case											v	v	v
66	Worst case											v	v	v	
Note	<ol style="list-style-type: none"> The mark "v" means that this configuration is chosen for testing The mark "-" means that this bandwidth is not supported. The device is investigated from 30MHz to 10 times of fundamental signal for radiated spurious emission test under different RB size/offset and modulations in exploratory test. Subsequently, only the worst case emissions are reported. All the radiated test cases were performed with Adapter 1. 														

2.2 Connection Diagram of Test System

<EUT Standalone>

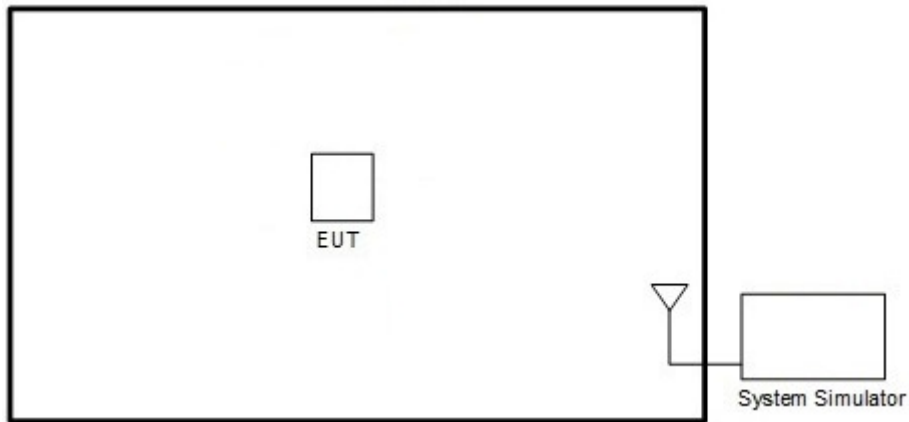

<EUT with Accessories>

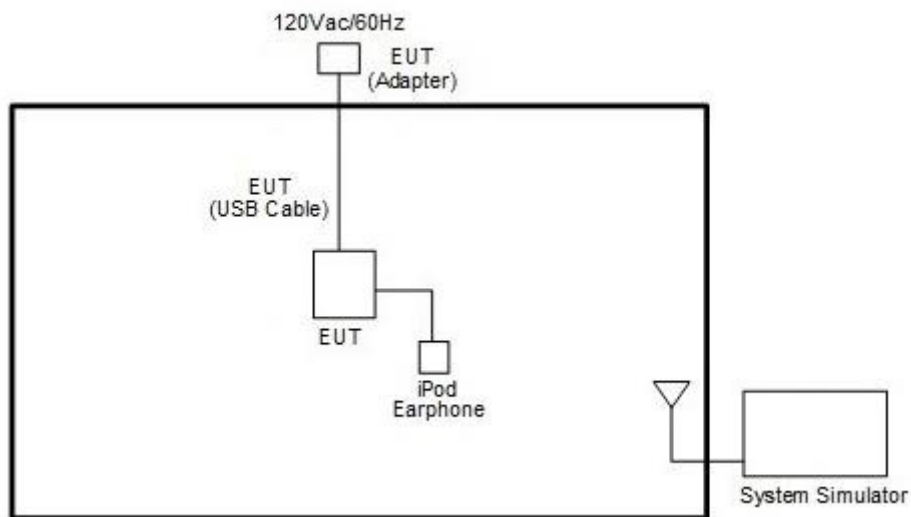

2.3 Support Unit used in test configuration and system

Item	Equipment	Trade Name	Model No.	FCC ID	Data Cable	Power Cord
1.	System Simulator	Anritsu	MT8820C	N/A	N/A	Unshielded, 1.8 m
2.	iPod Earphone	Apple	N/A	Verification	Unshielded, 1.0m	N/A



2.4 Measurement Results Explanation Example

For all conducted test items:

The offset level is set in the spectrum analyzer to compensate the RF cable loss and attenuator factor between EUT conducted output port and spectrum analyzer. With the offset compensation, the spectrum analyzer reading level is exactly the EUT RF output level.

The spectrum analyzer offset is derived from RF cable loss and attenuator factor.

$$\text{Offset} = \text{RF cable loss} + \text{attenuator factor}.$$

Following shows an offset computation example with cable loss 4.2 dB and 10dB attenuator.

Example :

$$\begin{aligned} \text{Offset(dB)} &= \text{RF cable loss(dB)} + \text{attenuator factor(dB)}. \\ &= 4.2 + 10 = 14.2 \text{ (dB)} \end{aligned}$$

2.5 Frequency List of Low/Middle/High Channels

LTE Band 2 Channel and Frequency List				
BW [MHz]	Channel/Frequency(MHz)	Lowest	Middle	Highest
20	Channel	18700	18900	19100
	Frequency	1860	1880	1900
15	Channel	18675	18900	19125
	Frequency	1857.5	1880	1902.5
10	Channel	18650	18900	19150
	Frequency	1855	1880	1905
5	Channel	18625	18900	19175
	Frequency	1852.5	1880	1907.5
3	Channel	18615	18900	19185
	Frequency	1851.5	1880	1908.5
1.4	Channel	18607	18900	19193
	Frequency	1850.7	1880	1909.3



LTE Band 4 Channel and Frequency List				
BW [MHz]	Channel/Frequency(MHz)	Lowest	Middle	Highest
20	Channel	20050	20175	20300
	Frequency	1720	1732.5	1745
15	Channel	20025	20175	20325
	Frequency	1717.5	1732.5	1747.5
10	Channel	20000	20175	20350
	Frequency	1715	1732.5	1750
5	Channel	19975	20175	20375
	Frequency	1712.5	1732.5	1752.5
3	Channel	19965	20175	20385
	Frequency	1711.5	1732.5	1753.5
1.4	Channel	19957	20175	20393
	Frequency	1710.7	1732.5	1754.3

LTE Band 5 Channel and Frequency List				
BW [MHz]	Channel/Frequency(MHz)	Lowest	Middle	Highest
10	Channel	20450	20525	20600
	Frequency	829	836.5	844
5	Channel	20425	20525	20625
	Frequency	826.5	836.5	846.5
3	Channel	20415	20525	20635
	Frequency	825.5	836.5	847.5
1.4	Channel	20407	20525	20643
	Frequency	824.7	836.5	848.3



LTE Band 7 Channel and Frequency List				
BW [MHz]	Channel/Frequency(MHz)	Lowest	Middle	Highest
20	Channel	20850	21100	21350
	Frequency	2510	2535	2560
15	Channel	20825	21100	21375
	Frequency	2507.5	2535	2562.5
10	Channel	20800	21100	21400
	Frequency	2505	2535	2565
5	Channel	20775	21100	21425
	Frequency	2502.5	2535	2567.5

LTE Band 12 Channel and Frequency List				
BW [MHz]	Channel/Frequency(MHz)	Lowest	Middle	Highest
10	Channel	23060	23095	23130
	Frequency	704	707.5	711
5	Channel	23035	23095	23155
	Frequency	701.5	707.5	713.5
3	Channel	23025	23095	23165
	Frequency	700.5	707.5	714.5
1.4	Channel	23017	23095	23173
	Frequency	699.7	707.5	715.3

LTE Band 13 Channel and Frequency List				
BW [MHz]	Channel/Frequency(MHz)	Lowest	Middle	Highest
10	Channel	-	23230	-
	Frequency	-	782	-
5	Channel	23205	23230	23255
	Frequency	779.5	782	784.5

LTE Band 17 Channel and Frequency List				
BW [MHz]	Channel/Frequency(MHz)	Lowest	Middle	Highest
10	Channel	23780	23790	23800
	Frequency	709	710	711
5	Channel	23755	23790	23825
	Frequency	706.5	710	713.5



LTE Band 25 Channel and Frequency List				
BW [MHz]	Channel/Frequency(MHz)	Lowest	Middle	Highest
20	Channel	26140	26340	26590
	Frequency	1860	1880	1905
15	Channel	26115	26340	26615
	Frequency	1857.5	1880	1907.5
10	Channel	26090	26340	26640
	Frequency	1855	1880	1910
5	Channel	26065	26340	26665
	Frequency	1852.5	1880	1912.5
3	Channel	26055	26340	26675
	Frequency	1851.5	1880	1913.5
1.4	Channel	26047	26340	26683
	Frequency	1850.7	1880	1914.3

LTE Band 26 Channel and Frequency List				
BW [MHz]	Channel/Frequency(MHz)	Lowest	Middle	Highest
15	Channel	26865	26915	26965
	Frequency	831.5	836.5	841.5
10	Channel	26840	26915	26990
	Frequency	829	836.5	844
5	Channel	26815	26915	27015
	Frequency	826.5	836.5	846.5
3	Channel	26805	26915	27025
	Frequency	825.5	836.5	847.5
1.4	Channel	26797	26915	27033
	Frequency	824.7	836.5	848.3



LTE Band 38 Channel and Frequency List				
BW [MHz]	Channel/Frequency(MHz)	Lowest	Middle	Highest
20	Channel	37850	38000	38150
	Frequency	2580	2595	2610
15	Channel	37825	38000	38175
	Frequency	2577.5	2595	2612.5
10	Channel	37800	38000	38200
	Frequency	2575	2595	2615
5	Channel	37775	38000	38225
	Frequency	2572.5	2595	2617.5

LTE Band 41 Channel and Frequency List				
BW [MHz]	Channel/Frequency(MHz)	Lowest	Middle	Highest
20	Channel	39750	40620	41490
	Frequency	2506	2593	2680
15	Channel	39725	40620	41515
	Frequency	2503.5	2593	2682.5
10	Channel	39700	40620	41540
	Frequency	2501	2593	2685
5	Channel	39675	40620	41565
	Frequency	2498.5	2593	2687.5

LTE Band 66 Channel and Frequency List				
BW [MHz]	Channel/Frequency(MHz)	Lowest	Middle	Highest
20	Channel	132072	132322	132572
	Frequency	1720	1745	1770
15	Channel	132047	132322	132597
	Frequency	1717.5	1745	1772.5
10	Channel	132022	132322	132622
	Frequency	1715	1745	1775
5	Channel	131997	132322	132647
	Frequency	1712.5	1745	1777.5
3	Channel	131987	132322	132657
	Frequency	1711.5	1745	1778.5
1.4	Channel	131979	132322	132665
	Frequency	1710.7	1745	1779.3

3 Conducted Test Items

3.1 Measuring Instruments

See list of measuring instruments of this test report.

3.2 Test Setup

3.2.1 Conducted Output Power

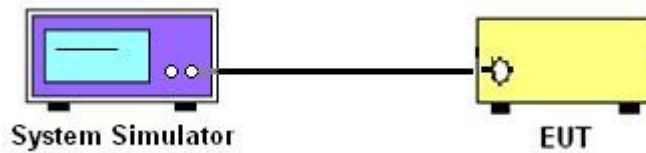

3.2.2 Peak-to-Average Ratio, Occupied Bandwidth ,Conducted Band-Edge and Conducted Spurious Emission

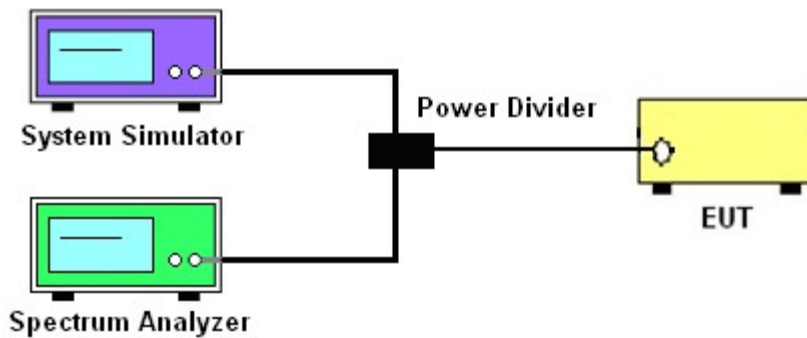

3.2.3 Frequency Stability



3.3 Test Result of Conducted Test

Please refer to Appendix A.



3.4 Conducted Output Power and ERP/EIRP

3.4.1 Description of the Conducted Output Power Measurement and ERP/EIRP Measurement

A system simulator was used to establish communication with the EUT. Its parameters were set to force the EUT transmitting at maximum output power. The measured power in the radio frequency on the transmitter output terminals shall be reported.

The ERP of mobile transmitters must not exceed 7 Watts for LTE Band 5 and Band 26.

The ERP of mobile transmitters must not exceed 3 Watts for LTE Band 12, Band 13 and Band 17.

The EIRP of mobile transmitters must not exceed 2 Watts for LTE Band 2, Band 25, Band 7, Band 38 and Band 41.

The EIRP of mobile transmitters must not exceed 1 Watts for LTE Band 4 and Band 66.

According to KDB 412172 D01 Power Approach,

$EIRP = P_T + G_T - L_C$, $ERP = EIRP - 2.15$, where

P_T = transmitter output power in dBm

G_T = gain of the transmitting antenna in dBi

L_C = signal attenuation in the connecting cable between the transmitter and antenna in dB

3.4.2 Test Procedures

1. The transmitter output port was connected to the system simulator.
2. Set EUT at maximum power through the system simulator.
3. Select lowest, middle, and highest channels for each band and different modulation.
4. Measure and record the power level from the system simulator.



3.5 Peak-to-Average Ratio

3.5.1 Description of the PAR Measurement

Power Complementary Cumulative Distribution Function (CCDF) curves provide a means for characterizing the power peaks of a digitally modulated signal on a statistical basis. A CCDF curve depicts the probability of the peak signal amplitude exceeding the average power level. Most contemporary measurement instrumentation include the capability to produce CCDF curves for an input signal provided that the instrument's resolution bandwidth can be set wide enough to accommodate the entire input signal bandwidth. In measuring transmissions in this band using an average power technique, the peak-to-average ratio (PAR) of the transmission may not exceed 13 dB.

3.5.2 Test Procedures

The testing follows FCC KDB 971168 v03 Section 5.7.1

1. The EUT was connected to spectrum and system simulator via a power divider.
2. Set the CCDF (Complementary Cumulative Distribution Function) option in spectrum analyzer.
3. The highest RF powers were measured and recorded the maximum PAPR level associated with a probability of 0.1 %.
4. Record the deviation as Peak to Average Ratio.



3.6 Occupied Bandwidth

3.6.1 Description of Occupied Bandwidth Measurement

The occupied bandwidth is the width of a frequency band such that, below the lower and above the upper frequency limits, the mean powers emitted are each equal to a specified percentage 0.5% of the total mean transmitted power.

The 26 dB emission bandwidth is defined as the frequency range between two points, one above and one below the carrier frequency, at which the spectral density of the emission is attenuated 26 dB below the maximum in-band spectral density of the modulated signal. Spectral density (power per unit bandwidth) is to be measured with a detector of resolution bandwidth equal to approximately 1.0% of the emission bandwidth.

3.6.2 Test Procedures

The testing follows FCC KDB 971168 v03 Section 4.2

1. The EUT was connected to spectrum analyzer and system simulator via a power divider.
2. The spectrum analyzer center frequency is set to the nominal EUT channel center frequency. The span range for the spectrum analyzer shall be between two and five times the anticipated OBW.
3. The nominal resolution bandwidth (RBW) shall be in the range of 1 to 5 % of the anticipated OBW, and the VBW shall be at least 3 times the RBW.
4. Set the detection mode to peak, and the trace mode to max hold.
5. Determine the reference value: Set the EUT to transmit a modulated signal. Allow the trace to stabilize. Set the spectrum analyzer marker to the highest level of the displayed trace.
(this is the reference value)
6. Determine the “-26 dB down amplitude” as equal to (Reference Value – X).
7. Place two markers, one at the lowest and the other at the highest frequency of the envelope of the spectral display such that each marker is at or slightly below the “-X dB down amplitude” determined in step 6. If a marker is below this “-X dB down amplitude” value it shall be placed as close as possible to this value. The OBW is the positive frequency difference between the two markers.
8. Use the 99 % power bandwidth function of the spectrum analyzer and report the measured bandwidth.



3.7 Conducted Band Edge

3.7.1 Description of Conducted Band Edge Measurement

22.917(a)

For operations in the 824 – 849 MHz band, the FCC limit is $43 + 10\log_{10}(P[\text{Watts}])$ dB below the transmitter power P(Watts) in a 100kHz bandwidth. However, in the 1MHz bands immediately outside and adjacent to the licensee's frequency block, a resolution bandwidth of at least one percent of the emission bandwidth of the fundamental emission of the transmitter may be employed.

24.238 (a)

For operations in the 1850-1910 and 1930-1990 MHz band, the FCC limit is $43 + 10\log_{10}(P[\text{Watts}])$ dB below the transmitter power P(Watts) in a 1MHz bandwidth. However, in the 1 MHz bands immediately outside and adjacent to the frequency block a resolution bandwidth of at least one percent of the emission bandwidth of the fundamental emission of the transmitter may be employed.

27.53 (c)

For operations in the 776-788 MHz band, the FCC limit is $43 + 10\log_{10}(P[\text{Watts}])$ dB below the transmitter power P(Watts) in a 100 kHz bandwidth. However, in the 100 kHz bands immediately outside and adjacent to the frequency block, a resolution bandwidth of at least 30 kHz may be employed. In addition, the power of any unwanted emissions in any 6.25 kHz bandwidth for all frequencies between 763-775 MHz and 793-806 MHz shall be attenuated below the transmitter power, P (dBW), by at least $65 + 10 \log_{10} p(\text{watts})$, dB, for mobile and portable equipment.

27.53 (g)

For operations in the 698 -746 MHz band, the FCC limit is $43 + 10\log_{10}(P[\text{Watts}])$ dB below the transmitter power P(Watts) in a 100 kHz bandwidth. However, in the 100 kilohertz bands immediately outside and adjacent to a licensee's frequency block, a resolution bandwidth of at least 30 kHz may be employed.

27.53 (h)

For operations in the 1710 – 1755 MHz band, the FCC limit is $43 + 10\log_{10}(P[\text{Watts}])$ dB below the transmitter power P(Watts) in a 1 MHz bandwidth. However, in the 1MHz bands immediately outside and adjacent to the licensee's frequency block, a resolution bandwidth of at least one percent of the emission bandwidth of the fundamental emission of the transmitter may be employed.



27.53(m)(4)

For mobile digital stations, the attenuation factor shall be not less than $40 + 10 \log (P)$ dB on all frequencies between the channel edge and 5 megahertz from the channel edge, $43 + 10 \log (P)$ dB on all frequencies between 5 megahertz and X megahertz from the channel edge, and $55 + 10 \log (P)$ dB on all frequencies more than X megahertz from the channel edge, where X is the greater of 6 megahertz or the actual emission bandwidth as defined in paragraph (m)(6) of this section. In addition, the attenuation factor shall not be less that $43 + 10 \log (P)$ dB on all frequencies between 2490.5 MHz and 2496 MHz and $55 + 10 \log (P)$ dB at or below 2490.5 MHz. Mobile Satellite Service licensees operating on frequencies below 2495 MHz may also submit a documented interference complaint against BRS licensees operating on channel BRS Channel 1 on the same terms and conditions as adjacent channel BRS or EBS licensees.

3.7.2 Test Procedures

The testing follows FCC KDB 971168 v03 Section 6.0.

1. The EUT was connected to spectrum analyzer and system simulator via a power divider.
2. The band edges of low and high channels for the highest RF powers were measured.
3. Set RBW \geq 1% EBW in the 1MHz band immediately outside and adjacent to the band edge.
4. Beyond the 1 MHz band from the band edge, RBW=1MHz was used.
5. Set spectrum analyzer with RMS detector.
6. The RF fundamental frequency should be excluded against the limit line in the operating frequency band.
7. Checked that all the results comply with the emission limit line.
The limit line is derived from $43 + 10\log(P)$ dB below the transmitter power P(Watts)
8. For LTE Band 7, 38, 41, the other 40 dB, and 55 dB have additionally applied same calculation above.



3.8 Conducted Spurious Emission

3.8.1 Description of Conducted Spurious Emission Measurement

The power of any emission outside of the authorized operating frequency ranges must be lower than the transmitter power (P) by a factor of at least $43 + 10 \log (P)$ dB.

For Band 7,38,41:

The power of any emission outside of the authorized operating frequency ranges must be lower than the transmitter power (P) by a factor of at least $55 + 10 \log (P)$ dB.

It is measured by means of a calibrated spectrum analyzer and scanned from 30 MHz up to a frequency including its 10th harmonic.

3.8.2 Test Procedures

The testing follows FCC KDB 971168 v03 Section 6.0.

1. The EUT was connected to spectrum analyzer and system simulator via a power divider.
2. The RF output of EUT was connected to the spectrum analyzer by RF cable and attenuator.
The path loss was compensated to the results for each measurement.
3. The middle channel for the highest RF power within the transmitting frequency was measured.
4. The conducted spurious emission for the whole frequency range was taken.
5. Make the measurement with the spectrum analyzer's RBW = 1MHz, VBW = 3MHz.
6. Set spectrum analyzer with RMS detector.
7. Taking the record of maximum spurious emission.
8. The RF fundamental frequency should be excluded against the limit line in the operating frequency band.
9. The limit line is derived from $43 + 10\log(P)$ dB below the transmitter power P(Watts)
10. For Band 7, 38, 41
The limit line is derived from $55 + 10\log(P)$ dB below the transmitter power P(Watts)



3.9 Frequency Stability

3.9.1 Description of Frequency Stability Measurement

The frequency stability shall be measured by variation of ambient temperature and variation of primary supply voltage to ensure that the fundamental emission stays within the authorized frequency block. The frequency stability of the transmitter shall be maintained within $\pm 0.00025\%$ ($\pm 2.5\text{ppm}$) of the center frequency.

3.9.2 Test Procedures for Temperature Variation

The testing follows FCC KDB 971168 v03 Section 9.0.

1. The EUT was set up in the thermal chamber and connected with the system simulator.
2. With power OFF, the temperature was decreased to -30°C and the EUT was stabilized before testing. Power was applied and the maximum change in frequency was recorded within one minute.
3. With power OFF, the temperature was raised in 10°C step up to 50°C . The EUT was stabilized at each step for at least half an hour. Power was applied and the maximum frequency change was recorded within one minute.

3.9.3 Test Procedures for Voltage Variation

The testing follows FCC KDB 971168 v03 Section 9.0.

1. The EUT was placed in a temperature chamber at $20\pm 5^{\circ}\text{C}$ and connected with the system simulator.
2. The power supply voltage to the EUT was varied from 85% to 115% of the nominal value measured at the input to the EUT.
3. The variation in frequency was measured for the worst case.

4 Radiated Test Items

4.1 Measuring Instruments

See list of measuring instruments of this test report.

4.2 Test Setup

4.2.1 For radiated test from 30MHz to 1GHz

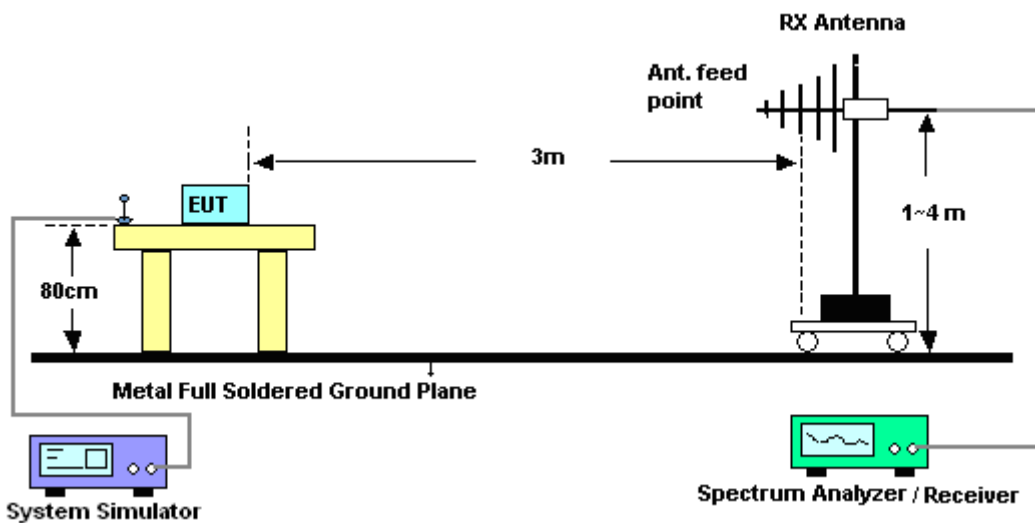

4.2.2 For radiated test above 1GHz

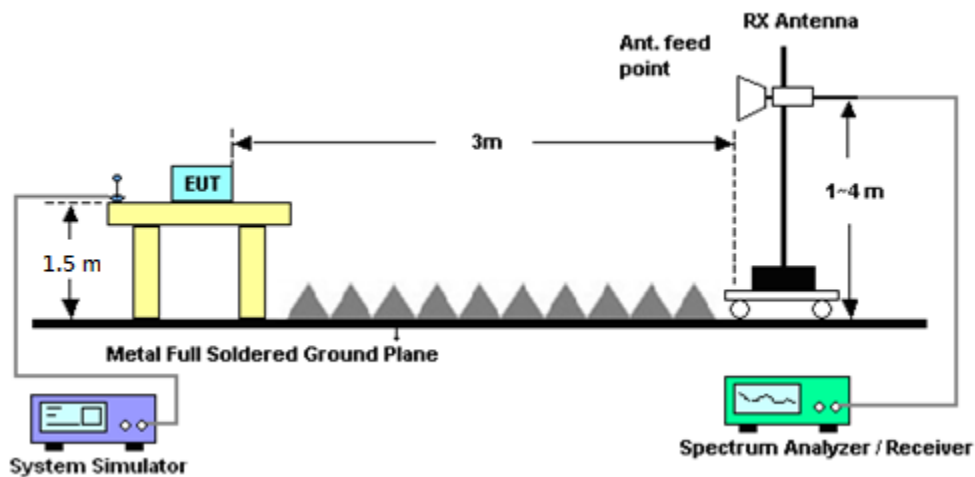

4.3 Test Result of Radiated Test

Please refer to Appendix B.



4.4 Radiated Spurious Emission

4.4.1 Description of Radiated Spurious Emission

The radiated spurious emission was measured by substitution method according to ANSI / TIA-603-E. The power of any emission outside of the authorized operating frequency ranges must be attenuated below the transmitter power (P) by a factor of at least $43 + 10 \log (P)$ dB.

For Band 7, 38, 41

The power of any emission outside of the authorized operating frequency ranges must be attenuated below the transmitter power (P) by a factor of at least $55 + 10 \log (P)$ dB.

For LTE Band 12,13,17

For operations in the 746-758 MHz, 775-788 MHz, and 805-806 MHz bands, emissions in the band 1559-1610 MHz shall be limited to -70 dBW/MHz equivalent isotropically radiated power (EIRP) for wideband signals, and -80 dBW EIRP for discrete emissions of less than 700 Hz bandwidth.

The spectrum is scanned from 30 MHz up to a frequency including its 10th harmonic.

4.4.2 Test Procedures

The testing follows FCC KDB 971168 v03 Section 5.8 and ANSI / TIA-603-E Section 2.2.12.

1. The EUT was placed on a turntable with 0.8 meter for frequency below 1GHz and 1.5 meter for frequency above 1GHz respectively above ground.
2. The EUT was set 3 meters from the receiving antenna, which was mounted on the antenna tower.
3. The table was rotated 360 degrees to determine the position of the highest spurious emission.
4. The height of the receiving antenna is varied between one meter and four meters to search the maximum spurious emission for both horizontal and vertical polarizations.
5. Make the measurement with the spectrum analyzer's RBW = 1MHz, VBW = 3MHz, taking the record of maximum spurious emission.
6. A horn antenna was substituted in place of the EUT and was driven by a signal generator.
7. Tune the output power of signal generator to the same emission level with EUT maximum spurious emission.
8. Taking the record of output power at antenna port.
9. Repeat step 7 to step 8 for another polarization.
10. The RF fundamental frequency should be excluded against the limit line in the operating frequency band.

The limit line is derived from $43 + 10\log(P)$ dB below the transmitter power P(Watts)

11. For Band 7, 38, 41:

The limit line is derived from $55 + 10\log(P)$ dB below the transmitter power P(Watts)

$EIRP (dBm) = S.G. Power - Tx Cable Loss + Tx Antenna Gain$

$ERP (dBm) = EIRP - 2.15$



5 List of Measuring Equipment

Instrument	Manufacturer	Model No.	Serial No.	Characteristics	Calibration Date	Test Date	Due Date	Remark
LTE Base Station	Anritsu	MT8820C	620143282 1	GSM/GPRS /WCDMA/LTE	Oct. 13, 2017	Jan. 03, 2018~ Jan. 29, 2018	Oct. 12, 2018	Conducted (TH05-HY)
Spectrum Analyzer	Rohde & Schwarz	FSV40	101397	10Hz~40GHz	Nov. 07, 2017	Jan. 03, 2018~ Jan. 29, 2018	Nov. 06, 2018	Conducted (TH05-HY)
Spectrum Analyzer	Rohde & Schwarz	FSV30	100895	9kHz~30GHz	Apr. 25, 2017	Jan. 03, 2018~ Jan. 29, 2018	Apr. 24, 2018	Conducted (TH05-HY)
Temperature Chamber	ESPEC	SH-641	92013720	-30°C~70°C	Aug. 28, 2017	Jan. 03, 2018~ Jan. 29, 2018	Aug. 27, 2018	Conducted (TH05-HY)
Programmable Power Supply	GW Instek	PSS-2005	EL890001	1V~20V 0.5A~5A	Oct. 06, 2017	Jan. 03, 2018~ Jan. 29, 2018	Oct. 05, 2018	Conducted (TH05-HY)
Coupler	Warison	1-18GHz 20d B 25WSMA Directional C oupler	#B	1G~18GHz	Feb. 20, 2017	Jan. 03, 2018~ Jan. 29, 2018	Feb. 19, 2018	Conducted (TH05-HY)
Amplifier	MITEQ	TTA1840-35- HG	1871923	18GHz~40GHz, VSWR : 2.5:1 max	Jul. 18, 2017	Jan. 17, 2018~ Jan. 22, 2018	Jul. 17, 2018	Radiation (03CH13-HY)
Bilog Antenna	TESEQ	CBL 6111D&N-6-0 6	35414&AT- N0602	30MHz~1GHz	Oct. 14, 2017	Jan. 17, 2018~ Jan. 22, 2018	Oct. 13, 2018	Radiation (03CH13-HY)
Amplifier	Sonoma-Instru ment	310 N	187282	9KHz~1GHz	Dec. 21, 2016	Jan. 17, 2018~ Jan. 22, 2018	Dec. 20, 2018	Radiation (03CH13-HY)
Horn Antenna	SCHWARZBE CK	BBHA 9120 D	9120D-124 1	1GHz ~ 18GHz	Jun. 15, 2017	Jan. 17, 2018~ Jan. 22, 2018	Jun. 14, 2018	Radiation (03CH13-HY)
Preamplifier	MITEQ	AMF-7D-0010 1800-30-10P	1590074	1GHz~18GHz	May 22, 2017	Jan. 17, 2018~ Jan. 22, 2018	May 21, 2018	Radiation (03CH13-HY)
Spectrum Analyzer	Keysight	N9010A	MY553705 26	10Hz~44GHz	Mar. 15, 2017	Jan. 17, 2018~ Jan. 22, 2018	Mar. 14, 2018	Radiation (03CH13-HY)
Antenna Mast	EMEC	AM-BS-4500- B	N/A	1m~4m	N/A	Jan. 17, 2018~ Jan. 22, 2018	N/A	Radiation (03CH13-HY)
Turn Table	EMEC	TT2000	N/A	0~360 Degree	N/A	Jan. 17, 2018~ Jan. 22, 2018	N/A	Radiation (03CH13-HY)
SHF-EHF Horn Antenna	SCHWARZBE CK	BBHA 9170	BBHA9170 251	18GHz- 40GHz	Nov. 10, 2017	Jan. 17, 2018~ Jan. 22, 2018	Nov. 09, 2018	Radiation (03CH13-HY)
SHF-EHF Horn Antenna	SCHWARZBE CK	BBHA 9170	BBHA9170 584	18GHz- 40GHz	Nov. 27, 2017	Jan. 17, 2018~ Jan. 22, 2018	Nov. 26, 2018	Radiation (03CH13-HY)
Horn Antenna	SCHWARZBE CK	BBHA 9120 D	9120D-152 2	1G~18GHz	Mar. 17, 2017	Jan. 17, 2018~ Jan. 22, 2018	Mar. 16, 2018	Radiation (03CH13-HY)
Signal Generator	Rohde & Schwarz	SMF100A	101107	100kHz~40GHz	May 22, 2017	Jan. 17, 2018~ Jan. 22, 2018	May 21, 2018	Radiation (03CH13-HY)
Preamplifier	Keysight	83017A	MY532702 64	1GHz ~ 26.5GHz	Dec. 05, 2017	Jan. 17, 2018~ Jan. 22, 2018	Dec. 04, 2018	Radiation (03CH13-HY)



6 Uncertainty of Evaluation

Uncertainty of Radiated Emission Measurement (30 MHz ~ 1000 MHz)

Measuring Uncertainty for a Level of Confidence of 95% ($U = 2Uc(y)$)	3.07
---	------

Uncertainty of Radiated Emission Measurement (1 GHz ~ 18 GHz)

Measuring Uncertainty for a Level of Confidence of 95% ($U = 2Uc(y)$)	3.48
---	------

Uncertainty of Radiated Emission Measurement (18 GHz ~ 40 GHz)

Measuring Uncertainty for a Level of Confidence of 95% ($U = 2Uc(y)$)	3.92
---	------



Appendix A. Test Results of Conducted Test

Conducted Output Power(Average power)

LTE Band 2 Maximum Average Power [dBm]						
BW [MHz]	RB Size	RB Offset	Mod	Lowest	Middle	Highest
20	1	0	QPSK	23.15	23.08	22.88
20	1	49		23.36	23.29	23.22
20	1	99		22.98	22.94	22.93
20	50	0		22.38	22.24	22.13
20	50	24		22.25	22.20	22.06
20	50	50		22.26	21.92	22.01
20	100	0		22.36	22.20	22.02
20	1	0	16-QAM	21.75	21.62	21.78
20	1	49		21.88	21.65	21.52
20	1	99		21.45	21.55	21.38
20	50	0		21.32	21.21	21.03
20	50	24		21.16	21.05	21.14
20	50	50		21.13	20.94	21.10
20	100	0		21.31	21.07	20.99
15	1	0	QPSK	23.32	23.01	22.84
15	1	37		23.31	23.30	23.17
15	1	74		23.15	23.03	22.95
15	36	0		22.36	22.24	22.05
15	36	20		22.28	22.25	21.98
15	36	39		22.28	21.99	21.99
15	75	0		22.39	22.25	22.04
15	1	0	16-QAM	22.07	21.87	21.86
15	1	37		22.35	21.85	22.29
15	1	74		22.33	22.04	22.09
15	36	0		21.26	21.15	20.98
15	36	20		21.17	21.08	20.93
15	36	39		21.28	21.00	21.05
15	75	0		21.38	21.17	21.11



LTE Band 2 Maximum Average Power [dBm]						
BW [MHz]	RB Size	RB Offset	Mod	Lowest	Middle	Highest
10	1	0	QPSK	23.18	22.91	22.77
10	1	25		23.34	23.30	23.17
10	1	49		22.92	22.78	22.78
10	25	0		22.40	22.26	22.06
10	25	12		22.42	22.29	22.09
10	25	25		22.29	22.06	22.04
10	50	0		22.28	22.22	22.05
10	1	0	16-QAM	21.82	21.97	21.48
10	1	25		22.18	22.16	22.19
10	1	49		21.67	21.16	21.49
10	25	0		21.39	21.32	21.03
10	25	12		21.37	21.29	21.11
10	25	25		21.40	21.07	21.27
10	50	0		21.30	21.24	20.99
5	1	0	QPSK	23.03	22.88	22.83
5	1	12		23.29	23.16	23.01
5	1	24		23.17	22.74	22.69
5	12	0		22.34	22.20	22.03
5	12	7		22.30	22.20	22.03
5	12	13		22.31	22.13	21.92
5	25	0		22.25	22.24	22.04
5	1	0	16-QAM	21.63	21.66	21.32
5	1	12		21.82	21.80	21.63
5	1	24		21.57	21.59	21.34
5	12	0		21.31	20.98	20.97
5	12	7		21.26	20.96	21.14
5	12	13		21.29	20.97	20.87
5	25	0		21.40	21.21	21.23



LTE Band 2 Maximum Average Power [dBm]						
BW [MHz]	RB Size	RB Offset	Mod	Lowest	Middle	Highest
3	1	0	QPSK	23.13	22.93	22.91
3	1	8		23.07	22.97	22.85
3	1	14		22.95	22.78	22.63
3	8	0		22.35	22.24	22.16
3	8	4		22.36	22.20	22.06
3	8	7		22.35	22.11	22.01
3	15	0		22.31	22.27	22.04
3	1	0	16-QAM	22.36	22.19	22.10
3	1	8		22.37	21.78	21.75
3	1	14		22.34	21.42	21.42
3	8	0		21.31	21.12	21.11
3	8	4		21.36	21.17	21.04
3	8	7		21.39	20.99	21.07
3	15	0		21.41	21.12	21.17
1.4	1	0	QPSK	23.16	23.15	22.78
1.4	1	3		23.33	23.14	22.73
1.4	1	5		23.28	22.99	22.90
1.4	3	0		23.28	23.25	23.06
1.4	3	1		23.24	23.26	22.99
1.4	3	3		23.23	23.27	23.02
1.4	6	0		22.30	22.22	21.98
1.4	1	0	16-QAM	21.75	21.69	21.56
1.4	1	3		21.87	22.07	21.82
1.4	1	5		21.73	21.65	21.56
1.4	3	0		22.12	22.06	21.91
1.4	3	1		22.24	22.10	22.00
1.4	3	3		22.19	21.96	21.87
1.4	6	0		21.16	21.08	20.96



LTE Band 25 Maximum Average Power [dBm]						
BW [MHz]	RB Size	RB Offset	Mod	Lowest	Middle	Highest
20	1	0	QPSK	22.97	22.88	22.79
20	1	49		23.42	23.26	22.88
20	1	99		22.95	22.63	22.55
20	50	0		22.31	22.23	22.13
20	50	24		22.21	22.15	21.97
20	50	50		22.15	22.01	21.88
20	100	0		22.26	22.19	21.97
20	1	0	16-QAM	21.64	21.59	21.72
20	1	49		21.69	21.60	22.10
20	1	99		21.41	21.12	21.42
20	50	0		21.34	21.23	21.09
20	50	24		21.32	21.26	21.01
20	50	50		21.26	21.12	20.98
20	100	0		21.26	21.10	21.05
15	1	0	QPSK	23.09	23.13	22.73
15	1	37		23.24	23.32	23.26
15	1	74		23.19	23.08	22.77
15	36	0		22.18	22.26	22.06
15	36	20		22.29	22.18	22.07
15	36	39		22.31	22.12	21.90
15	75	0		22.22	22.18	22.01
15	1	0	16-QAM	21.71	21.66	21.74
15	1	37		21.84	21.68	22.24
15	1	74		21.71	21.53	21.52
15	36	0		21.37	21.28	21.00
15	36	20		21.21	21.14	21.07
15	36	39		21.32	21.04	20.93
15	75	0		21.22	21.11	21.10



LTE Band 25 Maximum Average Power [dBm]						
BW [MHz]	RB Size	RB Offset	Mod	Lowest	Middle	Highest
10	1	0	QPSK	22.89	22.81	22.71
10	1	25		23.31	23.26	22.89
10	1	49		23.25	22.81	22.74
10	25	0		22.22	22.17	22.00
10	25	12		22.28	22.20	21.88
10	25	25		22.21	22.07	21.88
10	50	0		22.24	22.13	21.96
10	1	0	16-QAM	21.60	21.62	21.63
10	1	25		21.72	22.14	21.88
10	1	49		21.58	21.52	21.43
10	25	0		21.30	21.37	20.94
10	25	12		21.16	21.36	20.90
10	25	25		21.10	20.99	20.88
10	50	0		21.05	21.05	20.88
5	1	0	QPSK	22.80	22.88	22.90
5	1	12		23.15	23.00	23.08
5	1	24		23.01	22.85	22.53
5	12	0		22.15	22.06	21.95
5	12	7		22.17	22.02	21.91
5	12	13		22.14	21.99	21.85
5	25	0		22.12	22.10	22.00
5	1	0	16-QAM	21.48	22.08	22.02
5	1	12		21.79	21.81	21.57
5	1	24		22.05	21.68	21.34
5	12	0		21.13	20.89	21.07
5	12	7		21.27	20.91	20.70
5	12	13		21.09	20.95	20.70
5	25	0		21.28	21.01	20.94



LTE Band 25 Maximum Average Power [dBm]						
BW [MHz]	RB Size	RB Offset	Mod	Lowest	Middle	Highest
3	1	0	QPSK	22.95	22.92	22.90
3	1	8		23.17	22.88	22.71
3	1	14		23.22	22.88	22.78
3	8	0		22.33	22.17	22.17
3	8	4		22.19	22.14	21.95
3	8	7		22.27	22.05	21.98
3	15	0		22.20	22.12	21.97
3	1	0	16-QAM	21.51	22.13	22.04
3	1	8		21.99	21.73	21.65
3	1	14		22.19	21.46	21.31
3	8	0		21.26	20.82	20.69
3	8	4		21.22	21.10	20.68
3	8	7		21.22	21.21	20.85
3	15	0		21.19	21.13	20.94
1.4	1	0	QPSK	23.04	22.96	22.73
1.4	1	3		23.08	23.09	22.62
1.4	1	5		22.93	22.96	22.64
1.4	3	0		23.09	23.18	22.77
1.4	3	1		23.13	23.21	22.76
1.4	3	3		23.19	23.11	22.82
1.4	6	0		22.20	22.07	21.87
1.4	1	0	16-QAM	22.08	21.59	21.25
1.4	1	3		21.75	21.96	21.50
1.4	1	5		21.56	21.61	21.22
1.4	3	0		21.99	22.00	21.74
1.4	3	1		22.13	22.02	21.74
1.4	3	3		22.09	21.97	21.77
1.4	6	0		21.11	21.03	20.77



LTE Band 4 Maximum Average Power [dBm]						
BW [MHz]	RB Size	RB Offset	Mod	Lowest	Middle	Highest
20	1	0	QPSK	22.82	23.02	23.38
20	1	49		23.31	23.33	23.48
20	1	99		22.94	22.99	23.11
20	50	0		22.17	22.28	22.60
20	50	24		22.26	22.19	22.40
20	50	50		22.26	22.21	22.29
20	100	0		22.26	22.20	22.40
20	1	0	16-QAM	21.57	21.91	22.17
20	1	49		21.79	22.13	22.01
20	1	99		22.03	21.47	21.72
20	50	0		21.16	21.25	21.48
20	50	24		21.24	21.13	21.37
20	50	50		21.14	21.21	21.28
20	100	0		21.22	21.30	21.39
15	1	0	QPSK	23.16	23.23	23.22
15	1	37		23.20	23.22	23.21
15	1	74		23.20	23.28	23.21
15	36	0		22.23	22.27	22.48
15	36	20		22.21	22.26	22.38
15	36	39		22.27	22.27	22.36
15	75	0		22.14	22.16	22.33
15	1	0	16-QAM	21.35	21.75	22.10
15	1	37		21.83	21.96	22.09
15	1	74		21.72	21.37	21.72
15	36	0		21.05	21.21	21.44
15	36	20		21.14	21.20	21.45
15	36	39		21.36	21.30	21.36
15	75	0		21.22	21.26	21.42



LTE Band 4 Maximum Average Power [dBm]						
BW [MHz]	RB Size	RB Offset	Mod	Lowest	Middle	Highest
10	1	0	QPSK	23.07	23.03	23.23
10	1	25		23.28	23.41	23.31
10	1	49		22.99	23.05	23.26
10	25	0		22.19	22.29	22.42
10	25	12		22.14	22.23	22.34
10	25	25		22.10	22.19	22.36
10	50	0		22.05	22.13	22.34
10	1	0	16-QAM	21.68	22.00	21.98
10	1	25		22.40	22.11	22.13
10	1	49		22.24	21.79	22.06
10	25	0		21.22	21.18	21.60
10	25	12		21.23	21.28	21.37
10	25	25		21.31	21.29	21.24
10	50	0		21.13	21.23	21.34
5	1	0	QPSK	22.83	23.06	23.06
5	1	12		23.21	23.41	23.17
5	1	24		23.09	23.00	23.06
5	12	0		22.05	22.27	22.24
5	12	7		22.11	22.21	22.35
5	12	13		22.06	22.16	22.28
5	25	0		22.05	22.26	22.30
5	1	0	16-QAM	21.43	21.75	22.26
5	1	12		21.69	21.89	22.01
5	1	24		22.11	21.84	21.55
5	12	0		20.87	21.12	21.05
5	12	7		21.20	21.06	21.36
5	12	13		21.07	21.02	21.45
5	25	0		21.27	21.21	21.31



LTE Band 4 Maximum Average Power [dBm]						
BW [MHz]	RB Size	RB Offset	Mod	Lowest	Middle	Highest
3	1	0	QPSK	22.80	23.11	23.09
3	1	8		22.96	23.06	22.96
3	1	14		22.98	23.15	23.15
3	8	0		22.12	22.30	22.09
3	8	4		22.24	22.27	22.22
3	8	7		22.01	22.31	22.20
3	15	0		22.09	22.25	22.19
3	1	0	16-QAM	21.38	22.43	21.66
3	1	8		21.49	22.22	21.52
3	1	14		21.41	21.72	21.64
3	8	0		21.06	21.20	20.91
3	8	4		21.10	21.27	21.17
3	8	7		21.13	21.28	21.17
3	15	0		21.02	21.32	21.29
1.4	1	0	QPSK	22.90	23.13	23.05
1.4	1	3		23.03	23.07	23.08
1.4	1	5		22.93	23.06	23.05
1.4	3	0		23.10	23.18	23.16
1.4	3	1		23.09	23.35	23.18
1.4	3	3		23.09	23.28	23.12
1.4	6	0		22.03	22.19	22.06
1.4	1	0	16-QAM	22.10	21.78	21.62
1.4	1	3		21.76	21.89	21.81
1.4	1	5		21.60	22.07	21.71
1.4	3	0		21.91	22.03	21.98
1.4	3	1		21.99	22.11	21.99
1.4	3	3		21.98	22.05	21.99
1.4	6	0		21.03	21.02	20.95



LTE Band 5 Maximum Average Power [dBm]						
BW [MHz]	RB Size	RB Offset	Mod	Lowest	Middle	Highest
10	1	0	QPSK	22.99	23.14	22.71
10	1	25		23.19	23.21	22.85
10	1	49		22.87	22.99	22.68
10	25	0		22.24	22.29	22.10
10	25	12		22.24	22.22	22.03
10	25	25		22.21	22.10	21.88
10	50	0		22.20	22.21	21.96
10	1	0	16-QAM	21.88	21.65	21.49
10	1	25		21.80	21.75	21.62
10	1	49		21.75	21.46	21.39
10	25	0		21.09	21.20	21.06
10	25	12		21.19	21.29	21.11
10	25	25		21.21	21.29	21.01
10	50	0		21.21	21.31	21.06
5	1	0	QPSK	23.02	22.91	22.77
5	1	12		23.06	23.12	22.83
5	1	24		22.83	22.94	22.57
5	12	0		22.24	22.13	21.97
5	12	7		22.19	22.15	22.00
5	12	13		22.08	22.23	21.80
5	25	0		22.11	22.19	21.87
5	1	0	16-QAM	21.55	21.53	21.53
5	1	12		21.88	22.39	21.98
5	1	24		21.52	21.65	21.29
5	12	0		21.03	20.93	20.95
5	12	7		20.96	20.97	20.94
5	12	13		20.97	20.96	20.67
5	25	0		21.12	21.09	20.90



LTE Band 5 Maximum Average Power [dBm]						
BW [MHz]	RB Size	RB Offset	Mod	Lowest	Middle	Highest
3	1	0	QPSK	23.18	22.81	22.74
3	1	8		23.04	22.92	22.70
3	1	14		22.79	22.97	22.73
3	8	0		22.21	22.07	22.07
3	8	4		22.21	22.15	21.84
3	8	7		22.16	22.14	21.77
3	15	0		22.25	22.11	21.89
3	1	0	16-QAM	21.53	21.54	21.16
3	1	8		21.62	21.57	21.36
3	1	14		21.77	21.53	21.38
3	8	0		21.21	21.22	20.91
3	8	4		21.26	21.22	20.91
3	8	7		21.16	21.20	20.77
3	15	0		21.19	21.08	20.85
1.4	1	0	QPSK	23.16	23.09	22.93
1.4	1	3		23.05	23.00	22.72
1.4	1	5		23.10	23.14	22.75
1.4	3	0		23.13	23.11	23.01
1.4	3	1		23.02	23.17	23.04
1.4	3	3		23.18	23.14	22.84
1.4	6	0		22.21	22.21	21.95
1.4	1	0	16-QAM	21.84	21.69	21.68
1.4	1	3		22.00	22.07	21.70
1.4	1	5		21.76	21.68	21.52
1.4	3	0		22.12	22.12	21.84
1.4	3	1		22.29	22.48	21.83
1.4	3	3		22.11	22.28	21.70
1.4	6	0		21.16	21.04	20.81



LTE Band 7 Maximum Average Power [dBm]						
BW [MHz]	RB Size	RB Offset	Mod	Lowest	Middle	Highest
20	1	0	QPSK	22.63	22.61	22.53
20	1	49		23.10	22.93	22.97
20	1	99		22.51	22.38	22.45
20	50	0		22.02	21.85	21.77
20	50	24		21.90	21.71	21.68
20	50	50		21.88	21.67	21.58
20	100	0		21.92	21.73	21.63
20	1	0	16-QAM	21.56	21.27	21.48
20	1	49		21.65	21.30	21.20
20	1	99		21.48	21.11	21.14
20	50	0		20.99	20.70	20.78
20	50	24		20.88	20.77	20.70
20	50	50		20.99	20.69	20.81
20	100	0		20.90	20.75	20.75
15	1	0	QPSK	22.86	22.57	22.52
15	1	37		23.03	22.82	23.07
15	1	74		22.80	22.74	22.54
15	36	0		22.09	21.85	21.72
15	36	20		22.01	21.75	21.73
15	36	39		22.01	21.68	21.72
15	75	0		22.08	21.75	21.73
15	1	0	16-QAM	21.78	21.47	21.59
15	1	37		22.46	22.11	22.04
15	1	74		21.79	21.47	21.38
15	36	0		21.00	20.89	20.72
15	36	20		21.12	20.88	20.84
15	36	39		20.96	20.81	20.82
15	75	0		21.10	20.88	20.85



LTE Band 7 Maximum Average Power [dBm]						
BW [MHz]	RB Size	RB Offset	Mod	Lowest	Middle	Highest
10	1	0	QPSK	22.71	22.50	22.42
10	1	25		23.02	22.71	22.64
10	1	49		23.00	22.42	22.45
10	25	0		22.11	21.76	21.77
10	25	12		22.01	21.75	21.69
10	25	25		22.01	21.69	21.66
10	50	0		21.97	21.73	21.67
10	1	0	16-QAM	21.52	21.29	21.38
10	1	25		21.53	21.91	22.00
10	1	49		21.17	21.22	21.37
10	25	0		21.03	20.80	20.79
10	25	12		21.12	20.80	20.81
10	25	25		21.20	20.62	20.77
10	50	0		21.08	20.68	20.79
5	1	0	QPSK	22.66	22.45	22.42
5	1	12		22.94	22.42	22.61
5	1	24		22.89	22.53	22.37
5	12	0		22.04	21.70	21.68
5	12	7		22.04	21.72	21.66
5	12	13		21.90	21.63	21.64
5	25	0		21.96	21.67	21.66
5	1	0	16-QAM	21.32	21.06	21.66
5	1	12		21.66	21.33	21.41
5	1	24		21.12	21.06	21.37
5	12	0		20.87	20.55	20.43
5	12	7		21.06	20.71	20.78
5	12	13		21.01	20.74	20.68
5	25	0		20.98	20.72	20.70



LTE Band 12 Maximum Average Power [dBm]						
BW [MHz]	RB Size	RB Offset	Mod	Lowest	Middle	Highest
10	1	0	QPSK	22.53	22.63	22.51
10	1	25		22.87	22.97	22.88
10	1	49		22.55	22.66	22.53
10	25	0		21.91	21.87	21.85
10	25	12		21.85	21.81	21.83
10	25	25		21.75	21.85	21.75
10	50	0		21.82	21.88	21.86
10	1	0	16-QAM	21.35	21.46	21.44
10	1	25		21.48	22.03	21.88
10	1	49		21.33	21.91	21.22
10	25	0		20.85	20.94	20.91
10	25	12		20.81	20.90	20.87
10	25	25		20.83	20.96	20.98
10	50	0		20.87	20.82	20.80
5	1	0	QPSK	22.63	22.46	22.64
5	1	12		22.82	22.85	22.83
5	1	24		22.63	22.78	22.47
5	12	0		21.71	21.84	21.84
5	12	7		21.83	21.89	21.69
5	12	13		21.76	21.80	21.68
5	25	0		21.75	21.79	21.76
5	1	0	16-QAM	21.26	21.24	21.82
5	1	12		21.47	21.65	21.97
5	1	24		21.35	21.41	21.70
5	12	0		20.54	20.57	20.84
5	12	7		20.65	20.82	20.92
5	12	13		20.81	20.90	20.82
5	25	0		20.90	20.90	20.82



LTE Band 12 Maximum Average Power [dBm]						
BW [MHz]	RB Size	RB Offset	Mod	Lowest	Middle	Highest
3	1	0	QPSK	22.76	22.70	22.76
3	1	8		22.66	22.60	22.77
3	1	14		22.66	22.66	22.50
3	8	0		21.80	21.81	21.82
3	8	4		21.81	21.81	21.82
3	8	7		21.77	21.78	21.83
3	15	0		21.84	21.78	21.77
3	1	0	16-QAM	21.25	21.50	21.09
3	1	8		21.23	21.70	21.57
3	1	14		21.57	21.29	21.25
3	8	0		20.83	20.83	20.87
3	8	4		20.75	20.94	20.87
3	8	7		20.82	21.01	20.85
3	15	0		20.85	20.98	20.88
1.4	1	0	QPSK	22.78	22.74	22.75
1.4	1	3		22.87	22.78	22.79
1.4	1	5		22.81	22.73	22.58
1.4	3	0		22.82	22.74	22.73
1.4	3	1		22.87	22.78	22.86
1.4	3	3		22.79	22.82	22.77
1.4	6	0		21.83	21.74	21.65
1.4	1	0	16-QAM	22.03	21.21	21.20
1.4	1	3		21.57	21.51	21.34
1.4	1	5		21.22	21.37	21.20
1.4	3	0		21.54	21.62	21.43
1.4	3	1		21.70	21.68	21.60
1.4	3	3		21.62	21.66	21.43
1.4	6	0		20.74	20.79	20.58



LTE Band 13 Maximum Average Power [dBm]						
BW [MHz]	RB Size	RB Offset	Mod	Lowest	Middle	Highest
10	1	0	QPSK		23.16	
10	1	25			23.32	
10	1	49			23.14	
10	25	0			22.46	
10	25	12			22.34	
10	25	25			22.36	
10	50	0			22.32	
10	1	0	16-QAM		21.70	
10	1	25			21.82	
10	1	49			21.81	
10	25	0			21.34	
10	25	12			21.32	
10	25	25			21.37	
10	50	0			21.31	
5	1	0	QPSK	22.98	22.95	23.12
5	1	12		22.99	23.30	23.12
5	1	24		23.21	23.02	23.24
5	12	0		22.27	22.33	22.22
5	12	7		22.24	22.36	22.38
5	12	13		22.40	22.25	22.40
5	25	0		22.25	22.30	22.36
5	1	0	16-QAM	22.35	21.92	21.72
5	1	12		21.84	21.93	21.96
5	1	24		21.75	21.92	21.74
5	12	0		20.96	21.03	21.11
5	12	7		21.20	21.36	21.39
5	12	13		21.29	21.34	21.41
5	25	0		21.23	21.30	21.31



LTE Band 17 Maximum Average Power [dBm]						
BW [MHz]	RB Size	RB Offset	Mod	Lowest	Middle	Highest
10	1	0	QPSK	22.80	22.83	22.93
10	1	25		23.20	23.35	23.34
10	1	49		23.33	23.26	23.18
10	25	0		22.25	22.32	22.28
10	25	12		22.18	22.28	22.24
10	25	25		22.23	22.31	22.25
10	50	0		22.23	22.31	22.28
10	1	0	16-QAM	21.96	21.59	21.58
10	1	25		21.76	21.73	22.49
10	1	49		21.77	22.38	21.67
10	25	0		21.29	21.26	21.32
10	25	12		21.40	21.33	21.34
10	25	25		21.50	21.40	21.45
10	50	0		21.21	21.34	21.31
5	1	0	QPSK	22.98	22.88	22.87
5	1	12		23.11	23.33	23.13
5	1	24		23.06	22.95	22.85
5	12	0		22.21	22.04	22.21
5	12	7		22.24	22.32	22.23
5	12	13		22.26	22.16	22.08
5	25	0		22.25	22.15	22.11
5	1	0	16-QAM	21.56	21.53	21.52
5	1	12		21.81	22.47	21.83
5	1	24		22.13	21.74	21.74
5	12	0		21.12	21.03	21.09
5	12	7		21.44	21.40	21.31
5	12	13		21.26	21.24	21.07
5	25	0		21.27	21.25	21.19



LTE Band 26 Maximum Average Power [dBm]						
BW [MHz]	RB Size	RB Offset	Mod	Lowest	Middle	Highest
15	1	0	QPSK	22.96	23.16	22.98
15	1	37		23.40	23.18	22.95
15	1	74		22.87	23.06	22.97
15	36	0		22.26	22.21	22.09
15	36	20		22.23	22.15	22.00
15	36	39		22.17	22.13	21.93
15	75	0		22.32	22.19	21.96
15	1	0	16-QAM	22.05	21.94	21.59
15	1	37		21.96	22.43	21.67
15	1	74		21.68	22.22	21.43
15	36	0		21.31	21.21	21.18
15	36	20		21.34	21.07	21.09
15	36	39		21.19	21.08	21.02
15	75	0		21.26	21.24	20.95
10	1	0	QPSK	22.93	23.00	22.74
10	1	25		23.11	23.34	22.90
10	1	49		22.82	23.17	22.57
10	25	0		22.26	22.25	21.90
10	25	12		22.30	22.23	21.96
10	25	25		22.22	22.04	21.88
10	50	0		22.26	22.22	21.97
10	1	0	16-QAM	21.87	21.71	21.70
10	1	25		22.59	21.84	21.58
10	1	49		21.90	21.57	21.59
10	25	0		21.30	21.18	20.98
10	25	12		21.23	21.24	20.94
10	25	25		21.32	21.13	20.97
10	50	0		21.22	21.22	21.06



LTE Band 26 Maximum Average Power [dBm]						
BW [MHz]	RB Size	RB Offset	Mod	Lowest	Middle	Highest
5	1	0	QPSK	22.92	22.94	22.61
5	1	12		23.31	23.29	22.84
5	1	24		22.83	23.05	22.68
5	12	0		22.26	22.14	21.88
5	12	7		22.20	22.15	21.90
5	12	13		22.17	22.16	21.76
5	25	0		22.19	22.19	21.84
5	1	0	16-QAM	21.65	22.04	21.58
5	1	12		22.01	22.18	21.61
5	1	24		21.83	21.47	21.21
5	12	0		21.22	20.98	20.85
5	12	7		21.09	21.21	20.91
5	12	13		21.00	21.20	20.78
5	25	0		21.24	21.17	20.80
3	1	0	QPSK	22.97	22.82	22.89
3	1	8		23.00	22.98	22.72
3	1	14		22.85	23.10	22.51
3	8	0		22.34	22.20	22.12
3	8	4		22.28	22.16	21.87
3	8	7		22.31	22.17	21.90
3	15	0		22.27	22.10	22.03
3	1	0	16-QAM	21.71	21.86	21.32
3	1	8		21.75	21.71	21.21
3	1	14		21.66	22.25	21.39
3	8	0		21.22	21.24	20.96
3	8	4		21.27	21.23	20.74
3	8	7		21.31	21.38	20.82
3	15	0		21.29	21.21	20.83



LTE Band 26 Maximum Average Power [dBm]						
BW [MHz]	RB Size	RB Offset	Mod	Lowest	Middle	Highest
1.4	1	0	QPSK	23.16	23.05	22.79
1.4	1	3		23.19	23.20	22.72
1.4	1	5		23.01	22.96	22.75
1.4	3	0		23.22	23.18	23.04
1.4	3	1		23.26	23.28	22.98
1.4	3	3		23.22	23.27	22.88
1.4	6	0		22.30	22.16	21.86
1.4	1	0	16-QAM	21.75	21.61	21.49
1.4	1	3		22.18	21.69	21.57
1.4	1	5		22.19	21.64	21.38
1.4	3	0		22.12	22.08	21.82
1.4	3	1		22.30	22.43	21.75
1.4	3	3		22.17	22.06	21.60
1.4	6	0		21.08	20.90	20.66



LTE Band 38 Maximum Average Power [dBm]						
BW [MHz]	RB Size	RB Offset	Mod	Lowest	Middle	Highest
20	1	0	QPSK	22.92	22.82	22.79
20	1	49		23.21	22.92	22.85
20	1	99		23.05	22.89	22.84
20	50	0		22.30	22.43	22.16
20	50	24		22.13	22.36	22.14
20	50	50		22.03	22.23	21.76
20	100	0		22.30	22.24	21.99
20	1	0	16-QAM	21.66	21.75	21.83
20	1	49		21.83	21.98	21.67
20	1	99		21.65	21.73	21.32
20	50	0		21.03	21.27	21.08
20	50	24		21.09	21.40	21.09
20	50	50		21.06	21.16	20.91
20	100	0		21.16	21.34	21.02
15	1	0	QPSK	22.86	22.72	22.73
15	1	37		23.08	23.13	23.05
15	1	74		22.98	22.86	22.58
15	36	0		22.30	22.33	22.20
15	36	20		22.42	22.43	22.16
15	36	39		22.00	22.23	21.73
15	75	0		22.04	22.32	21.86
15	1	0	16-QAM	21.60	21.86	21.66
15	1	37		22.13	22.30	21.57
15	1	74		21.89	21.63	21.33
15	36	0		21.16	21.18	21.08
15	36	20		21.10	21.20	21.03
15	36	39		21.08	21.01	20.92
15	75	0		21.03	21.23	20.87



LTE Band 38 Maximum Average Power [dBm]						
BW [MHz]	RB Size	RB Offset	Mod	Lowest	Middle	Highest
10	1	0	QPSK	22.88	22.91	22.88
10	1	25		23.09	23.04	23.06
10	1	49		22.90	22.95	22.67
10	25	0		22.25	22.38	22.16
10	25	12		22.16	22.31	22.11
10	25	25		22.33	22.21	22.00
10	50	0		22.14	22.30	22.04
10	1	0	16-QAM	21.46	21.75	21.51
10	1	25		22.00	21.75	21.60
10	1	49		21.75	21.68	21.40
10	25	0		21.27	21.35	21.18
10	25	12		21.23	21.32	21.15
10	25	25		21.28	21.23	21.04
10	50	0		21.13	21.35	20.92
5	1	0	QPSK	22.79	22.75	22.62
5	1	12		23.02	22.95	22.77
5	1	24		22.88	22.71	22.51
5	12	0		22.00	22.31	21.87
5	12	7		22.00	22.14	21.99
5	12	13		22.01	21.99	21.88
5	25	0		22.03	22.10	21.93
5	1	0	16-QAM	21.75	21.47	21.32
5	1	12		22.00	21.98	21.71
5	1	24		21.70	21.46	21.52
5	12	0		20.79	20.89	20.75
5	12	7		21.08	20.95	20.73
5	12	13		21.01	20.95	20.70
5	25	0		21.16	20.92	20.74



LTE Band 41 Maximum Average Power [dBm]						
BW [MHz]	RB Size	RB Offset	Mod	Lowest	Middle	Highest
20	1	0	QPSK	23.10	23.02	22.78
20	1	49		23.13	23.48	22.85
20	1	99		23.00	23.05	22.73
20	50	0		22.26	22.41	22.01
20	50	24		22.40	22.47	22.08
20	50	50		22.29	22.24	21.97
20	100	0		22.25	22.34	22.04
20	1	0	16-QAM	21.54	21.67	21.20
20	1	49		22.07	21.87	21.39
20	1	99		21.81	21.70	21.31
20	50	0		21.36	21.27	20.97
20	50	24		21.26	21.27	21.04
20	50	50		21.30	21.34	21.05
20	100	0		21.30	21.41	20.96
15	1	0	QPSK	23.10	22.76	22.66
15	1	37		23.44	23.42	22.92
15	1	74		23.12	23.00	22.60
15	36	0		22.31	22.49	21.99
15	36	20		22.40	22.40	22.03
15	36	39		22.23	22.14	21.86
15	75	0		22.31	22.20	22.00
15	1	0	16-QAM	21.84	21.69	21.30
15	1	37		22.15	21.75	21.60
15	1	74		21.76	21.79	21.36
15	36	0		21.13	21.24	20.89
15	36	20		21.22	21.38	20.94
15	36	39		21.26	21.09	20.94
15	75	0		21.42	21.10	21.00



LTE Band 41 Maximum Average Power [dBm]						
BW [MHz]	RB Size	RB Offset	Mod	Lowest	Middle	Highest
10	1	0	QPSK	23.26	22.83	22.47
10	1	25		23.34	23.38	22.89
10	1	49		23.29	23.18	22.77
10	25	0		22.53	22.40	22.01
10	25	12		22.32	22.52	22.03
10	25	25		22.32	22.28	22.01
10	50	0		22.25	22.40	21.99
10	1	0	16-QAM	21.82	21.63	21.43
10	1	25		21.73	21.81	21.44
10	1	49		21.87	21.91	21.30
10	25	0		21.46	21.41	20.96
10	25	12		21.68	21.34	21.02
10	25	25		21.52	21.29	20.94
10	50	0		21.34	21.25	21.01
5	1	0	QPSK	23.08	22.97	22.41
5	1	12		23.25	23.23	22.74
5	1	24		23.04	22.94	22.45
5	12	0		22.21	22.27	22.01
5	12	7		22.32	22.38	22.12
5	12	13		22.10	22.40	22.09
5	25	0		22.31	22.33	22.06
5	1	0	16-QAM	21.61	21.49	21.34
5	1	12		21.67	21.68	21.81
5	1	24		21.59	21.63	21.51
5	12	0		21.14	20.96	20.71
5	12	7		21.24	21.05	20.83
5	12	13		21.24	21.05	20.79
5	25	0		21.39	21.02	20.90



LTE Band 66 Maximum Average Power [dBm]						
BW [MHz]	RB Size	RB Offset	Mod	Lowest	Middle	Highest
20	1	0	QPSK	22.91	23.27	22.95
20	1	49		23.33	23.38	22.96
20	1	99		22.88	23.18	22.77
20	50	0		22.30	22.41	22.19
20	50	24		22.27	22.35	22.04
20	50	50		22.28	22.33	21.98
20	100	0		22.20	22.34	22.02
20	1	0	16-QAM	21.87	22.17	21.82
20	1	49		22.14	21.90	21.66
20	1	99		21.89	21.74	21.51
20	50	0		21.20	21.44	21.28
20	50	24		21.21	21.44	21.07
20	50	50		21.29	21.32	21.01
20	100	0		21.21	21.34	21.02
15	1	0	QPSK	23.20	23.10	22.99
15	1	37		23.23	23.31	23.22
15	1	74		23.23	23.24	22.80
15	36	0		22.25	22.31	22.11
15	36	20		22.26	22.33	21.99
15	36	39		22.28	22.29	22.17
15	75	0		22.15	22.41	22.11
15	1	0	16-QAM	21.94	22.18	21.96
15	1	37		21.92	22.01	22.23
15	1	74		21.79	22.40	21.57
15	36	0		21.21	21.39	21.01
15	36	20		21.16	21.33	21.09
15	36	39		21.27	21.37	21.01
15	75	0		21.22	21.40	21.14



LTE Band 66 Maximum Average Power [dBm]						
BW [MHz]	RB Size	RB Offset	Mod	Lowest	Middle	Highest
10	1	0	QPSK	22.96	23.26	22.87
10	1	25		23.05	23.17	23.21
10	1	49		23.06	23.15	22.85
10	25	0		22.10	22.38	22.15
10	25	12		22.26	22.37	21.99
10	25	25		22.21	22.32	22.01
10	50	0		22.20	22.27	22.01
10	1	0	16-QAM	21.91	21.97	21.83
10	1	25		21.72	21.82	22.36
10	1	49		21.68	21.74	21.70
10	25	0		21.08	21.40	21.06
10	25	12		21.23	21.47	21.08
10	25	25		21.16	21.41	21.08
10	50	0		21.12	21.24	20.88
5	1	0	QPSK	23.00	23.23	23.05
5	1	12		23.26	23.32	23.19
5	1	24		22.94	23.17	22.98
5	12	0		22.15	22.18	22.09
5	12	7		22.12	22.24	22.06
5	12	13		22.15	22.33	22.03
5	25	0		22.19	22.21	22.00
5	1	0	16-QAM	21.53	21.79	21.49
5	1	12		22.18	21.92	21.80
5	1	24		22.18	21.68	21.36
5	12	0		20.85	21.03	20.89
5	12	7		21.00	21.22	20.99
5	12	13		20.95	21.24	20.92
5	25	0		20.99	21.22	21.03



LTE Band 66 Maximum Average Power [dBm]						
BW [MHz]	RB Size	RB Offset	Mod	Lowest	Middle	Highest
3	1	0	QPSK	23.12	23.22	22.91
3	1	8		22.74	23.30	22.92
3	1	14		22.77	23.25	22.84
3	8	0		22.23	22.21	22.05
3	8	4		22.26	22.24	22.10
3	8	7		22.19	22.31	22.17
3	15	0		22.12	22.22	22.10
3	1	0	16-QAM	21.78	22.44	22.22
3	1	8		22.17	21.93	22.17
3	1	14		21.90	21.70	21.85
3	8	0		21.14	21.21	20.95
3	8	4		21.27	21.28	21.07
3	8	7		21.29	21.36	21.13
3	15	0		20.91	21.23	20.90
1.4	1	0	QPSK	23.06	23.19	23.02
1.4	1	3		23.17	23.24	22.92
1.4	1	5		23.15	23.19	22.97
1.4	3	0		23.12	23.26	23.03
1.4	3	1		23.12	23.30	23.04
1.4	3	3		23.22	23.27	23.14
1.4	6	0		22.10	22.22	22.08
1.4	1	0	16-QAM	22.34	21.81	21.55
1.4	1	3		21.94	22.17	21.96
1.4	1	5		22.04	22.08	21.92
1.4	3	0		22.33	22.24	21.85
1.4	3	1		22.36	22.33	22.05
1.4	3	3		22.19	21.92	22.05
1.4	6	0		21.06	21.04	20.90



LTE Band 2

Peak-to-Average Ratio

Mode	LTE Band 2 / 20MHz				
Mod.	QPSK		16QAM		Limit: 13dB
RB Size	1RB	Full RB	1RB	Full RB	Result
Lowest CH	4.84	5.01	5.86	6.2	PASS
Middle CH	4.93	5.1	6.09	6.23	
Highest CH	4.9	5.33	5.68	6.17	



LTE Band 2 / 20MHz / QPSK

Lowest Channel / 1RB

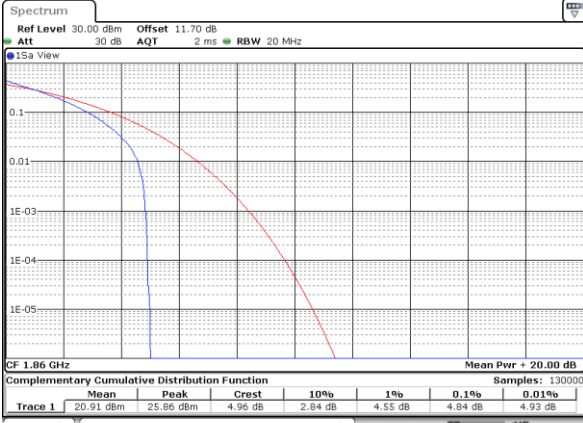

Date: 3 JAN 2018 17:07:23

Lowest Channel / Full RB

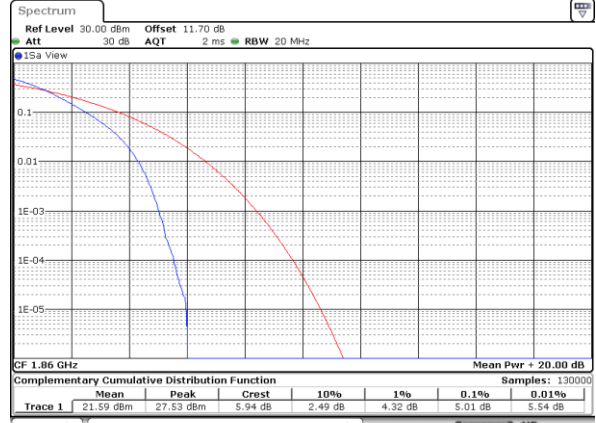

Date: 3 JAN 2018 17:07:32

Middle Channel / 1RB

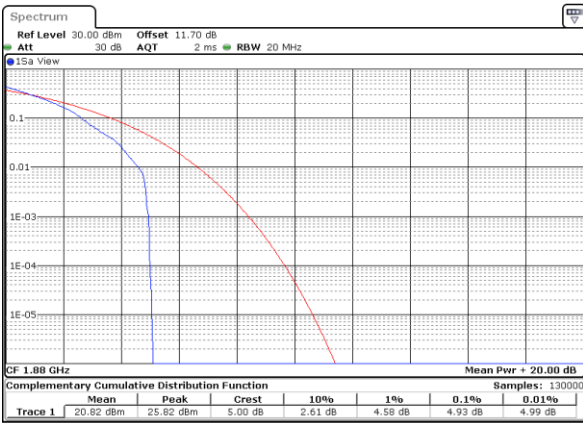

Date: 3 JAN 2018 17:07:41

Middle Channel / Full RB

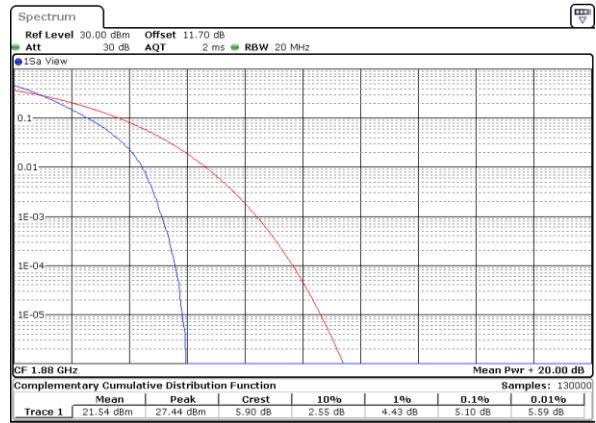

Date: 3 JAN 2018 17:07:50

Highest Channel / 1RB

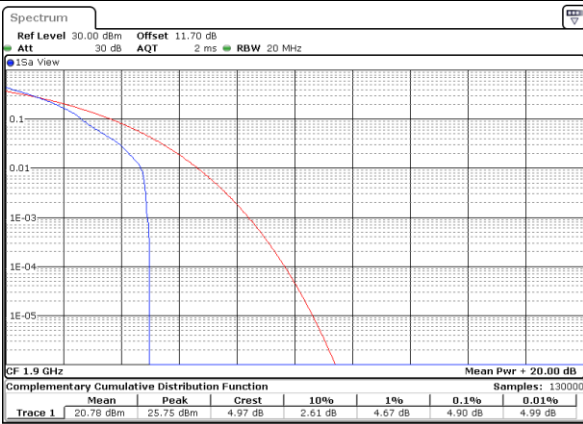

Date: 3 JAN 2018 17:07:59

Highest Channel / Full RB

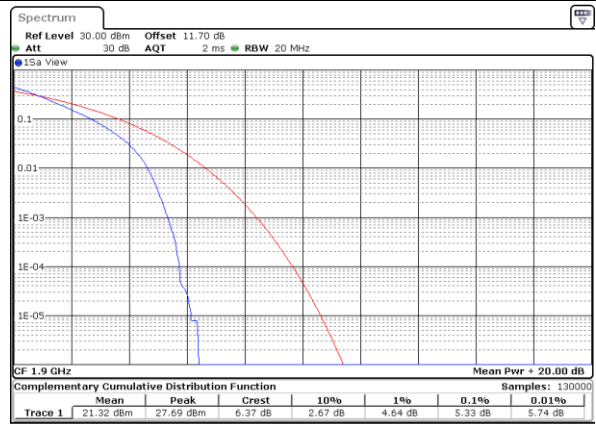

Date: 3 JAN 2018 17:08:08



LTE Band 2 / 20MHz / 16QAM

Lowest Channel / 1RB

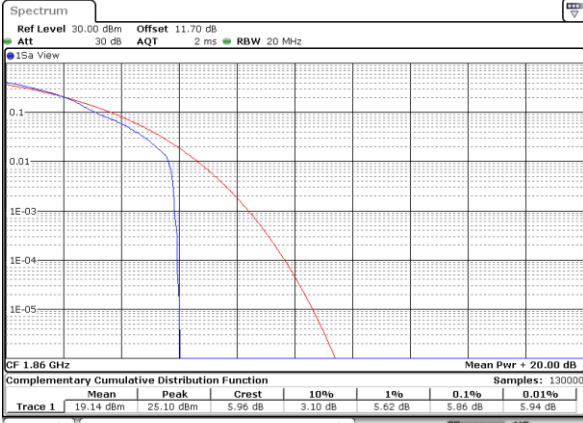

Date: 3 JAN 2018 17:05:55

Lowest Channel / Full RB

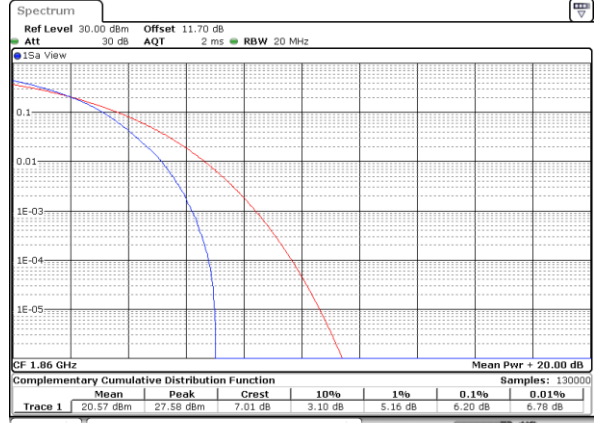

Date: 3 JAN 2018 17:06:05

Middle Channel / 1RB

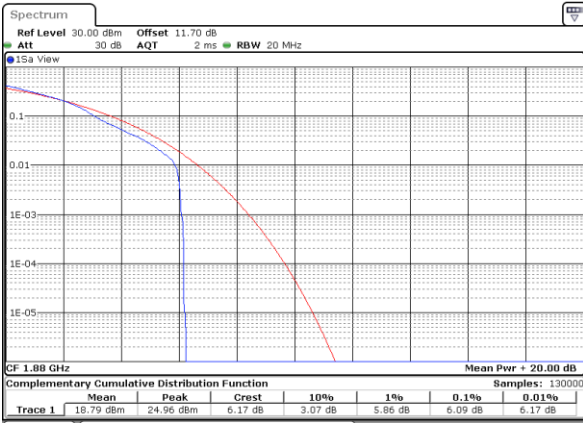

Date: 3 JAN 2018 17:06:14

Middle Channel / Full RB

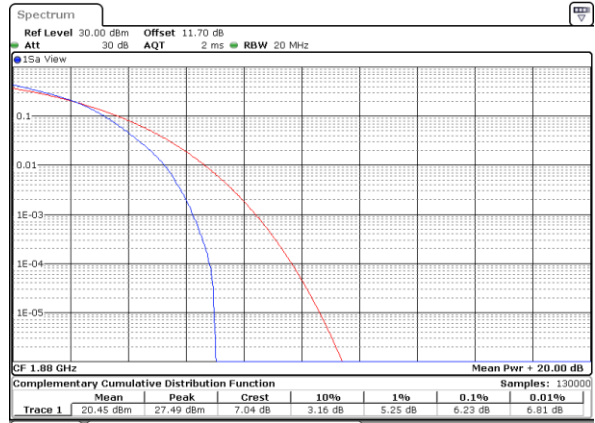

Date: 3 JAN 2018 17:06:53

Highest Channel / 1RB



Date: 3 JAN 2018 17:07:02

Highest Channel / Full RB

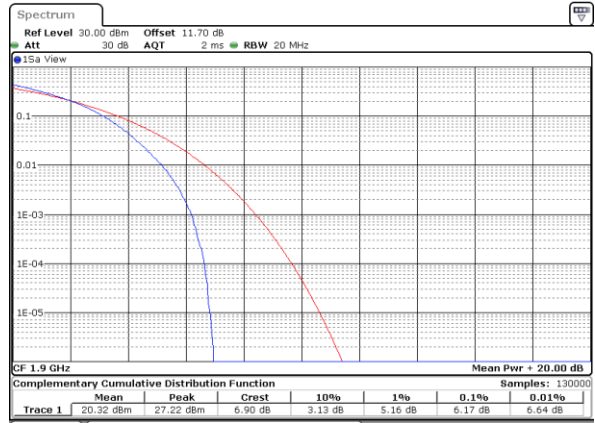

Date: 3 JAN 2018 17:07:11



26dB Bandwidth

Mode	LTE Band 2 : 26dB BW(MHz)											
	1.4MHz		3MHz		5MHz		10MHz		15MHz		20MHz	
BW												
Mod.	QPSK	16QAM	QPSK	16QAM	QPSK	16QAM	QPSK	16QAM	QPSK	16QAM	QPSK	16QAM
Lowest CH	1.27	1.27	2.97	2.99	4.88	4.81	10.01	9.85	14.21	14.24	20.10	20.02
Middle CH	1.28	1.27	3.03	2.99	4.91	4.96	9.81	9.75	14.57	14.12	20.30	20.34
Highest CH	1.28	1.27	3.03	2.99	5.01	4.81	9.79	9.83	14.54	14.33	20.02	20.06



LTE Band 2

Lowest Channel / 1.4MHz / QPSK

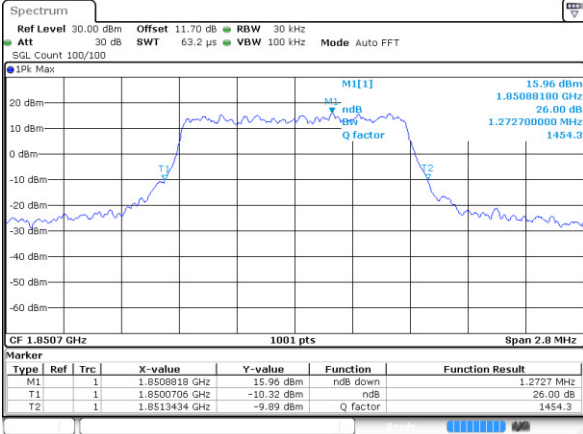

Date: 3 JAN 2018 16:47:51

Lowest Channel / 1.4MHz / 16QAM

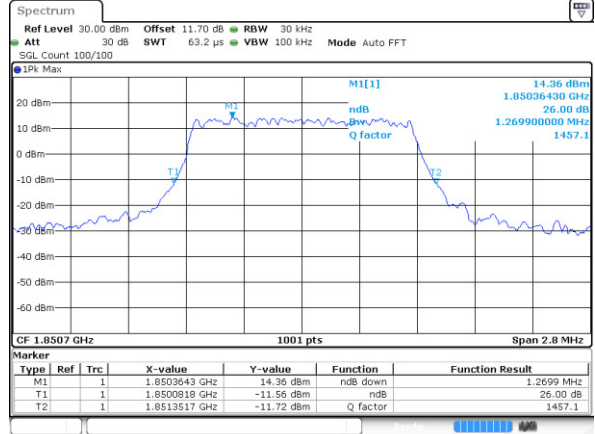

Date: 3 JAN 2018 16:48:01

Middle Channel / 1.4MHz / QPSK

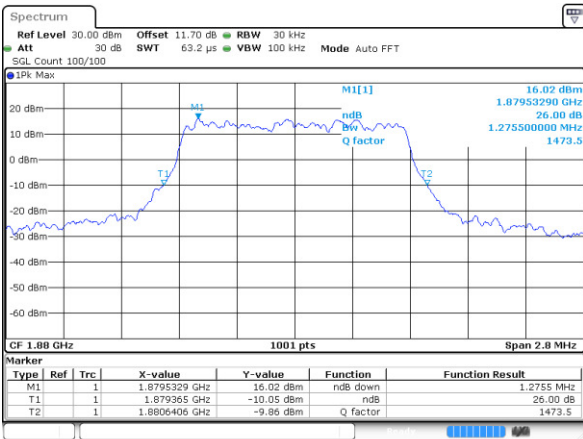

Date: 3 JAN 2018 16:54:54

Middle Channel / 1.4MHz / 16QAM

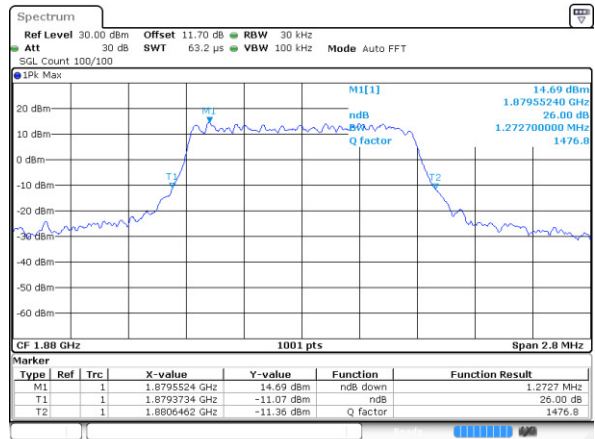

Date: 3 JAN 2018 16:55:04

Highest Channel / 1.4MHz / QPSK

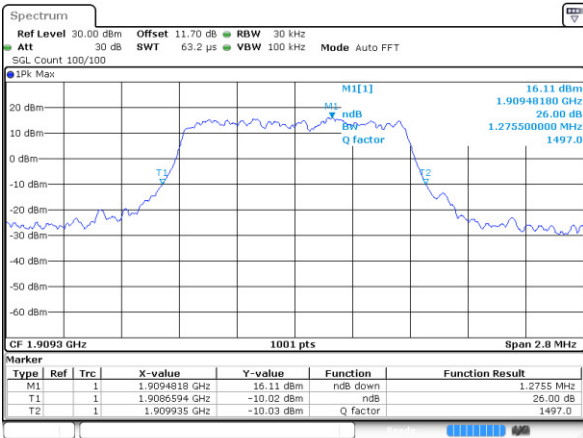

Date: 3 JAN 2018 16:57:22

Highest Channel / 1.4MHz / 16QAM

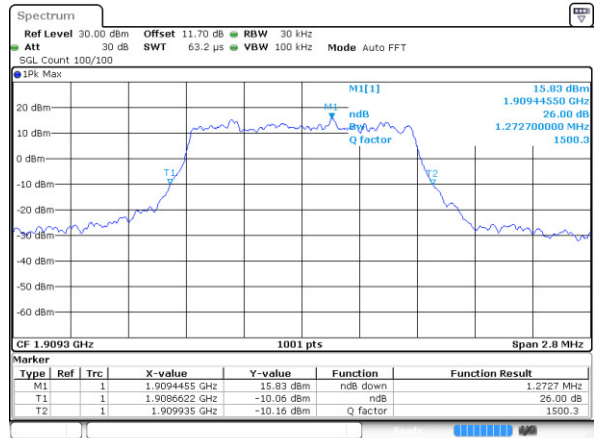

Date: 3 JAN 2018 16:57:32



LTE Band 2

Lowest Channel / 3MHz / QPSK

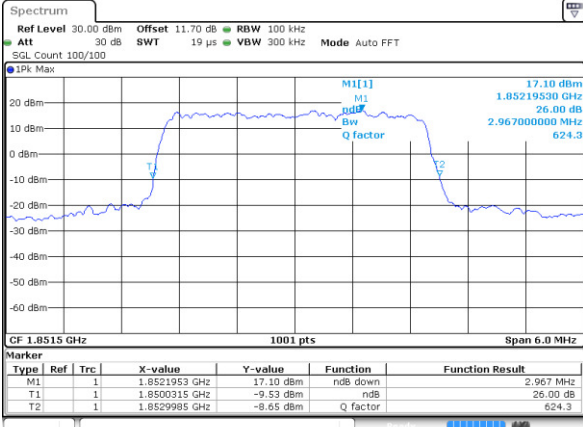

Date: 3 JAN 2018 15:11:50

Lowest Channel / 3MHz / 16QAM

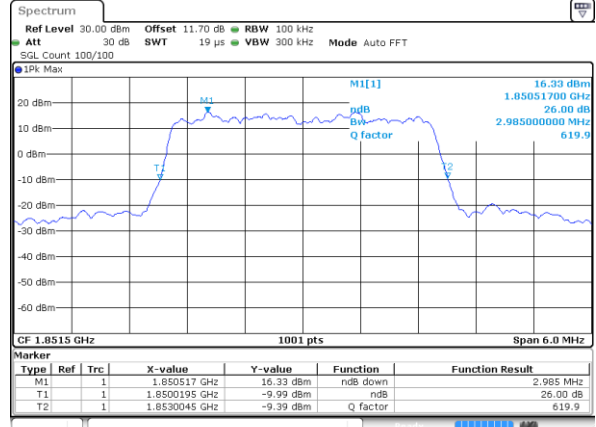

Date: 3 JAN 2018 15:12:00

Middle Channel / 3MHz / QPSK

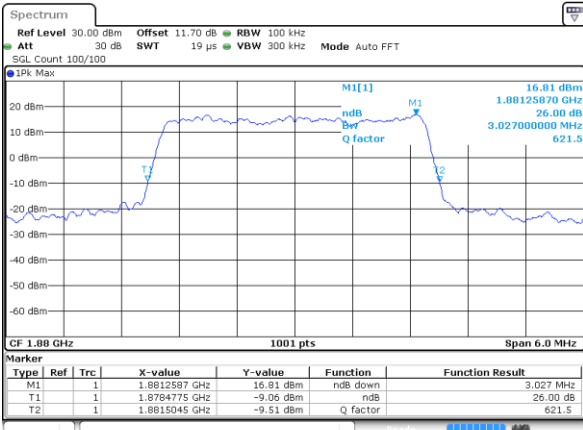

Date: 3 JAN 2018 15:18:54

Middle Channel / 3MHz / 16QAM

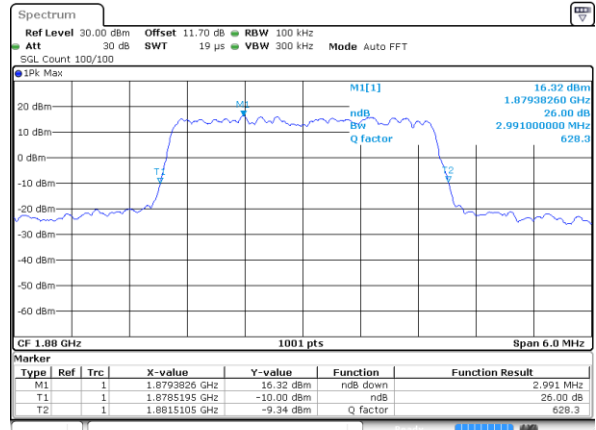

Date: 3 JAN 2018 15:19:04

Highest Channel / 3MHz / QPSK

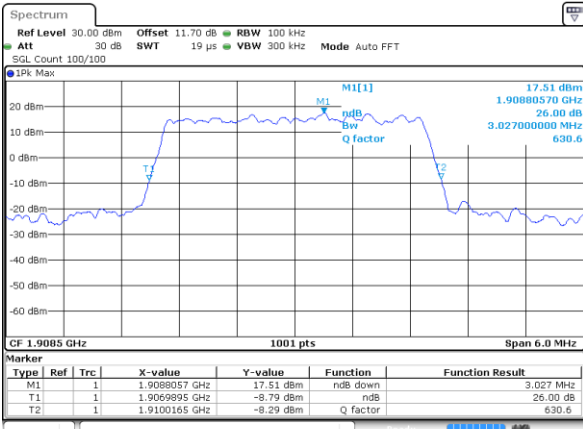

Date: 3 JAN 2018 15:21:22

Highest Channel / 3MHz / 16QAM

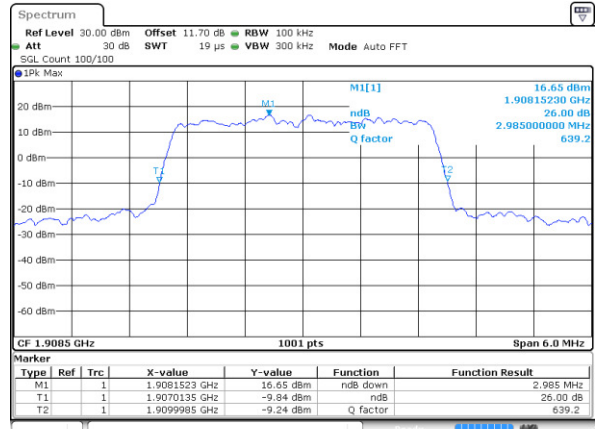

Date: 3 JAN 2018 15:21:32



LTE Band 2

Lowest Channel / 5MHz / QPSK

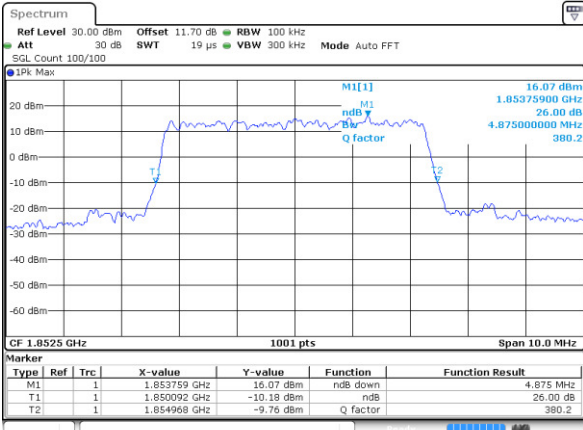

Date: 3 JAN 2018 15:28:26

Lowest Channel / 5MHz / 16QAM

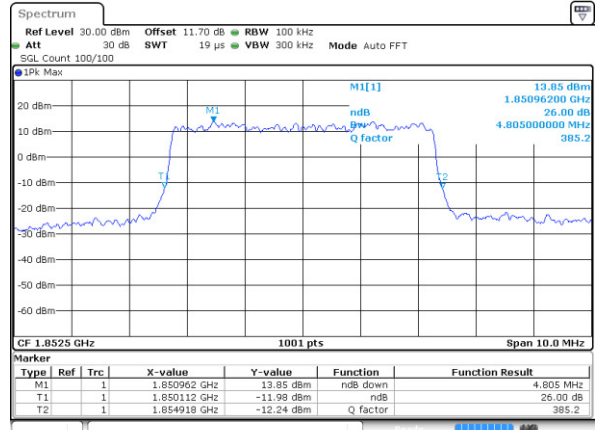

Date: 3 JAN 2018 15:28:36

Middle Channel / 5MHz / QPSK

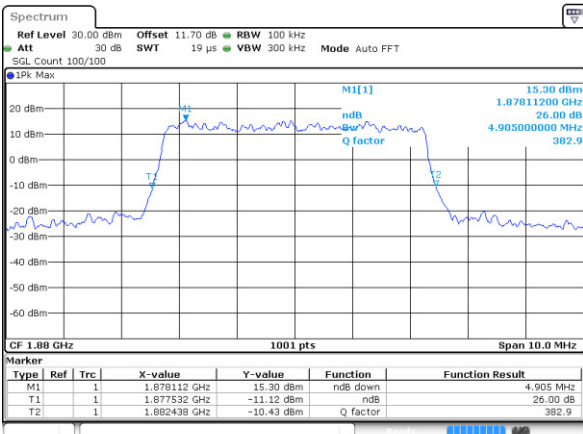

Date: 3 JAN 2018 15:35:29

Middle Channel / 5MHz / 16QAM

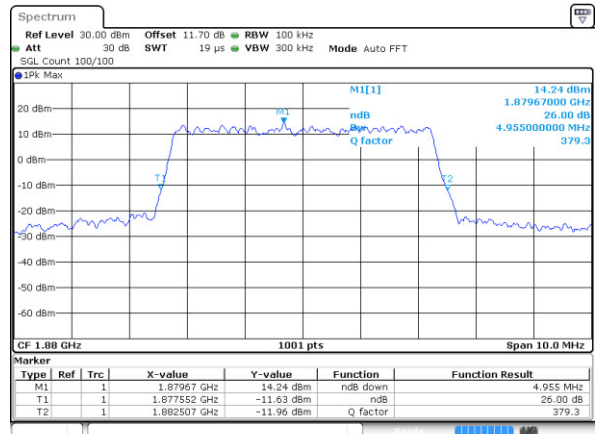

Date: 3 JAN 2018 15:35:39

Highest Channel / 5MHz / QPSK

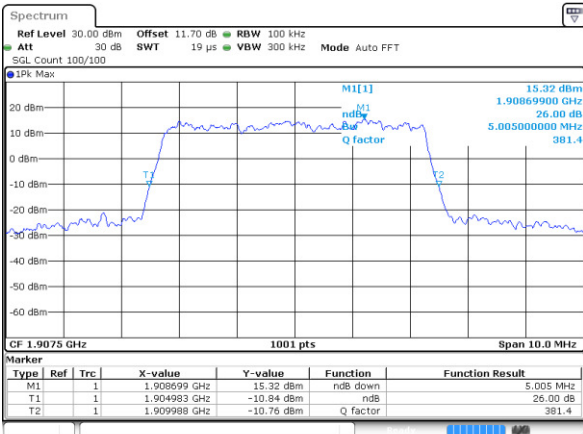

Date: 3 JAN 2018 15:37:57

Highest Channel / 5MHz / 16QAM

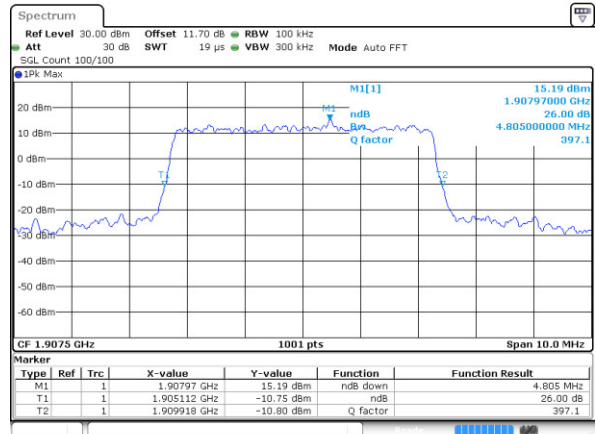

Date: 3 JAN 2018 15:38:07



LTE Band 2

Lowest Channel / 10MHz / QPSK

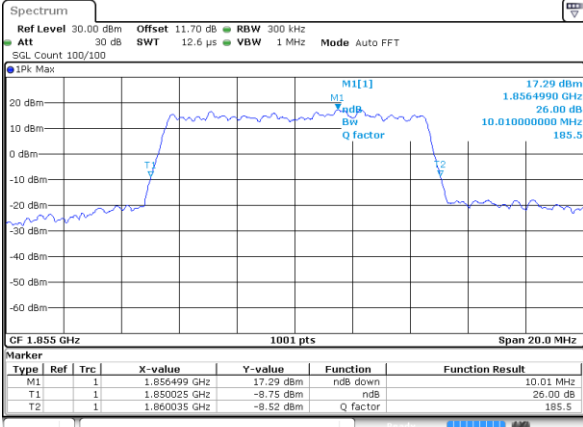

Date: 3 JAN 2018 15:57:29

Lowest Channel / 10MHz / 16QAM

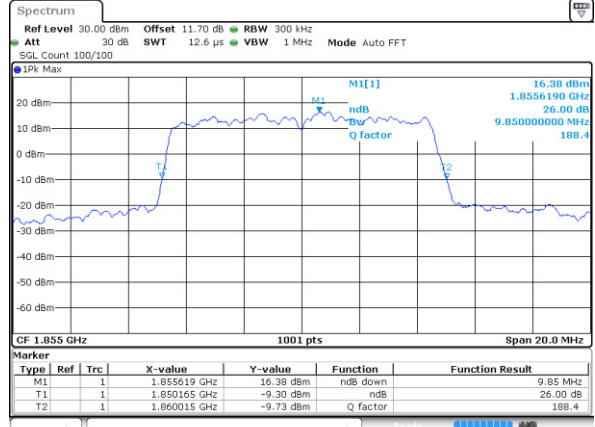

Date: 3 JAN 2018 15:57:39

Middle Channel / 10MHz / QPSK

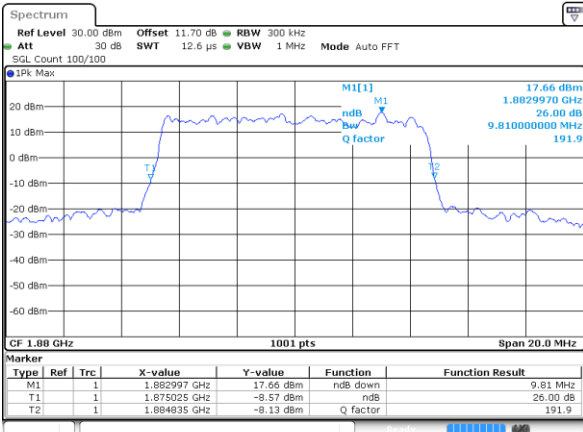

Date: 3 JAN 2018 16:04:32

Middle Channel / 10MHz / 16QAM

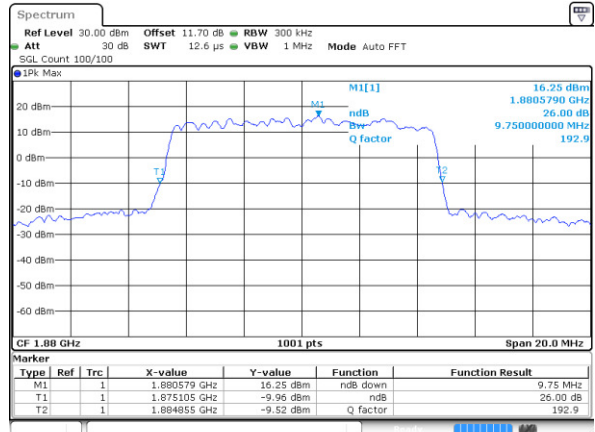

Date: 3 JAN 2018 16:04:42

Highest Channel / 10MHz / QPSK

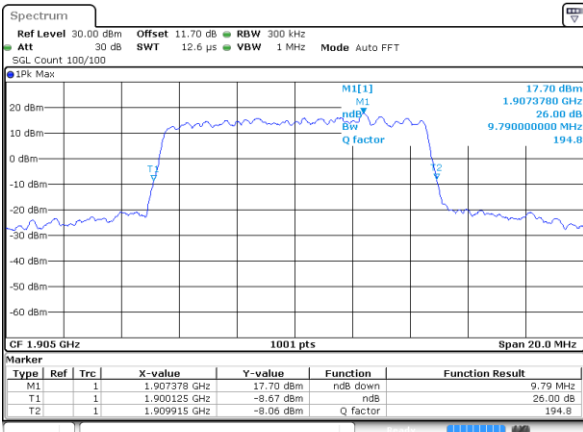

Date: 3 JAN 2018 16:07:00

Highest Channel / 10MHz / 16QAM

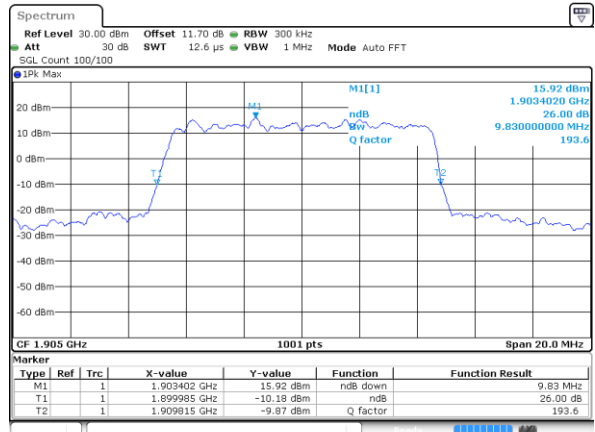

Date: 3 JAN 2018 16:07:10



LTE Band 2

Lowest Channel / 15MHz / QPSK

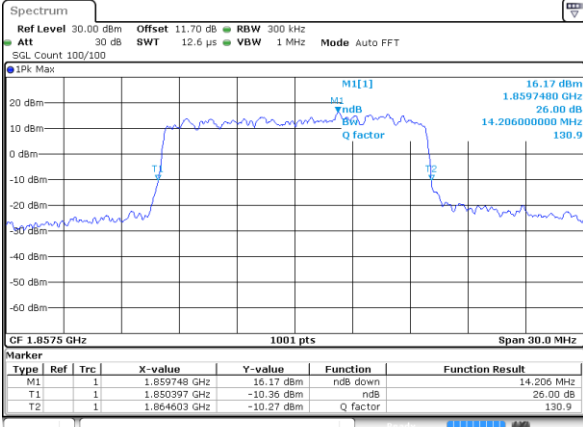

Date: 3 JAN 2018 16:14:03

Lowest Channel / 15MHz / 16QAM

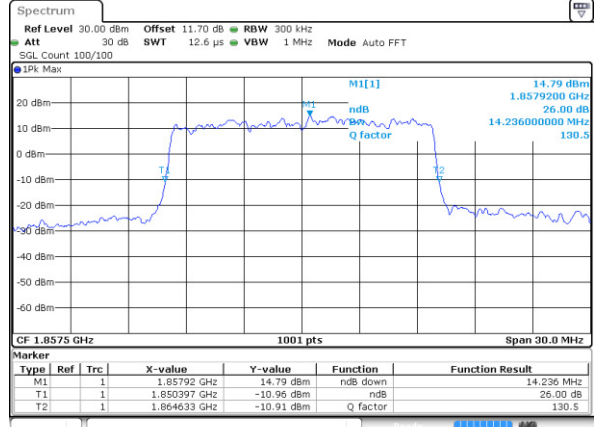

Date: 3 JAN 2018 16:14:13

Middle Channel / 15MHz / QPSK

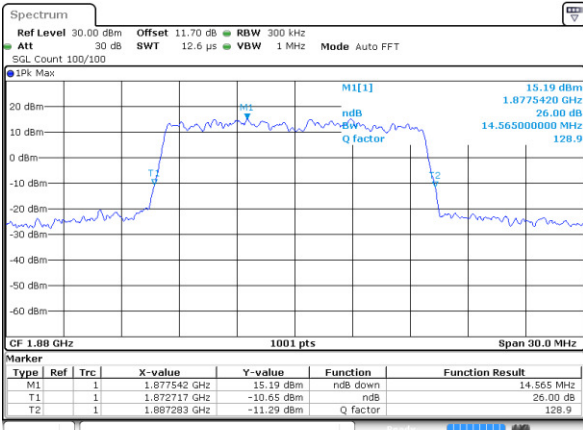

Date: 3 JAN 2018 16:21:06

Middle Channel / 15MHz / 16QAM

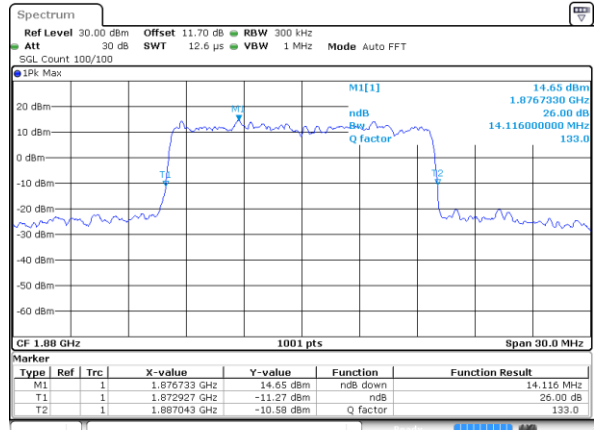

Date: 3 JAN 2018 16:21:16

Highest Channel / 15MHz / QPSK

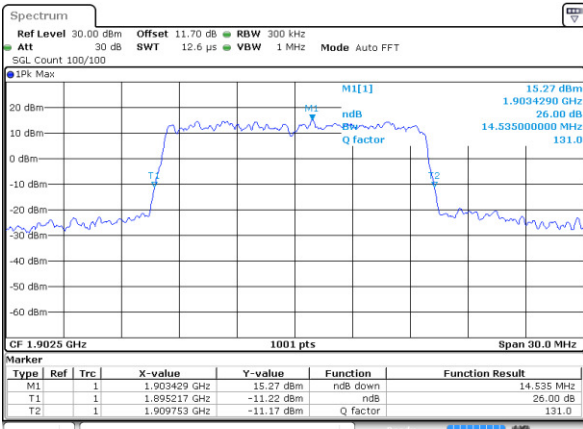

Date: 3 JAN 2018 16:23:34

Highest Channel / 15MHz / 16QAM

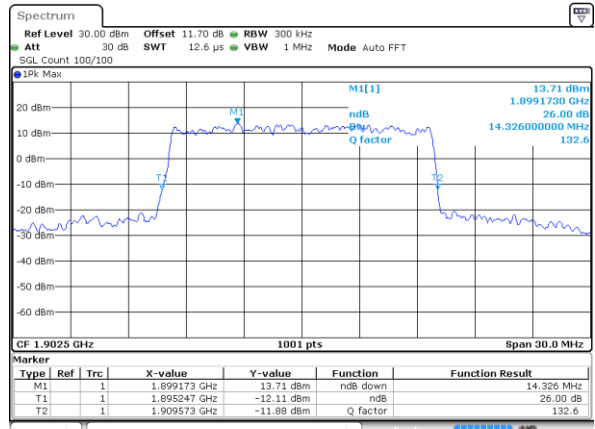

Date: 3 JAN 2018 16:23:44



LTE Band 2

Lowest Channel / 20MHz / QPSK

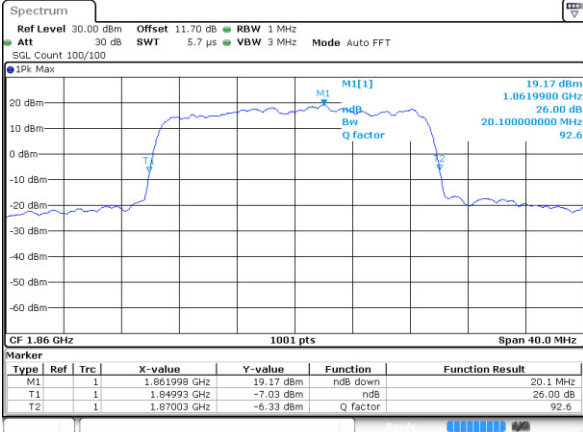

Date: 3 JAN 2018 16:30:37

Lowest Channel / 20MHz / 16QAM

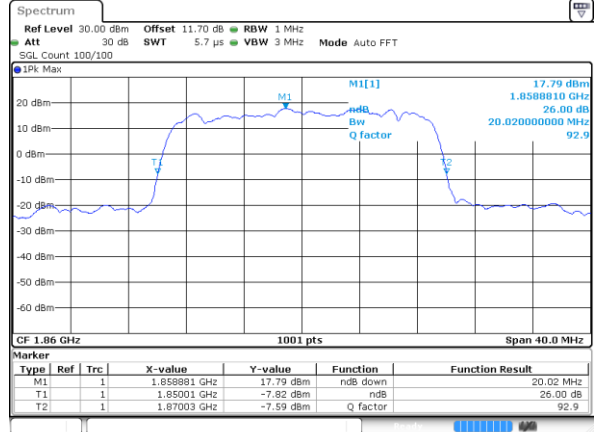

Date: 3 JAN 2018 16:30:47

Middle Channel / 20MHz / QPSK

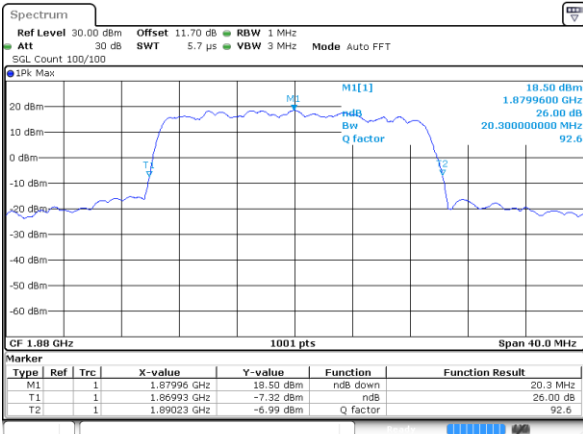

Date: 3 JAN 2018 16:37:39

Middle Channel / 20MHz / 16QAM

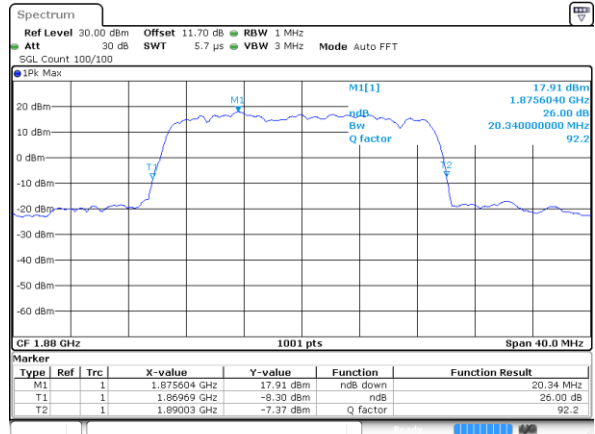

Date: 3 JAN 2018 16:37:49

Highest Channel / 20MHz / QPSK

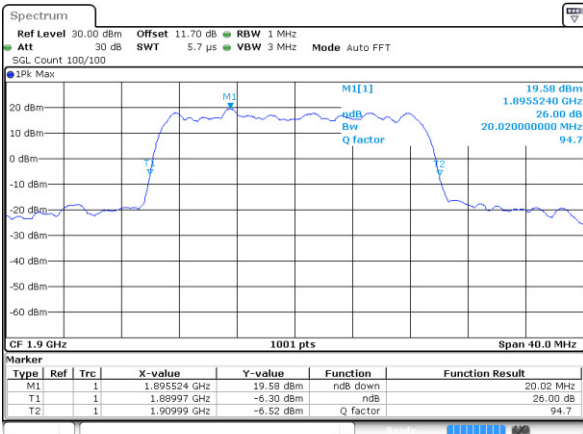

Date: 3 JAN 2018 16:40:08

Highest Channel / 20MHz / 16QAM

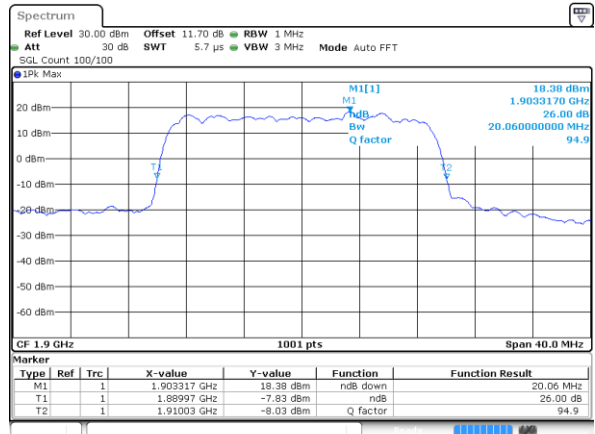

Date: 3 JAN 2018 16:40:18



Occupied Bandwidth

Mode	LTE Band 2 : 99%OBW(MHz)											
	1.4MHz		3MHz		5MHz		10MHz		15MHz		20MHz	
BW												
Mod.	QPSK	16QAM	QPSK	16QAM	QPSK	16QAM	QPSK	16QAM	QPSK	16QAM	QPSK	16QAM
Lowest CH	1.1	1.09	2.72	2.72	4.5	4.5	9.13	8.99	13.4	13.49	18.18	18.18
Middle CH	1.09	1.1	2.72	2.72	4.48	4.51	8.99	9.05	13.4	13.43	18.34	18.38
Highest CH	1.09	1.1	2.71	2.72	4.49	4.48	8.97	9.03	13.43	13.43	18.46	18.34



LTE Band 2

Lowest Channel / 1.4MHz / QPSK

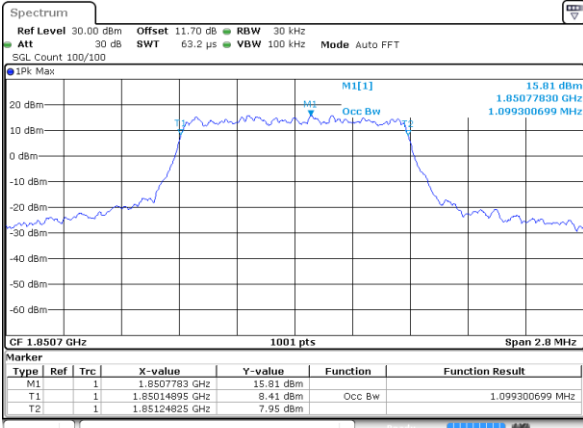

Date: 3.JAN.2018 16:47:31

Lowest Channel / 1.4MHz / 16QAM

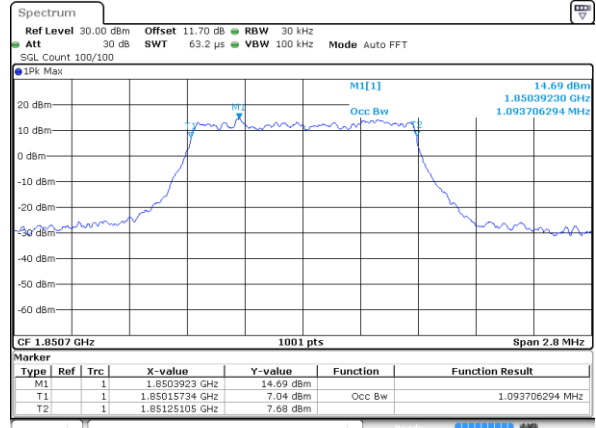

Date: 3.JAN.2018 16:47:41

Middle Channel / 1.4MHz / QPSK

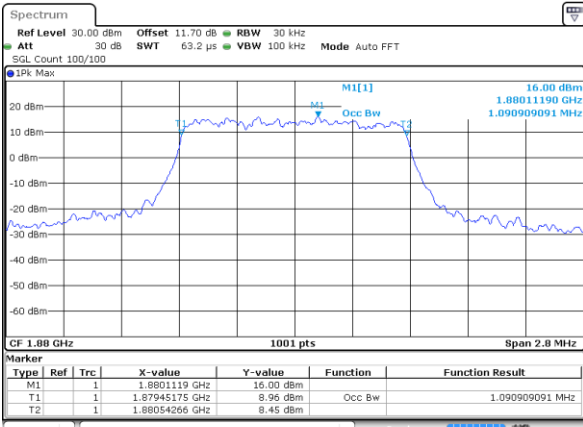

Date: 3.JAN.2018 16:54:34

Middle Channel / 1.4MHz / 16QAM

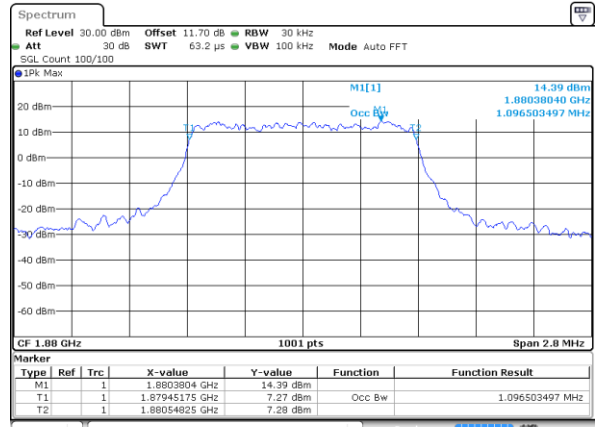

Date: 3.JAN.2018 16:54:44

Highest Channel / 1.4MHz / QPSK

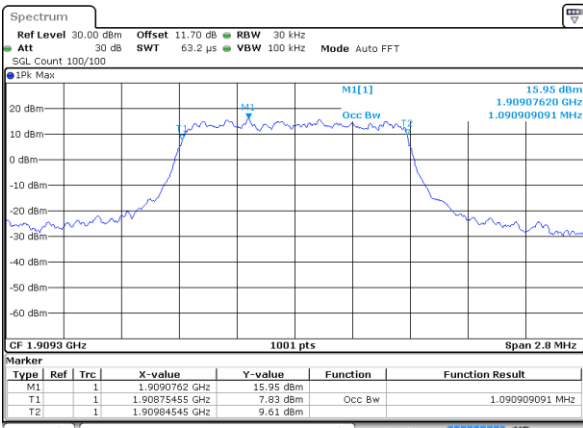

Date: 3.JAN.2018 16:57:02

Highest Channel / 1.4MHz / 16QAM

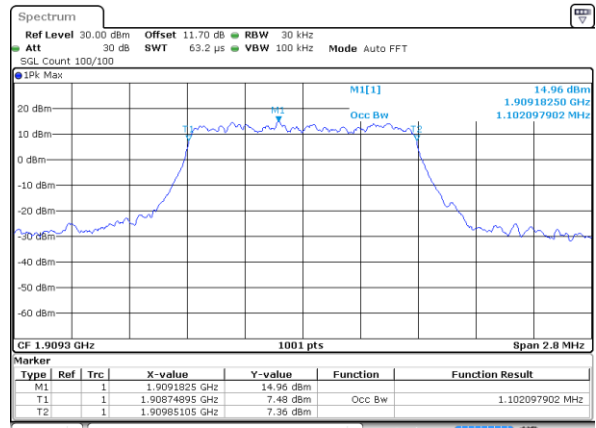

Date: 3.JAN.2018 16:57:12



LTE Band 2

Lowest Channel / 3MHz / QPSK

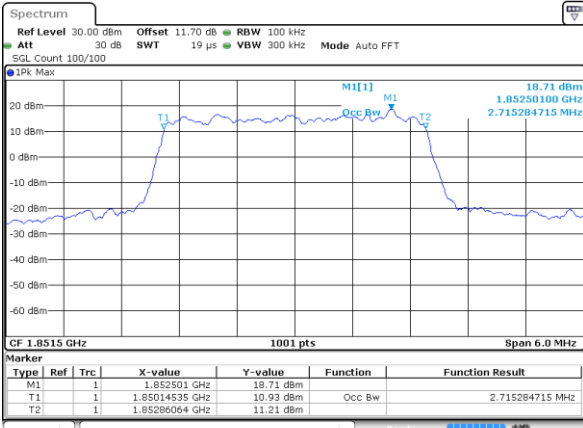

Date: 3.JAN.2018 15:11:30

Lowest Channel / 3MHz / 16QAM

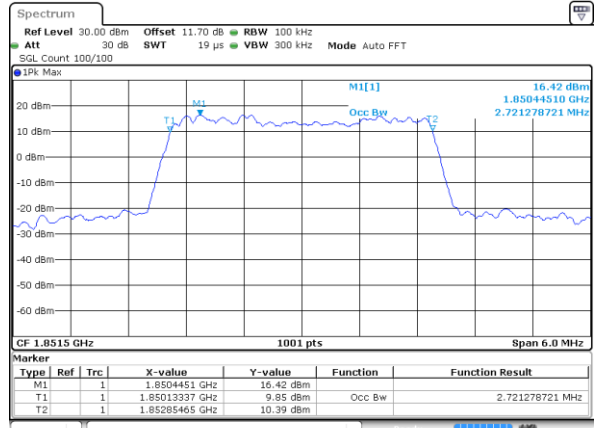

Date: 3.JAN.2018 15:11:40

Middle Channel / 3MHz / QPSK

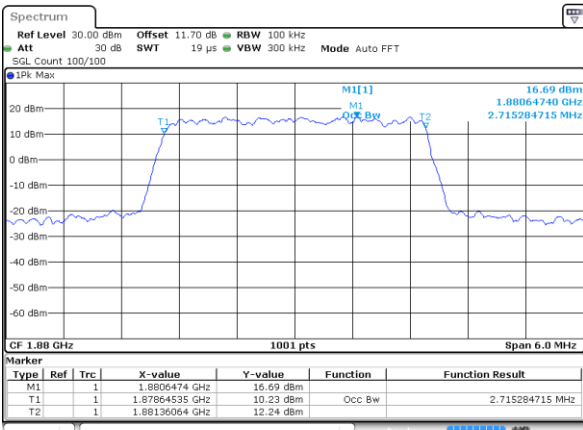

Date: 3.JAN.2018 15:18:34

Middle Channel / 3MHz / 16QAM

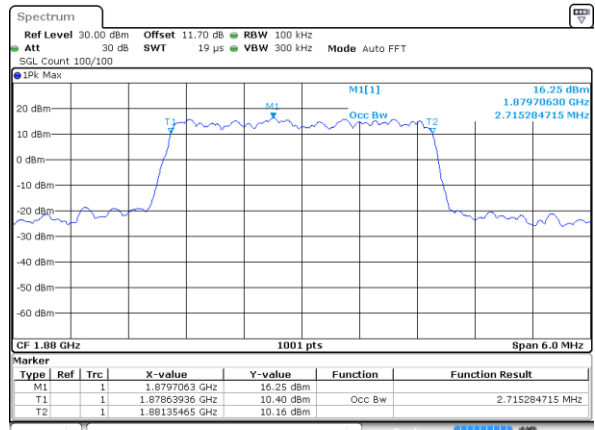

Date: 3.JAN.2018 15:18:44

Highest Channel / 3MHz / QPSK

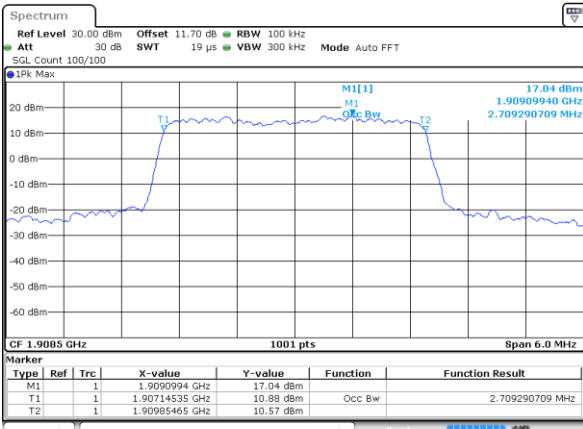

Date: 3.JAN.2018 15:21:02

Highest Channel / 3MHz / 16QAM

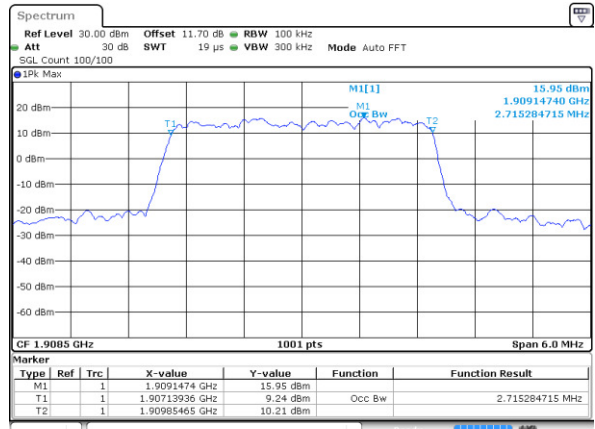

Date: 3.JAN.2018 15:21:12



LTE Band 2

Lowest Channel / 5MHz / QPSK

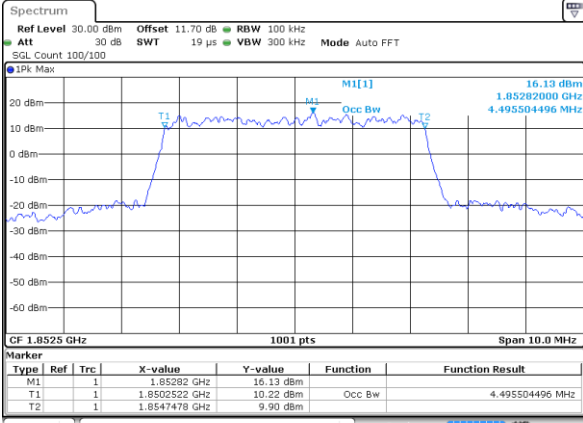

Date: 3 JAN 2018 15:28:06

Lowest Channel / 5MHz / 16QAM

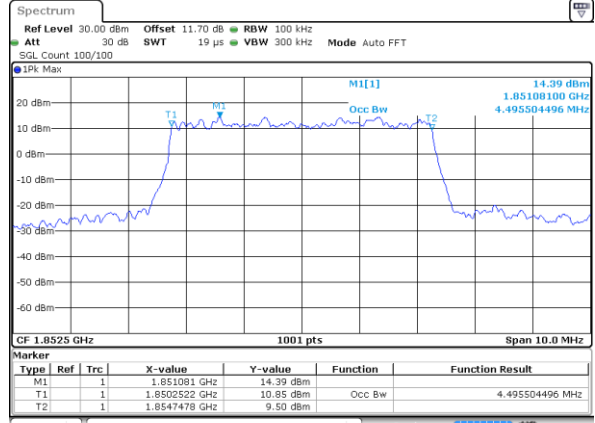

Date: 3 JAN 2018 15:28:16

Middle Channel / 5MHz / QPSK

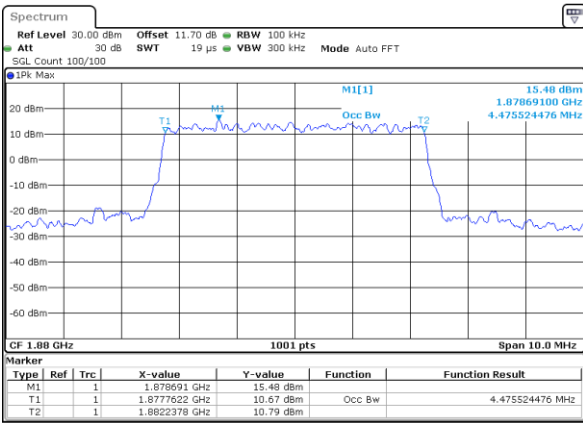

Date: 3 JAN 2018 15:35:09

Middle Channel / 5MHz / 16QAM

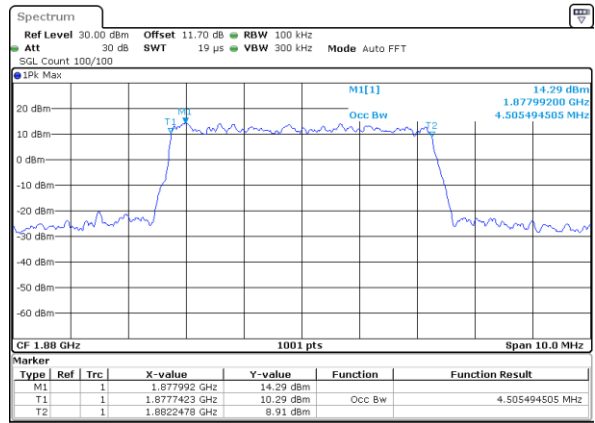

Date: 3 JAN 2018 15:35:19

Highest Channel / 5MHz / QPSK

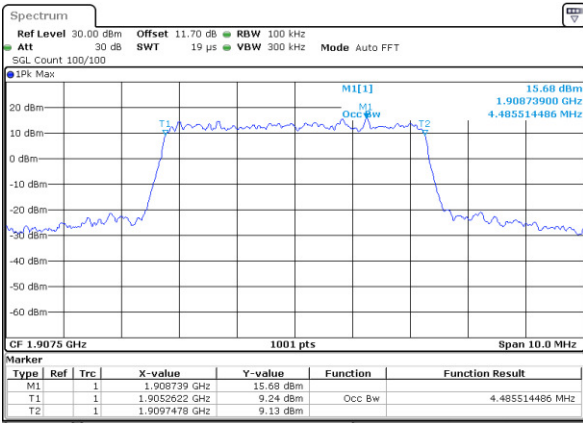

Date: 3 JAN 2018 15:37:37

Highest Channel / 5MHz / 16QAM

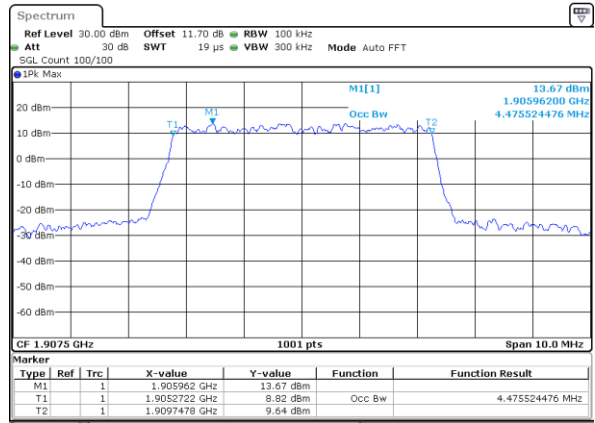

Date: 3 JAN 2018 15:37:47



LTE Band 2

Lowest Channel / 10MHz / QPSK

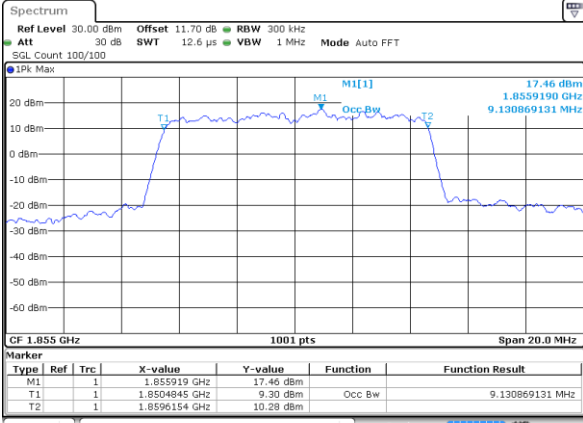

Date: 3 JAN 2018 15:57:09

Lowest Channel / 10MHz / 16QAM

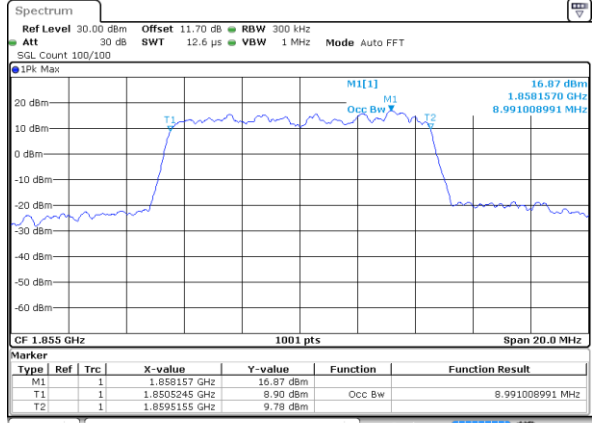

Date: 3 JAN 2018 15:57:19

Middle Channel / 10MHz / QPSK

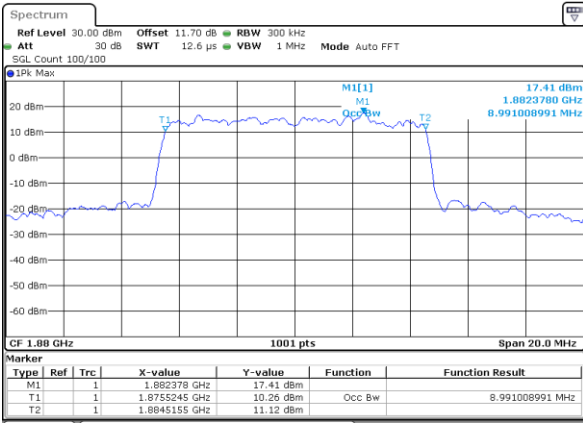

Date: 3 JAN 2018 16:04:12

Middle Channel / 10MHz / 16QAM

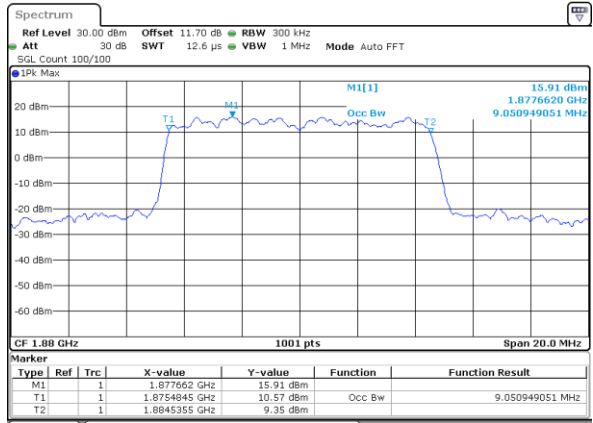

Date: 3 JAN 2018 16:04:22

Highest Channel / 10MHz / QPSK

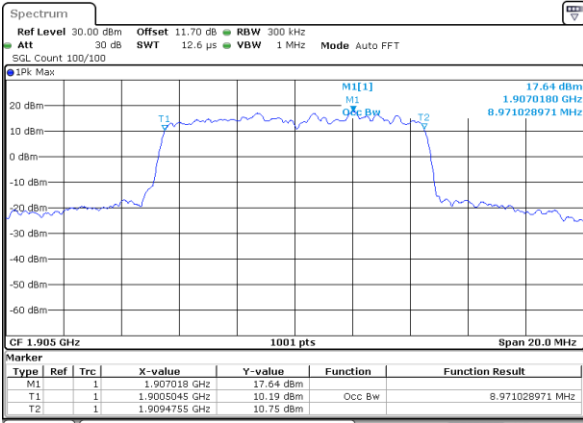

Date: 3 JAN 2018 16:06:40

Highest Channel / 10MHz / 16QAM

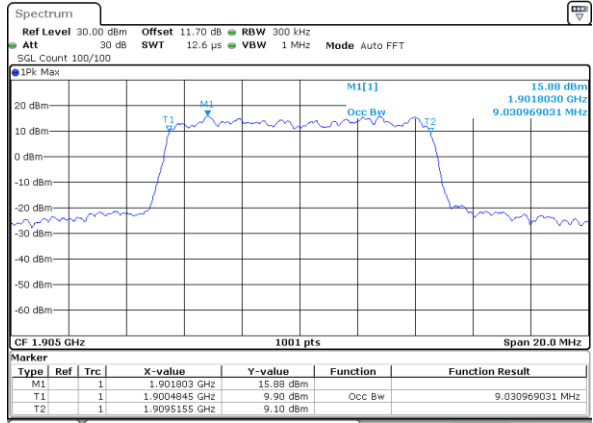

Date: 3 JAN 2018 16:06:50



LTE Band 2

Lowest Channel / 15MHz / QPSK

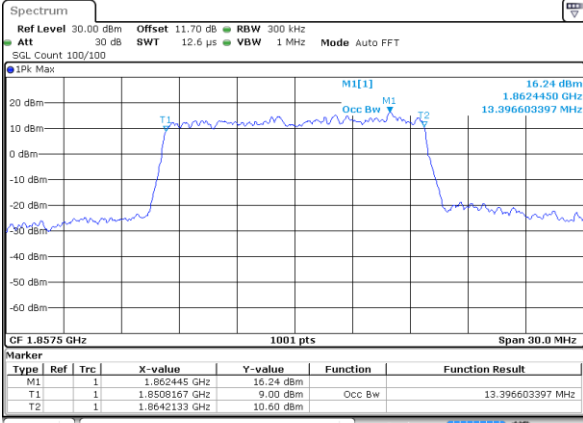

Date: 3 JAN 2018 16:13:43

Lowest Channel / 15MHz / 16QAM

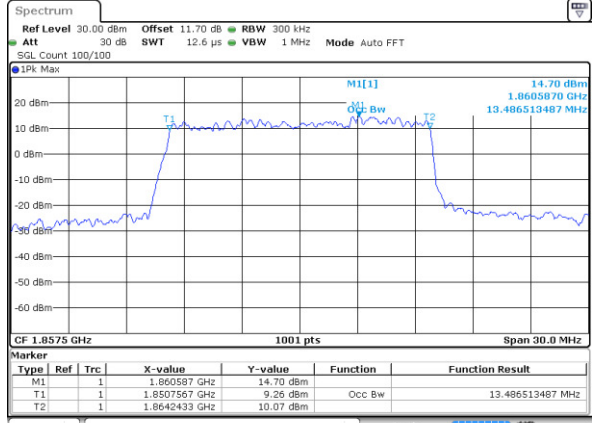

Date: 3 JAN 2018 16:13:53

Middle Channel / 15MHz / QPSK

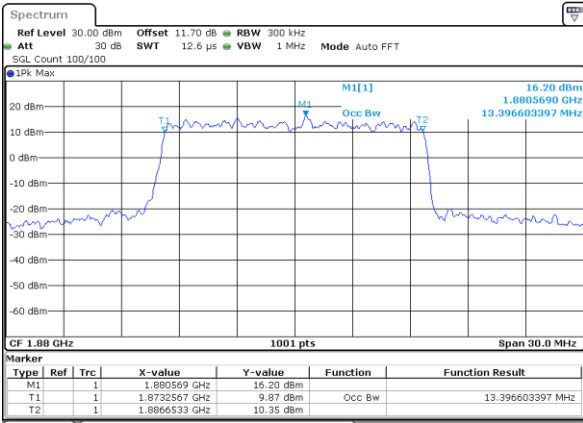

Date: 3 JAN 2018 16:20:46

Middle Channel / 15MHz / 16QAM

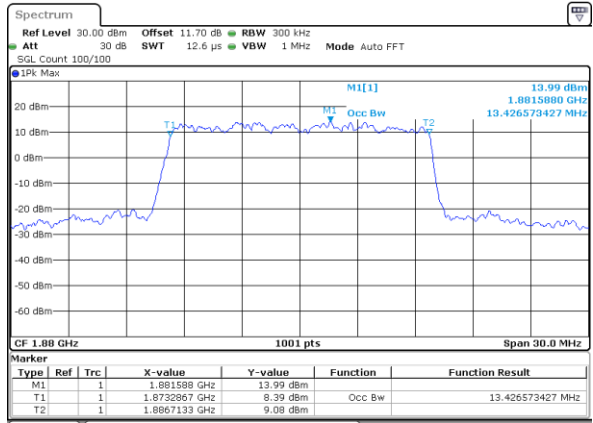

Date: 3 JAN 2018 16:20:56

Highest Channel / 15MHz / QPSK

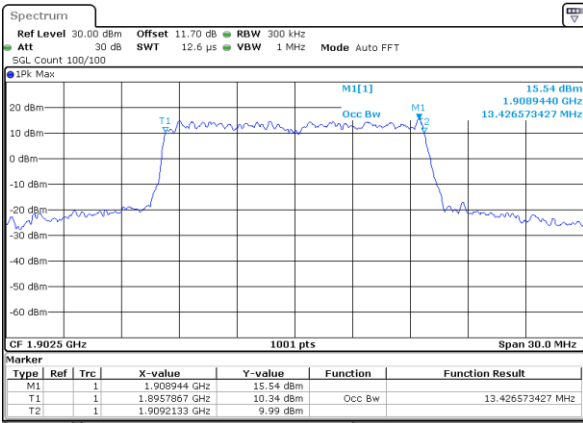

Date: 3 JAN 2018 16:23:14

Highest Channel / 15MHz / 16QAM

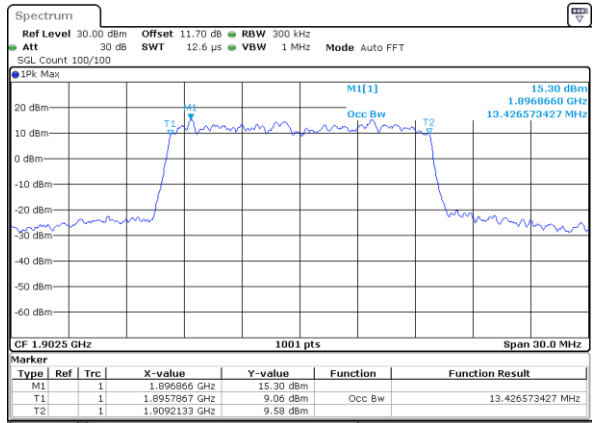

Date: 3 JAN 2018 16:23:24



LTE Band 2

Lowest Channel / 20MHz / QPSK

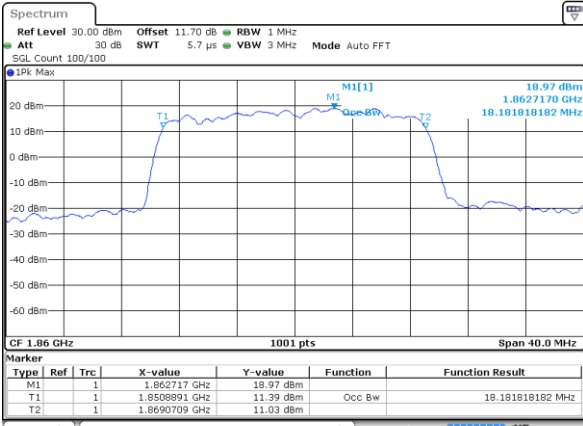

Date: 3 JAN 2018 16:30:17

Lowest Channel / 20MHz / 16QAM

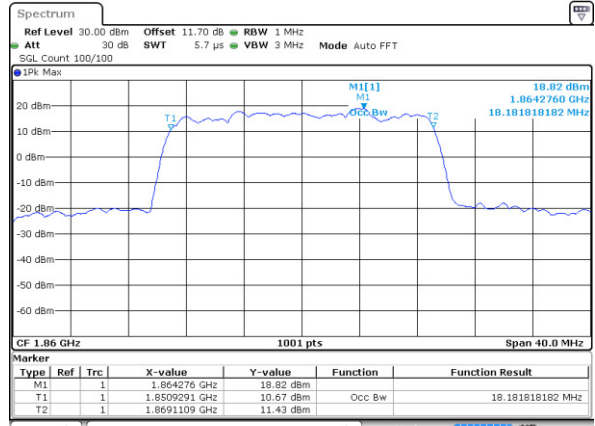

Date: 3 JAN 2018 16:30:27

Middle Channel / 20MHz / QPSK

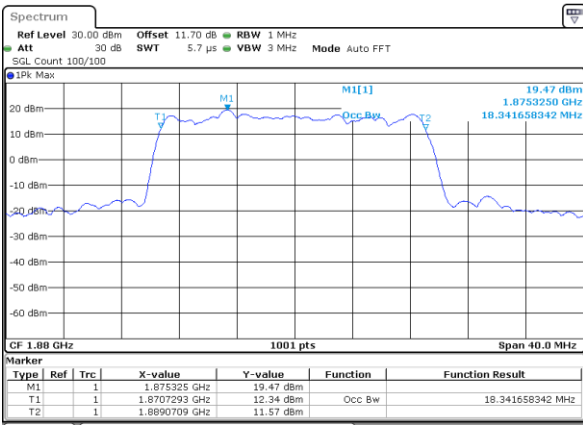

Date: 3 JAN 2018 16:37:19

Middle Channel / 20MHz / 16QAM

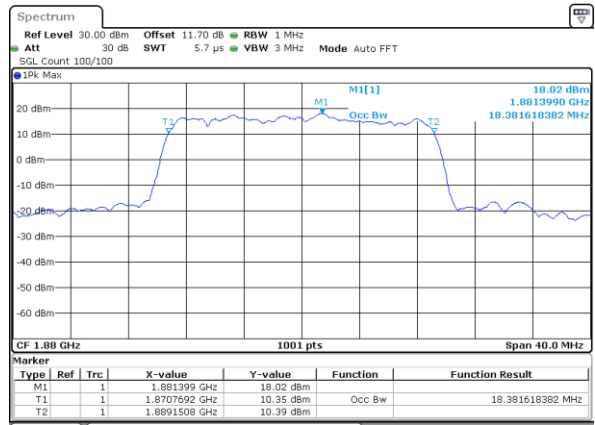

Date: 3 JAN 2018 16:37:30

Highest Channel / 20MHz / QPSK

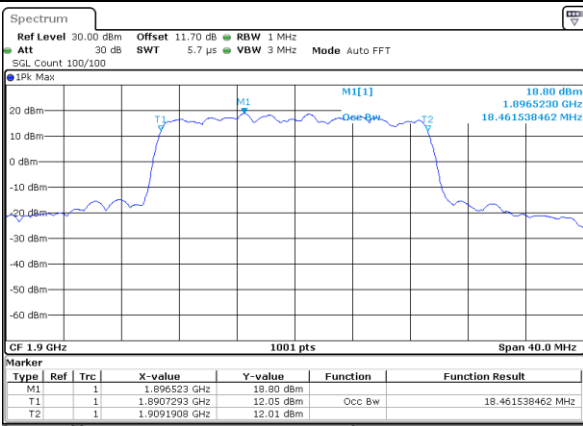

Date: 3 JAN 2018 16:39:47

Highest Channel / 20MHz / 16QAM

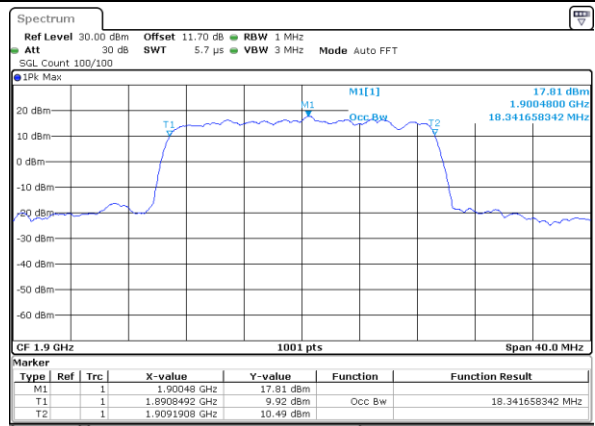

Date: 3 JAN 2018 16:39:58



Conducted Band Edge



LTE Band 2 / 1.4MHz / QPSK

Lowest Band Edge / 1RB

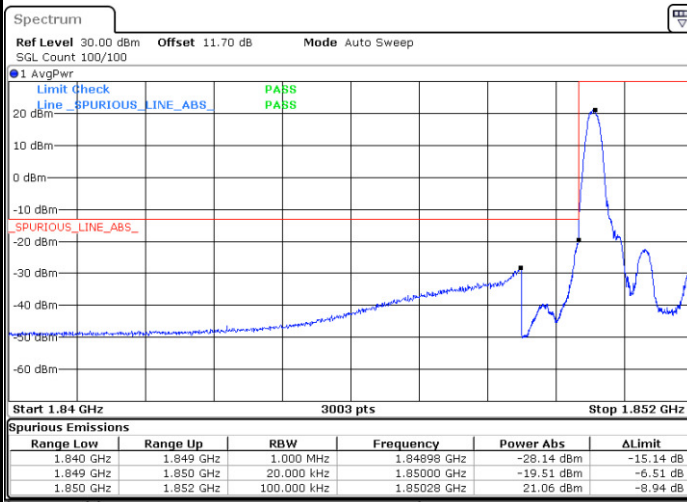

Date: 3 JAN 2018 16:49:10

Highest Band Edge / 1RB

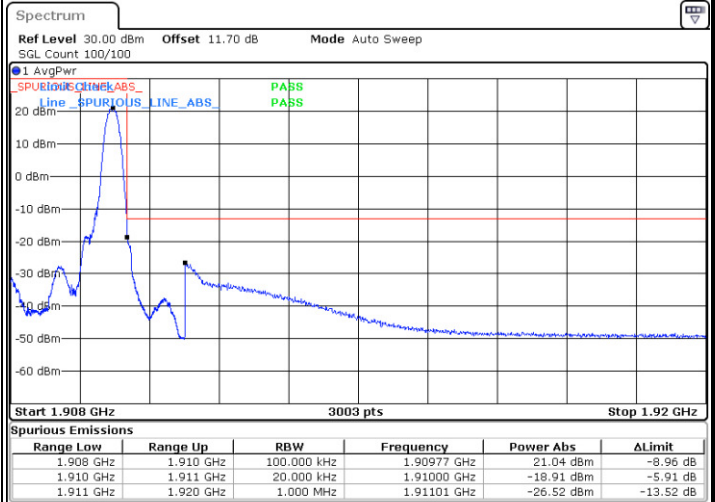

Date: 3 JAN 2018 16:58:41

Lowest Band Edge / Full RB

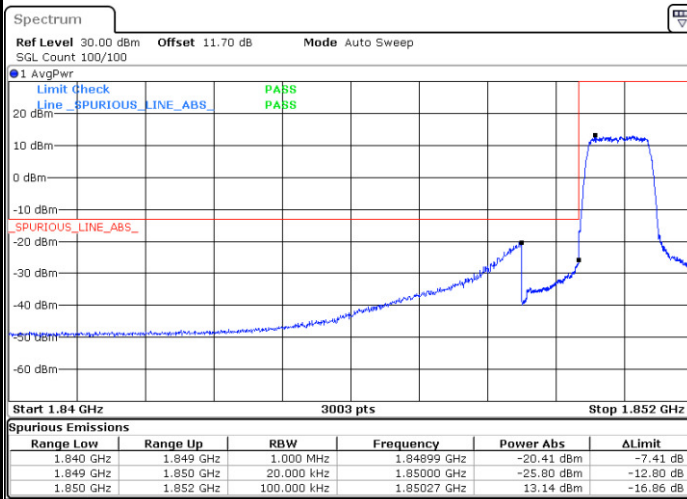

Date: 3 JAN 2018 16:51:27

Highest Band Edge / Full RB

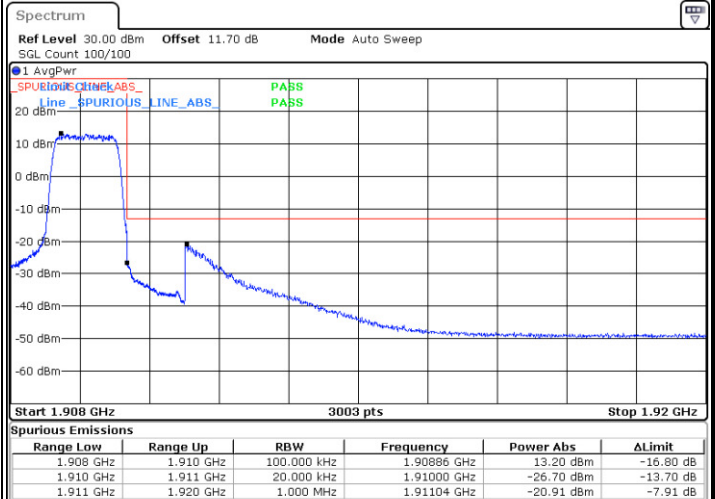

Date: 3 JAN 2018 17:00:58



LTE Band 2 / 1.4MHz / 16QAM

Lowest Band Edge / 1 RB

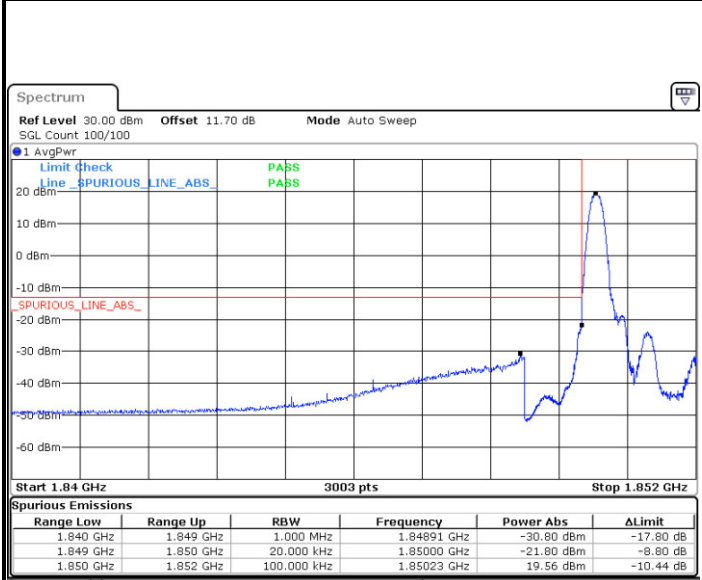

Date: 3. JAN 2018 16:50:18

Highest Band Edge / 1 RB

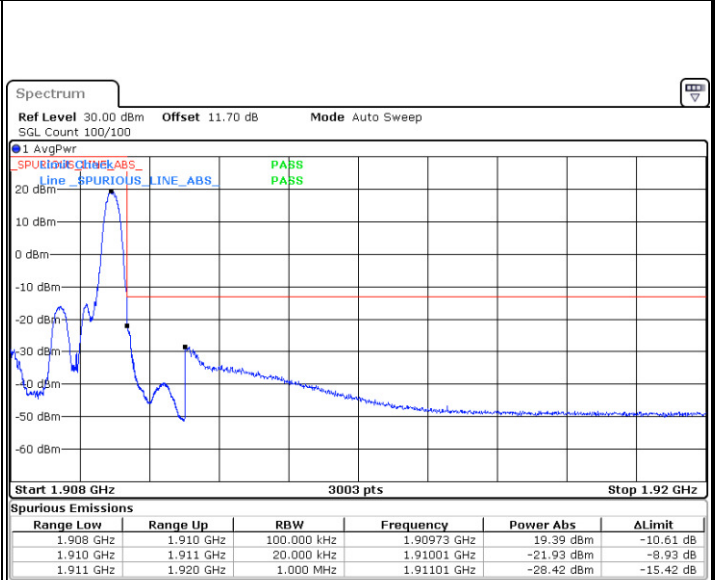

Date: 3. JAN 2018 16:59:49

Lowest Band Edge / Full RB

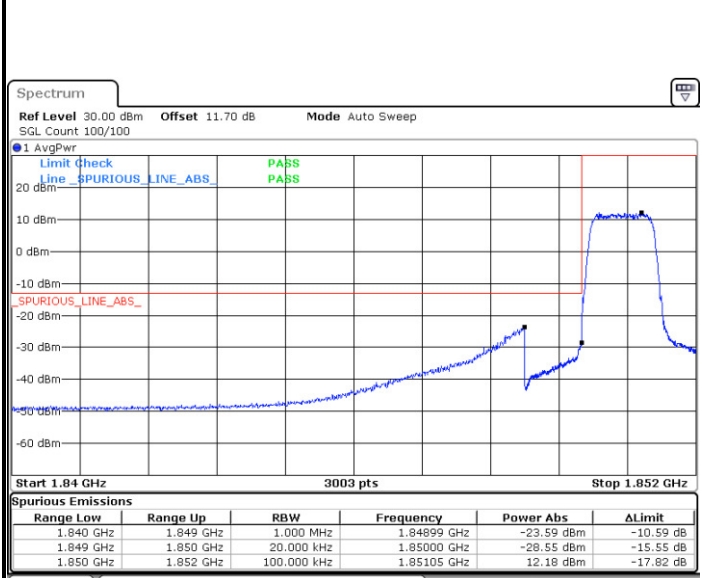

Date: 3. JAN 2018 16:52:36

Highest Band Edge / Full RB

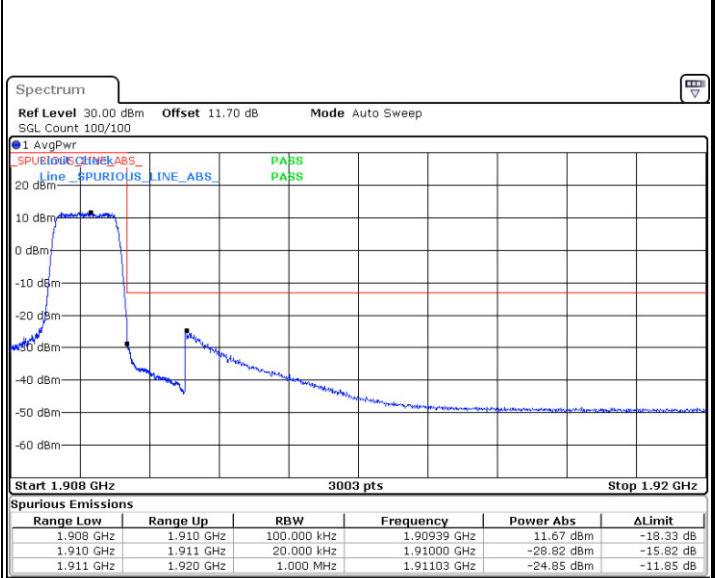

Date: 3. JAN 2018 17:02:07



LTE Band 2 / 3MHz / QPSK

Lowest Band Edge / 1RB

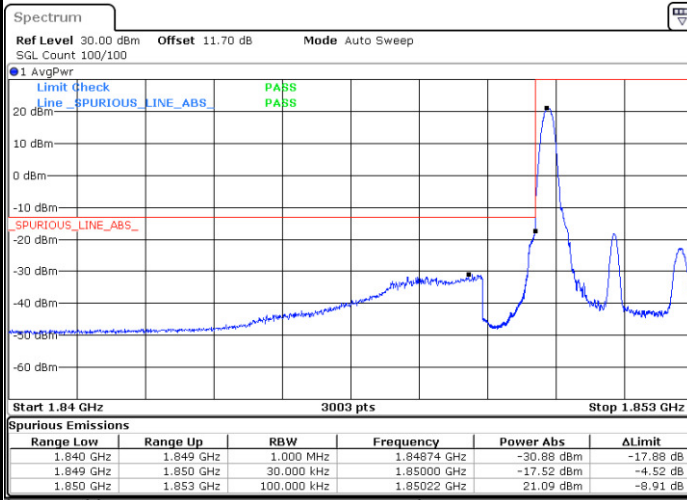

Date: 3. JAN 2018 15:13:09

Highest Band Edge / 1 RB

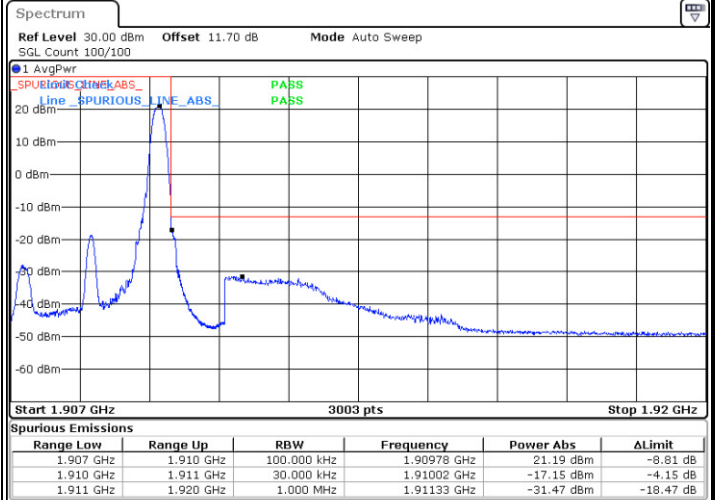

Date: 3. JAN 2018 15:22:41

Lowest Band Edge / Full RB

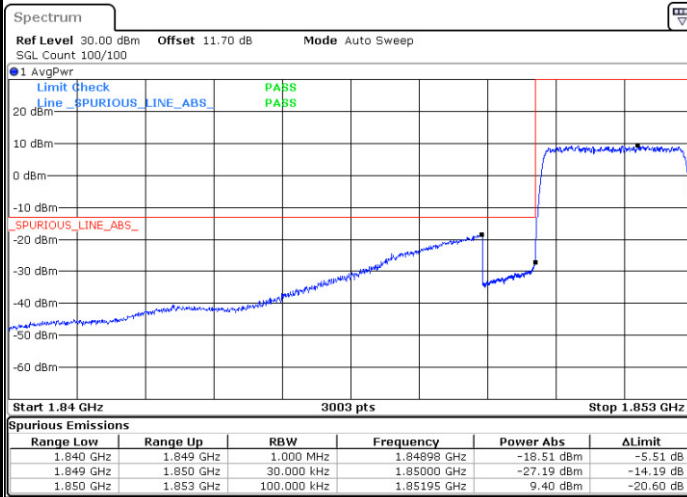

Date: 3. JAN 2018 15:15:27

Highest Band Edge / Full RB

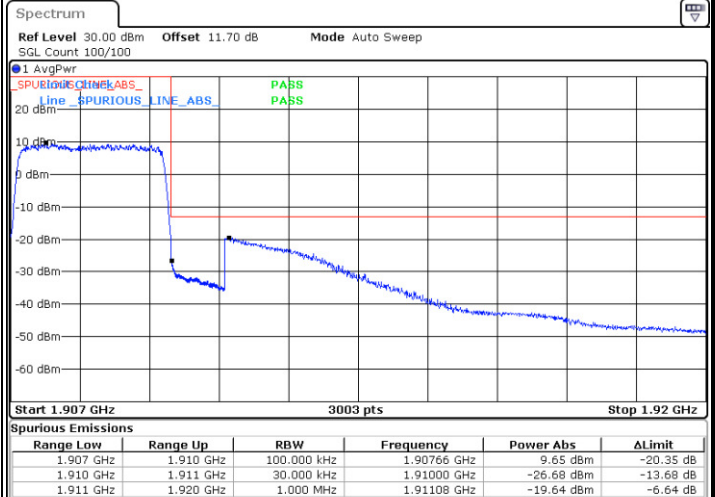

Date: 3. JAN 2018 15:24:58



LTE Band 2 / 3MHz / 16QAM

Lowest Band Edge / 1 RB

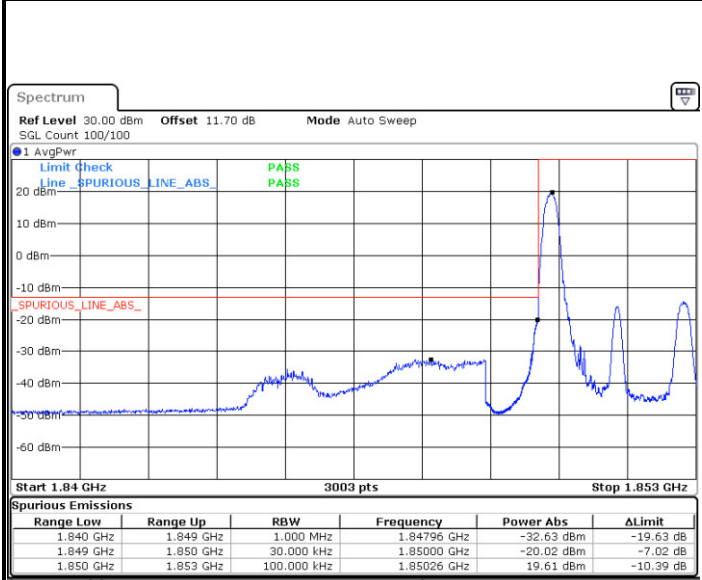

Date: 3. JAN 2018 15:14:18

Highest Band Edge / 1 RB

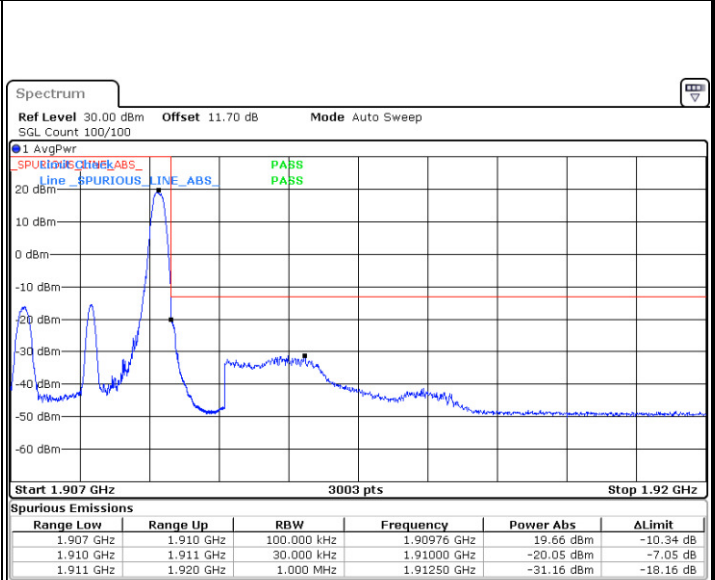

Date: 3. JAN 2018 15:23:49

Lowest Band Edge / Full RB

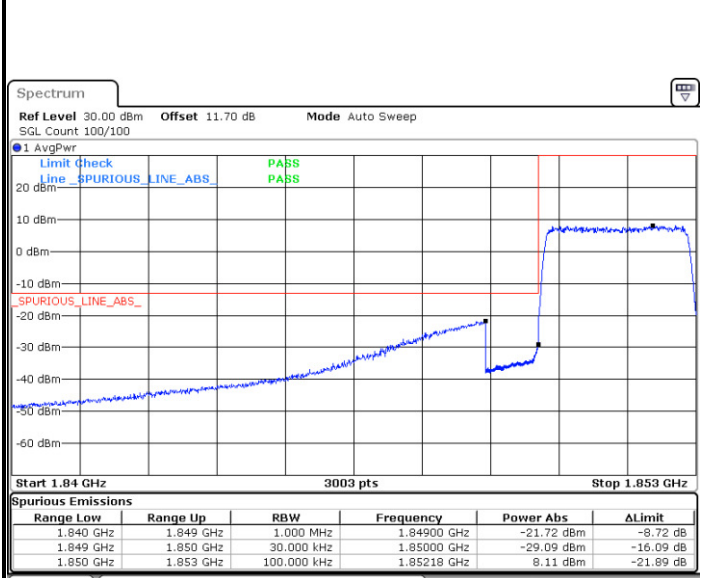

Date: 3. JAN 2018 15:16:36

Highest Band Edge / Full RB

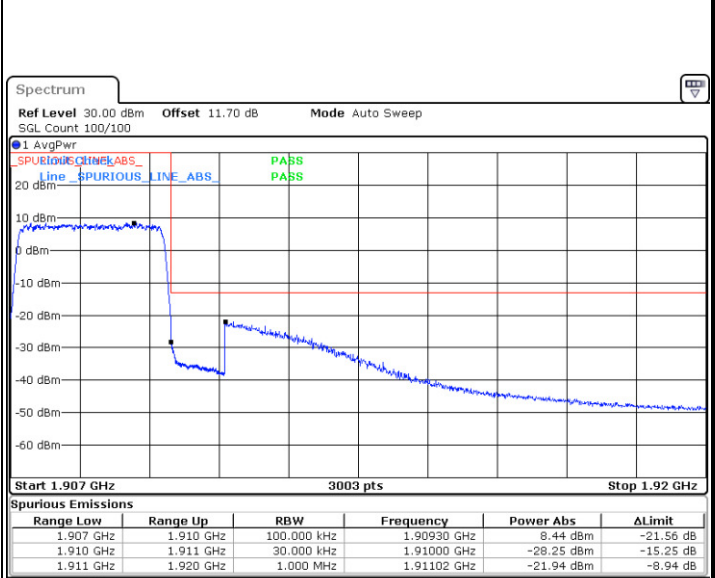

Date: 3. JAN 2018 15:26:07



LTE Band 2 / 5MHz / QPSK

Lowest Band Edge / 1 RB

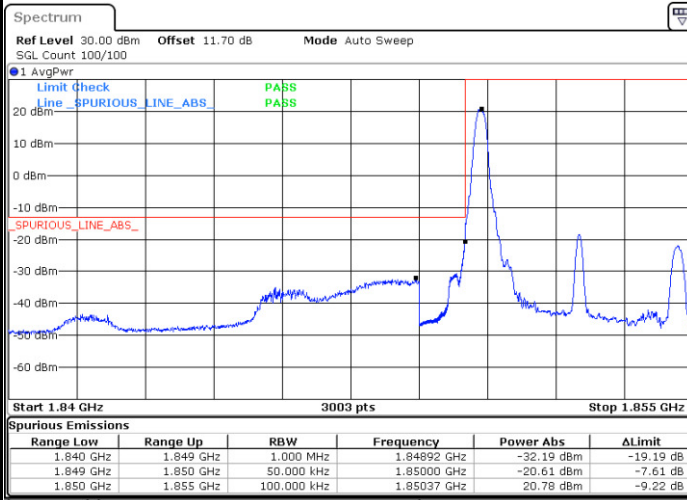

Date: 3. JAN 2018 15:29:44

Highest Band Edge / 1 RB

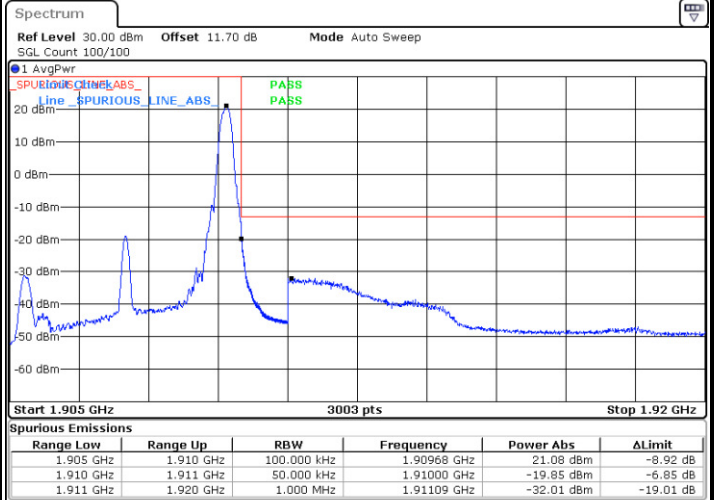

Date: 3. JAN 2018 17:29:44

Lowest Band Edge / Full RB

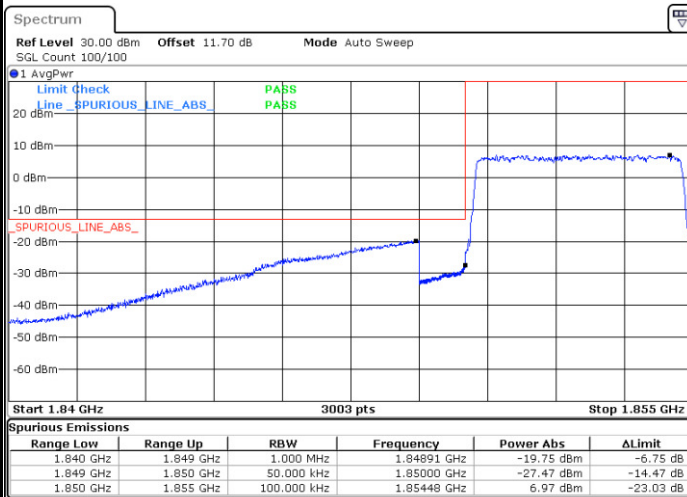

Date: 3. JAN 2018 15:32:02

Highest Band Edge / Full RB

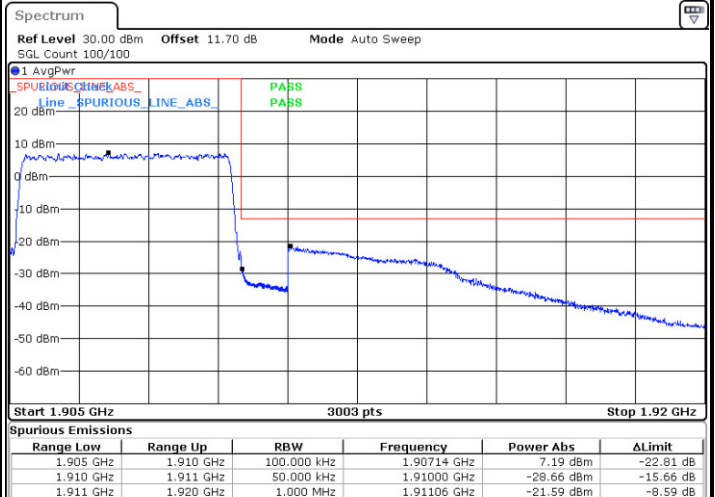

Date: 3. JAN 2018 17:32:01



LTE Band 2 / 5MHz / 16QAM

Lowest Band Edge / 1RB

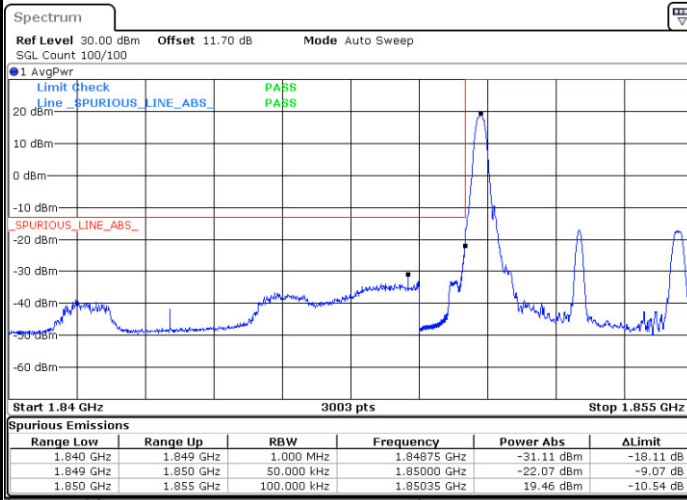

Date: 3. JAN 2018 15:30:53

Highest Band Edge / 1 RB

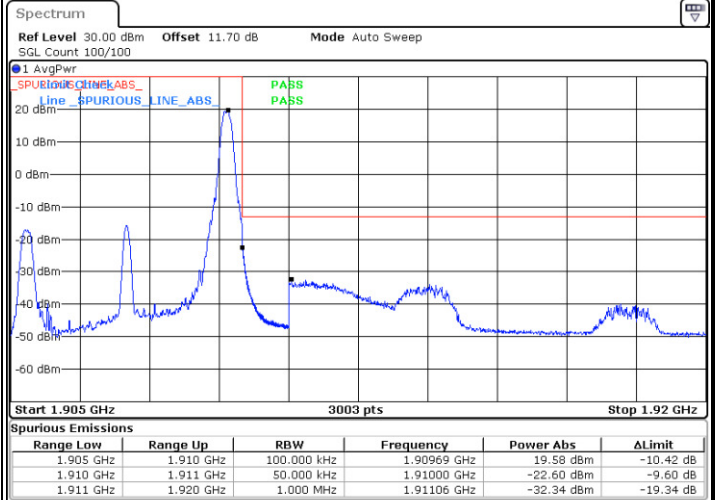

Date: 3. JAN 2018 17:30:53

Lowest Band Edge / Full RB

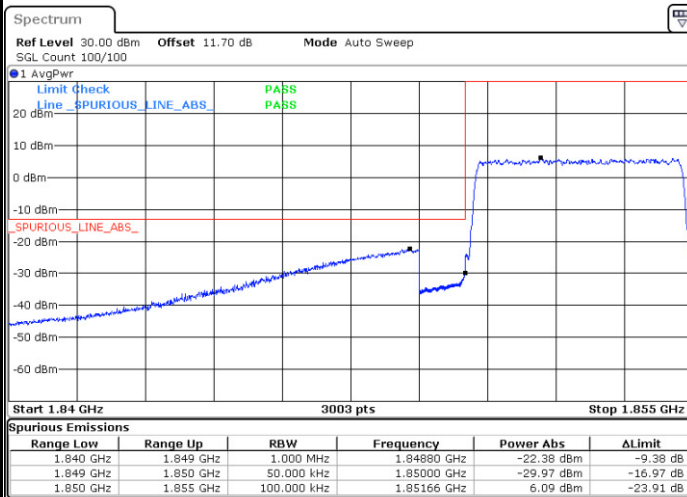

Date: 3. JAN 2018 15:33:10

Highest Band Edge / Full RB

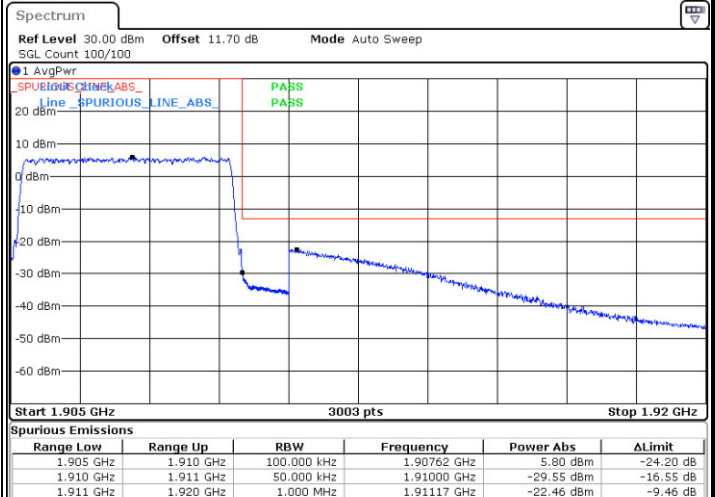

Date: 3. JAN 2018 17:33:10



LTE Band 2 / 10MHz / QPSK

Lowest Band Edge / 1 RB

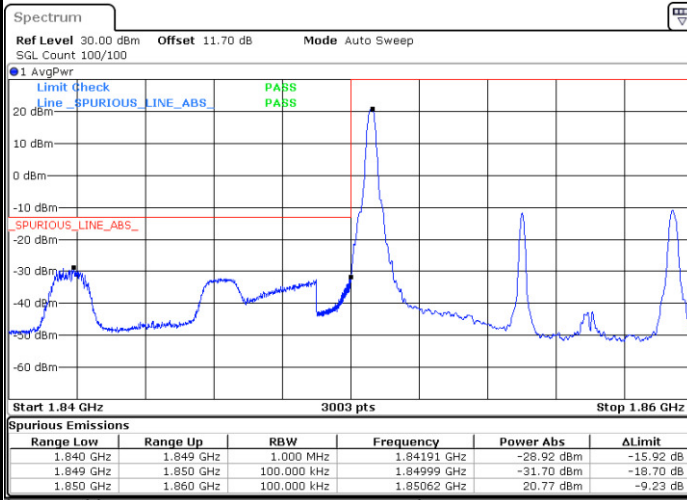

Date: 3. JAN 2018 15:58:47

Highest Band Edge / 1 RB

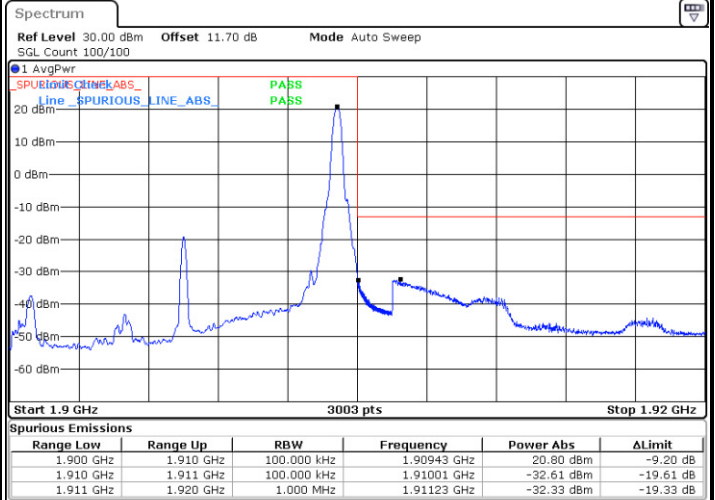

Date: 3. JAN 2018 16:08:18

Lowest Band Edge / Full RB

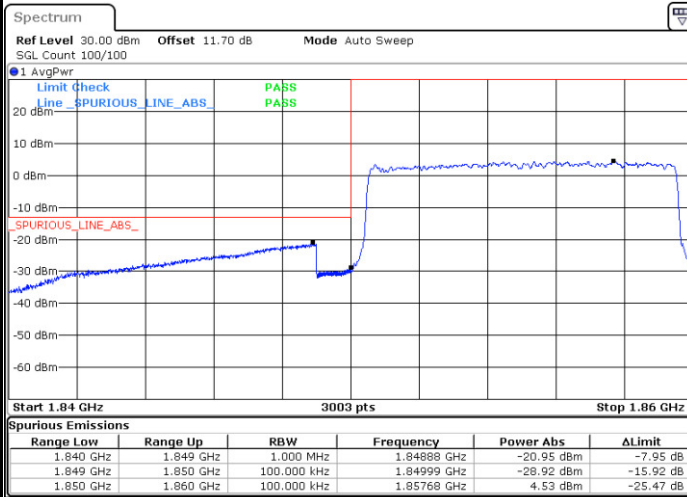

Date: 3. JAN 2018 16:01:05

Highest Band Edge / Full RB

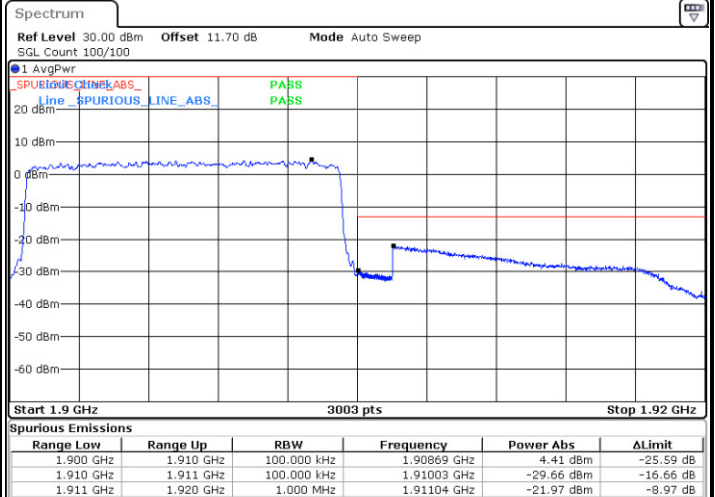

Date: 3. JAN 2018 16:10:36