



FCC RF Test Report

APPLICANT : Motorola Mobility LLC
EQUIPMENT : Mobile Cellular Phone
BRAND NAME : Motorola
MODEL NAME : XT1924-4, XT1924-5
FCC ID : IHDT56XA5
STANDARD : FCC Part 15 Subpart C §15.247
CLASSIFICATION : (DSS) Spread Spectrum Transmitter

The product was received on Dec. 22, 2017 and testing was completed on Jan. 02, 2018. We, Sporton International (Kunshan) Inc., would like to declare that the tested sample has been evaluated in accordance with the test procedures and has been in compliance with the applicable technical standards.

This report contains data that were produced under subcontract by Laboratory SPORTON INTERNATIONAL INC.

The test results in this report apply exclusively to the tested model / sample. Without written approval of Sporton International (Kunshan) Inc., the test report shall not be reproduced except in full.



Approved by: James Huang / Manager

Sporton International (Kunshan) Inc.

No.3-2 Ping-Xiang Rd, Kunshan Development Zone Kunshan City Jiangsu Province 215335 China



TABLE OF CONTENTS

REVISION HISTORY..... 3

SUMMARY OF TEST RESULT 4

1 GENERAL DESCRIPTION..... 5

1.1 Applicant..... 5

1.2 Manufacturer..... 5

1.3 Product Feature of Equipment Under Test..... 5

1.4 Product Specification of Equipment Under Test..... 6

1.5 Modification of EUT 6

1.6 Specification of Accessory..... 7

1.7 Testing Location 8

1.8 Applicable Standards..... 9

2 TEST CONFIGURATION OF EQUIPMENT UNDER TEST..... 10

2.1 Descriptions of Test Mode..... 10

2.2 Test Mode..... 11

2.3 Connection Diagram of Test System..... 12

2.4 Support Unit used in test configuration and system 13

2.5 EUT Operation Test Setup 13

2.6 Measurement Results Explanation Example..... 13

3 TEST RESULT 14

3.1 Number of Channel Measurement 14

3.2 Hopping Channel Separation Measurement 16

3.3 Dwell Time Measurement..... 23

3.4 20dB Bandwidth Measurement 26

3.5 Peak Output Power Measurement 33

3.6 Conducted Band Edges Measurement..... 35

3.7 Conducted Spurious Emission Measurement 42

3.8 Radiated Band Edges and Spurious Emission Measurement 52

3.9 AC Conducted Emission Measurement..... 58

3.10 Antenna Requirements..... 62

4 LIST OF MEASURING EQUIPMENT..... 63

5 UNCERTAINTY OF EVALUATION..... 64

APPENDIX A. RADIATED SPURIOUS EMISSION

APPENDIX B. SETUP PHOTOGRAPHS



SUMMARY OF TEST RESULT

Report Section	FCC Rule	Description	Limit	Result	Remark
3.1	15.247(a)(1)	Number of Channels	$\geq 15\text{Chs}$	Pass	-
3.2	15.247(a)(1)	Hopping Channel Separation	$\geq 2/3$ of 20dB BW	Pass	-
3.3	15.247(a)(1)	Dwell Time of Each Channel	$\leq 0.4\text{sec}$ in 31.6sec period	Pass	-
3.4	15.247(a)(1)	20dB Bandwidth	NA	Pass	-
3.5	15.247(b)(1)	Peak Output Power	$\leq 125\text{ mW}$	Pass	-
3.6	15.247(d)	Conducted Band Edges	$\leq 20\text{dBc}$	Pass	-
3.7	15.247(d)	Conducted Spurious Emission	$\leq 20\text{dBc}$	Pass	-
3.8	15.247(d)	Radiated Band Edges and Radiated Spurious Emission	15.209(a) & 15.247(d)	Pass	Under limit 9.01 dB at 747.300 MHz
3.9	15.207	AC Conducted Emission	15.207(a)	Pass	Under limit 9.99 dB at 0.156 MHz
3.10	15.203 & 15.247(b)	Antenna Requirement	N/A	Pass	-



1 General Description

1.1 Applicant

Motorola Mobility LLC
222 W,Merchandise Mart Plaza, Chicago IL 60654 USA

1.2 Manufacturer

Motorola Mobility LLC
222 W,Merchandise Mart Plaza, Chicago IL 60654 USA

1.3 Product Feature of Equipment Under Test

Product Feature	
Equipment	Mobile Cellular Phone
Brand Name	Motorola
Model Name	XT1924-4, XT1924-5
FCC ID	IHDT56XA5
EUT supports Radios application	GSM/GPRS/EGPRS/WCDMA/HSPA/HSPA+(16QAM uplink is not supported)/DC-HSDPA/LTE/ WLAN 2.4GHz 802.11b/g/n HT20/ Bluetooth v3.0+EDR/ Bluetooth v4.0 LE/ Bluetooth v4.1 LE/ Bluetooth v4.2 LE
IMEI Code	Conducted : 351878090031216/351878090031224 Conduction: 351878090028931/351878090028949 Radiation: 351878090028550/351878090028568
HW Version	DVT1B
SW Version	rhannah-userdebug 8.0.0 OPP27.66 1190 intcfg,test-keys
EUT Stage	Identical Prototype

Remark:

1. The above EUT's information was declared by manufacturer. Please refer to the specifications or user's manual for more detailed description.
2. There are two types of EUT sample 1 and sample 2, the differences between two samples are only for SIM slot, sample 1(model name: XT1924-4) is dual SIM slot, sample 2(model name: XT1924-5) is single SIM slot. According to the difference, we choose sample 1 to perform full test.



1.4 Product Specification of Equipment Under Test

Standards-related Product Specification	
Tx/Rx Frequency Range	2402 MHz ~ 2480 MHz
Number of Channels	79
Carrier Frequency of Each Channel	2402+n*1 MHz; n=0~78
Maximum Output Power to Antenna	Bluetooth BR(1Mbps) : 8.95 dBm (0.0079 W) Bluetooth EDR (2Mbps) : 9.78 dBm (0.0095 W) Bluetooth EDR (3Mbps) : 10.18 dBm (0.0104 W)
Antenna Type / Gain	IFA Antenna with gain 0.07 dBi
Type of Modulation	Bluetooth BR (1Mbps) : GFSK Bluetooth EDR (2Mbps) : $\pi/4$ -DQPSK Bluetooth EDR (3Mbps) : 8-DPSK

1.5 Modification of EUT

No modifications are made to the EUT during all test items.



1.6 Specification of Accessory

Specification of Accessory				
AC Adapter 1(US)	Brand Name	Motorola (Acbel)	Model Name	SPN5945A C-P35
	Power Rating	I/P: 100-240 Vac, 300mA, O/P: 5Vdc, 2000mA		
AC Adapter 1(EU)	Brand Name	Motorola (Acbel)	Model Name	SPN5944A C-P36
	Power Rating	I/P: 100-240 Vac, 300mA, O/P: 5Vdc, 2000mA		
AC Adapter 1(UK)	Brand Name	Motorola (Acbel)	Model Name	SPN5940A C-P37
	Power Rating	I/P: 100-240 Vac, 300mA, O/P: 5Vdc, 2000mA		
AC Adapter 1(IN)	Brand Name	Motorola (Acbel)	Model Name	SA18C19493 C-P49 SPN5946A
	Power Rating	I/P: 100-240 Vac, 300mA, O/P: 5Vdc, 2000mA		
AC Adapter 2(US)	Brand Name	Motorola (Salom)	Model Name	SSW-2919UMTJ C-P35 SPN5945A
	Power Rating	I/P: 100-240 Vac, 300mA, O/P: 5Vdc, 2000mA		
AC Adapter 2(EU)	Brand Name	Motorola (Salom)	Model Name	SSW-2919EU C-P36 SPN5944A
	Power Rating	I/P: 100-240 Vac, 300mA, O/P: 5Vdc, 2000mA		
AC Adapter 2(UK)	Brand Name	Motorola (Salom)	Model Name	SSW-2919UK C-P37 SPN5940A
	Power Rating	I/P: 100-240 Vac, 300mA, O/P: 5Vdc, 2000mA		
Battery	Brand Name	Motorola (Amperex)	Model Name	HE50
	Power Rating	3.8Vdc,4850/5000mAh	Type	Li-ion
Earphone	Brand Name	Motorola (NEW Leaders)	Model Name	NLD-EM300V-01SF
	Signal Line Type	1.25 meter, non-shielded cable, without ferrite core		
USB Cable (Black/White)	Brand Name	Motorola (Saibao)	Model Name	SLQ-A081A
	Signal Line Type	1.02 meter, shielded cable, without ferrite core		



1.7 Testing Location

Sporton International (Kunshan) Inc. is accredited to ISO 17025 by National Voluntary Laboratory Accreditation Program (NVLAP code: 600155-0) and the FCC designation No. is CN5013.

Test Site	Sporton International (Kunshan) Inc.		
Test Site Location	No.3-2 Ping-Xiang Rd, Kunshan Development Zone Kunshan City Jiangsu Province 215335 China TEL : +86-512-57900158 FAX : +86-512-57900958		
Test Site No.	Sporton Site No.		FCC Test Firm Registration No.
	TH01-KS	CO01-KS	630927

Note: The test site complies with ANSI C63.4 2014 requirement.

SPORTON INTERNATIONAL INC. is accredited to ISO 17025 by Taiwan Accreditation Foundation (TAF code : 1190) and under the FCC-recognized accredited testing laboratories by Mutual Recognition Agreement (MRA) in FCC Test.

Test Site	SPORTON INTERNATIONAL INC.		
Test Site Location	No.58, Aly. 75, Ln. 564 Wenhua 3rd Rd. Guishan Dist. Taoyuan City Taiwan TEL: +886-3-327-3456 FAX: +886-3-328-4978		
Test Site No.	Sporton Site No.	FCC designation No.	FCC Test Firm Registration No.
	03CH12-HY	TW0007	214511

Note:

1. The test site complies with ANSI C63.4 2014 requirement.
2. Test data subcontracted: radiated spurious emissions in section 3.8 of this report.



1.8 Applicable Standards

According to the specifications of the manufacturer, the EUT must comply with the requirements of the following standards:

- ♦ FCC Part 15 Subpart C §15.247
- ♦ ANSI C63.10-2013

Remark:

1. All test items were verified and recorded according to the standards and without any deviation during the test.
2. This EUT has also been tested and complied with the requirements of FCC Part 15, Subpart B, recorded in a separate test report.



2 Test Configuration of Equipment Under Test

2.1 Descriptions of Test Mode

Preliminary tests were performed in different data rates and recorded the RF output power in the following table:

Channel	Frequency	Bluetooth RF Output Power		
		Data Rate / Modulation		
		GFSK	$\pi/4$ -DQPSK	8-DPSK
		1Mbps	2Mbps	3Mbps
Ch00	2402MHz	8.56 dBm	9.41 dBm	9.75 dBm
Ch39	2441MHz	8.95 dBm	9.78 dBm	10.18 dBm
Ch78	2480MHz	8.28 dBm	9.17 dBm	9.59 dBm

Remark:

1. All the test data for each data rate were verified, but only the worst case was reported.
 2. The data rate was set in 3Mbps for all the test items due to the highest RF output power.
- a. The EUT has been associated with peripherals and configuration operated in a manner tended to maximize its emission characteristics in a typical application. Frequency range investigated: conduction (150 kHz to 30 MHz), radiation (9 kHz to the 10th harmonic of the highest fundamental frequency or to 40 GHz, whichever is lower). Pre-scanned tests, X, Y, Z in three orthogonal panels, and different data rates were conducted to determine the final configuration from all possible combinations, and the worst mode of radiated spurious emissions is Bluetooth 3Mbps mode, and recorded in this report.
- b. AC power line Conducted Emission was tested under maximum output power.



2.2 Test Mode

The following summary table is showing all test modes to demonstrate in compliance with the standard.

Summary table of Test Cases			
Test Item	Data Rate / Modulation		
	Bluetooth BR 1Mbps GFSK	Bluetooth EDR 2Mbps $\pi/4$ -DQPSK	Bluetooth EDR 3Mbps 8-DPSK
Conducted Test Cases	Mode 1: CH00_2402 MHz Mode 2: CH39_2441 MHz Mode 3: CH78_2480 MHz	Mode 4: CH00_2402 MHz Mode 5: CH39_2441 MHz Mode 6: CH78_2480 MHz	Mode 7: CH00_2402 MHz Mode 8: CH39_2441 MHz Mode 9: CH78_2480 MHz
Radiated Test Cases	Bluetooth EDR 3Mbps 8-DPSK Mode 1: CH00_2402 MHz Mode 2: CH39_2441 MHz Mode 3: CH78_2480 MHz		
AC Conducted Emission	Mode 1 : GSM850 Idle + Bluetooth Link + WLAN Link(2.4G) + Earphone + USB Cable (Charging from Adapter 1) for Sample 1 Mode 2 : GSM850 Idle + Bluetooth Link + WLAN Link(2.4G) + Earphone + USB Cable (Charging from Adapter 2) for Sample 1		
Remark: The worst case of conducted emission is mode 1; only the test data of it was reported.			

2.3 Connection Diagram of Test System

<Bluetooth Tx Mode>

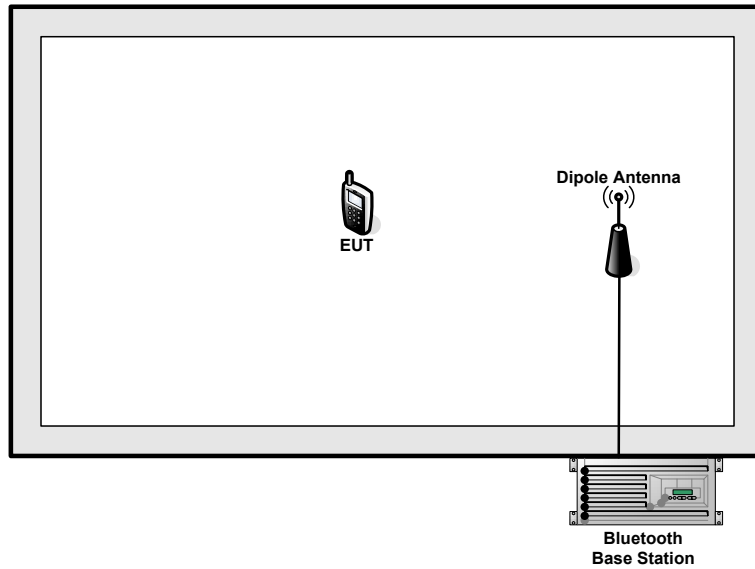

<AC Conducted Emission Mode>

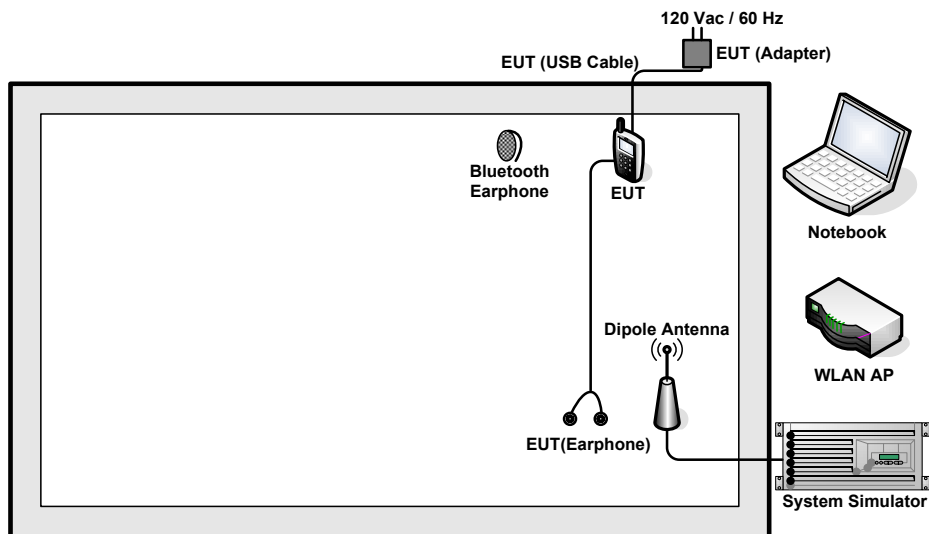



2.4 Support Unit used in test configuration and system

Item	Equipment	Trade Name	Model Name	FCC ID	Data Cable	Power Cord
1.	Bluetooth Base Station	R&S	CBT32	N/A	N/A	Unshielded, 1.8 m
2.	System Simulator	Anritsu	MT8820C	N/A	N/A	Unshielded, 1.8 m
3.	WLAN AP	D-Link	DIR-855	KA2DIR855A2	N/A	Unshielded,1.8m
4.	Notebook	Lenovo	G480	N/A	N/A	Shielded cable DC O/P 1.8 m Unshielded AC I/P cable1.2 m
5.	Bluetooth Earphone	Lenovo	LBH308	N/A	N/A	N/A

2.5 EUT Operation Test Setup

For Bluetooth function, the engineering test program was provided and enabled to make EUT connect with Bluetooth base station to continuous transmit/receive.

For AC power line conducted emissions, the EUT was set to connect with the WLAN AP under large package sizes transmission.

2.6 Measurement Results Explanation Example

For all conducted test items:

The offset level is set in the spectrum analyzer to compensate the RF cable loss between EUT conducted output port and spectrum analyzer. With the offset compensation, the spectrum analyzer reading level is exactly the EUT RF output level.

Example:

The spectrum analyzer offset is derived from RF cable loss .

$$\text{Offset} = \text{RF cable loss} .$$

Following shows an offset computation example with cable loss 5.4 dB.

$$\begin{aligned} \text{Offset}(dB) &= \text{RF cable loss}(dB) . \\ &= 5.4 (dB) \end{aligned}$$

3 Test Result

3.1 Number of Channel Measurement

3.1.1 Limits of Number of Hopping Frequency

Frequency hopping systems in the 2400-2483.5 MHz band shall use at least 15 channels.

3.1.2 Measuring Instruments

The measuring equipment is listed in the section 4 of this test report.

3.1.3 Test Procedure

1. The testing follows ANSI C63.10-2013 clause 7.8.3.
2. The RF output of EUT was connected to the spectrum analyzer by RF cable and attenuator. The path loss was compensated to the results for each measurement.
3. Set to the maximum power setting and enable the EUT transmit continuously.
4. Enable the EUT hopping function.
5. Use the following spectrum analyzer settings: Span = the frequency band of operation; RBW = 300kHz; VBW \geq RBW; Sweep = auto; Detector function = peak; Trace = max hold.
6. The number of hopping frequency used is defined as the number of total channel.
7. Record the measurement data derived from spectrum analyzer.

3.1.4 Test Setup

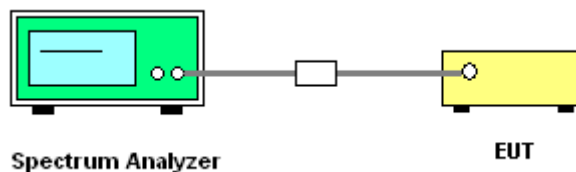

3.1.5 Test Result of Number of Hopping Frequency

Test Mode :	3Mbps	Temperature :	21~25°C
Test Engineer :	Silent Hai	Relative Humidity :	51~55%
Number of Hopping (Channel)	Adaptive Frequency Hopping (Channel)	Limits (Channel)	Pass/Fail
79	20	> 15	Pass



Number of Hopping Channel Plot on Channel 00 - 78

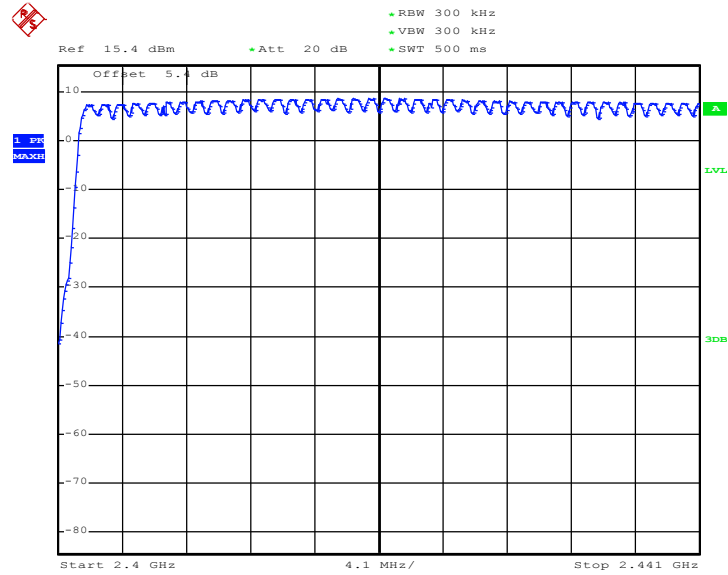

Date: 28.DEC.2017 01:26:02

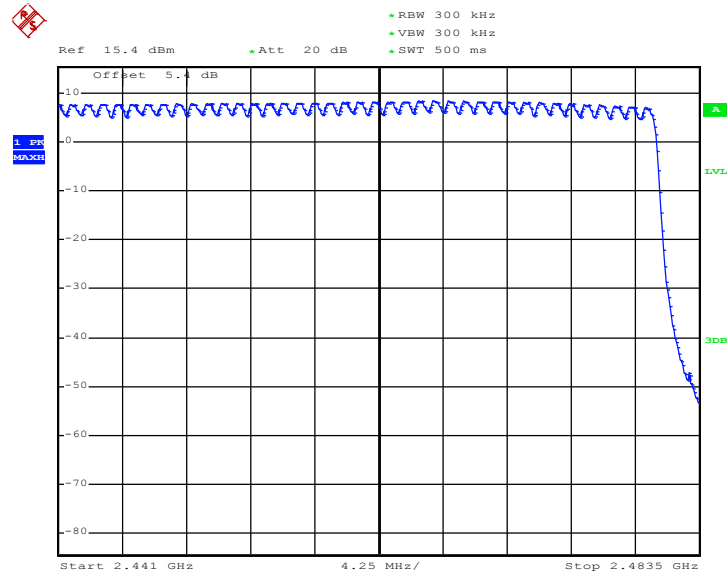

Date: 28.DEC.2017 01:33:00

3.2 Hopping Channel Separation Measurement

3.2.1 Limit of Hopping Channel Separation

Frequency hopping systems operating in the 2400-2483.5 MHz band may have hopping channel carrier frequencies that are separated by 25 kHz or two-thirds of the 20 dB bandwidth of the hopping channel, whichever is greater.

3.2.2 Measuring Instruments

The measuring equipment is listed in the section 4 of this test report.

3.2.3 Test Procedures

1. The testing follows ANSI C63.10-2013 clause 7.8.2.
2. The RF output of EUT was connected to the spectrum analyzer by RF cable and attenuator. The path loss was compensated to the results for each measurement.
3. Set to the maximum power setting and enable the EUT transmit continuously.
4. Enable the EUT hopping function.
5. Use the following spectrum analyzer settings:
Span = wide enough to capture the peaks of two adjacent channels;
RBW = 300kHz; VBW \geq RBW; Sweep = auto; Detector function = peak; Trace = max hold.
6. Measure and record the results in the test report.

3.2.4 Test Setup

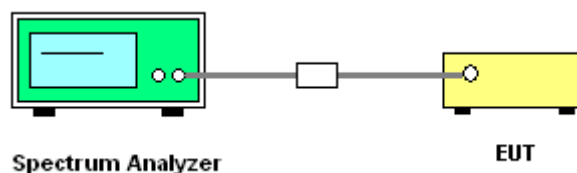



3.2.5 Test Result of Hopping Channel Separation

Test Mode :	1Mbps	Temperature :	21~25°C
Test Engineer :	Silent Hai	Relative Humidity :	51~55%

Channel	Frequency (MHz)	Frequency Separation (MHz)	(2/3 of 20dB BW) Limits (MHz)	Pass/Fail
00	2402	1.008	0.6480	Pass
39	2441	1.002	0.6453	Pass
78	2480	1.008	0.6453	Pass

Channel Separation Plot on Channel 00 - 01

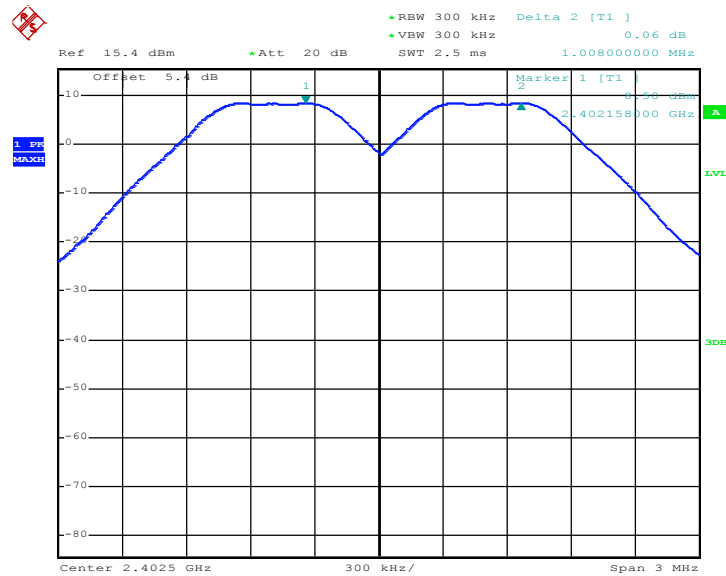

Date: 28.DEC.2017 00:18:56



Channel Separation Plot on Channel 39 - 40

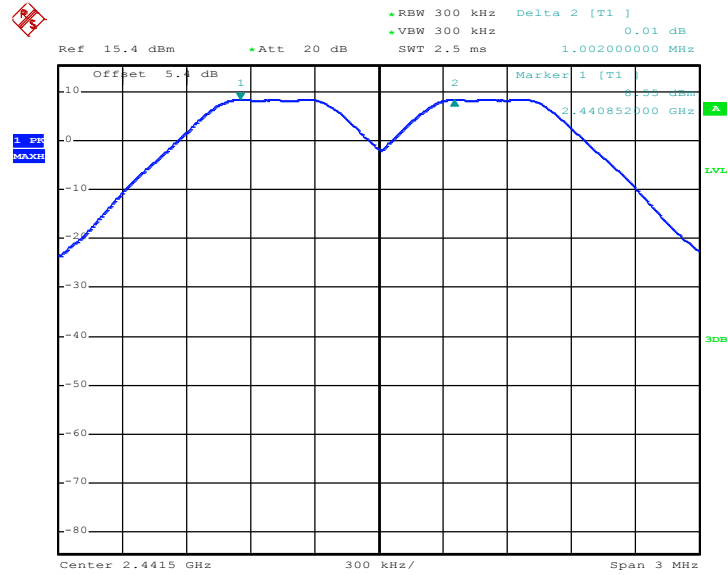

Date: 28.DEC.2017 00:27:41

Channel Separation Plot on Channel 77 - 78

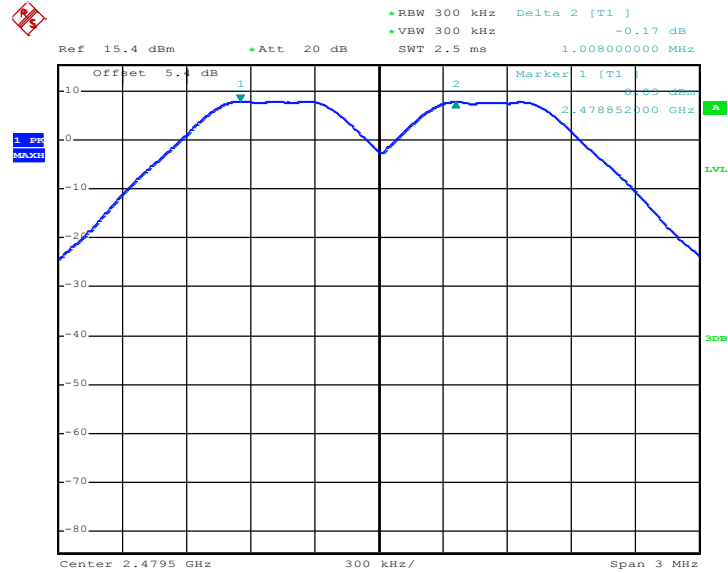

Date: 28.DEC.2017 00:31:38



Test Mode :	2Mbps	Temperature :	21~25°C
Test Engineer :	Silent Hai	Relative Humidity :	51~55%

Channel	Frequency (MHz)	Frequency Separation (MHz)	(2/3 of 20dB BW) Limits (MHz)	Pass/Fail
00	2402	1.008	0.8480	Pass
39	2441	1.002	0.8480	Pass
78	2480	1.008	0.8480	Pass

Channel Separation Plot on Channel 00 - 01

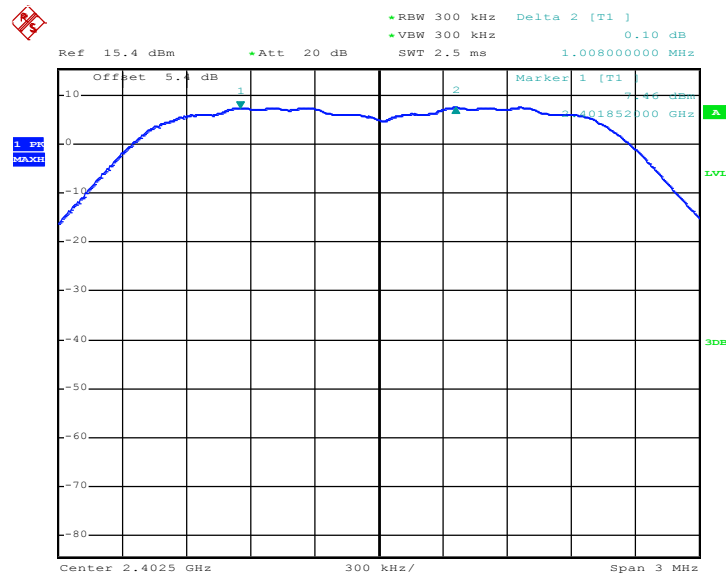

Date: 28.DEC.2017 00:38:35



Channel Separation Plot on Channel 39 - 40

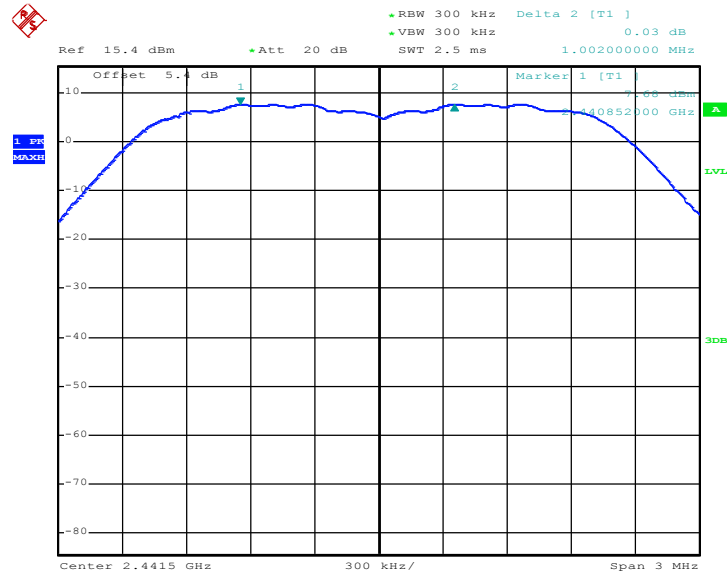

Date: 28.DEC.2017 00:45:59

Channel Separation Plot on Channel 77 - 78

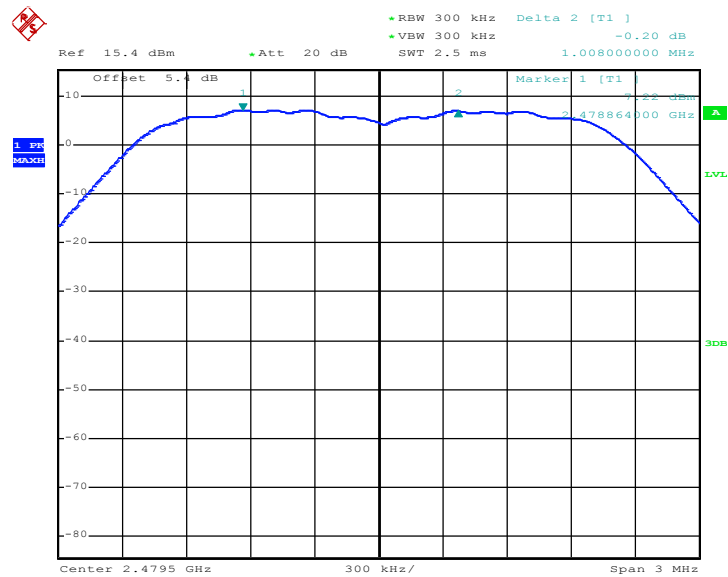

Date: 28.DEC.2017 00:50:58



Test Mode :	3Mbps	Temperature :	21~25°C
Test Engineer :	Silent Hai	Relative Humidity :	51~55%

Channel	Frequency (MHz)	Frequency Separation (MHz)	(2/3 of 20dB BW) Limits (MHz)	Pass/Fail
00	2402	1.008	0.8280	Pass
39	2441	1.002	0.8280	Pass
78	2480	1.002	0.8280	Pass

Channel Separation Plot on Channel 00 - 01

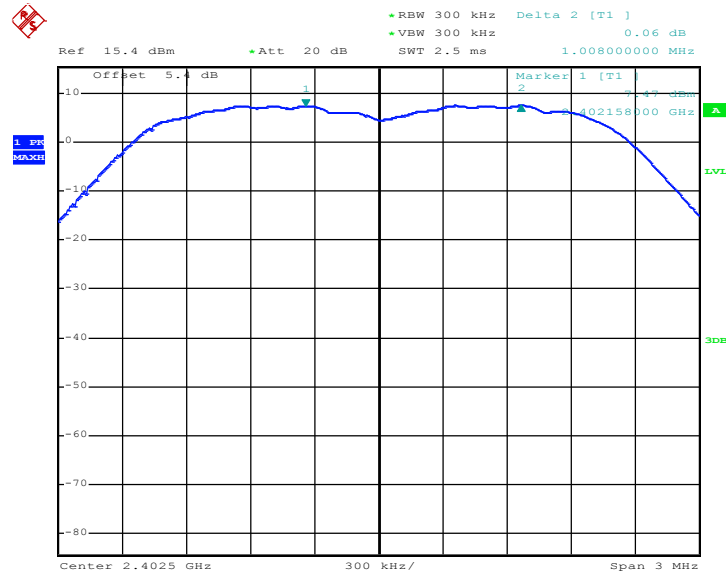

Date: 28.DEC.2017 01:00:02



Channel Separation Plot on Channel 39 - 40

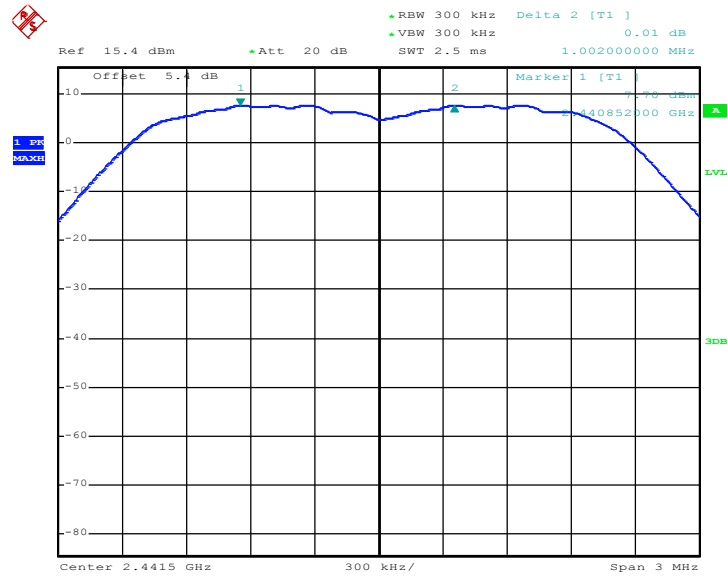

Date: 28.DEC.2017 01:03:52

Channel Separation Plot on Channel 77 - 78

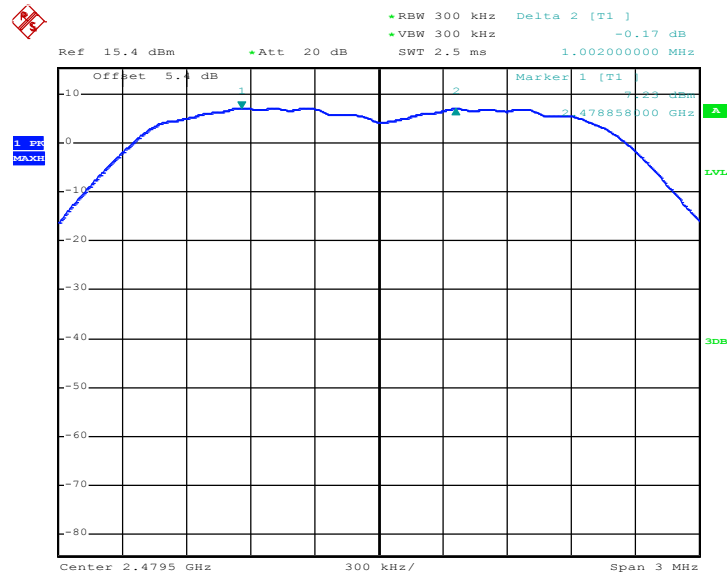

Date: 28.DEC.2017 01:10:37

3.3 Dwell Time Measurement

3.3.1 Limit of Dwell Time

The average time of occupancy on any channel shall not be greater than 0.4 seconds within a period of 0.4 seconds multiplied by the number of hopping channels employed.

3.3.2 Measuring Instruments

The measuring equipment is listed in the section 4 of this test report.

3.3.3 Test Procedures

1. The testing follows ANSI C63.10-2013 clause 7.8.4.
2. The RF output of EUT was connected to the spectrum analyzer by RF cable and attenuator. The path loss was compensated to the results for each measurement.
3. Set to the maximum power setting and enable the EUT transmit continuously.
4. Enable the EUT hopping function.
5. Use the following spectrum analyzer settings: Span = zero span, centered on a hopping channel; RBW = 1 MHz; VBW \geq RBW; Sweep = as necessary to capture the entire dwell time per hopping channel; Detector function = peak; Trace = max hold.
6. Measure and record the results in the test report.

3.3.4 Test Setup

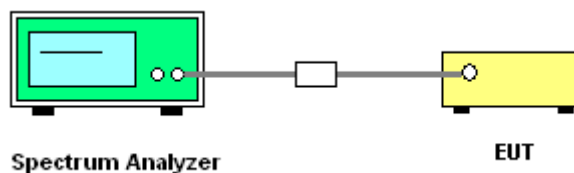



3.3.5 Test Result of Dwell Time

Test Mode :	2DH5	Temperature :	21~25°C
Test Engineer :	Silent Hai	Relative Humidity :	51~55%

Mode	Hopping Channel Number	Hops Over Occupancy Time(hops)	Package Transfer Time (msec)	Dwell Time (sec)	Limits (sec)	Pass/Fail
Normal	79	106.67	2.8986	0.31	0.4	Pass
AFH	20	53.33	2.8986	0.15	0.4	Pass

Remark:

- In normal mode, hopping rate is 1600 hops/s with 6 slots in 79 hopping channels.
With channel hopping rate (1600 / 6 / 79) in Occupancy Time Limit (0.4 x 79) (s),
Hops Over Occupancy Time comes to (1600 / 6 / 79) x (0.4 x 79) = 106.67 hops.
- In AFH mode, hopping rate is 800 hops/s with 6 slots in 20 hopping channels.
With channel hopping rate (800 / 6 / 20) in Occupancy Time Limit (0.4 x 20) (s),
Hops Over Occupancy Time comes to (800 / 6 / 20) x (0.4 x 20) = 53.33 hops.
- Dwell Time(s) = Hops Over Occupancy Time (hops) x Package Transfer Time



Package Transfer Time Plot

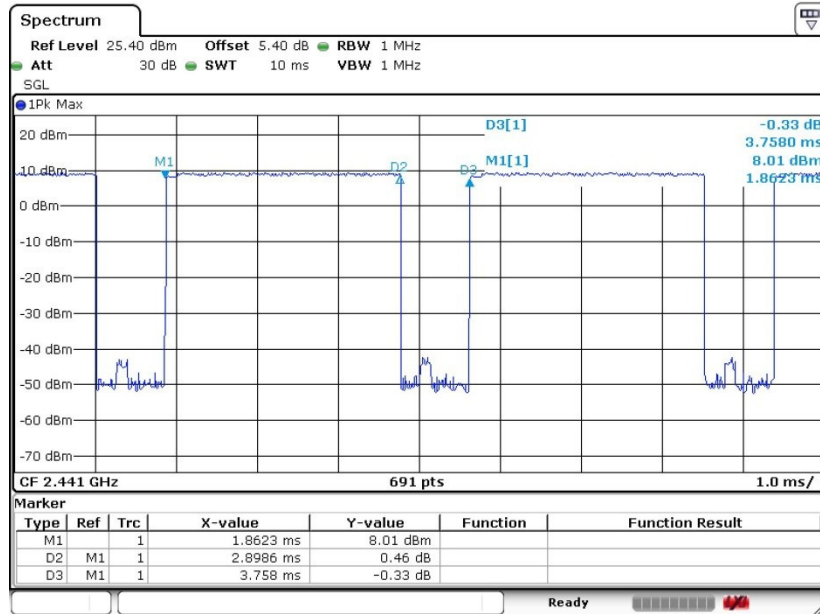

Date: 26 DEC 2017 18:01:18

3.4 20dB Bandwidth Measurement

3.4.1 Limit of 20dB Bandwidth

Reporting only

3.4.2 Measuring Instruments

The measuring equipment is listed in the section 4 of this test report.

3.4.3 Test Procedures

1. The testing follows ANSI C63.10-2013 clause 6.9.2 and 6.9.3.
2. The RF output of EUT was connected to the spectrum analyzer by RF cable and attenuator. The path loss was compensated to the results for each measurement.
3. Set to the maximum power setting and enable the EUT transmit continuously.
4. Use the following spectrum analyzer settings for 20dB Bandwidth measurement.
Span = approximately 2 to 5 times the 20 dB bandwidth, centered on a hopping channel;
RBW \geq 1% of the 20 dB bandwidth; VBW \geq RBW; Sweep = auto; Detector function = peak;
Trace = max hold.
5. Measure and record the results in the test report.

3.4.4 Test Setup

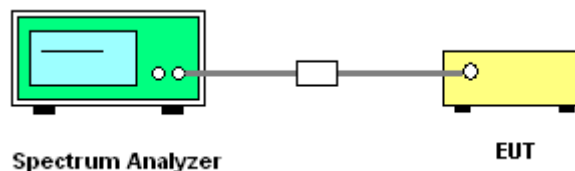



3.4.5 Test Result of 20dB Bandwidth

Test Mode :	1Mbps	Temperature :	21~25°C
Test Engineer :	Silent Hai	Relative Humidity :	51~55%

Channel	Frequency (MHz)	20dB Bandwidth (MHz)
00	2402	0.972
39	2441	0.968
78	2480	0.968

20 dB Bandwidth Plot on Channel 00

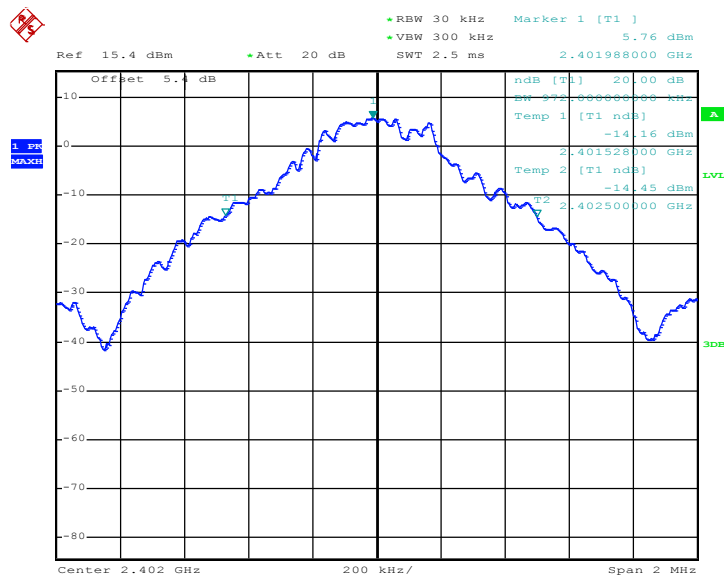

Date: 28.DEC.2017 00:20:00



20 dB Bandwidth Plot on Channel 39

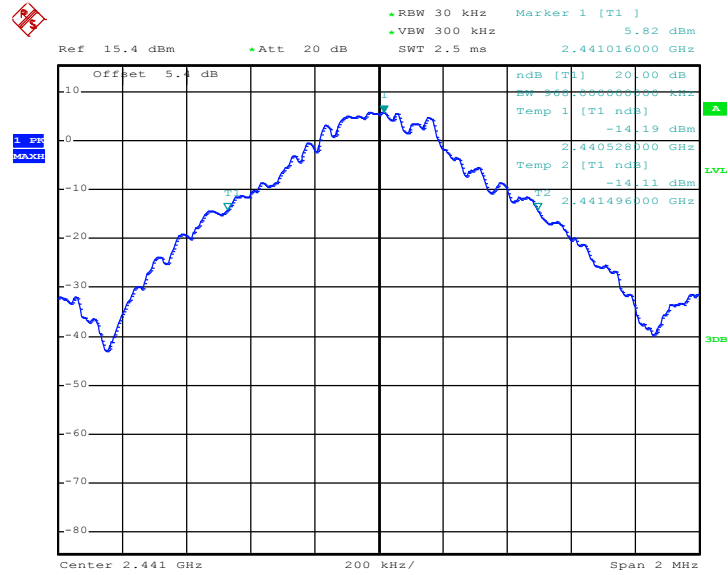

Date: 28.DEC.2017 00:28:43

20 dB Bandwidth Plot on Channel 78

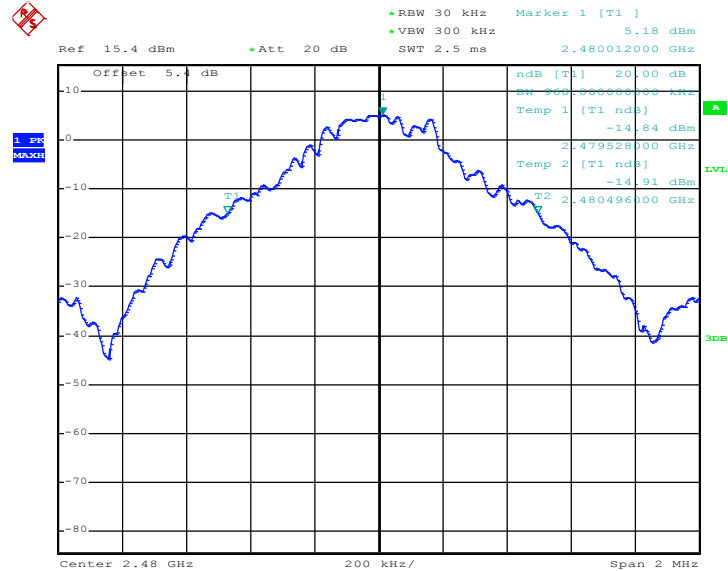

Date: 28.DEC.2017 00:32:12



Test Mode :	2Mbps	Temperature :	21~25°C
Test Engineer :	Silent Hai	Relative Humidity :	51~55%

Channel	Frequency (MHz)	20dB Bandwidth (MHz)
00	2402	1.272
39	2441	1.272
78	2480	1.272

20 dB Bandwidth Plot on Channel 00

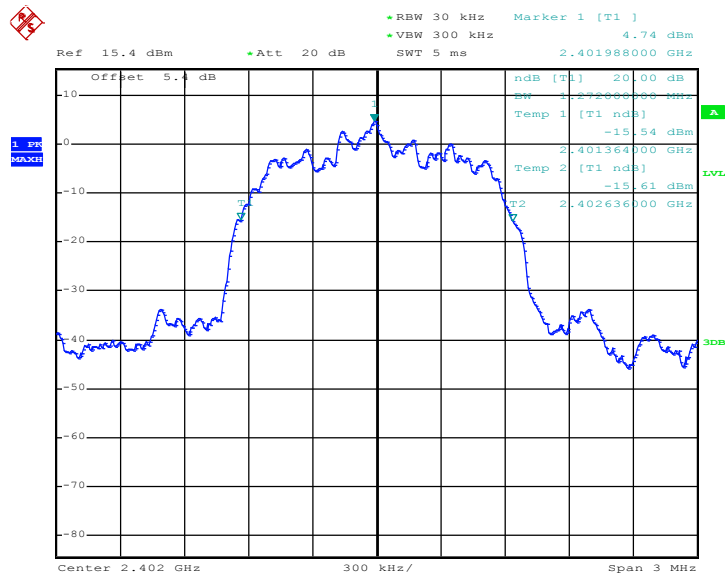

Date: 28.DEC.2017 00:39:35



Test Mode :	3Mbps	Temperature :	21~25°C
Test Engineer :	Silent Hai	Relative Humidity :	51~55%

Channel	Frequency (MHz)	20dB Bandwidth (MHz)
00	2402	1.242
39	2441	1.242
78	2480	1.242

20 dB Bandwidth Plot on Channel 00

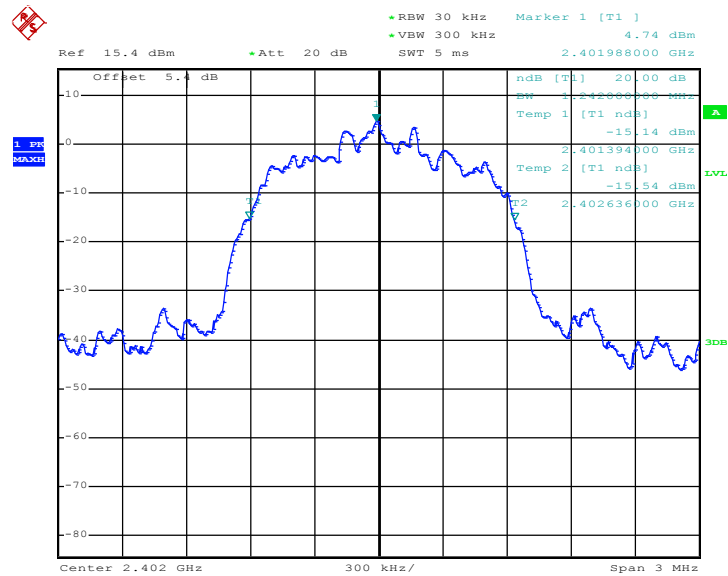

Date: 28.DEC.2017 01:00:31



20 dB Bandwidth Plot on Channel 39

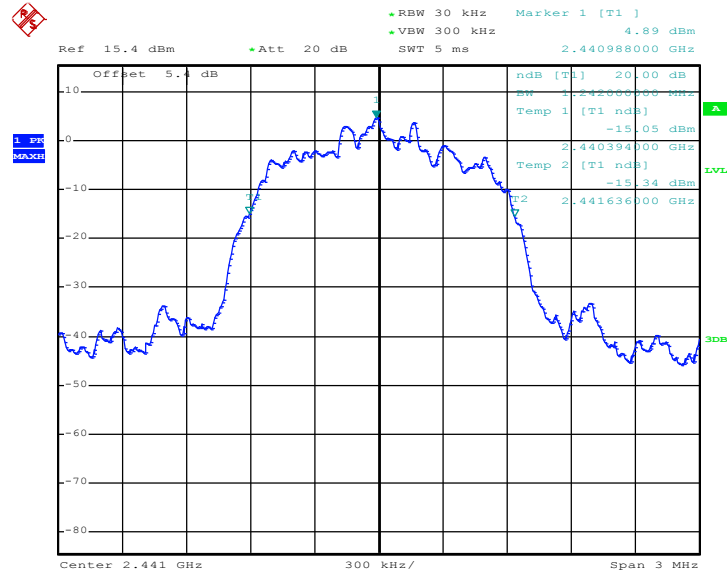

Date: 28.DEC.2017 01:04:54

20 dB Bandwidth Plot on Channel 78

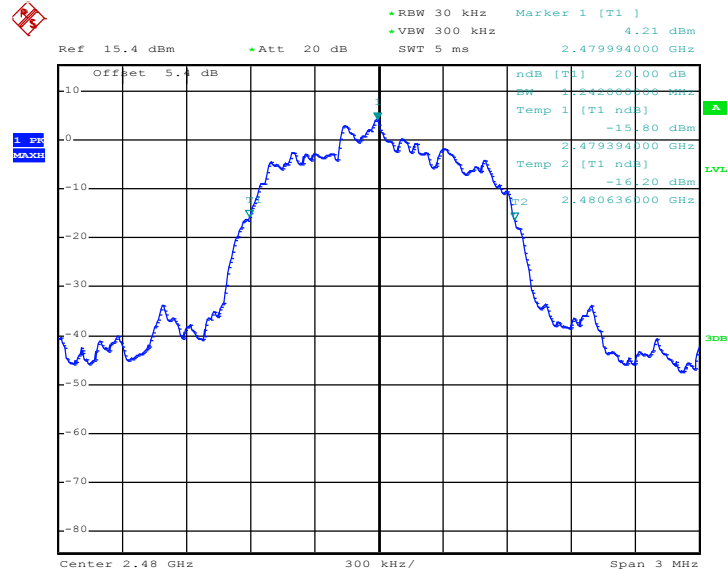

Date: 28.DEC.2017 01:11:08

3.5 Peak Output Power Measurement

3.5.1 Limit of Peak Output Power

The maximum peak conducted output power of the intentional radiator shall not exceed the following:

- (1) For frequency hopping systems operating in the 2400-2483.5 MHz band employing at least 75 non-overlapping hopping channels, and all frequency hopping systems in the 5725-5850 MHz band: 1 watt. For all other frequency hopping systems in the 2400-2483.5 MHz band 0.125 watts.

3.5.2 Measuring Instruments

The measuring equipment is listed in the section 4 of this test report.

3.5.3 Test Procedures

1. The testing follows ANSI C63.10-2013 clause 7.8.5.
2. The RF output of EUT was connected to the power meter by RF cable and attenuator. The path loss was compensated to the results for each measurement.
3. Set to the maximum power setting and enable the EUT transmit continuously.
4. Measure the conducted output power with cable loss and record the results in the test report.
5. Measure and record the results in the test report.

3.5.4 Test Setup

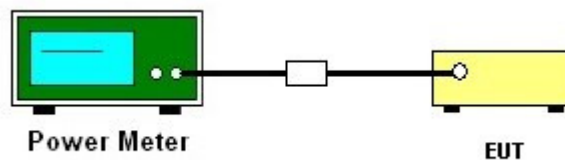



3.5.5 Test Result of Peak Output Power

Test Mode :	1Mbps	Temperature :	21~25°C
Test Engineer :	Silent Hai	Relative Humidity :	51~55%

Channel	Frequency (MHz)	RF Power (dBm)		
		GFSK	Max. Limits (dBm)	Pass/Fail
		1 Mbps		
00	2402	8.56	20.97	Pass
39	2441	8.95	20.97	Pass
78	2480	8.28	20.97	Pass

Test Mode :	2Mbps	Temperature :	21~25°C
Test Engineer :	Silent Hai	Relative Humidity :	51~55%

Channel	Frequency (MHz)	RF Power (dBm)		
		$\pi/4$ -DQPSK	Max. Limits (dBm)	Pass/Fail
		2 Mbps		
00	2402	9.41	20.97	Pass
39	2441	9.78	20.97	Pass
78	2480	9.17	20.97	Pass

Test Mode :	3Mbps	Temperature :	21~25°C
Test Engineer :	Silent Hai	Relative Humidity :	51~55%

Channel	Frequency (MHz)	RF Power (dBm)		
		8-DPSK	Max. Limits (dBm)	Pass/Fail
		3 Mbps		
00	2402	9.75	20.97	Pass
39	2441	10.18	20.97	Pass
78	2480	9.59	20.97	Pass

3.6 Conducted Band Edges Measurement

3.6.1 Limit of Band Edges

In any 100 kHz bandwidth outside the intentional radiation frequency band, the radio frequency power shall be at least 20 dB below the highest level of the radiated power. In addition, radiated emissions which fall in the restricted bands must also comply with the radiated emission limits.

3.6.2 Measuring Instruments

The measuring equipment is listed in the section 4 of this test report.

3.6.3 Test Procedures

1. The testing follows ANSI C63.10-2013 clause 7.8.6.
2. Set to the maximum power setting and enable the EUT transmit continuously.
3. Set RBW = 100kHz, VBW = 300kHz. Band edge emissions must be at least 20 dB down from the highest emission level within the authorized band as measured with a 100kHz RBW. The attenuation shall be 30 dB instead of 20 dB when RMS conducted output power procedure is used.
4. Enable hopping function of the EUT and then repeat step 2. and 3.
5. Measure and record the results in the test report.

3.6.4 Test Setup

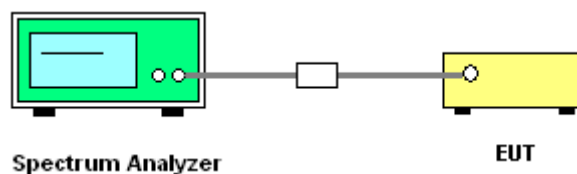



3.6.5 Test Result of Conducted Band Edges

Test Mode :	1Mbps	Temperature :	21~25°C
Test Channel :	00 and 78	Relative Humidity :	51~55%
		Test Engineer :	Silent Hai

Low Band Edge Plot on Channel 00

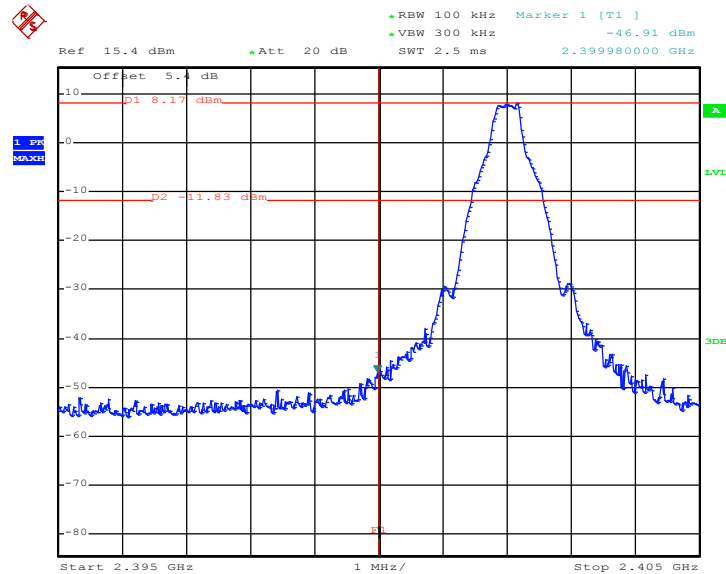

Date: 28.DEC.2017 00:21:48

High Band Edge Plot on Channel 78

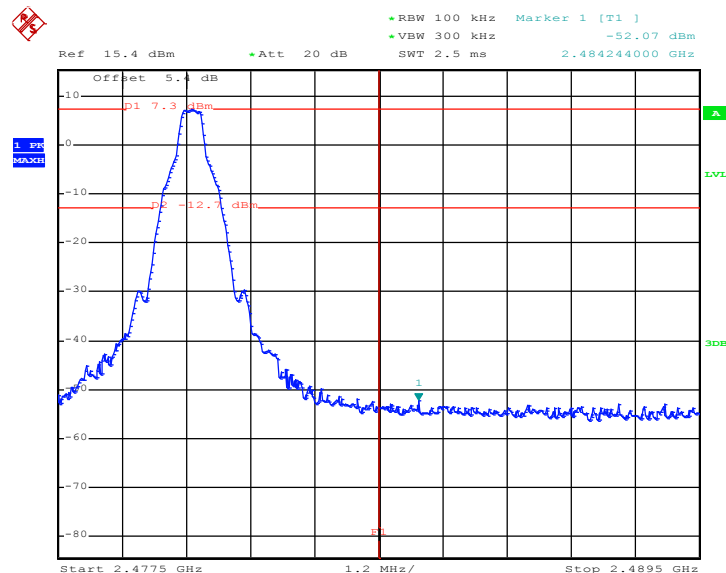

Date: 28.DEC.2017 00:33:19



Test Mode :	2Mbps	Temperature :	21~25°C
Test Channel :	00 and 78	Relative Humidity :	51~55%
		Test Engineer :	Silent Hai

Low Band Edge Plot on Channel 00

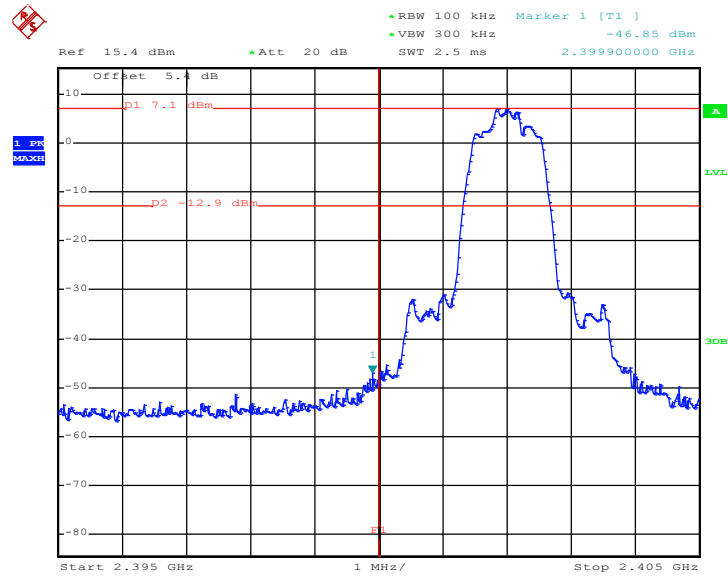

Date: 28.DEC.2017 00:39:55

High Band Edge Plot on Channel 78

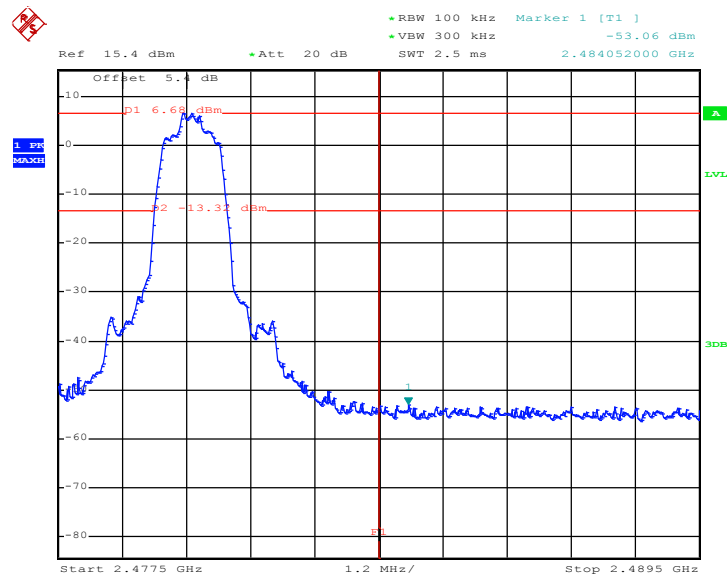

Date: 28.DEC.2017 00:53:24



Test Mode :	3Mbps	Temperature :	21~25°C
Test Channel :	00 and 78	Relative Humidity :	51~55%
		Test Engineer :	Silent Hai

Low Band Edge Plot on Channel 00

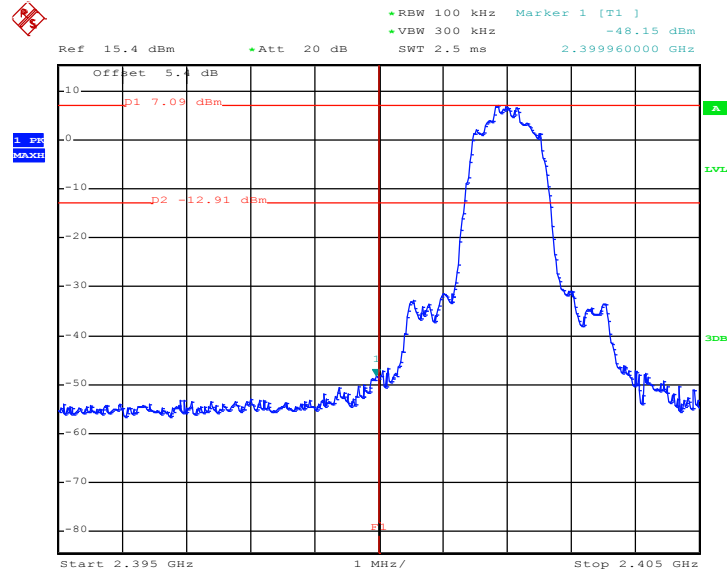

Date: 28.DEC.2017 01:01:48

High Band Edge Plot on Channel 78

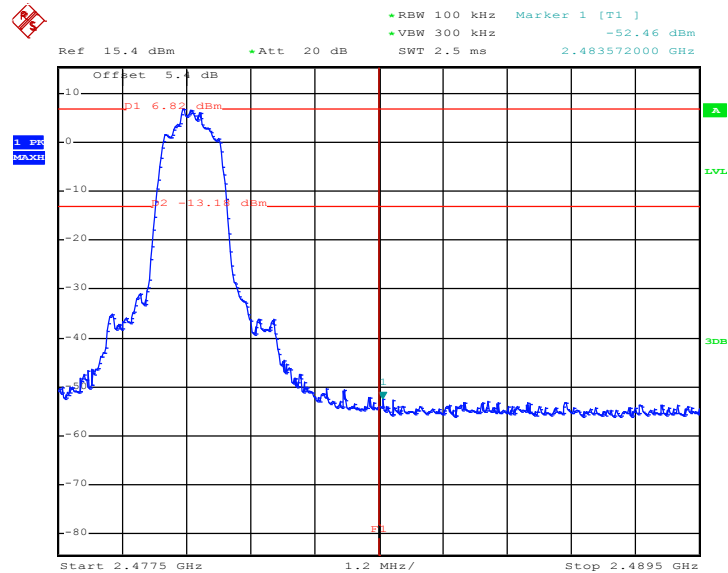

Date: 28.DEC.2017 01:12:44



3.6.6 Test Result of Conducted Hopping Mode Band Edges

Test Mode :	1Mbps	Temperature :	21~25°C
Test Engineer :	Silent Hai	Relative Humidity :	51~55%

1Mbps Hopping Mode Low Band Edge Plot

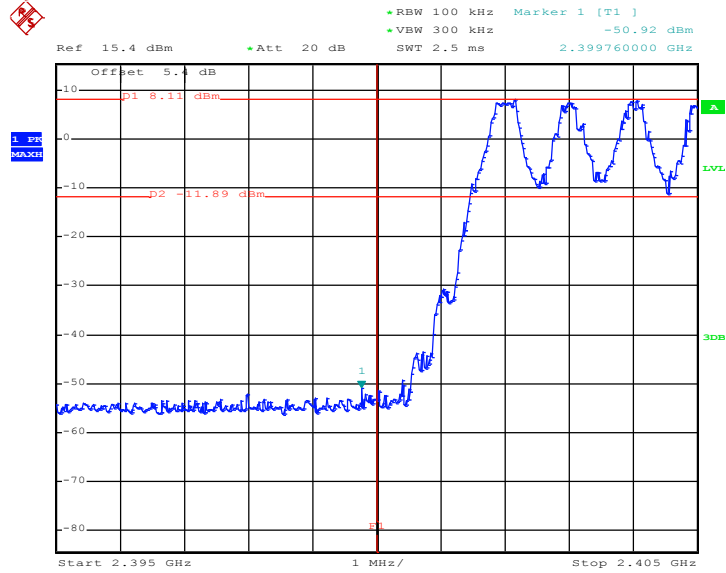

Date: 28.DEC.2017 01:16:12

1Mbps Hopping Mode High Band Edge Plot

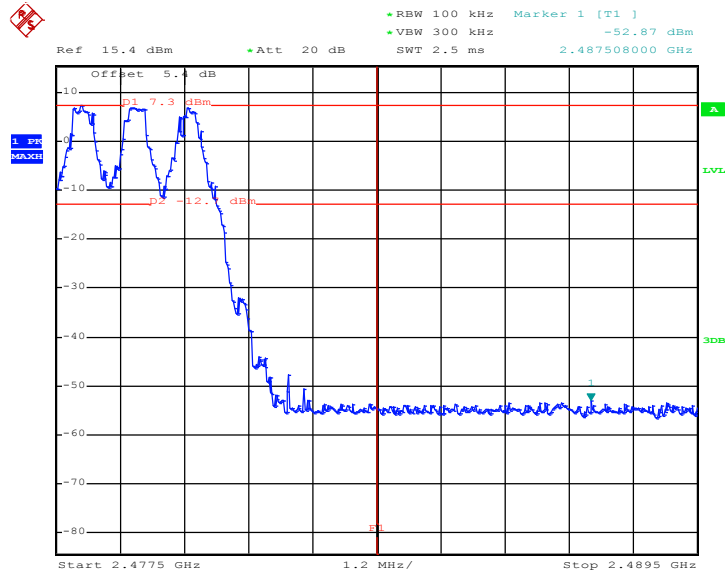

Date: 28.DEC.2017 01:16:42



Test Mode :	2Mbps	Temperature :	21~25°C
Test Engineer :	Silent Hai	Relative Humidity :	51~55%

2Mbps Hopping Mode Low Band Edge Plot

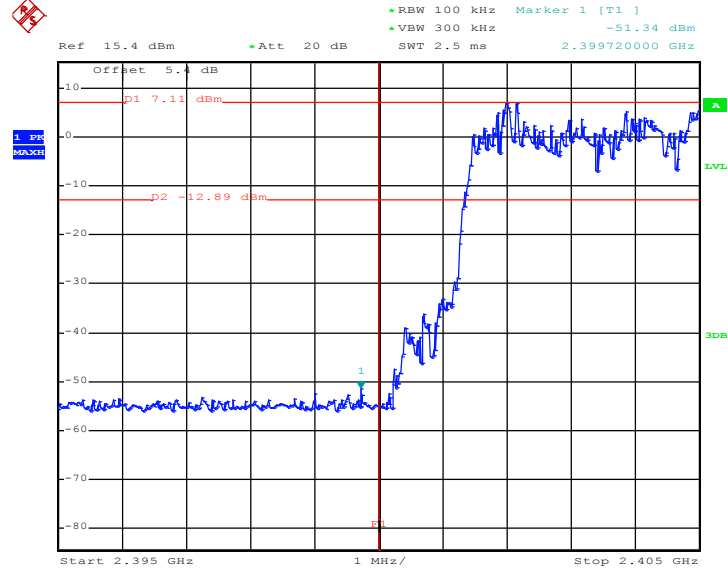

Date: 28.DEC.2017 01:19:15

2Mbps Hopping Mode High Band Edge Plot

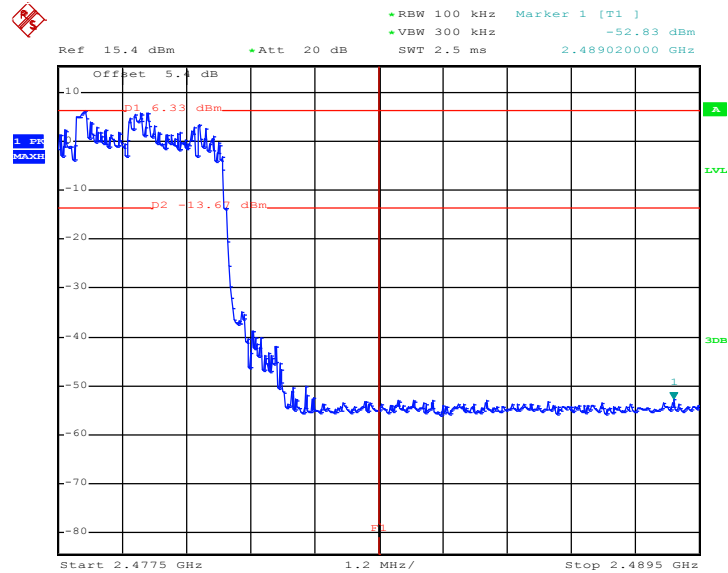

Date: 28.DEC.2017 01:18:19



Test Mode :	3Mbps	Temperature :	21~25°C
Test Engineer :	Silent Hai	Relative Humidity :	51~55%

3Mbps Hopping Mode Low Band Edge Plot

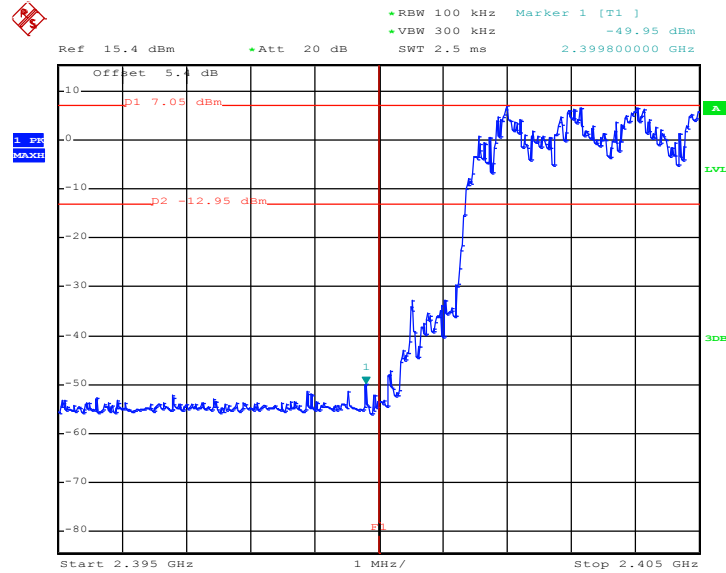

Date: 28.DEC.2017 01:20:20

3Mbps Hopping Mode High Band Edge Plot

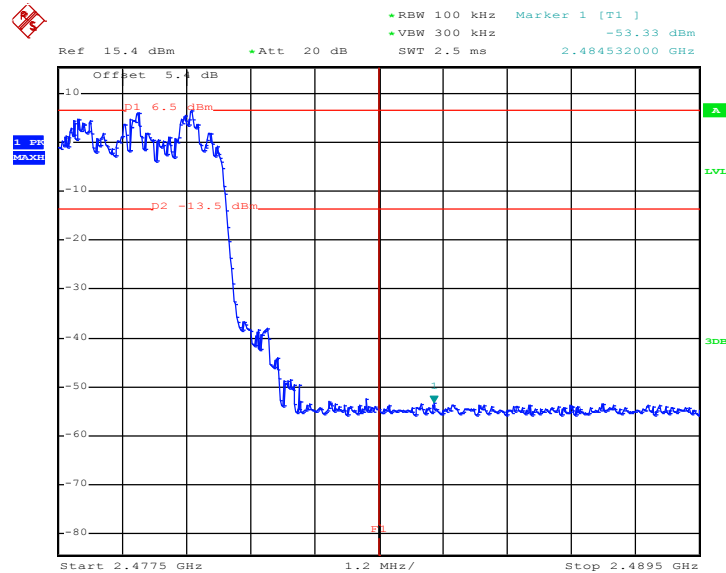

Date: 28.DEC.2017 01:21:42

3.7 Conducted Spurious Emission Measurement

3.7.1 Limit of Spurious Emission Measurement

In any 100 kHz bandwidth outside the intentional radiation frequency band, the radio frequency power shall be at least 20 dB below the highest level of the radiated power. In addition, radiated emissions which fall in the restricted bands must also comply with the radiated emission limits.

3.7.2 Measuring Instruments

The measuring equipment is listed in the section 4 of this test report.

3.7.3 Test Procedure

1. The testing follows ANSI C63.10-2013 clause 7.8.8.
2. The RF output of EUT was connected to the spectrum analyzer by RF cable and attenuator. The path loss was compensated to the results for each measurement.
3. Set to the maximum power setting and enable the EUT transmit continuously.
4. Set RBW = 100 kHz, VBW = 300kHz, scan up through 10th harmonic. All harmonics / spurs must be at least 20 dB down from the highest emission level within the authorized band as measured with a 100 kHz RBW.
5. Measure and record the results in the test report.
6. The RF fundamental frequency should be excluded against the limit line in the operating frequency band.

3.7.4 Test Setup

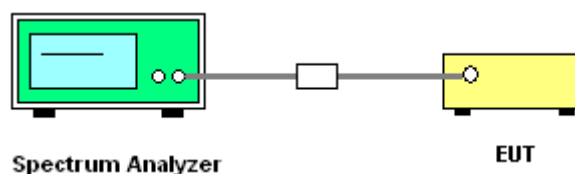



3.7.5 Test Result of Conducted Spurious Emission

Test Mode :	1Mbps	Temperature :	21~25°C
Test Channel :	00	Relative Humidity :	51~55%
		Test Engineer :	Silent Hai

1Mbps CSE Plot on Ch 00 between 30MHz ~ 3 GHz

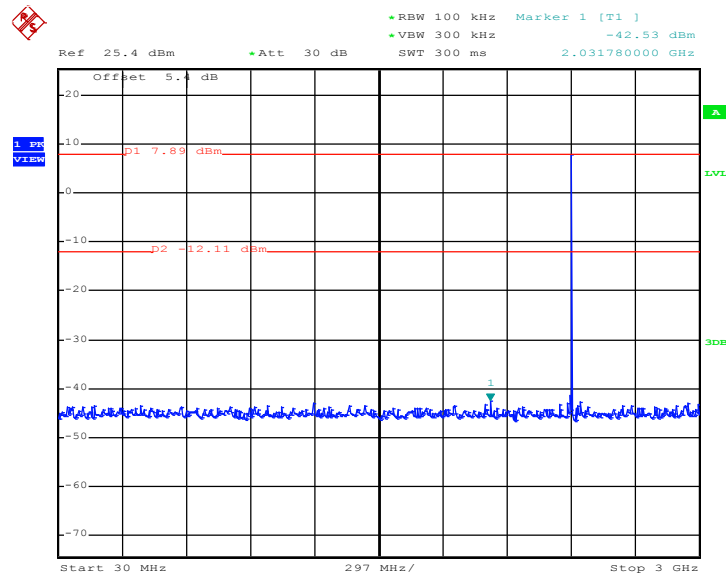

Date: 28.DEC.2017 00:23:48

1Mbps CSE Plot on Ch 00 between 2 GHz ~ 25 GHz

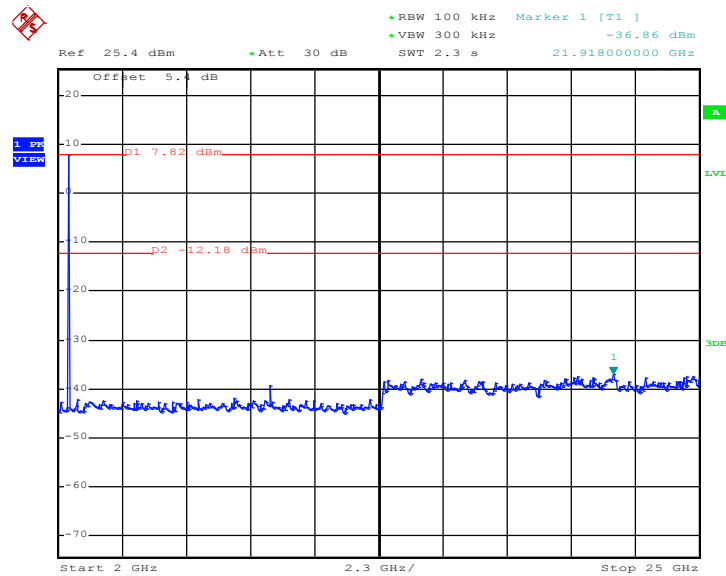

Date: 28.DEC.2017 00:25:06



Test Mode :	1Mbps	Temperature :	21~25°C
Test Channel :	39	Relative Humidity :	51~55%
		Test Engineer :	Silent Hai

1Mbps CSE Plot on Ch 39 between 30MHz ~ 3 GHz

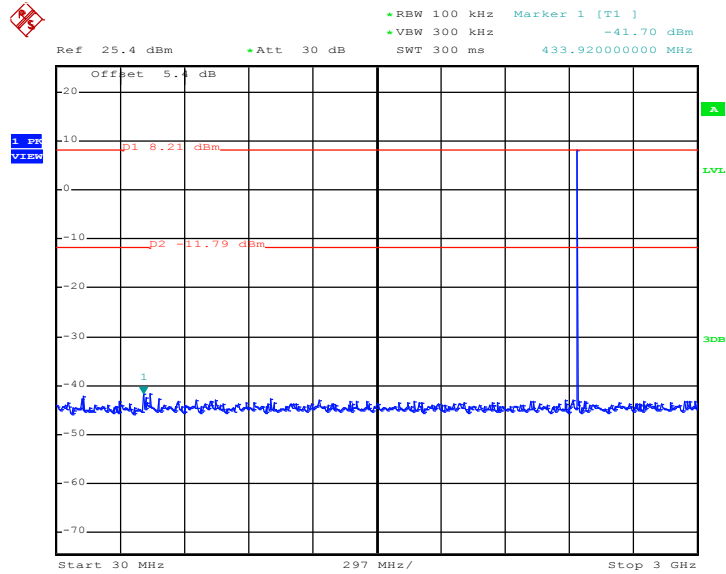

Date: 28.DEC.2017 00:29:52

1Mbps CSE Plot on Ch 39 between 2 GHz ~ 25 GHz

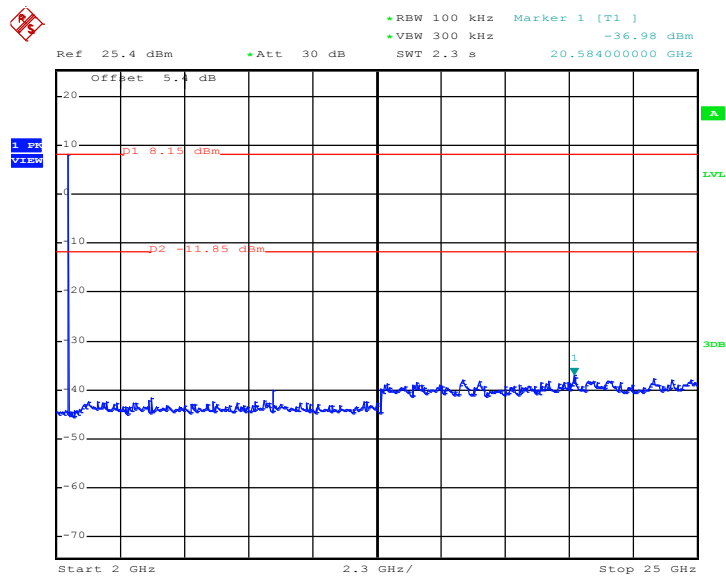

Date: 28.DEC.2017 00:30:13



Test Mode :	1Mbps	Temperature :	21~25°C
Test Channel :	78	Relative Humidity :	51~55%
		Test Engineer :	Silent Hai

1Mbps CSE Plot on Ch 78 between 30MHz ~ 3 GHz

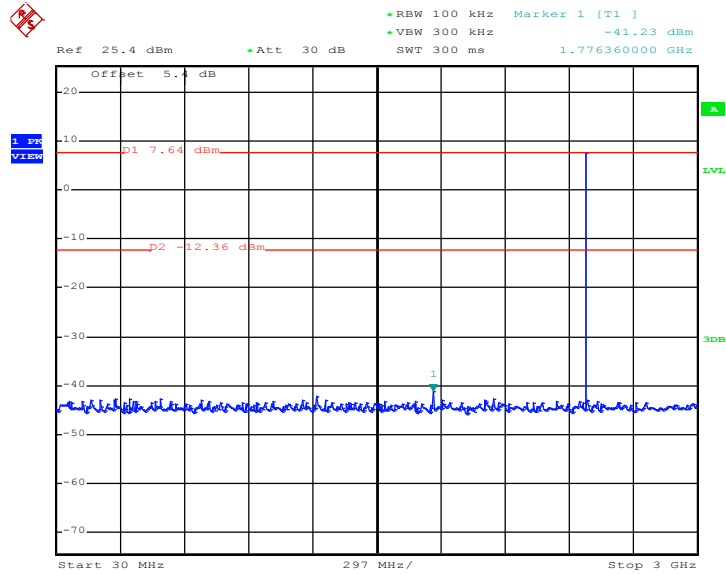

Date: 28.DEC.2017 00:34:36

1Mbps CSE Plot on Ch 78 between 2 GHz ~ 25 GHz

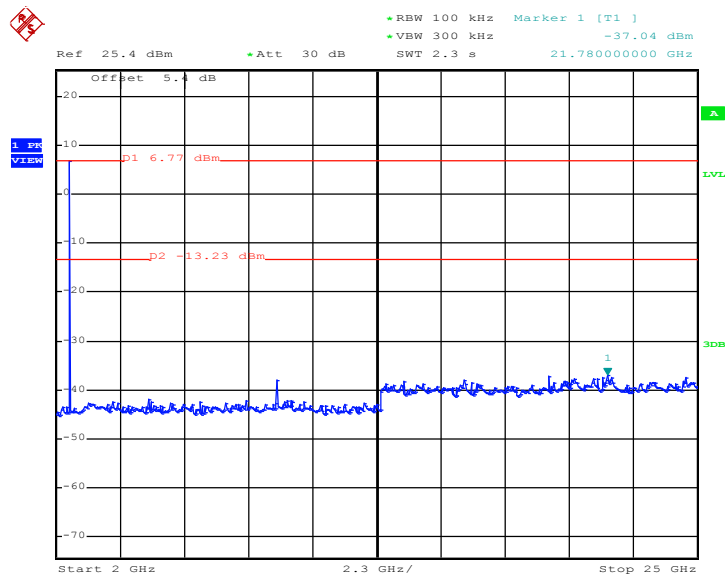

Date: 28.DEC.2017 00:34:57



Test Mode :	2Mbps	Temperature :	21~25°C
Test Channel :	00	Relative Humidity :	51~55%
		Test Engineer :	Silent Hai

2Mbps CSE Plot on Ch 00 between 30MHz ~ 3 GHz

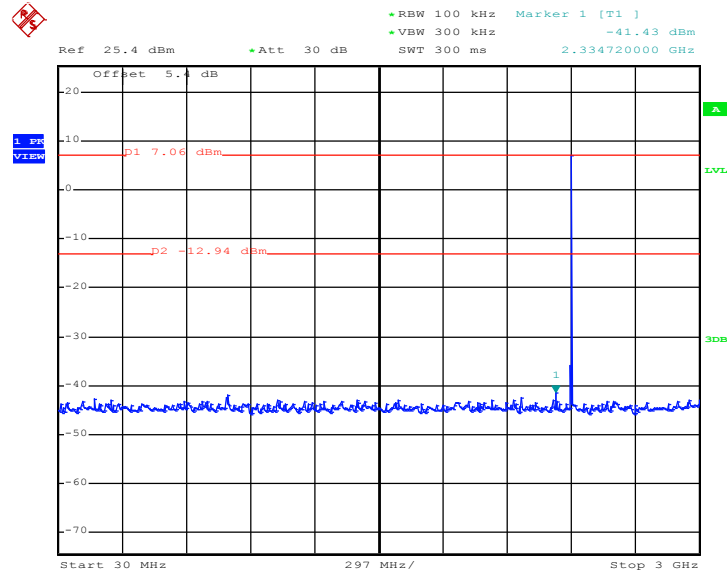

Date: 28.DEC.2017 00:42:02

2Mbps CSE Plot on Ch 00 between 2 GHz ~ 25 GHz

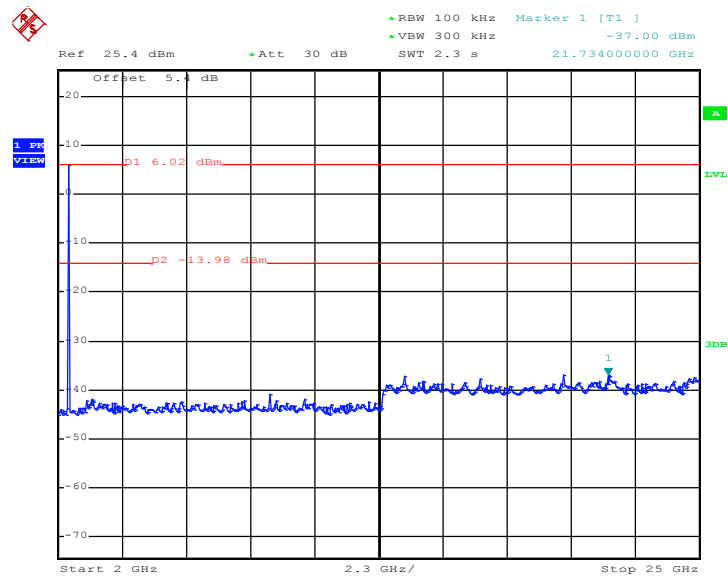

Date: 28.DEC.2017 00:43:50



Test Mode :	2Mbps	Temperature :	21~25°C
Test Channel :	39	Relative Humidity :	51~55%
		Test Engineer :	Silent Hai

2Mbps CSE Plot on Ch 39 between 30MHz ~ 3 GHz

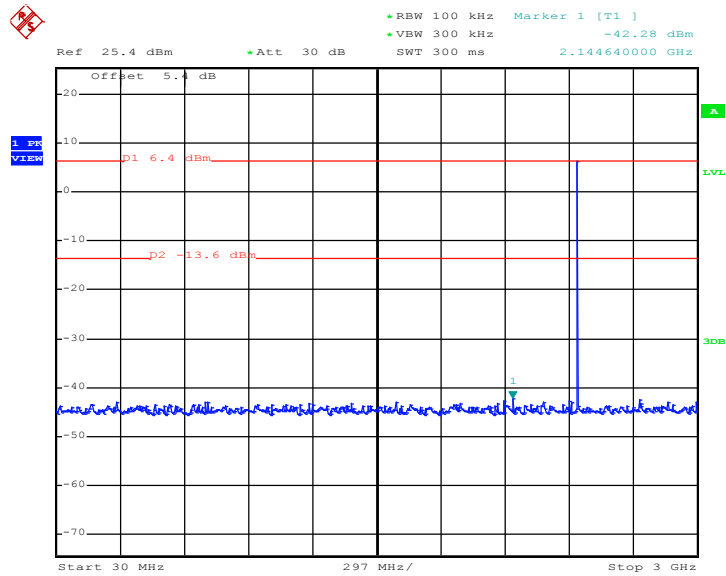

Date: 28.DEC.2017 00:47:32

2Mbps CSE Plot on Ch 39 between 2 GHz ~ 25 GHz

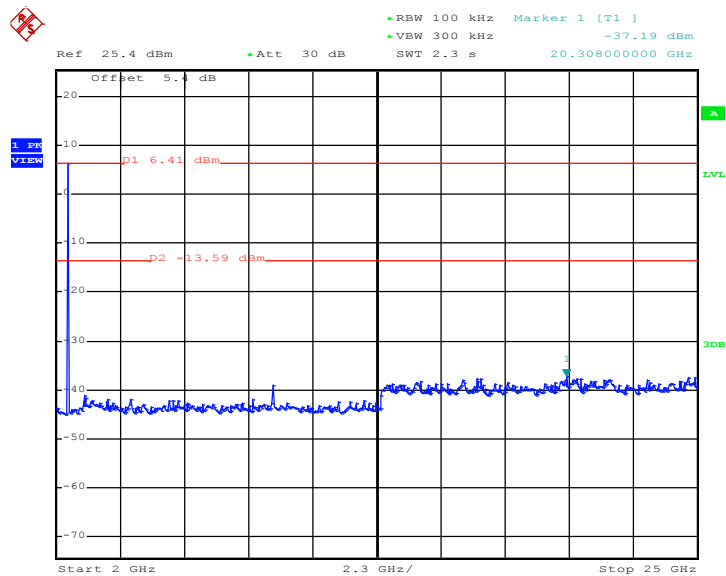

Date: 28.DEC.2017 00:49:04



Test Mode :	2Mbps	Temperature :	21~25°C
Test Channel :	78	Relative Humidity :	51~55%
		Test Engineer :	Silent Hai

2Mbps CSE Plot on Ch 78 between 30MHz ~ 3 GHz

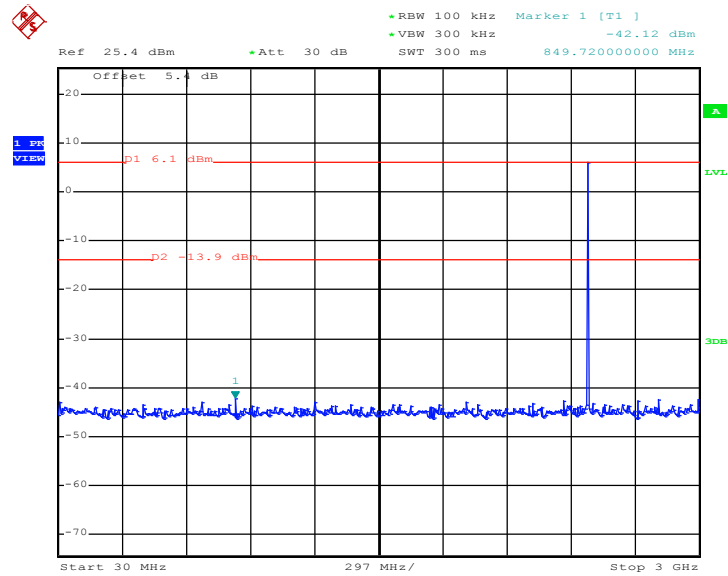

Date: 28.DEC.2017 00:56:52

2Mbps CSE Plot on Ch 78 between 2 GHz ~ 25 GHz

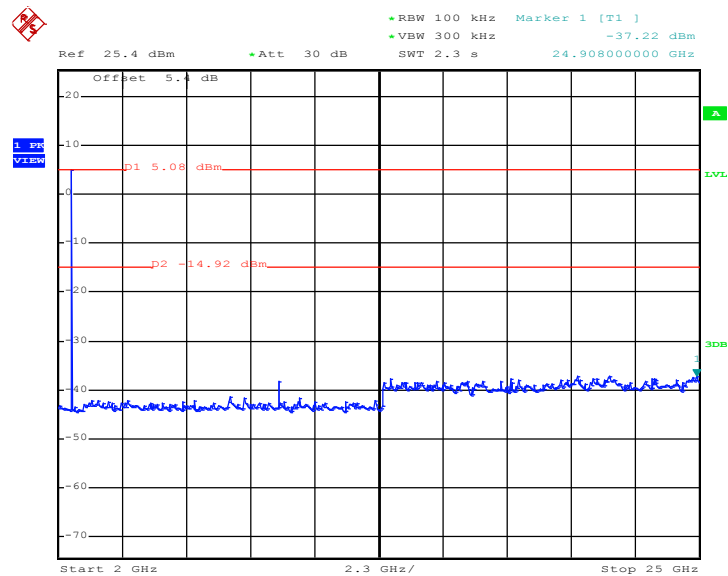

Date: 28.DEC.2017 00:56:13



Test Mode :	3Mbps	Temperature :	21~25°C
Test Channel :	00	Relative Humidity :	51~55%
		Test Engineer :	Silent Hai

3Mbps CSE Plot on Ch 00 between 30MHz ~ 3 GHz

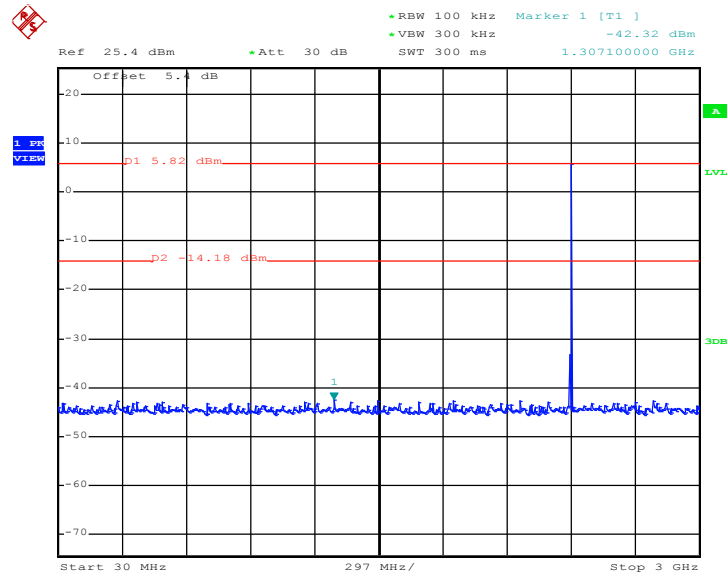

Date: 28.DEC.2017 01:02:23

3Mbps CSE Plot on Ch 00 between 2 GHz ~ 25 GHz

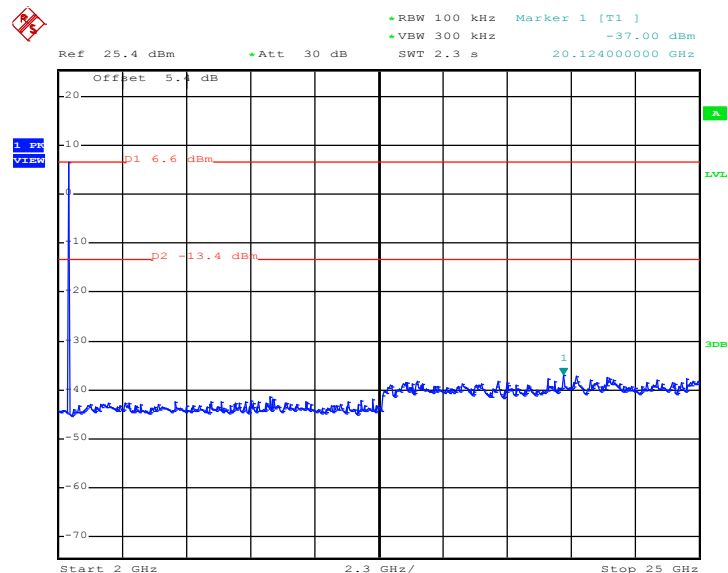

Date: 28.DEC.2017 01:02:45



Test Mode :	3Mbps	Temperature :	21~25°C
Test Channel :	39	Relative Humidity :	51~55%
		Test Engineer :	Silent Hai

3Mbps CSE Plot on Ch 39 between 30MHz ~ 3 GHz

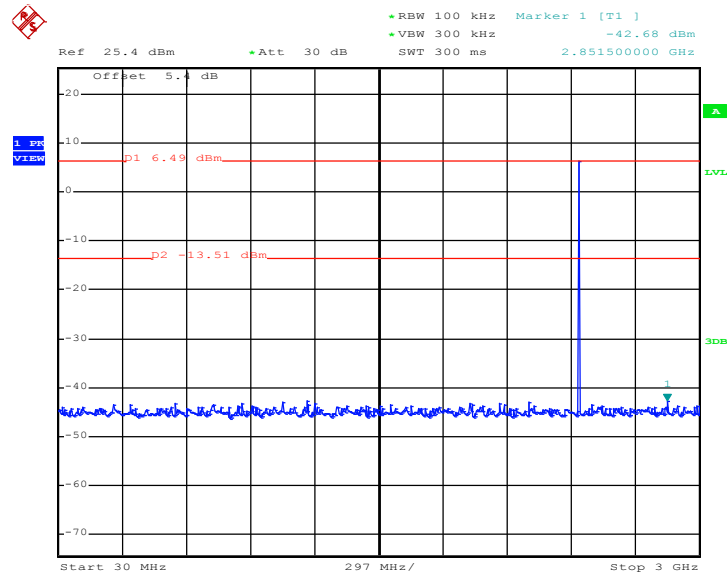

Date: 28.DEC.2017 01:07:58

3Mbps CSE Plot on Ch 39 between 2 GHz ~ 25 GHz

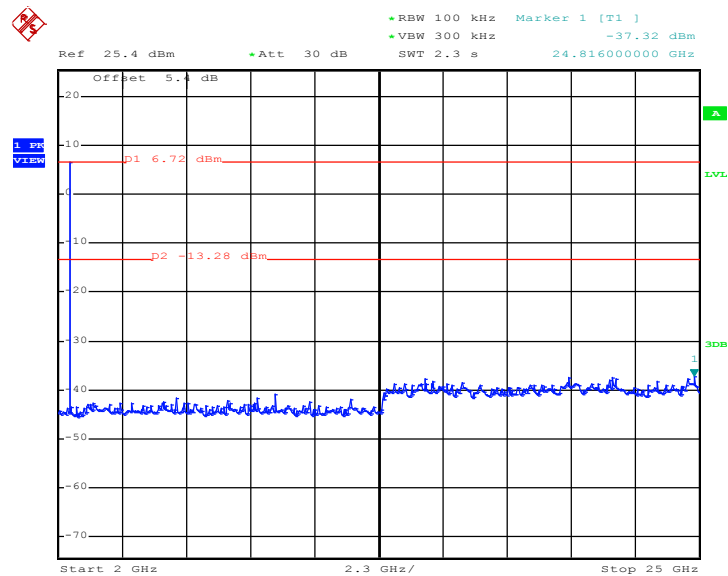

Date: 28.DEC.2017 01:07:19



Test Mode :	3Mbps	Temperature :	21~25°C
Test Channel :	78	Relative Humidity :	51~55%
		Test Engineer :	Silent Hai

3Mbps CSE Plot on Ch 78 between 30MHz ~ 3 GHz

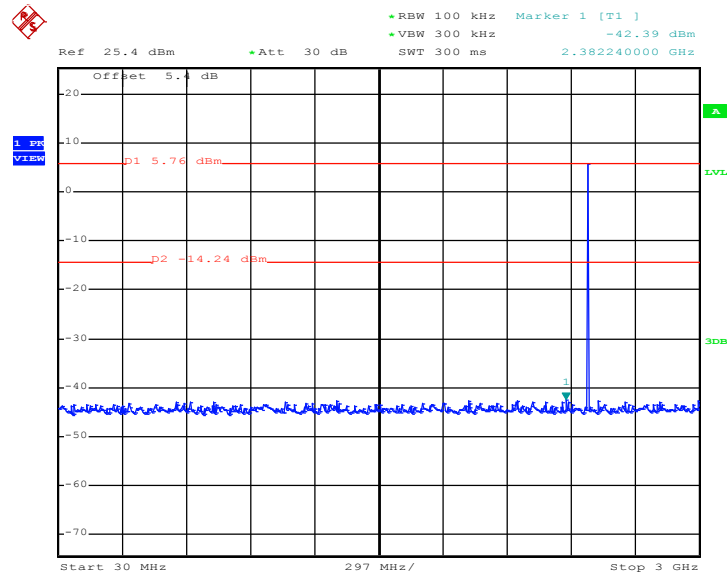

Date: 28.DEC.2017 01:13:08

3Mbps CSE Plot on Ch 78 between 2 GHz ~ 25 GHz

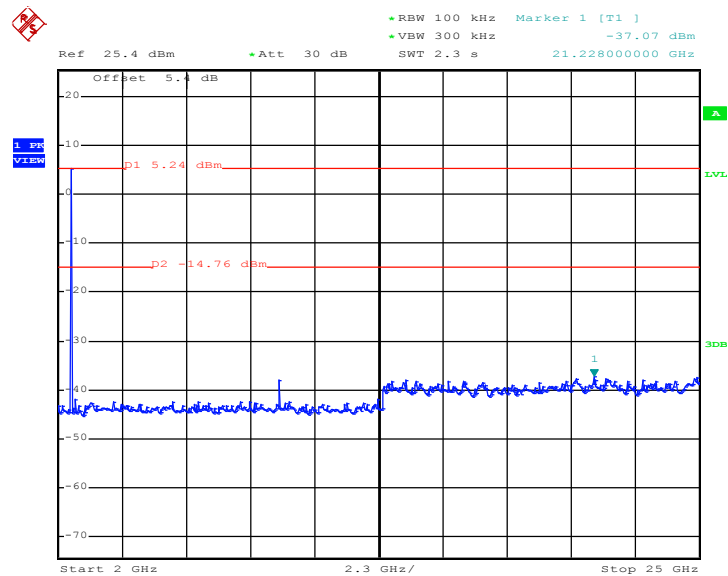

Date: 28.DEC.2017 01:13:30



3.8 Radiated Band Edges and Spurious Emission Measurement

3.8.1 Limit of Radiated Band Edges and Spurious Emission

In any 100 kHz bandwidth outside the intentional radiator frequency band, all harmonics/spurious must be at least 20 dB below the highest emission level within the authorized band. In addition, radiated emissions which fall in the restricted bands must also comply with the limits as below.

Frequency (MHz)	Field Strength (microvolts/meter)	Measurement Distance (meters)
0.009 – 0.490	2400/F(kHz)	300
0.490 – 1.705	24000/F(kHz)	30
1.705 – 30.0	30	30
30 – 88	100	3
88 – 216	150	3
216 - 960	200	3
Above 960	500	3

3.8.2 Measuring Instruments

The measuring equipment is listed in the section 4 of this test report.



3.8.3 Test Procedures

1. The EUT was placed on a turntable with 0.8 meter for frequency below 1GHz and 1.5 meter for frequency above 1GHz respectively above ground.
2. The EUT was set 3 meters from the interference receiving antenna, which was mounted on the top of a variable height antenna tower.
3. For each suspected emission, the EUT was arranged to its worst case and then tune the Antenna tower (from 1 m to 4 m) and turntable (from 0 degree to 360 degrees) to find the maximum reading. A pre-amp and a high pass filter are used for the test in order to get better signal level to comply with the guidelines.
4. Set to the maximum power setting and enable the EUT transmit continuously.
5. Use the following spectrum analyzer settings:
 - (1) Span shall wide enough to fully capture the emission being measured;
 - (2) Set RBW=100 kHz for $f < 1 \text{ GHz}$, RBW=1MHz for $f > 1\text{GHz}$; VBW \geq RBW; Sweep = auto; Detector function = peak; Trace = max hold for peak
 - (3) For average measurement: use duty cycle correction factor method per 15.35(c).
Duty cycle = On time/100 milliseconds
On time = $N_1 * L_1 + N_2 * L_2 + \dots + N_{n-1} * L_{n-1} + N_n * L_n$
Where N_1 is number of type 1 pulses, L_1 is length of type 1 pulses, etc.
Average Emission Level = Peak Emission Level + $20 * \log(\text{Duty cycle})$
6. Corrected Reading: Antenna Factor + Cable Loss + Read Level - Preamp Factor = Level

Note: The average levels were calculated from the peak level corrected with duty cycle correction factor (-24.76dB) derived from $20 \log(\text{dwell time}/100\text{ms})$. This correction is only for signals that hop with the fundamental signal, such as band-edge and harmonic. Other spurious signals that are independent of the hopping signal would not use this correction.

3.8.4 Test Setup

For radiated emissions below 30MHz

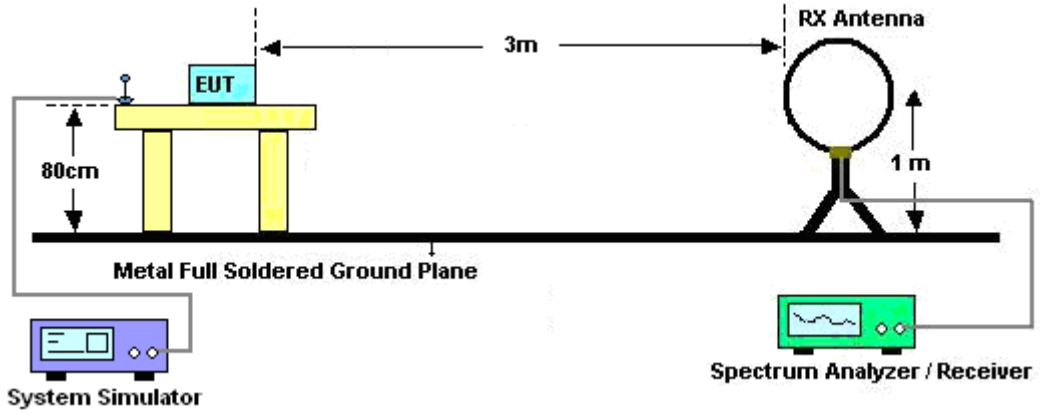

For radiated emissions from 30MHz to 1GHz

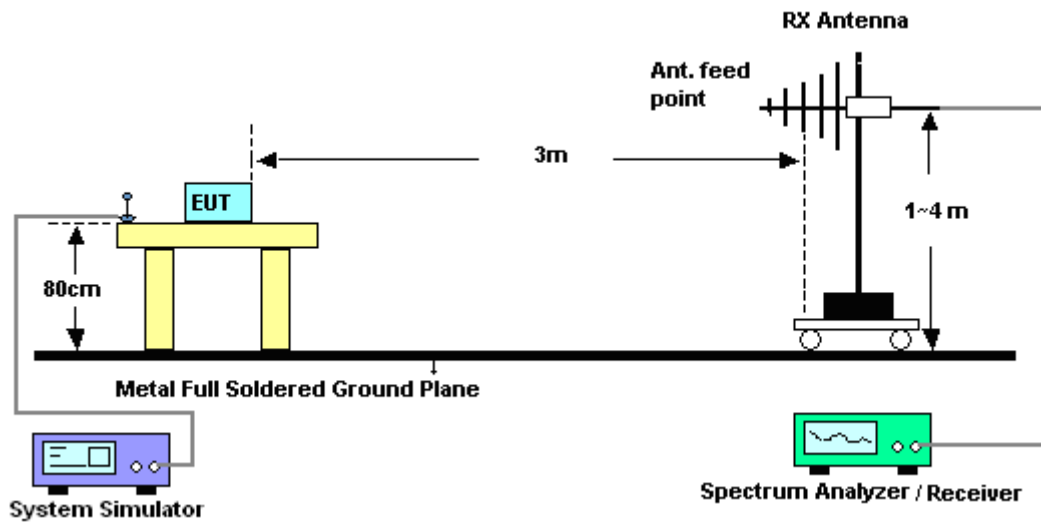

For radiated emissions above 1GHz

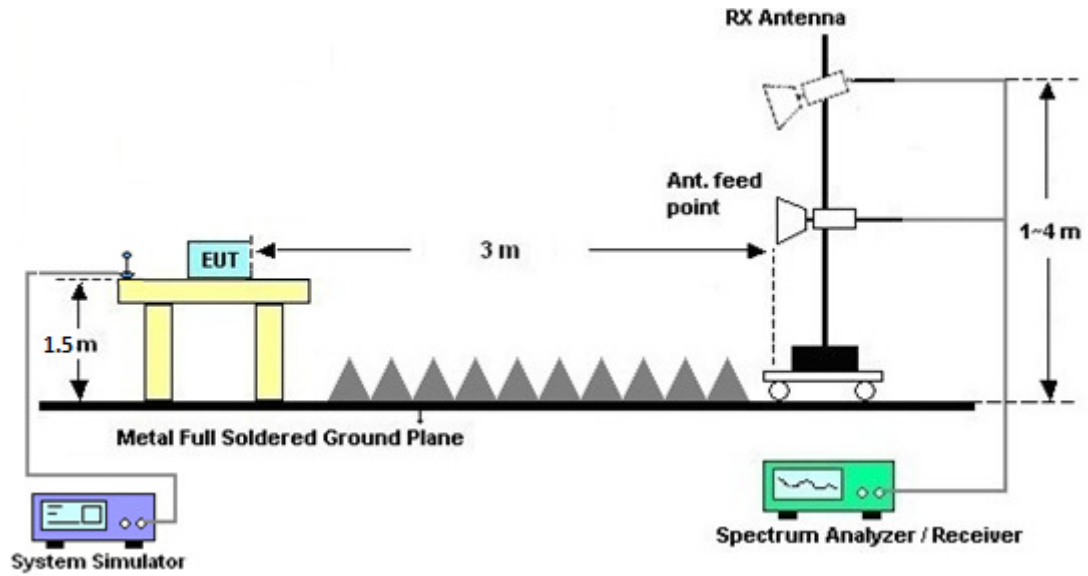

3.8.5 Test Results of Radiated Spurious Emissions (9 kHz ~ 30 MHz)

The low frequency, which started from 9 kHz to 30MHz, was pre-scanned and the result which was 20dB lower than the limit line was not reported.



3.8.6 Duty cycle correction factor for average measurement

3DH5 on time (One Pulse) Plot on Channel 39

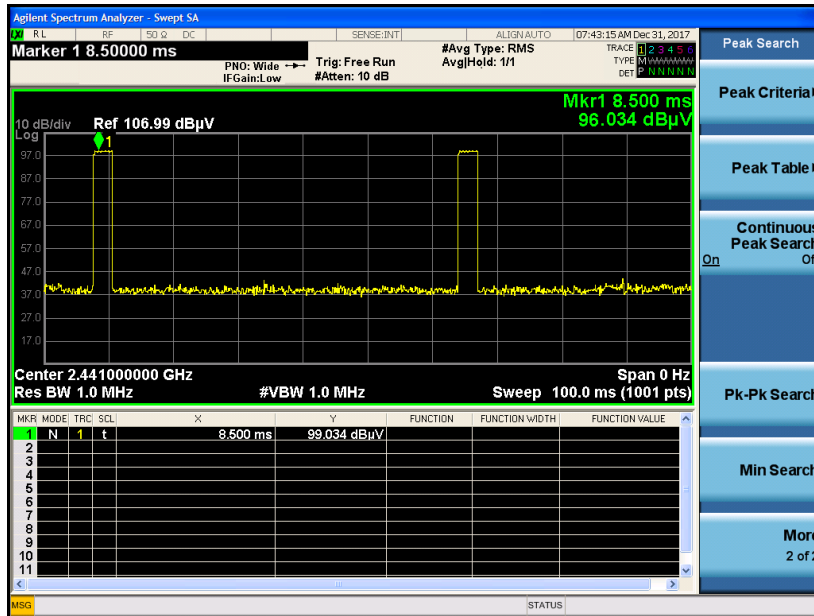

3DH5 on time (Count Pulses) Plot on Channel 39

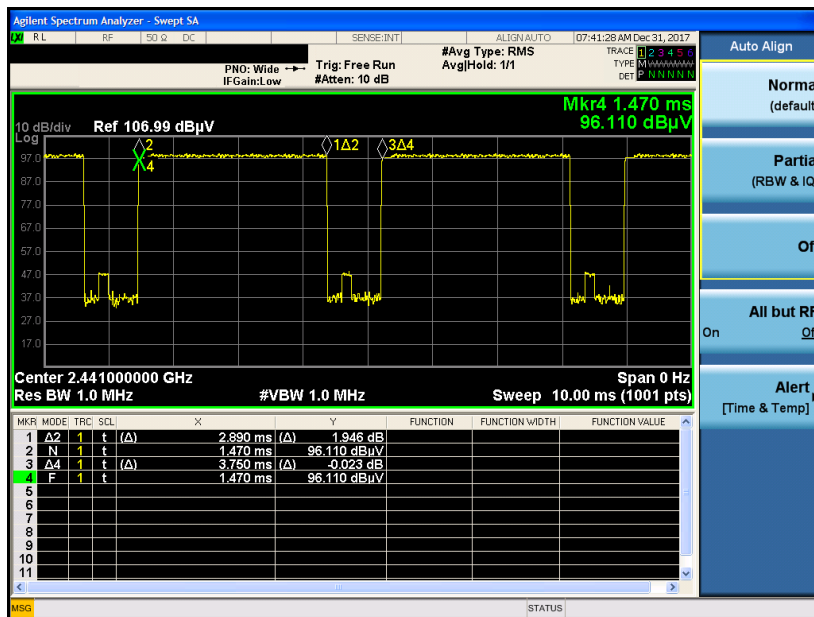

Note:

1. Worst case Duty cycle = on time/100 milliseconds = 2 * 2.89 / 100 = 5.78 %
2. Worst case Duty cycle correction factor = 20*log(Duty cycle) = -24.76 dB
3. 3DH5 has the highest duty cycle worst case and is reported.



Duty Cycle Correction Factor Consideration for AFH mode:

Bluetooth normal hopping rate is 1600Hz and reduced to 800Hz in AFH mode; due to the reduced number of hopping frequencies, with the same packet configuration the dwell time in each channel frequency within 100msec period is longer in AFH mode than normal mode.

In AFH mode, the minimum hopping frequencies are 20, to get the longest dwell time DH5 packet is observed; the period to have DH5 packet completing one hopping sequence is

$$2.89 \text{ ms} \times 20 \text{ channels} = 57.8 \text{ ms}$$

There cannot be 2 complete hopping sequences within 100ms period, considering the random hopping behavior, maximum 2 hops can be possibly observed within the period. $[100\text{ms} / 57.8\text{ms}] = 2 \text{ hops}$

Thus, the maximum possible ON time:

$$2.89 \text{ ms} \times 2 = 5.78 \text{ ms}$$

Worst case Duty Cycle Correction factor, which is derived from the maximum possible ON time,

$$20 \times \log(5.78 \text{ ms}/100\text{ms}) = -24.76 \text{ dB}$$

3.8.7 Test Result of Radiated Spurious at Band Edges

Please refer to Appendix A.

3.8.8 Test Result of Radiated Spurious Emission (30MHz ~ 10th Harmonic)

Please refer to Appendix A.



3.9 AC Conducted Emission Measurement

3.9.1 Limit of AC Conducted Emission

For equipment that is designed to be connected to the public utility (AC) power line, the radio frequency voltage that is conducted back onto the AC power line on any frequency or frequencies within the band 150 kHz to 30 MHz shall not exceed the limits in the following table.

Frequency of emission (MHz)	Conducted limit (dBµV)	
	Quasi-peak	Average
0.15-0.5	66 to 56*	56 to 46*
0.5-5	56	46
5-30	60	50

*Decreases with the logarithm of the frequency.

3.9.2 Measuring Instruments

The measuring equipment is listed in the section 4 of this test report.

3.9.3 Test Procedures

1. The EUT was placed 0.4 meter from the conducting wall of the shielding room was kept at least 80 centimeters from any other grounded conducting surface.
2. Connect EUT to the power mains through a line impedance stabilization network (LISN).
3. All the support units are connecting to the other LISN.
4. The LISN provides 50 ohm coupling impedance for the measuring instrument.
5. The FCC states that a 50 ohm, 50 microhenry LISN should be used.
6. Both sides of AC line were checked for maximum conducted interference.
7. The frequency range from 150 kHz to 30 MHz was searched.
8. Set the test-receiver system to Peak Detect Function and specified bandwidth (IF Bandwidth = 9kHz) with Maximum Hold Mode. Then measurement is also conducted by Average Detector and Quasi-Peak Detector Function respectively.

3.9.4 Test Setup

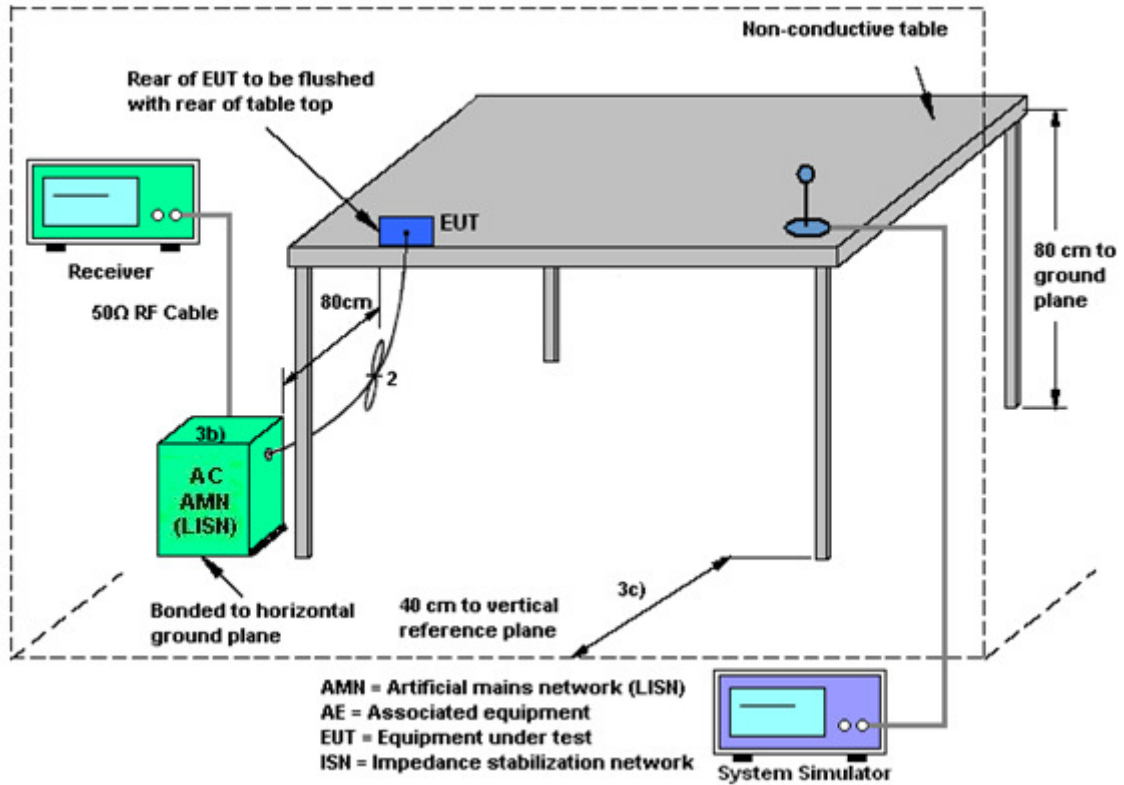



3.9.5 Test Result of AC Conducted Emission

Test Mode :	Mode 1	Temperature :	22~24°C
Test Engineer :	Amos Zhang	Relative Humidity :	42~46%
Test Voltage :	120Vac / 60Hz	Phase :	Line
Function Type :	GSM850 Idle + Bluetooth Link + WLAN Link(2.4G) + Earphone + USB Cable (Charging from Adapter 1) for Sample 1		

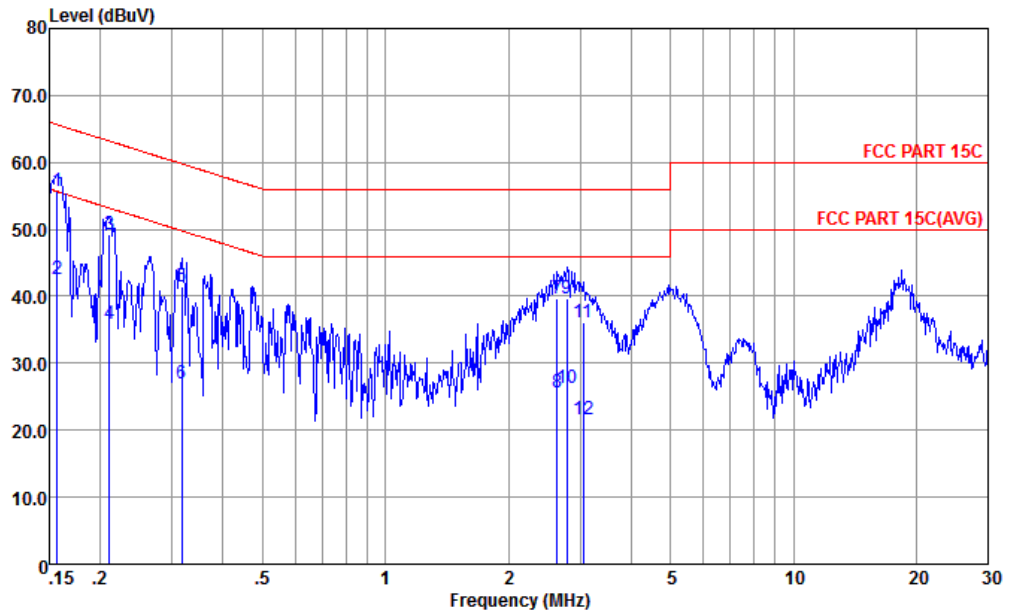

Site : CO01-KS
 Condition : FCC PART 15C LISN-L-171013-060103 LINE
 mode : Mode 1
 : 351878090028931/351878090028949 #9

	Freq	Level	Over Limit	Limit Line	Read Level	LISN Factor	Cable Loss	Remark
	MHz	dBuV	dB	dBuV	dBuV	dB	dB	
1 *	0.156	55.66	-9.99	65.65	44.90	0.17	10.59	QP
2	0.156	42.66	-12.99	55.65	31.90	0.17	10.59	Average
3	0.211	49.26	-13.92	63.18	38.61	0.20	10.45	QP
4	0.211	35.86	-17.32	53.18	25.21	0.20	10.45	Average
5	0.317	41.55	-18.25	59.80	30.90	0.23	10.42	QP
6	0.317	26.95	-22.85	49.80	16.30	0.23	10.42	Average
7	2.636	39.70	-16.30	56.00	29.20	0.31	10.19	QP
8	2.636	25.70	-20.30	46.00	15.20	0.31	10.19	Average
9	2.779	39.70	-16.30	56.00	29.20	0.31	10.19	QP
10	2.779	26.40	-19.60	46.00	15.90	0.31	10.19	Average
11	3.058	36.01	-19.99	56.00	25.51	0.32	10.18	QP
12	3.058	21.71	-24.29	46.00	11.21	0.32	10.18	Average



Test Mode :	Mode 1	Temperature :	22~24°C
Test Engineer :	Amos Zhang	Relative Humidity :	42~46%
Test Voltage :	120Vac / 60Hz	Phase :	Neutral
Function Type :	GSM850 Idle + Bluetooth Link + WLAN Link(2.4G) + Earphone + USB Cable (Charging from Adapter 1) for Sample 1		

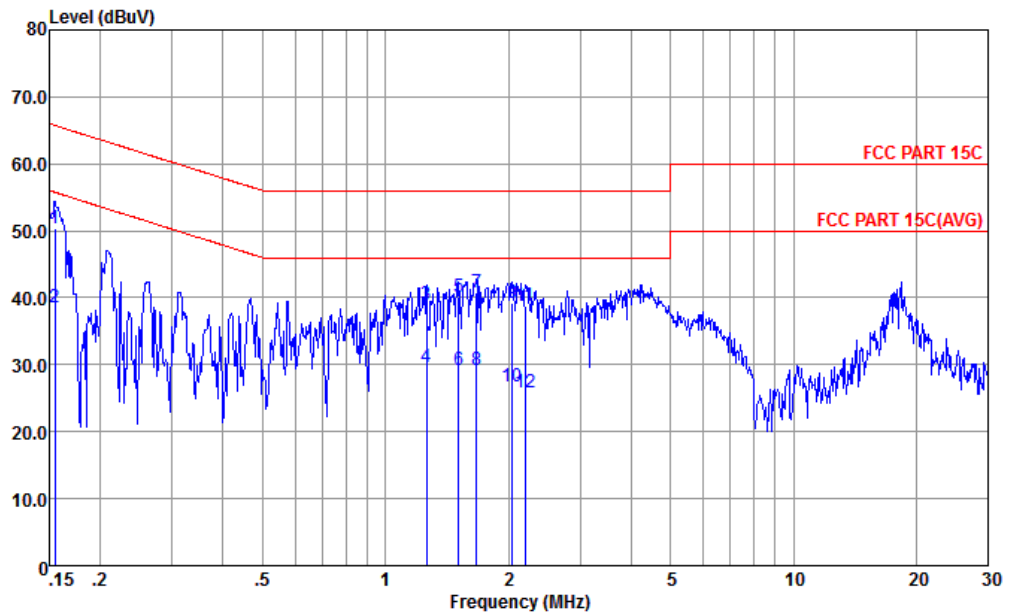

Site : CO01-KS
Condition : FCC PART 15C LISN-N-171013-060103 NEUTRAL

mode : Mode 1
: 351878090028931/351878090028949 #9

	Freq	Level	Over Limit	Limit Line	Read Level	LISN Factor	Cable Loss	Remark
	MHz	dBuV	dB	dBuV	dBuV	dB	dB	
1	0.155	50.38	-15.36	65.74	39.50	0.28	10.60	QP
2	0.155	38.48	-17.26	55.74	27.60	0.28	10.60	Average
3	1.262	39.06	-16.94	56.00	28.61	0.31	10.14	QP
4	1.262	29.66	-16.34	46.00	19.21	0.31	10.14	Average
5	1.511	40.09	-15.91	56.00	29.60	0.32	10.17	QP
6	1.511	29.09	-16.91	46.00	18.60	0.32	10.17	Average
7 *	1.671	40.70	-15.30	56.00	30.19	0.32	10.19	QP
8	1.671	29.10	-16.90	46.00	18.59	0.32	10.19	Average
9	2.044	39.13	-16.87	56.00	28.60	0.32	10.21	QP
10	2.044	26.83	-19.17	46.00	16.30	0.32	10.21	Average
11	2.201	38.83	-17.17	56.00	28.30	0.32	10.21	QP
12	2.201	25.83	-20.17	46.00	15.30	0.32	10.21	Average



3.10 Antenna Requirements

3.10.1 Standard Applicable

If directional gain of transmitting antennas is greater than 6dBi, the power shall be reduced by the same level in dB comparing to gain minus 6dBi. The use of a permanently attached antenna or of an antenna that uses a unique coupling to the intentional radiator shall be considered sufficient to comply with the rule.

3.10.2 Antenna Anti-Replacement Construction

An embedded-in antenna design is used.

3.10.3 Antenna Gain

The antenna peak gain of EUT is less than 6 dBi. Therefore, it is not necessary to reduce maximum peak output power limit.



4 List of Measuring Equipment

Instrument	Manufacturer	Model No.	Serial No.	Characteristics	Calibration Date	Test Date	Due Date	Remark
Spectrum Analyzer	R&S	FSV40	101040	10Hz~40GHz	Aug. 08, 2017	Dec. 26, 2017~ Dec. 28, 2017	Aug. 07, 2018	Conducted (TH01-KS)
Spectrum Analyzer	R&S	FSP40	100319	9kHz~40GHz	Oct. 12, 2017	Dec. 26, 2017~ Dec. 28, 2017	Oct. 11, 2018	Conducted (TH01-KS)
Pulse Power Sensor	Anritsu	MA2411B	0917070	300MHz~40GHz	Jan. 19, 2017	Dec. 26, 2017~ Dec. 28, 2017	Jan. 18, 2018	Conducted (TH01-KS)
Power Meter	Anritsu	ML2495A	1005002	50MHz Bandwidth	Jan. 19, 2017	Dec. 26, 2017~ Dec. 28, 2017	Jan. 18, 2018	Conducted (TH01-KS)
Amplifier	MITEQ	TTA1840-35-HG	1871923	18GHz~40GHz, VSWR : 2.5:1 max	Jul. 18, 2017	Dec. 31, 2017	Jul. 17, 2018	Radiation (03CH12-HY)
Bilog Antenna	TESEQ	CBL 6111D&00800 N1D01N-06	35413&02	30MHz~1GHz	Dec. 18, 2017	Dec. 31, 2017	Dec. 17, 2018	Radiation (03CH12-HY)
Loop Antenna	Rohde & Schwarz	HFH2-Z2	100488	9 kHz~30 MHz	Nov. 23, 2017	Dec. 31, 2017	Nov. 22, 2018	Radiation (03CH12-HY)
Horn Antenna	SCHWARZBECK	BBHA 9120D	9120D-1328	1GHz ~ 18GHz	Oct. 20, 2017	Dec. 31, 2017	Oct. 19, 2018	Radiation (03CH12-HY)
Preamplifier	MITEQ	AMF-7D-00101800	2025787	1GHZ~18GHZ	Feb. 13, 2017	Dec. 31, 2017	Feb. 12, 2018	Radiation (03CH12-HY)
Preamplifier	COM-POWER	PA-103	161075	10MHz~1GHz	Mar. 23, 2017	Dec. 31, 2017	Mar. 22, 2018	Radiation (03CH12-HY)
Preamplifier	Keysight	83017A	MY53270148	1GHz~26.5GHz	Jan. 12, 2017	Dec. 31, 2017	Jan. 11, 2018	Radiation (03CH12-HY)
SHF-EHF Horn Antenna	SCHWARZBECK	BBHA 9170	BBHA9170576	18GHz ~ 40GHz	Apr. 27, 2017	Dec. 31, 2017	Apr. 26, 2018	Radiation (03CH12-HY)
Spectrum Analyzer	Agilent	N9030A	MY52350276	3Hz~44GHz	Mar. 23, 2017	Dec. 31, 2017	Mar. 22, 2018	Radiation (03CH12-HY)
Controller	EMEC	EM1000	N/A	Control Turn table & Ant Mast	NCR	Dec. 31, 2017	NCR	Radiation (03CH12-HY)
Antenna Mast	EMEC	AM-BS-4500-B	N/A	1m~4m	NCR	Dec. 31, 2017	NCR	Radiation (03CH12-HY)
Turn Table	EMEC	TT2000	N/A	0~360 Degree	NCR	Dec. 31, 2017	NCR	Radiation (03CH12-HY)
EMI Receiver	R&S	ESCi7	100768	9kHz~7GHz;	Apr. 20, 2017	Jan. 02, 2018	Apr. 19, 2018	Conduction (CO01-KS)
AC LISN	MessTec	AN3016	060103	9kHz~30MHz	Oct. 13, 2017	Jan. 02, 2018	Oct. 12, 2018	Conduction (CO01-KS)
AC LISN (for auxiliary equipment)	MessTec	AN3016	060105	9kHz~30MHz	Oct. 13, 2017	Jan. 02, 2018	Oct. 12, 2018	Conduction (CO01-KS)
AC Power Source	Chroma	61602	ABP00000811	AC 0V~300V, 45Hz~1000Hz	Oct. 12, 2017	Jan. 02, 2018	Oct. 11, 2018	Conduction (CO01-KS)

NCR: No Calibration Required



5 Uncertainty of Evaluation

Uncertainty of Conducted Emission Measurement (150 kHz ~ 30 MHz)

Measuring Uncertainty for a Level of Confidence of 95% ($U = 2Uc(y)$)	2.3dB
---	-------

Uncertainty of Radiated Emission Measurement (30 MHz ~ 1000 MHz)

Measuring Uncertainty for a Level of Confidence of 95% ($U = 2Uc(y)$)	5.1 dB
---	--------

Uncertainty of Radiated Emission Measurement (1000 MHz ~ 18000 MHz)

Measuring Uncertainty for a Level of Confidence of 95% ($U = 2Uc(y)$)	5.2 dB
---	--------

Uncertainty of Radiated Emission Measurement (18000 MHz ~ 40000 MHz)

Measuring Uncertainty for a Level of Confidence of 95% ($U = 2Uc(y)$)	4.7 dB
---	--------



Appendix A. Radiated Spurious Emission

2.4GHz 2400~2483.5MHz

BT (Band Edge @ 3m)

BT	Note	Frequency	Level	Over Limit	Limit Line	Read Level	Antenna Factor	Cable Loss	Preamp Factor	Ant Pos	Table Pos	Peak Avg.	Pol.
		(MHz)	(dBμV/m)	(dB)	(dBμV/m)	(dBμV)	(dB/m)	(dB)	(dB)	(cm)	(deg)	(P/A)	(H/V)
BT CH00 2402MHz		2342.2	41.09	-32.91	74	41.56	27.03	4	31.5	100	134	P	H
		2342.2	16.33	-37.67	54	-	-	-	-	-	-	A	H
	*	2402	98.18	-	-	98.48	27.15	4.04	31.49	100	134	P	H
	*	2402	73.42	-	-	-	-	-	-	-	-	A	H
		2331	41.32	-32.68	74	41.86	26.99	3.98	31.51	155	309	P	V
		2331	16.56	-37.44	54	-	-	-	-	-	-	A	V
	*	2402	103.36	-	-	103.66	27.15	4.04	31.49	155	309	P	V
	*	2402	78.6	-	-	-	-	-	-	-	-	A	V
BT CH 39 2441MHz		2322.32	40.78	-33.22	74	41.32	26.99	3.98	31.51	100	139	P	H
		2322.32	16.02	-37.98	54	-	-	-	-	-	-	A	H
	*	2441	100.46	-	-	100.58	27.28	4.07	31.47	100	139	P	H
	*	2441	75.7	-	-	-	-	-	-	-	-	A	H
		2484.46	41.42	-32.58	74	41.42	27.36	4.11	31.47	100	139	P	H
		2484.46	16.66	-37.34	54	-	-	-	-	-	-	A	H
		2314.76	41.2	-32.8	74	41.8	26.94	3.97	31.51	336	302	P	V
		2314.76	16.44	-37.56	54	-	-	-	-	-	-	A	V
	*	2441	104.56	-	-	104.68	27.28	4.07	31.47	336	302	P	V
	*	2441	79.8	-	-	-	-	-	-	-	-	A	V
		2489.29	40.86	-33.14	74	40.82	27.4	4.11	31.47	336	302	P	V
	2489.29	16.1	-37.9	54	-	-	-	-	-	-	A	V	



BT CH 78 2480MHz	*	2480	98.32	-	-	98.34	27.36	4.09	31.47	100	58	P	H
	*	2480	73.56	-	-	-	-	-	-	-	-	A	H
		2483.52	45.19	-28.81	74	45.19	27.36	4.11	31.47	100	58	P	H
		2483.52	20.43	-33.57	54	-	-	-	-	-	-	A	H
	*	2480	103.56	-	-	103.58	27.36	4.09	31.47	142	332	P	V
	*	2480	78.8	-	-	-	-	-	-	-	-	A	V
		2483.56	48.6	-25.4	74	48.6	27.36	4.11	31.47	142	332	P	V
		2483.56	23.84	-30.16	54	-	-	-	-	-	-	A	V
Remark	<ol style="list-style-type: none"> No other spurious found. All results are PASS against Peak and Average limit line. 												



2.4GHz 2400~2483.5MHz

BT (Harmonic @ 3m)

BT	Note	Frequency (MHz)	Level (dBμV/m)	Over Limit (dB)	Limit Line (dBμV/m)	Read Level (dBμV)	Antenna Factor (dB/m)	Cable Loss (dB)	Preamp Factor (dB)	Ant Pos (cm)	Table Pos (deg)	Peak Avg. (P/A)	Pol. (H/V)
BT CH 00 2402MHz		4804	46.04	-27.96	74	72.77	31.32	6.16	64.75	100	0	P	H
		4804	21.28	-32.72	54	-	-	-	-	-	-	A	H
		12010	52.82	-21.18	74	68.66	38.88	10.09	65.2	100	0	P	H
		12010	28.06	-25.94	54	-	-	-	-	-	-	A	H
		4804	44.87	-29.13	74	71.6	31.32	6.16	64.75	100	0	P	V
		4804	20.11	-33.89	54	-	-	-	-	-	-	A	V
		12010	51.58	-22.42	74	67.42	38.88	10.09	65.2	100	0	P	V
		12010	26.82	-27.18	54	-	-	-	-	-	-	A	V
BT CH 39 2441MHz		4882	42.87	-31.13	74	69.38	31.46	6.21	64.7	100	0	P	H
		4882	18.11	-35.89	54	-	-	-	-	-	-	A	H
		7323	43.49	-30.51	74	64.11	36.15	7.72	64.83	100	0	P	H
		7323	18.73	-35.27	54	-	-	-	-	-	-	A	H
		12205	53.05	-20.95	74	69.04	38.69	10.17	65.24	100	0	P	H
		12205	28.29	-25.71	54	-	-	-	-	-	-	A	H
		4882	41.58	-32.42	74	68.09	31.46	6.21	64.7	100	0	P	V
		4882	16.82	-37.18	54	-	-	-	-	-	-	A	V
		7323	44.56	-29.44	74	65.18	36.15	7.72	64.83	100	0	P	V
		7323	19.8	-34.2	54	-	-	-	-	-	-	A	V
		12205	51.1	-22.9	74	67.09	38.69	10.17	65.24	100	0	P	V
		12205	26.34	-27.66	54	-	-	-	-	-	-	A	V
BT CH 78 2480MHz		4960	40.31	-33.69	74	66.56	31.63	6.26	64.63	100	0	P	H
		4960	15.55	-38.45	54	-	-	-	-	-	-	A	H
		7440	43.51	-30.49	74	63.85	36.47	7.75	64.88	100	0	P	H
		7440	18.75	-35.25	54	-	-	-	-	-	-	A	H
		12400	50.76	-23.24	74	66.91	38.49	10.24	65.28	100	0	P	H
		12400	26	-28	54	-	-	-	-	-	-	A	H
		4960	38.76	-35.24	74	65.01	31.63	6.26	64.63	100	0	P	V
		4960	14	-40	54	-	-	-	-	-	-	A	V
	7440	42.64	-31.36	74	62.98	36.47	7.75	64.88	100	0	P	V	



		7440	17.88	-36.12	54	-	-	-	-	-	-	A	V
		12400	51.22	-22.78	74	67.37	38.49	10.24	65.28	100	0	P	V
		12400	26.46	-27.54	54	-	-	-	-	-	-	A	V
Remark	1. No other spurious found. 2. All results are PASS against Peak and Average limit line.												



Emission below 1GHz

2.4GHz BT (LF)

BT	Note	Frequency	Level	Over	Limit	Read	Antenna	Cable	Preamp	Ant	Table	Peak	Pol.
		(MHz)	(dBμV/m)	(dB)	(dBμV/m)	(dBμV)	(dB/m)	(dB)	(dB)	(cm)	(deg)	(P/A)	(H/V)
2.4GHz BT LF		30.81	22.81	-17.19	40	28.48	24.05	0.48	30.19	-	-	P	H
		71.58	19.96	-20.04	40	37.21	12.48	0.68	30.43	-	-	P	H
		256.53	20.26	-25.74	46	29.55	19.48	1.32	30.2	-	-	P	H
		559.7	28.68	-17.32	46	30.29	25.95	1.9	29.71	-	-	P	H
		746.6	35.88	-10.12	46	34.94	27.87	2.21	29.44	100	0	P	H
		962.2	33.76	-20.24	54	28.93	30.93	2.51	29.04	-	-	P	H
		60.78	30.29	-9.71	40	48.25	11.77	0.68	30.44	-	-	P	V
		234.12	25.15	-20.85	46	37.53	16.52	1.23	30.23	-	-	P	V
		288.93	22.33	-23.67	46	32.01	18.99	1.35	30.15	-	-	P	V
		510.7	36.63	-9.37	46	40.4	23.94	1.83	29.78	-	-	P	V
		555.5	36.05	-9.95	46	38.14	25.48	1.9	29.72	-	-	P	V
	747.3	36.99	-9.01	46	36.05	27.87	2.21	29.44	100	0	P	V	
Remark	1. No other spurious found. 2. All results are PASS against limit line.												



Note symbol

*	Fundamental Frequency which can be ignored. However, the level of any unwanted emissions shall not exceed the level of the fundamental frequency.
!	Test result is over limit line.
P/A	Peak or Average
H/V	Horizontal or Vertical



A calculation example for radiated spurious emission is shown as below:

WIFI	Note	Frequency	Level	Over	Limit	Read	Antenna	Cable	Preamp	Ant	Table	Peak	Pol.
Ant.				Limit	Line	Level	Factor	Loss	Factor	Pos	Pos	Avg.	
1+2		(MHz)	(dBμV/m)	(dB)	(dBμV/m)	(dBμV)	(dB/m)	(dB)	(dB)	(cm)	(deg)	(P/A)	(H/V)
802.11b		2390	55.45	-18.55	74	54.51	32.22	4.58	35.86	103	308	P	H
CH 01													
2412MHz		2390	43.54	-10.46	54	42.6	32.22	4.58	35.86	103	308	A	H

- Level(dBμV/m) =
Antenna Factor(dB/m) + Cable Loss(dB) + Read Level(dBμV) - Preamp Factor(dB)
- Over Limit(dB) = Level(dBμV/m) – Limit Line(dBμV/m)

For Peak Limit @ 2390MHz:

- Level(dBμV/m)
= Antenna Factor(dB/m) + Cable Loss(dB) + Read Level(dBμV) - Preamp Factor(dB)
= 32.22(dB/m) + 4.58(dB) + 54.51(dBμV) – 35.86 (dB)
= 55.45 (dBμV/m)
- Over Limit(dB)
= Level(dBμV/m) – Limit Line(dBμV/m)
= 55.45(dBμV/m) – 74(dBμV/m)
= -18.55(dB)

For Average Limit @ 2390MHz:

- Level(dBμV/m)
= Antenna Factor(dB/m) + Cable Loss(dB) + Read Level(dBμV) - Preamp Factor(dB)
= 32.22(dB/m) + 4.58(dB) + 42.6(dBμV) – 35.86 (dB)
= 43.54 (dBμV/m)
- Over Limit(dB)
= Level(dBμV/m) – Limit Line(dBμV/m)
= 43.54(dBμV/m) – 54(dBμV/m)
= -10.46(dB)

Both peak and average measured complies with the limit line, so test result is “PASS”.