



FCC RF Test Report

APPLICANT : Motorola Mobility LLC
EQUIPMENT : Mobile Cellular Phone
BRAND NAME : Motorola
MODEL NAME : XT1924-3
FCC ID : IHDT56XA6
STANDARD : 47 CFR Part 2, 22(H), 27(M)
CLASSIFICATION : PCS Licensed Transmitter Held to Ear (PCE)

The product was received on Dec. 22, 2017 and completely tested on Jan. 25, 2018. We, Sporton International (Kunshan) Inc., would like to declare that the tested sample has been evaluated in accordance with the test procedures given in ANSI/TIA-603-E and the testing has shown the tested sample to be in compliance with the applicable technical standards. This report contains data that were produced under subcontract by Laboratory SPORTON INTERNATIONAL INC.

The test results in this report apply exclusively to the tested model / sample. Without written approval of Sporton International (Kunshan) Inc., the test report shall not be reproduced except in full.



Approved by: James Huang / Manager

Sporton International (Kunshan) Inc.
No.3-2 Ping-Xiang Rd, Kunshan Development Zone Kunshan City Jiangsu Province 215335
China



TABLE OF CONTENTS

REVISION HISTORY 3
SUMMARY OF TEST RESULT 4
1 GENERAL DESCRIPTION 5
1.1 Applicant 5
1.2 Manufacturer 5
1.3 Product Feature of Equipment Under Test 5
1.4 Product Specification of Equipment Under Test 6
1.5 Modification of EUT 6
1.6 Specification of Accessory 7
1.7 Re-use of Measured Data 8
1.8 Maximum EIRP Power, Frequency Tolerance, and Emission Designator 9
1.9 Testing Location 10
1.10 Applicable Standards 11
2 TEST CONFIGURATION OF EQUIPMENT UNDER TEST 12
2.1 Test Mode 12
2.2 Connection Diagram of Test System 13
2.3 Support Unit used in test configuration and system 13
2.4 Measurement Results Explanation Example 13
2.5 Frequency List of Low/Middle/High Channels 14
3 CONDUCTED TEST ITEMS 15
3.1 Measuring Instruments 15
3.2 Test Setup 15
3.3 Test Result of Conducted Test 15
3.4 Conducted Output Power and EIRP 16
3.5 Peak-to-Average Ratio 17
3.6 Occupied Bandwidth 18
3.7 Conducted Band Edge 19
3.8 Conducted Spurious Emission 21
3.9 Frequency Stability 22
4 RADIATED TEST ITEMS 23
4.1 Measuring Instruments 23
4.2 Test Setup 23
4.3 Test Result of Radiated Test 23
4.4 Radiated Spurious Emission 24
5 LIST OF MEASURING EQUIPMENT 25
6 UNCERTAINTY OF EVALUATION 26
APPENDIX A. TEST RESULTS OF CONDUCTED TEST
APPENDIX B. TEST RESULTS OF RADIATED TEST
APPENDIX C. TEST SETUP PHOTOGRAPHS
APPENDIX D. REFERENCE REPORT



REVISION HISTORY

| REPORT NO. | VERSION | DESCRIPTION | ISSUED DATE |
|--------------|---------|-------------------------|---------------|
| FG7D2201-01B | Rev. 01 | Initial issue of report | Mar. 06, 2018 |
| | | | |
| | | | |
| | | | |
| | | | |
| | | | |
| | | | |
| | | | |
| | | | |
| | | | |
| | | | |
| | | | |
| | | | |
| | | | |
| | | | |
| | | | |
| | | | |
| | | | |
| | | | |
| | | | |
| | | | |
| | | | |



SUMMARY OF TEST RESULT

| Report Section | FCC Rule | Description | Limit | Result | Remark |
|----------------|-------------------------|---|-------------------------------------|--------|---|
| 3.4 | §2.1046 | Conducted Output Power | Reporting Only | PASS | - |
| | §27.50(h)(2) | Equivalent Isotropic Radiated Power (Band 38) (Band 41) | EIRP < 2Watt | PASS | - |
| 3.5 | N/A | Peak-to-Average Ratio | <13 dB | PASS | - |
| 3.6 | §2.1049 | Occupied Bandwidth | Reporting Only | PASS | - |
| 3.7 | §27.53(m)(4) | Conducted Band Edge Measurement (Band 38) (Band 41) | §27.53(m)(4) | PASS | - |
| 3.8 | §2.1051 §27.53(m)(4) | Conducted Spurious Emission (Band 38) (Band 41) | < 55+10log ₁₀ (P[Watts]) | PASS | - |
| 3.9 | §2.1055 §27.54 | Frequency Stability Temperature & Voltage | Within Authorized Band | PASS | - |
| 4.4 | §2.1053 §27.53(m)(4) | Radiated Spurious Emission (Band 38) (Band 41) | < 55+10log ₁₀ (P[Watts]) | PASS | Under limit 16.53 dB at 7758.000 MHz |



1 General Description

1.1 Applicant

Motorola Mobility LLC
222 W, Merchandise Mart Plaza, Chicago IL 60654 USA

1.2 Manufacturer

Motorola Mobility LLC
222 W, Merchandise Mart Plaza, Chicago IL 60654 USA

1.3 Product Feature of Equipment Under Test

| Product Feature | |
|---------------------------------|--|
| Equipment | Mobile Cellular Phone |
| Brand Name | Motorola |
| Model Name | XT1924-3 |
| FCC ID | IHDT56XA6 |
| EUT supports Radios application | GSM/GPRS/EGPRS/WCDMA/HSPA/DC-HSDPA/HSPA+(16 QAM uplink is not supported)/LTE WLAN 2.4GHz 802.11b/g/n HT20 Bluetooth v3.0+EDR/ Bluetooth v4.0 LE/ Bluetooth v4.1 LE/ Bluetooth v4.2 LE |
| IMEI Code | Conducted: 351876090030956/351876090030964 Radiation: 351876090027473/ 351876090027481 |
| HW Version | DVT1B |
| SW Version | ahannah-userdebug 8.0.0 OPP27.60 924 intcfg,test-keys |
| EUT Stage | Identical Prototype |

1.4 Product Specification of Equipment Under Test

| Standards-related Product Specification | |
|---|---|
| Tx Frequency | LTE Band 5 : 824.7 MHz ~ 848.3 MHz LTE Band 7 : 2502.5 MHz ~ 2567.5 MHz LTE Band 38 : 2572.5MHz ~ 2617.5MHz LTE Band 41 : 2537.5 MHz ~ 2652.5 MHz |
| Rx Frequency | LTE Band 5 : 869.7 MHz ~ 893.3 MHz LTE Band 7 : 2622.5MHz ~ 2687.5 MHz LTE Band 38 : 2572.5MHz ~ 2617.5MHz LTE Band 41 : 2537.5 MHz ~ 2652.5 MHz |
| Bandwidth | LTE Band 5 : 1.4MHz / 3MHz / 5MHz / 10MHz LTE Band 7 : 5MHz/ 10MHz / 15MHz / 20MHz LTE Band 38 : 5MHz / 10MHz / 15MHz / 20MHz LTE Band 41 : 5MHz / 10MHz / 15MHz / 20MHz |
| Maximum Output Power to Antenna | LTE Band 38 : 23.54 dBm LTE Band 41 : 23.76 dBm |
| Antenna Gain | LTE Band 38 : 0.48 dBi LTE Band 41 : 0.55 dBi |
| Type of Modulation | QPSK / 16QAM |

1.5 Modification of EUT

No modifications are made to the EUT during all test items.



1.6 Specification of Accessory

| Specification of Accessory | | | | |
|----------------------------|------------------|---|------------|-----------------------------|
| AC Adapter 1(US) | Brand Name | Motorola (Acbel) | Model Name | SPN5945A C-P35 |
| | Power Rating | I/P: 100-240 Vac, 300mA, O/P: 5Vdc, 2000mA | | |
| AC Adapter 1(EU) | Brand Name | Motorola (Acbel) | Model Name | SPN5944A C-P36 |
| | Power Rating | I/P: 100-240 Vac, 300mA, O/P: 5Vdc, 2000mA | | |
| AC Adapter 1(UK) | Brand Name | Motorola (Acbel) | Model Name | SPN5940A C-P37 |
| | Power Rating | I/P: 100-240 Vac, 300mA, O/P: 5Vdc, 2000mA | | |
| AC Adapter 1(IN) | Brand Name | Motorola (Acbel) | Model Name | SA18C19493 C-P49 |
| | Power Rating | I/P: 100-240 Vac, 300mA, O/P: 5Vdc, 2000mA | | |
| AC Adapter 2(US) | Brand Name | Motorola (Salom) | Model Name | SSW-2919UMTJ C-P35 SPN5945A |
| | Power Rating | I/P: 100-240 Vac, 300mA, O/P: 5Vdc, 2000mA | | |
| AC Adapter 2(EU) | Brand Name | Motorola (Salom) | Model Name | SSW-2919EU C-P36 SPN5944A |
| | Power Rating | I/P: 100-240 Vac, 300mA, O/P: 5Vdc, 2000mA | | |
| AC Adapter 2(UK) | Brand Name | Motorola (Salom) | Model Name | SSW-2919UK C-P37 SPN5940A |
| | Power Rating | I/P: 100-240 Vac, 300mA, O/P: 5Vdc, 2000mA | | |
| Battery | Brand Name | Motorola (Amperex) | Model Name | HE50 |
| | Power Rating | 3.8Vdc,4850/5000mAh | Type | Li-ion |
| Earphone | Brand Name | Motorola (NEW Leaders) | Model Name | NLD-EM300V-01SF |
| | Signal Line Type | 1.2 meter, non-shielded cable, without ferrite core | | |
| USB Cable | Brand Name | Motorola (Saibao) | Model Name | SLQ-A081A |
| | Signal Line Type | 1.0 meter, non-shielded cable, without ferrite core | | |



1.7 Re-use of Measured Data

1.7.1 Introduction Section

This application re-uses data collected on a similar device. The subject device of this application (Model: XT1924-3, FCC ID: IHDT56XA6) is electrically identical to the reference device (Model: XT1924-4, XT1924-5, FCC ID: IHDT56XA5) for the portions of the circuitry corresponding to the data being re-used, as treated by KDB Publication 178919 D01.

1.7.2 Difference Section

For details concerning the similarity with respect to component placement, mechanical/electrical design etc., some difference of population/depopulation to enable support of different cellular bands, please refer to the Product Equality Declaration.

The re-used RF data includes the following bands provided in Appendix D (Sporton RF Report No. FG7D2201B for the reference device Model: XT1924-4, XT1924-5, FCC ID: IHDT56XA5):

1.7.3 Spot Check Verification Data Section

In order to confirm hardware similarity of the subject device with the reference device, spot check measurements were performed on the subject device for radiated spurious emission, Conducted Band-edge and Conducted spurious emission, the test result were consistent with FCC ID: IHDT56XA5 and added new Band 38/41 to full test.

Assertions concerning the similarity of these devices are based on representations by the applicant. The applicant accepts full responsibility for the validity of the similarity claim, and for the determination that verification test data are sufficient to support it.

1.7.4 Reference detail Section:

| Equipment Class | Reference FCC ID | Folder Test | Report Title/Section |
|-----------------|------------------|------------------------------------|---|
| PCE (2G/3G) | IHDT56XA5 | Part22H.24E (FG7D2201A) | All sections applicable for GSM 850/1900/WCDMA Band II/V |
| PCE (LTE) | IHDT56XA5 | Part22H.24E.27L.27M (FG7D2201B) | All sections applicable for LTE Band 5/7 |



1.8 Maximum EIRP Power, Frequency Tolerance, and Emission Designator

| LTE Band 38 | | QPSK | | | 16QAM | | |
|-------------|-----------------------|------------------------------|---------------------------|-----------------|------------------------------|---------------------------|-----------------|
| BW (MHz) | Frequency Range (MHz) | Emission Designator (99%OBW) | Frequency Tolerance (ppm) | Maximum EIRP(W) | Emission Designator (99%OBW) | Frequency Tolerance (ppm) | Maximum EIRP(W) |
| 5 | 2572.5 ~ 2617.5 | 4M50G7D | - | 0.2472 | 4M53W7D | - | 0.1782 |
| 10 | 2575.0 ~ 2615.0 | 9M09G7D | 0.0018 | 0.2443 | 9M09W7D | - | 0.1746 |
| 15 | 2577.5 ~ 2612.5 | 13M5G7D | - | 0.2523 | 13M4W7D | - | 0.1807 |
| 20 | 2580.0 ~ 2610.0 | 18M4G7D | - | 0.2472 | 18M3W7D | - | 0.1762 |
| LTE Band 41 | | QPSK | | | 16QAM | | |
| BW (MHz) | Frequency Range (MHz) | Emission Designator (99%OBW) | Frequency Tolerance (ppm) | Maximum EIRP(W) | Emission Designator (99%OBW) | Frequency Tolerance (ppm) | Maximum EIRP(W) |
| 5 | 2537.5 ~ 2652.5 | 4M52G7D | - | 0.2547 | 4M49W7D | - | 0.1754 |
| 10 | 2540.0 ~ 2650.0 | 9M01G7D | 0.0022 | 0.2432 | 9M03W7D | - | 0.1687 |
| 15 | 2542.5 ~ 2647.5 | 13M5G7D | - | 0.2449 | 13M4W7D | - | 0.1782 |
| 20 | 2545.0 ~ 2645.0 | 18M3G7D | - | 0.2698 | 18M3W7D | - | 0.1807 |



1.9 Testing Location

Sporton International (Kunshan) Inc. is accredited to ISO 17025 by National Voluntary Laboratory Accreditation Program (NVLAP code: 600155-0) and the FCC designation No. is CN5013.

| | | |
|---------------------------|---|---------------------------------------|
| Test Site | Sporton International (Kunshan) Inc. | |
| Test Site Location | No.3-2 Ping-Xiang Rd, Kunshan Development Zone Kunshan City Jiangsu Province 215335 China TEL : +86-512-57900158 FAX : +86-512-57900958 | |
| Test Site No. | Sporton Site No. | FCC Test Firm Registration No. |
| | TH01-KS | 630927 |

SPORTON INTERNATIONAL INC. is accredited to ISO 17025 by Taiwan Accreditation Foundation (TAF code : 1190) and under the FCC-recognized accredited testing laboratories by Mutual Recognition Agreement (MRA) in FCC Test.

| | | | |
|---------------------------|--|----------------------------|---------------------------------------|
| Test Site | SPORTON INTERNATIONAL INC. | | |
| Test Site Location | No.58, Aly. 75, Ln. 564 Wenhua 3rd Rd. Guishan Dist. Taoyuan City Taiwan TEL: +886-3-327-3456 FAX: +886-3-328-4978 | | |
| Test Site No. | Sporton Site No. | FCC designation No. | FCC Test Firm Registration No. |
| | 03CH12-HY | TW0007 | 214511 |

Note:

1. The test site complies with ANSI C63.4 2014 requirement.
2. Test data subcontracted: radiated spurious emissions in section 4.4 of this report.



1.10 Applicable Standards

According to the specifications of the manufacturer, the EUT must comply with the requirements of the following standards:

- ♦ 47 CFR Part 2, 22(H), 27(M)
- ♦ ANSI/TIA-603-E
- ♦ FCC KDB 971168 D01 Power Meas License Digital Systems v03
- ♦ FCC KDB 412172 D01 Determining ERP and EIRP v01r01

Remark:

1. All test items were verified and recorded according to the standards and without any deviation during the test.
2. This EUT has also been tested and complied with the requirements of FCC Part 15, Subpart B, recorded in a separate test report.



2 Test Configuration of Equipment Under Test

2.1 Test Mode

Antenna port conducted and radiated test items listed below are performed according to KDB 971168 D01 Power Meas License Digital Systems v03 with maximum output power.

Radiated measurements are performed by rotating the EUT in three different orthogonal test planes to find the maximum emission.

| Test Items | Band | Bandwidth (MHz) | | | | | | Modulation | | RB # | | | Test Channel | | |
|-----------------------------|--|-----------------|---|---|----|----|----|------------|-------|------|------|------|--------------|---|---|
| | | 1.4 | 3 | 5 | 10 | 15 | 20 | QPSK | 16QAM | 1 | Half | Full | L | M | H |
| | 38 | - | - | Y | Y | Y | Y | Y | Y | Y | Y | Y | Y | Y | Y |
| | 41 | - | - | Y | Y | Y | Y | Y | Y | Y | Y | Y | Y | Y | Y |
| Peak-to-Average Ratio | 38 | - | - | | | | Y | Y | Y | Y | | Y | Y | Y | Y |
| | 41 | - | - | | | | Y | Y | Y | Y | | Y | Y | Y | Y |
| 26dB and 99% Bandwidth | 38 | - | - | Y | Y | Y | Y | Y | Y | | | Y | Y | Y | Y |
| | 41 | - | - | Y | Y | Y | Y | Y | Y | | | Y | Y | Y | Y |
| Conducted Band Edge | 38 | - | - | Y | Y | Y | Y | Y | Y | Y | | Y | Y | | Y |
| | 41 | - | - | Y | Y | Y | Y | Y | Y | Y | | Y | Y | | Y |
| Conducted Spurious Emission | 38 | - | - | Y | Y | Y | Y | Y | Y | Y | | | Y | Y | Y |
| | 41 | - | - | Y | Y | Y | Y | Y | Y | Y | | | Y | Y | Y |
| Frequency Stability | 38 | - | - | | Y | | | Y | | | | Y | | Y | |
| | 41 | - | - | | Y | | | Y | | | | Y | | Y | |
| E.I.R.P. | 38 | - | - | Y | Y | Y | Y | Y | Y | Y | | | Y | Y | Y |
| | 41 | - | - | Y | Y | Y | Y | Y | Y | Y | | | Y | Y | Y |
| Radiated Spurious Emission | 38 | - | - | Y | Y | Y | Y | Y | | Y | | | | Y | |
| | 41 | - | - | Y | Y | Y | Y | Y | | Y | | | | Y | |
| Note | <ol style="list-style-type: none"> The mark "Y" means that this configuration is chosen for testing The mark "-" means that this bandwidth is not supported. The device is investigated from 30MHz to 10 times of fundamental signal for radiated spurious emission test under different BW/RB size/offset and modulations in exploratory test. Subsequently, only the worst case emissions are reported. | | | | | | | | | | | | | | |

2.2 Connection Diagram of Test System

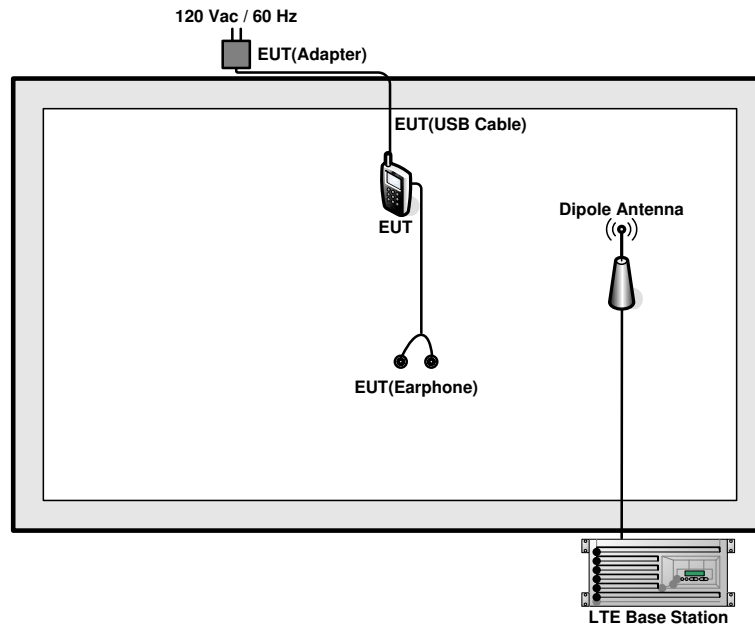

2.3 Support Unit used in test configuration and system

| Item | Equipment | Trade Name | Model No. | FCC ID | Data Cable | Power Cord |
|------|------------------|------------|-----------|--------|------------|-------------------|
| 1. | LTE Base Station | Anritsu | MT8820C | N/A | N/A | Unshielded, 1.8 m |
| 2. | DC Power Supply | GW | GPS-3030D | N/A | N/A | Unshielded, 1.8 m |

2.4 Measurement Results Explanation Example

For all conducted test items:

The offset level is set in the spectrum analyzer to compensate the RF cable loss between EUT conducted output port and spectrum analyzer. With the offset compensation, the spectrum analyzer reading level is exactly the EUT RF output level.

The spectrum analyzer offset is derived from RF cable loss.

Offset = RF cable loss.

Following shows an offset computation example with cable loss 5.4 dB.

Example :

Offset(dB) = RF cable loss(dB).

= 5.4 (dB)



2.5 Frequency List of Low/Middle/High Channels

| LTE Band 38 Channel and Frequency List | | | | |
|--|------------------------|--------|--------|---------|
| BW [MHz] | Channel/Frequency(MHz) | Lowest | Middle | Highest |
| 20 | Channel | 37850 | 38000 | 38150 |
| | Frequency | 2580 | 2595 | 2610 |
| 15 | Channel | 37825 | 38000 | 38175 |
| | Frequency | 2577.5 | 2595 | 2612.5 |
| 10 | Channel | 37800 | 38000 | 38200 |
| | Frequency | 2575 | 2595 | 2615 |
| 5 | Channel | 37775 | 38000 | 38225 |
| | Frequency | 2572.5 | 2595 | 2617.5 |

| LTE Band 41 Channel and Frequency List | | | | |
|--|------------------------|--------|--------|---------|
| BW [MHz] | Channel/Frequency(MHz) | Lowest | Middle | Highest |
| 20 | Channel | 40140 | 40640 | 41140 |
| | Frequency | 2545 | 2595 | 2645 |
| 15 | Channel | 40115 | 40640 | 41165 |
| | Frequency | 2542.5 | 2595 | 2647.5 |
| 10 | Channel | 40090 | 40640 | 41190 |
| | Frequency | 2540 | 2595 | 2650 |
| 5 | Channel | 40065 | 40640 | 41215 |
| | Frequency | 2537.5 | 2595 | 2652.5 |

3 Conducted Test Items

3.1 Measuring Instruments

See list of measuring instruments of this test report.

3.2 Test Setup

3.2.1 Conducted Output Power

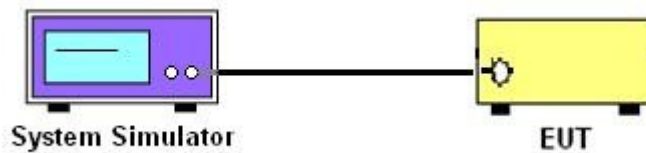

3.2.2 Peak-to-Average Ratio, Occupied Bandwidth ,Conducted Band-Edge and Conducted Spurious Emission

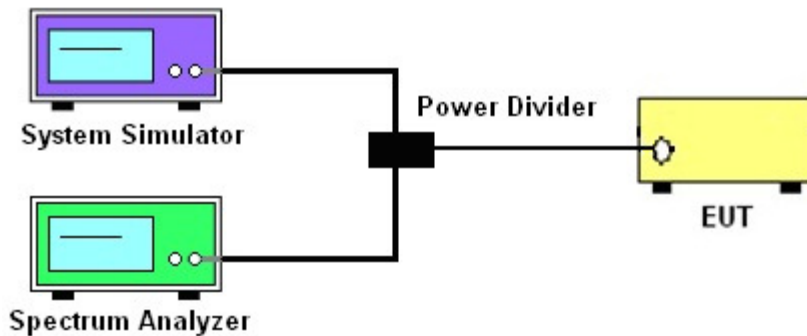

3.2.3 Frequency Stability

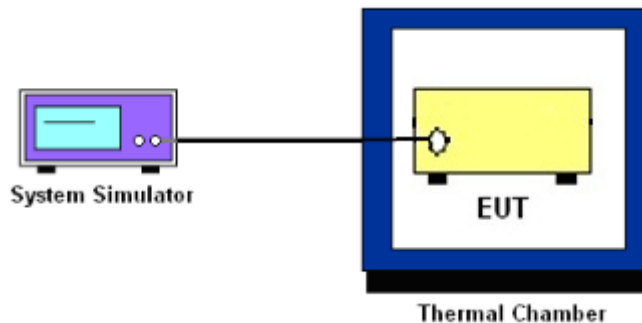

3.3 Test Result of Conducted Test

Please refer to Appendix A.



3.4 Conducted Output Power and EIRP

3.4.1 Description of the Conducted Output Power Measurement and EIRP Measurement

A system simulator was used to establish communication with the EUT. Its parameters were set to force the EUT transmitting at maximum output power. The measured power in the radio frequency on the transmitter output terminals shall be reported.

The EIRP of mobile transmitters must not exceed 2 Watts for LTE Band 38, and Band 41.

According to KDB 412172 D01 Power Approach,

$EIRP = P_T + G_T - L_C$, $ERP = EIRP - 2.15$, where

P_T = transmitter output power in dBm

G_T = gain of the transmitting antenna in dBi

L_C = signal attenuation in the connecting cable between the transmitter and antenna in dB

3.4.2 Test Procedures

1. The transmitter output port was connected to the system simulator.
2. Set EUT at maximum power through the system simulator.
3. Select lowest, middle, and highest channels for each band and different modulation.
4. Measure and record the power level from the system simulator.



3.5 Peak-to-Average Ratio

3.5.1 Description of the PAR Measurement

Power Complementary Cumulative Distribution Function (CCDF) curves provide a means for characterizing the power peaks of a digitally modulated signal on a statistical basis. A CCDF curve depicts the probability of the peak signal amplitude exceeding the average power level. Most contemporary measurement instrumentation include the capability to produce CCDF curves for an input signal provided that the instrument's resolution bandwidth can be set wide enough to accommodate the entire input signal bandwidth. In measuring transmissions in this band using an average power technique, the peak-to-average ratio (PAR) of the transmission may not exceed 13 dB.

3.5.2 Test Procedures

1. The testing follows FCC KDB 971168 v03 Section 5.7.1.
2. The EUT was connected to spectrum and system simulator via a power divider.
3. Set the CCDF (Complementary Cumulative Distribution Function) option in spectrum analyzer.
4. The highest RF powers were measured and recorded the maximum PAPR level associated with a probability of 0.1 %.
5. Record the deviation as Peak to Average Ratio.



3.6 Occupied Bandwidth

3.6.1 Description of Occupied Bandwidth Measurement

The occupied bandwidth is the width of a frequency band such that, below the lower and above the upper frequency limits, the mean powers emitted are each equal to a specified percentage 0.5% of the total mean transmitted power.

The 26 dB emission bandwidth is defined as the frequency range between two points, one above and one below the carrier frequency, at which the spectral density of the emission is attenuated 26 dB below the maximum in-band spectral density of the modulated signal. Spectral density (power per unit bandwidth) is to be measured with a detector of resolution bandwidth equal to approximately 1.0% of the emission bandwidth.

3.6.2 Test Procedures

1. The testing follows FCC KDB 971168 v03 Section 4.1 and 4.2.
2. The EUT was connected to spectrum analyzer and system simulator via a power divider.
3. The spectrum analyzer center frequency is set to the nominal EUT channel center frequency. The span range for the spectrum analyzer shall be between two and five times the anticipated OBW.
4. The nominal resolution bandwidth (RBW) shall be in the range of 1 to 5 % of the anticipated OBW, and the VBW shall be at least 3 times the RBW.
5. Set the detection mode to peak, and the trace mode to max hold.
6. Determine the reference value: Set the EUT to transmit a modulated signal. Allow the trace to stabilize. Set the spectrum analyzer marker to the highest level of the displayed trace.
(this is the reference value)
7. Determine the “-26 dB down amplitude” as equal to (Reference Value – X).
8. Place two markers, one at the lowest and the other at the highest frequency of the envelope of the spectral display such that each marker is at or slightly below the “-X dB down amplitude” determined in step 6. If a marker is below this “-X dB down amplitude” value it shall be placed as close as possible to this value. The OBW is the positive frequency difference between the two markers.
9. Use the 99 % power bandwidth function of the spectrum analyzer and report the measured bandwidth.



3.7 Conducted Band Edge

3.7.1 Description of Conducted Band Edge Measurement

27.53(m)(4)

For mobile digital stations, the attenuation factor shall be not less than $40 + 10 \log (P)$ dB on all frequencies between the channel edge and 5 megahertz from the channel edge, $43 + 10 \log (P)$ dB on all frequencies between 5 megahertz and X megahertz from the channel edge, and $55 + 10 \log (P)$ dB on all frequencies more than X megahertz from the channel edge, where X is the greater of 6 megahertz or the actual emission bandwidth as defined in paragraph (m)(6) of this section. In addition, the attenuation factor shall not be less that $43 + 10 \log (P)$ dB on all frequencies between 2490.5 MHz and 2496 MHz and $55 + 10 \log (P)$ dB at or below 2490.5 MHz. Mobile Satellite Service licensees operating on frequencies below 2495 MHz may also submit a documented interference complaint against BRS licensees operating on channel BRS Channel 1 on the same terms and conditions as adjacent channel BRS or EBS licensees.



3.7.2 Test Procedures

1. The testing follows FCC KDB 971168 v03 Section 6.0.
2. The EUT was connected to spectrum analyzer and system simulator via a power divider.
3. The band edges of low and high channels for the highest RF powers were measured.
4. Set RBW \geq 1% EBW in the 1MHz band immediately outside and adjacent to the band edge.
5. Beyond the 1 MHz band from the band edge, RBW=1MHz was used.
6. Set spectrum analyzer with RMS detector.
7. The RF fundamental frequency should be excluded against the limit line in the operating frequency band.
8. Offset has included the duty factor for LTE Band 38/41. Duty factor = $10 \log (1/x)$, where x is the measured duty cycle.
9. Checked that all the results comply with the emission limit line.

Example:

The limit line is derived from $43 + 10\log(P)$ dB below the transmitter power P(Watts)

$$= P(W) - [43 + 10\log(P)] \text{ (dB)}$$

$$= [30 + 10\log(P)] \text{ (dBm)} - [43 + 10\log(P)] \text{ (dB)} = -13\text{dBm}.$$

10. For LTE Band 38, 41, the other 40 dB, and 55 dB have additionally applied same calculation above.



3.8 Conducted Spurious Emission

3.8.1 Description of Conducted Spurious Emission Measurement

The power of any emission outside of the authorized operating frequency ranges must be lower than the transmitter power (P) by a factor of at least $43 + 10 \log (P)$ dB.

For Band 38,41:

The power of any emission outside of the authorized operating frequency ranges must be lower than the transmitter power (P) by a factor of at least $55 + 10 \log (P)$ dB.

It is measured by means of a calibrated spectrum analyzer and scanned from 30 MHz up to a frequency including its 10th harmonic.

3.8.2 Test Procedures

1. The testing follows FCC KDB 971168 v03 Section 6.0.
2. The EUT was connected to spectrum analyzer and system simulator via a power divider.
3. The RF output of EUT was connected to the spectrum analyzer by RF cable and attenuator. The path loss was compensated to the results for each measurement.
4. The middle channel for the highest RF power within the transmitting frequency was measured.
5. The conducted spurious emission for the whole frequency range was taken.
6. Make the measurement with the spectrum analyzer's RBW = 1MHz, VBW = 3MHz.
7. Set spectrum analyzer with RMS detector.
8. Offset has included the duty factor for LTE Band 38/41. Duty factor = $10 \log (1/x)$, where x is the measured duty cycle.
9. Taking the record of maximum spurious emission.
10. The RF fundamental frequency should be excluded against the limit line in the operating frequency band.
11. The limit line is derived from $43 + 10 \log (P)$ dB below the transmitter power P(Watts)
= $P(W) - [43 + 10 \log (P)]$ (dB)
= $[30 + 10 \log (P)]$ (dBm) - $[43 + 10 \log (P)]$ (dB)
= -13dBm.
12. For Band 38, 41
The limit line is derived from $55 + 10 \log (P)$ dB below the transmitter power P(Watts)
= $P(W) - [55 + 10 \log (P)]$ (dB)
= $[30 + 10 \log (P)]$ (dBm) - $[55 + 10 \log (P)]$ (dB)
= -25dBm.



3.9 Frequency Stability

3.9.1 Description of Frequency Stability Measurement

The frequency stability shall be measured by variation of ambient temperature and variation of primary supply voltage to ensure that the fundamental emission stays within the authorized frequency block. The frequency stability of the transmitter shall be maintained within $\pm 0.00025\%$ ($\pm 2.5\text{ppm}$) of the center frequency.

3.9.2 Test Procedures for Temperature Variation

1. The testing follows FCC KDB 971168 v03 Section 9.0.
2. The EUT was set up in the thermal chamber and connected with the system simulator.
3. With power OFF, the temperature was decreased to -30°C and the EUT was stabilized before testing. Power was applied and the maximum change in frequency was recorded within one minute.
4. With power OFF, the temperature was raised in 10°C step up to 50°C . The EUT was stabilized at each step for at least half an hour. Power was applied and the maximum frequency change was recorded within one minute.

3.9.3 Test Procedures for Voltage Variation

1. The testing follows FCC KDB 971168 v03 Section 9.0.
2. The EUT was placed in a temperature chamber at $20\pm 5^{\circ}\text{C}$ and connected with the system simulator.
3. The power supply voltage to the EUT was varied from 85% to 115% of the nominal value measured at the input to the EUT.
4. The variation in frequency was measured for the worst case.

4 Radiated Test Items

4.1 Measuring Instruments

See list of measuring instruments of this test report.

4.2 Test Setup

4.2.1 For radiated test from 30MHz to 1GHz

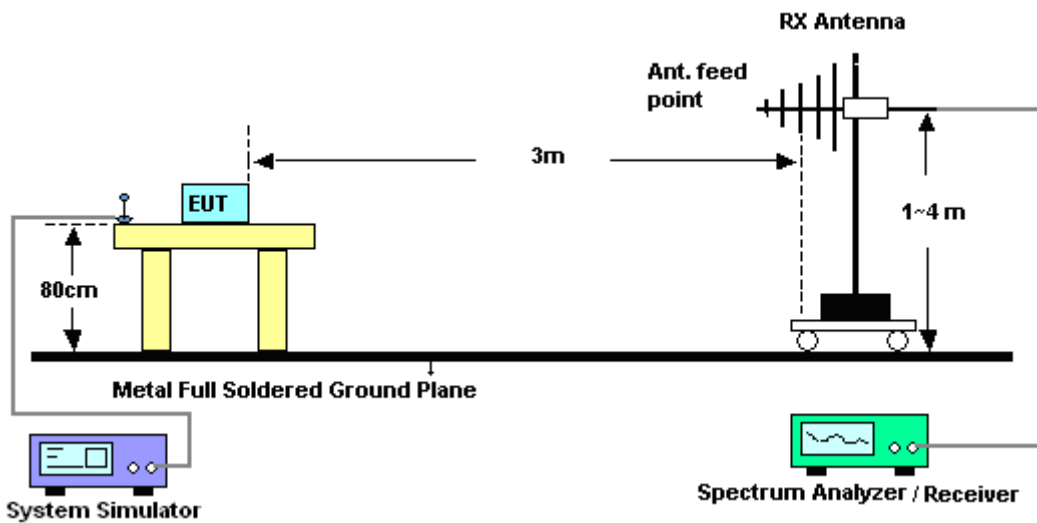

4.2.2 For radiated test above 1GHz

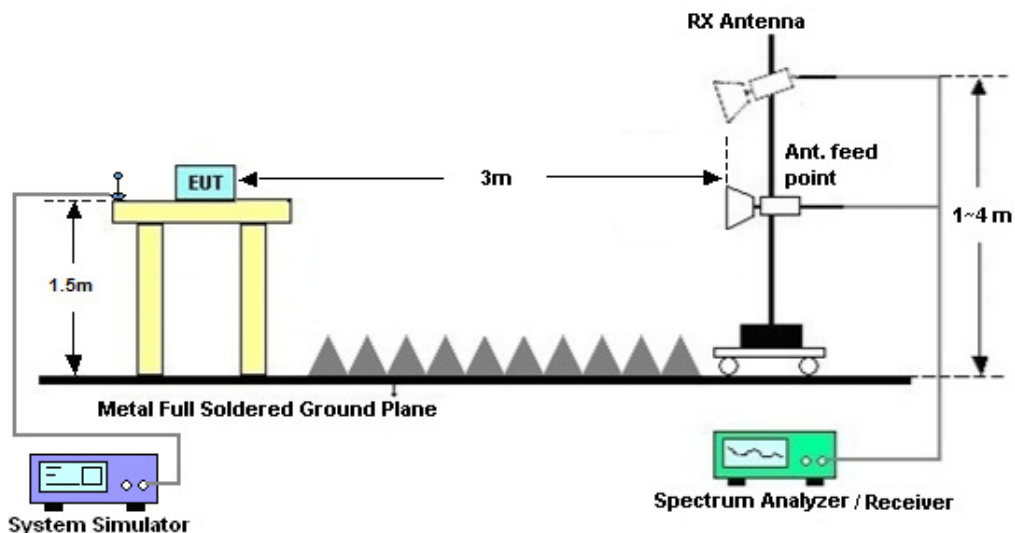

4.3 Test Result of Radiated Test

Please refer to Appendix B.



4.4 Radiated Spurious Emission

4.4.1 Description of Radiated Spurious Emission

The radiated spurious emission was measured by substitution method according to ANSI/TIA-603-E. The power of any emission outside of the authorized operating frequency ranges must be attenuated below the transmitter power (P) by a factor of at least $43 + 10 \log (P)$ dB.

For Band 38, 41

The power of any emission outside of the authorized operating frequency ranges must be attenuated below the transmitter power (P) by a factor of at least $55 + 10 \log (P)$ dB.

The spectrum is scanned from 30 MHz up to a frequency including its 10th harmonic.

4.4.2 Test Procedures

1. The testing follows FCC KDB 971168 v03 Section 5.8 and ANSI/TIA-603-E Section 2.2.12.
2. The EUT was placed on a turntable with 0.8 meter height for frequency below 1GHz and 1.5 meter height for frequency above 1GHz respectively above ground.
3. The EUT was set 3 meters from the receiving antenna mounted on the antenna tower.
4. The table was rotated 360 degrees to determine the position of the highest spurious emission.
5. The height of the receiving antenna is varied between 1m to 4m to search the maximum spurious emission for both horizontal and vertical polarizations.
6. During the measurement, the system simulator parameters were set to force the EUT transmitting at maximum output power.
7. Make the measurement with the spectrum analyzer's RBW = 1MHz, VBW = 3MHz, taking the record of maximum spurious emission.
8. A horn antenna was substituted in place of the EUT and was driven by a signal generator.
9. Tune the output power of signal generator to the same emission level with EUT maximum spurious emission.
10. $EIRP \text{ (dBm)} = S.G. \text{ Power} - Tx \text{ Cable Loss} + Tx \text{ Antenna Gain}$
11. $ERP \text{ (dBm)} = EIRP - 2.15$
12. The RF fundamental frequency should be excluded against the limit line in the operating frequency band.

The limit line is derived from $43 + 10\log(P)$ dB below the transmitter power P(Watts)
 $= P(W) - [43 + 10\log(P)] \text{ (dB)}$
 $= [30 + 10\log(P)] \text{ (dBm)} - [43 + 10\log(P)] \text{ (dB)}$
 $= -13\text{dBm}.$

13. For Band 38, 41:

The limit line is derived from $55 + 10\log(P)$ dB below the transmitter power P(Watts)
 $EIRP \text{ (dBm)} = S.G. \text{ Power} - Tx \text{ Cable Loss} + Tx \text{ Antenna Gain}$
 $ERP \text{ (dBm)} = EIRP - 2.15$



5 List of Measuring Equipment

| Instrument | Manufacturer | Model No. | Serial No. | Characteristics | Calibration Date | Test Date | Due Date | Remark |
|------------------------------|--------------|-------------------|-------------|-----------------------------------|------------------|----------------------------------|---------------|--------------------------|
| Spectrum Analyzer | R&S | FSV40 | 101040 | 10Hz~40GHz | Aug. 08, 2017 | Dec. 28, 2017~ Jan. 25, 2018 | Aug. 07, 2018 | Conducted (TH01-KS) |
| Radio communication analyzer | Anritsu | MT8820C | 6201300652 | 2G/3G/LTE_ full band | Aug. 08, 2017 | Dec. 28, 2017~ Jan. 25, 2018 | Aug. 07, 2018 | Conducted (TH01-KS) |
| Thermal Chamber | Hongzhan | LP-150U | HZ014011440 | -40~+150°C 20%~95%RH | Apr. 18, 2017 | Dec. 28, 2017~ Jan. 25, 2018 | Apr. 17, 2018 | Conducted (TH01-KS) |
| Amplifier | MITEQ | TTA1840-35 -HG | 1871923 | 18GHz~40GHz, VS WR : 2.5:1 max | Jul. 18, 2017 | Jan. 03, 2018 ~ Jan. 05, 2018 | Jul. 17, 2018 | Radiation (03CH12-HY) |
| Bilog Antenna | TESEQ | CBL 6111D&008 | 35413&02 | 30MHz~1GHz | Dec. 18, 2017 | Jan. 03, 2018 ~ Jan. 05, 2018 | Dec. 17, 2018 | Radiation (03CH12-HY) |
| Horn Antenna | SCHWARZBECK | BBHA 9120D | 9120D-1328 | 1GHz ~ 18GHz | Oct. 20, 2017 | Jan. 03, 2018 ~ Jan. 05, 2018 | Oct. 19, 2018 | Radiation (03CH12-HY) |
| Hygrometer | TECPEL | DTM-303B | TP140349 | N/A | Oct. 12, 2017 | Jan. 03, 2018 ~ Jan. 05, 2018 | Oct. 11, 2018 | Radiation (03CH12-HY) |
| Preamplifier | COM-POWER | PA-103 | 161075 | 10MHz~1GHz | Mar. 23, 2017 | Jan. 03, 2018 ~ Jan. 05, 2018 | Mar. 22, 2018 | Radiation (03CH12-HY) |
| Preamplifier | Keysight | 83017A | MY53270148 | 1GHz~26.5GHz | Jan. 12, 2017 | Jan. 03, 2018 ~ Jan. 05, 2018 | Jan. 11, 2018 | Radiation (03CH12-HY) |
| Controller | EMEC | EM1000 | N/A | Control Turn table & Ant Mast | NCR | Jan. 03, 2018 ~ Jan. 05, 2018 | NCR | Radiation (03CH12-HY) |
| Antenna Mast | EMEC | AM-BS-450 0-B | N/A | 1m~4m | NCR | Jan. 03, 2018 ~ Jan. 05, 2018 | NCR | Radiation (03CH12-HY) |
| Turn Table | EMEC | TT2000 | N/A | 0~360 Degree | NCR | Jan. 03, 2018 ~ Jan. 05, 2018 | NCR | Radiation (03CH12-HY) |
| SHF-EHF Horn Antenna | SCHWARZBECK | BBHA 9170 | BBHA9170576 | 18GHz ~ 40GHz | Apr. 27, 2017 | Jan. 03, 2018 ~ Jan. 05, 2018 | Apr. 26, 2018 | Radiation (03CH12-HY) |
| Spectrum Analyzer | Agilent | N9030A | MY52350276 | 3Hz~44GHz | Mar. 23, 2017 | Jan. 03, 2018 ~ Jan. 05, 2018 | Mar. 22, 2018 | Radiation (03CH12-HY) |

NCR: No Calibration Required



6 Uncertainty of Evaluation

Uncertainty of Radiated Emission Measurement (30 MHz ~ 1000 MHz)

| | |
|---|--------|
| Measuring Uncertainty for a Level of Confidence of 95% ($U = 2Uc(y)$) | 3.4 dB |
|---|--------|

Uncertainty of Radiated Emission Measurement (1GHz ~ 18GHz)

| | |
|---|--------|
| Measuring Uncertainty for a Level of Confidence of 95% ($U = 2Uc(y)$) | 3.7 dB |
|---|--------|

Uncertainty of Radiated Emission Measurement (18GHz ~ 40GHz)

| | |
|---|--------|
| Measuring Uncertainty for a Level of Confidence of 95% ($U = 2Uc(y)$) | 4.0 dB |
|---|--------|



Appendix A. Test Results of Conducted Test

Conducted Output Power(Average power)

| LTE Band 38 Maximum Average Power [dBm] | | | | | | |
|---|---------|-----------|--------|--------|--------|---------|
| BW [MHz] | RB Size | RB Offset | Mod | Lowest | Middle | Highest |
| 20 | 1 | 0 | QPSK | 23.25 | 23.17 | 23.27 |
| 20 | 1 | 49 | | 23.18 | 23.45 | 23.34 |
| 20 | 1 | 99 | | 23.29 | 23.19 | 23.14 |
| 20 | 50 | 0 | | 22.23 | 22.29 | 22.25 |
| 20 | 50 | 24 | | 22.21 | 22.24 | 22.22 |
| 20 | 50 | 50 | | 22.21 | 22.12 | 22.14 |
| 20 | 100 | 0 | | 22.22 | 22.24 | 22.23 |
| 20 | 1 | 0 | 16-QAM | 21.72 | 21.67 | 21.98 |
| 20 | 1 | 49 | | 21.84 | 21.94 | 21.98 |
| 20 | 1 | 99 | | 21.85 | 21.96 | 21.62 |
| 20 | 50 | 0 | | 21.25 | 21.31 | 21.33 |
| 20 | 50 | 24 | | 21.25 | 21.15 | 21.11 |
| 20 | 50 | 50 | | 21.2 | 21.11 | 21.12 |
| 20 | 100 | 0 | | 21.21 | 21.26 | 21.23 |
| 15 | 1 | 0 | QPSK | 23.23 | 23.15 | 23.16 |
| 15 | 1 | 37 | | 23.5 | 23.52 | 23.54 |
| 15 | 1 | 74 | | 23.36 | 23.44 | 23.13 |
| 15 | 36 | 0 | | 22.2 | 22.23 | 22.15 |
| 15 | 36 | 20 | | 22.25 | 22.22 | 22.3 |
| 15 | 36 | 39 | | 22.16 | 22.07 | 22.05 |
| 15 | 75 | 0 | | 22.26 | 22.1 | 22.06 |
| 15 | 1 | 0 | 16-QAM | 21.74 | 21.68 | 21.7 |
| 15 | 1 | 37 | | 21.92 | 22.07 | 22.09 |
| 15 | 1 | 74 | | 21.55 | 22.02 | 21.75 |
| 15 | 36 | 0 | | 21.18 | 21.13 | 21.17 |
| 15 | 36 | 20 | | 21.16 | 21.06 | 21.13 |
| 15 | 36 | 39 | | 21.03 | 21.1 | 21.1 |
| 15 | 75 | 0 | | 21.23 | 21.28 | 21.13 |



| LTE Band 38 Maximum Average Power [dBm] | | | | | | |
|---|---------|-----------|--------|--------|--------|---------|
| BW [MHz] | RB Size | RB Offset | Mod | Lowest | Middle | Highest |
| 10 | 1 | 0 | QPSK | 23.37 | 23.22 | 23.32 |
| 10 | 1 | 25 | | 23.28 | 23.3 | 23.24 |
| 10 | 1 | 49 | | 23.21 | 23.4 | 23.27 |
| 10 | 25 | 0 | | 22.15 | 22.26 | 22.24 |
| 10 | 25 | 12 | | 22.25 | 22.28 | 22.23 |
| 10 | 25 | 25 | | 22.2 | 22.02 | 22.09 |
| 10 | 50 | 0 | | 22.19 | 22.14 | 22.15 |
| 10 | 1 | 0 | 16-QAM | 21.71 | 21.63 | 21.86 |
| 10 | 1 | 25 | | 21.94 | 21.69 | 21.9 |
| 10 | 1 | 49 | | 21.71 | 21.67 | 21.58 |
| 10 | 25 | 0 | | 21.37 | 21.36 | 21.42 |
| 10 | 25 | 12 | | 21.41 | 21.5 | 21.35 |
| 10 | 25 | 25 | | 21.25 | 21.24 | 20.95 |
| 10 | 50 | 0 | | 21.14 | 21.13 | 21.1 |
| 5 | 1 | 0 | QPSK | 23.1 | 23.14 | 23.11 |
| 5 | 1 | 12 | | 23.37 | 23.45 | 23.23 |
| 5 | 1 | 24 | | 23.28 | 23.07 | 23.09 |
| 5 | 12 | 0 | | 22.07 | 22 | 22.16 |
| 5 | 12 | 7 | | 22.08 | 22.07 | 22.22 |
| 5 | 12 | 13 | | 22.15 | 22.07 | 22.23 |
| 5 | 25 | 0 | | 22.09 | 21.99 | 22.18 |
| 5 | 1 | 0 | 16-QAM | 21.92 | 21.52 | 21.9 |
| 5 | 1 | 12 | | 21.94 | 22.03 | 22.03 |
| 5 | 1 | 24 | | 21.84 | 21.81 | 21.87 |
| 5 | 12 | 0 | | 21.04 | 21.25 | 21.21 |
| 5 | 12 | 7 | | 21.17 | 21.14 | 21.22 |
| 5 | 12 | 13 | | 21.35 | 21.02 | 21.25 |
| 5 | 25 | 0 | | 21.26 | 21.19 | 21.36 |



| LTE Band 41 Maximum Average Power [dBm] | | | | | | |
|---|---------|-----------|--------|--------|--------|---------|
| BW [MHz] | RB Size | RB Offset | Mod | Lowest | Middle | Highest |
| 20 | 1 | 0 | QPSK | 23.12 | 23.15 | 23.08 |
| 20 | 1 | 49 | | 23.29 | 23.28 | 23.76 |
| 20 | 1 | 99 | | 23.24 | 23.16 | 23.02 |
| 20 | 50 | 0 | | 22.18 | 22.08 | 22.19 |
| 20 | 50 | 24 | | 22.08 | 22.01 | 22.07 |
| 20 | 50 | 50 | | 22.04 | 22.08 | 21.94 |
| 20 | 100 | 0 | | 22.08 | 22.15 | 22.11 |
| 20 | 1 | 0 | 16-QAM | 21.75 | 21.58 | 21.81 |
| 20 | 1 | 49 | | 22.02 | 21.98 | 21.74 |
| 20 | 1 | 99 | | 21.5 | 21.85 | 21.48 |
| 20 | 50 | 0 | | 20.98 | 21.01 | 21.06 |
| 20 | 50 | 24 | | 21.02 | 21.03 | 20.96 |
| 20 | 50 | 50 | | 21.09 | 20.95 | 20.94 |
| 20 | 100 | 0 | | 21.13 | 21.15 | 20.93 |
| 15 | 1 | 0 | QPSK | 23.1 | 22.91 | 23.03 |
| 15 | 1 | 37 | | 23.32 | 23.15 | 23.34 |
| 15 | 1 | 74 | | 23.1 | 23.18 | 22.94 |
| 15 | 36 | 0 | | 22.13 | 21.91 | 22.07 |
| 15 | 36 | 20 | | 22.15 | 22.12 | 22.09 |
| 15 | 36 | 39 | | 22.1 | 22.13 | 21.88 |
| 15 | 75 | 0 | | 22.11 | 22.1 | 21.93 |
| 15 | 1 | 0 | 16-QAM | 21.69 | 21.68 | 21.8 |
| 15 | 1 | 37 | | 21.76 | 21.88 | 21.96 |
| 15 | 1 | 74 | | 21.44 | 21.57 | 21.63 |
| 15 | 36 | 0 | | 21.05 | 20.85 | 20.99 |
| 15 | 36 | 20 | | 20.96 | 21.06 | 20.94 |
| 15 | 36 | 39 | | 20.94 | 21.08 | 20.86 |
| 15 | 75 | 0 | | 21.09 | 21.25 | 21.01 |



| LTE Band 41 Maximum Average Power [dBm] | | | | | | |
|---|---------|-----------|--------|--------|--------|---------|
| BW [MHz] | RB Size | RB Offset | Mod | Lowest | Middle | Highest |
| 10 | 1 | 0 | QPSK | 23.21 | 23.23 | 23.06 |
| 10 | 1 | 25 | | 23.31 | 23.18 | 23.25 |
| 10 | 1 | 49 | | 23.06 | 23.18 | 23.14 |
| 10 | 25 | 0 | | 22.12 | 22.01 | 22.04 |
| 10 | 25 | 12 | | 22.08 | 22.05 | 21.99 |
| 10 | 25 | 25 | | 21.94 | 22.01 | 21.78 |
| 10 | 50 | 0 | | 22.12 | 22.08 | 21.92 |
| 10 | 1 | 0 | 16-QAM | 21.54 | 21.68 | 21.66 |
| 10 | 1 | 25 | | 21.71 | 21.68 | 21.72 |
| 10 | 1 | 49 | | 21.55 | 21.65 | 21.18 |
| 10 | 25 | 0 | | 21.25 | 21.04 | 21.07 |
| 10 | 25 | 12 | | 21.28 | 21.15 | 21.14 |
| 10 | 25 | 25 | | 21.11 | 21.15 | 20.96 |
| 10 | 50 | 0 | | 21.08 | 21.05 | 21.03 |
| 5 | 1 | 0 | QPSK | 23.19 | 23.08 | 23.07 |
| 5 | 1 | 12 | | 23.51 | 23.22 | 23.3 |
| 5 | 1 | 24 | | 23.17 | 23.25 | 23.02 |
| 5 | 12 | 0 | | 22.16 | 22.01 | 21.99 |
| 5 | 12 | 7 | | 22.16 | 22.08 | 21.96 |
| 5 | 12 | 13 | | 22.13 | 22.13 | 21.82 |
| 5 | 25 | 0 | | 22.08 | 22.12 | 21.87 |
| 5 | 1 | 0 | 16-QAM | 21.69 | 21.67 | 21.44 |
| 5 | 1 | 12 | | 21.89 | 21.58 | 21.72 |
| 5 | 1 | 24 | | 21.67 | 21.68 | 21.51 |
| 5 | 12 | 0 | | 20.97 | 21.35 | 20.77 |
| 5 | 12 | 7 | | 21.05 | 21.02 | 20.74 |
| 5 | 12 | 13 | | 20.97 | 21.08 | 20.88 |
| 5 | 25 | 0 | | 21.07 | 21.21 | 21.08 |



EIRP

| LTE Band 38 (G _T - L _C = 0.48 dBi) QPSK | | | | | | | | | |
|---|--------|--------|--------|--------|--------|--------|--------|--------|--------|
| Bandwidth | 5M | | | 10M | | | 15M | | |
| Channel | 37775 | 38000 | 38225 | 37800 | 38000 | 38200 | 37825 | 38000 | 38175 |
| | (Low) | (Mid) | (High) | (Low) | (Mid) | (High) | (Low) | (Mid) | (High) |
| Frequency | 2572.5 | 2595 | 2617.5 | 2575 | 2595 | 2615 | 2577.5 | 2595 | 2612.5 |
| (MHz) | | | | | | | | | |
| Conducted Power (dBm) | 23.37 | 23.45 | 23.23 | 23.21 | 23.40 | 23.27 | 23.50 | 23.52 | 23.54 |
| Conducted Power (Watts) | 0.2173 | 0.2213 | 0.2104 | 0.2094 | 0.2188 | 0.2123 | 0.2239 | 0.2249 | 0.2259 |
| EIRP(dBm) | 23.85 | 23.93 | 23.71 | 23.69 | 23.88 | 23.75 | 23.98 | 24.00 | 24.02 |
| EIRP(Watts) | 0.2427 | 0.2472 | 0.2350 | 0.2339 | 0.2443 | 0.2371 | 0.2500 | 0.2512 | 0.2523 |

| LTE Band 38 (G _T - L _C = 0.48 dBi) QPSK | | | |
|---|--------|--------|--------|
| Bandwidth | 20M | | |
| Channel | 37850 | 38000 | 38150 |
| | (Low) | (Mid) | (High) |
| Frequency | 2580 | 2595 | 2610 |
| (MHz) | | | |
| Conducted Power (dBm) | 23.18 | 23.45 | 23.34 |
| Conducted Power (Watts) | 0.2080 | 0.2213 | 0.2158 |
| EIRP(dBm) | 23.66 | 23.93 | 23.82 |
| EIRP(Watts) | 0.2323 | 0.2472 | 0.2410 |



| LTE Band 38 (G _T - L _C = 0.48 dBi) 16QAM | | | | | | | | | |
|--|--------|--------|--------|--------|--------|--------|--------|--------|--------|
| Bandwidth | 5M | | | 10M | | | 15M | | |
| Channel | 37775 | 38000 | 38225 | 37800 | 38000 | 38200 | 37825 | 38000 | 38175 |
| | (Low) | (Mid) | (High) | (Low) | (Mid) | (High) | (Low) | (Mid) | (High) |
| Frequency (MHz) | 2572.5 | 2595 | 2617.5 | 2575 | 2595 | 2615 | 2577.5 | 2595 | 2612.5 |
| Conducted Power (dBm) | 21.94 | 22.03 | 22.03 | 21.94 | 21.69 | 21.90 | 21.92 | 22.07 | 22.09 |
| Conducted Power (Watts) | 0.1563 | 0.1596 | 0.1596 | 0.1563 | 0.1476 | 0.1549 | 0.1556 | 0.1611 | 0.1618 |
| EIRP(dBm) | 22.42 | 22.51 | 22.51 | 22.42 | 22.17 | 22.38 | 22.40 | 22.55 | 22.57 |
| EIRP(Watts) | 0.1746 | 0.1782 | 0.1782 | 0.1746 | 0.1648 | 0.1730 | 0.1738 | 0.1799 | 0.1807 |

| LTE Band 38 (G _T - L _C = 0.48 dBi) 16QAM | | | |
|--|--------|--------|--------|
| Bandwidth | 20M | | |
| Channel | 37850 | 38000 | 38150 |
| | (Low) | (Mid) | (High) |
| Frequency (MHz) | 2580 | 2595 | 2610 |
| Conducted Power (dBm) | 21.72 | 21.67 | 21.98 |
| Conducted Power (Watts) | 0.1486 | 0.1469 | 0.1578 |
| EIRP(dBm) | 22.20 | 22.15 | 22.46 |
| EIRP(Watts) | 0.1660 | 0.1641 | 0.1762 |



| LTE Band 41 (G _T - L _C = 0.55 dBi) QPSK | | | | | | | | | |
|---|--------|--------|--------|--------|--------|--------|--------|--------|--------|
| Bandwidth | 5M | | | 10M | | | 15M | | |
| Channel | 40065 | 40640 | 41215 | 40090 | 40640 | 41190 | 40115 | 40640 | 41165 |
| | (Low) | (Mid) | (High) | (Low) | (Mid) | (High) | (Low) | (Mid) | (High) |
| Frequency (MHz) | 2537.5 | 2595 | 2652.5 | 2540 | 2595 | 2650 | 2542.5 | 2595 | 2647.5 |
| Conducted Power (dBm) | 23.51 | 23.22 | 23.30 | 23.31 | 23.18 | 23.25 | 23.32 | 23.15 | 23.34 |
| Conducted Power (Watts) | 0.2244 | 0.2099 | 0.2138 | 0.2143 | 0.2080 | 0.2113 | 0.2148 | 0.2065 | 0.2158 |
| EIRP(dBm) | 24.06 | 23.77 | 23.85 | 23.86 | 23.73 | 23.80 | 23.87 | 23.70 | 23.89 |
| EIRP(Watts) | 0.2547 | 0.2382 | 0.2427 | 0.2432 | 0.2360 | 0.2399 | 0.2438 | 0.2344 | 0.2449 |

| LTE Band 41 (G _T - L _C = 0.55 dBi) QPSK | | | |
|---|--------|--------|--------|
| Bandwidth | 20M | | |
| Channel | 40140 | 40640 | 41140 |
| | (Low) | (Mid) | (High) |
| Frequency (MHz) | 2545 | 2595 | 2645 |
| Conducted Power (dBm) | 23.29 | 23.28 | 23.76 |
| Conducted Power (Watts) | 0.2133 | 0.2128 | 0.2377 |
| EIRP(dBm) | 23.84 | 23.83 | 24.31 |
| EIRP(Watts) | 0.2421 | 0.2415 | 0.2698 |



| LTE Band 41 (G _T - L _C = 0.55 dBi) 16QAM | | | | | | | | | |
|--|--------|--------|--------|--------|--------|--------|--------|--------|--------|
| Bandwidth | 5M | | | 10M | | | 15M | | |
| Channel | 40065 | 40640 | 41215 | 40090 | 40640 | 41190 | 40115 | 40640 | 41165 |
| | (Low) | (Mid) | (High) | (Low) | (Mid) | (High) | (Low) | (Mid) | (High) |
| Frequency (MHz) | 2537.5 | 2595 | 2652.5 | 2540 | 2595 | 2650 | 2542.5 | 2595 | 2647.5 |
| Conducted Power (dBm) | 21.89 | 21.58 | 21.72 | 21.71 | 21.68 | 21.72 | 21.76 | 21.88 | 21.96 |
| Conducted Power (Watts) | 0.1545 | 0.1439 | 0.1486 | 0.1483 | 0.1472 | 0.1486 | 0.1500 | 0.1542 | 0.1570 |
| EIRP(dBm) | 22.44 | 22.13 | 22.27 | 22.26 | 22.23 | 22.27 | 22.31 | 22.43 | 22.51 |
| EIRP(Watts) | 0.1754 | 0.1633 | 0.1687 | 0.1683 | 0.1671 | 0.1687 | 0.1702 | 0.1750 | 0.1782 |

| LTE Band 41 (G _T - L _C = 3.06 dBi) 16QAM | | | |
|--|--------|--------|--------|
| Bandwidth | 20M | | |
| Channel | 40140 | 40640 | 41140 |
| | (Low) | (Mid) | (High) |
| Frequency (MHz) | 2545 | 2595 | 2645 |
| Conducted Power (dBm) | 22.02 | 21.98 | 21.74 |
| Conducted Power (Watts) | 0.1592 | 0.1578 | 0.1493 |
| EIRP(dBm) | 22.57 | 22.53 | 22.29 |
| EIRP(Watts) | 0.1807 | 0.1791 | 0.1694 |



Peak-to-Average Ratio

| Mode | LTE Band 38 / 20MHz | | | | |
|------------|---------------------|---------|-------|---------|-------------|
| Mod. | QPSK | | 16QAM | | Limit: 13dB |
| RB Size | 1RB | Full RB | 1RB | Full RB | Result |
| Lowest CH | 4.35 | 5.94 | 5.83 | 6.00 | PASS |
| Middle CH | 4.64 | 5.04 | 5.54 | 6.61 | |
| Highest CH | 4.41 | 6.70 | 5.59 | 6.35 | |

| Mode | LTE Band 41 / 20MHz | | | | |
|------------|---------------------|---------|-------|---------|-------------|
| Mod. | QPSK | | 16QAM | | Limit: 13dB |
| RB Size | 1RB | Full RB | 1RB | Full RB | Result |
| Lowest CH | 4.7 | 5.04 | 5.07 | 5.8 | PASS |
| Middle CH | 5.77 | 4.96 | 5.65 | 6.14 | |
| Highest CH | 4.61 | 5.48 | 5.16 | 5.83 | |



LTE Band 38 / 20MHz / QPSK

Lowest Channel / 1RB

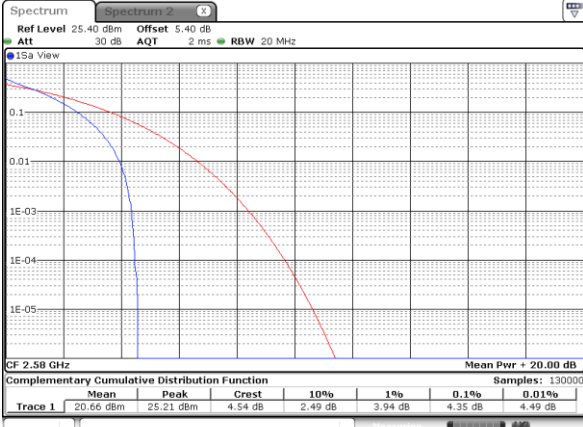

Date: 28 DEC 2017 17:37:31

Lowest Channel / Full RB

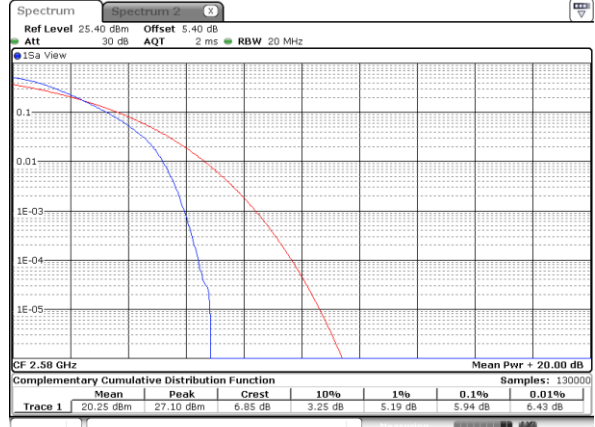

Date: 28 DEC 2017 17:37:46

Middle Channel / 1RB

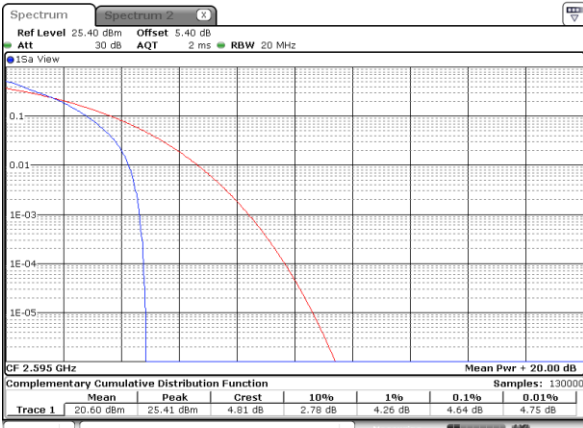

Date: 28 DEC 2017 17:37:56

Middle Channel / Full RB

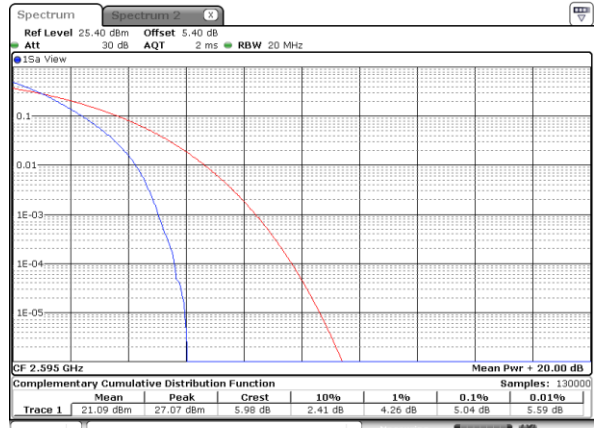

Date: 28 DEC 2017 17:38:14

Highest Channel / 1RB

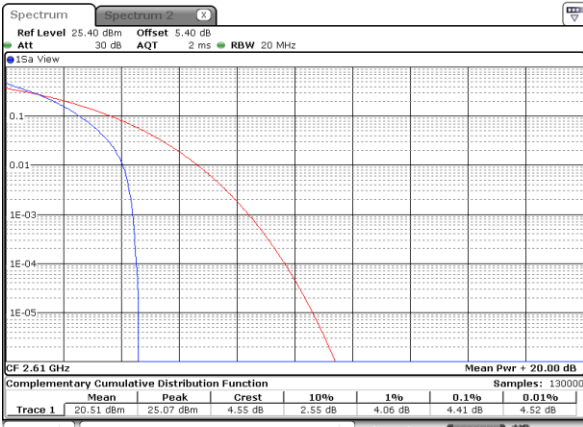

Date: 28 DEC 2017 17:38:43

Highest Channel / Full RB

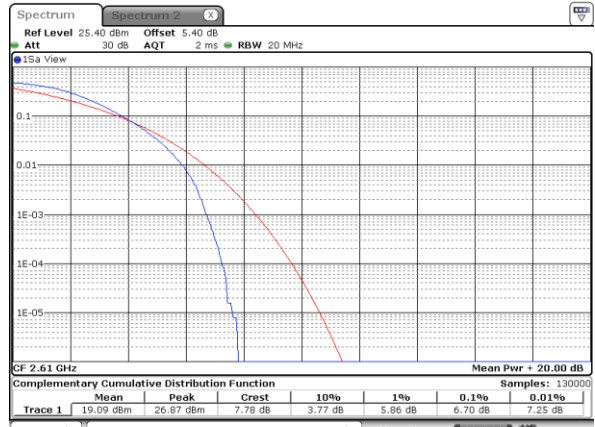

Date: 28 DEC 2017 17:38:55



LTE Band 38 / 20MHz / 16QAM

Lowest Channel / 1RB

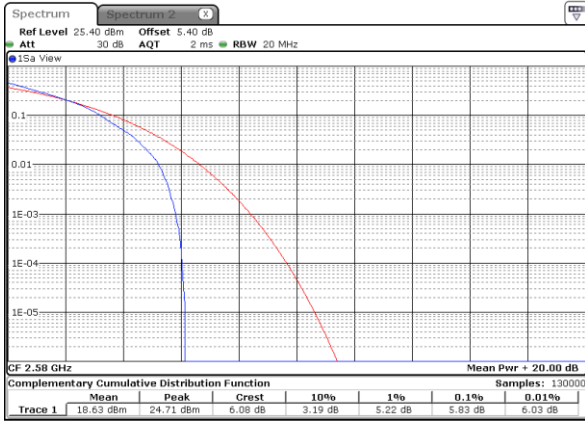

Date: 28 DEC 2017 17:35:57

Lowest Channel / Full RB

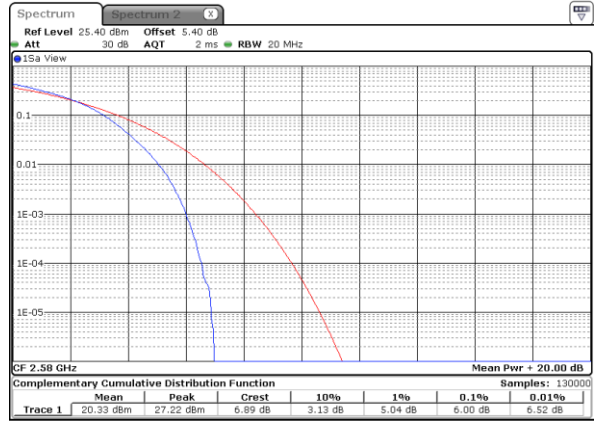

Date: 28 DEC 2017 17:36:06

Middle Channel / 1RB

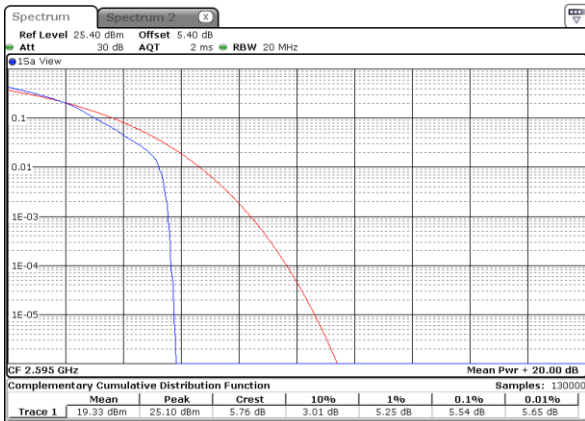

Date: 28 DEC 2017 17:36:21

Middle Channel / Full RB

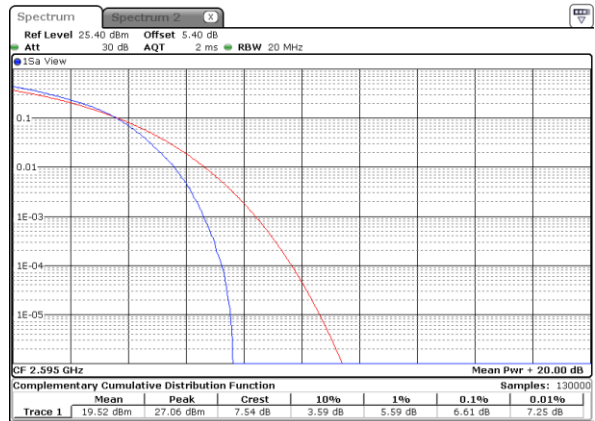

Date: 28 DEC 2017 17:36:31

Highest Channel / 1RB

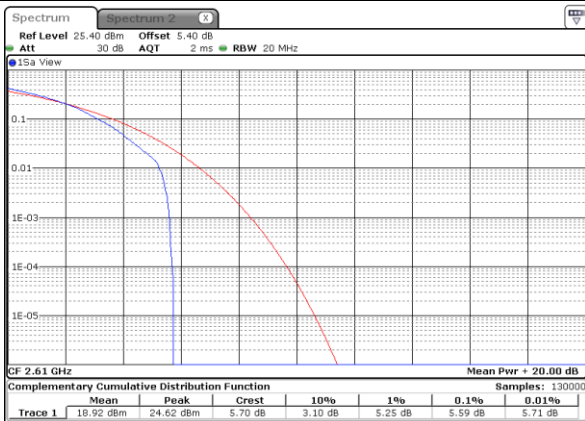

Date: 28 DEC 2017 17:36:47

Highest Channel / Full RB

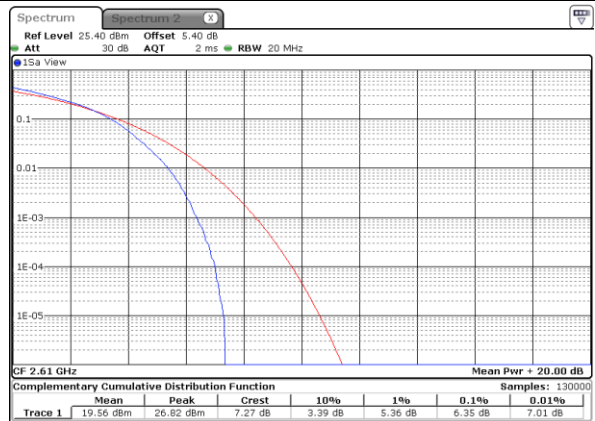

Date: 28 DEC 2017 17:37:20



LTE Band 41 / 20MHz / QPSK

Lowest Channel / 1RB

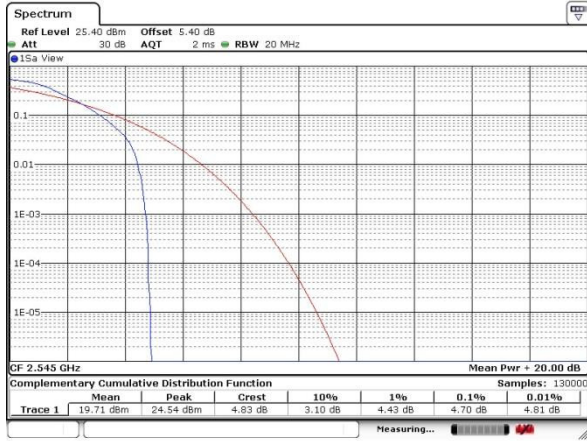

Date: 30 DEC 2017 15:18:53

Lowest Channel / Full RB

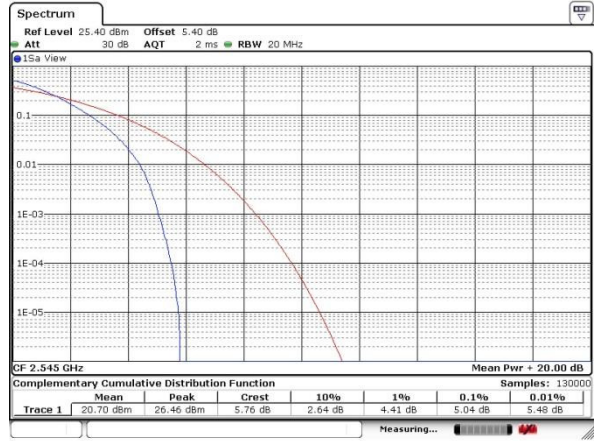

Date: 30 DEC 2017 15:20:56

Middle Channel / 1RB

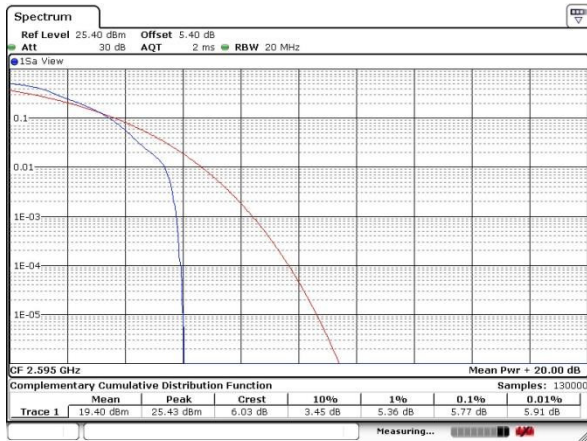

Date: 30 DEC 2017 15:23:13

Middle Channel / Full RB

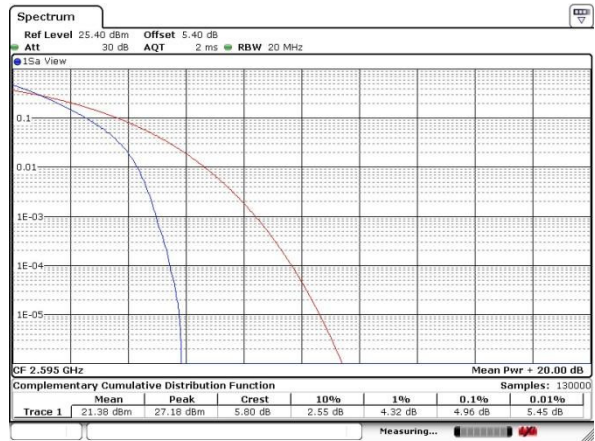

Date: 30 DEC 2017 15:21:38

Highest Channel / 1RB

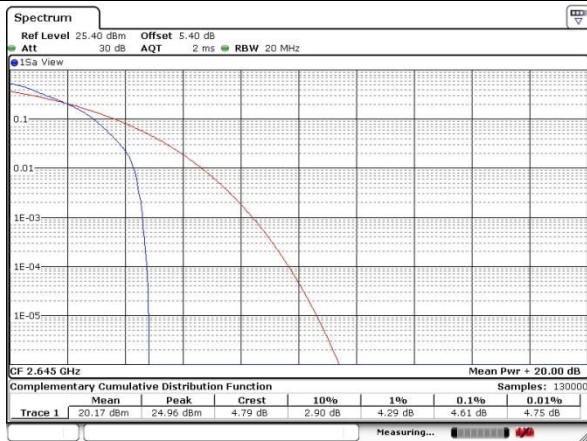

Date: 30 DEC 2017 15:24:28

Highest Channel / Full RB

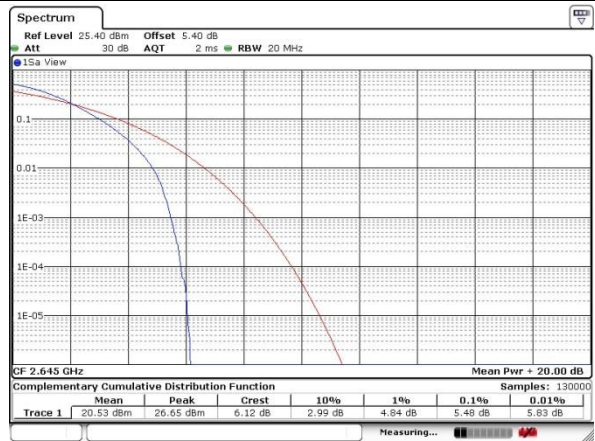

Date: 30 DEC 2017 15:25:58



LTE Band 41 / 20MHz / 16QAM

Lowest Channel / 1RB



Date: 30 DEC 2017 15:19:41

Lowest Channel / Full RB



Date: 30 DEC 2017 15:20:24

Middle Channel / 1RB

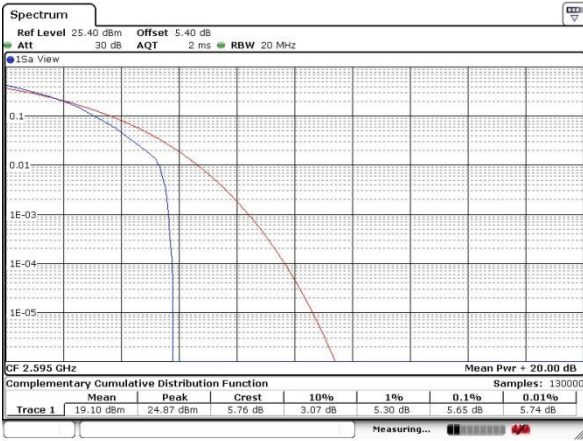

Date: 30 DEC 2017 15:22:37

Middle Channel / Full RB

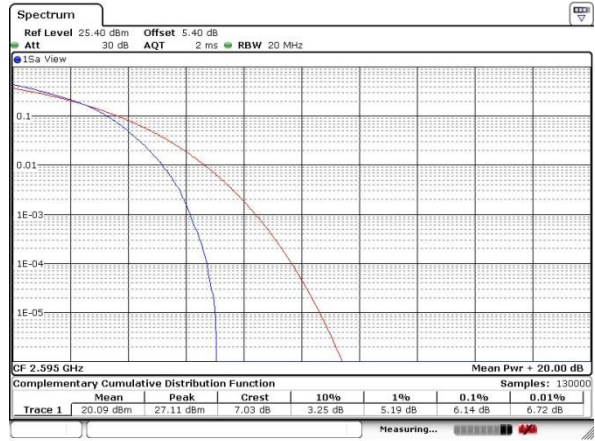

Date: 30 DEC 2017 15:22:06

Highest Channel / 1RB

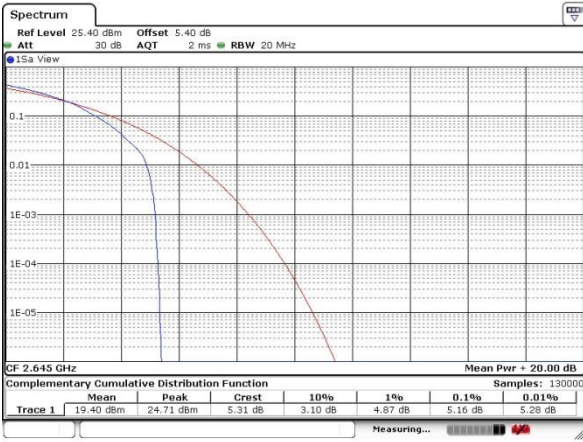

Date: 30 DEC 2017 15:25:00

Highest Channel / Full RB

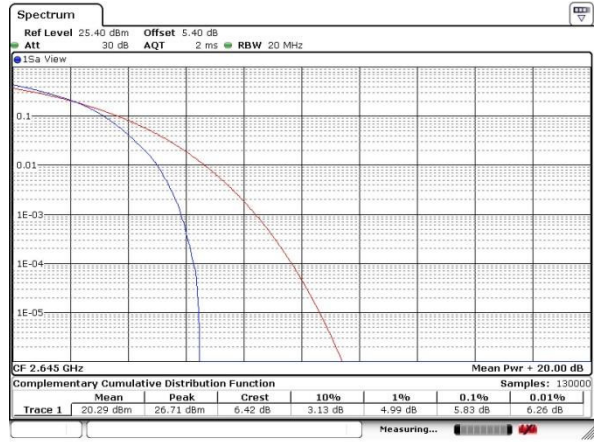

Date: 30 DEC 2017 15:25:30



26dB Bandwidth

| Mode | LTE Band 38 : 26dB BW(MHz) | | | | | | | | | | | |
|------------|----------------------------|-------|------|-------|------|-------|-------|-------|-------|-------|-------|-------|
| | 1.4MHz | | 3MHz | | 5MHz | | 10MHz | | 15MHz | | 20MHz | |
| Mod. | QPSK | 16QAM | QPSK | 16QAM | QPSK | 16QAM | QPSK | 16QAM | QPSK | 16QAM | QPSK | 16QAM |
| Lowest CH | - | - | - | - | 4.89 | 4.93 | 9.69 | 9.63 | 14.33 | 15.76 | 20.22 | 20.10 |
| Middle CH | - | - | - | - | 4.92 | 4.92 | 9.65 | 9.75 | 14.36 | 14.54 | 20.18 | 20.10 |
| Highest CH | - | - | - | - | 4.91 | 4.83 | 9.69 | 9.63 | 14.42 | 14.21 | 20.10 | 20.18 |

| Mode | LTE Band 41 : 26dB BW(MHz) | | | | | | | | | | | |
|------------|----------------------------|-------|------|-------|------|-------|-------|-------|-------|-------|-------|-------|
| | 1.4MHz | | 3MHz | | 5MHz | | 10MHz | | 15MHz | | 20MHz | |
| Mod. | QPSK | 16QAM | QPSK | 16QAM | QPSK | 16QAM | QPSK | 16QAM | QPSK | 16QAM | QPSK | 16QAM |
| Lowest CH | - | - | - | - | 4.88 | 4.97 | 9.63 | 9.93 | 14.24 | 14.24 | 20.06 | 20.1 |
| Middle CH | - | - | - | - | 4.99 | 4.81 | 9.77 | 9.75 | 14.51 | 14.12 | 20.18 | 20.06 |
| Highest CH | - | - | - | - | 4.87 | 5.02 | 9.79 | 9.63 | 14.3 | 14.27 | 20.18 | 19.98 |



LTE Band 38

Lowest Channel / 5MHz / QPSK

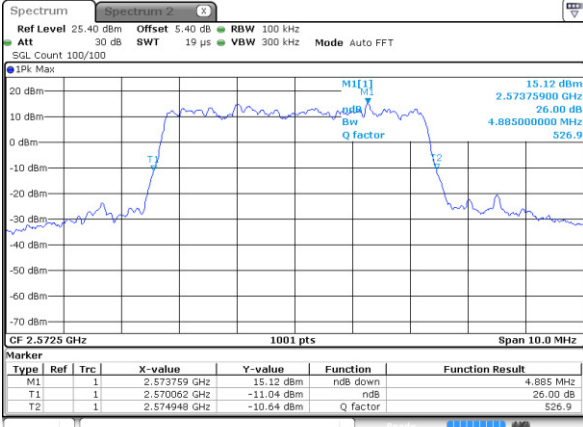

Date: 28 DEC 2017 17:26:42

Lowest Channel / 5MHz / 16QAM

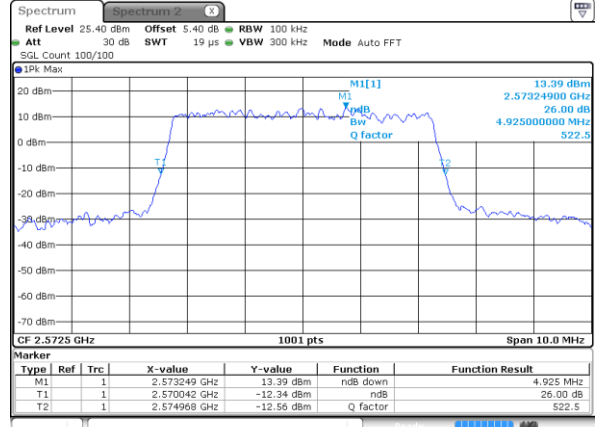

Date: 28 DEC 2017 17:26:52

Middle Channel / 5MHz / QPSK

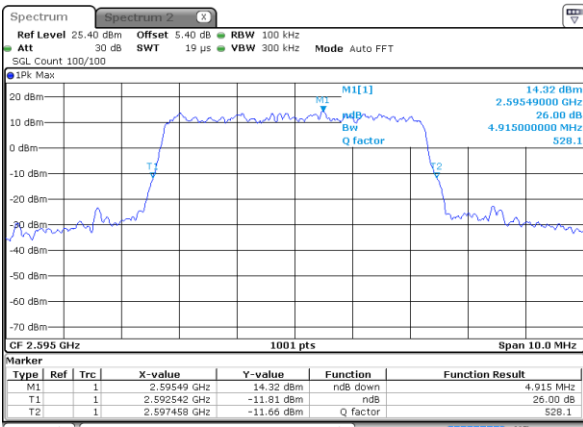

Date: 28 DEC 2017 17:27:24

Middle Channel / 5MHz / 16QAM

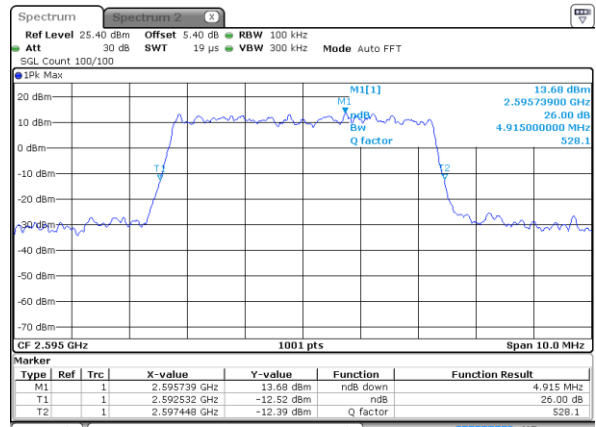

Date: 28 DEC 2017 17:27:35

Highest Channel / 5MHz / QPSK

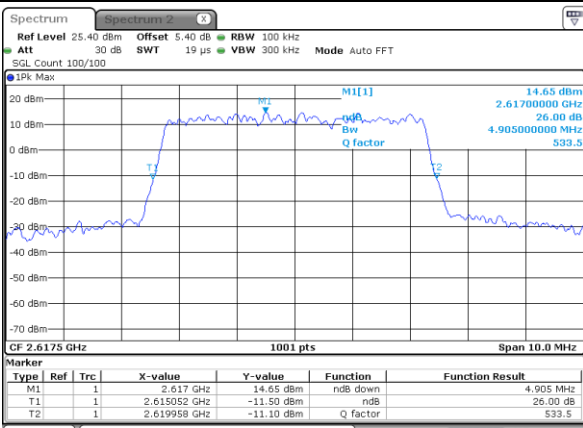

Date: 28 DEC 2017 17:28:07

Highest Channel / 5MHz / 16QAM

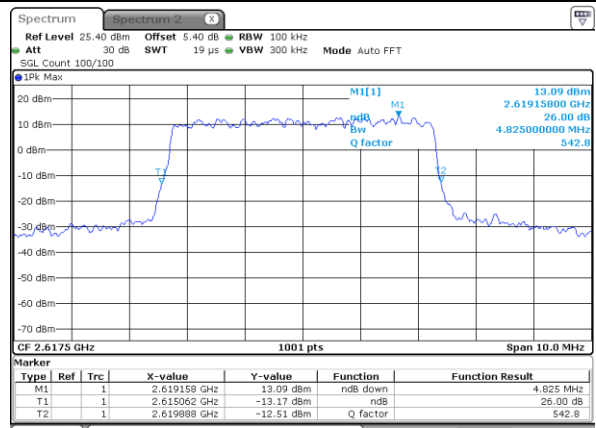

Date: 28 DEC 2017 17:28:17



LTE Band 38

Lowest Channel / 10MHz / QPSK

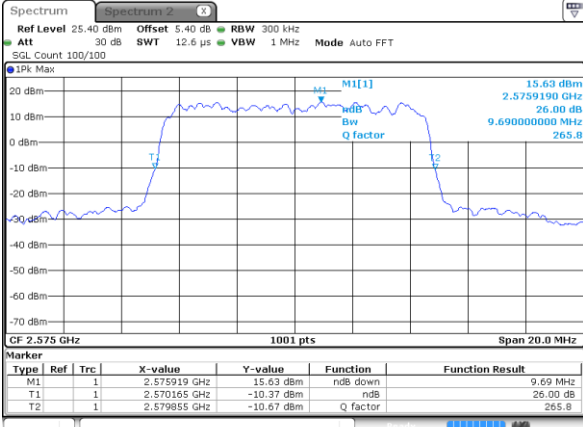

Date: 28 DEC 2017 17:28:49

Lowest Channel / 10MHz / 16QAM

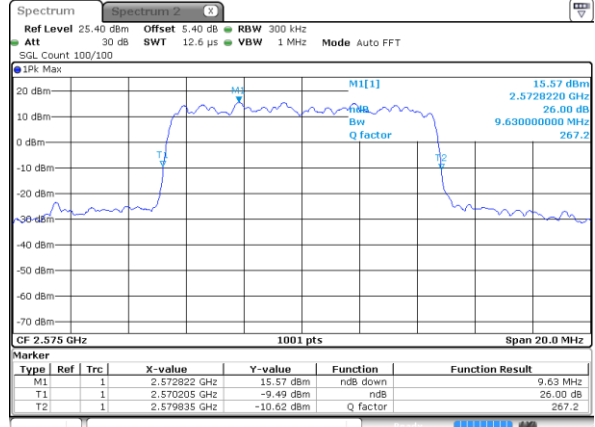

Date: 28 DEC 2017 17:29:00

Middle Channel / 10MHz / QPSK

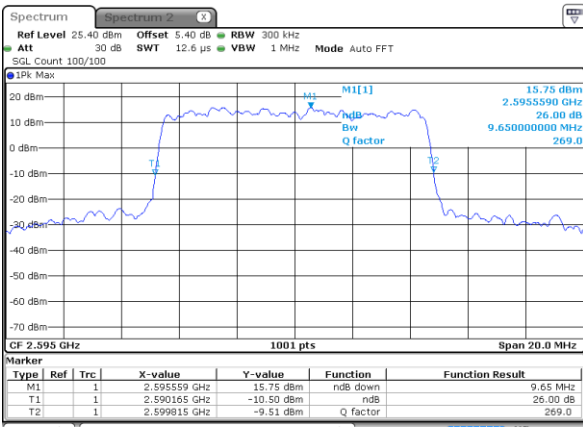

Date: 28 DEC 2017 17:29:32

Middle Channel / 10MHz / 16QAM

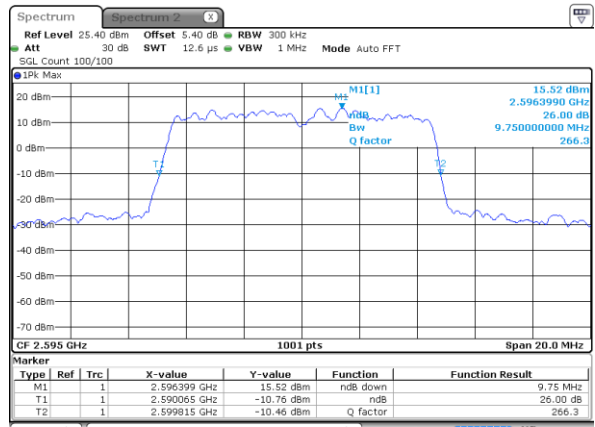

Date: 28 DEC 2017 17:29:42

Highest Channel / 10MHz / QPSK

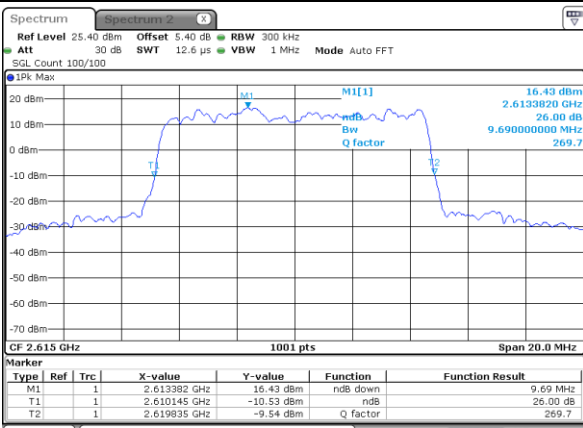

Date: 28 DEC 2017 17:30:14

Highest Channel / 10MHz / 16QAM

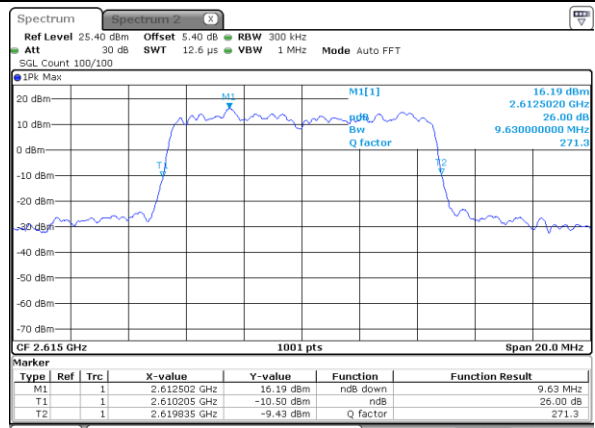

Date: 28 DEC 2017 17:30:25



LTE Band 38

Lowest Channel / 15MHz / QPSK

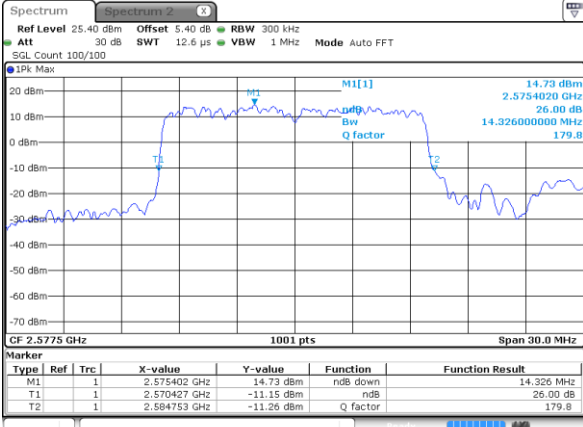

Date: 28 DEC 2017 17:30:57

Lowest Channel / 15MHz / 16QAM

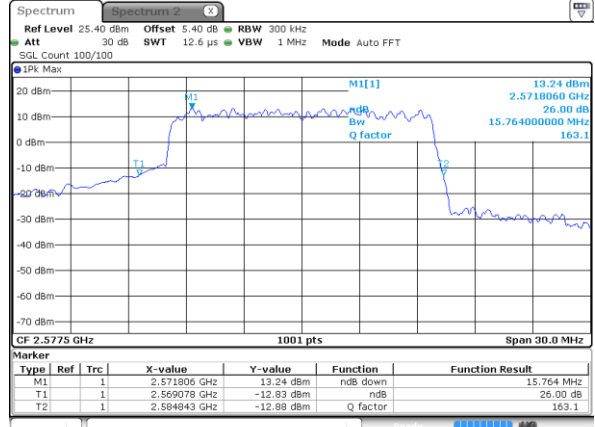

Date: 28 DEC 2017 17:31:08

Middle Channel / 15MHz / QPSK

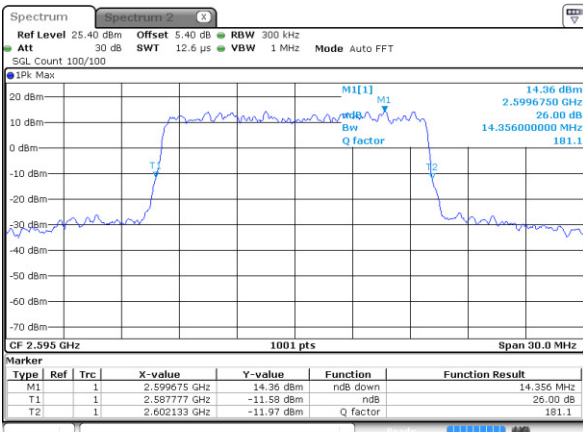

Date: 28 DEC 2017 17:31:40

Middle Channel / 15MHz / 16QAM

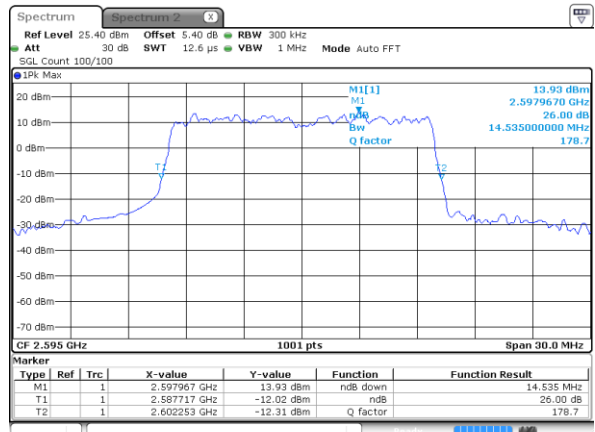

Date: 28 DEC 2017 17:31:50

Highest Channel / 15MHz / QPSK

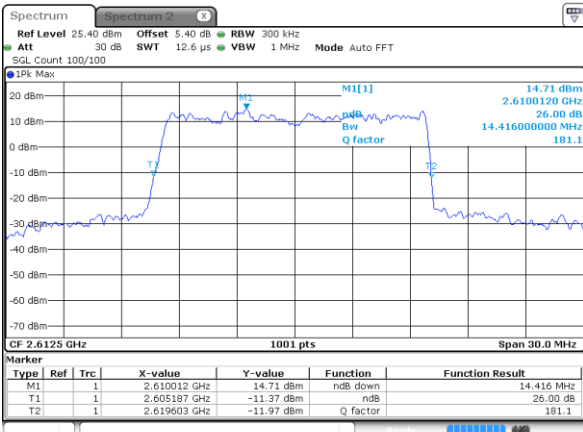

Date: 28 DEC 2017 17:32:22

Highest Channel / 15MHz / 16QAM

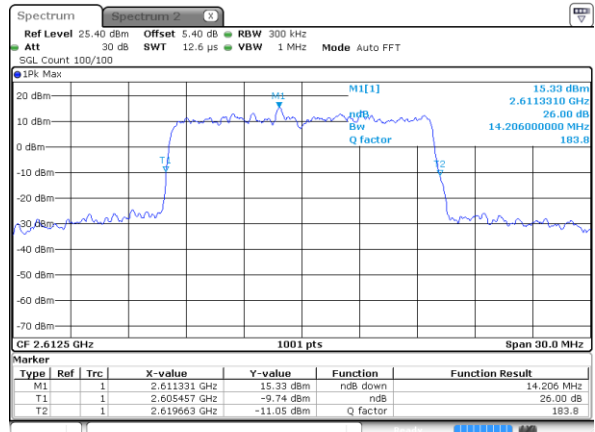

Date: 28 DEC 2017 17:32:33



LTE Band 38

Lowest Channel / 20MHz / QPSK

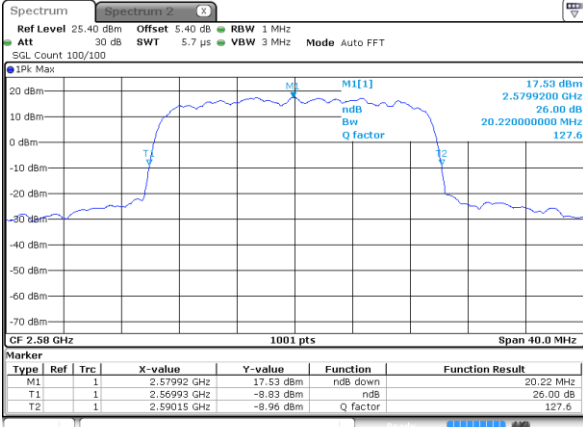

Date: 28 DEC 2017 17:33:05

Lowest Channel / 20MHz / 16QAM

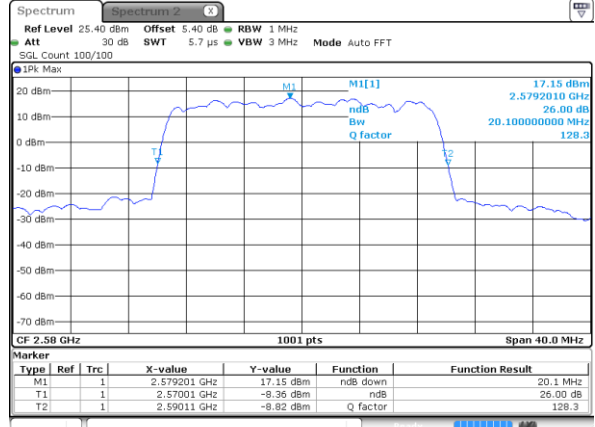

Date: 28 DEC 2017 17:33:15

Middle Channel / 20MHz / QPSK

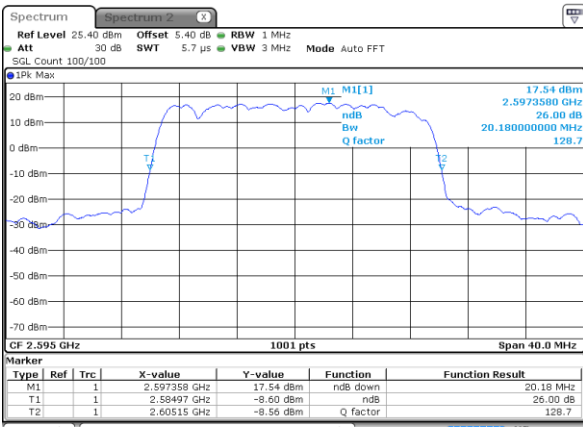

Date: 28 DEC 2017 17:33:47

Middle Channel / 20MHz / 16QAM

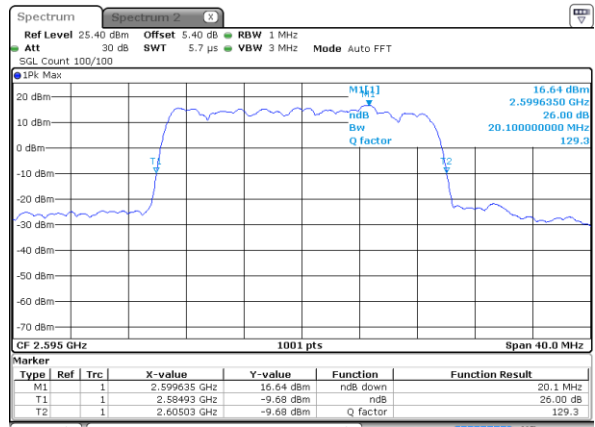

Date: 28 DEC 2017 17:33:58

Highest Channel / 20MHz / QPSK

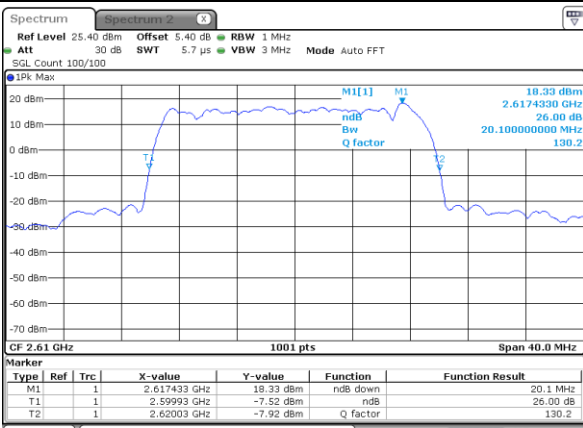

Date: 28 DEC 2017 17:34:30

Highest Channel / 20MHz / 16QAM

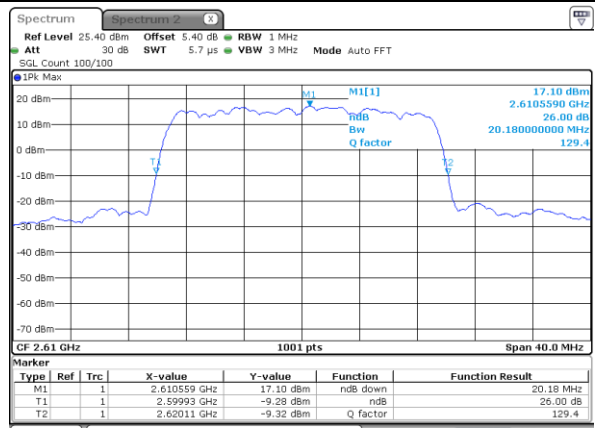

Date: 28 DEC 2017 17:34:40



LTE Band 41

Lowest Channel / 5MHz / QPSK

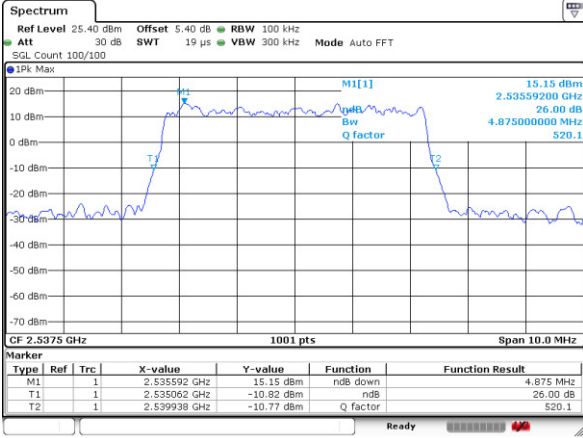

Date: 30 DEC 2017 12:27:27

Lowest Channel / 5MHz / 16QAM

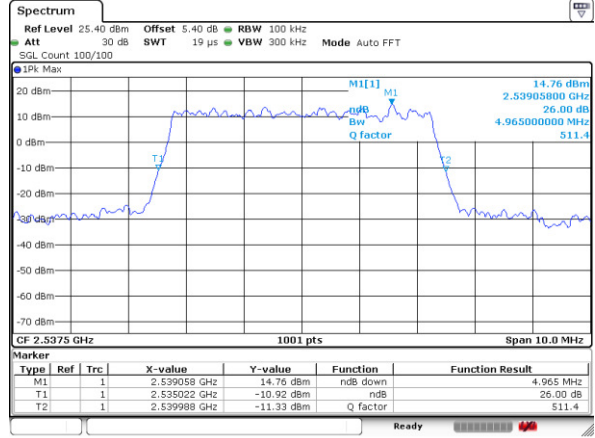

Date: 30 DEC 2017 12:27:10

Middle Channel / 5MHz / QPSK

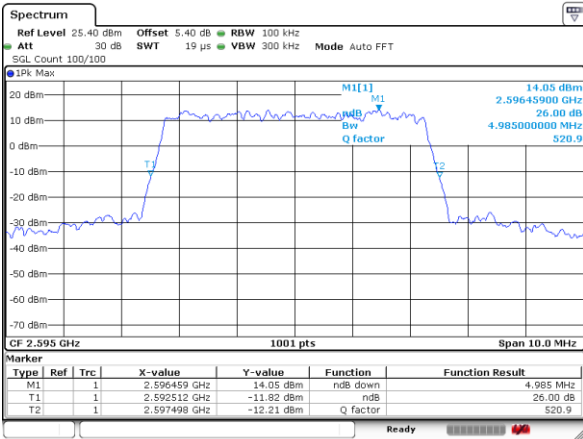

Date: 30 DEC 2017 12:26:10

Middle Channel / 5MHz / 16QAM

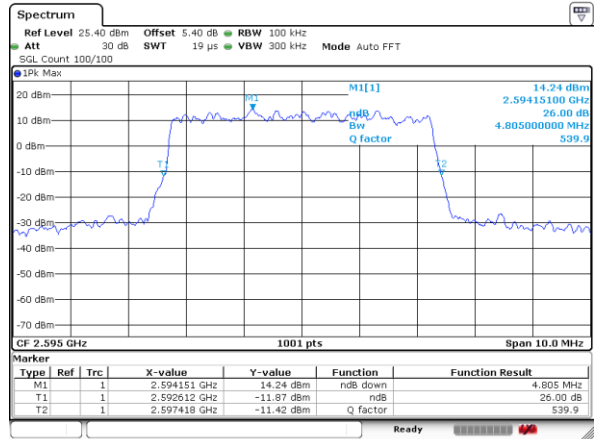

Date: 30 DEC 2017 12:26:41

Highest Channel / 5MHz / QPSK

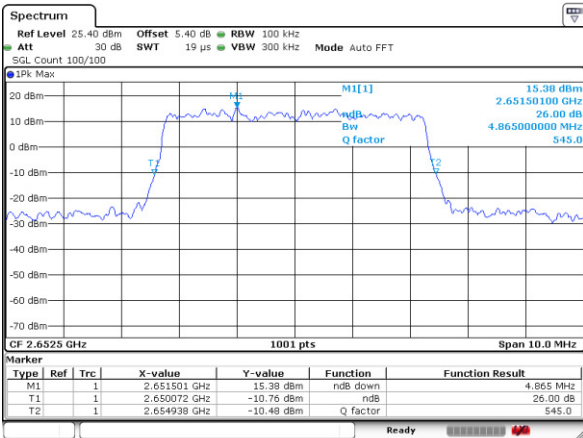

Date: 30 DEC 2017 12:25:46

Highest Channel / 5MHz / 16QAM

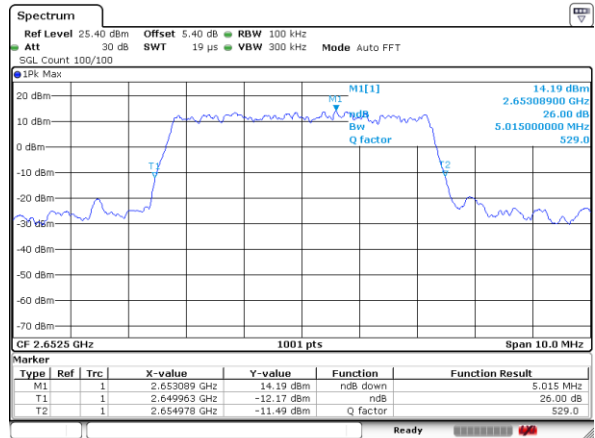

Date: 30 DEC 2017 12:25:32



LTE Band 41

Lowest Channel / 10MHz / QPSK

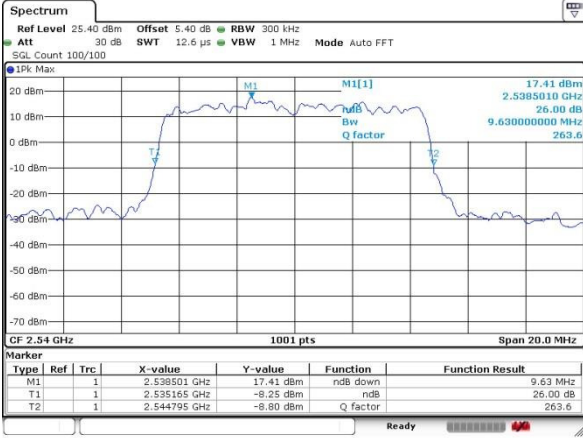

Date: 30 DEC 2017 13:16:45

Lowest Channel / 10MHz / 16QAM

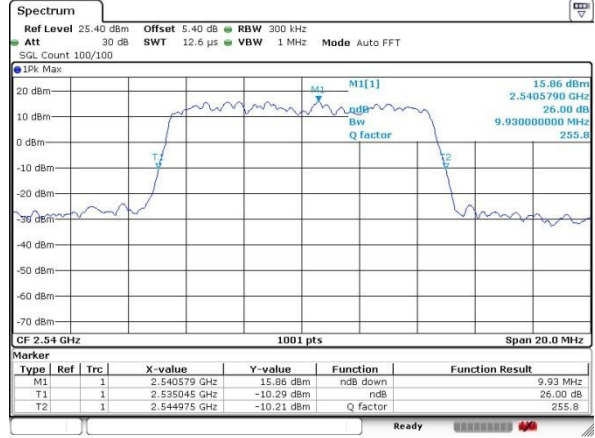

Date: 30 DEC 2017 13:17:54

Middle Channel / 10MHz / QPSK

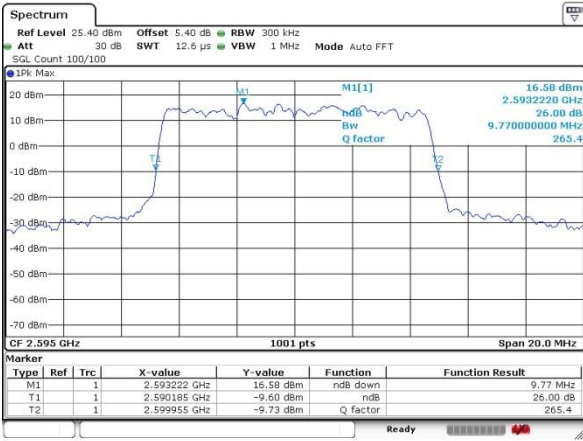

Date: 30 DEC 2017 13:19:16

Middle Channel / 10MHz / 16QAM

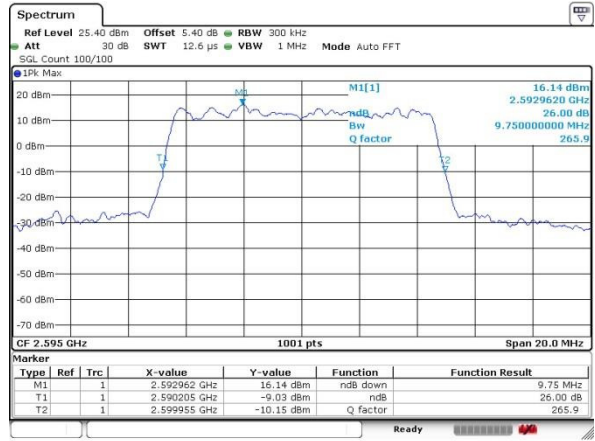

Date: 30 DEC 2017 13:18:36

Highest Channel / 10MHz / QPSK

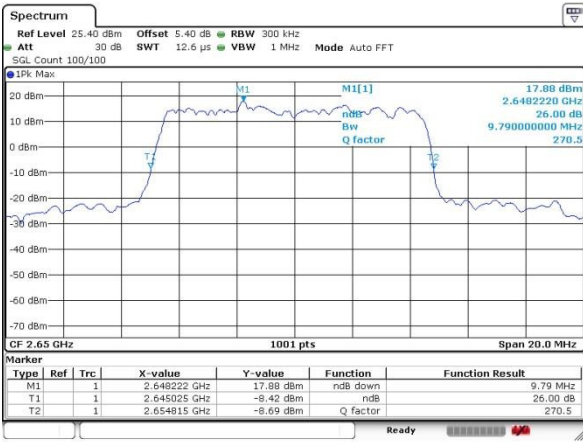

Date: 30 DEC 2017 13:20:03

Highest Channel / 10MHz / 16QAM

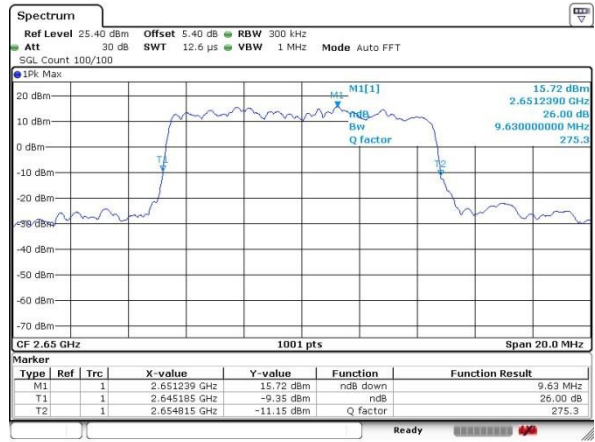

Date: 30 DEC 2017 13:20:40



LTE Band 41

Lowest Channel / 15MHz / QPSK

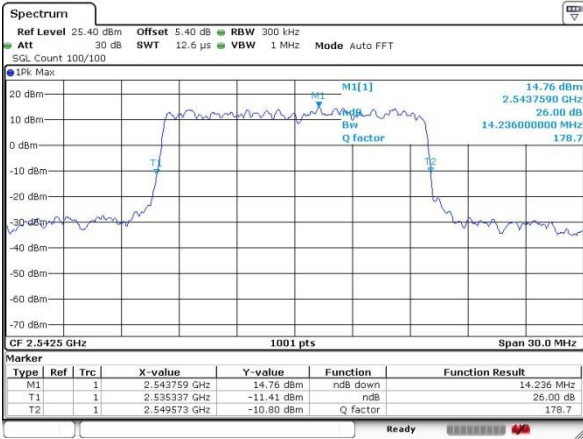

Date: 30 DEC 2017 14:40:29

Lowest Channel / 15MHz / 16QAM

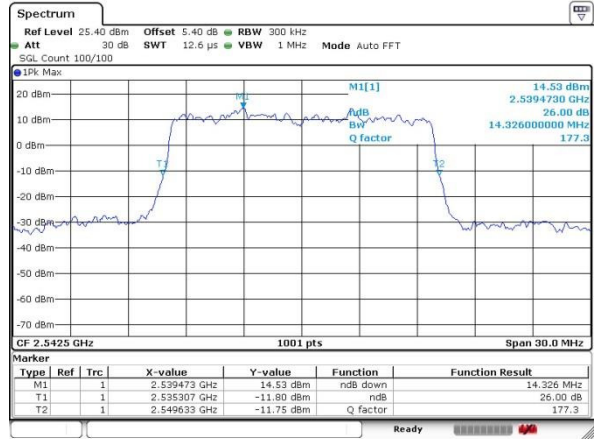

Date: 30 DEC 2017 14:41:09

Middle Channel / 15MHz / QPSK

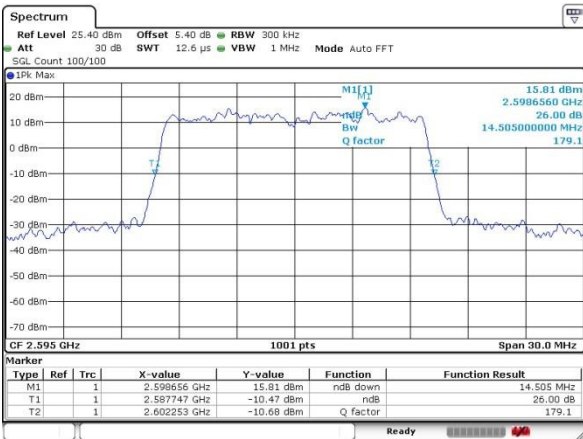

Date: 30 DEC 2017 14:42:08

Middle Channel / 15MHz / 16QAM

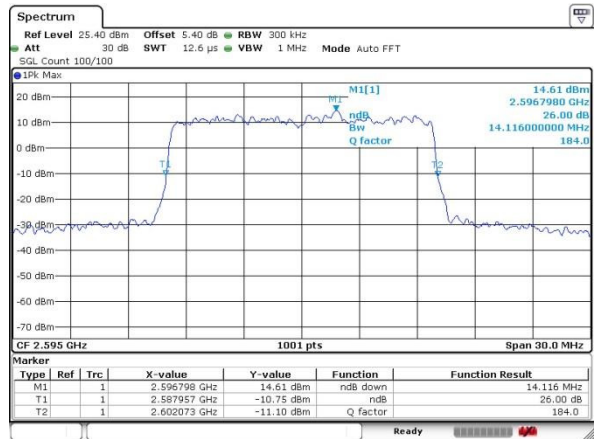

Date: 30 DEC 2017 14:41:42

Highest Channel / 15MHz / QPSK

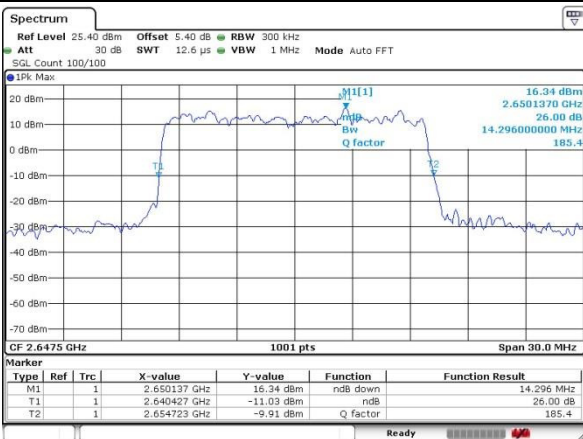

Date: 30 DEC 2017 14:43:18

Highest Channel / 15MHz / 16QAM

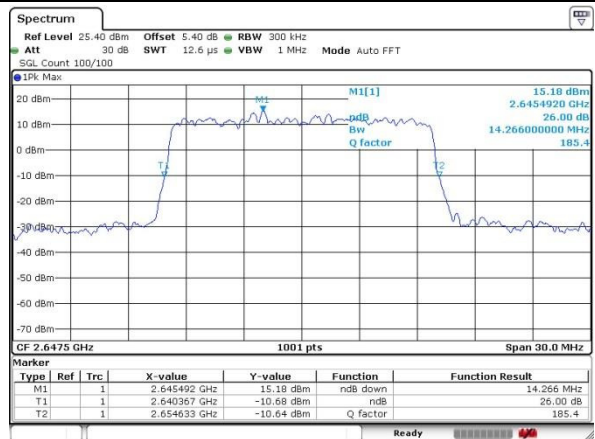

Date: 30 DEC 2017 14:44:00



LTE Band 41

Lowest Channel / 20MHz / QPSK

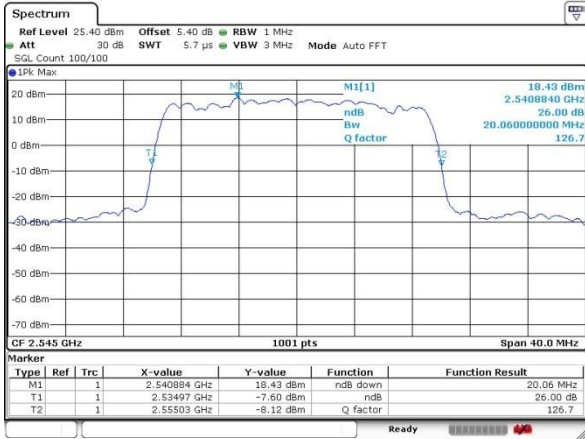

Date: 30 DEC 2017 14:50:20

Lowest Channel / 20MHz / 16QAM

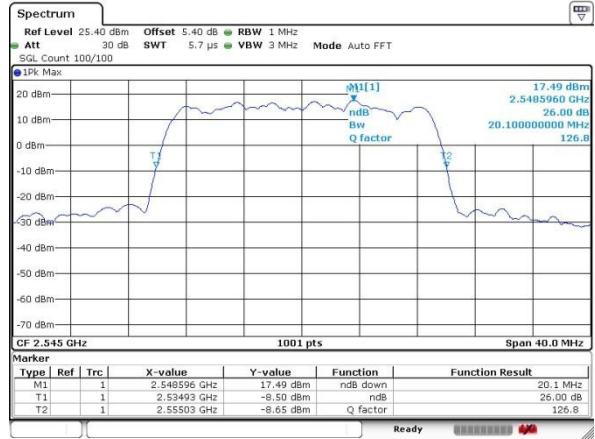

Date: 30 DEC 2017 14:50:48

Middle Channel / 20MHz / QPSK

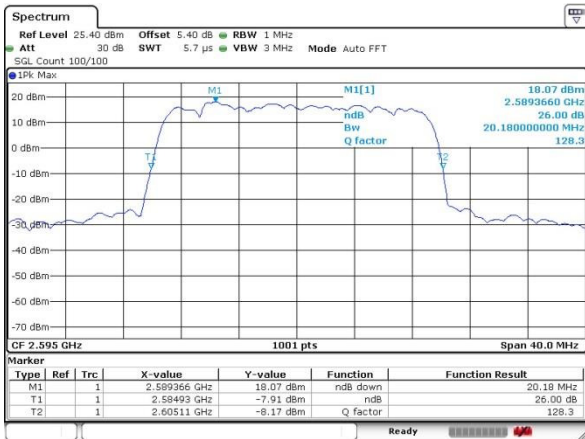

Date: 30 DEC 2017 14:51:38

Middle Channel / 20MHz / 16QAM

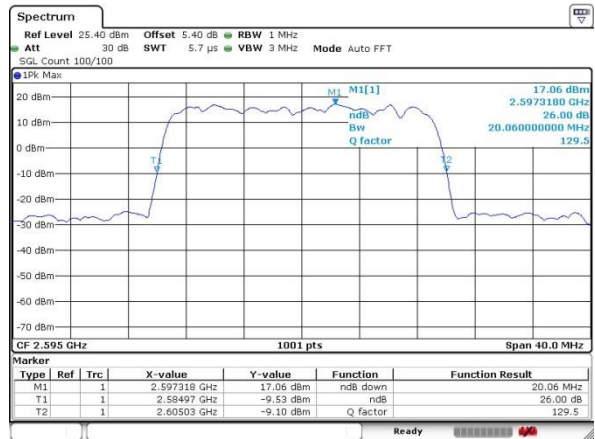

Date: 30 DEC 2017 14:51:17

Highest Channel / 20MHz / QPSK

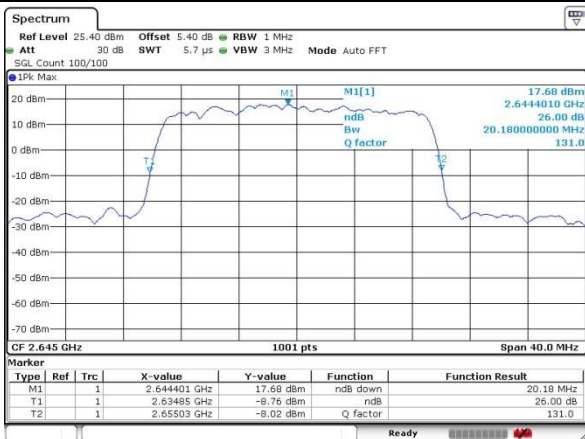

Date: 30 DEC 2017 14:52:25

Highest Channel / 20MHz / 16QAM

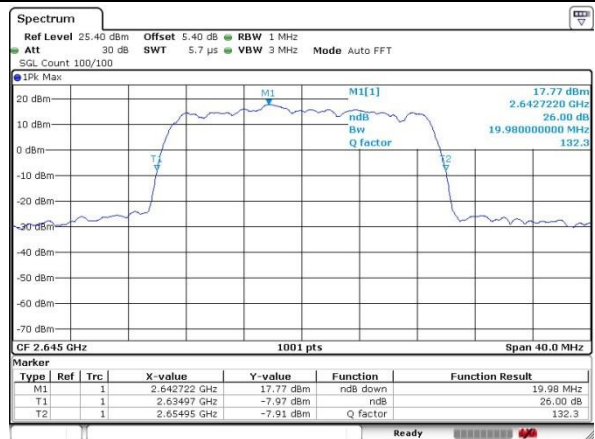

Date: 30 DEC 2017 14:52:54



Occupied Bandwidth

| Mode | LTE Band 38 : 99%OBW(MHz) | | | | | | | | | | | |
|------------|---------------------------|-------|------|-------|------|-------|-------|-------|-------|-------|-------|-------|
| | 1.4MHz | | 3MHz | | 5MHz | | 10MHz | | 15MHz | | 20MHz | |
| Mod. | QPSK | 16QAM | QPSK | 16QAM | QPSK | 16QAM | QPSK | 16QAM | QPSK | 16QAM | QPSK | 16QAM |
| Lowest CH | - | - | - | - | 4.49 | 4.53 | 8.97 | 9.01 | 13.40 | 13.43 | 18.26 | 18.14 |
| Middle CH | - | - | - | - | 4.49 | 4.50 | 8.97 | 9.03 | 13.46 | 13.43 | 18.26 | 18.26 |
| Highest CH | - | - | - | - | 4.50 | 4.50 | 9.09 | 9.09 | 13.46 | 13.40 | 18.42 | 18.30 |

| Mode | LTE Band 41 : 99%OBW(MHz) | | | | | | | | | | | |
|------------|---------------------------|-------|------|-------|------|-------|-------|-------|-------|-------|-------|-------|
| | 1.4MHz | | 3MHz | | 5MHz | | 10MHz | | 15MHz | | 20MHz | |
| Mod. | QPSK | 16QAM | QPSK | 16QAM | QPSK | 16QAM | QPSK | 16QAM | QPSK | 16QAM | QPSK | 16QAM |
| Lowest CH | - | - | - | - | 4.52 | 4.49 | 8.97 | 9.03 | 13.4 | 13.4 | 18.22 | 18.26 |
| Middle CH | - | - | - | - | 4.49 | 4.48 | 9.01 | 8.99 | 13.46 | 13.43 | 18.3 | 18.26 |
| Highest CH | - | - | - | - | 4.51 | 4.49 | 8.99 | 8.99 | 13.43 | 13.4 | 18.18 | 18.22 |



LTE Band 38

Lowest Channel / 5MHz / QPSK

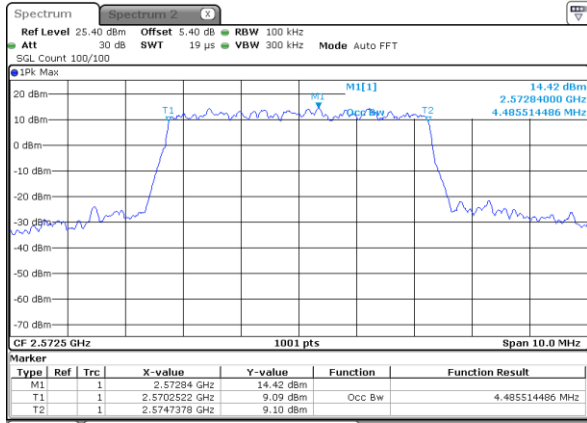

Date: 28 DEC 2017 17:26:20

Lowest Channel / 5MHz / 16QAM

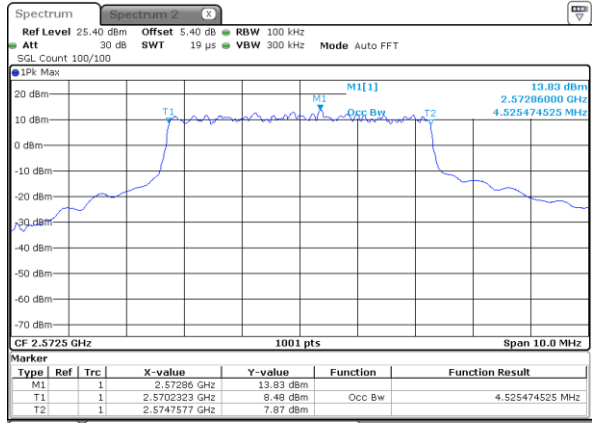

Date: 28 DEC 2017 17:26:31

Middle Channel / 5MHz / QPSK

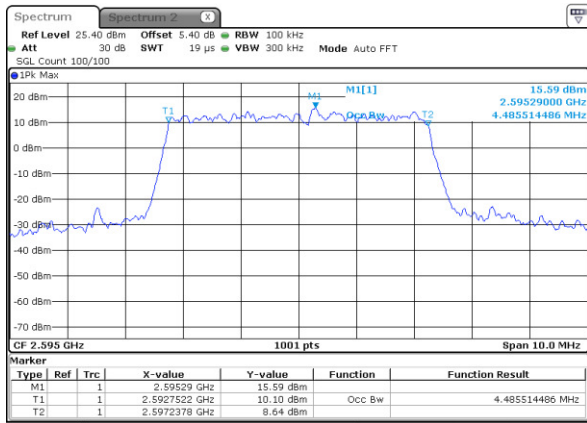

Date: 28 DEC 2017 17:27:03

Middle Channel / 5MHz / 16QAM

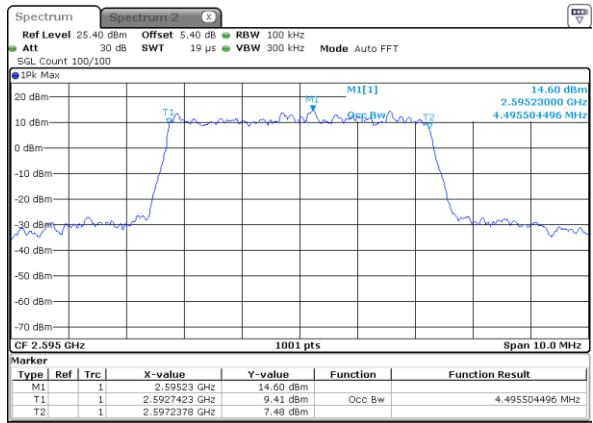

Date: 28 DEC 2017 17:27:14

Highest Channel / 5MHz / QPSK

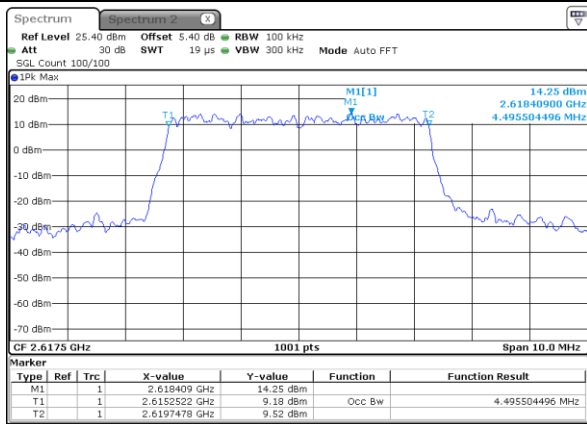

Date: 28 DEC 2017 17:27:45

Highest Channel / 5MHz / 16QAM

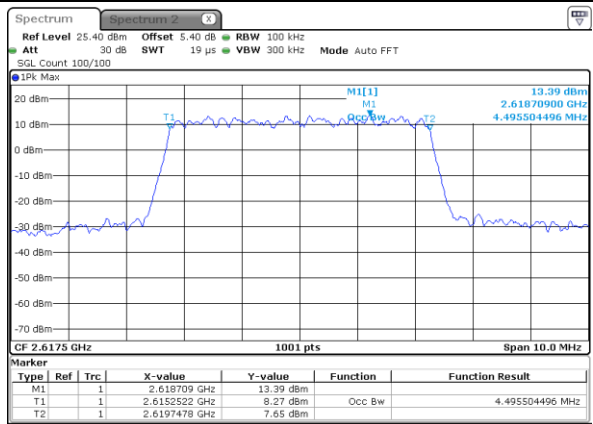

Date: 28 DEC 2017 17:27:56