



# FCC RF Test Report

**APPLICANT** : Motorola Mobility LLC  
**EQUIPMENT** : Mobile Cellular Phone  
**BRAND NAME** : Motorola  
**MODEL NAME** : XT1924-7  
**FCC ID** : IHDT56XA2  
**STANDARD** : FCC 47 CFR Part 2, 22(H), 24(E), 27(L)  
**CLASSIFICATION** : PCS Licensed Transmitter Held to Ear (PCE)

The product was received on Dec. 29, 2017 and testing was completed on Mar. 03, 2018. We, Sporton International (Kunshan) Inc., would like to declare that the tested sample has been evaluated in accordance with the test procedures given in ANSI/TIA-603-E and has been in compliance with the applicable technical standards.

This report contains data that were produced under subcontract by Laboratory SPORTON INTERNATIONAL INC.

The test results in this report apply exclusively to the tested model / sample. Without written approval of Sporton International (Kunshan) Inc., the test report shall not be reproduced except in full.



Approved by: James Huang / Manager

**Sporton International (Kunshan) Inc.**  
**No.3-2 Ping-Xiang Rd, Kunshan Development Zone Kunshan City Jiangsu Province 215335**  
**China**



# TABLE OF CONTENTS

**REVISION HISTORY.....3**

**SUMMARY OF TEST RESULT .....4**

**1 GENERAL DESCRIPTION .....5**

1.1 Applicant.....5

1.2 Manufacturer .....5

1.3 Product Feature of Equipment Under Test .....5

1.4 Product Specification of Equipment Under Test .....6

1.5 Specification of Accessory .....7

1.6 Modification of EUT .....7

1.7 Re-use of Measured Data .....8

1.8 Maximum ERP/EIRP Power, Frequency Tolerance, and Emission Designator .....9

1.9 Testing Location .....9

1.10 Applicable Standards .....10

**2 TEST CONFIGURATION OF EQUIPMENT UNDER TEST .....11**

2.1 Test Mode.....11

2.2 Connection Diagram of Test System .....12

2.3 Support Unit used in test configuration .....12

2.4 Measurement Results Explanation Example .....12

**3 CONDUCTED TEST RESULT .....13**

3.1 Measuring Instruments.....13

3.2 Test Setup .....13

3.3 Test Result of Conducted Test.....13

3.4 Conducted Output Power and ERP/EIRP .....14

3.5 Peak-to-Average Ratio .....14

3.6 99% Occupied Bandwidth and 26dB Bandwidth Measurement.....15

3.7 Conducted Band Edge .....16

3.8 Conducted Spurious Emission .....17

3.9 Frequency Stability .....18

**4 RADIATED TEST ITEMS .....19**

4.1 Measuring Instruments.....19

4.2 Test Setup .....19

4.3 Test Result of Radiated Test.....19

4.4 Field Strength of Spurious Radiation Measurement .....20

**5 LIST OF MEASURING EQUIPMENT .....21**

**6 UNCERTAINTY OF EVALUATION .....22**

**APPENDIX A. TEST RESULTS OF CONDUCTED TEST**

**APPENDIX B. TEST RESULTS OF RADIATED TEST**

**APPENDIX C. TEST SETUP PHOTOGRAPHS**

**APPENDIX D. REFERENCE REPORT**



### REVISION HISTORY

REPORT NO.	VERSION	DESCRIPTION	ISSUED DATE
FG7D2903A	Rev. 01	Initial issue of report	Mar. 08, 2018



### SUMMARY OF TEST RESULT

Report Section	FCC Rule	Description	Limit	Result	Remark
3.4	§2.1046	Conducted Output Power	Reporting Only	PASS	-
	§22.913(a)(2)	Effective Radiated Power	< 7 Watts	PASS	-
	§24.232(c)	Equivalent Isotropic Radiated Power	< 2 Watts	PASS	-
	§27.50(d)(4)	Equivalent Isotropic Radiated Power	< 1 Watts	PASS	-
3.5	§24.232(d)	Peak-to-Average Ratio	< 13 dB	PASS	-
3.6	§2.1049 §22.917(b) §24.238(b) §27.53(g)	Occupied Bandwidth	Reporting Only	PASS	-
3.7	§2.1051 §22.917(a) §24.238(a) §27.53(h)	Band Edge Measurement	< 43+10log10(P[Watts])	PASS	-
3.8	§2.1051 §22.917(a) §24.238(a) §27.53(h)	Conducted Emission	< 43+10log10(P[Watts])	PASS	-
3.9	§2.1055 §22.355	Frequency Stability for Temperature & Voltage	< 2.5 ppm for Part 22H	PASS	-
	§2.1055 §24.235 §27.54		Within Authorized Band		
4.4	§2.1053 §22.917(a) §24.238(a) §27.53(h)	Field Strength of Spurious Radiation	< 43+10log10(P[Watts])	PASS	Under limit 23.41 dB at 2508.000 MHz



# 1 General Description

## 1.1 Applicant

Motorola Mobility LLC  
222 W, Merchandise Mart Plaza, Chicago IL 60654 USA

## 1.2 Manufacturer

Motorola Mobility LLC  
222 W, Merchandise Mart Plaza, Chicago IL 60654 USA

## 1.3 Product Feature of Equipment Under Test

Product Feature	
Equipment	Mobile Cellular Phone
Brand Name	Motorola
Model Name	XT1924-7
FCC ID	IHDT56XA2
EUT supports Radios application	GSM/GPRS/EGPRS/WCDMA/HSPA/ DC-HSDPA/HSPA+(16QAM uplink is not supported)/LTE/ WLAN 2.4GHz 802.11b/g/n HT20/ WLAN 5GHz 802.11a/n HT20/HT40/ Bluetooth v3.0 + EDR/Bluetooth v4.0 LE/ Bluetooth v4.1 LE/Bluetooth v4.2 LE
IMEI Code	Conducted: 351883090027800 Radiation: 351883090028816
HW Version	DVT 1B
SW Version	OPP27.66
EUT Stage	Identical Prototype

**Remark:** The above EUT's information was declared by manufacturer. Please refer to the specifications or user's manual for more detailed description.



### 1.4 Product Specification of Equipment Under Test

Standards-related Product Specification	
<b>Tx Frequency</b>	<b>GSM/GPRS/EDGE:</b> 850: 824.2 MHz ~ 848.8 MHz 1900: 1850.2 MHz ~ 1909.8MHz <b>WCDMA:</b> Band V: 826.4 MHz ~ 846.6 MHz Band II: 1852.4 MHz ~ 1907.6 MHz Band IV: 1712.4 MHz ~ 1752.6 MHz
<b>Rx Frequency</b>	<b>GSM/GPRS/EDGE:</b> 850: 869.2 MHz ~ 893.8 MHz 1900: 1930.2 MHz ~ 1989.8 MHz <b>WCDMA:</b> Band V: 871.4 MHz ~ 891.6 MHz Band II: 1932.4 MHz ~ 1987.6 MHz Band IV: 2112.4 MHz ~ 2152.6 MHz
<b>Maximum Output Power</b>	<b>WCDMA:</b> Band V: 22.93 dBm Band II: 23.21 dBm Band IV: 23.01 dBm
<b>Antenna Type</b>	PIFA Antenna
<b>Antenna Gain</b>	Cellular Band: -2.70 dBi PCS Band: -0.30 dBi AWS Band: -1.1 dBi
<b>Type of Modulation</b>	GSM: GMSK GPRS: GMSK EDGE: GMSK / 8PSK WCDMA : BPSK (Uplink) HSDPA/DC-HSDPA : QPSK (Uplink) HSUPA : QPSK (Uplink) HSPA+ : 16QAM (Uplink is not supported) DC-HSDPA : 64QAM

## 1.5 Specification of Accessory

Specification of Accessory				
AC Adapter 1	Brand Name	Motorola (Salom)	Model Name	SPN5970A SC-22
	Power Rating	I/P: 100-240 Vac, 500mA, O/P: 5 Vdc,3000mA or 9Vdc,1600mA or 12Vdc,1200mA		
AC Adapter 2	Brand Name	Motorola (Chenyang)	Model Name	SPN5993A SC-22
	Power Rating	I/P: 100-240 Vac, 500mA, O/P: 5 Vdc,3000mA or 9Vdc,1600mA or 12Vdc,1200mA		
Earphone	Brand Name	Motorola (NEW Leader)	Model Name	NLD-EM300V-01SF
	Signal Line	1.25 meter, non-shielded cable, without ferrite core		
Battery	Brand Name	Motorola (AmpereX)	Model Name	HE50
	Power Rating	3.8Vdc,4850/5000mAh	Type	Li-ion
USB Cable (Black/White)	Brand Name	Motorola (SaiBao)	Model Name	SLQ-A081A
	Signal Line	1.02 meter, shielded cable, without ferrite core		

## 1.6 Modification of EUT

No modifications are made to the EUT during all test items.



## 1.7 Re-use of Measured Data

### 1.7.1 Introduction Section

This application re-uses data collected on a similar device. The subject device of this application (Model: XT1924-7, FCC ID: IHDT56XA2) is electrically identical to the reference device (Model: XT1924-6, XT1924-8, FCC ID: IHDT56XA1) for the portions of the circuitry corresponding to the data being re-used, as treated by KDB Publication 178919 D01.

### 1.7.2 Difference Section

For details concerning the similarity with respect to component placement, mechanical/electrical design etc., some difference of population/depoulation to enable support of different cellular bands, please refer to the Product Equality Declaration.

The re-used RF data includes the following bands provided in Appendix D (Sporton RF Report No. FG7D2903-01A for the reference device Model: XT1924-6, XT1924-8, FCC ID: IHDT56XA1):

### 1.7.3 Spot Check Verification Data Section

In order to confirm hardware similarity of the subject device with the reference device, spot check measurements were performed on the subject device for radiated spurious emission, Conducted Band-edge and Conducted spurious emission, the test result were consistent with FCC ID: IHDT56XA1 and WCDMA Band II/V/IV to full re-test.

Assertions concerning the similarity of these devices are based on representations by the applicant. The applicant accepts full responsibility for the validity of the similarity claim, and for the determination that verification test data are sufficient to support it.

### 1.7.4 Reference detail Section:

Equipment Class	Reference FCC ID	Folder Test	Report Title/Section
PCE (2G/3G)	IHDT56XA1	Part22H.24E.27L (FG7D2903-01A)	All sections applicable for GSM850/1900
PCE (LTE)	IHDT56XA1	Part22H.24E.27L.27M. 27F.27H (FG7D2903-01B)	All sections applicable for LTE Band 7/12/13





### 1.8 Maximum ERP/EIRP Power, Frequency Tolerance, and Emission Designator

FCC Rule	System	Type of Modulation	Maximum ERP/EIRP (W)	Frequency Tolerance (ppm)	Emission Designator
Part 22H	WCDMA Band V RMC 12.2Kbps	BPSK	0.0643	0.0335 ppm	4M13F9W
Part 24E	WCDMA Band II RMC 12.2Kbps	BPSK	0.1954	0.0160 ppm	4M15F9W
Part 27L	WCDMA Band IV RMC 12.2Kbps	BPSK	0.1552	0.0144 ppm	4M12F9W

### 1.9 Testing Location

Sporton International (Kunshan) Inc. is accredited to ISO 17025 by National Voluntary Laboratory Accreditation Program (NVLAP code: 600155-0) and the FCC designation No. is CN5013.

<b>Test Site</b>	Sporton International (Kunshan) Inc.	
<b>Test Site Location</b>	No.3-2 Ping-Xiang Rd, Kunshan Development Zone Kunshan City Jiangsu Province 215335 China TEL : +86-512-57900158 FAX : +86-512-57900958	
<b>Test Site No.</b>	<b>Sporton Site No.</b>	<b>FCC Test Firm Registration No.</b>
	TH01-KS	630927

**Note:** The test site complies with ANSI C63.4 2014 requirement.

SPORTON INTERNATIONAL INC. is accredited to ISO 17025 by Taiwan Accreditation Foundation (TAF code : 1190) and the FCC designation No. TW0007 under the FCC-recognized accredited testing laboratories by Mutual Recognition Agreement (MRA) in FCC Test.

<b>Test Site</b>	SPORTON INTERNATIONAL INC.	
<b>Test Site Location</b>	No.58, Aly. 75, Ln. 564 Wenha 3rd Rd. Guishan Dist. Taoyuan City Taiwan TEL: +886-3-327-3456 FAX: +886-3-328-4978	
<b>Test Site No.</b>	<b>Sporton Site No.</b>	<b>FCC Test Firm Registration No.</b>
	03CH11-HY	214511

**Note:**

1. The test site complies with ANSI C63.4 2014 requirement.
2. Test data subcontracted: radiated spurious emissions for section 4.4 of this report.



## 1.10 Applicable Standards

According to the specifications of the manufacturer, the EUT must comply with the requirements of the following standards:

- ♦ 47 CFR Part 2, 22(H), 24(E), 27(L)
- ♦ ANSI/TIA-603-E
- ♦ FCC KDB 971168 D01 Power Meas. License Digital Systems v03
- ♦ FCC KDB 412172 D01 Determining ERP and EIRP v01r01

### **Remark:**

1. All test items were verified and recorded according to the standards and without any deviation during the test.
2. This EUT has also been tested and complied with the requirements of FCC Part 15, Subpart B, recorded in a separate test report.



## 2 Test Configuration of Equipment Under Test

### 2.1 Test Mode

Antenna port conducted and radiated test items were performed according to KDB 971168 D01 Power Meas. License Digital Systems v03 with maximum output power.

Radiated measurements were performed with rotating EUT in different three orthogonal test planes to find the maximum emission.

Radiated emissions were investigated as following frequency range:

1. 30 MHz to 10th harmonic for WCDMA Band V.
2. 30 MHz to 10th harmonic for WCDMA Band IV.
3. 30 MHz to 10th harmonic for WCDMA Band II.

All modes and data rates and positions were investigated.

Test modes are chosen to be reported as the worst case configuration below:

Test Modes		
Band	Radiated TCs	Conducted TCs
WCDMA Band V	■ RMC 12.2Kbps Link	■ RMC 12.2Kbps Link
WCDMA Band II	■ RMC 12.2Kbps Link	■ RMC 12.2Kbps Link
WCDMA Band IV	■ RMC 12.2Kbps Link	■ RMC 12.2Kbps Link

## 2.2 Connection Diagram of Test System

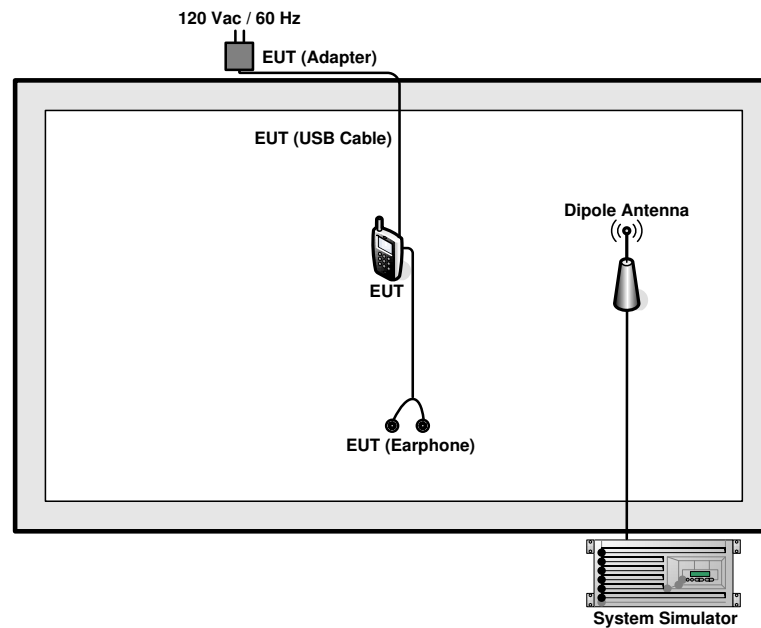

## 2.3 Support Unit used in test configuration

Item	Equipment	Trade Name	Model No.	FCC ID	Data Cable	Power Cord
1.	System Simulator	R&S	CMU 200	N/A	N/A	Unshielded, 1.8 m
2.	DC Power Supply	GW INSTEK	GPS-3030D	N/A	N/A	Unshielded, 1.8 m

## 2.4 Measurement Results Explanation Example

### For all conducted test items:

The offset level is set in the spectrum analyzer to compensate the RF cable loss and attenuator factor between RF conducted output port and spectrum analyzer. With the offset compensation, the spectrum analyzer reading level will be exactly the RF output level.

The spectrum analyzer offset is derived from RF cable loss and attenuator factor.

*Offset = RF cable loss + attenuator factor.*

The following shows an offset computation example with RF cable loss 4.4 dB and a 10dB attenuator.

Example :

$$\begin{aligned} \text{Offset(dB)} &= \text{RF cable loss(dB)} + \text{attenuator factor(dB)} \\ &= 4.4 + 10 = 14.4 \text{ (dB)} \end{aligned}$$

### 3 Conducted Test Result

#### 3.1 Measuring Instruments

See list of measuring instruments of this test report.

#### 3.2 Test Setup

##### 3.2.1 Conducted Output Power



##### 3.2.2 Peak-to-Average Ratio, Occupied Bandwidth, Conducted Band-Edge and Conducted Spurious Emission

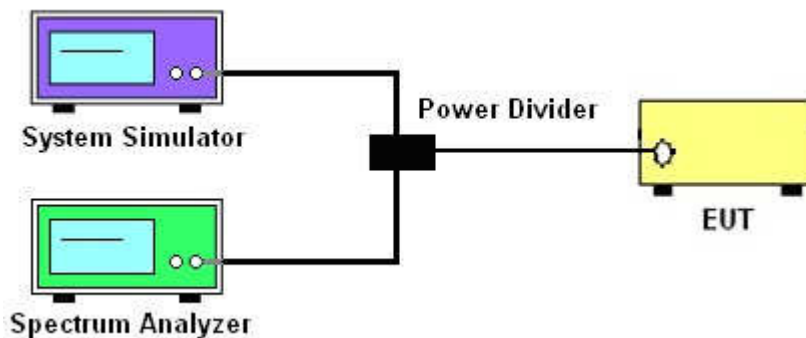

##### 3.2.3 Frequency Stability

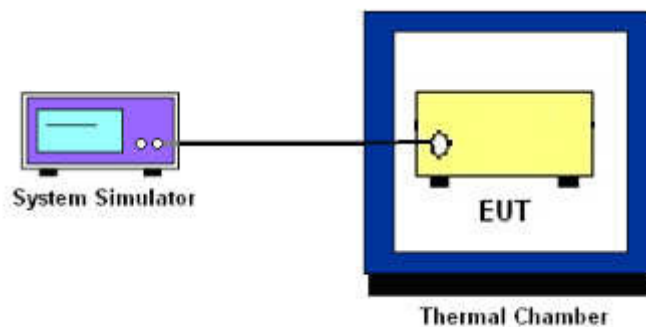

### 3.3 Test Result of Conducted Test

Please refer to Appendix A.



### 3.4 Conducted Output Power and ERP/EIRP

#### 3.4.1 Description of the Conducted Output Power and ERP/EIRP

A system simulator was used to establish communication with the EUT. Its parameters were set to enforce EUT transmitting at the maximum power. The measured power in the radio frequency on the transmitter output terminals shall be reported.

The ERP of mobile transmitters must not exceed 7 Watts for WCDMA Band V.

The EIRP of mobile transmitters must not exceed 2 Watts for WCDMA Band II.

The EIRP of mobile transmitters must not exceed 1 Watts for WCDMA Band IV.

According to KDB 412172 D01 Power Approach,

$EIRP = P_T + G_T - L_C$ ,  $ERP = EIRP - 2.15$ , where

$P_T$  = transmitter output power in dBm

$G_T$  = gain of the transmitting antenna in dBi

$L_C$  = signal attenuation in the connecting cable between the transmitter and antenna in dB

#### 3.4.2 Test Procedures

1. The transmitter output port was connected to the system simulator.
2. Set EUT at maximum power through system simulator.
3. Select lowest, middle, and highest channels for each band and different modulation.
4. Measure the maximum burst average power for WCDMA.

### 3.5 Peak-to-Average Ratio

#### 3.5.1 Description of the PAR Measurement

The peak-to-average ratio (PAR) of the transmission may not exceed 13 dB.

#### 3.5.2 Test Procedures

1. The testing follows FCC KDB 971168 D01 v03 Section 5.7.1.
2. The EUT was connected to spectrum analyzer and system simulator via a power divider.
3. Set EUT to transmit at maximum output power.
4. When the duty cycle is less than 98%, then signal gating will be implemented on the spectrum analyzer by triggering from the system simulator.
5. Set the CCDF (Complementary Cumulative Distribution Function) option of the spectrum analyzer.  
Record the maximum PAPR level associated with a probability of 0.1%.



### 3.6 99% Occupied Bandwidth and 26dB Bandwidth Measurement

#### 3.6.1 Description of 99% Occupied Bandwidth and 26dB Bandwidth Measurement

The occupied bandwidth is the width of a frequency band such that, below the lower and above the upper frequency limits, the mean powers emitted are each equal to a specified percentage 0.5% of the total mean transmitted power.

The 26 dB emission bandwidth is defined as the frequency range between two points, one above and one below the carrier frequency, at which the spectral density of the emission is attenuated 26 dB below the maximum in-band spectral density of the modulated signal. Spectral density (power per unit bandwidth) is to be measured with a detector of resolution bandwidth equal to approximately 1.0% of the emission bandwidth.

#### 3.6.2 Test Procedures

1. The testing follows FCC KDB 971168 v03 Section 4.2.
2. The EUT was connected to spectrum analyzer and system simulator via a power divider.
3. The spectrum analyzer center frequency is set to the nominal EUT channel center frequency. The span range for the spectrum analyzer shall be between two and five times the anticipated OBW.
4. The nominal resolution bandwidth (RBW) shall be in the range of 1 to 5 % of the anticipated OBW, and the VBW shall be at least 3 times the RBW.
5. Set the detection mode to peak, and the trace mode to max hold.
6. Determine the reference value: Set the EUT to transmit a modulated signal. Allow the trace to stabilize. Set the spectrum analyzer marker to the highest level of the displayed trace.  
(this is the reference value)
7. Determine the “-26 dB down amplitude” as equal to (Reference Value – X).
8. Place two markers, one at the lowest and the other at the highest frequency of the envelope of the spectral display such that each marker is at or slightly below the “-X dB down amplitude” determined in step 6. If a marker is below this “-X dB down amplitude” value it shall be placed as close as possible to this value. The OBW is the positive frequency difference between the two markers.
9. Use the 99 % power bandwidth function of the spectrum analyzer and report the measured bandwidth.



## 3.7 Conducted Band Edge

### 3.7.1 Description of Conducted Band Edge Measurement

The power of any emission outside of the authorized operating frequency ranges must be lower than the transmitter power (P) by a factor of at least  $43 + 10 \log (P)$  dB.

### 3.7.2 Test Procedures

1. The testing follows FCC KDB 971168 D01 v03 Section 6.0.
2. The EUT was connected to the spectrum analyzer and system simulator via a power divider.
3. The RF output of EUT was connected to the spectrum analyzer by an RF cable and attenuator. The path loss was compensated to the results for each measurement.
4. The band edges of low and high channels for the highest RF powers were measured.
5. The RF fundamental frequency should be excluded against the limit line in the operating frequency band.
6. The limit line is derived from  $43 + 10\log(P)$  dB below the transmitter power P(Watts)  
 $= P(W) - [43 + 10\log(P)]$  (dB)  
 $= [30 + 10\log(P)]$  (dBm) -  $[43 + 10\log(P)]$  (dB)  
 $= -13\text{dBm}$ .





### 3.8 Conducted Spurious Emission

#### 3.8.1 Description of Conducted Spurious Emission Measurement

The power of any emission outside of the authorized operating frequency ranges must be lower than the transmitter power (P) by a factor of at least  $43 + 10 \log (P)$  dB.

It is measured by means of a calibrated spectrum analyzer and scanned from 30 MHz up to a frequency including its 10<sup>th</sup> harmonic.

#### 3.8.2 Test Procedures

1. The testing follows FCC KDB 971168 D01 v03 Section 6.0.
2. The EUT was connected to the spectrum analyzer and system simulator via a power divider.
3. The RF output of EUT was connected to the spectrum analyzer by an RF cable and attenuator. The path loss was compensated to the results for each measurement.
4. The middle channel for the highest RF power within the transmitting frequency was measured.
5. The conducted spurious emission for the whole frequency range was taken.
6. The RF fundamental frequency should be excluded against the limit line in the operating frequency band.
7. The limit line is derived from  $43 + 10\log(P)$  dB below the transmitter power P(Watts)  
=  $P(W) - [43 + 10\log(P)]$  (dB)  
=  $[30 + 10\log(P)]$  (dBm) -  $[43 + 10\log(P)]$  (dB)  
= -13dBm.



## **3.9 Frequency Stability**

### **3.9.1 Description of Frequency Stability Measurement**

The frequency stability shall be measured by variation of ambient temperature and variation of primary supply voltage to ensure that the fundamental emission stays within the authorized frequency block. The frequency stability of the transmitter shall be maintained within  $\pm 0.00025\%$  ( $\pm 2.5\text{ppm}$ ) of the center frequency.

### **3.9.2 Test Procedures for Temperature Variation**

1. The testing follows FCC KDB 971168 D01 v03 Section 9.0.
2. The EUT was set up in the thermal chamber and connected with the system simulator.
3. With power OFF, the temperature was decreased to  $-30^{\circ}\text{C}$  and the EUT was stabilized before testing. Power was applied and the maximum change in frequency was recorded within one minute.
4. With power OFF, the temperature was raised in  $10^{\circ}\text{C}$  steps up to  $50^{\circ}\text{C}$ . The EUT was stabilized at each step for at least half an hour. Power was applied and the maximum frequency change was recorded within one minute.

### **3.9.3 Test Procedures for Voltage Variation**

1. The testing follows FCC KDB 971168 D01 v03 Section 9.0.
2. The EUT was placed in a temperature chamber at  $20\pm 5^{\circ}\text{C}$  and connected with the system simulator.
3. The power supply voltage to the EUT was varied from 85% to 115% of the nominal value measured at the input to the EUT.
4. The variation in frequency was measured for the worst case.

## 4 Radiated Test Items

### 4.1 Measuring Instruments

See list of measuring instruments of this test report.

### 4.2 Test Setup

#### 4.2.1 For radiated test from 30MHz to 1GHz

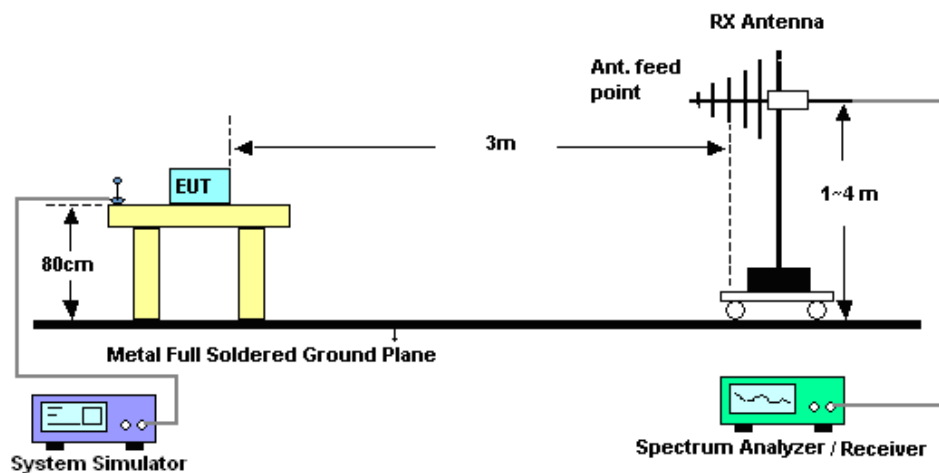

#### 4.2.2 For radiated test above 1GHz

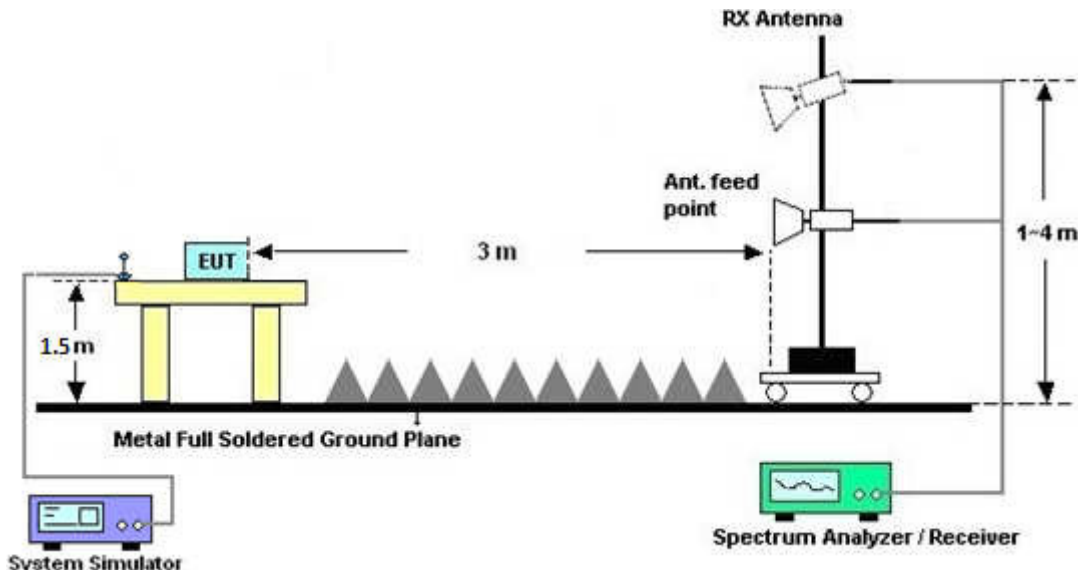

### 4.3 Test Result of Radiated Test

Please refer to Appendix B.



## 4.4 Field Strength of Spurious Radiation Measurement

### 4.4.1 Description of Field Strength of Spurious Radiated Measurement

The power of any emission outside of the authorized operating frequency ranges must be attenuated below the transmitter power (P) by a factor of at least  $43 + 10 \log (P)$  dB. The spectrum is scanned from 30 MHz up to a frequency including its 10th harmonic.

### 4.4.2 Test Procedures

1. The testing follows FCC KDB 971168 D01 v03 Section 5.8 and ANSI/TIA-603-E Section 2.2.12.
2. The EUT was placed on a rotatable wooden table 0.8 meters for frequency below 1GHz and 1.5 meter for frequency above 1GHz above the ground.
3. The EUT was set 3 meters from the receiving antenna, which was mounted on the antenna tower.
4. The table was rotated 360 degrees to determine the position of the highest spurious emission.
5. The height of the receiving antenna is varied between one meter and four meters to search for the maximum spurious emission for both horizontal and vertical polarizations.
6. Make the measurement with the spectrum analyzer's RBW = 1MHz, VBW = 3MHz, taking record of maximum spurious emission.
7. A horn antenna was substituted in place of the EUT and was driven by a signal generator.
8. Tune the output power of signal generator to the same emission level with EUT maximum spurious emission.
9. Taking the record of output power at antenna port.
10. Repeat step 7 to step 8 for another polarization.
11.  $EIRP \text{ (dBm)} = S.G. \text{ Power} - Tx \text{ Cable Loss} + Tx \text{ Antenna Gain}$
12.  $ERP \text{ (dBm)} = EIRP - 2.15$
13. The RF fundamental frequency should be excluded against the limit line in the operating frequency band.
14. The limit line is derived from  $43 + 10\log(P)$  dB below the transmitter power P(Watts)  
 $= P(W) - [43 + 10\log(P)] \text{ (dB)}$   
 $= [30 + 10\log(P)] \text{ (dBm)} - [43 + 10\log(P)] \text{ (dB)}$   
 $= -13\text{dBm}.$



## 5 List of Measuring Equipment

Instrument	Manufacturer	Model No.	Serial No.	Characteristics	Calibration Date	Test Date	Due Date	Remark
Spectrum Analyzer	R&S	FSV40	101040	10Hz~40GHz	Aug. 08, 2017	Jan. 12, 2018	Aug. 07, 2018	Conducted (TH01-KS)
Radio communication analyzer	Anritsu	MT8820C	6201300652	2G/3G/LTE_ full band	Aug. 08, 2017	Jan. 12, 2018	Aug. 07, 2018	Conducted (TH01-KS)
Thermal Chamber	Ten Billion	TTC-B3S	TBN-960502	-40~+150°C	Oct. 12, 2017	Jan. 12, 2018	Oct. 11, 2018	Conducted (TH01-KS)
Amplifier	MITEQ	TTA1840-35-HG	1871923	18GHz~40GHz, VS WR : 2.5:1 max	Jul. 18, 2017	Mar. 02, 2018~ Mar. 03, 2018	Jul. 17, 2018	Radiation (03CH11-HY)
Amplifier	SONOMA	310N	187312	9kHz~1GHz	Nov. 10, 2017	Mar. 02, 2018~ Mar. 03, 2018	Nov. 09, 2018	Radiation (03CH11-HY)
Bilog Antenna	TESEQ	CBL 6111D&N-6-	35414&AT-N0 602	30MHz~1GHz	Oct. 14, 2017	Mar. 02, 2018~ Mar. 03, 2018	Oct. 13, 2018	Radiation (03CH11-HY)
Horn Antenna	SCHWARZBECK	BBHA 9120 D	9120D-1326	1GHz ~ 18GHz	Oct. 16, 2017	Mar. 02, 2018~ Mar. 03, 2018	Oct. 15, 2018	Radiation (03CH11-HY)
Preamplifier	Keysight	83017A	MY53270080	1GHz~26.5GHz	Nov. 10, 2017	Mar. 02, 2018~ Mar. 03, 2018	Nov. 09, 2018	Radiation (03CH11-HY)
Spectrum Analyzer	Keysight	N9010A	MY54200486	10Hz ~ 44GHz	Oct. 19, 2017	Mar. 02, 2018~ Mar. 03, 2018	Oct. 18, 2018	Radiation (03CH11-HY)
Filter	Wainwright	WHKX12-10 80-1200-15	SN2	1.2G High Pass	Sep. 18, 2017	Mar. 02, 2018~ Mar. 03, 2018	Sep. 17, 2018	Radiation (03CH11-HY)
Filter	Wainwright	WHKX12-27 00-3000-18	SN3	2.7G High Pass	Sep. 18, 2017	Mar. 02, 2018~ Mar. 03, 2018	Sep. 17, 2018	Radiation (03CH11-HY)
Controller	E MEC	EM 1000	N/A	Control Turn table & Ant Mast	NCR	Mar. 02, 2018~ Mar. 03, 2018	NCR	Radiation (03CH11-HY)
Antenna Mast	E MEC	AM-BS-450 0-B	N/A	1~4m	NCR	Mar. 02, 2018~ Mar. 03, 2018	NCR	Radiation (03CH11-HY)
Turn Table	E MEC	TT 2000	N/A	0~360 Degree	NCR	Mar. 02, 2018~ Mar. 03, 2018	NCR	Radiation (03CH11-HY)
SHF-EHF Horn Antenna	SCHWARZBECK	BBHA 9170	BBHA917057 6	18GHz- 40GHz	Apr. 27, 2017	Mar. 02, 2018~ Mar. 03, 2018	Apr. 26, 2018	Radiation (03CH11-HY)

NCR: No Calibration Required



## 6 Uncertainty of Evaluation

### Uncertainty of Radiated Emission Measurement (30 MHz ~ 1000 MHz)

Measuring Uncertainty for a Level of Confidence of 95% ( $U = 2Uc(y)$ )	3.4dB
---	-------

### Uncertainty of Radiated Emission Measurement (1 GHz ~ 18 GHz)

Measuring Uncertainty for a Level of Confidence of 95% ( $U = 2Uc(y)$ )	3.7dB
---	-------

### Uncertainty of Radiated Emission Measurement (18 GHz ~ 40 GHz)

Measuring Uncertainty for a Level of Confidence of 95% ( $U = 2Uc(y)$ )	4.0dB
---	-------



## Appendix A. Test Results of Conducted Test

### Conducted Output Power (Average power)

Conducted Power (*Unit: dBm)									
Band	WCDMA Band V			WCDMA Band II			WCDMA Band IV		
Channel	4132	4182	4233	9262	9400	9538	1312	1413	1513
Frequency	826.4	836.4	846.6	1852.4	1880	1907.6	1712.4	1732.6	1752.6
AMR 12.2K	22.91	22.81	22.85	23.00	23.19	23.06	22.98	22.91	22.84
RMC 12.2K	22.93	22.83	22.87	23.02	23.21	23.08	23.01	22.93	22.86
HSDPA Subtest-1	21.96	21.86	21.88	22.10	22.19	22.14	22.16	22.06	22.01
HSDPA Subtest-2	21.94	21.83	21.89	22.09	22.17	22.15	22.18	22.09	21.98
HSDPA Subtest-3	21.41	21.30	21.37	21.49	21.60	21.52	21.54	21.49	21.38
HSDPA Subtest-4	21.44	21.26	21.35	21.47	21.56	21.55	21.56	21.46	21.41
DC-HSDPA Subtest-1	21.85	21.78	21.75	21.95	22.08	22.01	22.12	22.08	22.03
DC-HSDPA Subtest-2	21.90	21.82	21.80	22.00	22.10	22.02	22.15	22.10	22.05
DC-HSDPA Subtest-3	21.42	21.34	21.35	21.60	21.64	21.63	21.63	21.60	21.53
DC-HSDPA Subtest-4	21.40	21.30	21.32	21.55	21.60	21.58	21.60	21.55	21.50
HSUPA Subtest-1	21.92	21.81	21.87	22.11	22.27	22.09	22.13	22.09	22.03
HSUPA Subtest-2	19.95	19.80	19.91	20.13	20.23	20.07	20.15	20.06	20.04
HSUPA Subtest-3	20.92	20.84	20.86	21.12	21.26	21.08	21.18	21.10	21.08
HSUPA Subtest-4	19.88	19.79	19.80	20.14	20.24	20.03	20.16	20.04	20.01
HSUPA Subtest-5	21.54	21.42	21.49	21.81	21.89	21.74	21.75	21.66	21.59



**ERP/EIRP**

WCDMA Band V ( $G_T - L_C = -2.7\text{dBi}$ )			
Channel	4132	4182	4233
	(Low)	(Mid)	(High)
Frequency	826.4	836.4	846.6
(MHz)			
Conducted Power (dBm)	22.93	22.83	22.87
Conducted Power (Watts)	0.1963	0.1919	0.1936
ERP(dBm)	18.08	17.98	18.02
ERP(Watts)	0.0643	0.0628	0.0634

WCDMA Band II ( $G_T - L_C = -0.3\text{dBi}$ )			
Channel	9262	9400	9538
	(Low)	(Mid)	(High)
Frequency	1852.4	1880	1907.6
(MHz)			
Conducted Power (dBm)	23.02	23.21	23.08
Conducted Power (Watts)	0.2004	0.2094	0.2032
EIRP(dBm)	22.72	22.91	22.78
EIRP(Watts)	0.1871	0.1954	0.1897

WCDMA Band IV ( $G_T - L_C = -1.1\text{dBi}$ )			
Channel	1312	1413	1513
	(Low)	(Mid)	(High)
Frequency	1712.4	1732.6	1752.6
(MHz)			
Conducted Power (dBm)	23.01	22.93	22.86
Conducted Power (Watts)	0.2000	0.1963	0.1932
EIRP(dBm)	21.91	21.83	21.76
EIRP(Watts)	0.1552	0.1524	0.1500





**Peak-to-Average Ratio**

Mode	WCDMA Band V(dB)	WCDMA Band II(dB)	WCDMA Band IV(dB)	Limit: 13dB
Mod.	RMC 12.2Kbps	RMC 12.2Kbps	RMC 12.2Kbps	Result
Lowest CH	2.96	2.70	2.84	<b>PASS</b>
Middle CH	3.10	2.93	3.36	
Highest CH	3.04	2.75	3.36	

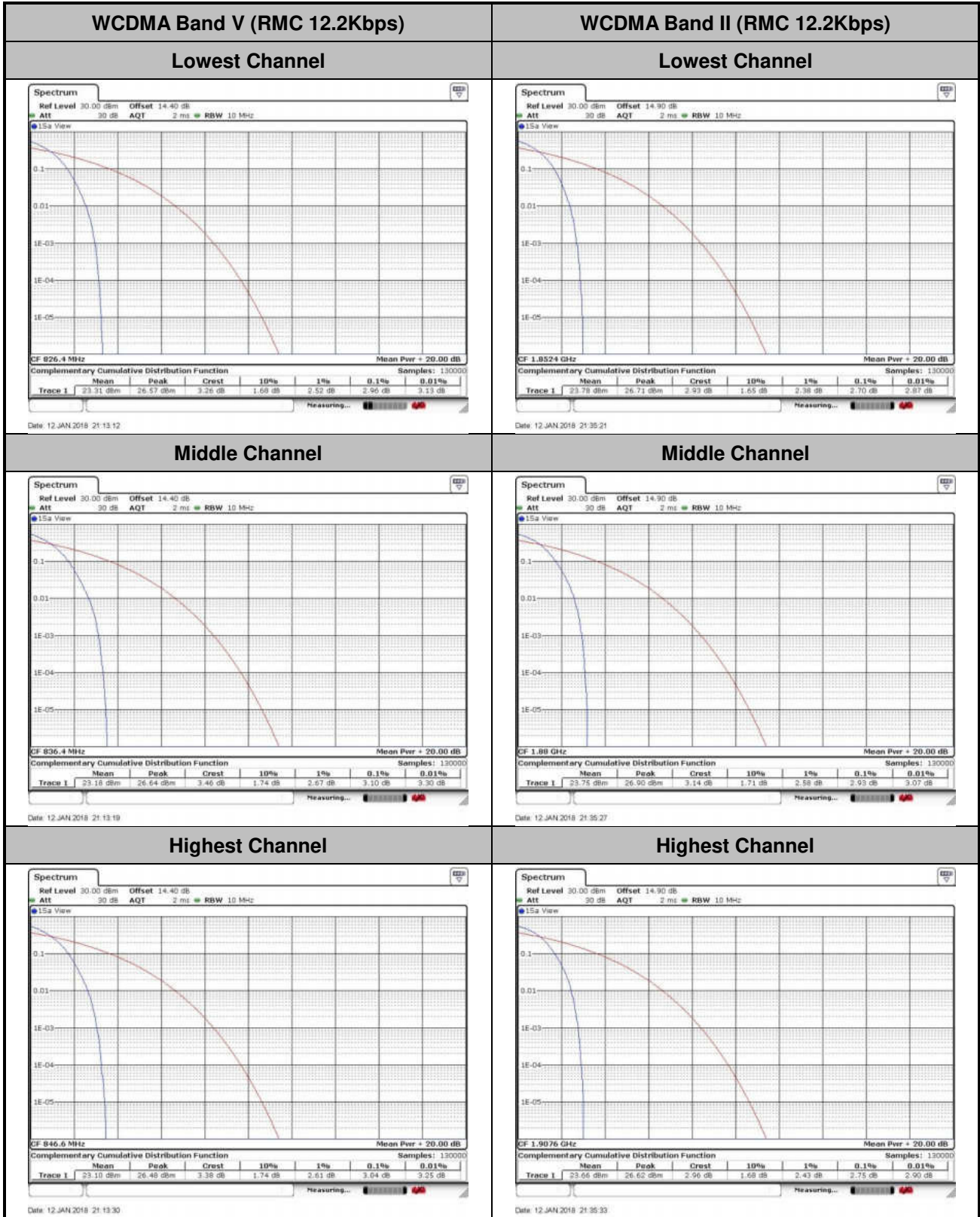

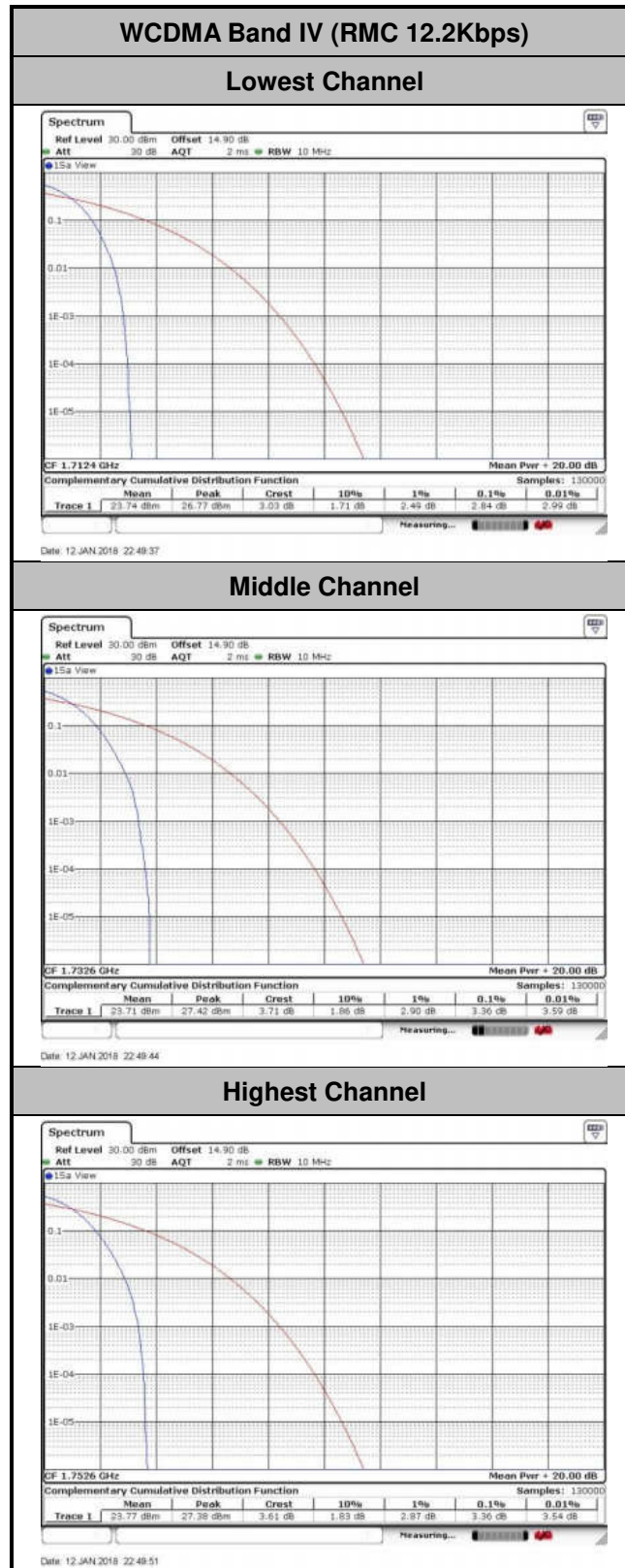



**26dB Bandwidth**

Mode	WCDMA Band V(MHz)	WCDMA Band II(MHz)	WCDMA Band IV(MHz)
Mod.	RMC 12.2Kbps	RMC 12.2Kbps	RMC 12.2Kbps
Lowest CH	4.72	4.73	4.72
Middle CH	4.71	4.71	4.69
Highest CH	4.71	4.74	4.70



WCDMA Band V (RMC 12.2Kbps)

Lowest Channel

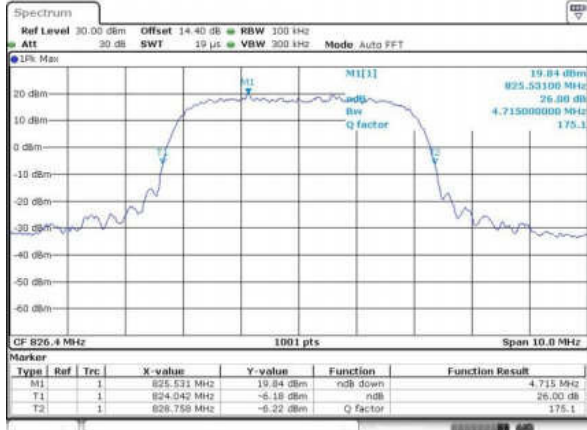

Date: 12 JAN 2018 20:56:33

WCDMA Band II (RMC 12.2Kbps)

Lowest Channel

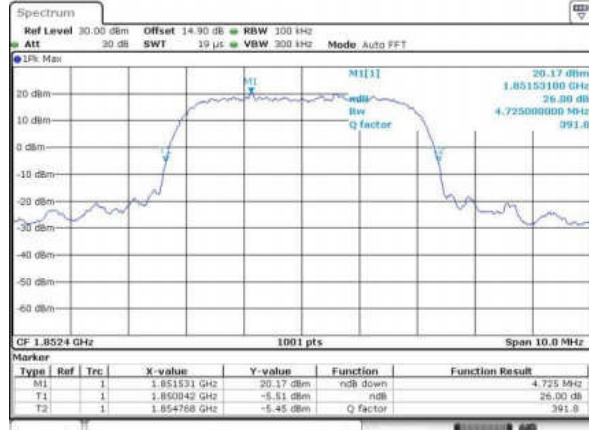

Date: 12 JAN 2018 21:15:16

Middle Channel

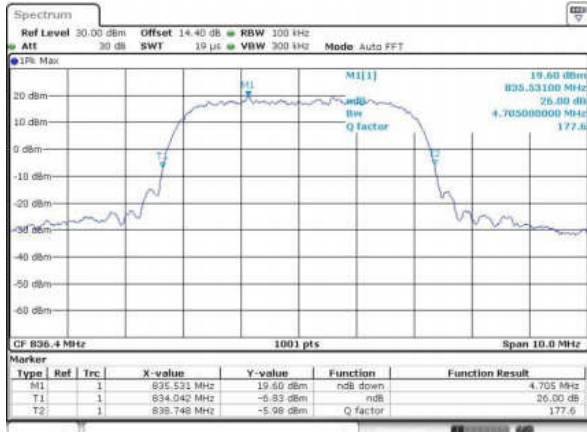

Date: 12 JAN 2018 20:57:01

Middle Channel

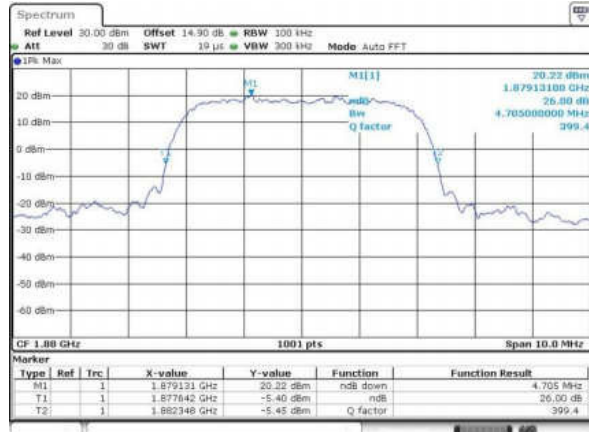

Date: 12 JAN 2018 21:15:44

Highest Channel

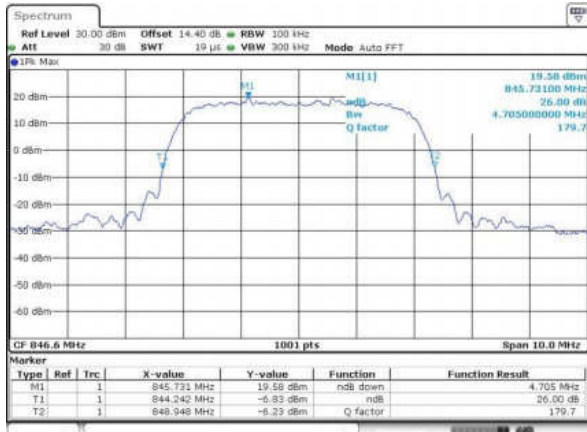

Date: 12 JAN 2018 20:57:29

Highest Channel

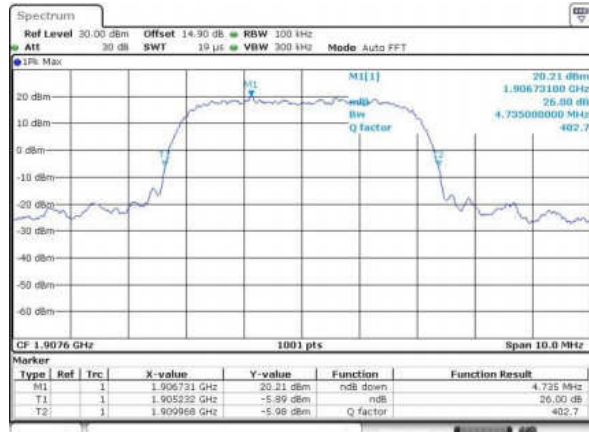

Date: 12 JAN 2018 21:16:13

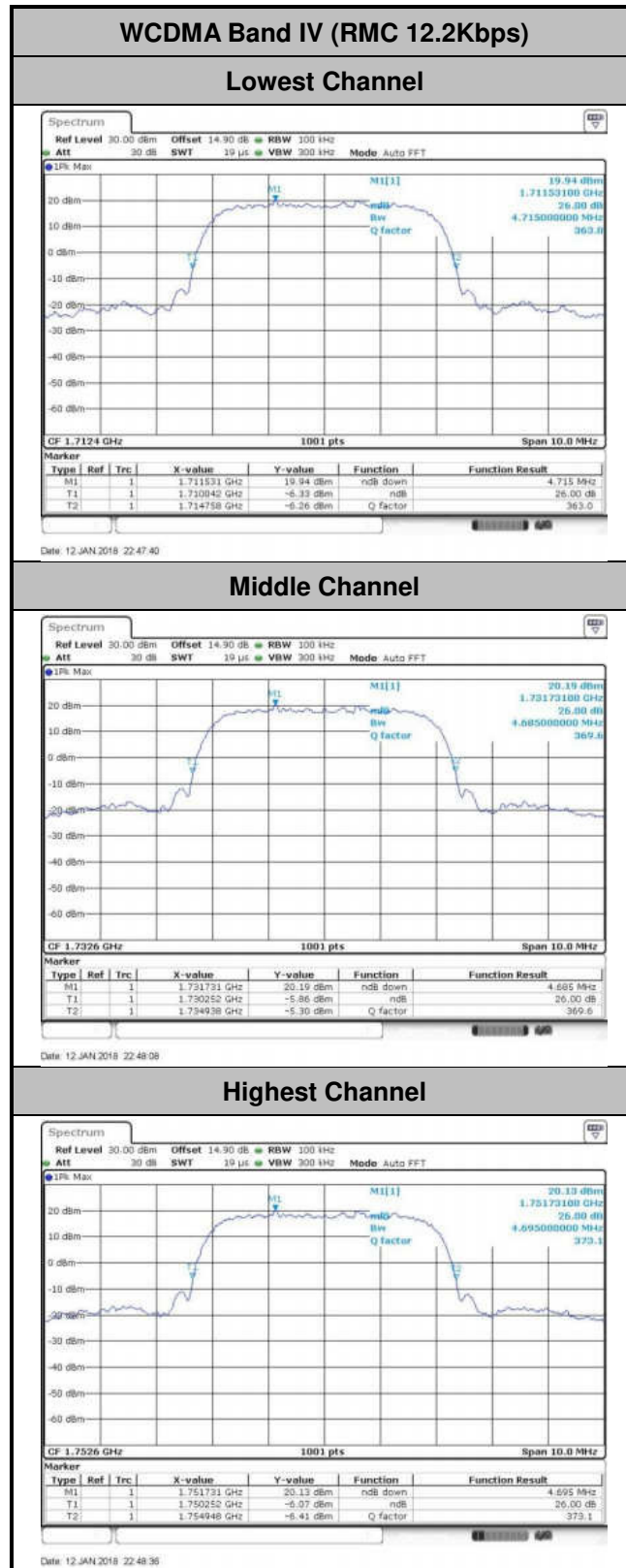



## Occupied Bandwidth

Mode	WCDMA Band V(MHz)	WCDMA Band II(MHz)	WCDMA Band IV(MHz)
Mod.	RMC 12.2Kbps	RMC 12.2Kbps	RMC 12.2Kbps
Lowest CH	4.13	4.14	4.12
Middle CH	4.13	4.14	4.12
Highest CH	4.12	4.15	4.12



WCDMA Band V (RMC 12.2Kbps)

WCDMA Band II (RMC 12.2Kbps)

Lowest Channel

Lowest Channel

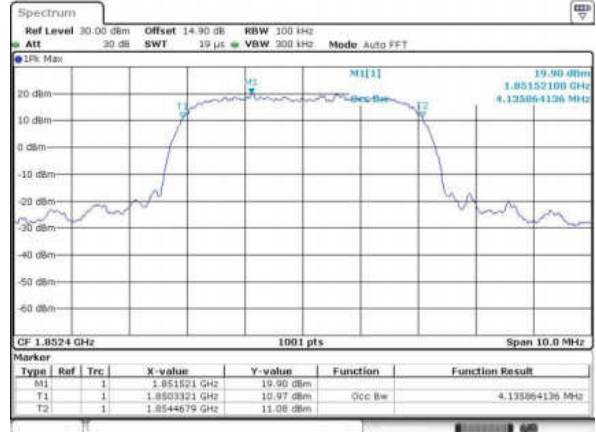
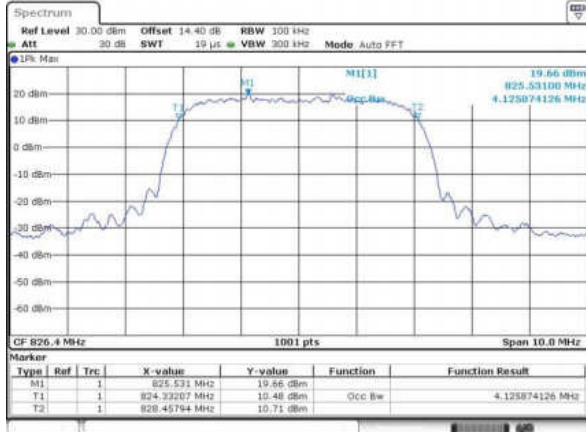

Date: 12 JAN 2018 21:02:14

Date: 12 JAN 2018 21:34:11

Middle Channel

Middle Channel

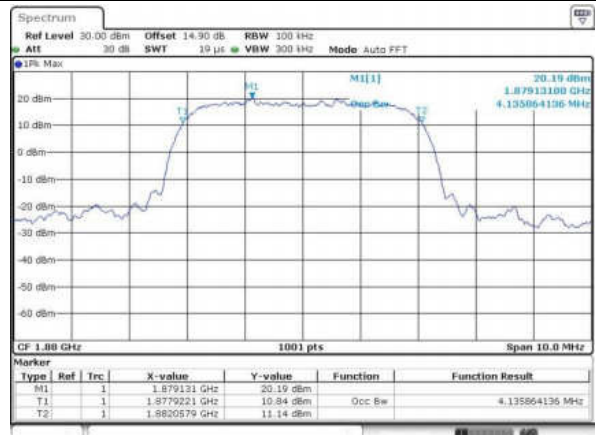
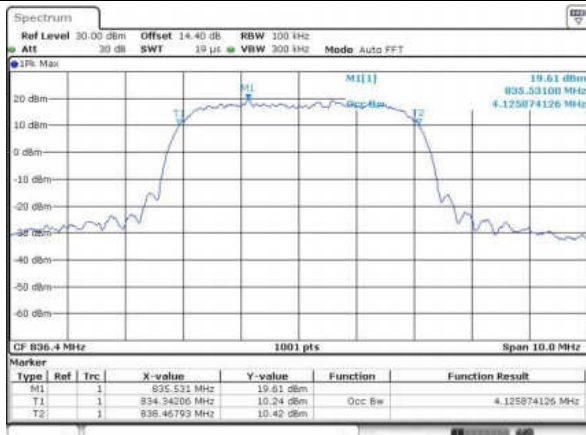

Date: 12 JAN 2018 21:02:42

Date: 12 JAN 2018 21:34:39

Highest Channel

Highest Channel

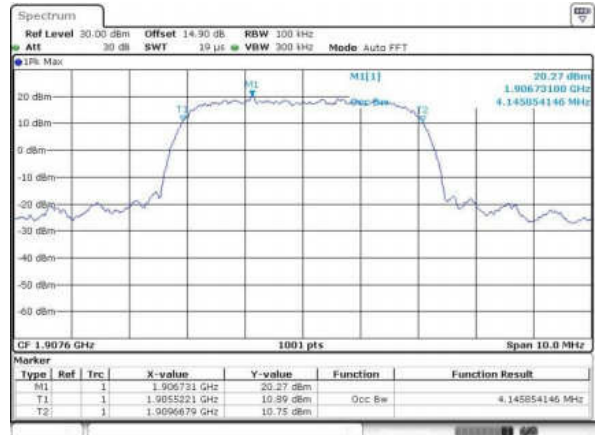
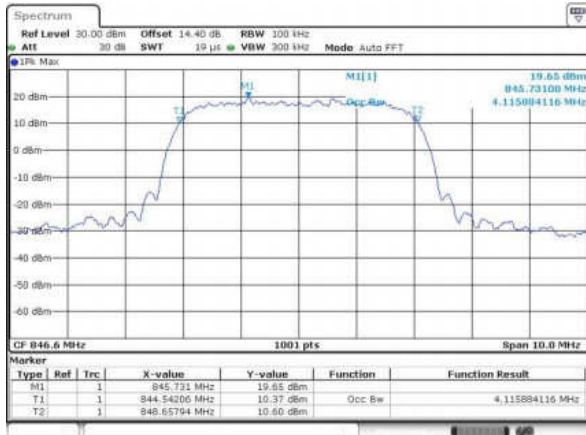

Date: 12 JAN 2018 21:03:10

Date: 12 JAN 2018 21:35:08



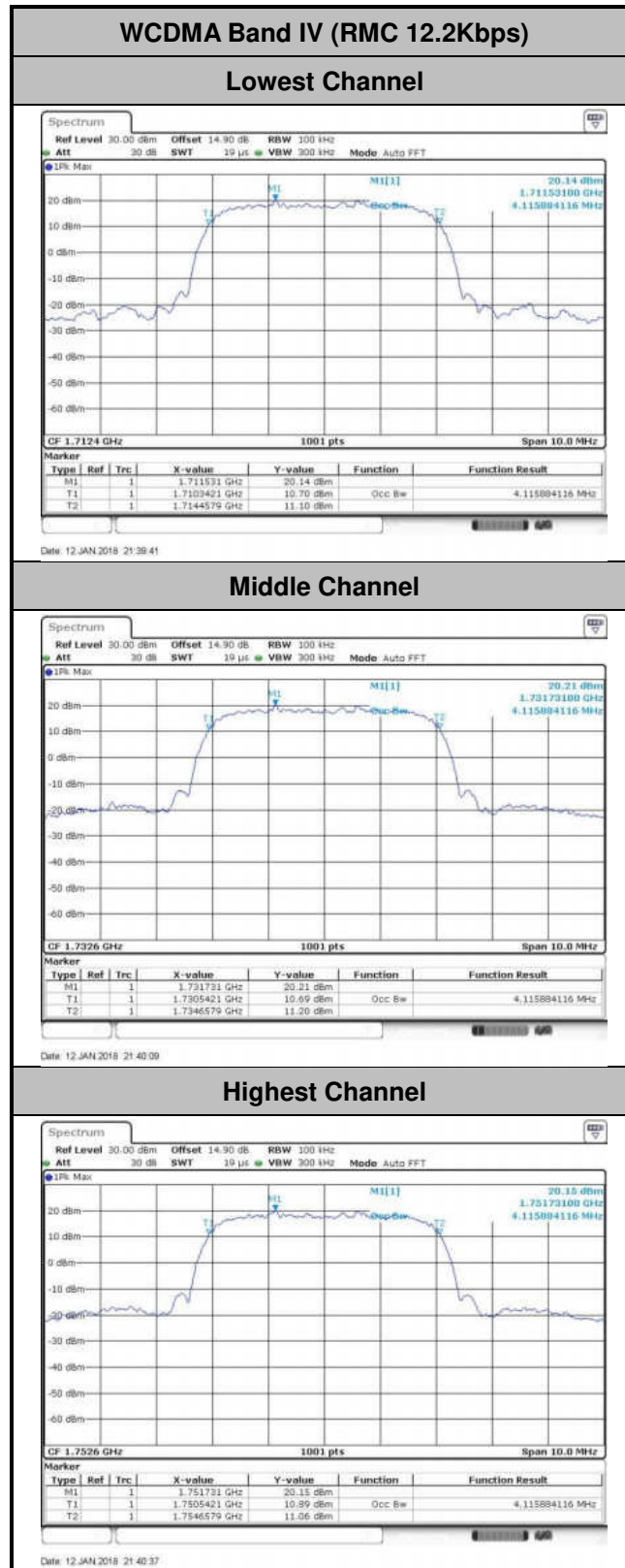



# Conducted Band Edge

## WCDMA Band V (RMC 12.2Kbps)

### Lowest Band Edge

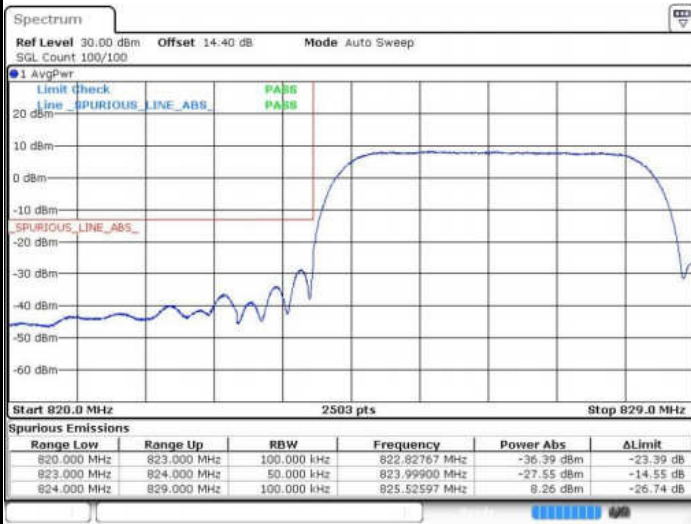

Date: 12 JAN 2016 21:09:12

### Highest Band Edge



Date: 12 JAN 2016 21:08:53

## WCDMA Band II (RMC 12.2Kbps)

### Lowest Band Edge

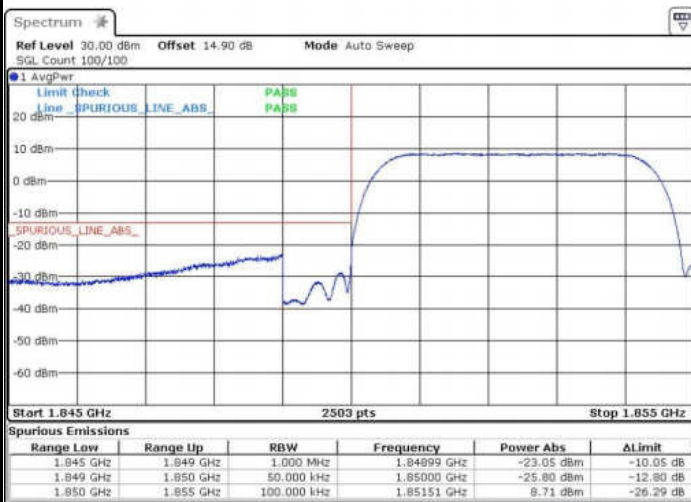

Date: 12 JAN 2016 21:22:55

### Highest Band Edge



Date: 12 JAN 2016 21:25:36

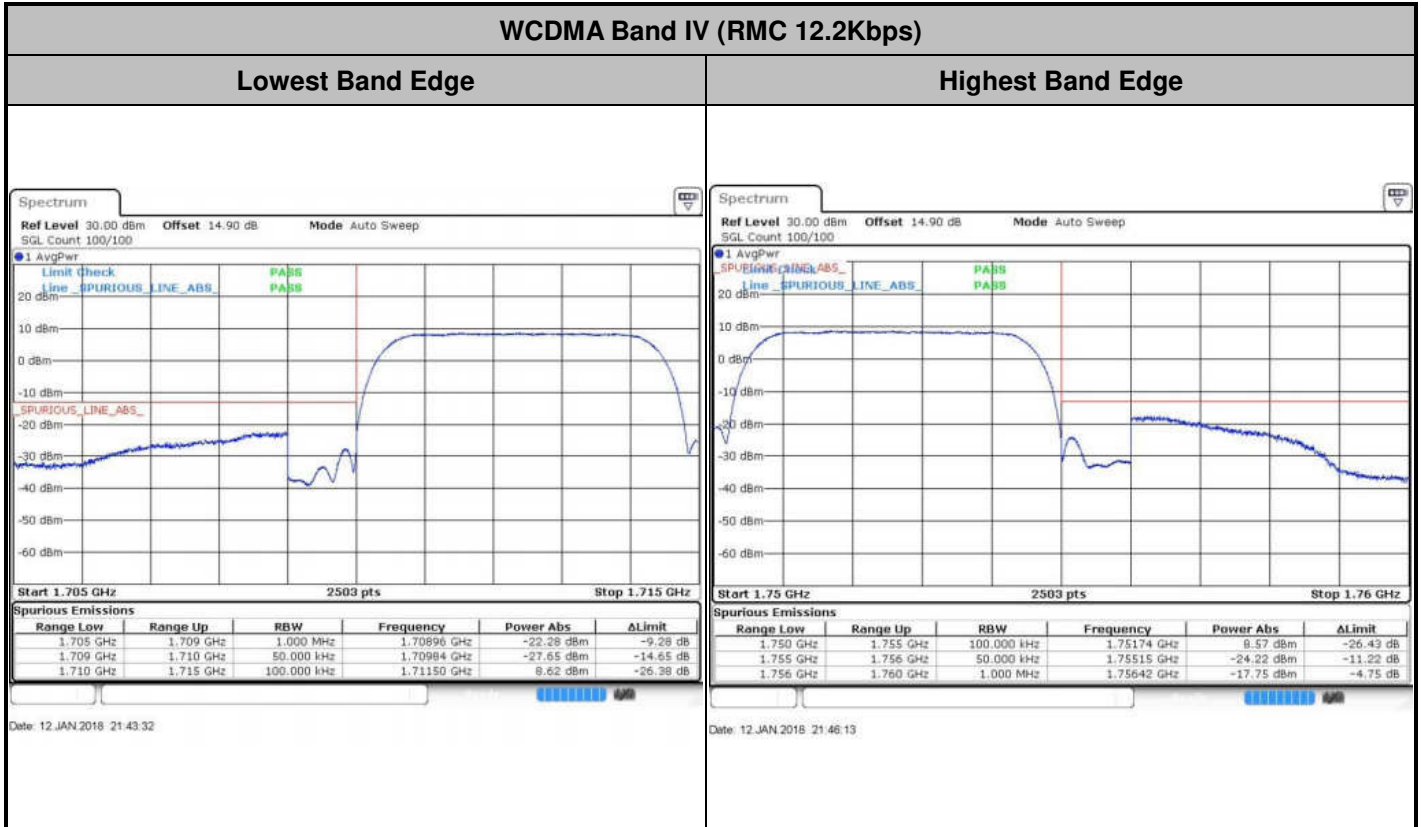



# Conducted Spurious Emission

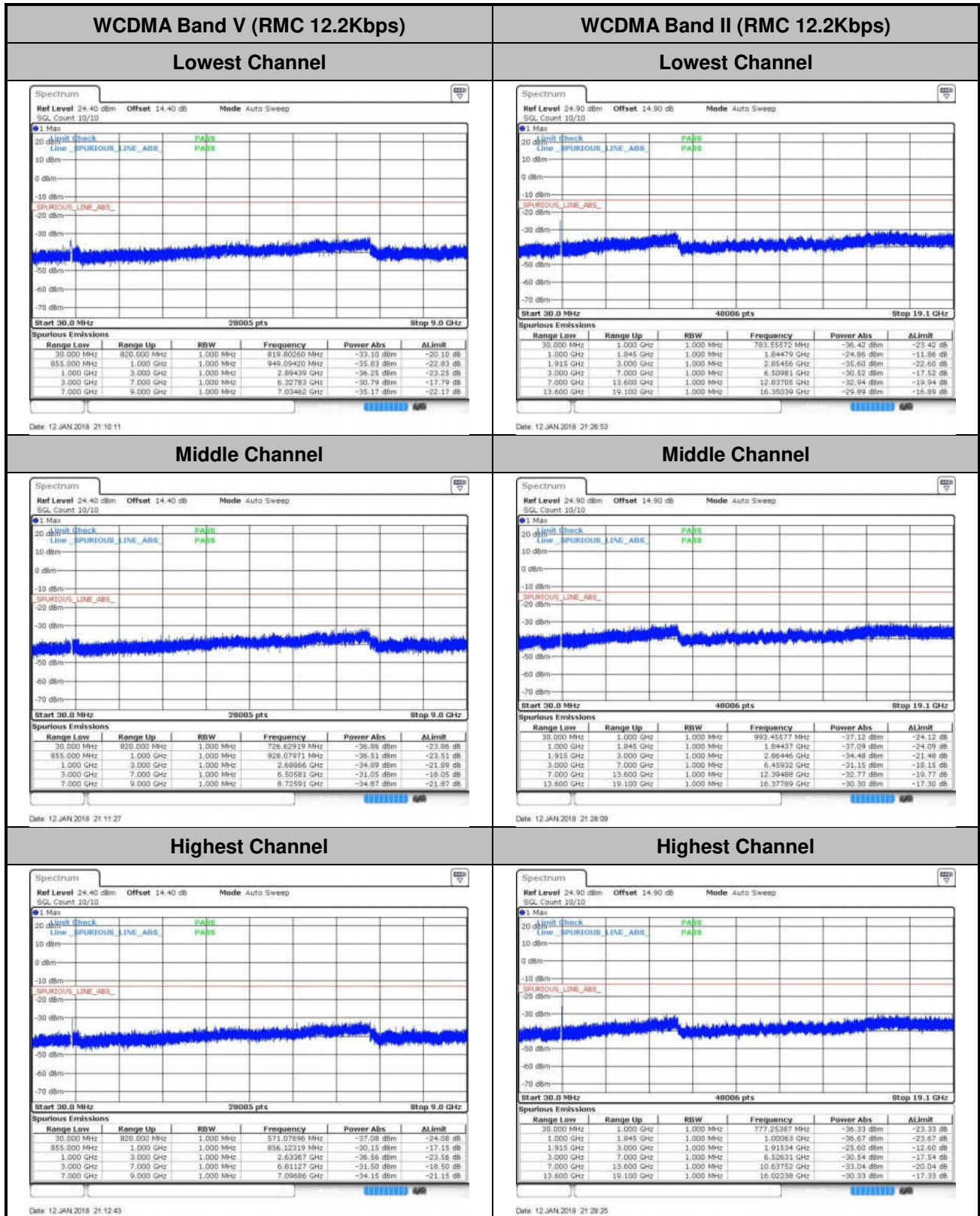

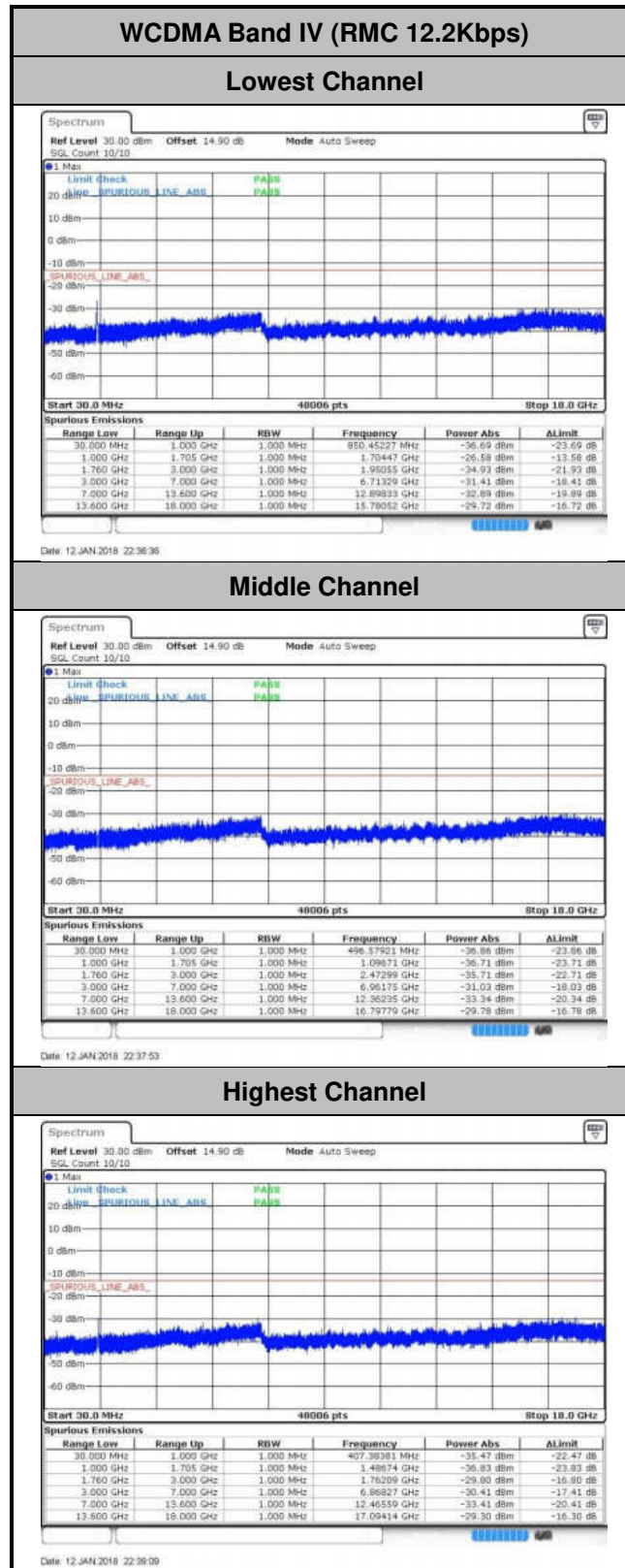



### Frequency Stability

Test Conditions	Middle Channel	WCDMA Band V (RMC 12.2Kbps)	Limit 2.5ppm
Temperature (°C)	Voltage (Volt)	Deviation (ppm)	Result
50	Normal Voltage	0.0155	PASS
40	Normal Voltage	0.0179	
30	Normal Voltage	0.0227	
20(Ref.)	Normal Voltage	0.0000	
10	Normal Voltage	0.0251	
0	Normal Voltage	0.0299	
-10	Normal Voltage	0.0012	
-20	Normal Voltage	0.0335	
-30	Normal Voltage	0.0096	
20	Maximum Voltage	0.0024	
20	Normal Voltage	0.0060	
20	Battery End Point	0.0215	

Note: Normal Voltage = 3.8 V. ; Battery End Point (BEP) =3.6V. ; Maximum Voltage =4.4V

Test Conditions	Middle Channel	WCDMA Band II (RMC 12.2Kbps)	Limit Note 2.
Temperature (°C)	Voltage (Volt)	Deviation (ppm)	Result
50	Normal Voltage	0.0053	PASS
40	Normal Voltage	0.0048	
30	Normal Voltage	0.0043	
20(Ref.)	Normal Voltage	0.0000	
10	Normal Voltage	0.0101	
0	Normal Voltage	0.0085	
-10	Normal Voltage	0.0090	
-20	Normal Voltage	0.0016	
-30	Normal Voltage	0.0112	
20	Maximum Voltage	0.0160	
20	Normal Voltage	0.0021	
20	Battery End Point	0.0080	

Note:

1. Normal Voltage = 3.8 V. ; Battery End Point (BEP) =3.6V. ; Maximum Voltage =4.4V
2. The frequency fundamental emissions stay within the authorized frequency block based on the frequency deviation measured is small.



Test Conditions	Middle Channel	WCDMA Band IV (RMC 12.2Kbps)	Limit Note 2.
Temperature (°C)	Voltage (Volt)	Deviation (ppm)	Result
50	Normal Voltage	0.0081	PASS
40	Normal Voltage	0.0087	
30	Normal Voltage	0.0012	
20(Ref.)	Normal Voltage	0.0000	
10	Normal Voltage	0.0035	
0	Normal Voltage	0.0029	
-10	Normal Voltage	0.0006	
-20	Normal Voltage	0.0006	
-30	Normal Voltage	0.0092	
20	Maximum Voltage	0.0121	
20	Normal Voltage	0.0144	
20	Battery End Point	0.0063	

**Note:**

1. Normal Voltage = 3.8 V. ; Battery End Point (BEP) =3.6 V. ; Maximum Voltage =4.4V
2. The frequency fundamental emissions stay within the authorized frequency block based on the frequency deviation measured is small.



## Appendix B. Test Results of Radiated Test

### Radiated Spurious Emission

WCDMA Band V(RMC 12.2Kbps)									
Channel	Frequency ( MHz )	ERP ( dBm )	Limit ( dBm )	Over Limit ( dB )	SPA Reading (dBm)	S.G. Power ( dBm )	TX Cable loss ( dB )	TX Antenna Gain (dBi)	Polarization (H/V)
Lowest	1656	-58.99	-13	-45.99	-68.94	-65.96	0.53	9.64	H
	2480	-48.25	-13	-35.25	-61.69	-56.23	0.65	10.78	H
	3306	-58.64	-13	-45.64	-74.77	-67.75	0.76	12.02	H
	1656	-63.88	-13	-50.88	-73.54	-70.85	0.53	9.64	V
	2480	-60.30	-13	-47.30	-74.23	-68.28	0.65	10.78	V
	3306	-58.85	-13	-45.85	-74.95	-67.96	0.76	12.02	V
Middle	1672	-52.07	-13	-39.07	-62.16	-59.07	0.53	9.68	H
	2508	-36.41	-13	-23.41	-49.83	-44.41	0.66	10.80	H
	3344	-58.40	-13	-45.40	-74.6	-67.62	0.76	12.13	H
	1672	-50.31	-13	-37.31	-60	-57.31	0.53	9.68	V
	2508	-37.76	-13	-24.76	-51.59	-45.76	0.66	10.80	V
	3344	-58.98	-13	-45.98	-74.99	-68.2	0.76	12.13	V
Highest	1692	-62.83	-13	-49.83	-73.07	-69.87	0.53	9.72	H
	2538	-60.53	-13	-47.53	-74	-68.54	0.66	10.82	H
	3384	-58.70	-13	-45.70	-75	-68.03	0.77	12.25	H
	1692	-63.48	-13	-50.48	-73.22	-70.52	0.53	9.72	V
	2538	-60.22	-13	-47.22	-74.06	-68.23	0.66	10.82	V
	3384	-59.07	-13	-46.07	-74.96	-68.4	0.77	12.25	V

Remark: Spurious emissions within 30-1000MHz were found more than 20dB below limit line.





WCDMA Band II(RMC 12.2Kbps)									
Channel	Frequency ( MHz )	EIRP ( dBm )	Limit ( dBm )	Over Limit ( dB )	SPA Reading (dBm)	S.G. Power ( dBm )	TX Cable loss ( dB )	TX Antenna Gain (dBi)	Polarization (H/V)
Lowest	3704	-57.43	-13	-44.43	-74.42	-69.22	0.72	12.52	H
	5556	-55.13	-13	-42.13	-76.94	-67.3	1.00	13.17	H
	7408	-52.81	-13	-39.81	-77.89	-62.19	1.18	10.57	H
	3704	-56.56	-13	-43.56	-74.72	-68.35	0.72	12.52	V
	5556	-55.27	-13	-42.27	-77.2	-67.44	1.00	13.17	V
	7408	-53.55	-13	-40.55	-78.48	-62.93	1.18	10.57	V
Middle	3760	-56.54	-13	-43.54	-73.69	-68.35	0.69	12.50	H
	5640	-44.15	-13	-31.15	-65.87	-56.28	0.98	13.12	H
	7520	-52.83	-13	-39.83	-77.75	-62.11	1.18	10.46	H
	3760	-56.21	-13	-43.21	-74.57	-68.02	0.69	12.50	V
	5640	-54.83	-13	-41.83	-76.72	-66.96	0.98	13.12	V
	7520	-52.65	-13	-39.65	-77.62	-61.93	1.18	10.46	V
Highest	3814	-57.46	-13	-44.46	-74.73	-69.25	0.68	12.47	H
	5721	-55.29	-13	-42.29	-77.04	-67.37	0.99	13.07	H
	7628	-52.64	-13	-39.64	-77.82	-62.22	1.18	10.76	H
	3814	-55.83	-13	-42.83	-74.32	-67.62	0.68	12.47	V
	5721	-55.39	-13	-42.39	-77.35	-67.47	0.99	13.07	V
	7628	-52.93	-13	-39.93	-77.86	-62.51	1.18	10.76	V

Remark: Spurious emissions within 30-1000MHz were found more than 20dB below limit line.



WCDMA Band IV(RMC 12.2Kbps)									
Channel	Frequency ( MHz )	EIRP ( dBm )	Limit ( dBm )	Over Limit ( dB )	SPA Reading (dBm)	S.G. Power ( dBm )	TX Cable loss ( dB )	TX Antenna Gain (dBi)	Polarization (H/V)
Lowest	3426	-52.00	-13	-39.00	-68.99	-63.6	0.77	12.38	H
	5138	-57.00	-13	-44.00	-77.36	-68.5	0.97	12.48	H
	6850	-54.50	-13	-41.50	-77.85	-65.3	0.83	11.63	H
	3426	-49.70	-13	-36.70	-66.35	-61.3	0.77	12.38	V
	5138	-57.30	-13	-44.30	-77.89	-68.8	0.97	12.48	V
	6850	-54.10	-13	-41.10	-77.94	-64.9	0.83	11.63	V
Middle	3468	-52.97	-13	-39.97	-70.01	-64.7	0.78	12.50	H
	5202	-53.49	-13	-40.49	-73.92	-65.1	0.99	12.60	H
	6931	-53.86	-13	-40.86	-77.3	-64.3	1.01	11.45	H
	3468	-54.07	-13	-41.07	-71.37	-65.8	0.78	12.50	V
	5202	-52.89	-13	-39.89	-73.61	-64.5	0.99	12.60	V
	6931	-53.46	-13	-40.46	-77.37	-63.9	1.01	11.45	V
Highest	3504	-50.68	-13	-37.68	-67.26	-62.5	0.78	12.60	H
	5258	-57.70	-13	-44.70	-78.36	-69.4	1.01	12.72	H
	7010	-53.38	-13	-40.38	-76.92	-63.5	1.17	11.28	H
	3504	-50.88	-13	-37.88	-68.63	-62.7	0.78	12.60	V
	5258	-57.50	-13	-44.50	-78.2	-69.2	1.01	12.72	V
	7010	-52.78	-13	-39.78	-76.91	-62.9	1.17	11.28	V

Remark: Spurious emissions within 30-1000MHz were found more than 20dB below limit line.



## **Appendix D. Reference Report**

Please refer to Sporton report number FG7D2903-01A which is issued separately.