



FCC RF Test Report

APPLICANT : Motorola Mobility LLC
EQUIPMENT : Mobile Cellular Phone
BRAND NAME : Motorola
MODEL NAME : XT1926-6, XT1926-7
FCC ID : IHDT56WL4
STANDARD : FCC Part 15 Subpart E §15.407
CLASSIFICATION : (NII) Unlicensed National Information Infrastructure

The product was received on Dec. 27, 2017 and testing was completed on Jan. 22, 2018. We, Sporton International (Kunshan) Inc., would like to declare that the tested sample has been evaluated in accordance with the test procedures and has been in compliance with the applicable technical standards.

The test results in this report apply exclusively to the tested model / sample. Without written approval of Sporton International (Kunshan) Inc., the test report shall not be reproduced except in full.



Approved by: James Huang / Manager

Sporton International (Kunshan) Inc.
No.3-2 Ping-Xiang Rd, Kunshan Development Zone Kunshan City Jiangsu Province 215335
China



TABLE OF CONTENTS

1 GENERAL DESCRIPTION 5

1.1 Applicant 5

1.2 Manufacturer 5

1.3 Product Feature of Equipment Under Test 5

1.4 Product Specification of Equipment Under Test 6

1.5 Specification of Accessory 7

1.6 Modification of EUT 8

1.7 Testing Location 8

1.8 Applicable Standards 9

2 TEST CONFIGURATION OF EQUIPMENT UNDER TEST 10

2.1 Carrier Frequency and Channel 10

2.2 Test Mode 11

2.3 Connection Diagram of Test System 12

2.4 Support Unit used in test configuration and system 13

2.5 EUT Operation Test Setup 13

2.6 Measurement Results Explanation Example 14

3 TEST RESULT 15

3.1 6dB and 26dB and 99% Occupied Bandwidth Measurement 15

3.2 Maximum Conducted Output Power Measurement 18

3.3 Power Spectral Density Measurement 19

3.4 Unwanted Emissions Measurement 22

3.5 AC Conducted Emission Measurement 28

3.6 Automatically Discontinue Transmission 32

3.7 Antenna Requirements 33

4 LIST OF MEASURING EQUIPMENT 34

5 UNCERTAINTY OF EVALUATION 35

APPENDIX A. CONDUCTED TEST RESULTS

APPENDIX B. RADIATED SPURIOUS EMISSION

APPENDIX C. DUTY CYCLE PLOTS

APPENDIX D. SETUP PHOTOGRAPHS



SUMMARY OF TEST RESULT

Report Section	FCC Rule	Description	Limit	Result	Remark
3.1	15.403(i)	6dB, 26dB and 99% Occupied Bandwidth	> 500kHz	Pass	-
3.2	15.407(a)	Maximum Conducted Output Power	≤ 30 dBm	Pass	-
3.3	15.407(a)	Power Spectral Density	≤ 30 dBm/500kHz	Pass	-
3.4	15.407(b)	Unwanted Emissions	15.407(b)(4)(i) & 15.209(a)	Pass	Under limit 3.04 dB at 11650.000 MHz
3.5	15.207	AC Conducted Emission	15.207(a)	Pass	Under limit 13.94 dB at 0.195 MHz
3.6	15.407(c)	Automatically Discontinue Transmission	Discontinue Transmission	Pass	-
3.7	15.203 & 15.407(a)	Antenna Requirement	N/A	Pass	-



1 General Description

1.1 Applicant

Motorola Mobility LLC
222 W, Merchandise Mart Plaza, Chicago IL 60654 USA

1.2 Manufacturer

Motorola Mobility LLC
222 W, Merchandise Mart Plaza, Chicago IL 60654 USA

1.3 Product Feature of Equipment Under Test

Product Feature	
Equipment	Mobile Cellular Phone
Brand Name	Motorola
Model Name	XT1926-6, XT1926-7
FCC ID	IHDT56WL4
EUT supports Radios application	GSM/GPRS/EGPRS/WCDMA/HSPA/DC-HSDPA /HSPA+/LTE/NFC WLAN 2.4GHz 802.11b/g/n HT20 WLAN 5GHz 802.11a/n HT20/HT40 WLAN 5GHz 802.11ac VHT20/VHT40/VHT80 Bluetooth v3.0+EDR/ Bluetooth v4.0 LE/ Bluetooth v4.1 LE/Bluetooth v4.2 LE/ Bluetooth v5.0 LE
IMEI Code	Conducted: 351853090015717/351853090015725 Conduction: N/A Radiation: 351853090016053/351853090016061
HW Version	DVT1B
SW Version	evert_n-userdebug 8.0.0 OPW27.88 1825 intcfg,test-keys
EUT Stage	Identical Prototype

Remark:

1. The above EUT's information was declared by manufacturer. Please refer to the specifications or user's manual for more detailed description.
2. There are two types of EUT sample 1 and sample 2, the differences between two samples are only for SIM slot, sample 1(Model name: XT1926-7) is dual SIM slot, sample 2(Model name: XT1926-6) is single SIM slot. We only choose dual SIM sample to perform full test.



1.4 Product Specification of Equipment Under Test

Standards-related Product Specification	
Tx/Rx Channel Frequency Range	5745 MHz ~ 5825 MHz
Maximum Output Power	<p><5745 MHz ~ 5825 MHz> 802.11a : 15.02 dBm / 0.0318 W 802.11n HT20 : 13.65 dBm / 0.0232 W 802.11n HT40 : 13.17 dBm / 0.0207 W 802.11ac VHT20: 14.89 dBm / 0.0308 W 802.11ac VHT40: 13.09 dBm / 0.0204 W 802.11ac VHT80: 11.77 dBm / 0.0150 W</p>
99% Occupied Bandwidth	802.11a : 17.58 MHz 802.11n HT40 : 36.56 MHz 802.11ac VHT20 : 18.73 MHz 802.11ac VHT80 : 75.76 MHz
Type of Modulation	802.11a/n : OFDM (BPSK / QPSK / 16QAM / 64QAM) 802.11ac : OFDM (BPSK / QPSK / 16QAM / 64QAM / 256QAM)
Antenna Type / Gain	PIFA Antenna with gain -3.0 dBi

Note: For 802.11n HT20 / ac VHT20 and 802.11n HT40 / ac VHT40 mode, the whole testing has assessed only 802.11ac VHT20/ HT40 by referring to their maximum conducted power.



1.5 Specification of Accessory

Specification of Accessory				
AC Adapter 1(US)	Brand Name	Motorola (Salom)	Model Name	SC-22
	Power Rating	I/P: 100-240 Vac, 500mA, O/P: 5Vdc,3000mA or 9Vdc,1600mA or 12Vdc,1200mA		
AC Adapter 1(EU)	Brand Name	Motorola (Salom)	Model Name	SC-23
	Power Rating	I/P: 100-240 Vac, 500mA, O/P: 5Vdc,3000mA or 9Vdc,1600mA or 12Vdc,1200mA		
AC Adapter 1(UK)	Brand Name	Motorola (Salom)	Model Name	SC-24
	Power Rating	I/P: 100-240 Vac, 500mA, O/P: 5Vdc,3000mA or 9Vdc,1600mA or 12Vdc,1200mA		
AC Adapter 1(IN)	Brand Name	Motorola (Salom)	Model Name	SC-25
	Power Rating	I/P: 100-240 Vac, 500mA, O/P: 5Vdc,3000mA or 9Vdc,1600mA or 12Vdc,1200mA		
AC Adapter 1(AU)	Brand Name	Motorola (Salom)	Model Name	SC-26
	Power Rating	I/P: 100-240 Vac, 500mA, O/P: 5Vdc,3000mA or 9Vdc,1600mA or 12Vdc,1200mA		
AC Adapter 1(AR)	Brand Name	Motorola (Salom)	Model Name	SC-27
	Power Rating	I/P: 100-240 Vac, 500mA, O/P: 5Vdc,3000mA or 9Vdc,1600mA or 12Vdc,1200mA		
AC Adapter 2(US)	Brand Name	Motorola (Chenyang)	Model Name	SC-22
	Power Rating	I/P: 100-240 Vac, 500mA, O/P: 5Vdc,3000mA or 9Vdc,1600mA or 12Vdc,1200mA		
AC Adapter 2(EU)	Brand Name	Motorola (Chenyang)	Model Name	SC-23
	Power Rating	I/P: 100-240 Vac, 500mA, O/P: 5Vdc,3000mA or 9Vdc,1600mA or 12Vdc,1200mA		
AC Adapter 2(UK)	Brand Name	Motorola (Chenyang)	Model Name	SC-24
	Power Rating	I/P: 100-240 Vac, 500mA, O/P: 5Vdc,3000mA or 9Vdc,1600mA or 12Vdc,1200mA		
AC Adapter 2(IN)	Brand Name	Motorola (Chenyang)	Model Name	SC-25
	Power Rating	I/P: 100-240 Vac, 500mA, O/P: 5Vdc,3000mA or 9Vdc,1600mA or 12Vdc,1200mA		
AC Adapter 2(AU)	Brand Name	Motorola (Chenyang)	Model Name	SC-26
	Power Rating	I/P: 100-240 Vac, 500mA, O/P: 5Vdc,3000mA or 9Vdc,1600mA or 12Vdc,1200mA		
AC Adapter 2(AR)	Brand Name	Motorola (chenyang)	Model Name	SC-27
	Power Rating	I/P: 100-240 Vac, 500mA, O/P: 5Vdc,3000mA or 9Vdc,1600mA or 12Vdc,1200mA		
Battery	Brand Name	Motorola (ATL)	Model Name	JT40
	Power Rating	3.8Vdc,3200mAh	Type	Li-ion Polymer
Earphone 1	Brand Name	Motorola (Jiahe)	Model Name	LS-118M-12
	Signal Line Type	1.2 meter, non-shielded cable, without ferrite core		
Earphone 2	Brand Name	Motorola (Lianyun)	Model Name	TS910A-38AMS01WHR-M
	Signal Line Type	1.2 meter, non-shielded cable, without ferrite core		
USB Cable	Brand Name	Motorola (Liqi)	Model Name	L32B-053000100-ALL
	Signal Line Type	1.0 meter, shielded cable, without ferrite core		



1.6 Modification of EUT

No modifications are made to the EUT during all test items.

1.7 Testing Location

Sporton International (Kunshan) Inc. is accredited to ISO 17025 by National Voluntary Laboratory Accreditation Program (NVLAP code: 600155-0) and the FCC designation No. is CN5013.

Test Site	Sporton International (Kunshan) Inc.		
Test Site Location	No.3-2 Ping-Xiang Rd, Kunshan Development Zone Kunshan City Jiangsu Province 215335 China TEL : +86-512-57900158 FAX : +86-512-57900958		
Test Site No.	Sporton Site No.		FCC Test Firm Registration No.
	TH01-KS	CO01-KS	630927

Note: The test site complies with ANSI C63.4 2014 requirement.

Sporton International (Shenzhen) Inc. is accredited to ISO 17025 by National Voluntary Laboratory Accreditation Program (NVLAP code: 600156-0) and the FCC designation No. is CN5019.

Test Site	Sporton International (Shenzhen) Inc.		
Test Site Location	No. 3 Bldg the third floor of south, Shahe River west, Fengzeyuan Warehouse, Nanshan District Shenzhen City Guangdong Province 518055 China TEL: +86-755-3320-2398		
Test Site No.	Sporton Site No.		FCC Test Firm Registration No.
	03CH01-SZ		577730

Note: The test site complies with ANSI C63.4 2014 requirement.



1.8 Applicable Standards

According to the specifications of the manufacturer, the EUT must comply with the requirements of the following standards:

- ♦ FCC Part 15 Subpart E
- ♦ FCC KDB 789033 D02 General UNII Test Procedures New Rules v02r01
- ♦ ANSI C63.10-2013

Remark:

1. All test items were verified and recorded according to the standards and without any deviation during the test.
2. This EUT has also been tested and complied with the requirements of FCC Part 15, Subpart B, recorded in a separate test report.



2 Test Configuration of Equipment Under Test

The EUT has been associated with peripherals and configuration operated in a manner tended to maximize its emission characteristics in a typical application. Frequency range investigated: conducted emission (150 kHz to 30 MHz) and radiated emission (9 kHz to the 10th harmonic of the highest fundamental frequency or to 40 GHz, whichever is lower). For radiated measurement, pre-scanned in three orthogonal panels, X, Y, Z. The worst cases were recorded in this report.

2.1 Carrier Frequency and Channel

Frequency Band	Channel	Freq. (MHz)	Channel	Freq. (MHz)
5745-5825 MHz Band 4 (U-NII-3)	149	5745	157	5785
	151*	5755	159*	5795
	153	5765	161	5805
	155#	5775	165	5825

Note:

1. The above Frequency and Channel in "*" were 802.11n HT40 and 802.11ac VHT40.
2. The above Frequency and Channel in "#n" were 802.11ac VHT80.



2.2 Test Mode

Final test mode of conducted test items and radiated spurious emissions are considering the modulation and worse data rates as below table.

Modulation	Data Rate
802.11a	6 Mbps
802.11n HT40	MCS0
802.11ac VHT20	MCS0
802.11ac VHT80	MCS0

AC Conducted Emission	Mode 1 : GSM850 Idle + Bluetooth Link + WLAN Link (5G) + USB Cable (Charging from Adapter 1) + Earphone 1
Remark: For Radiated Test Cases, The tests were performed with Earphone 1, Adapter 1 and USB Cable.	

Ch. #		Band IV : 5745-5825 MHz		
		802.11a	802.11n HT20	802.11n HT40
L	Low	149	149	151
M	Middle	157	157	-
H	High	165	165	159

Ch. #		Band IV : 5745-5825 MHz		
		802.11ac VHT20	802.11ac VHT40	802.11ac VHT80
L	Low	149	151	-
M	Middle	157	-	155
H	High	165	159	-

2.3 Connection Diagram of Test System

<WLAN Tx Mode>

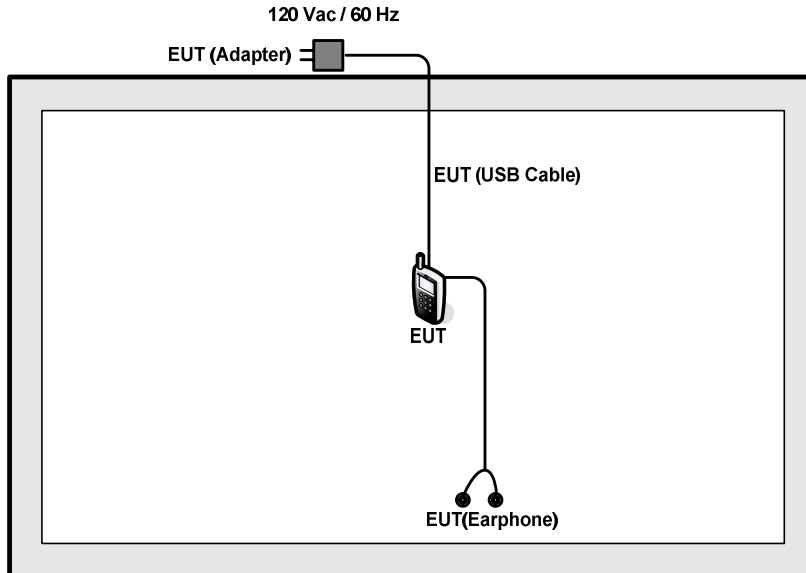

<AC Conducted Emission Mode>

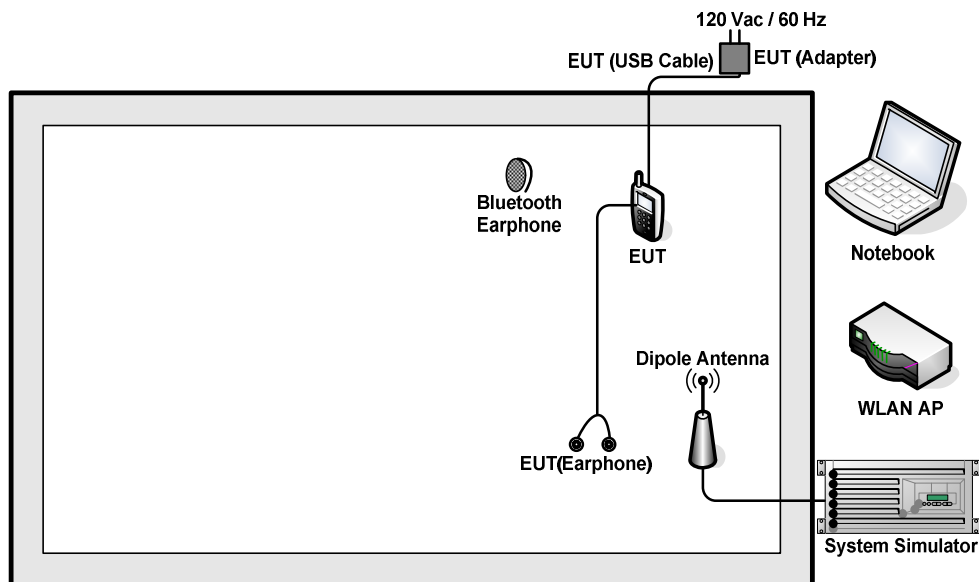



2.4 Support Unit used in test configuration and system

Item	Equipment	Trade Name	Model Name	FCC ID	Data Cable	Power Cord
1.	System Simulator	R&S	CMU 200	N/A	N/A	Unshielded, 1.8 m
2.	WLAN AP	D-Link	DIR-855	KA2DIR855A2	N/A	Unshielded, 1.8 m
3.	Notebook	Lenovo	G480	N/A	N/A	AC I/P: Unshielded, 1.8 m DC O/P: Shielded, 1.8 m
4.	Bluetooth Earphone	Lenovo	LBH308	N/A	N/A	N/A

2.5 EUT Operation Test Setup

For WLAN RF test items, an engineering test program was provided and enabled to make EUT continuously transmit/receive.

For AC power line conducted emissions, the EUT was set to connect with the WLAN AP under large package sizes transmission.



2.6 Measurement Results Explanation Example

For all conducted test items:

The offset level is set in the spectrum analyzer to compensate the RF cable loss between EUT conducted output port and spectrum analyzer. With the offset compensation, the spectrum analyzer reading level is exactly the EUT RF output level.

Example :

The spectrum analyzer offset is derived from RF cable loss.

Offset = RF cable loss.

Following shows an offset computation example with cable loss 6.9 dB.

$$\begin{aligned} \text{Offset(dB)} &= \text{RF cable loss(dB)}. \\ &= 6.9 \text{ (dB)} \end{aligned}$$

3 Test Result

3.1 6dB and 26dB and 99% Occupied Bandwidth Measurement

3.1.1 Description of 6dB and 26dB and 99% Occupied Bandwidth

The minimum 6 dB bandwidth shall be at least 500 kHz.

26dB and 99% Occupied bandwidth are reporting only.

3.1.2 Measuring Instruments

The measuring equipment is listed in the section 4 of this test report.

3.1.3 Test Procedures

1. The testing follows FCC KDB 789033 D02 General UNII Test Procedures New Rules v01r04.
Section C) Emission bandwidth for the band 5.725-5.85GHz
2. Set RBW = 100kHz.
3. Set the VBW $\geq 3 \times$ RBW.
4. Detector = Peak.
5. Trace mode = max hold
6. Measure the maximum width of the emission that is 6 dB down from the peak of the emission.
7. Measure and record the results in the test report.

3.1.4 Test Setup

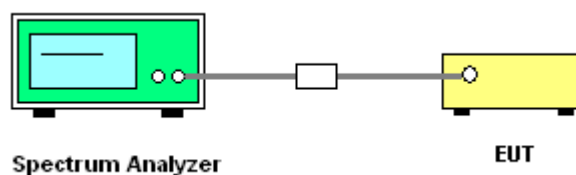



3.1.5 Test Result of 6dB Bandwidth

Please refer to Appendix A.

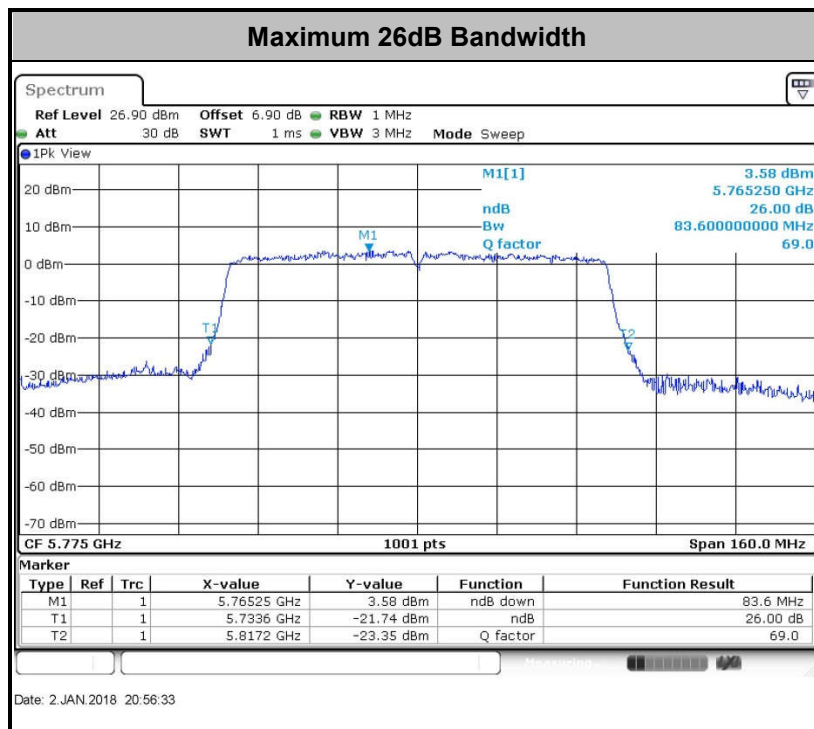
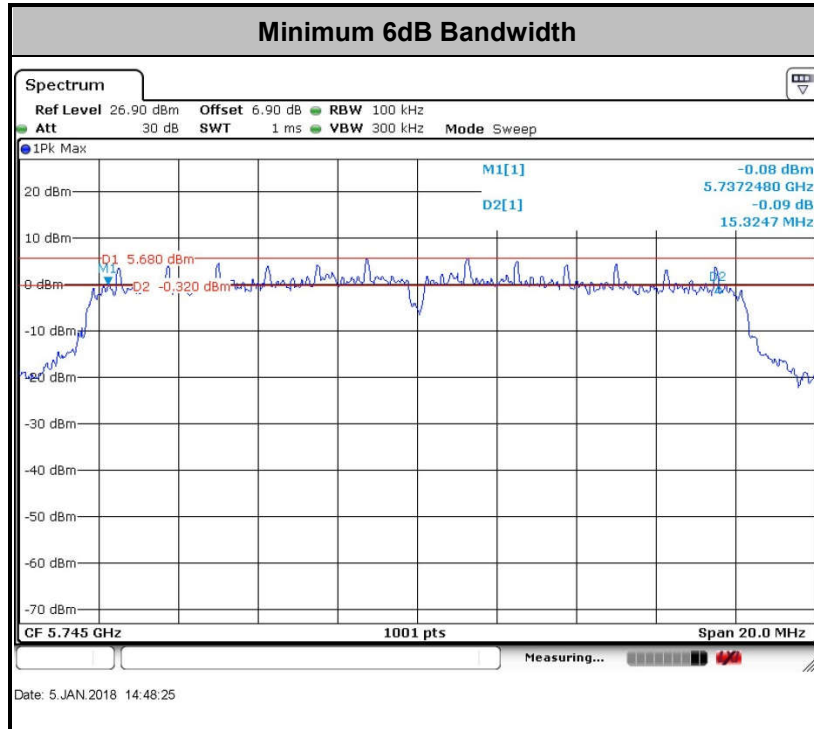

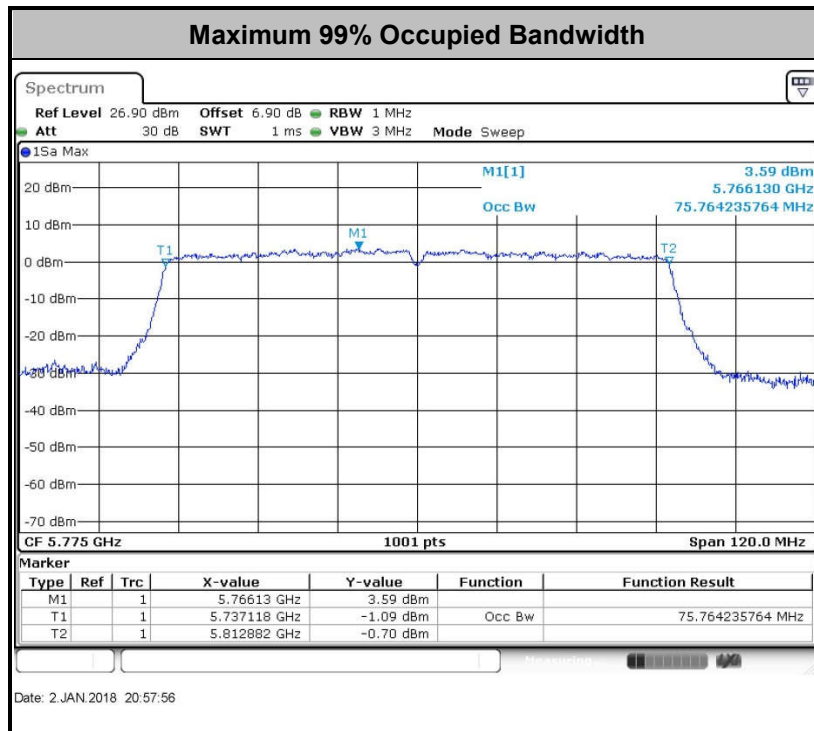

Note: The occupied channel bandwidth is maintained within the band of operation for all of the modulations.

3.2 Maximum Conducted Output Power Measurement

3.2.1 Limit of Maximum Conducted Output Power

For the band 5.725–5.85 GHz, the maximum conducted output power over the frequency band of operation shall not exceed 1 W.

If transmitting antennas of directional gain greater than 6 dBi are used, the peak output power shall be reduced by the amount in dB that the directional gain of the antenna exceeds 6 dBi.

3.2.2 Measuring Instruments

The measuring equipment is listed in the section 4 of this test report.

3.2.3 Test Procedures

The testing follows Method PM of FCC KDB 789033 D02 General UNII Test Procedures New Rules v02r01.

Method PM (Measurement using an RF average power meter):

1. Measurement is performed using a wideband RF power meter.
2. The EUT is configured to transmit continuously with a consistent duty cycle at its maximum power control level.
3. Measure the average power of the transmitter, and the average power is corrected with duty factor, $10 \log(1/x)$, where x is the duty cycle.

3.2.4 Test Setup

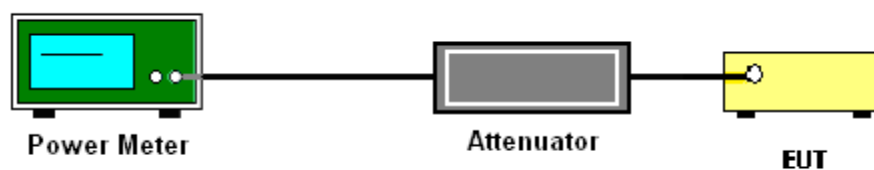

3.2.5 Test Result of Maximum Conducted Output Power

Please refer to Appendix A.



3.3 Power Spectral Density Measurement

3.3.1 Limit of Power Spectral Density

For the band 5.725–5.85 GHz, the maximum power spectral density shall not exceed 30 dBm in any 500-kHz band.

If transmitting antennas of directional gain greater than 6 dBi are used, the peak output power shall be reduced by the amount in dB that the directional gain of the antenna exceeds 6 dBi.

3.3.2 Measuring Instruments

The measuring equipment is listed in the section 4 of this test report.

3.3.3 Test Procedures

The testing follows FCC KDB 789033 D02 General UNII Test Procedures New Rules v02r01. Section F) Maximum power spectral density.

Method SA-2

(trace averaging across on and off times of the EUT transmissions, followed by duty cycle correction).

- Measure the duty cycle.
- Set span to encompass the entire emission bandwidth (EBW) of the signal.
- Set RBW = 300 kHz.
- Set VBW \geq 1 MHz.
- Number of points in sweep \geq 2 Span / RBW.
- Sweep time = auto.
- Detector = RMS
- Trace average at least 100 traces in power averaging mode.
- Add $10 \log(500\text{kHz}/\text{RBW})$ to the test result.
- Add $10 \log(1/x)$, where x is the duty cycle, to the measured power in order to compute the average power during the actual transmission times. For example, add $10 \log(1/0.25) = 6$ dB if the duty cycle is 25 percent.

1. The RF output of EUT was connected to the spectrum analyzer by a low loss cable.
2. Each plot has already offset with cable loss, and attenuator loss. Measure the PPSD and record it.

3.3.4 Test Setup

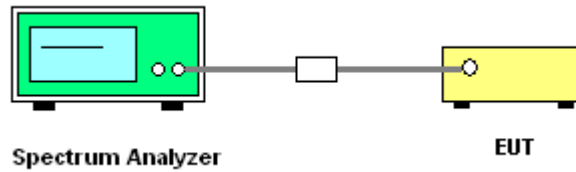



3.3.5 Test Result of Power Spectral Density

Please refer to Appendix A.

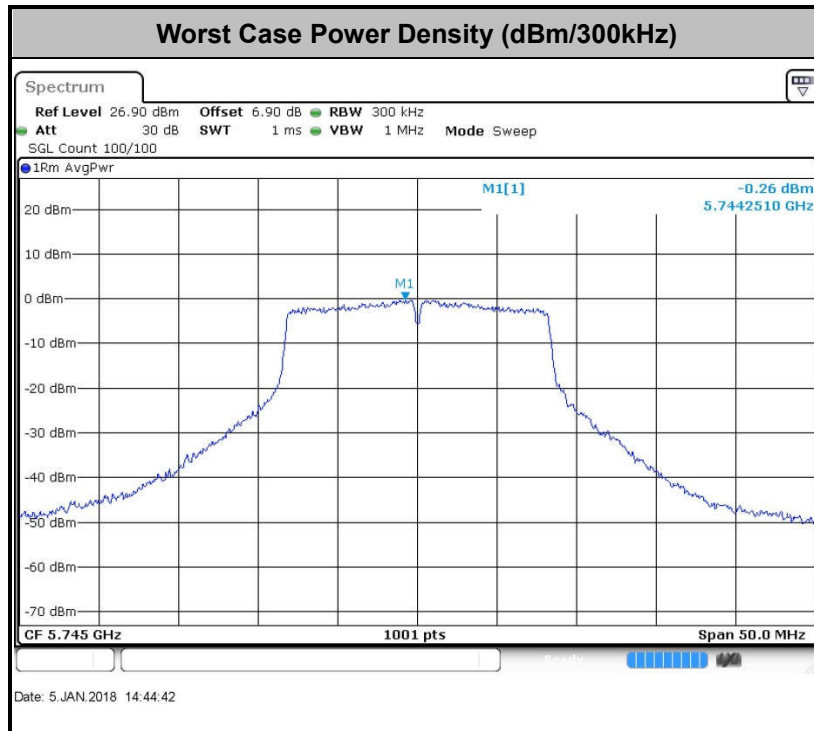



3.4 Unwanted Emissions Measurement

This section as specified in FCC Part 15.407(b) is to measure unwanted emissions through radiated measurement for band edge spurious emissions and out of band emissions measurement. The unwanted emissions shall comply with 15.407(b)(1) to (6), and restricted bands per FCC Part15.205.

3.4.1 Limit of Unwanted Emissions

(1) For transmitters operating in the 5.725-5.85 GHz band:

15.407(b)(4)(i) All emissions shall be limited to a level of -27 dBm/MHz at 75 MHz or more above or below the band edge increasing linearly to 10 dBm/MHz at 25 MHz above or below the band edge, and from 25 MHz above or below the band edge increasing linearly to a level of 15.6 dBm/MHz at 5 MHz above or below the band edge, and from 5 MHz above or below the band edge increasing linearly to a level of 27 dBm/MHz at the band edge.

(2) Unwanted spurious emissions fallen in restricted bands per FCC Part15.205 shall comply with the general field strength limits set forth in § 15.209 as below table,

Frequency (MHz)	Field Strength (microvolts/meter)	Measurement Distance (meters)
0.009 – 0.490	2400/F(kHz)	300
0.490 – 1.705	24000/F(kHz)	30
1.705 – 30.0	30	30
30 – 88	100	3
88 – 216	150	3
216 - 960	200	3
Above 960	500	3

Note: The following formula is used to convert the EIRP to field strength.

$$E = \frac{1000000\sqrt{30P}}{3} \mu\text{V/m, where P is the eirp (Watts)}$$



EIRP (dBm)	Field Strength at 3m (dB μ V/m)
-17	78.3
- 27	68.3

(3) KDB789033 D02 v01r04 G)2)c)

- (i) Section 15.407(b)(1) to (b)(3) specify the unwanted emission limits for the U-NII-1 and U-NII-2 bands. As specified, emissions above 1000 MHz that are outside of the restricted bands are subject to a peak emission limit of -27 dBm/MHz.³
- (ii) Section 15.407(b)(4) specifies the unwanted emission limit for the U-NII-3 band. A band emissions mask is specified in Section 15.407(b)(4)(i). The emission limits are in terms of a Peak detector. An alternative to the band emissions mask is specified in Section 15.407(b)(4)(ii). The alternative limits are based on the highest antenna gain specified in the filing. There are also marketing and importation restrictions for the devices using the alternative limit.⁴

Note 3: An out-of-band emission that complies with both the average and peak limits of Section 15.209 is not required to satisfy the -27 dBm/MHz peak emission limit.

Note 4: Only devices with antenna gains of 10 dBi or less may be approved using the emission limits specified in Section 15.247(d) till March 2, 2018; all other devices operating in this band must use the mask specified in Section 15.407(b)(4)(i).



3.4.2 Measuring Instruments

The measuring equipment is listed in the section 4 of this test report.

3.4.3 Test Procedures

1. The testing follows FCC KDB 789033 D02 General UNII Test Procedures New Rules v01r04. Section G) Unwanted emissions measurement.

(1) Procedure for Unwanted Emissions Measurements Below 1000MHz

- RBW = 120 kHz
- VBW = 300 kHz
- Detector = Peak
- Trace mode = max hold

(2) Procedure for Peak Unwanted Emissions Measurements Above 1000 MHz

- RBW = 1 MHz
- VBW \geq 3 MHz
- Detector = Peak
- Sweep time = auto
- Trace mode = max hold

(3) Procedures for Average Unwanted Emissions Measurements Above 1000MHz

- RBW = 1 MHz
- VBW = 10 Hz, when duty cycle is no less than 98 percent.
- VBW \geq 1/T, when duty cycle is less than 98 percent where T is the minimum transmission duration over which the transmitter is on and is transmitting at its maximum power control level for the tested mode of operation.

2. The EUT was placed on a turntable with 0.8 meter for frequency below 1GHz and 1.5 meter for frequency above 1GHz respectively above ground.
3. The EUT was set 3 meters from the interference receiving antenna which was mounted on the top of a variable height antenna tower.
4. The antenna is a broadband antenna and its height is adjusted between one meter and four meters above ground to find the maximum value of the field strength for both horizontal polarization and vertical polarization of the antenna.
5. For each suspected emission, the EUT was arranged to its worst case and then adjust the antenna tower (from 1 m to 4 m) and turntable (from 0 degree to 360 degrees) to find the maximum reading.
6. For testing below 1GHz, if the emission level of the EUT in peak mode was 3 dB lower than the limit specified, then peak values of EUT will be reported, otherwise, the emissions will be repeated one by one using the CISPR quasi-peak method and reported.
7. For testing above 1GHz, the emission level of the EUT in peak mode was 20dB lower than average limit (that means the emission level in average mode also complies with the limit in average mode), then peak values of EUT will be reported, otherwise, the emissions will be measured in average mode again and reported.

3.4.4 Test Setup

For radiated emissions below 30MHz

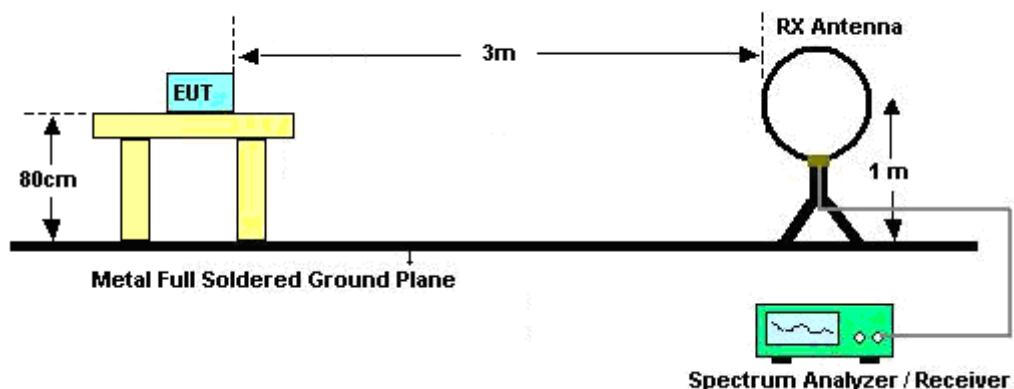

For radiated emissions from 30MHz to 1GHz

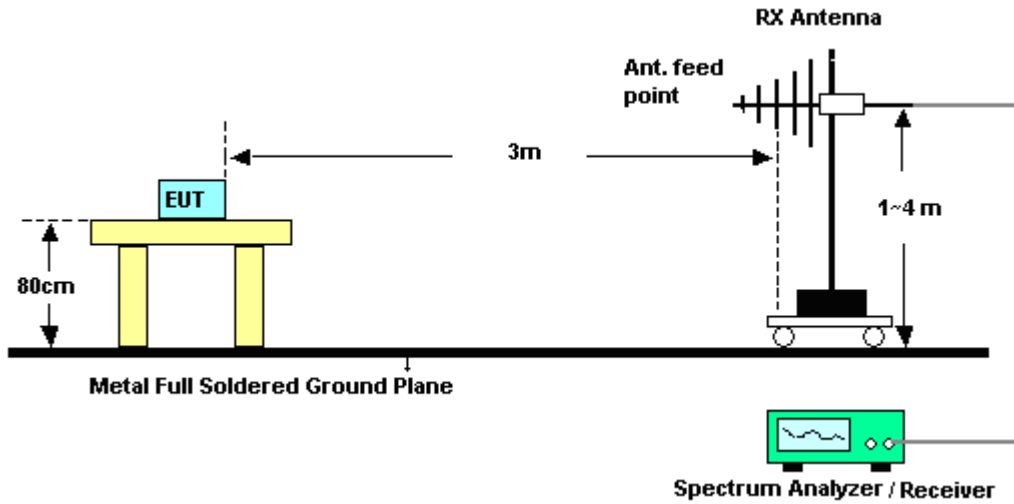

For radiated emissions above 1GHz

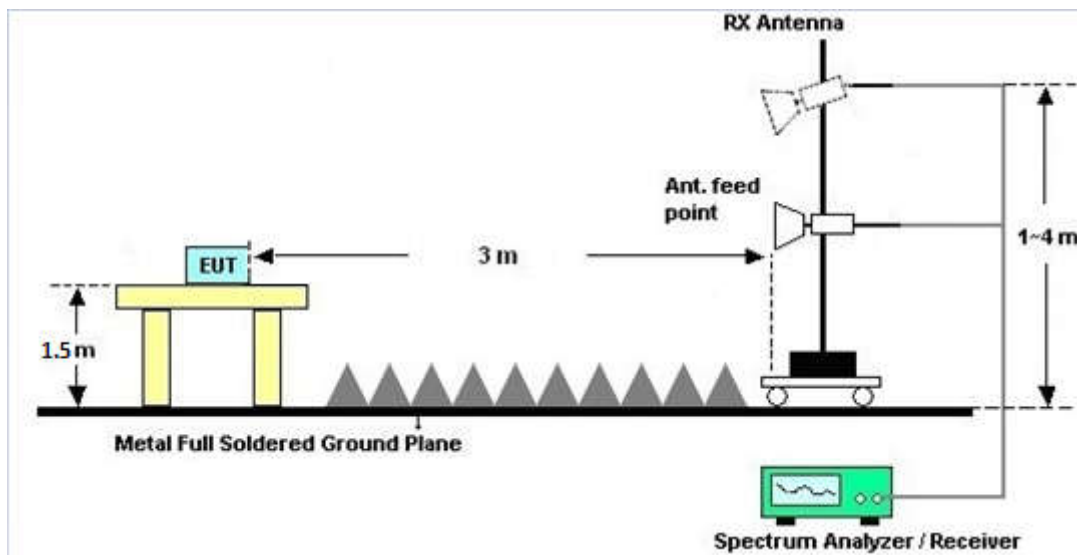



3.4.5 Test Results of Radiated Spurious Emissions (9 kHz ~ 30 MHz)

The low frequency, which started from 9 kHz to 30MHz, was pre-scanned and the result which was 20dB lower than the limit line per 15.31(o) was not reported.

3.4.6 Test Result of Radiated Spurious at Band Edges

Please refer to Appendix B.

3.4.7 Duty Cycle

Please refer to Appendix C.

3.4.8 Test Result of Radiated Spurious Emissions (30MHz ~ 10th Harmonic)

Please refer to Appendix B.



3.5 AC Conducted Emission Measurement

3.5.1 Limit of AC Conducted Emission

For equipment that is designed to be connected to the public utility (AC) power line, the radio frequency voltage that is conducted back onto the AC power line on any frequency or frequencies within the band 150 kHz to 30 MHz shall not exceed the limits in the following table.

Frequency of emission (MHz)	Conducted limit (dBµV)	
	Quasi-peak	Average
0.15-0.5	66 to 56*	56 to 46*
0.5-5	56	46
5-30	60	50

*Decreases with the logarithm of the frequency.

3.5.2 Measuring Instruments

The measuring equipment is listed in the section 4 of this test report.

3.5.3 Test Procedures

1. The EUT was placed 0.4 meter from the conducting wall of the shielding room was kept at least 80 centimeters from any other grounded conducting surface.
2. Connect EUT to the power mains through a line impedance stabilization network (LISN).
3. All the support units are connecting to the other LISN.
4. The LISN provides 50 ohm coupling impedance for the measuring instrument.
5. The FCC states that a 50 ohm, 50 microhenry LISN should be used.
6. Both sides of AC line were checked for maximum conducted interference.
7. The frequency range from 150 kHz to 30 MHz was searched.
8. Set the test-receiver system to Peak Detect Function and specified bandwidth with Maximum Hold Mode.

3.5.4 Test Setup

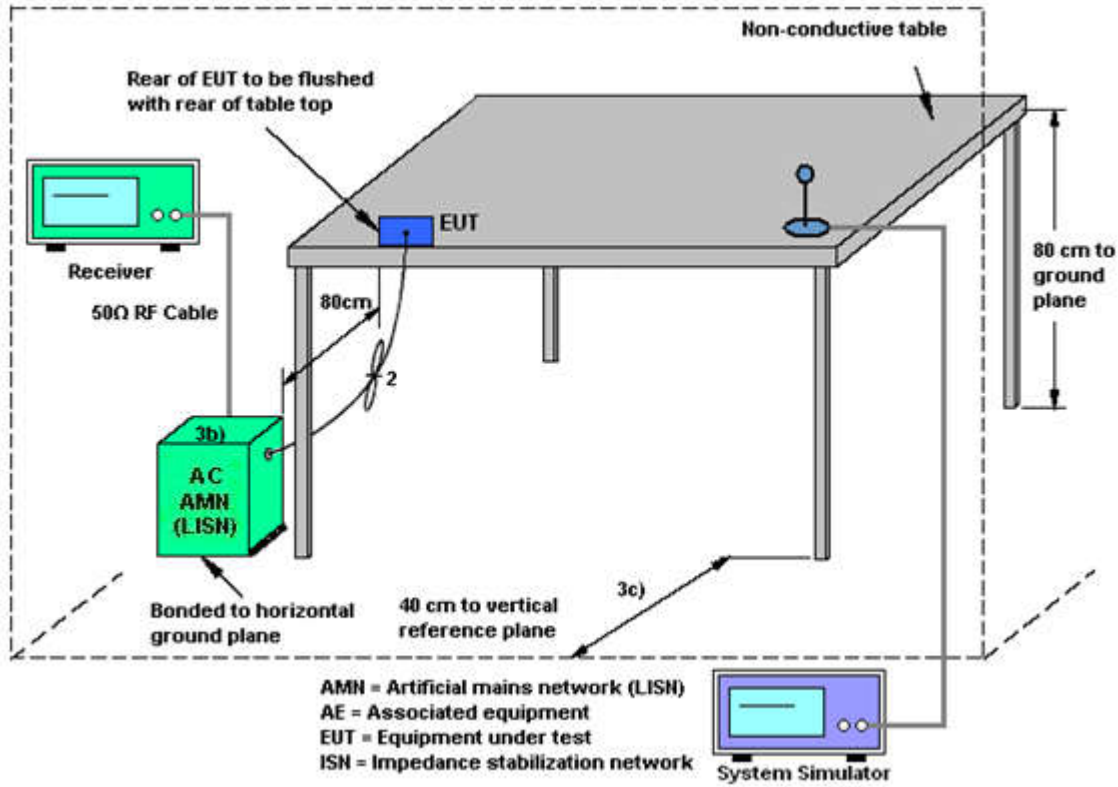



3.5.5 Test Result of AC Conducted Emission

Test Mode :	Mode 1	Temperature :	22~24°C
Test Engineer :	Eko Guan	Relative Humidity :	40~42%
Test Voltage :	120Vac / 60Hz	Phase :	Line
Function Type :	GSM850 Idle + Bluetooth Link + WLAN Link (5G) + USB Cable (Charging from Adapter 1) + Earphone 1		

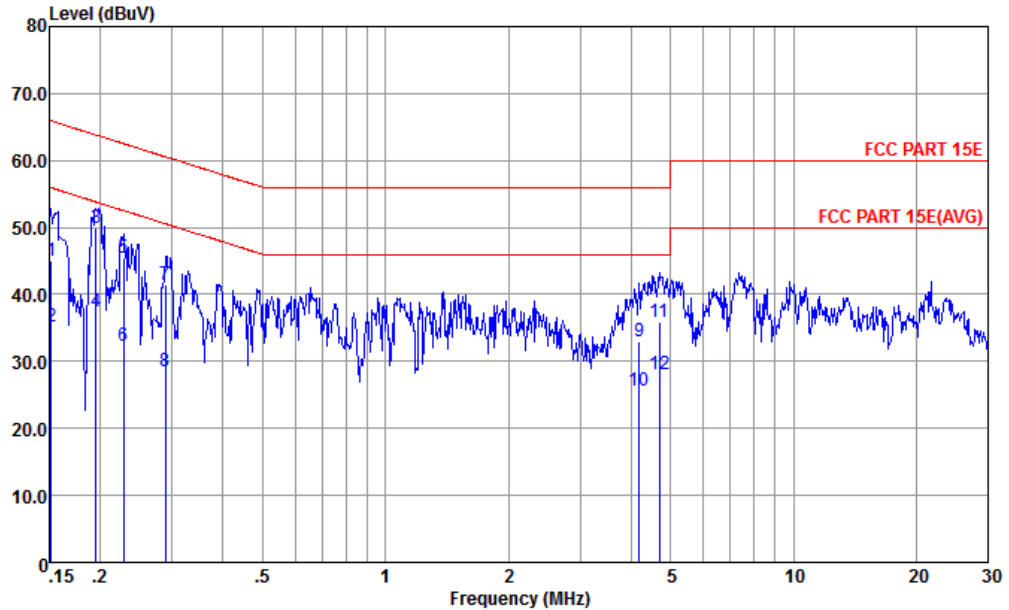

Site : CO01-KS
 Condition : FCC PART 15E LISN-L-171013-060103 LINE

	Freq	Level	Over Limit	Limit Line	Read Level	LISN Factor	Cable Loss	Remark
	MHz	dBuV	dB	dBuV	dBuV	dB	dB	
1	0.152	44.97	-20.94	65.91	34.20	0.16	10.61	QP
2	0.152	35.27	-20.64	55.91	24.50	0.16	10.61	Average
3 *	0.195	49.86	-13.94	63.80	39.19	0.20	10.47	QP
4	0.195	37.46	-16.34	53.80	26.79	0.20	10.47	Average
5	0.228	45.45	-17.07	62.52	34.79	0.21	10.45	QP
6	0.228	32.25	-20.27	52.52	21.59	0.21	10.45	Average
7	0.289	41.45	-19.09	60.54	30.80	0.22	10.43	QP
8	0.289	28.55	-21.99	50.54	17.90	0.22	10.43	Average
9	4.180	33.03	-22.97	56.00	22.50	0.35	10.18	QP
10	4.180	25.73	-20.27	46.00	15.20	0.35	10.18	Average
11	4.696	35.78	-20.22	56.00	25.21	0.36	10.21	QP
12	4.696	28.08	-17.92	46.00	17.51	0.36	10.21	Average



Test Mode :	Mode 1	Temperature :	22~24°C
Test Engineer :	Eko Guan	Relative Humidity :	40~42%
Test Voltage :	120Vac / 60Hz	Phase :	Neutral
Function Type :	GSM850 Idle + Bluetooth Link + WLAN Link (5G) + USB Cable (Charging from Adapter 1) + Earphone 1		

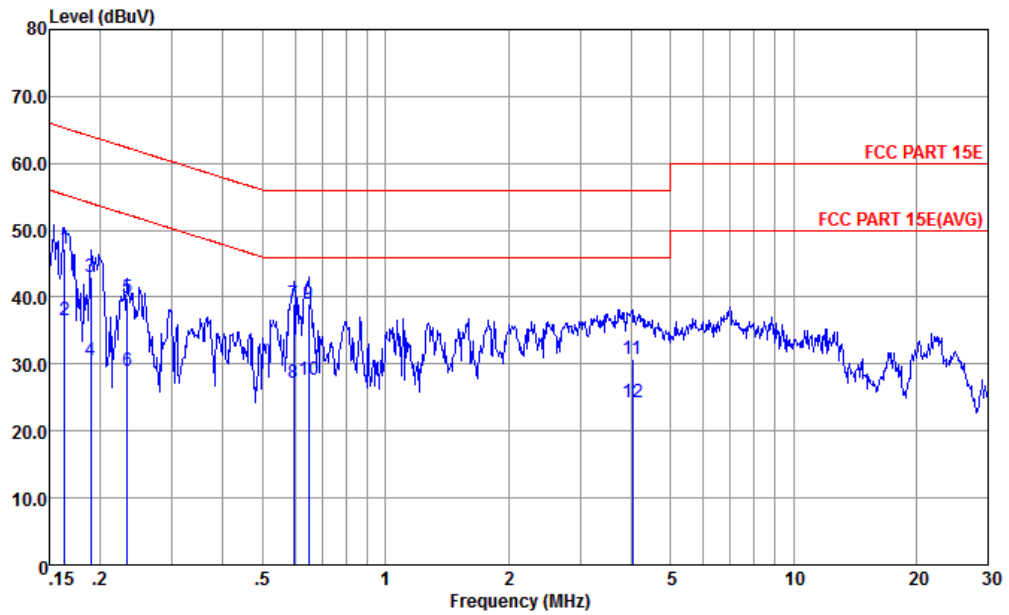

Site : CO01-KS
 Condition : FCC PART 15E LISN-N-171013-060103 NEUTRAL

	Freq	Level	Over Limit	Limit Line	Read Level	LISN Factor	Cable Loss	Remark
	MHz	dBuV	dB	dBuV	dBuV	dB	dB	
1	0.163	47.15	-18.15	65.30	36.30	0.28	10.57	QP
2	0.163	36.65	-18.65	55.30	25.80	0.28	10.57	Average
3	0.189	43.07	-20.99	64.06	32.30	0.28	10.49	QP
4	0.189	30.57	-23.49	54.06	19.80	0.28	10.49	Average
5	0.233	39.93	-22.42	62.35	29.21	0.28	10.44	QP
6	0.233	28.93	-23.42	52.35	18.21	0.28	10.44	Average
7 *	0.595	39.03	-16.97	56.00	28.50	0.30	10.23	QP
8	0.595	27.13	-18.87	46.00	16.60	0.30	10.23	Average
9	0.647	38.99	-17.01	56.00	28.49	0.30	10.20	QP
10	0.647	27.69	-18.31	46.00	17.19	0.30	10.20	Average
11	4.027	30.80	-25.20	56.00	20.29	0.34	10.17	QP
12	4.027	24.30	-21.70	46.00	13.79	0.34	10.17	Average



3.6 Automatically Discontinue Transmission

3.6.1 Limit of Automatically Discontinue Transmission

The device shall automatically discontinue transmission in case of either absence of information to transmit or operational failure. These provisions are not intended to preclude the transmission of control or signaling information or the use of repetitive codes used by certain digital technologies to complete frame or burst intervals. Applicants shall include in their application for equipment authorization to describe how this requirement is met.

3.6.2 Measuring Instruments

The measuring equipment is listed in the section 4 of this test report.

3.6.3 Test Result of Automatically Discontinue Transmission

While the EUT is not transmitting any information, the EUT can automatically discontinue transmission and become standby mode for power saving. The EUT can detect the controlling signal of ACK message transmitting from remote device and verify whether it shall resend or discontinue transmission.



3.7 Antenna Requirements

3.7.1 Standard Applicable

According to FCC 47 CFR Section 15.407(a)(1)(2) ,if transmitting antenna directional gain is greater than 6 dBi, both the peak transmit power and the peak power spectral density shall be reduced by the amount in dB that the directional gain of the antenna exceeds 6 dBi.

3.7.2 Antenna Anti-Replacement Construction

An embedded-in antenna design is used.

3.7.3 Antenna Gain

The antenna gain is less than 6 dBi. Therefore, it is not necessary to reduce maximum peak output power limit.



4 List of Measuring Equipment

Instrument	Manufacturer	Model No.	Serial No.	Characteristics	Calibration Date	Test Date	Due Date	Remark
Spectrum Analyzer	R&S	FSV40	101040	10Hz~40GHz	Aug. 08, 2017	Jan. 02, 2018~ Jan. 05, 2018	Aug. 07, 2018	Conducted (TH01-KS)
Pulse Power Sensor	Anritsu	MA2411B	0917070	300MHz~40GHz	Jan. 19, 2017	Jan. 02, 2018~ Jan. 05, 2018	Jan. 18, 2018	Conducted (TH01-KS)
Power Meter	Anritsu	ML2495A	1005002	50MHz Bandwidth	Jan. 19, 2017	Jan. 02, 2018~ Jan. 05, 2018	Jan. 18, 2018	Conducted (TH01-KS)
EMI Test Receiver&SA	Agilent	N9038A	MY52260185	20Hz~26.5GHz	Apr. 20, 2017	Jan. 12, 2018~ Jan. 17, 2018	Apr. 19, 2018	Radiation (03CH01-SZ)
Loop Antenna	R&S	HFH2-Z2	100354	9kHz~30MHz	May 14, 2017	Jan. 12, 2018~ Jan. 17, 2018	May 13, 2018	Radiation (03CH01-SZ)
Bilog Antenna	TeseQ	CBL6112D	23188	30MHz-2GHz	Apr. 25, 2017	Jan. 12, 2018~ Jan. 17, 2018	Apr. 24, 2018	Radiation (03CH01-SZ)
Double Ridge Horn Antenna	ETS Lindgren	3117	119436	1GHz~18GHz	Jul. 28, 2017	Jan. 12, 2018~ Jan. 17, 2018	Jul. 27, 2018	Radiation (03CH01-SZ)
SHF-EHF Horn	com-power	AH-840	101071	18Ghz-40GHz	Jun. 16, 2017	Jan. 12, 2018~ Jan. 17, 2018	Jun. 15, 2018	Radiation (03CH01-SZ)
LF Amplifier	Burgeon	BPA-530	102209	0.01~3000Mhz	Apr. 20, 2017	Jan. 12, 2018~ Jan. 17, 2018	Apr. 19, 2018	Radiation (03CH01-SZ)
HF Amplifier	MITEQ	AMF-7D-0010 1800-30-10P-R	1707137	1GHz~18GHz	Oct. 19, 2017	Jan. 12, 2018~ Jan. 17, 2018	Oct. 18, 2018	Radiation (03CH01-SZ)
HF Amplifier	KEYSIGHT	83017A	MY53270104	0.5GHz~26.5GHz	Oct. 19, 2017	Jan. 12, 2018~ Jan. 17, 2018	Oct. 18, 2018	Radiation (03CH01-SZ)
HF Amplifier	MITEQ	TTA1840-35-H G	1871923	18GHz~40GHz	Jul. 18, 2017	Jan. 12, 2018~ Jan. 17, 2018	Jul. 17, 2018	Radiation (03CH01-SZ)
AC Power Source	Chroma	61601	6160100019 85	N/A	NCR	Jan. 12, 2018~ Jan. 17, 2018	NCR	Radiation (03CH01-SZ)
Turn Table	EM	EM1000	N/A	0~360 degree	NCR	Jan. 12, 2018~ Jan. 17, 2018	NCR	Radiation (03CH01-SZ)
EMI Receiver	R&S	ESC17	100768	9kHz~7GHz;	Apr. 20, 2017	Jan. 22, 2018	Apr. 19, 2018	Conduction (CO01-KS)
AC LISN	MessTec	AN3016	060103	9kHz~30MHz	Oct. 13, 2017	Jan. 22, 2018	Oct. 12, 2018	Conduction (CO01-KS)
AC LISN (for auxiliary equipment)	MessTec	AN3016	060105	9kHz~30MHz	Oct. 13, 2017	Jan. 22, 2018	Oct. 12, 2018	Conduction (CO01-KS)
AC Power Source	Chroma	61602	ABP0000008 11	AC 0V~300V, 45Hz~1000Hz	Oct. 12, 2017	Jan. 22, 2018	Oct. 11, 2018	Conduction (CO01-KS)

NCR: No Calibration Required



5 Uncertainty of Evaluation

Uncertainty of Conducted Emission Measurement (150kHz ~ 30MHz)

Measuring Uncertainty for a Level of Confidence of 95% ($U = 2Uc(y)$)	2.3dB
---	-------

Uncertainty of Radiated Emission Measurement (30 MHz ~ 1000 MHz)

Measuring Uncertainty for a Level of Confidence of 95% ($U = 2Uc(y)$)	4.8dB
---	-------

Uncertainty of Radiated Emission Measurement (1000 MHz ~ 18000 MHz)

Measuring Uncertainty for a Level of Confidence of 95% ($U = 2Uc(y)$)	5.0dB
---	-------

Uncertainty of Radiated Emission Measurement (18000 MHz ~ 40000 MHz)

Measuring Uncertainty for a Level of Confidence of 95% ($U = 2Uc(y)$)	4.3dB
---	-------



Appendix A. Conducted Test Results

Test Engineer:	Silent Hai	Temperature:	21~25	°C
Test Date:	2018/1/2 ~ 2018/1/5	Relative Humidity:	51~55	%

TEST RESULTS DATA
6dB and 26dB EBW and 99% OBW

Band IV									
Mod.	Data Rate	NTX	CH.	Freq. (MHz)	99% Bandwidth (MHz)	26 dB Bandwidth (MHz)	6 dB Bandwidth (MHz)	6dB Bandwidth min. Limit (MHz)	Pass/Fail
11a	6M bps	1	149	5745	17.48	23.73	15.32	0.5	Pass
11a	6M bps	1	157	5785	17.58	23.23	15.50	0.5	Pass
11a	6M bps	1	165	5825	17.48	22.83	15.52	0.5	Pass
HT40	MCS 0	1	151	5755	36.56	41.81	35.33	0.5	Pass
HT40	MCS 0	1	159	5795	36.46	41.99	35.13	0.5	Pass
VHT20	MCS 0	1	149	5745	18.73	25.18	15.96	0.5	Pass
VHT20	MCS 0	1	157	5785	18.73	24.88	16.50	0.5	Pass
VHT20	MCS 0	1	165	5825	18.63	24.73	16.52	0.5	Pass
VHT80	MCS 0	1	155	5775	75.76	83.60	75.13	0.5	Pass

TEST RESULTS DATA
Average Power Table

Band IV										
Mod.	Data Rate	N _{TX}	CH.	Freq. (MHz)	Duty Factor (dB)	Average Conducted Power (dBm)	FCC Conducted Power Limit (dBm)	DG (dBi)		Pass/Fail
11a	6M bps	1	149	5745	0.20	15.02	30.00	-3.00		Pass
11a	6M bps	1	157	5785	0.20	14.78	30.00	-3.00		Pass
11a	6M bps	1	165	5825	0.20	14.85	30.00	-3.00		Pass
HT20	MCS 0	1	149	5745	0.26	13.61	30.00	-3.00		Pass
HT20	MCS 0	1	157	5785	0.26	13.47	30.00	-3.00		Pass
HT20	MCS 0	1	165	5825	0.26	13.65	30.00	-3.00		Pass
HT40	MCS 0	1	151	5755	0.45	13.17	30.00	-3.00		Pass
HT40	MCS 0	1	159	5795	0.45	13.14	30.00	-3.00		Pass
VHT20	MCS 0	1	149	5745	0.20	14.79	30.00	-3.00		Pass
VHT20	MCS 0	1	157	5785	0.20	14.71	30.00	-3.00		Pass
VHT20	MCS 0	1	165	5825	0.20	14.89	30.00	-3.00		Pass
VHT40	MCS 0	1	151	5755	0.40	13.08	30.00	-3.00		Pass
VHT40	MCS 0	1	159	5795	0.40	13.09	30.00	-3.00		Pass
VHT80	MCS 0	1	155	5775	0.75	11.77	30.00	-3.00		Pass

TEST RESULTS DATA
Power Spectral Density

Band IV										
Mod.	Data Rate	NTX	CH.	Freq. (MHz)	Duty Factor (dB)	10log (500kHz /RBW) Factor (dB)	Average Power Density (dBm/500kHz)	Average PSD Limit (dBm/500kHz)	DG (dBi)	Pass/Fail
11a	6M bps	1	149	5745	0.56	2.22	2.52	30.00	-3.00	Pass
11a	6M bps	1	157	5785	0.56	2.22	2.50	30.00	-3.00	Pass
11a	6M bps	1	165	5825	0.56	2.22	1.87	30.00	-3.00	Pass
HT40	MCS 0	1	151	5755	0.45	2.22	-3.07	30.00	-3.00	Pass
HT40	MCS 0	1	159	5795	0.45	2.22	-2.85	30.00	-3.00	Pass
VHT20	MCS 0	1	149	5745	0.20	2.22	1.37	30.00	-3.00	Pass
VHT20	MCS 0	1	157	5785	0.20	2.22	1.72	30.00	-3.00	Pass
VHT20	MCS 0	1	165	5825	0.20	2.22	1.61	30.00	-3.00	Pass
VHT80	MCS 0	1	155	5775	0.75	2.22	-7.55	30.00	-3.00	Pass



Appendix B. Radiated Spurious Emission

Band 4 - 5725~5850MHz WIFI 802.11a (Band Edge @ 3m)

WIFI	Note	Frequency	Level	Over	Limit	Read	Antenna	Cable	Preamp	Ant	Table	Peak	Pol.
Ant.				Limit	Line	Level	Factor	Loss	Factor	Pos	Pos	Avg.	
1		(MHz)	(dBμV/m)	(dB)	(dBμV/m)	(dBμV)	(dB/m)	(dB)	(dB)	(cm)	(deg)	(P/A)	(H/V)
802.11a CH 149 5745MHz		5645.2	56.14	-12.06	68.2	40.23	34.5	12.23	30.82	119	306	P	H
		5681.8	55.41	-36.36	91.77	39.41	34.48	12.37	30.85	119	306	P	H
		5719.8	60.07	-50.67	110.74	44	34.46	12.51	30.9	119	306	P	H
		5725	65.83	-56.37	122.2	49.76	34.46	12.51	30.9	119	306	P	H
	*	5745	104.52	-	-	88.33	34.45	12.65	30.91	119	306	P	H
	*	5745	97.59	-	-	81.4	34.45	12.65	30.91	119	306	A	H
		5604.4	55.32	-12.88	68.2	39.56	34.46	12.09	30.79	357	277	P	V
		5698.8	55.9	-48.42	104.32	39.92	34.48	12.37	30.87	357	277	P	V
		5718	58.47	-51.77	110.24	42.4	34.46	12.51	30.9	357	277	P	V
		5725	67.84	-54.36	122.2	51.77	34.46	12.51	30.9	357	277	P	V
	*	5745	106.01	-	-	89.82	34.45	12.65	30.91	357	277	P	V
	*	5745	98.79	-	-	82.6	34.45	12.65	30.91	357	277	A	V



WIFI Ant. 1	Note	Frequency (MHz)	Level (dBμV/m)	Over Limit (dB)	Limit Line (dBμV/m)	Read Level (dBμV)	Antenna Factor (dB/m)	Cable Loss (dB)	Preamp Factor (dB)	Ant Pos (cm)	Table Pos (deg)	Peak Avg. (P/A)	Pol. (H/V)
		5621	55.54	-12.66	68.2	39.78	34.48	12.09	30.81	100	228	P	H
		5692.8	55.46	-44.43	99.89	39.48	34.48	12.37	30.87	100	228	P	H
		5705.4	54.17	-52.54	106.71	38.07	34.47	12.51	30.88	100	228	P	H
		5721.4	55.02	-58.97	113.99	38.95	34.46	12.51	30.9	100	228	P	H
	*	5785	103.45	-	-	87.16	34.44	12.79	30.94	100	228	P	H
	*	5785	97.12	-	-	80.83	34.44	12.79	30.94	100	228	A	H
		5850.8	55.97	-64.41	120.38	39.68	34.41	12.88	31	100	228	P	H
		5858.8	54.8	-54.93	109.73	38.45	34.4	12.97	31.02	100	228	P	H
		5896.8	55.76	-33.27	89.03	39.34	34.42	13.05	31.05	100	228	P	H
		5931.6	55.15	-13.05	68.2	38.73	34.45	13.05	31.08	100	228	P	H
		5615.6	57.05	-11.15	68.2	41.29	34.48	12.09	30.81	354	257	P	V
		5694.4	55.97	-45.1	101.07	39.99	34.48	12.37	30.87	354	257	P	V
		5716.2	55.45	-54.29	109.74	39.35	34.47	12.51	30.88	354	257	P	V
		5723.4	54.85	-63.7	118.55	38.78	34.46	12.51	30.9	354	257	P	V
	*	5785	106.18	-	-	89.89	34.44	12.79	30.94	354	257	P	V
	*	5785	100.44	-	-	84.15	34.44	12.79	30.94	354	257	A	V
		5852.4	55.16	-61.57	116.73	38.87	34.41	12.88	31	354	257	P	V
		5868.8	55.84	-51.09	106.93	39.49	34.4	12.97	31.02	354	257	P	V
		5902.8	56.21	-28.38	84.59	39.79	34.42	13.05	31.05	354	257	P	V
		5941.4	55.89	-12.31	68.2	39.38	34.46	13.14	31.09	354	257	P	V



WiFi Ant. 1	Note	Frequency (MHz)	Level (dBμV/m)	Over Limit (dB)	Limit Line (dBμV/m)	Read Level (dBμV)	Antenna Factor (dB/m)	Cable Loss (dB)	Preamp Factor (dB)	Ant Pos (cm)	Table Pos (deg)	Peak Avg. (P/A)	Pol. (H/V)
802.11a CH 165 5825MHz	*	5825	103.27	-	-	86.96	34.42	12.88	30.99	103	228	P	H
	*	5825	96.66	-	-	80.35	34.42	12.88	30.99	103	228	A	H
		5851	60.07	-59.85	119.92	43.78	34.41	12.88	31	103	228	P	H
		5856.8	59.14	-51.16	110.3	42.79	34.4	12.97	31.02	103	228	P	H
		5915.8	55.01	-19.97	74.98	38.58	34.44	13.05	31.06	103	228	P	H
		5935	55.73	-12.47	68.2	39.22	34.45	13.14	31.08	103	228	P	H
	*	5825	106	-	-	89.69	34.42	12.88	30.99	353	266	P	V
	*	5825	100.67	-	-	84.36	34.42	12.88	30.99	353	266	A	V
		5850	61.56	-60.64	122.2	45.27	34.41	12.88	31	353	266	P	V
		5856.8	60.62	-49.68	110.3	44.27	34.4	12.97	31.02	353	266	P	V
		5917.8	56.65	-16.86	73.51	40.22	34.44	13.05	31.06	353	266	P	V
		5946.2	55.57	-12.63	68.2	39.06	34.46	13.14	31.09	353	266	P	V
Remark	<ol style="list-style-type: none"> No other spurious found. All results are PASS against Peak and Average limit line. 												



Band 4 5725~5850MHz

WIFI 802.11a (Harmonic @ 3m)

WIFI Ant. 1	Note	Frequency (MHz)	Level (dBμV/m)	Over Limit (dB)	Limit Line (dBμV/m)	Read Level (dBμV)	Antenna Factor (dB/m)	Cable Loss (dB)	Preamp Factor (dB)	Ant Pos (cm)	Table Pos (deg)	Peak Avg. (P/A)	Pol. (H/V)
802.11a CH 149 5745MHz		11490	50.76	-23.24	74	53.55	37.69	14.88	55.36	160	360	P	H
		17235	50.04	-18.16	68.2	44.6	43.89	18.04	56.49	170	360	P	H
		11490	50.04	-23.96	74	52.83	37.69	14.88	55.36	160	360	P	V
		17235	50.68	-17.52	68.2	45.24	43.89	18.04	56.49	170	360	P	V
802.11a CH 157 5785MHz		11570	49.18	-24.82	74	51.71	37.81	14.9	55.24	175	198	P	H
		17355	50.23	-17.97	68.2	45.1	43.53	18.18	56.58	189	185	P	H
		11570	50.78	-23.22	74	53.31	37.81	14.9	55.24	175	198	P	V
		17355	50.16	-18.04	68.2	45.03	43.53	18.18	56.58	189	185	P	V
802.11a CH 165 5825MHz		11650	55.55	-18.45	74	57.84	37.92	14.92	55.13	156	347	P	H
		11650	50.96	-3.04	54	53.25	37.92	14.92	55.13	156	347	A	H
		17475	50.56	-17.64	68.2	45.75	43.18	18.31	56.68	150	360	P	H
		11650	50.9	-23.1	74	53.19	37.92	14.92	55.13	156	347	P	V
		17475	50.25	-17.95	68.2	45.44	43.18	18.31	56.68	150	360	P	V
Remark	<ol style="list-style-type: none"> No other spurious found. All results are PASS against Peak and Average limit line. 												



Band 4 5725~5850MHz
WIFI 802.11n HT20 (Band Edge @ 3m)

Table with 14 columns: WIFI Ant. 1, Note, Frequency (MHz), Level (dBµV/m), Over Limit (dB), Limit Line (dBµV/m), Read Level (dBµV), Antenna Factor (dB/m), Cable Loss (dB), Preamp Factor (dB), Ant Pos (cm), Table Pos (deg), Peak Avg. (P/A), Pol. (H/V). Rows include frequencies like 5618.2, 5678.6, 5719.8, 5725, 5745, 5745, 5642.8, 5656.2, 5719.8, 5723, 5745, 5745.



WiFi Ant. 1	Note	Frequency (MHz)	Level (dBμV/m)	Over Limit (dB)	Limit Line (dBμV/m)	Read Level (dBμV)	Antenna Factor (dB/m)	Cable Loss (dB)	Preamp Factor (dB)	Ant Pos (cm)	Table Pos (deg)	Peak Avg. (P/A)	Pol. (H/V)
		5615.2	55.39	-12.81	68.2	39.63	34.46	12.09	30.79	137	301	P	H
		5693	55.62	-44.42	100.04	39.64	34.48	12.37	30.87	137	301	P	H
		5709	55.52	-52.2	107.72	39.42	34.47	12.51	30.88	137	301	P	H
		5724.4	55.17	-65.66	120.83	39.1	34.46	12.51	30.9	137	301	P	H
	*	5785	103.61	-	-	87.32	34.44	12.79	30.94	137	301	P	H
	*	5785	97.69	-	-	81.4	34.44	12.79	30.94	137	301	A	H
		5850.4	54.88	-66.41	121.29	38.59	34.41	12.88	31	137	301	P	H
		5865	55.46	-52.54	108	39.11	34.4	12.97	31.02	137	301	P	H
		5906.2	55.53	-26.55	82.08	39.1	34.44	13.05	31.06	137	301	P	H
		5948	56.04	-12.16	68.2	39.53	34.46	13.14	31.09	137	301	P	H
		5611	55.05	-13.15	68.2	39.29	34.46	12.09	30.79	356	271	P	V
		5676	56.61	-30.87	87.48	40.61	34.48	12.37	30.85	356	271	P	V
		5712.6	56.52	-52.21	108.73	40.42	34.47	12.51	30.88	356	271	P	V
		5724	53.71	-66.21	119.92	37.64	34.46	12.51	30.9	356	271	P	V
	*	5785	105.42	-	-	89.13	34.44	12.79	30.94	356	271	P	V
	*	5785	98.78	-	-	82.49	34.44	12.79	30.94	356	271	A	V
		5853.2	55.47	-59.43	114.9	39.18	34.41	12.88	31	356	271	P	V
		5860.2	55.72	-53.62	109.34	39.37	34.4	12.97	31.02	356	271	P	V
		5876.2	55.82	-48.49	104.31	39.47	34.41	12.97	31.03	356	271	P	V
		5927.6	56.53	-11.67	68.2	40.11	34.45	13.05	31.08	356	271	P	V



WIFI Ant. 1	Note	Frequency (MHz)	Level (dBμV/m)	Over Limit (dB)	Limit Line (dBμV/m)	Read Level (dBμV)	Antenna Factor (dB/m)	Cable Loss (dB)	Preamp Factor (dB)	Ant Pos (cm)	Table Pos (deg)	Peak Avg. (P/A)	Pol. (H/V)
802.11n HT20 CH 165 5825MHz	*	5825	103.9	-	-	87.59	34.42	12.88	30.99	143	309	P	H
	*	5825	96.47	-	-	80.16	34.42	12.88	30.99	143	309	A	H
		5851.2	58.39	-61.07	119.46	42.1	34.41	12.88	31	143	309	P	H
		5857.2	57.01	-53.17	110.18	40.66	34.4	12.97	31.02	143	309	P	H
		5887.2	57.17	-38.97	96.14	40.82	34.41	12.97	31.03	143	309	P	H
		5934.8	54.97	-13.23	68.2	38.46	34.45	13.14	31.08	143	309	P	H
	*	5825	105.41	-	-	89.1	34.42	12.88	30.99	365	276	P	V
	*	5825	98.71	-	-	82.4	34.42	12.88	30.99	365	276	A	V
		5850	57.74	-64.46	122.2	41.45	34.41	12.88	31	365	276	P	V
		5858.2	56.35	-53.55	109.9	40	34.4	12.97	31.02	365	276	P	V
		5892.2	56.86	-35.58	92.44	40.52	34.42	12.97	31.05	365	276	P	V
		5947.6	55	-13.2	68.2	38.49	34.46	13.14	31.09	365	276	P	V
Remark	<ol style="list-style-type: none"> No other spurious found. All results are PASS against Peak and Average limit line. 												



Band 4 5725~5850MHz
WIFI 802.11n HT20 (Harmonic @ 3m)

WIFI Ant. 1	Note	Frequency (MHz)	Level (dBμV/m)	Over Limit (dB)	Limit Line (dBμV/m)	Read Level (dBμV)	Antenna Factor (dB/m)	Cable Loss (dB)	Preamp Factor (dB)	Ant Pos (cm)	Table Pos (deg)	Peak Avg. (P/A)	Pol. (H/V)
802.11n HT20		11490	50.06	-23.94	74	52.85	37.69	14.88	55.36	160	360	P	H
		17235	50.28	-17.92	68.2	44.84	43.89	18.04	56.49	170	360	P	H
CH 149 5745MHz		11490	49.55	-24.45	74	52.34	37.69	14.88	55.36	160	360	P	V
		17235	50.16	-18.04	68.2	44.72	43.89	18.04	56.49	170	360	P	V
802.11n HT20 CH 157 5785MHz		11570	54.49	-19.51	74	57.02	37.81	14.9	55.24	175	198	P	H
		11570	50.8	-3.2	54	53.33	37.81	14.9	55.24	175	198	A	H
		17355	50.71	-17.49	68.2	45.58	43.53	18.18	56.58	189	185	P	H
		11570	49.92	-24.08	74	52.45	37.81	14.9	55.24	175	198	P	V
		17355	50.74	-17.46	68.2	45.61	43.53	18.18	56.58	189	185	P	V
802.11n HT20 CH 165 5825MHz		11650	52.32	-21.68	74	54.61	37.92	14.92	55.13	156	347	P	H
		11650	50.02	-3.98	54	52.31	37.92	14.92	55.13	156	347	A	H
		17475	50.32	-17.88	68.2	45.51	43.18	18.31	56.68	150	360	P	H
		11650	50.81	-23.19	74	53.1	37.92	14.92	55.13	156	347	P	V
		17475	50.42	-17.78	68.2	45.61	43.18	18.31	56.68	150	360	P	V
Remark	1. No other spurious found. 2. All results are PASS against Peak and Average limit line.												



Band 4 5725~5850MHz
WIFI 802.11n HT40 (Band Edge @ 3m)

Table with 14 columns: WIFI Ant. 1, Note, Frequency (MHz), Level (dBµV/m), Over Limit (dB), Limit Line (dBµV/m), Read Level (dBµV), Antenna Factor (dB/m), Cable Loss (dB), Preamp Factor (dB), Ant Pos (cm), Table Pos (deg), Peak Avg. (P/A), Pol. (H/V). Rows include test data for frequencies from 5632.4 to 5936.6 MHz.



WiFi Ant. 1	Note	Frequency (MHz)	Level (dBμV/m)	Over Limit (dB)	Limit Line (dBμV/m)	Read Level (dBμV)	Antenna Factor (dB/m)	Cable Loss (dB)	Preamp Factor (dB)	Ant Pos (cm)	Table Pos (deg)	Peak Avg. (P/A)	Pol. (H/V)
		5645.4	55.34	-12.86	68.2	39.43	34.5	12.23	30.82	142	307	P	H
		5651.8	55.82	-13.72	69.54	39.94	34.49	12.23	30.84	142	307	P	H
		5713.4	55.67	-53.28	108.95	39.57	34.47	12.51	30.88	142	307	P	H
		5720	54.49	-56.31	110.8	38.42	34.46	12.51	30.9	142	307	P	H
	*	5795	102.37	-	-	86.11	34.43	12.79	30.96	142	307	P	H
	*	5795	95.36	-	-	79.1	34.43	12.79	30.96	142	307	A	H
		5854	55.9	-57.18	113.08	39.64	34.4	12.88	31.02	142	307	P	H
		5862.2	56.95	-51.83	108.78	40.6	34.4	12.97	31.02	142	307	P	H
		5898.8	55.95	-31.6	87.55	39.53	34.42	13.05	31.05	142	307	P	H
		5926.8	55.67	-12.53	68.2	39.25	34.45	13.05	31.08	142	307	P	H
		5609.8	55.86	-12.34	68.2	40.1	34.46	12.09	30.79	353	251	P	V
		5691	54.97	-43.59	98.56	38.99	34.48	12.37	30.87	353	251	P	V
		5716.8	54.98	-54.93	109.91	38.88	34.47	12.51	30.88	353	251	P	V
		5720.8	54.65	-57.97	112.62	38.58	34.46	12.51	30.9	353	251	P	V
	*	5795	101.22	-	-	84.96	34.43	12.79	30.96	353	251	P	V
	*	5795	93.06	-	-	76.8	34.43	12.79	30.96	353	251	A	V
		5854	55.4	-57.68	113.08	39.14	34.4	12.88	31.02	353	251	P	V
		5862.6	56.32	-52.35	108.67	39.97	34.4	12.97	31.02	353	251	P	V
		5919.6	56.53	-15.65	72.18	40.1	34.44	13.05	31.06	353	251	P	V
		5941	55.18	-13.02	68.2	38.67	34.46	13.14	31.09	353	251	P	V
Remark	1. No other spurious found. 2. All results are PASS against Peak and Average limit line.												



Band 4 5725~5850MHz
WIFI 802.11n HT40 (Harmonic @ 3m)

WIFI Ant. 1	Note	Frequency (MHz)	Level (dBμV/m)	Over Limit (dB)	Limit Line (dBμV/m)	Read Level (dBμV)	Antenna Factor (dB/m)	Cable Loss (dB)	Preamp Factor (dB)	Ant Pos (cm)	Table Pos (deg)	Peak Avg. (P/A)	Pol. (H/V)
802.11n HT40		11510	50.51	-23.49	74	53.27	37.7	14.88	55.34	160	360	P	H
		17265	50.56	-17.64	68.2	45.2	43.79	18.09	56.52	170	360	P	H
CH 151 5755MHz		11510	50.76	-23.24	74	53.52	37.7	14.88	55.34	160	360	P	V
		17265	50.86	-17.34	68.2	45.5	43.79	18.09	56.52	170	360	P	V
802.11n HT40		11590	50.6	-23.4	74	53.06	37.84	14.91	55.21	170	300	P	H
		17385	50.89	-17.31	68.2	45.85	43.43	18.22	56.61	150	200	P	H
CH 159 5795MHz		11590	50.4	-23.6	74	52.86	37.84	14.91	55.21	170	300	P	V
		17385	50.54	-17.66	68.2	45.5	43.43	18.22	56.61	150	200	P	V
Remark	1. No other spurious found. 2. All results are PASS against Peak and Average limit line.												



Emission below 1GHz
5GHz WIFI 802.11a (LF @ 3m)

WIFI	Note	Frequency	Level	Over	Limit	Read	Antenna	Cable	Preamp	Ant	Table	Peak	Pol.
Ant.				Limit	Line	Level	Factor	Loss	Factor	Pos	Pos	Avg.	
1		(MHz)	(dBμV/m)	(dB)	(dBμV/m)	(dBμV)	(dB/m)	(dB)	(dB)	(cm)	(deg)	(P/A)	(H/V)
5GHz 802.11a LF		31.94	27.99	-12.01	40	32.18	27.14	0.27	31.6	100	136	P	H
		172.59	25.03	-18.47	43.5	37.03	17.87	1.44	31.31	-	-	P	H
		207.51	26.36	-17.14	43.5	37.83	18.03	1.66	31.16	-	-	P	H
		226.91	25.08	-20.92	46	35.31	19.11	1.75	31.09	-	-	P	H
		435.46	31.38	-14.62	46	33.89	26.07	2.52	31.1	-	-	P	H
		961.2	28.81	-25.19	54	26.21	29.95	4	31.35	-	-	P	H
		34.85	33.55	-6.45	40	38.53	26.3	0.32	31.6	100	124	P	V
		206.54	22.43	-21.07	43.5	33.98	17.98	1.65	31.18	-	-	P	V
		226.91	21.5	-24.5	46	31.73	19.11	1.75	31.09	-	-	P	V
		433.52	29.06	-16.94	46	31.67	25.98	2.51	31.1	-	-	P	V
		658.56	26.1	-19.9	46	26.68	27.45	3.17	31.2	-	-	P	V
	986.42	29.36	-24.64	54	26.16	30.5	4.14	31.44	-	-	P	V	
Remark	1. No other spurious found. 2. All results are PASS against limit line.												



Note symbol

*	Fundamental Frequency which can be ignored. However, the level of any unwanted emissions shall not exceed the level of the fundamental frequency.
!	Test result is over limit line.
P/A	Peak or Average
H/V	Horizontal or Vertical



A calculation example for radiated spurious emission is shown as below:

WIFI	Note	Frequency	Level	Over	Limit	Read	Antenna	Cable	Preamp	Ant	Table	Peak	Pol.
Ant.				Limit	Line	Level	Factor	Loss	Factor	Pos	Pos	Avg.	
1		(MHz)	(dBμV/m)	(dB)	(dBμV/m)	(dBμV)	(dB/m)	(dB)	(dB)	(cm)	(deg)	(P/A)	(H/V)
802.11b		2390	55.45	-18.55	74	54.51	32.22	4.58	35.86	103	308	P	H
CH 01													
2412MHz		2390	43.54	-10.46	54	42.6	32.22	4.58	35.86	103	308	A	H

- Level(dBμV/m) =
Antenna Factor(dB/m) + Cable Loss(dB) + Read Level(dBμV) - Preamp Factor(dB)
- Over Limit(dB) = Level(dBμV/m) – Limit Line(dBμV/m)

For Peak Limit @ 2390MHz:

- Level(dBμV/m)
= Antenna Factor(dB/m) + Cable Loss(dB) + Read Level(dBμV) - Preamp Factor(dB)
= 32.22(dB/m) + 4.58(dB) + 54.51(dBμV) – 35.86 (dB)
= 55.45 (dBμV/m)
- Over Limit(dB)
= Level(dBμV/m) – Limit Line(dBμV/m)
= 55.45(dBμV/m) – 74(dBμV/m)
= -18.55(dB)

For Average Limit @ 2390MHz:

- Level(dBμV/m)
= Antenna Factor(dB/m) + Cable Loss(dB) + Read Level(dBμV) - Preamp Factor(dB)
= 32.22(dB/m) + 4.58(dB) + 42.6(dBμV) – 35.86 (dB)
= 43.54 (dBμV/m)
- Over Limit(dB)
= Level(dBμV/m) – Limit Line(dBμV/m)
= 43.54(dBμV/m) – 54(dBμV/m)
= -10.46(dB)

Both peak and average measured complies with the limit line, so test result is “PASS”.



Appendix C. Duty Cycle Plots

Band	Duty Cycle(%)	T(ms)	1/T(kHz)	VBW Setting
802.11a	95.54	2.078	0.481	1 kHz
802.11n HT20	94.20	1.930	0.518	1 kHz
802.11n HT40	90.10	0.949	1.053	3 kHz
802.11ac VHT80	84.21	0.464	2.156	3 kHz

802.11a

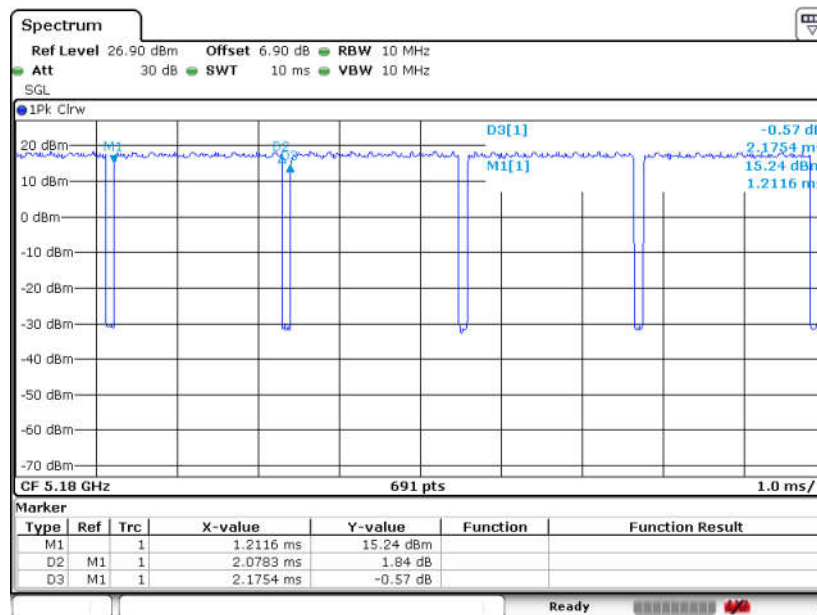



802.11n HT20

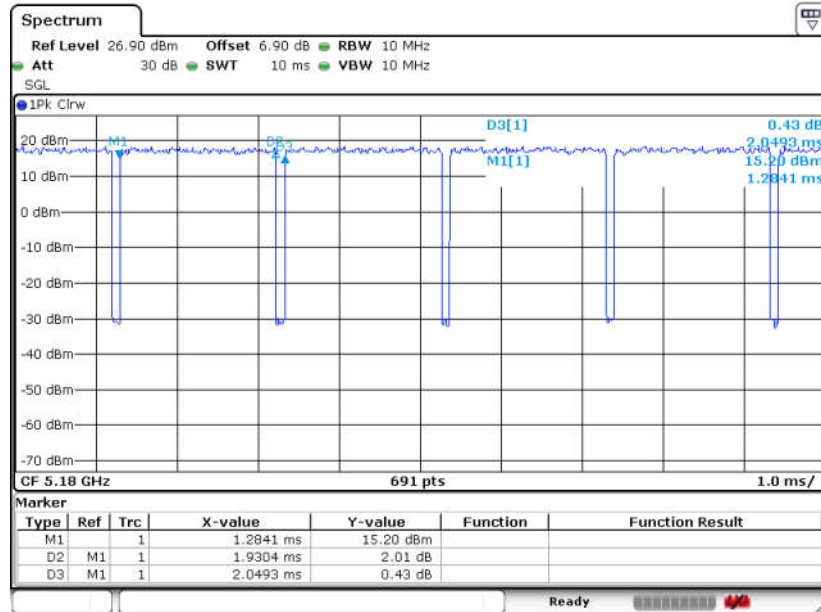

802.11n HT40

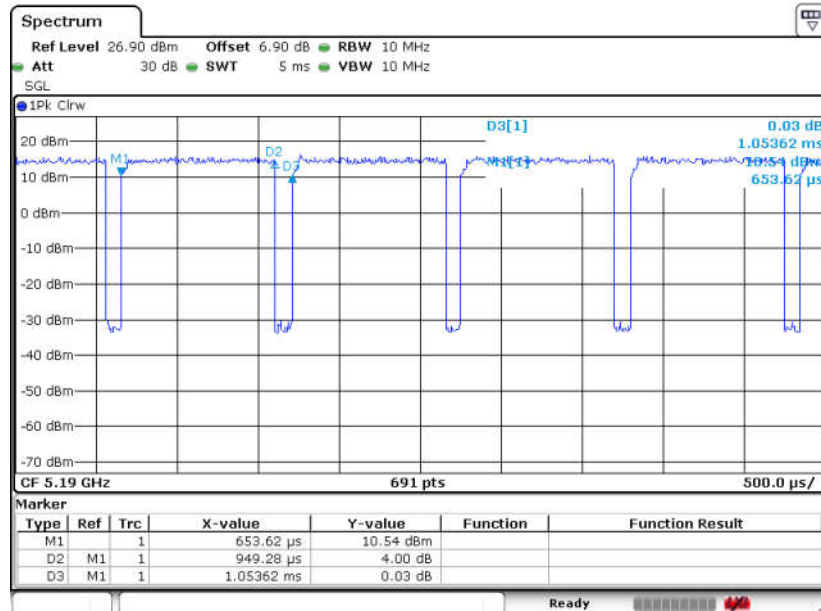



802.11ac VHT80

