



# FCC RF Test Report

**APPLICANT** : Motorola Mobility LLC  
**EQUIPMENT** : Mobile Cellular Phone  
**BRAND NAME** : Motorola  
**MODEL NAME** : XT1926-6, XT1926-7  
**FCC ID** : IHDT56WL4  
**STANDARD** : 47 CFR Part 2, 22(H), 24(E), 27(L), 27(M), 27(H)  
**CLASSIFICATION** : PCS Licensed Transmitter Held to Ear (PCE)

The product was received on Dec. 27, 2017 and completely tested on Jan. 10, 2018. We, Sporton International (Kunshan) Inc., would like to declare that the tested sample has been evaluated in accordance with the test procedures given in ANSI/TIA-603-E and the testing has shown the tested sample to be in compliance with the applicable technical standards. The test results in this report apply exclusively to the tested model / sample. Without written approval of Sporton International (Kunshan) Inc., the test report shall not be reproduced except in full.



Approved by: James Huang / Manager

**Sporton International (Kunshan) Inc.**  
No.3-2 Ping-Xiang Rd, Kunshan Development Zone Kunshan City Jiangsu Province 215335  
China



TABLE OF CONTENTS

REVISION HISTORY..... 3
SUMMARY OF TEST RESULT ..... 4
1 GENERAL DESCRIPTION ..... 6
1.1. Applicant ..... 6
1.2. Manufacturer ..... 6
1.3. Product Feature of Equipment Under Test..... 6
1.4. Product Specification of Equipment Under Test..... 7
1.5. Modification of EUT ..... 7
1.6. Accessory List..... 8
1.7. Maximum ERP/EIRP Power, Frequency Tolerance, and Emission Designator ..... 9
1.8. Testing Location ..... 12
1.9. Applicable Standards..... 12
1.10. Specification of Accessory..... 13
2 TEST CONFIGURATION OF EQUIPMENT UNDER TEST ..... 14
1.11. Test Mode ..... 14
1.12. Connection Diagram of Test System..... 16
1.13. Support Unit used in test configuration and system ..... 17
1.14. Measurement Results Explanation Example..... 17
1.15. Frequency List of Low/Middle/High Channels ..... 18
3 CONDUCTED TEST ITEMS ..... 21
1.16. Measuring Instruments ..... 21
1.17. Test Setup ..... 21
1.18. Test Result of Conducted Test ..... 21
1.19. Conducted Output Power and ERP/EIRP ..... 22
1.20. Peak-to-Average Ratio ..... 23
1.21. Occupied Bandwidth ..... 24
1.22. Conducted Band Edge ..... 25
1.23. Conducted Spurious Emission ..... 27
1.24. Frequency Stability ..... 28
4 RADIATED TEST ITEMS ..... 29
1.25. Measuring Instruments ..... 29
1.26. Test Setup ..... 29
1.27. Test Result of Radiated Test ..... 29
1.28. Radiated Spurious Emission ..... 30
5 LIST OF MEASURING EQUIPMENT ..... 31
6 UNCERTAINTY OF EVALUATION ..... 32
APPENDIX A. TEST RESULTS OF CONDUCTED TEST
APPENDIX B. TEST RESULTS OF RADIATED TEST
APPENDIX C. TEST SETUP PHOTOGRAPHS





**SUMMARY OF TEST RESULT**

Report Section	FCC Rule	Description	Limit	Result	Remark
1.19	§2.1046	Conducted Output Power	Reporting Only	PASS	-
	§22.913(a)(2)	Effective Radiated Power (Band 5)	ERP < 7 Watt	PASS	-
	§27.50(c)(10)	Effective Radiated Power (Band 12) (Band 17)	ERP < 3 Watt	PASS	-
	§24.232(c) §27.50(h)(2)	Equivalent Isotropic Radiated Power (Band 2) (Band 7)	EIRP < 2Watt	PASS	-
	§27.50(d)(4)	Equivalent Isotropic Radiated Power (Band 4)	EIRP < 1Watt	PASS	-
3.5	§24.232(d)	Peak-to-Average Ratio	<13 dB	PASS	-
3.6	§2.1049	Occupied Bandwidth	Reporting Only	PASS	-
3.7	§2.1051 §22.917(a) §24.238(a) §27.53(g) §27.53(h)	Conducted Band Edge Measurement (Band 2) (Band 4) (Band 5) (Band 12) (Band 17)	< 43+10log <sub>10</sub> (P[Watts])	PASS	-
	§27.53(m)(4)	Conducted Band Edge Measurement (Band 7)	§27.53(m)(4)		
3.8	§2.1051 §22.917(a) §24.238(a) §27.53(g) §27.53(h)	Conducted Spurious Emission (Band 2) (Band 4) (Band 5) (Band 12) (Band 17)	< 43+10log <sub>10</sub> (P[Watts])	PASS	-
	§2.1051 §27.53(m)(4)	Conducted Spurious Emission (Band 7)	< 55+10log <sub>10</sub> (P[Watts])		
3.9	§2.1055 §22.355	Frequency Stability Temperature & Voltage	< 2.5 ppm for Part 22H	PASS	-
	§2.1055 §24.235 §27.54		Within Authorized Band		



Report Section	FCC Rule	Description	Limit	Result	Remark
1.28	§2.1053 §22.917(a) §24.238(a) §27.53(g) §27.53(h)	Radiated Spurious Emission (Band 2) (Band 4) (Band 5) (Band 12) (Band 17)	$< 43+10\log_{10}(P[\text{Watts}])$	PASS	Under limit 21.91 dB at 10122.360 MHz
	§2.1053 §27.53(m)(4)	Radiated Spurious Emission (Band 7)	$< 55+10\log_{10}(P[\text{Watts}])$		



# 1 General Description

## 1.1. Applicant

Motorola Mobility LLC  
222 W, Merchandise Mart Plaza, Chicago IL 60654 USA

## 1.2. Manufacturer

Motorola Mobility LLC  
222 W, Merchandise Mart Plaza, Chicago IL 60654 USA

## 1.3. Product Feature of Equipment Under Test

Product Feature	
Equipment	Mobile Cellular Phone
Brand Name	Motorola
Model Name	XT1926-6, XT1926-7
FCC ID	IHDT56WL4
EUT supports Radios application	GSM/GPRS/EGPRS/WCDMA/HSPA/DC-HSDPA/ HSPA+/LTE/NFC WLAN2.4GHz 802.11b/g/n HT20 WLAN5GHz 802.11a/n HT20/HT40 WLAN5GHz 802.11ac VHT20/VHT40/VHT80 Bluetooth v3.0+EDR/ Bluetooth v4.0 LE/ Bluetooth v4.1 LE/ Bluetooth v4.2 LE / Bluetooth v5.0 LE
IMEI Code	Conducted: 351853090015758/351853090015766 Radiation: 351853090016053/351853090016061
HW Version	DVT1B
SW Version	evert_n-userdebug 8.0.0 OPW27.88 1825 intcfg,test-keys
EUT Stage	Identical Prototype

**Remark:**

1. The above EUT's information was declared by manufacturer. Please refer to the specifications or user's manual for more detailed description.
2. There are two types of EUT sample 1 and sample 2, the differences between two samples are only for SIM slot, sample 1(Model name: XT1926-7) is dual SIM slot, sample 2(Model name: XT1926-6) is single SIM slot. We only choose dual SIM sample to perform full tes



### 1.4. Product Specification of Equipment Under Test

Standards-related Product Specification	
<b>Tx Frequency</b>	LTE Band 2 : 1850.7 MHz ~ 1909.3 MHz LTE Band 4 : 1710.7 MHz ~ 1754.3 MHz LTE Band 5 : 824.7 MHz ~ 848.3 MHz LTE Band 7 : 2502.5 MHz ~ 2567.5 MHz LTE Band 12 : 699.7 MHz ~ 715.3 MHz LTE Band 17 : 706.5 MHz ~ 713.5 MHz
<b>Rx Frequency</b>	LTE Band 2 : 1930.7 MHz ~ 1989.3 MHz LTE Band 4 : 2110.7 MHz ~ 2154.3 MHz LTE Band 5 : 869.7 MHz ~ 893.3 MHz LTE Band 7 : 2622.5MHz ~ 2687.5 MHz LTE Band 12 : 729.7 MHz ~ 745.3 MHz LTE Band 17 : 736.5 MHz ~ 743.5 MHz
<b>Bandwidth</b>	LTE Band 2 : 1.4MHz / 3MHz / 5MHz / 10MHz / 15MHz / 20MHz LTE Band 4 : 1.4MHz / 3MHz / 5MHz / 10MHz / 15MHz / 20MHz LTE Band 5 : 1.4MHz / 3MHz / 5MHz / 10MHz LTE Band 7 : 5MHz/ 10MHz / 15MHz / 20MHz LTE Band 12 : 1.4MHz / 3MHz / 5MHz / 10MHz LTE Band 17 : 5MHz / 10MHz
<b>Maximum Output Power to Antenna</b>	LTE Band 2 : 23.27 dBm LTE Band 4 : 23.46 dBm LTE Band 5 : 23.44 dBm LTE Band 7 : 22.45 dBm LTE Band 12 : 23.37 dBm LTE Band 17 : 23.43 dBm
<b>Antenna Gain</b>	LTE Band 2 : -0.6 dBi LTE Band 4 : -1.2 dBi LTE Band 5 : -3.3 dBi LTE Band 7 : -2.1 dBi for Antenna #2, -0.5 dBi for Antenna #3 LTE Band 12 : -3.3 dBi LTE Band 17 : -3.3 dBi
<b>Type of Modulation</b>	QPSK / 16QAM / 64QAM

Note: LTE band 7 Antenna #2, #3 can't transmit simultaneously.

### 1.5. Modification of EUT

No modifications are made to the EUT during all test items.



### 1.6. Accessory List

Specification of Accessory			
AC Adapter 1(US)	Brand Name	Motorola (Salom)	Model Name SC-22
	Power Rating	I/P: 100-240 Vac, 500mA, O/P: 5Vdc,3000mA or 9Vdc,1600mA or 12Vdc,1200mA	
AC Adapter 1(EU)	Brand Name	Motorola (Salom)	Model Name SC-23
	Power Rating	I/P: 100-240 Vac, 500mA, O/P: 5Vdc,3000mA or 9Vdc,1600mA or 12Vdc,1200mA	
AC Adapter 1(UK)	Brand Name	Motorola (Salom)	Model Name SC-24
	Power Rating	I/P: 100-240 Vac, 500mA, O/P: 5Vdc,3000mA or 9Vdc,1600mA or 12Vdc,1200mA	
AC Adapter 1(IN)	Brand Name	Motorola (Salom)	Model Name SC-25
	Power Rating	I/P: 100-240 Vac, 500mA, O/P: 5Vdc,3000mA or 9Vdc,1600mA or 12Vdc,1200mA	
AC Adapter 1(AU)	Brand Name	Motorola (Salom)	Model Name SC-26
	Power Rating	I/P: 100-240 Vac, 500mA, O/P: 5Vdc,3000mA or 9Vdc,1600mA or 12Vdc,1200mA	
AC Adapter 1(AR)	Brand Name	Motorola (Salom)	Model Name SC-27
	Power Rating	I/P: 100-240 Vac, 500mA, O/P: 5Vdc,3000mA or 9Vdc,1600mA or 12Vdc,1200mA	
AC Adapter 2(US)	Brand Name	Motorola (Chenyang)	Model Name SC-22
	Power Rating	I/P: 100-240 Vac, 500mA, O/P: 5Vdc,3000mA or 9Vdc,1600mA or 12Vdc,1200mA	
AC Adapter 2(EU)	Brand Name	Motorola (Chenyang)	Model Name SC-23
	Power Rating	I/P: 100-240 Vac, 500mA, O/P: 5Vdc,3000mA or 9Vdc,1600mA or 12Vdc,1200mA	
AC Adapter 2(UK)	Brand Name	Motorola (Chenyang)	Model Name SC-24
	Power Rating	I/P: 100-240 Vac, 500mA, O/P: 5Vdc,3000mA or 9Vdc,1600mA or 12Vdc,1200mA	
AC Adapter 2(IN)	Brand Name	Motorola (Chenyang)	Model Name SC-25
	Power Rating	I/P: 100-240 Vac, 500mA, O/P: 5Vdc,3000mA or 9Vdc,1600mA or 12Vdc,1200mA	
AC Adapter 2(AU)	Brand Name	Motorola (Chenyang)	Model Name SC-26
	Power Rating	I/P: 100-240 Vac, 500mA, O/P: 5Vdc,3000mA or 9Vdc,1600mA or 12Vdc,1200mA	
AC Adapter 2(AR)	Brand Name	Motorola (chenyang)	Model Name SC-27
	Power Rating	I/P: 100-240 Vac, 500mA, O/P: 5Vdc,3000mA or 9Vdc,1600mA or 12Vdc,1200mA	
Battery	Brand Name	Motorola (ATL)	Model Name JT40
	Power Rating	3.8Vdc,3200mAh	Type Li-ion Polymer
Earphone 1	Brand Name	Motorola (Jiahe)	Model Name LS-118M-12
	Signal Line Type	1.2 meter, non-shielded cable, without ferrite core	
Earphone 2	Brand Name	Motorola (Lianyun)	Model Name TS910A-38AMS01WHR-M
	Signal Line Type	1.2 meter, non-shielded cable, without ferrite core	
USB Cable	Brand Name	Motorola (Liqi)	Model Name L32B-053000100-ALL
	Signal Line Type	1.0 meter, shielded cable, without ferrite core	





### 1.7. Maximum ERP/EIRP Power, Frequency Tolerance, and Emission Designator

LTE Band 2		QPSK			16QAM		
BW (MHz)	Frequency Range (MHz)	Emission Designator (99%OBW)	Frequency Tolerance (ppm)	Maximum EIRP(W)	Emission Designator (99%OBW)	Frequency Tolerance (ppm)	Maximum EIRP(W)
1.4	1850.7 ~ 1909.3	1M10G7D	-	0.1845	1M09W7D	-	0.1618
3	1851.5 ~ 1908.5	2M75G7D	-	0.1811	2M73W7D	-	0.1600
5	1852.5 ~ 1907.5	4M51G7D	-	0.1807	4M52W7D	-	0.1596
10	1855.0 ~ 1905.0	9M11G7D	0.0027	0.1841	9M01W7D	-	0.1603
15	1857.5 ~ 1902.5	13M5G7D	-	0.1841	13M5W7D	-	0.1603
20	1860.0 ~ 1900.0	18M3G7D	-	0.1849	18M4W7D	-	0.1648
LTE Band 2		64QAM					
BW (MHz)	Frequency Range (MHz)	Emission Designator (99%OBW)	Frequency Tolerance (ppm)	Maximum EIRP(W)			
1.4	1850.7 ~ 1909.3	1M09W7D	-	0.1265			
3	1851.5 ~ 1908.5	2M73W7D	-	0.1279			
5	1852.5 ~ 1907.5	4M50W7D	-	0.1265			
10	1855.0 ~ 1905.0	9M07W7D	-	0.1279			
15	1857.5 ~ 1902.5	13M5W7D	-	0.1265			
20	1860.0 ~ 1900.0	18M4W7D	-	0.1259			
LTE Band 4		QPSK			16QAM		
BW (MHz)	Frequency Range (MHz)	Emission Designator (99%OBW)	Frequency Tolerance (ppm)	Maximum EIRP(W)	Emission Designator (99%OBW)	Frequency Tolerance (ppm)	Maximum EIRP(W)
1.4	1710.7 ~ 1754.3	1M09G7D	-	0.1663	1M09W7D	-	0.1452
3	1711.5 ~ 1753.5	2M74G7D	-	0.1663	2M73W7D	-	0.1459
5	1712.5 ~ 1752.5	4M49G7D	-	0.1667	4M50W7D	-	0.1469
10	1715.0 ~ 1750.0	9M01G7D	0.0016	0.1660	9M05W7D	-	0.1459
15	1717.5 ~ 1747.5	13M5G7D	-	0.1671	13M6W7D	-	0.1469
20	1720.0 ~ 1745.0	18M3G7D	-	0.1683	18M5W7D	-	0.1469



LTE Band 4		64QAM							
BW (MHz)	Frequency Range (MHz)	Emission Designator (99%OBW)		Frequency Tolerance (ppm)		Maximum EIRP(W)			
1.4	1710.7 ~ 1754.3	1M09W7D		-		0.1096			
3	1711.5 ~ 1753.5	2M73W7D		-		0.1074			
5	1712.5 ~ 1752.5	4M50W7D		-		0.1096			
10	1715.0 ~ 1750.0	9M03W7D		-		0.1074			
15	1717.5 ~ 1747.5	13M5W7D		-		0.1076			
20	1720.0 ~ 1745.0	18M3W7D		-		0.1102			
LTE Band 5		QPSK			16QAM				
BW (MHz)	Frequency Range (MHz)	Emission Designator (99%OBW)	Frequency Tolerance (ppm)	Maximum ERP(W)	Emission Designator (99%OBW)	Frequency Tolerance (ppm)	Maximum ERP(W)		
1.4	824.7 ~ 848.3	1M09G7D	-	0.0625	1M09W7D	-	0.0541		
3	825.5 ~ 847.5	2M71G7D	-	0.0628	2M73W7D	-	0.0546		
5	826.5 ~ 846.5	4M51G7D	-	0.0625	4M50W7D	-	0.0545		
10	829.0 ~ 844.0	9M05G7D	0.0069	0.0630	9M01W7D	-	0.0547		
LTE Band 5		64QAM							
BW (MHz)	Frequency Range (MHz)	Emission Designator (99%OBW)		Frequency Tolerance (ppm)		Maximum ERP(W)			
1.4	824.7 ~ 848.3	1M09W7D		-		0.0433			
3	825.5 ~ 847.5	2M72W7D		-		0.0443			
5	826.5 ~ 846.5	4M55W7D		-		0.0433			
10	829.0 ~ 844.0	9M05W7D		-		0.0423			
LTE Band 7		QPSK			16QAM				
BW (MHz)	Frequency Range (MHz)	Emission Designator (99%OBW)	Frequency Tolerance (ppm)	Maximum EIRP(W)		Emission Designator (99%OBW)	Frequency Tolerance (ppm)	Maximum EIRP(W)	
				Ant.2	Ant.3			Ant.2	Ant.3
5	2502.5 ~ 2567.5	4M51G7D	-	0.1009	0.1459	4M50W7D	-	0.1081	0.1563
10	2505.0 ~ 2565.0	9M07G7D	0.0030	0.1014	0.1466	9M07W7D	-	0.1079	0.1560
15	2507.5 ~ 2562.5	13M5G7D	-	0.1021	0.1476	13M5W7D	-	0.1081	0.1563
20	2510.0 ~ 2560.0	18M3G7D	-	0.1084	0.1567	18M5W7D	-	0.1079	0.1560



LTE Band 7		64QAM					
BW (MHz)	Frequency Range (MHz)	Emission Designator (99%OBW)	Frequency Tolerance (ppm)	Maximum EIRP(W)			
				Ant.2	Ant.3		
5	2502.5 ~ 2567.5	4M50W7D	-	0.0865	0.1250		
10	2505.0 ~ 2565.0	9M07W7D	-	0.0847	0.1225		
15	2507.5 ~ 2562.5	13M5W7D	-	0.0847	0.1225		
20	2510.0 ~ 2560.0	18M3W7D	-	0.0857	0.1239		
LTE Band 12		QPSK			16QAM		
BW (MHz)	Frequency Range (MHz)	Emission Designator (99%OBW)	Frequency Tolerance (ppm)	Maximum ERP(W)	Emission Designator (99%OBW)	Frequency Tolerance (ppm)	Maximum ERP(W)
1.4	699.7 ~ 715.3	1M09G7D	-	0.0605	1M09W7D	-	0.0537
3	700.5 ~ 714.5	2M73G7D	-	0.0607	2M75W7D	-	0.0535
5	701.5 ~ 713.5	4M49G7D	-	0.0610	4M50W7D	-	0.0537
10	704.0 ~ 711.0	9M09G7D	0.0089	0.0619	9M07W7D	-	0.0542
LTE Band 12		64QAM					
BW (MHz)	Frequency Range (MHz)	Emission Designator (99%OBW)	Frequency Tolerance (ppm)	Maximum ERP(W)			
1.4	699.7 ~ 715.3	1M10W7D	-	0.0449			
3	700.5 ~ 714.5	2M73W7D	-	0.0450			
5	701.5 ~ 713.5	4M52W7D	-	0.0452			
10	704.0 ~ 711.0	9M05W7D	-	0.0450			
LTE Band 17		QPSK			16QAM		
BW (MHz)	Frequency Range (MHz)	Emission Designator (99%OBW)	Frequency Tolerance (ppm)	Maximum ERP(W)	Emission Designator (99%OBW)	Frequency Tolerance (ppm)	Maximum ERP(W)
5	706.5 ~ 713.5	4M50G7D	-	0.0625	4M51W7D	-	0.0561
10	709.0 ~ 711.0	9M05G7D	0.0058	0.0628	9M01W7D	-	0.0556
LTE Band 17		64QAM					
BW (MHz)	Frequency Range (MHz)	Emission Designator (99%OBW)	Frequency Tolerance (ppm)	Maximum ERP(W)			
5	706.5 ~ 713.5	4M51W7D	-	0.0447			
10	709.0 ~ 711.0	9M03W7D	-	0.0443			



### 1.8. Testing Location

Sporton International (Kunshan) Inc. is accredited to ISO 17025 by National Voluntary Laboratory Accreditation Program (NVLAP code: 600155-0) and the FCC designation No. is CN5013.

<b>Test Site</b>	Sporton International (Kunshan) Inc.	
<b>Test Site Location</b>	No.3-2 Ping-Xiang Rd, Kunshan Development Zone Kunshan City Jiangsu Province 215335 China TEL : +86-512-57900158 FAX : +86-512-57900958	
<b>Test Site No.</b>	<b>Sporton Site No.</b>	<b>FCC Test Firm Registration No.</b>
	TH01-KS	630927

Sporton International (Shenzhen) Inc. is accredited to ISO 17025 by National Voluntary Laboratory Accreditation Program (NVLAP code: 600156-0) and the FCC designation No. is CN5019.

<b>Test Site</b>	Sporton International (Shenzhen) Inc.	
<b>Test Site Location</b>	No. 3 Bldg the third floor of south, Shahe River west, Fengzeyuan Warehouse, Nanshan District Shenzhen City Guangdong Province 518055 China TEL: +86-755-3320-2398	
<b>Test Site No.</b>	<b>Sporton Site No.</b>	<b>FCC Test Firm Registration No.</b>
	03CH04-SZ	577730

**Note:** The test site complies with ANSI C63.4 2014 requirement.

### 1.9. Applicable Standards

According to the specifications of the manufacturer, the EUT must comply with the requirements of the following standards:

- ♦ 47 CFR Part 2, 22(H), 24(E), 27(L), 27(M), 27(H)
- ♦ ANSI/TIA-603-E
- ♦ FCC KDB 971168 D01 Power Meas License Digital Systems v03
- ♦ FCC KDB 412172 D01 Determining ERP and EIRP v01r01

**Remark:**

1. All test items were verified and recorded according to the standards and without any deviation during the test.
2. This EUT has also been tested and complied with the requirements of FCC Part 15, Subpart B, recorded in a separate test report.



### 1.10. Specification of Accessory

Specification of Accessory			
AC Adapter 1(US)	Brand Name	Motorola (Salom)	Model Name SC-22
	Power Rating	I/P: 100-240 Vac, 500mA, O/P: 5Vdc,3000mA or 9Vdc,1600mA or 12Vdc,1200mA	
AC Adapter 1(EU)	Brand Name	Motorola (Salom)	Model Name SC-23
	Power Rating	I/P: 100-240 Vac, 500mA, O/P: 5Vdc,3000mA or 9Vdc,1600mA or 12Vdc,1200mA	
AC Adapter 1(UK)	Brand Name	Motorola (Salom)	Model Name SC-24
	Power Rating	I/P: 100-240 Vac, 500mA, O/P: 5Vdc,3000mA or 9Vdc,1600mA or 12Vdc,1200mA	
AC Adapter 1(IN)	Brand Name	Motorola (Salom)	Model Name SC-25
	Power Rating	I/P: 100-240 Vac, 500mA, O/P: 5Vdc,3000mA or 9Vdc,1600mA or 12Vdc,1200mA	
AC Adapter 1(AU)	Brand Name	Motorola (Salom)	Model Name SC-26
	Power Rating	I/P: 100-240 Vac, 500mA, O/P: 5Vdc,3000mA or 9Vdc,1600mA or 12Vdc,1200mA	
AC Adapter 1 (PRC)	Brand Name	Motorola (Salom)	Model Name SC-21
	Power Rating	I/P: 100-240 Vac, 500mA, O/P: 5Vdc,3000mA or 9Vdc,1600mA or 12Vdc,1200mA	
AC Adapter 2(US)	Brand Name	Motorola (Chenyang)	Model Name SC-22
	Power Rating	I/P: 100-240 Vac, 500mA, O/P: 5Vdc,3000mA or 9Vdc,1600mA or 12Vdc,1200mA	
AC Adapter 2(EU)	Brand Name	Motorola (Chenyang)	Model Name SC-23
	Power Rating	I/P: 100-240 Vac, 500mA, O/P: 5Vdc,3000mA or 9Vdc,1600mA or 12Vdc,1200mA	
AC Adapter 2(UK)	Brand Name	Motorola (Chenyang)	Model Name SC-24
	Power Rating	I/P: 100-240 Vac, 500mA, O/P: 5Vdc,3000mA or 9Vdc,1600mA or 12Vdc,1200mA	
AC Adapter 2(IN)	Brand Name	Motorola (Chenyang)	Model Name SC-25
	Power Rating	I/P: 100-240 Vac, 500mA, O/P: 5Vdc,3000mA or 9Vdc,1600mA or 12Vdc,1200mA	
AC Adapter 2(AU)	Brand Name	Motorola (Chenyang)	Model Name SC-26
	Power Rating	I/P: 100-240 Vac, 500mA, O/P: 5Vdc,3000mA or 9Vdc,1600mA or 12Vdc,1200mA	
Battery	Brand Name	Motorola (ATL)	Model Name HG30
	Power Rating	3.8Vdc,3000mAh	Type Li-ion
Earphone 1	Brand Name	Motorola (Jiahe)	Model Name LS-118M-12
	Signal Line Type	1.2 meter, non-shielded cable, without ferrite core	
Earphone 2	Brand Name	Motorola (Lianyun)	Model Name TS910A-38AMS01WHR-M
	Signal Line Type	1.2 meter, non-shielded cable, without ferrite core	
USB Cable	Brand Name	Motorola (Liqi)	Model Name L32B-053000100-ALL
	Signal Line Type	1.0 meter, shielded cable, without ferrite core	



## 2 Test Configuration of Equipment Under Test

### 1.11. Test Mode

Antenna port conducted and radiated test items listed below are performed according to KDB 971168 D01 Power Meas License Digital Systems v03 with maximum output power.

Radiated measurements are performed by rotating the EUT in three different orthogonal test planes to find the maximum emission.

Test Items	Band	Bandwidth (MHz)						Modulation			RB #			Test Channel		
		1.4	3	5	10	15	20	QPSK	16QAM	64QAM	1	Half	Full	L	M	H
Max. Output Power	2	✓	✓	✓	✓	✓	✓	✓	✓	✓	✓	✓	✓	✓	✓	✓
	4	✓	✓	✓	✓	✓	✓	✓	✓	✓	✓	✓	✓	✓	✓	✓
	5	✓	✓	✓	✓	-	-	✓	✓	✓	✓	✓	✓	✓	✓	✓
	7	-	-	✓	✓	✓	✓	✓	✓	✓	✓	✓	✓	✓	✓	✓
	12	✓	✓	✓	✓	-	-	✓	✓	✓	✓	✓	✓	✓	✓	✓
	17	-	-	✓	✓	-	-	✓	✓	✓	✓	✓	✓	✓	✓	✓
Peak-to-Average Ratio	2						✓	✓	✓	✓	✓		✓	✓	✓	✓
	4						✓	✓	✓	✓	✓		✓	✓	✓	✓
	5				✓	-	-	✓	✓	✓	✓		✓	✓	✓	✓
	7	-	-				✓	✓	✓	✓	✓		✓	✓	✓	✓
	12				✓	-	-	✓	✓	✓	✓		✓	✓	✓	✓
	17	-	-		✓	-	-	✓	✓	✓	✓		✓	✓	✓	✓
26dB and 99% Bandwidth	2	✓	✓	✓	✓	✓	✓	✓	✓	✓			✓	✓	✓	✓
	4	✓	✓	✓	✓	✓	✓	✓	✓	✓			✓	✓	✓	✓
	5	✓	✓	✓	✓	-	-	✓	✓	✓			✓	✓	✓	✓
	7	-	-	✓	✓	✓	✓	✓	✓	✓			✓	✓	✓	✓
	12	✓	✓	✓	✓	-	-	✓	✓	✓			✓	✓	✓	✓
	17	-	-	✓	✓	-	-	✓	✓	✓			✓	✓	✓	✓
Conducted Band Edge	2	✓	✓	✓	✓	✓	✓	✓	✓	✓	✓		✓	✓		✓
	4	✓	✓	✓	✓	✓	✓	✓	✓	✓	✓		✓	✓		✓
	5	✓	✓	✓	✓	-	-	✓	✓	✓	✓		✓	✓		✓
	7	-	-	✓	✓	✓	✓	✓	✓	✓	✓		✓	✓		✓
	12	✓	✓	✓	✓	-	-	✓	✓	✓	✓		✓	✓		✓
	17	-	-	✓	✓	-	-	✓	✓	✓	✓		✓	✓		✓



Test Items	Band	Bandwidth (MHz)						Modulation			RB #			Test Channel		
		1.4	3	5	10	15	20	QPSK	16QAM	64QAM	1	Half	Full	L	M	H
Conducted Spurious Emission	2	√	√	√	√	√	√	√	√	√	√			√	√	√
	4	√	√	√	√	√	√	√	√	√	√			√	√	√
	5	√	√	√	√	-	-	√	√	√	√			√	√	√
	7	-	-	√	√	√	√	√	√	√	√			√	√	√
	12	√	√	√	√	-	-	√	√	√	√			√	√	√
	17	-	-	√	√	-	-	√	√	√	√			√	√	√
Frequency Stability	2				√			√					√		√	
	4				√			√					√		√	
	5				√	-	-	√					√		√	
	7	-	-		√			√					√		√	
	12				√	-	-	√					√		√	
	17	-	-		√	-	-	√					√		√	
E.R.P./ E.I.R.P.	2	√	√	√	√	√	√	√	√	√	√			√	√	√
	4	√	√	√	√	√	√	√	√	√	√			√	√	√
	5	√	√	√	√	-	-	√	√	√	√			√	√	√
	7	-	-	√	√	√	√	√	√	√	√			√	√	√
	12	√	√	√	√	-	-	√	√	√	√			√	√	√
	17	-	-	√	√	-	-	√	√	√	√			√	√	√
Radiated Spurious Emission	2	√	√	√	√	√	√	√				√			√	
	4	√	√	√	√	√	√	√				√			√	
	5	√	√	√	√	-	-	√				√			√	
	7	-	-	√	√	√	√	√				√			√	
	12	√	√	√	√	-	-	√				√			√	
	17	-	-	√	√	-	-	√				√			√	
Note	<p>1. The mark "√" means that this configuration is chosen for testing</p> <p>2. The mark "-" means that this bandwidth is not supported.</p> <p>3. The device is investigated from 30MHz to 10 times of fundamental signal for radiated spurious emission test under different RB size/offset and modulations in exploratory test. Subsequently, only the worst case emissions are reported.</p>															

## 1.12. Connection Diagram of Test System

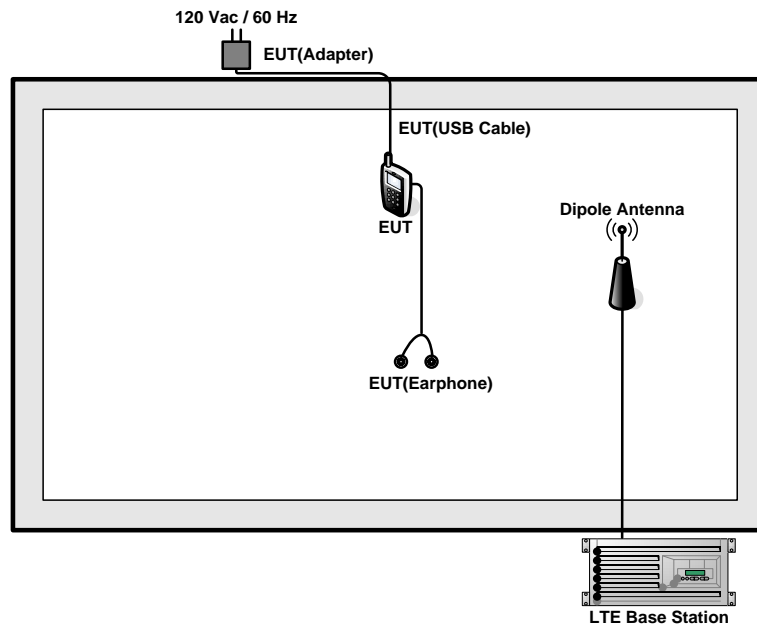





### 1.13. Support Unit used in test configuration and system

Item	Equipment	Trade Name	Model No.	FCC ID	Data Cable	Power Cord
1.	LTE Base Station	Anritsu	MT8820C	N/A	N/A	Unshielded, 1.8 m
2.	DC Power Supply	GW INSTEK	GPS-3030D	N/A	N/A	Unshielded, 1.8 m

### 1.14. Measurement Results Explanation Example

For all conducted test items:

The offset level is set in the spectrum analyzer to compensate the RF cable loss between EUT conducted output port and spectrum analyzer. With the offset compensation, the spectrum analyzer reading level is exactly the EUT RF output level.

The spectrum analyzer offset is derived from RF cable loss.

*Offset = RF cable loss.*

Following shows an offset computation example with cable loss 4.9 dB.

Example :

$$\begin{aligned} \text{Offset}(dB) &= \text{RF cable loss}(dB). \\ &= 4.9 \text{ (dB)} \end{aligned}$$



### 1.15. Frequency List of Low/Middle/High Channels

LTE Band 2 Channel and Frequency List				
BW [MHz]	Channel/Frequency(MHz)	Lowest	Middle	Highest
20	Channel	18700	18900	19100
	Frequency	1860	1880	1900
15	Channel	18675	18900	19125
	Frequency	1857.5	1880	1902.5
10	Channel	18650	18900	19150
	Frequency	1855	1880	1905
5	Channel	18625	18900	19175
	Frequency	1852.5	1880	1907.5
3	Channel	18615	18900	19185
	Frequency	1851.5	1880	1908.5
1.4	Channel	18607	18900	19193
	Frequency	1850.7	1880	1909.3

LTE Band 4 Channel and Frequency List				
BW [MHz]	Channel/Frequency(MHz)	Lowest	Middle	Highest
20	Channel	20050	20175	20300
	Frequency	1720	1732.5	1745
15	Channel	20025	20175	20325
	Frequency	1717.5	1732.5	1747.5
10	Channel	20000	20175	20350
	Frequency	1715	1732.5	1750
5	Channel	19975	20175	20375
	Frequency	1712.5	1732.5	1752.5
3	Channel	19965	20175	20385
	Frequency	1711.5	1732.5	1753.5
1.4	Channel	19957	20175	20393
	Frequency	1710.7	1732.5	1754.3



LTE Band 5 Channel and Frequency List				
BW [MHz]	Channel/Frequency(MHz)	Lowest	Middle	Highest
10	Channel	20450	20525	20600
	Frequency	829	836.5	844
5	Channel	20425	20525	20625
	Frequency	826.5	836.5	846.5
3	Channel	20415	20525	20635
	Frequency	825.5	836.5	847.5
1.4	Channel	20407	20525	20643
	Frequency	824.7	836.5	848.3

LTE Band 7 Channel and Frequency List				
BW [MHz]	Channel/Frequency(MHz)	Lowest	Middle	Highest
20	Channel	20850	21100	21350
	Frequency	2510	2535	2560
15	Channel	20825	21100	21375
	Frequency	2507.5	2535	2562.5
10	Channel	20800	21100	21400
	Frequency	2505	2535	2565
5	Channel	20775	21100	21425
	Frequency	2502.5	2535	2567.5



LTE Band 12 Channel and Frequency List				
BW [MHz]	Channel/Frequency(MHz)	Lowest	Middle	Highest
10	Channel	23060	23095	23130
	Frequency	704	707.5	711
5	Channel	23035	23095	23155
	Frequency	701.5	707.5	713.5
3	Channel	23025	23095	23165
	Frequency	700.5	707.5	714.5
1.4	Channel	23017	23095	23173
	Frequency	699.7	707.5	715.3

LTE Band 17 Channel and Frequency List				
BW [MHz]	Channel/Frequency(MHz)	Lowest	Middle	Highest
10	Channel	23780	23790	23800
	Frequency	709	710	711
5	Channel	23755	23790	23825
	Frequency	706.5	710	713.5

### 3 Conducted Test Items

#### 1.16. Measuring Instruments

See list of measuring instruments of this test report.

#### 1.17. Test Setup

##### 3.1.1 Conducted Output Power



##### 3.1.2 Peak-to-Average Ratio, Occupied Bandwidth ,Conducted Band-Edge and Conducted Spurious Emission

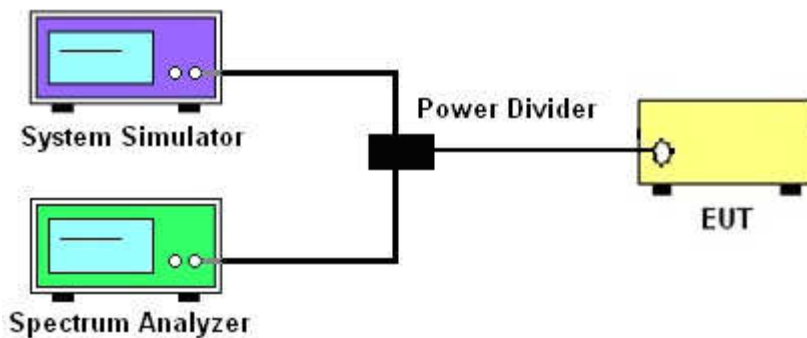

##### 3.1.3 Frequency Stability

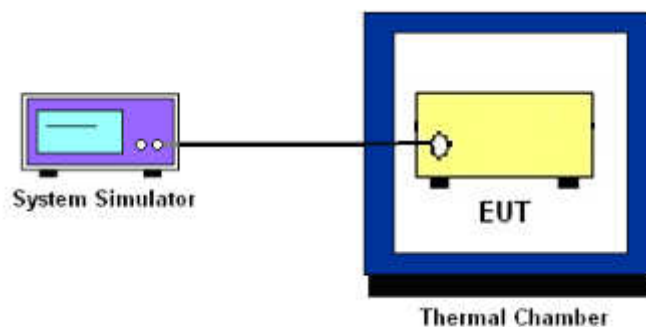

#### 1.18. Test Result of Conducted Test

Please refer to Appendix A.



## 1.19. Conducted Output Power and ERP/EIRP

### 3.1.4 Description of the Conducted Output Power Measurement and ERP/EIRP Measurement

A system simulator was used to establish communication with the EUT. Its parameters were set to force the EUT transmitting at maximum output power. The measured power in the radio frequency on the transmitter output terminals shall be reported.

The ERP of mobile transmitters must not exceed 7 Watts for LTE Band 5.

The ERP of mobile transmitters must not exceed 3 Watts for LTE Band 12, and Band 17.

The EIRP of mobile transmitters must not exceed 2 Watts for LTE Band 2 and Band 7.

The EIRP of mobile transmitters must not exceed 1 Watts for LTE Band 4.

According to KDB 412172 D01 Power Approach,

$EIRP = P_T + G_T - L_C$ ,  $ERP = EIRP - 2.15$ , where

$P_T$  = transmitter output power in dBm

$G_T$  = gain of the transmitting antenna in dBi

$L_C$  = signal attenuation in the connecting cable between the transmitter and antenna in dB

### 3.1.5 Test Procedures

1. The transmitter output port was connected to the system simulator.
2. Set EUT at maximum power through the system simulator.
3. Select lowest, middle, and highest channels for each band and different modulation.
4. Measure and record the power level from the system simulator.



## **1.20. Peak-to-Average Ratio**

### **3.1.6 Description of the PAR Measurement**

Power Complementary Cumulative Distribution Function (CCDF) curves provide a means for characterizing the power peaks of a digitally modulated signal on a statistical basis. A CCDF curve depicts the probability of the peak signal amplitude exceeding the average power level. Most contemporary measurement instrumentation include the capability to produce CCDF curves for an input signal provided that the instrument's resolution bandwidth can be set wide enough to accommodate the entire input signal bandwidth. In measuring transmissions in this band using an average power technique, the peak-to-average ratio (PAR) of the transmission may not exceed 13 dB.

### **3.1.7 Test Procedures**

1. The testing follows FCC KDB 971168 v03 Section 5.7.1.
2. The EUT was connected to spectrum and system simulator via a power divider.
3. Set the CCDF (Complementary Cumulative Distribution Function) option in spectrum analyzer.
4. The highest RF powers were measured and recorded the maximum PAPR level associated with a probability of 0.1 %.
5. Record the deviation as Peak to Average Ratio.



## 1.21. Occupied Bandwidth

### 3.1.8 Description of Occupied Bandwidth Measurement

The occupied bandwidth is the width of a frequency band such that, below the lower and above the upper frequency limits, the mean powers emitted are each equal to a specified percentage 0.5% of the total mean transmitted power.

The 26 dB emission bandwidth is defined as the frequency range between two points, one above and one below the carrier frequency, at which the spectral density of the emission is attenuated 26 dB below the maximum in-band spectral density of the modulated signal. Spectral density (power per unit bandwidth) is to be measured with a detector of resolution bandwidth equal to approximately 1.0% of the emission bandwidth.

### 3.1.9 Test Procedures

1. The testing follows FCC KDB 971168 v03 Section 4.1 and 4.2.
2. The EUT was connected to spectrum analyzer and system simulator via a power divider.
3. The spectrum analyzer center frequency is set to the nominal EUT channel center frequency. The span range for the spectrum analyzer shall be between two and five times the anticipated OBW.
4. The nominal resolution bandwidth (RBW) shall be in the range of 1 to 5 % of the anticipated OBW, and the VBW shall be at least 3 times the RBW.
5. Set the detection mode to peak, and the trace mode to max hold.
6. Determine the reference value: Set the EUT to transmit a modulated signal. Allow the trace to stabilize. Set the spectrum analyzer marker to the highest level of the displayed trace.  
(this is the reference value)
7. Determine the “-26 dB down amplitude” as equal to (Reference Value – X).
8. Place two markers, one at the lowest and the other at the highest frequency of the envelope of the spectral display such that each marker is at or slightly below the “-X dB down amplitude” determined in step 6. If a marker is below this “-X dB down amplitude” value it shall be placed as close as possible to this value. The OBW is the positive frequency difference between the two markers.
9. Use the 99 % power bandwidth function of the spectrum analyzer and report the measured bandwidth.





## 1.22. Conducted Band Edge

### 3.1.10 Description of Conducted Band Edge Measurement

#### 22.917(a)

For operations in the 824 – 849 MHz band, the FCC limit is  $43 + 10\log_{10}(P[\text{Watts}])$  dB below the transmitter power  $P(\text{Watts})$  in a 100kHz bandwidth. However, in the 1MHz bands immediately outside and adjacent to the licensee's frequency block, a resolution bandwidth of at least one percent of the emission bandwidth of the fundamental emission of the transmitter may be employed.

#### 24.238 (a)

For operations in the 1850-1910 and 1930-1990 MHz band, the FCC limit is  $43 + 10\log_{10}(P[\text{Watts}])$  dB below the transmitter power  $P(\text{Watts})$  in a 1MHz bandwidth. However, in the 1 MHz bands immediately outside and adjacent to the frequency block a resolution bandwidth of at least one percent of the emission bandwidth of the fundamental emission of the transmitter may be employed.

#### 27.53 (g)

For operations in the 698 -746 MHz band, the FCC limit is  $43 + 10\log_{10}(P[\text{Watts}])$  dB below the transmitter power  $P(\text{Watts})$  in a 100 kHz bandwidth. However, in the 100 kilohertz bands immediately outside and adjacent to a licensee's frequency block, a resolution bandwidth of at least 30 kHz may be employed.

#### 27.53 (h)

For operations in the 1710 – 1755 MHz band, the FCC limit is  $43 + 10\log_{10}(P[\text{Watts}])$  dB below the transmitter power  $P(\text{Watts})$  in a 1 MHz bandwidth. However, in the 1MHz bands immediately outside and adjacent to the licensee's frequency block, a resolution bandwidth of at least one percent of the emission bandwidth of the fundamental emission of the transmitter may be employed.



27.53(m)(4)

For mobile digital stations, the attenuation factor shall be not less than  $40 + 10 \log (P)$  dB on all frequencies between the channel edge and 5 megahertz from the channel edge,  $43 + 10 \log (P)$  dB on all frequencies between 5 megahertz and X megahertz from the channel edge, and  $55 + 10 \log (P)$  dB on all frequencies more than X megahertz from the channel edge, where X is the greater of 6 megahertz or the actual emission bandwidth as defined in paragraph (m)(6) of this section. In addition, the attenuation factor shall not be less that  $43 + 10 \log (P)$  dB on all frequencies between 2490.5 MHz and 2496 MHz and  $55 + 10 \log (P)$  dB at or below 2490.5 MHz. Mobile Satellite Service licensees operating on frequencies below 2495 MHz may also submit a documented interference complaint against BRS licensees operating on channel BRS Channel 1 on the same terms and conditions as adjacent channel BRS or EBS licensees.

**3.1.11 Test Procedures**

1. The testing follows FCC KDB 971168 v03 Section 6.0.
2. The EUT was connected to spectrum analyzer and system simulator via a power divider.
3. The band edges of low and high channels for the highest RF powers were measured.
4. Set RBW  $\geq$  1% EBW in the 1MHz band immediately outside and adjacent to the band edge.
5. Beyond the 1 MHz band from the band edge, RBW=1MHz was used.
6. Set spectrum analyzer with RMS detector.
7. The RF fundamental frequency should be excluded against the limit line in the operating frequency band.
8. Checked that all the results comply with the emission limit line.

Example:

$$\begin{aligned} &\text{The limit line is derived from } 43 + 10\log(P)\text{dB below the transmitter power } P(\text{Watts}) \\ &= P(\text{W}) - [43 + 10\log(P)] \text{ (dB)} \\ &= [30 + 10\log(P)] \text{ (dBm)} - [43 + 10\log(P)] \text{ (dB)} = -13\text{dBm}. \end{aligned}$$

9. For LTE Band 7, the other 40 dB, and 55 dB have additionally applied same calculation above.



## 1.23. Conducted Spurious Emission

### 3.1.12 Description of Conducted Spurious Emission Measurement

The power of any emission outside of the authorized operating frequency ranges must be lower than the transmitter power (P) by a factor of at least  $43 + 10 \log (P)$  dB.

For Band 7:

The power of any emission outside of the authorized operating frequency ranges must be lower than the transmitter power (P) by a factor of at least  $55 + 10 \log (P)$  dB.

It is measured by means of a calibrated spectrum analyzer and scanned from 30 MHz up to a frequency including its 10<sup>th</sup> harmonic.

### 3.1.13 Test Procedures

1. The testing follows FCC KDB 971168 v03 Section 6.0.
2. The EUT was connected to spectrum analyzer and system simulator via a power divider.
3. The RF output of EUT was connected to the spectrum analyzer by RF cable and attenuator. The path loss was compensated to the results for each measurement.
4. The middle channel for the highest RF power within the transmitting frequency was measured.
5. The conducted spurious emission for the whole frequency range was taken.
6. Make the measurement with the spectrum analyzer's RBW = 1MHz, VBW = 3MHz.
7. Set spectrum analyzer with RMS detector.
8. Taking the record of maximum spurious emission.
9. The RF fundamental frequency should be excluded against the limit line in the operating frequency band.
10. The limit line is derived from  $43 + 10\log(P)$ dB below the transmitter power P(Watts)  
 $= P(W) - [43 + 10\log(P)]$  (dB)  
 $= [30 + 10\log(P)]$  (dBm) -  $[43 + 10\log(P)]$  (dB)  
 $= -13$ dBm.
11. For Band 7  
The limit line is derived from  $55 + 10\log(P)$ dB below the transmitter power P(Watts)  
 $= P(W) - [55 + 10\log(P)]$  (dB)  
 $= [30 + 10\log(P)]$  (dBm) -  $[55 + 10\log(P)]$  (dB)  
 $= -25$ dBm.



## 1.24. Frequency Stability

### 3.1.14 Description of Frequency Stability Measurement

The frequency stability shall be measured by variation of ambient temperature and variation of primary supply voltage to ensure that the fundamental emission stays within the authorized frequency block. The frequency stability of the transmitter shall be maintained within  $\pm 0.00025\%$  ( $\pm 2.5\text{ppm}$ ) of the center frequency.

### 3.1.15 Test Procedures for Temperature Variation

1. The testing follows FCC KDB 971168 v03 Section 9.0.
2. The EUT was set up in the thermal chamber and connected with the system simulator.
3. With power OFF, the temperature was decreased to  $-30^{\circ}\text{C}$  and the EUT was stabilized before testing. Power was applied and the maximum change in frequency was recorded within one minute.
4. With power OFF, the temperature was raised in  $10^{\circ}\text{C}$  step up to  $50^{\circ}\text{C}$ . The EUT was stabilized at each step for at least half an hour. Power was applied and the maximum frequency change was recorded within one minute.

### 3.1.16 Test Procedures for Voltage Variation

1. The testing follows FCC KDB 971168 v03 Section 9.0.
2. The EUT was placed in a temperature chamber at  $20\pm 5^{\circ}\text{C}$  and connected with the system simulator.
3. The power supply voltage to the EUT was varied from 85% to 115% of the nominal value measured at the input to the EUT.
4. The variation in frequency was measured for the worst case.

## 4 Radiated Test Items

### 1.25. Measuring Instruments

See list of measuring instruments of this test report.

### 1.26. Test Setup

#### 4.1.1 For radiated test from 30MHz to 1GHz

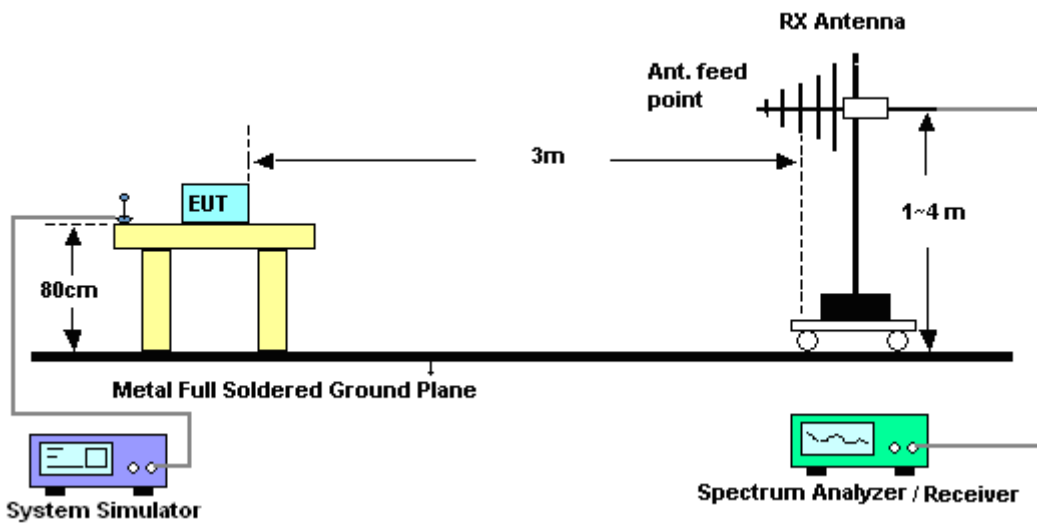

#### 4.1.2 For radiated test above 1GHz

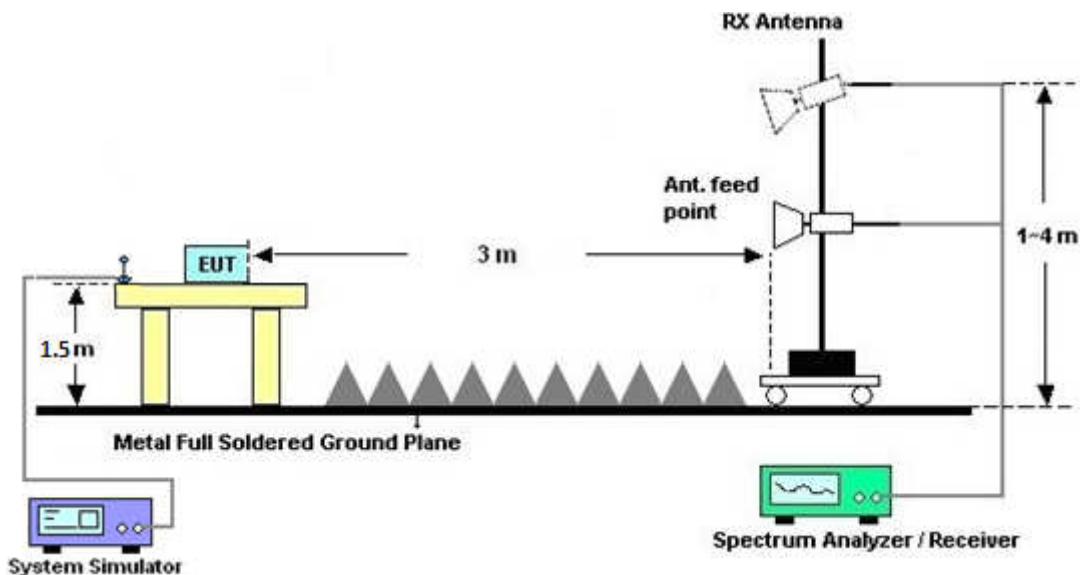

### 1.27. Test Result of Radiated Test

Please refer to Appendix B.



## 1.28. Radiated Spurious Emission

### 4.1.3 Description of Radiated Spurious Emission

The radiated spurious emission was measured by substitution method according to ANSI/TIA-603-E. The power of any emission outside of the authorized operating frequency ranges must be attenuated below the transmitter power (P) by a factor of at least  $43 + 10 \log (P)$  dB.

For Band 7

The power of any emission outside of the authorized operating frequency ranges must be attenuated below the transmitter power (P) by a factor of at least  $55 + 10 \log (P)$  dB.

### 4.1.4 Test Procedures

1. The testing follows FCC KDB 971168 v03 Section 5.8 and ANSI/TIA-603-E Section 2.2.12.
2. The EUT was placed on a turntable with 0.8 meter height for frequency below 1GHz and 1.5 meter height for frequency above 1GHz respectively above ground.
3. The EUT was set 3 meters from the receiving antenna mounted on the antenna tower.
4. The table was rotated 360 degrees to determine the position of the highest spurious emission.
5. The height of the receiving antenna is varied between 1m to 4m to search the maximum spurious emission for both horizontal and vertical polarizations.
6. During the measurement, the system simulator parameters were set to force the EUT transmitting at maximum output power.
7. Make the measurement with the spectrum analyzer's RBW = 1MHz, VBW = 3MHz, taking the record of maximum spurious emission.
8. A horn antenna was substituted in place of the EUT and was driven by a signal generator.
9. Tune the output power of signal generator to the same emission level with EUT maximum spurious emission.
10.  $EIRP \text{ (dBm)} = S.G. \text{ Power} - Tx \text{ Cable Loss} + Tx \text{ Antenna Gain}$
11.  $ERP \text{ (dBm)} = EIRP - 2.15$
12. The RF fundamental frequency should be excluded against the limit line in the operating frequency band.

The limit line is derived from  $43 + 10\log(P)$ dB below the transmitter power P(Watts)  
 $= P(W) - [43 + 10\log(P)] \text{ (dB)}$   
 $= [30 + 10\log(P)] \text{ (dBm)} - [43 + 10\log(P)] \text{ (dB)}$   
 $= -13\text{dBm}.$

13. For Band 7:

The limit line is derived from  $55 + 10\log(P)$ dB below the transmitter power P(Watts)  
 $EIRP \text{ (dBm)} = S.G. \text{ Power} - Tx \text{ Cable Loss} + Tx \text{ Antenna Gain}$   
 $ERP \text{ (dBm)} = EIRP - 2.15$



## 5 List of Measuring Equipment

Instrument	Manufacturer	Model No.	Serial No.	Characteristics	Calibration Date	Test Date	Due Date	Remark
Spectrum Analyzer	R&S	FSV40	101040	10Hz~40GHz	Aug. 08, 2017	Dec. 31, 2017~ Jan. 06, 2018	Aug. 07, 2018	Conducted (TH01-KS)
Radio communication analyzer	Anritsu	MT8820C	6201300652	2G/3G/LTE_ full band	Aug. 08, 2017	Dec. 31, 2017~ Jan. 06, 2018	Aug. 07, 2018	Conducted (TH01-KS)
Thermal Chamber	Hongzhan	LP-150U	HZ014011440	-40~+150°C 20%~95%RH	Apr. 18, 2017	Dec. 31, 2017~ Jan. 06, 2018	Apr. 17, 2018	Conducted (TH01-KS)
EXA Spectrum Analyzer	KEYSIGHT	N9010A	MY55150213	10Hz~44GHz	Apr. 20, 2017	Jan. 08, 2018~ Jan. 10, 2018	Apr. 19, 2018	Radiation (03CH04-SZ)
Bilog Antenna	TeseQ	CBL6111D	41909	30MHz~1GHz	May 16, 2017	Jan. 08, 2018~ Jan. 10, 2018	May 15, 2018	Radiation (03CH04-SZ)
Double Ridge Horn Antenna	SCHWARZBECK	BBHA9120D	9120D-1285	1GHz~18GHz	Dec. 13, 2017	Jan. 08, 2018~ Jan. 10, 2018	Dec. 12, 2018	Radiation (03CH04-SZ)
Horn Antenna	SCHWARZBECK	BBHA9170	9170#679	15GHz~40GHz	May 17, 2017	Jan. 08, 2018~ Jan. 10, 2018	May 16, 2018	Radiation (03CH04-SZ)
Amplifier	Burgeon	BPA-530	102211	0.01Hz ~3000MHz	Oct. 19, 2017	Jan. 08, 2018~ Jan. 10, 2018	Oct. 18, 2018	Radiation (03CH04-SZ)
HF Amplifier	MITEQ	AMF-7D-00 101800-30-1	1989346	1GHz~18GHz	Jul. 27, 2017	Jan. 08, 2018~ Jan. 10, 2018	Jul. 26, 2018	Radiation (03CH04-SZ)
HF Amplifier	MITEQ	TTA1840-35 -HG	1988315	18GHz~40GHz	Jul. 27, 2017	Jan. 08, 2018~ Jan. 10, 2018	Jul. 26, 2018	Radiation (03CH04-SZ)
Amplifier	Agilent Technologies	83017A	MY53270156	500MHz~26.5GHz	Apr. 20, 2017	Jan. 08, 2018~ Jan. 10, 2018	Apr. 19, 2018	Radiation (03CH04-SZ)
AC Power Source	Chroma	61601	N/A	N/A	NCR	Jan. 08, 2018~ Jan. 10, 2018	NCR	Radiation (03CH04-SZ)
Turn Table	EM	EM1000	N/A	0~360 degree	NCR	Jan. 08, 2018~ Jan. 10, 2018	NCR	Radiation (03CH04-SZ)
Antenna Mast	EM	EM1000	N/A	1 m~4 m	NCR	Jan. 08, 2018~ Jan. 10, 2018	NCR	Radiation (03CH04-SZ)

NCR: No Calibration Required



## 6 Uncertainty of Evaluation

### Uncertainty of Radiated Emission Measurement (30 MHz ~ 1000 MHz)

Measuring Uncertainty for a Level of Confidence of 95% ( $U = 2Uc(y)$ )	2.8 dB
---	--------

### Uncertainty of Radiated Emission Measurement (1 GHz ~ 18 GHz)

Measuring Uncertainty for a Level of Confidence of 95% ( $U = 2Uc(y)$ )	3.1 dB
---	--------

### Uncertainty of Radiated Emission Measurement (18 GHz ~ 40 GHz)

Measuring Uncertainty for a Level of Confidence of 95% ( $U = 2Uc(y)$ )	3.9 dB
---	--------





## Appendix A. Test Results of Conducted Test

### Conducted Output Power(Average power)

LTE Band 2 Maximum Average Power [dBm]						
BW [MHz]	RB Size	RB Offset	Mod	Lowest	Middle	Highest
20	1	0	QPSK	23.24	23.27	23.18
20	1	49		23.19	23.24	23.20
20	1	99		23.22	23.19	23.11
20	50	0		22.19	22.23	22.17
20	50	24		22.19	22.26	22.25
20	50	50		22.23	22.18	22.24
20	100	0		22.28	22.20	22.13
20	1	0	16-QAM	22.73	22.69	22.77
20	1	49		22.63	22.66	22.58
20	1	99		22.57	22.62	22.60
20	50	0		21.38	21.34	21.26
20	50	24		21.35	21.37	21.38
20	50	50		21.37	21.32	21.32
20	100	0		21.42	21.35	21.24
20	1	0	64QAM	21.30	21.45	21.34
20	1	49		21.42	21.55	21.46
20	1	99		21.54	21.59	21.60
20	50	0		20.31	20.34	20.32
20	50	24		20.33	20.38	20.28
20	50	50		20.31	20.35	20.21
20	100	0		20.35	20.40	20.30
15	1	0	QPSK	23.14	23.20	23.16
15	1	37		23.08	23.21	23.06
15	1	74		23.03	23.25	23.08
15	36	0		22.12	22.24	22.11
15	36	20		22.15	22.28	22.13
15	36	39		22.09	22.22	22.11
15	75	0		22.09	22.22	22.13



15	1	0	16-QAM	22.63	22.58	22.61
15	1	37		22.48	22.65	22.42
15	1	74		22.40	22.64	22.51
15	36	0		21.32	21.38	21.26
15	36	20		21.31	21.42	21.24
15	36	39		21.25	21.37	21.24
15	75	0		21.26	21.41	21.24
15	1	0	64QAM	21.33	21.50	21.28
15	1	37		21.52	21.57	21.39
15	1	74		21.56	21.62	21.50
15	36	0		20.36	20.38	20.27
15	36	20		20.39	20.43	20.22
15	36	39		20.34	20.38	20.17
15	75	0		20.40	20.41	20.27



LTE Band 2 Maximum Average Power [dBm]						
BW [MHz]	RB Size	RB Offset	Mod	Lowest	Middle	Highest
10	1	0	QPSK	23.19	23.25	23.18
10	1	25		23.09	23.16	23.15
10	1	49		23.08	23.15	23.10
10	25	0		22.09	22.20	22.19
10	25	12		22.09	22.20	22.18
10	25	25		22.04	22.17	22.13
10	50	0		22.08	22.17	22.16
10	1	0	16-QAM	22.63	22.63	22.51
10	1	25		22.46	22.59	22.47
10	1	49		22.46	22.65	22.54
10	25	0		21.27	21.35	21.26
10	25	12		21.27	21.35	21.28
10	25	25		21.22	21.33	21.28
10	50	0		21.23	21.32	21.28
10	1	0	64QAM	21.36	21.53	21.22
10	1	25		21.62	21.67	21.35
10	1	49		21.61	21.67	21.45
10	25	0		20.39	20.44	20.19
10	25	12		20.41	20.50	20.13
10	25	25		20.38	20.46	20.13
10	50	0		20.41	20.50	20.25
5	1	0	QPSK	23.08	23.16	23.14
5	1	12		23.09	23.17	23.14
5	1	24		23.03	23.15	23.08
5	12	0		22.12	22.23	22.16
5	12	7		22.15	22.20	22.17
5	12	13		22.08	22.20	22.14
5	25	0		22.07	22.17	22.13
5	1	0	16-QAM	22.54	22.56	22.49
5	1	12		22.54	22.63	22.53
5	1	24		22.46	22.55	22.53
5	12	0		21.32	21.37	21.28
5	12	7		21.28	21.35	21.35



5	12	13	64QAM	21.27	21.36	21.31
5	25	0		21.24	21.31	21.26
5	1	0		21.33	21.50	21.28
5	1	12		21.52	21.57	21.39
5	1	24		21.56	21.62	21.50
5	12	0		20.36	20.38	20.27
5	12	7		20.39	20.43	20.22
5	12	13		20.34	20.38	20.17
5	25	0		20.37	20.41	20.27



LTE Band 2 Maximum Average Power [dBm]						
BW [MHz]	RB Size	RB Offset	Mod	Lowest	Middle	Highest
3	1	0	QPSK	23.12	23.16	23.13
3	1	8		23.12	23.18	23.10
3	1	14		23.06	23.12	23.09
3	8	0		22.13	22.20	22.13
3	8	4		22.14	22.26	22.16
3	8	7		22.11	22.18	22.12
3	15	0		22.12	22.18	22.14
3	1	0	16-QAM	22.56	22.56	22.46
3	1	8		22.56	22.64	22.48
3	1	14		22.46	22.51	22.45
3	8	0		21.35	21.40	21.34
3	8	4		21.38	21.44	21.37
3	8	7		21.31	21.42	21.39
3	15	0		21.26	21.36	21.31
3	1	0	64QAM	21.36	21.53	21.34
3	1	8		21.62	21.67	21.43
3	1	14		21.61	21.67	21.55
3	8	0		20.39	20.44	20.35
3	8	4		20.41	20.50	20.31
3	8	7		20.38	20.46	20.21
3	15	0		20.41	20.50	20.29
1.4	1	0	QPSK	23.20	23.17	23.08
1.4	1	3		23.20	23.26	23.18
1.4	1	5		23.16	23.13	23.07
1.4	3	0		23.15	23.19	23.15
1.4	3	1		23.18	23.23	23.16
1.4	3	3		23.14	23.18	23.13
1.4	6	0		22.14	22.21	22.02
1.4	1	0	16-QAM	22.57	22.59	22.47
1.4	1	3		22.64	22.69	22.56
1.4	1	5		22.56	22.64	22.49
1.4	3	0		22.30	22.35	22.25
1.4	3	1		22.33	22.41	22.30



1.4	3	3	64QAM	22.25	22.36	22.29
1.4	6	0		21.36	21.40	21.37
1.4	1	0		21.33	21.50	21.28
1.4	1	3		21.52	21.57	21.39
1.4	1	5		21.56	21.62	21.50
1.4	3	0		20.36	20.38	20.27
1.4	3	1		20.39	20.43	20.22
1.4	3	3		20.34	20.38	20.17
1.4	6	0		20.37	20.41	20.27



LTE Band 4 Maximum Average Power [dBm]						
BW [MHz]	RB Size	RB Offset	Mod	Lowest	Middle	Highest
20	1	0	QPSK	23.46	23.19	23.32
20	1	49		23.40	23.25	23.30
20	1	99		23.23	23.11	23.40
20	50	0		22.42	22.32	22.33
20	50	24		22.34	22.29	22.41
20	50	50		22.27	22.26	22.36
20	100	0		22.33	22.31	22.43
20	1	0	16-QAM	22.87	22.67	22.68
20	1	49		22.79	22.68	22.71
20	1	99		22.62	22.52	22.87
20	50	0		21.58	21.45	21.49
20	50	24		21.49	21.44	21.61
20	50	50		21.44	21.41	21.54
20	100	0		21.42	21.41	21.54
20	1	0	64QAM	21.51	21.32	21.35
20	1	49		21.62	21.50	21.41
20	1	99		21.33	21.26	21.30
20	50	0		20.40	20.33	20.29
20	50	24		20.42	20.35	20.28
20	50	50		20.43	20.31	20.27
20	100	0		20.44	20.35	20.30
15	1	0	QPSK	23.43	23.19	23.34
15	1	37		23.37	23.24	23.40
15	1	74		23.15	23.13	23.36
15	36	0		22.43	22.30	22.34
15	36	20		22.34	22.34	22.45
15	36	39		22.27	22.29	22.37
15	75	0		22.31	22.30	22.38
15	1	0	16-QAM	22.87	22.63	22.74
15	1	37		22.81	22.64	22.81
15	1	74		22.54	22.52	22.84
15	36	0		21.57	21.42	21.51



15	36	20		21.50	21.49	21.59
15	36	39		21.47	21.45	21.54
15	75	0		21.43	21.44	21.55
15	1	0	64QAM	21.48	21.29	21.29
15	1	37		21.52	21.40	21.37
15	1	74		21.28	21.21	21.25
15	36	0		20.37	20.27	20.21
15	36	20		20.40	20.28	20.19
15	36	39		20.39	20.23	20.23
15	75	0		20.40	20.26	20.28





LTE Band 4 Maximum Average Power [dBm]						
BW [MHz]	RB Size	RB Offset	Mod	Lowest	Middle	Highest
10	1	0	QPSK	23.39	23.26	23.31
10	1	25		23.39	23.26	23.39
10	1	49		23.32	23.10	23.40
10	25	0		22.39	22.28	22.37
10	25	12		22.39	22.28	22.38
10	25	25		22.35	22.25	22.34
10	50	0		22.37	22.26	22.36
10	1	0	16-QAM	22.83	22.66	22.72
10	1	25		22.79	22.64	22.78
10	1	49		22.78	22.48	22.84
10	25	0		21.52	21.39	21.54
10	25	12		21.55	21.38	21.51
10	25	25		21.48	21.35	21.45
10	50	0		21.49	21.39	21.51
10	1	0	64QAM	21.51	21.26	21.35
10	1	25		21.42	21.30	21.33
10	1	49		21.23	21.16	21.20
10	25	0		20.34	20.21	20.13
10	25	12		20.38	20.21	20.10
10	25	25		20.35	20.15	20.19
10	50	0		20.36	20.17	20.26
5	1	0	QPSK	23.36	23.20	23.32
5	1	12		23.32	23.23	23.42
5	1	24		23.28	23.20	23.40
5	12	0		22.38	22.28	22.36
5	12	7		22.42	22.28	22.47
5	12	13		22.38	22.22	22.42
5	25	0		22.34	22.24	22.32
5	1	0	16-QAM	22.78	22.59	22.73
5	1	12		22.78	22.62	22.87
5	1	24		22.74	22.57	22.82
5	12	0		21.48	21.35	21.53
5	12	7		21.50	21.42	21.62



5	12	13	64QAM	21.54	21.39	21.61
5	25	0		21.50	21.36	21.48
5	1	0		21.60	21.16	21.41
5	1	12		21.32	21.20	21.23
5	1	24		21.17	21.11	21.16
5	12	0		20.29	20.15	20.07
5	12	7		20.35	20.18	20.01
5	12	13		20.33	20.13	20.14
5	25	0		20.32	20.12	20.20



LTE Band 4 Maximum Average Power [dBm]						
BW [MHz]	RB Size	RB Offset	Mod	Lowest	Middle	Highest
3	1	0	QPSK	23.32	23.19	23.40
3	1	8		23.31	23.20	23.41
3	1	14		23.29	23.17	23.36
3	8	0		22.37	22.21	22.43
3	8	4		22.39	22.29	22.45
3	8	7		22.34	22.23	22.42
3	15	0		22.33	22.20	22.42
3	1	0	16-QAM	22.71	22.60	22.78
3	1	8		22.77	22.61	22.84
3	1	14		22.72	22.56	22.80
3	8	0		21.56	21.42	21.63
3	8	4		21.59	21.45	21.67
3	8	7		21.54	21.42	21.64
3	15	0		21.49	21.37	21.55
3	1	0	64QAM	21.51	21.06	21.35
3	1	8		21.22	21.10	21.13
3	1	14		21.11	21.06	21.12
3	8	0		20.24	20.09	20.01
3	8	4		20.32	20.15	19.92
3	8	7		20.31	20.11	20.09
3	15	0		20.28	20.07	20.14
1.4	1	0	QPSK	23.26	23.13	23.34
1.4	1	3		23.32	23.23	23.41
1.4	1	5		23.24	23.12	23.32
1.4	3	0		23.31	23.14	23.35
1.4	3	1		23.32	23.22	23.40
1.4	3	3		23.28	23.15	23.35
1.4	6	0		22.28	22.20	22.36
1.4	1	0	16-QAM	22.65	22.50	22.71
1.4	1	3		22.70	22.54	22.82
1.4	1	5		22.61	22.51	22.70
1.4	3	0		22.44	22.28	22.52
1.4	3	1		22.46	22.37	22.55



1.4	3	3	64QAM	22.42	22.25	22.49
1.4	6	0		21.46	21.35	21.54
1.4	1	0		21.60	21.16	21.41
1.4	1	3		21.32	21.20	21.23
1.4	1	5		21.17	21.11	21.16
1.4	3	0		20.29	20.15	20.07
1.4	3	1		20.35	20.18	20.01
1.4	3	3		20.33	20.13	20.14
1.4	6	0		20.32	20.12	20.20



LTE Band 5 Maximum Average Power [dBm]						
BW [MHz]	RB Size	RB Offset	Mod	Lowest	Middle	Highest
10	1	0	QPSK	23.13	23.31	23.44
10	1	25		23.26	23.38	23.39
10	1	49		23.29	23.40	23.40
10	25	0		22.33	22.41	22.46
10	25	12		22.40	22.44	22.44
10	25	25		22.35	22.37	22.38
10	50	0		22.39	22.40	22.44
10	1	0	16-QAM	22.60	22.73	22.83
10	1	25		22.67	22.76	22.78
10	1	49		22.73	22.81	22.78
10	25	0		21.48	21.55	21.58
10	25	12		21.53	21.54	21.56
10	25	25		21.48	21.47	21.52
10	50	0		21.52	21.51	21.53
10	1	0	64QAM	21.28	21.44	21.52
10	1	25		21.31	21.62	21.71
10	1	49		21.26	21.46	21.57
10	25	0		20.38	20.52	20.63
10	25	12		20.41	20.63	20.66
10	25	25		20.39	20.41	20.52
10	50	0		20.43	20.60	20.74
5	1	0	QPSK	23.07	23.28	23.34
5	1	12		23.25	23.34	23.33
5	1	24		23.22	23.41	23.37
5	12	0		22.25	22.41	22.42
5	12	7		22.34	22.44	22.44
5	12	13		22.30	22.36	22.42
5	25	0		22.30	22.38	22.39
5	1	0	16-QAM	22.58	22.66	22.75
5	1	12		22.71	22.72	22.71
5	1	24		22.67	22.79	22.81
5	12	0		21.36	21.55	21.52
5	12	7		21.51	21.58	21.53



5	12	13		21.45	21.50	21.50
5	25	0		21.46	21.49	21.47
5	1	0	64QAM	21.23	21.33	21.58
5	1	12		21.19	21.52	21.81
5	1	24		21.13	21.41	21.65
5	12	0		20.29	20.46	20.69
5	12	7		20.33	20.55	20.75
5	12	13		20.32	20.35	20.61
5	25	0		20.39	20.55	20.80



LTE Band 5 Maximum Average Power [dBm]						
BW [MHz]	RB Size	RB Offset	Mod	Lowest	Middle	Highest
3	1	0	QPSK	23.10	23.25	23.33
3	1	8		23.18	23.31	23.41
3	1	14		23.28	23.43	23.39
3	8	0		22.21	22.37	22.37
3	8	4		22.23	22.39	22.42
3	8	7		22.32	22.38	22.49
3	15	0		22.17	22.36	22.34
3	1	0	16-QAM	22.51	22.62	22.73
3	1	8		22.65	22.70	22.82
3	1	14		22.64	22.74	22.78
3	8	0		21.43	21.56	21.54
3	8	4		21.44	21.57	21.57
3	8	7		21.52	21.56	21.68
3	15	0		21.36	21.48	21.48
3	1	0	64QAM	21.13	21.41	21.65
3	1	8		21.11	21.62	21.61
3	1	14		21.00	21.46	21.73
3	8	0		20.18	20.52	20.78
3	8	4		20.25	20.63	20.84
3	8	7		20.25	20.41	20.71
3	15	0		20.30	20.57	20.92
1.4	1	0	QPSK	23.02	23.25	23.36
1.4	1	3		23.07	23.32	23.41
1.4	1	5		23.11	23.24	23.33
1.4	3	0		23.10	23.30	23.38
1.4	3	1		23.08	23.35	23.41
1.4	3	3		23.17	23.31	23.38
1.4	6	0		22.13	22.29	22.41
1.4	1	0	16-QAM	22.50	22.71	22.69
1.4	1	3		22.58	22.78	22.75
1.4	1	5		22.61	22.68	22.70
1.4	3	0		22.26	22.46	22.52
1.4	3	1		22.28	22.47	22.54



1.4	3	3	64QAM	22.32	22.41	22.50
1.4	6	0		21.36	21.51	21.61
1.4	1	0		21.23	21.33	21.58
1.4	1	3		21.19	21.52	21.81
1.4	1	5		21.13	21.41	21.65
1.4	3	0		20.29	20.46	20.69
1.4	3	1		20.33	20.55	20.75
1.4	3	3		20.32	20.35	20.61
1.4	6	0		20.39	20.55	20.80





LTE Band 7 Maximum Average Power [dBm]						
BW [MHz]	RB Size	RB Offset	Mod	Lowest	Middle	Highest
20	1	0	QPSK	22.21	22.16	22.16
20	1	49		22.20	22.18	22.05
20	1	99		22.18	22.22	22.45
20	50	0		22.06	22.11	22.06
20	50	24		22.11	22.13	22.18
20	50	50		22.11	22.12	22.17
20	100	0		22.10	22.13	22.08
20	1	0	16-QAM	22.23	22.23	22.36
20	1	49		22.25	22.35	22.41
20	1	99		22.33	22.43	22.42
20	50	0		21.18	21.14	21.15
20	50	24		21.18	21.19	21.26
20	50	50		21.20	21.21	21.26
20	100	0		21.16	21.20	21.18
20	1	0	64QAM	21.00	21.02	21.12
20	1	49		21.16	21.25	21.37
20	1	99		21.19	21.39	21.43
20	50	0		20.11	20.19	20.28
20	50	24		20.15	20.21	20.35
20	50	50		20.17	20.26	20.37
20	100	0		20.13	20.19	20.29
15	1	0	QPSK	22.15	22.16	22.10
15	1	37		22.14	22.02	22.09
15	1	74		22.15	22.13	22.16
15	36	0		22.10	22.11	22.15
15	36	20		22.12	22.09	22.19
15	36	39		22.10	22.09	22.15
15	75	0		22.10	22.11	22.16
15	1	0	16-QAM	22.27	22.27	22.43
15	1	37		22.28	22.33	22.38
15	1	74		22.33	22.44	22.32
15	36	0		21.18	21.14	21.26



15	36	20	64QAM	21.20	21.21	21.23
15	36	39		21.20	21.20	21.25
15	75	0		21.18	21.16	21.23
15	1	0		20.95	21.00	21.14
15	1	37		21.11	21.22	21.33
15	1	74		21.23	21.35	21.38
15	36	0		20.16	20.14	20.25
15	36	20		20.21	20.15	20.08
15	36	39		20.20	20.23	20.34
15	75	0		20.16	20.21	20.24



LTE Band 7 Maximum Average Power [dBm]						
BW [MHz]	RB Size	RB Offset	Mod	Lowest	Middle	Highest
10	1	0	QPSK	22.12	22.14	22.07
10	1	25		22.03	22.05	22.06
10	1	49		22.01	22.08	22.14
10	25	0		22.06	22.05	22.11
10	25	12		22.12	22.07	22.16
10	25	25		22.10	22.11	22.15
10	50	0		22.10	22.09	22.12
10	1	0	16-QAM	22.27	22.25	22.38
10	1	25		22.35	22.35	22.36
10	1	49		22.38	22.43	22.43
10	25	0		21.15	21.15	21.19
10	25	12		21.18	21.19	21.21
10	25	25		21.18	21.15	21.23
10	50	0		21.18	21.13	21.18
10	1	0	64QAM	21.03	21.03	21.15
10	1	25		21.15	21.19	21.35
10	1	49		21.24	21.38	21.33
10	25	0		20.18	20.16	20.24
10	25	12		20.22	20.13	20.12
10	25	25		20.19	20.29	20.35
10	50	0		20.21	20.26	20.22
5	1	0	QPSK	22.13	22.11	22.05
5	1	12		22.07	22.05	22.05
5	1	24		22.04	22.02	22.09
5	12	0		22.06	22.05	22.07
5	12	7		22.14	22.07	22.12
5	12	13		22.10	22.10	22.09
5	25	0		22.09	22.05	22.08
5	1	0	16-QAM	22.24	22.22	22.35
5	1	12		22.36	22.37	22.36
5	1	24		22.37	22.37	22.44
5	12	0		21.12	21.11	21.15
5	12	7		21.18	21.17	21.18



5	12	13		21.18	21.13	21.17
5	25	0		21.14	21.15	21.15
5	1	0	64QAM	21.02	20.91	21.17
5	1	12		21.26	21.15	21.40
5	1	24		21.27	21.34	21.47
5	12	0		20.16	20.10	20.34
5	12	7		20.21	20.14	20.45
5	12	13		20.26	20.20	20.46
5	25	0		20.25	20.15	20.37



LTE Band 12 Maximum Average Power [dBm]						
BW [MHz]	RB Size	RB Offset	Mod	Lowest	Middle	Highest
10	1	0	QPSK	22.81	22.98	23.19
10	1	25		23.12	23.28	23.27
10	1	49		23.31	23.31	23.37
10	25	0		22.06	22.22	22.30
10	25	12		22.16	22.33	22.33
10	25	25		22.37	22.32	22.30
10	50	0		22.15	22.31	22.28
10	1	0	16-QAM	22.18	22.42	22.68
10	1	25		22.60	22.79	22.64
10	1	49		22.79	22.70	22.78
10	25	0		21.17	21.37	21.41
10	25	12		21.29	21.49	21.42
10	25	25		21.50	21.41	21.41
10	50	0		21.28	21.43	21.42
10	1	0	64QAM	21.77	21.85	21.96
10	1	25		21.85	21.92	21.98
10	1	49		21.76	21.89	21.96
10	25	0		20.13	20.18	20.35
10	25	12		20.08	20.19	20.41
10	25	25		20.04	20.17	20.44
10	50	0		20.10	20.19	20.28
5	1	0	QPSK	22.83	23.23	23.13
5	1	12		22.92	23.27	23.23
5	1	24		23.13	23.30	23.22
5	12	0		21.99	22.36	22.18
5	12	7		22.09	22.34	22.28
5	12	13		22.08	22.33	22.27
5	25	0		22.06	22.31	22.12
5	1	0	16-QAM	22.19	22.69	22.54
5	1	12		22.33	22.75	22.66
5	1	24		22.57	22.70	22.65
5	12	0		21.10	21.48	21.29
5	12	7		21.24	21.51	21.40



5	12	13	64QAM	21.20	21.48	21.43
5	25	0		21.18	21.46	21.26
5	1	0		21.86	21.95	21.92
5	1	12		21.95	21.90	21.97
5	1	24		21.82	21.94	22.00
5	12	0		20.18	20.24	20.41
5	12	7		20.11	20.22	20.50
5	12	13		20.06	20.19	20.49
5	25	0		20.14	20.24	20.34



LTE Band 12 Maximum Average Power [dBm]						
BW [MHz]	RB Size	RB Offset	Mod	Lowest	Middle	Highest
3	1	0	QPSK	22.83	23.18	23.19
3	1	8		22.89	23.28	23.18
3	1	14		23.03	23.26	23.22
3	8	0		21.97	22.33	22.25
3	8	4		21.98	22.33	22.24
3	8	7		22.08	22.33	22.22
3	15	0		21.97	22.29	22.57
3	1	0	16-QAM	22.14	22.65	22.64
3	1	8		22.28	22.73	22.61
3	1	14		22.40	22.68	22.41
3	8	0		21.14	21.49	21.47
3	8	4		21.14	21.53	21.43
3	8	7		21.23	21.49	21.38
3	15	0		21.07	21.41	21.33
3	1	0	64QAM	21.77	21.85	21.98
3	1	8		21.85	21.80	21.97
3	1	14		21.76	21.89	21.94
3	8	0		20.13	20.18	20.47
3	8	4		20.08	20.19	20.59
3	8	7		20.04	20.17	20.54
3	15	0		20.10	20.19	20.40
1.4	1	0	QPSK	22.74	23.11	23.12
1.4	1	3		22.80	23.27	23.18
1.4	1	5		22.85	23.20	23.10
1.4	3	0		22.80	23.25	23.14
1.4	3	1		22.82	23.27	23.19
1.4	3	3		22.88	23.23	23.17
1.4	6	0		21.89	22.21	22.15
1.4	1	0	16-QAM	22.12	22.57	22.52
1.4	1	3		22.15	22.75	22.63
1.4	1	5		22.20	22.65	22.56
1.4	3	0		21.93	22.41	22.30
1.4	3	1		21.95	22.45	22.32



1.4	3	3	64QAM	21.96	22.40	22.29
1.4	6	0		21.09	21.43	21.33
1.4	1	0		21.72	21.74	21.94
1.4	1	3		21.73	21.70	21.97
1.4	1	5		21.63	21.84	21.92
1.4	3	0		20.04	20.12	20.53
1.4	3	1		20.00	20.11	20.68
1.4	3	3		20.07	20.11	20.63
1.4	6	0		20.06	20.14	20.46





LTE Band 17 Maximum Average Power [dBm]						
BW [MHz]	RB Size	RB Offset	Mod	Lowest	Middle	Highest
10	1	0	QPSK	23.35	23.32	23.41
10	1	25		23.42	23.41	23.43
10	1	49		23.42	23.37	23.37
10	25	0		22.43	22.43	22.42
10	25	12		22.45	22.45	22.45
10	25	25		22.42	22.44	22.44
10	50	0		22.45	22.44	22.45
10	1	0	16-QAM	22.83	22.79	22.90
10	1	25		22.90	22.80	22.79
10	1	49		22.87	22.83	22.81
10	25	0		21.60	21.59	21.58
10	25	12		21.60	21.56	21.55
10	25	25		21.56	21.56	21.54
10	50	0		21.58	21.56	21.55
10	1	0	64QAM	21.52	21.46	21.52
10	1	25		21.84	21.85	21.91
10	1	49		21.71	21.73	21.82
10	25	0		20.50	20.56	20.63
10	25	12		20.63	20.69	20.75
10	25	25		20.58	20.64	20.73
10	50	0		20.55	20.58	20.66
5	1	0	QPSK	23.25	23.30	23.37
5	1	12		23.37	23.41	23.38
5	1	24		23.36	23.29	23.36
5	12	0		22.42	22.45	22.43
5	12	7		22.55	22.51	22.43
5	12	13		22.49	22.46	22.43
5	25	0		22.48	22.41	22.39
5	1	0	16-QAM	22.68	22.76	22.73
5	1	12		22.94	22.82	22.79
5	1	24		22.85	22.66	22.77
5	12	0		21.56	21.56	21.51
5	12	7		21.65	21.58	21.57



5	12	13	64QAM	21.65	21.57	21.55
5	25	0		21.60	21.59	21.53
5	1	0		21.61	21.56	21.58
5	1	12		21.94	21.95	21.90
5	1	24		21.77	21.78	21.86
5	12	0		20.55	20.62	20.69
5	12	7		20.66	20.72	20.84
5	12	13		20.60	20.66	20.78
5	25	0		20.59	20.63	20.72



**ERP/EIRP**

LTE Band 2 (G <sub>T</sub> - L <sub>C</sub> = -0.60 dB) QPSK									
Bandwidth	1.4M			3M			5M		
Channel	18607	18900	19193	18615	18900	19185	18625	18900	19175
	(Low)	(Mid)	(High)	(Low)	(Mid)	(High)	(Low)	(Mid)	(High)
Frequency	1850.7	1880	1909.3	1851.5	1880	1908.5	1852.5	1880	1907.5
(MHz)									
Conducted Power (dBm)	23.20	23.26	23.18	23.12	23.18	23.10	23.09	23.17	23.14
Conducted Power (Watts)	0.2089	0.2118	0.2080	0.2051	0.2080	0.2042	0.2037	0.2075	0.2061
EIRP(dBm)	22.60	22.66	22.58	22.52	22.58	22.50	22.49	22.57	22.54
EIRP(Watts)	0.1820	0.1845	0.1811	0.1786	0.1811	0.1778	0.1774	0.1807	0.1795

LTE Band 2 (G <sub>T</sub> - L <sub>C</sub> = -0.60 dB) QPSK									
Bandwidth	10M			15M			20M		
Channel	18650	18900	19150	18675	18900	19125	18650	18900	19100
	(Low)	(Mid)	(High)	(Low)	(Mid)	(High)	(Low)	(Mid)	(High)
Frequency	1855	1880	1905	1857.5	1880	1902.5	1860	1880	1900
(MHz)									
Conducted Power (dBm)	23.19	23.25	23.18	23.03	23.25	23.08	23.24	23.27	23.18
Conducted Power (Watts)	0.2084	0.2113	0.2080	0.2009	0.2113	0.2032	0.2109	0.2123	0.2080
EIRP(dBm)	22.59	22.65	22.58	22.43	22.65	22.48	22.64	22.67	22.58
EIRP(Watts)	0.1816	0.1841	0.1811	0.1750	0.1841	0.1770	0.1837	0.1849	0.1811



LTE Band 2 ( $G_T - L_C = -0.60\text{dB}$ ) 16QAM									
Bandwidth	1.4M			3M			5M		
Channel	18607	18900	19193	18615	18900	19185	18625	18900	19175
	(Low)	(Mid)	(High)	(Low)	(Mid)	(High)	(Low)	(Mid)	(High)
Frequency (MHz)	1850.7	1880	1909.3	1851.5	1880	1908.5	1852.5	1880	1907.5
Conducted Power (dBm)	22.64	22.69	22.56	22.56	22.64	22.48	22.54	22.63	22.53
Conducted Power (Watts)	0.1837	0.1858	0.1803	0.1803	0.1837	0.1770	0.1795	0.1832	0.1791
EIRP(dBm)	22.04	22.09	21.96	21.96	22.04	21.88	21.94	22.03	21.93
EIRP(Watts)	0.1600	0.1618	0.1570	0.1570	0.1600	0.1542	0.1563	0.1596	0.1560

LTE Band 2 ( $G_T - L_C = -0.60\text{ dB}$ ) 16QAM									
Bandwidth	10M			15M			20M		
Channel	18650	18900	19150	18675	18900	19125	18650	18900	19100
	(Low)	(Mid)	(High)	(Low)	(Mid)	(High)	(Low)	(Mid)	(High)
Frequency (MHz)	1855	1880	1905	1857.5	1880	1902.5	1860	1880	1900
Conducted Power (dBm)	22.46	22.65	22.54	22.48	22.65	22.42	22.73	22.69	22.77
Conducted Power (Watts)	0.1762	0.1841	0.1795	0.1770	0.1841	0.1746	0.1875	0.1858	0.1892
EIRP(dBm)	21.86	22.05	21.94	21.88	22.05	21.82	22.13	22.09	22.17
EIRP(Watts)	0.1535	0.1603	0.1563	0.1542	0.1603	0.1521	0.1633	0.1618	0.1648



LTE Band 2 ( $G_T - L_C = -0.60$ dB) 64QAM									
Bandwidth	1.4M			3M			5M		
Channel	18607	18900	19193	18615	18900	19185	18625	18900	19175
	(Low)	(Mid)	(High)	(Low)	(Mid)	(High)	(Low)	(Mid)	(High)
Frequency	1850.7	1880	1909.3	1851.5	1880	1908.5	1852.5	1880	1907.5
(MHz)									
Conducted Power (dBm)	21.56	21.62	21.50	21.62	21.67	21.43	21.56	21.62	21.50
Conducted Power (Watts)	0.1432	0.1452	0.1413	0.1452	0.1469	0.1390	0.1432	0.1452	0.1413
EIRP(dBm)	20.96	21.02	20.90	21.02	21.07	20.83	20.96	21.02	20.90
EIRP(Watts)	0.1247	0.1265	0.1230	0.1265	0.1279	0.1211	0.1247	0.1265	0.1230

LTE Band 2 ( $G_T - L_C = -0.60$ dB) 64QAM									
Bandwidth	10M			15M			20M		
Channel	18650	18900	19150	18675	18900	19125	18650	18900	19100
	(Low)	(Mid)	(High)	(Low)	(Mid)	(High)	(Low)	(Mid)	(High)
Frequency	1855	1880	1905	1857.5	1880	1902.5	1860	1880	1900
(MHz)									
Conducted Power (dBm)	21.62	21.67	21.35	21.56	21.62	21.50	21.54	21.59	21.60
Conducted Power (Watts)	0.1452	0.1469	0.1365	0.1432	0.1452	0.1413	0.1426	0.1442	0.1445
EIRP(dBm)	21.02	21.07	20.75	20.96	21.02	20.90	20.94	20.99	21.00
EIRP(Watts)	0.1265	0.1279	0.1189	0.1247	0.1265	0.1230	0.1242	0.1256	0.1259



LTE Band 4 (G <sub>T</sub> - L <sub>C</sub> = -1.20 dB) QPSK									
Bandwidth	1.4M			3M			5M		
Channel	19957	20175	20393	19965	20175	20385	19975	20175	20375
	(Low)	(Mid)	(High)	(Low)	(Mid)	(High)	(Low)	(Mid)	(High)
Frequency (MHz)	1710.7	1732.5	1754.3	1711.5	1732.5	1753.5	1712.5	1732.5	1752.5
Conducted Power (dBm)	23.32	23.23	23.41	23.31	23.20	23.41	23.32	23.23	23.42
Conducted Power (Watts)	0.2148	0.2104	0.2193	0.2143	0.2089	0.2193	0.2148	0.2104	0.2198
EIRP(dBm)	22.12	22.03	22.21	22.11	22.00	22.21	22.12	22.03	22.22
EIRP(Watts)	0.1629	0.1596	0.1663	0.1626	0.1585	0.1663	0.1629	0.1596	0.1667

LTE Band 4 (G <sub>T</sub> - L <sub>C</sub> = -1.20 dB) QPSK									
Bandwidth	10M			15M			20M		
Channel	20000	20175	20350	20025	20175	20325	20050	20175	20300
	(Low)	(Mid)	(High)	(Low)	(Mid)	(High)	(Low)	(Mid)	(High)
Frequency (MHz)	1715	1732.5	1750	1717.5	1732.5	1747.5	1720	1732.5	1745
Conducted Power (dBm)	23.32	23.10	23.40	23.43	23.19	23.34	23.46	23.19	23.32
Conducted Power (Watts)	0.2148	0.2042	0.2188	0.2203	0.2084	0.2158	0.2218	0.2084	0.2148
EIRP(dBm)	22.12	21.90	22.20	22.23	21.99	22.14	22.26	21.99	22.12
EIRP(Watts)	0.1629	0.1549	0.1660	0.1671	0.1581	0.1637	0.1683	0.1581	0.1629



LTE Band 4 (G <sub>T</sub> - L <sub>C</sub> = -1.20 dB) 16QAM									
Bandwidth	1.4M			3M			5M		
Channel	19957	20175	20393	19965	20175	20385	19975	20175	20375
	(Low)	(Mid)	(High)	(Low)	(Mid)	(High)	(Low)	(Mid)	(High)
Frequency (MHz)	1710.7	1732.5	1754.3	1711.5	1732.5	1753.5	1712.5	1732.5	1752.5
Conducted Power (dBm)	22.70	22.54	22.82	22.77	22.61	22.84	22.78	22.62	22.87
Conducted Power (Watts)	0.1862	0.1795	0.1914	0.1892	0.1824	0.1923	0.1897	0.1828	0.1936
EIRP(dBm)	21.50	21.34	21.62	21.57	21.41	21.64	21.58	21.42	21.67
EIRP(Watts)	0.1413	0.1361	0.1452	0.1435	0.1384	0.1459	0.1439	0.1387	0.1469

LTE Band 4 (G <sub>T</sub> - L <sub>C</sub> = -1.20 dB) 16QAM									
Bandwidth	10M			15M			20M		
Channel	20000	20175	20350	20025	20175	20325	20050	20175	20300
	(Low)	(Mid)	(High)	(Low)	(Mid)	(High)	(Low)	(Mid)	(High)
Frequency (MHz)	1715	1732.5	1750	1717.5	1732.5	1747.5	1720	1732.5	1745
Conducted Power (dBm)	22.78	22.48	22.84	22.87	22.63	22.74	22.87	22.67	22.68
Conducted Power (Watts)	0.1897	0.1770	0.1923	0.1936	0.1832	0.1879	0.1936	0.1849	0.1854
EIRP(dBm)	21.58	21.28	21.64	21.67	21.43	21.54	21.67	21.47	21.48
EIRP(Watts)	0.1439	0.1343	0.1459	0.1469	0.1390	0.1426	0.1469	0.1403	0.1406



LTE Band 4 (G <sub>T</sub> - L <sub>C</sub> = -1.20 dB) 64QAM									
Bandwidth	1.4M			3M			5M		
Channel	19957	20175	20393	19965	20175	20385	19975	20175	20375
	(Low)	(Mid)	(High)	(Low)	(Mid)	(High)	(Low)	(Mid)	(High)
Frequency	1710.7	1732.5	1754.3	1711.5	1732.5	1753.5	1712.5	1732.5	1752.5
(MHz)									
Conducted Power (dBm)	21.60	21.16	21.41	21.51	21.06	21.35	21.60	21.16	21.41
Conducted Power (Watts)	0.1445	0.1306	0.1384	0.1416	0.1276	0.1365	0.1445	0.1306	0.1384
EIRP(dBm)	20.40	19.96	20.21	20.31	19.86	20.15	20.40	19.96	20.21
EIRP(Watts)	0.1096	0.0991	0.1050	0.1074	0.0968	0.1035	0.1096	0.0991	0.1050

LTE Band 4 (G <sub>T</sub> - L <sub>C</sub> = -1.20 dB) 64QAM									
Bandwidth	10M			15M			20M		
Channel	20000	20175	20350	20025	20175	20325	20050	20175	20300
	(Low)	(Mid)	(High)	(Low)	(Mid)	(High)	(Low)	(Mid)	(High)
Frequency	1715	1732.5	1750	1717.5	1732.5	1747.5	1720	1732.5	1745
(MHz)									
Conducted Power (dBm)	21.51	21.26	21.35	21.52	21.40	21.37	21.62	21.50	21.41
Conducted Power (Watts)	0.1416	0.1337	0.1365	0.1419	0.1380	0.1371	0.1452	0.1413	0.1384
EIRP(dBm)	20.31	20.06	20.15	20.32	20.20	20.17	20.42	20.30	20.21
EIRP(Watts)	0.1074	0.1014	0.1035	0.1076	0.1047	0.1040	0.1102	0.1072	0.1050





LTE Band 5 (G <sub>T</sub> - L <sub>C</sub> = -3.30 dB) QPSK									
Bandwidth	1.4M			3M			5M		
Channel	20407	20525	20643	20415	20525	20635	20425	20525	20625
	(Low)	(Mid)	(High)	(Low)	(Mid)	(High)	(Low)	(Mid)	(High)
Frequency (MHz)	824.7	836.5	848.3	825.5	836.5	847.5	826.5	836.5	846.5
Conducted Power (dBm)	23.08	23.35	23.41	23.28	23.43	23.39	23.22	23.41	23.37
Conducted Power (Watts)	0.2032	0.2163	0.2193	0.2128	0.2203	0.2183	0.2099	0.2193	0.2173
ERP(dBm)	17.63	17.90	17.96	17.83	17.98	17.94	17.77	17.96	17.92
ERP(Watts)	0.0579	0.0617	0.0625	0.0607	0.0628	0.0622	0.0598	0.0625	0.0619

LTE Band 5 (G <sub>T</sub> - L <sub>C</sub> = -3.30 dB) QPSK			
Bandwidth	10M		
Channel	20450	20525	20600
	(Low)	(Mid)	(High)
Frequency (MHz)	829	836.5	844
Conducted Power (dBm)	23.13	23.31	23.44
Conducted Power (Watts)	0.2056	0.2143	0.2208
ERP(dBm)	17.68	17.86	17.99
ERP(Watts)	0.0586	0.0611	0.0630



LTE Band 5 ( $G_T - L_C = -3.30$ dB) 16QAM									
Bandwidth	1.4M			3M			5M		
Channel	20407	20525	20643	20415	20525	20635	20425	20525	20625
	(Low)	(Mid)	(High)	(Low)	(Mid)	(High)	(Low)	(Mid)	(High)
Frequency (MHz)	824.7	836.5	848.3	825.5	836.5	847.5	826.5	836.5	846.5
Conducted Power (dBm)	22.58	22.78	22.75	22.65	22.70	22.82	22.67	22.79	22.81
Conducted Power (Watts)	0.1811	0.1897	0.1884	0.1841	0.1862	0.1914	0.1849	0.1901	0.1910
ERP(dBm)	17.13	17.33	17.30	17.20	17.25	17.37	17.22	17.34	17.36
ERP(Watts)	0.0516	0.0541	0.0537	0.0525	0.0531	0.0546	0.0527	0.0542	0.0545

LTE Band 5 ( $G_T - L_C = -3.30$ dB) 16QAM			
Bandwidth	10M		
Channel	20450	20525	20600
	(Low)	(Mid)	(High)
Frequency (MHz)	829	836.5	844
Conducted Power (dBm)	22.60	22.73	22.83
Conducted Power (Watts)	0.1820	0.1875	0.1919
ERP(dBm)	17.15	17.28	17.38
ERP(Watts)	0.0519	0.0535	0.0547



LTE Band 5 ( $G_T - L_C = -3.30$ dB) 64QAM									
Bandwidth	1.4M			3M			5M		
Channel	20407	20525	20643	20415	20525	20635	20425	20525	20625
	(Low)	(Mid)	(High)	(Low)	(Mid)	(High)	(Low)	(Mid)	(High)
Frequency (MHz)	824.7	836.5	848.3	825.5	836.5	847.5	826.5	836.5	846.5
Conducted Power (dBm)	21.19	21.52	21.81	21.11	21.62	21.91	21.19	21.52	21.81
Conducted Power (Watts)	0.1315	0.1419	0.1517	0.1291	0.1452	0.1552	0.1315	0.1419	0.1517
ERP(dBm)	15.74	16.07	16.36	15.66	16.17	16.46	15.74	16.07	16.36
ERP(Watts)	0.0375	0.0405	0.0433	0.0368	0.0414	0.0443	0.0375	0.0405	0.0433

LTE Band 5 ( $G_T - L_C = -3.30$ dB) 64QAM			
Bandwidth	10M		
Channel	20450	20525	20600
	(Low)	(Mid)	(High)
Frequency (MHz)	829	836.5	844
Conducted Power (dBm)	21.31	21.62	21.71
Conducted Power (Watts)	0.1352	0.1452	0.1483
ERP(dBm)	15.86	16.17	16.26
ERP(Watts)	0.0385	0.0414	0.0423



< Antenna #2 >

LTE Band 7 (G <sub>T</sub> - L <sub>C</sub> = -2.10 dB) QPSK			
Bandwidth	5M		
Channel	20775	21100	21425
	(Low)	(Mid)	(High)
Frequency	2502.5	2535	2567.5
(MHz)			
Conducted Power (dBm)	22.14	22.07	22.12
Conducted Power (Watts)	0.1637	0.1611	0.1629
EIRP(dBm)	20.04	19.97	20.02
EIRP(Watts)	0.1009	0.0993	0.1005

LTE Band 7 (G <sub>T</sub> - L <sub>C</sub> = -2.10 dB) QPSK									
Bandwidth	10M			15M			20M		
Channel	20800	21100	21400	20825	21100	21375	20850	21100	21350
	(Low)	(Mid)	(High)	(Low)	(Mid)	(High)	(Low)	(Mid)	(Mid)
Frequency	2505	2535	2565	2507.5	2535	2562.5	2510	2535	2560
(MHz)									
Conducted Power (dBm)	22.12	22.07	22.16	22.12	22.09	22.19	22.18	22.22	22.45
Conducted Power (Watts)	0.1629	0.1611	0.1644	0.1629	0.1618	0.1656	0.1652	0.1667	0.1758
EIRP(dBm)	20.02	19.97	20.06	20.02	19.99	20.09	20.08	20.12	20.35
EIRP(Watts)	0.1005	0.0993	0.1014	0.1005	0.0998	0.1021	0.1019	0.1028	0.1084



LTE Band 7 ( $G_T - L_C = -2.10$ dB) 16QAM			
Bandwidth	5M		
Channel	20775	21100	21425
	(Low)	(Mid)	(High)
Frequency	2502.5	2535	2567.5
(MHz)			
Conducted Power (dBm)	22.37	22.37	22.44
Conducted Power (Watts)	0.1726	0.1726	0.1754
EIRP(dBm)	20.27	20.27	20.34
EIRP(Watts)	0.1064	0.1064	0.1081

LTE Band 7 ( $G_T - L_C = -2.10$ dB) 16QAM									
Bandwidth	10M			15M			20M		
Channel	20800	21100	21400	20825	21100	21375	20850	21100	21350
	(Low)	(Mid)	(High)	(Low)	(Mid)	(High)	(Low)	(Mid)	(Mid)
Frequency	2505	2535	2565	2507.5	2535	2562.5	2510	2535	2560
(MHz)									
Conducted Power (dBm)	22.38	22.43	22.43	22.33	22.44	22.32	22.33	22.43	22.42
Conducted Power (Watts)	0.1730	0.1750	0.1750	0.1710	0.1754	0.1706	0.1710	0.1750	0.1746
EIRP(dBm)	20.28	20.33	20.33	20.23	20.34	20.22	20.23	20.33	20.32
EIRP(Watts)	0.1067	0.1079	0.1079	0.1054	0.1081	0.1052	0.1054	0.1079	0.1076



LTE Band 7 ( $G_T - L_C = -2.10$ dB) 64QAM			
Bandwidth	5M		
Channel	20775	21100	21425
	(Low)	(Mid)	(High)
Frequency (MHz)	2502.5	2535	2567.5
	Conducted Power (dBm)	21.27	21.34
Conducted Power (Watts)	0.1340	0.1361	0.1403
EIRP(dBm)	19.17	19.24	19.37
EIRP(Watts)	0.0826	0.0839	0.0865

LTE Band 7 ( $G_T - L_C = -2.10$ dB) 64QAM									
Bandwidth	10M			15M			20M		
Channel	20800	21100	21400	20825	21100	21375	20850	21100	21350
	(Low)	(Mid)	(High)	(Low)	(Mid)	(High)	(Low)	(Mid)	(Mid)
Frequency (MHz)	2505	2535	2565	2507.5	2535	2562.5	2510	2535	2560
	Conducted Power (dBm)	21.24	21.38	21.33	21.23	21.35	21.38	21.19	21.39
Conducted Power (Watts)	0.1330	0.1374	0.1358	0.1327	0.1365	0.1374	0.1315	0.1377	0.1390
EIRP(dBm)	19.14	19.28	19.23	19.13	19.25	19.28	19.09	19.29	19.33
EIRP(Watts)	0.0820	0.0847	0.0838	0.0818	0.0841	0.0847	0.0811	0.0849	0.0857



< Antenna #3>

LTE Band 7 (G <sub>T</sub> - L <sub>C</sub> = -0.50 dB) QPSK			
Bandwidth	5M		
Channel	20775	21100	21425
	(Low)	(Mid)	(High)
Frequency	2502.5	2535	2567.5
(MHz)			
Conducted Power (dBm)	22.14	22.07	22.12
Conducted Power (Watts)	0.1637	0.1611	0.1629
EIRP(dBm)	21.64	21.57	21.62
EIRP(Watts)	0.1459	0.1435	0.1452

LTE Band 7 (G <sub>T</sub> - L <sub>C</sub> = -0.50 dB) QPSK									
Bandwidth	10M			15M			20M		
Channel	20800	21100	21400	20825	21100	21375	20850	21100	21350
	(Low)	(Mid)	(High)	(Low)	(Mid)	(High)	(Low)	(Mid)	(Mid)
Frequency	2505	2535	2565	2507.5	2535	2562.5	2510	2535	2560
(MHz)									
Conducted Power (dBm)	22.12	22.07	22.16	22.12	22.09	22.19	22.18	22.22	22.45
Conducted Power (Watts)	0.1629	0.1611	0.1644	0.1629	0.1618	0.1656	0.1652	0.1667	0.1758
EIRP(dBm)	21.62	21.57	21.66	21.62	21.59	21.69	21.68	21.72	21.95
EIRP(Watts)	0.1452	0.1435	0.1466	0.1452	0.1442	0.1476	0.1472	0.1486	0.1567



LTE Band 7 ( $G_T - L_C = -0.50$ dB) 16QAM			
Bandwidth	5M		
Channel	20775	21100	21425
	(Low)	(Mid)	(High)
Frequency	2502.5	2535	2567.5
(MHz)			
Conducted Power (dBm)	22.37	22.37	22.44
Conducted Power (Watts)	0.1726	0.1726	0.1754
EIRP(dBm)	21.87	21.87	21.94
EIRP(Watts)	0.1538	0.1538	0.1563

LTE Band 7 ( $G_T - L_C = -0.50$ dB) 16QAM									
Bandwidth	10M			15M			20M		
Channel	20800	21100	21400	20825	21100	21375	20850	21100	21350
	(Low)	(Mid)	(High)	(Low)	(Mid)	(High)	(Low)	(Mid)	(Mid)
Frequency	2505	2535	2565	2507.5	2535	2562.5	2510	2535	2560
(MHz)									
Conducted Power (dBm)	22.38	22.43	22.43	22.33	22.44	22.32	22.33	22.43	22.42
Conducted Power (Watts)	0.1730	0.1750	0.1750	0.1710	0.1754	0.1706	0.1710	0.1750	0.1746
EIRP(dBm)	21.88	21.93	21.93	21.83	21.94	21.82	21.83	21.93	21.92
EIRP(Watts)	0.1542	0.1560	0.1560	0.1524	0.1563	0.1521	0.1524	0.1560	0.1556





LTE Band 7 ( $G_T - L_C = -0.50$ dB) 64QAM			
Bandwidth	5M		
Channel	20775	21100	21425
	(Low)	(Mid)	(High)
Frequency (MHz)	2502.5	2535	2567.5
	Conducted Power (dBm)	21.27	21.34
Conducted Power (Watts)	0.1340	0.1361	0.1403
EIRP(dBm)	20.77	20.84	20.97
EIRP(Watts)	0.1194	0.1213	0.1250

LTE Band 7 ( $G_T - L_C = -0.50$ dB) 64QAM									
Bandwidth	10M			15M			20M		
Channel	20800	21100	21400	20825	21100	21375	20850	21100	21350
	(Low)	(Mid)	(High)	(Low)	(Mid)	(High)	(Low)	(Mid)	(Mid)
Frequency (MHz)	2505	2535	2565	2507.5	2535	2562.5	2510	2535	2560
	Conducted Power (dBm)	21.24	21.38	21.33	21.23	21.35	21.38	21.19	21.39
Conducted Power (Watts)	0.1330	0.1374	0.1358	0.1327	0.1365	0.1374	0.1315	0.1377	0.1390
EIRP(dBm)	20.74	20.88	20.83	20.73	20.85	20.88	20.69	20.89	20.93
EIRP(Watts)	0.1186	0.1225	0.1211	0.1183	0.1216	0.1225	0.1172	0.1227	0.1239



LTE Band 12 (G <sub>T</sub> - L <sub>C</sub> = -3.30 dB) QPSK									
Bandwidth	1.4M			3M			5M		
Channel	23017	23095	23173	23025	23095	23165	23035	23095	23155
	(Low)	(Mid)	(High)	(Low)	(Mid)	(High)	(Low)	(Mid)	(High)
Frequency (MHz)	699.7	707.5	715.3	700.5	707.5	714.5	701.5	707.5	713.5
Conducted Power (dBm)	22.82	23.27	23.19	22.89	23.28	23.18	23.13	23.30	23.22
Conducted Power (Watts)	0.1914	0.2123	0.2084	0.1945	0.2128	0.2080	0.2056	0.2138	0.2099
ERP(dBm)	17.37	17.82	17.74	17.44	17.83	17.73	17.68	17.85	17.77
ERP(Watts)	0.0546	0.0605	0.0594	0.0555	0.0607	0.0593	0.0586	0.0610	0.0598

LTE Band 12 (G <sub>T</sub> - L <sub>C</sub> = -3.30 dB) QPSK			
Bandwidth	10M		
Channel	23060	23095	23130
	(Low)	(Mid)	(High)
Frequency (MHz)	704	707.5	711
Conducted Power (dBm)	23.31	23.31	23.37
Conducted Power (Watts)	0.2143	0.2143	0.2173
ERP(dBm)	17.86	17.86	17.92
ERP(Watts)	0.0611	0.0611	0.0619



LTE Band 12 ( $G_T - L_C = -3.30$ dB) 16QAM									
Bandwidth	1.4M			3M			5M		
Channel	23017	23095	23173	23025	23095	23165	23035	23095	23155
	(Low)	(Mid)	(High)	(Low)	(Mid)	(High)	(Low)	(Mid)	(High)
Frequency (MHz)	699.7	707.5	715.3	700.5	707.5	714.5	701.5	707.5	713.5
Conducted Power (dBm)	22.15	22.75	22.63	22.28	22.73	22.61	22.33	22.75	22.66
Conducted Power (Watts)	0.1641	0.1884	0.1832	0.1690	0.1875	0.1824	0.1710	0.1884	0.1845
ERP(dBm)	16.70	17.30	17.18	16.83	17.28	17.16	16.88	17.30	17.21
ERP(Watts)	0.0468	0.0537	0.0522	0.0482	0.0535	0.0520	0.0488	0.0537	0.0526

LTE Band 12 ( $G_T - L_C = -3.30$ dB) 16QAM			
Bandwidth	10M		
Channel	23060	23095	23130
	(Low)	(Mid)	(High)
Frequency (MHz)	704	707.5	711
Conducted Power (dBm)	22.79	22.70	22.78
Conducted Power (Watts)	0.1901	0.1862	0.1897
ERP(dBm)	17.34	17.25	17.33
ERP(Watts)	0.0542	0.0531	0.0541



LTE Band 12 (G <sub>T</sub> - L <sub>C</sub> = -3.30 dB) 64QAM									
Bandwidth	1.4M			3M			5M		
Channel	23017	23095	23173	23025	23095	23165	23035	23095	23155
	(Low)	(Mid)	(High)	(Low)	(Mid)	(High)	(Low)	(Mid)	(High)
Frequency (MHz)	699.7	707.5	715.3	700.5	707.5	714.5	701.5	707.5	713.5
Conducted Power (dBm)	21.73	21.70	21.97	21.77	21.85	21.98	21.82	21.94	22.00
Conducted Power (Watts)	0.1489	0.1479	0.1574	0.1503	0.1531	0.1578	0.1521	0.1563	0.1585
ERP(dBm)	16.28	16.25	16.52	16.32	16.40	16.53	16.37	16.49	16.55
ERP(Watts)	0.0425	0.0422	0.0449	0.0429	0.0437	0.0450	0.0434	0.0446	0.0452

LTE Band 12 (G <sub>T</sub> - L <sub>C</sub> = -3.30 dB) 64QAM			
Bandwidth	10M		
Channel	23060	23095	23130
	(Low)	(Mid)	(High)
Frequency (MHz)	704	707.5	711
Conducted Power (dBm)	21.85	21.92	21.98
Conducted Power (Watts)	0.1531	0.1556	0.1578
ERP(dBm)	16.40	16.47	16.53
ERP(Watts)	0.0437	0.0444	0.0450



LTE Band 17 (G <sub>T</sub> - L <sub>C</sub> = -3.30 dB) QPSK						
Bandwidth	5M			10M		
Channel	23755	23790	23825	23780	23790	23800
	(Low)	(Mid)	(High)	(Low)	(Mid)	(High)
Frequency	706.5	710	713.5	709	710	711
(MHz)						
Conducted Power (dBm)	23.37	23.41	23.38	23.42	23.41	23.43
Conducted Power (Watts)	0.2173	0.2193	0.2178	0.2198	0.2193	0.2203
ERP(dBm)	17.92	17.96	17.93	17.97	17.96	17.98
ERP(Watts)	0.0619	0.0625	0.0621	0.0627	0.0625	0.0628

LTE Band 17 (G <sub>T</sub> - L <sub>C</sub> = -3.30 dB) 16QAM						
Bandwidth	5M			10M		
Channel	23755	23790	23825	23780	23790	23800
	(Low)	(Mid)	(High)	(Low)	(Mid)	(High)
Frequency	706.5	710	713.5	709	710	711
(MHz)						
Conducted Power (dBm)	22.94	22.82	22.79	22.83	22.79	22.90
Conducted Power (Watts)	0.1968	0.1914	0.1901	0.1919	0.1901	0.1950
ERP(dBm)	17.49	17.37	17.34	17.38	17.34	17.45
ERP(Watts)	0.0561	0.0546	0.0542	0.0547	0.0542	0.0556



LTE Band 17 (G <sub>T</sub> - L <sub>C</sub> = -3.30 dB) 64QAM						
Bandwidth	5M			10M		
Channel	23755	23790	23825	23780	23790	23800
	(Low)	(Mid)	(High)	(Low)	(Mid)	(High)
Frequency	706.5	710	713.5	709	710	711
(MHz)						
Conducted Power (dBm)	21.94	21.95	21.90	21.84	21.85	21.91
Conducted Power (Watts)	0.1563	0.1567	0.1549	0.1528	0.1531	0.1552
ERP(dBm)	16.49	16.50	16.45	16.39	16.40	16.46
ERP(Watts)	0.0446	0.0447	0.0442	0.0436	0.0437	0.0443



### Peak-to-Average Ratio

Mode	LTE Band 2 / 20MHz				
Mod.	QPSK		16QAM		Limit: 13dB
RB Size	1RB	Full RB	1RB	Full RB	Result
Lowest CH	3.48	4.38	5.07	5.59	PASS
Middle CH	3.45	4.49	4.99	5.74	
Highest CH	3.57	4.38	5.25	5.59	
Mod.	64QAM		Limit: 13dB		
RB Size	1RB	Full RB	Result		
Lowest CH	6.75	6.26	PASS		
Middle CH	6.61	6.43			
Highest CH	6.93	6.17			

Mode	LTE Band 4 / 20MHz				
Mod.	QPSK		16QAM		Limit: 13dB
RB Size	1RB	Full RB	1RB	Full RB	Result
Lowest CH	3.54	4.46	5.16	5.88	PASS
Middle CH	3.45	4.43	5.36	5.80	
Highest CH	3.42	4.61	5.07	5.88	
Mod.	64QAM		Limit: 13dB		
RB Size	1RB	Full RB	Result		
Lowest CH	5.04	5.86	PASS		
Middle CH	5.19	5.80			
Highest CH	5.13	5.91			

Mode	LTE Band 5 / 10MHz				
Mod.	QPSK		16QAM		Limit: 13dB
RB Size	1RB	Full RB	1RB	Full RB	Result
Lowest CH	3.88	4.93	5.51	6.17	PASS
Middle CH	3.77	4.81	5.62	6.00	
Highest CH	3.71	4.70	5.13	6.00	
Mod.	64QAM		Limit: 13dB		
RB Size	1RB	Full RB	Result		
Lowest CH	6.43	6.58	PASS		
Middle CH	6.41	6.67			
Highest CH	6.58	6.58			



Mode	LTE Band 7 / 20MHz				
Mod.	QPSK		16QAM		Limit: 13dB
RB Size	1RB	Full RB	1RB	Full RB	Result
Lowest CH	3.45	4.41	4.84	5.65	PASS
Middle CH	3.45	4.23	5.07	5.62	
Highest CH	3.57	4.38	5.04	5.65	
Mod.	64QAM		Limit: 13dB		
RB Size	1RB	Full RB	Result		
Lowest CH	5.77	6.17	PASS		
Middle CH	6.29	6.14			
Highest CH	6.35	6.26			

Mode	LTE Band 12 / 10MHz				
Mod.	QPSK		16QAM		Limit: 13dB
RB Size	1RB	Full RB	1RB	Full RB	Result
Lowest CH	3.59	4.99	5.25	6.20	PASS
Middle CH	3.71	4.99	5.42	6.26	
Highest CH	3.97	4.70	5.62	6.03	
Mod.	64QAM		Limit: 13dB		
RB Size	1RB	Full RB	Result		
Lowest CH	6.17	6.72	PASS		
Middle CH	6.49	6.67			
Highest CH	6.78	6.70			

Mode	LTE Band 17 / 10MHz				
Mod.	QPSK		16QAM		Limit: 13dB
RB Size	1RB	Full RB	1RB	Full RB	Result
Lowest CH	3.91	4.84	5.45	6.17	PASS
Middle CH	3.97	4.75	6.09	6.06	
Highest CH	4.00	4.72	5.48	6.09	
Mod.	64QAM		Limit: 13dB		
RB Size	1RB	Full RB	Result		
Lowest CH	5.62	6.17	PASS		
Middle CH	5.71	6.12			
Highest CH	5.74	6.14			





LTE Band 2 / 20MHz / QPSK

Lowest Channel / 1RB

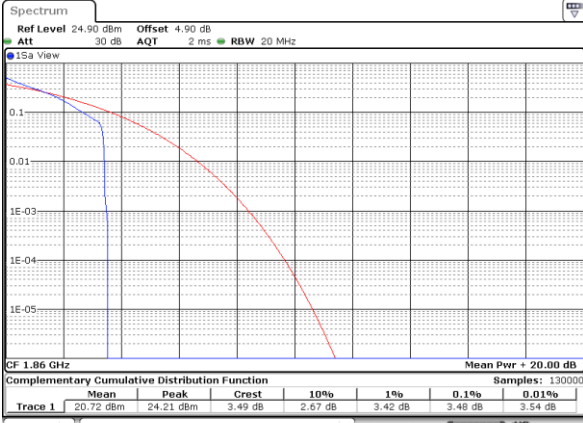

Date: 1 JAN 2018 14:30:21

Lowest Channel / Full RB

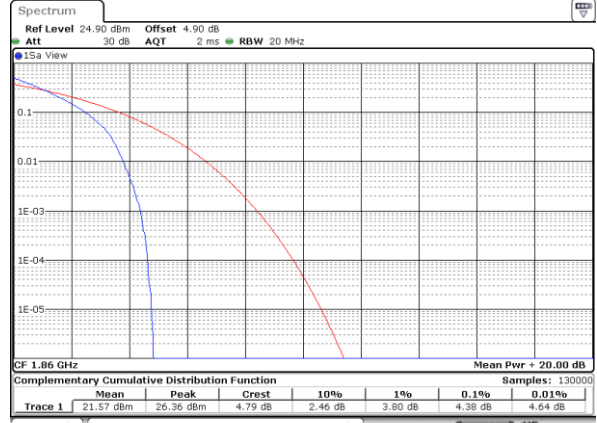

Date: 1 JAN 2018 14:30:05

Middle Channel / 1RB

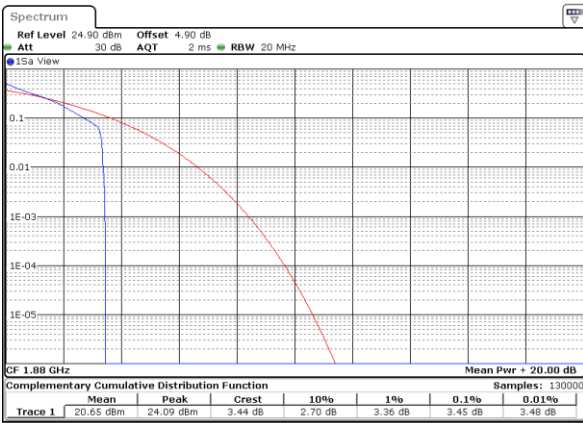

Date: 1 JAN 2018 14:30:52

Middle Channel / Full RB



Date: 1 JAN 2018 14:31:13

Highest Channel / 1RB

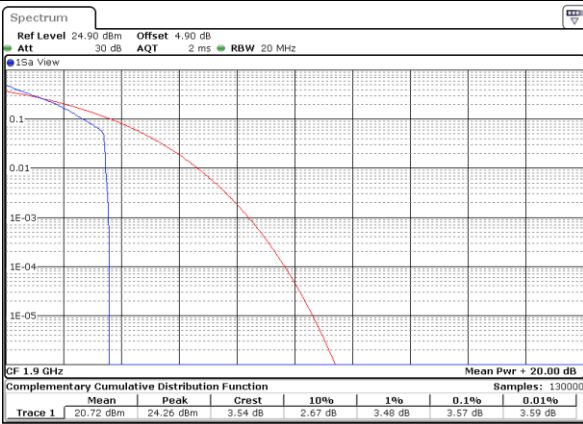

Date: 1 JAN 2018 14:32:01

Highest Channel / Full RB

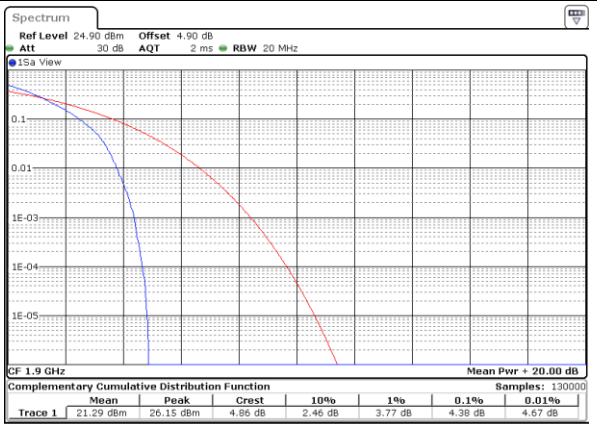

Date: 1 JAN 2018 14:31:33



LTE Band 2 / 20MHz / 16QAM

Lowest Channel / 1RB

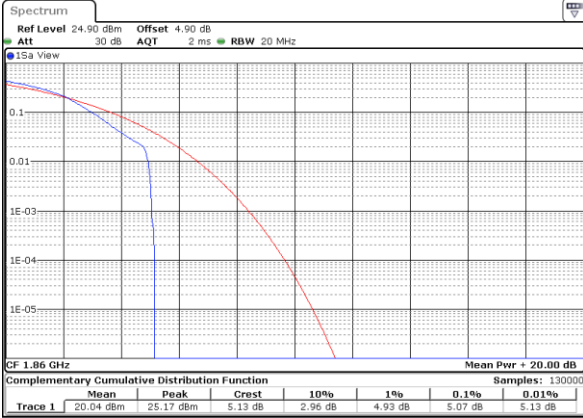

Date: 1 JAN 2018 14:22:15

Lowest Channel / Full RB

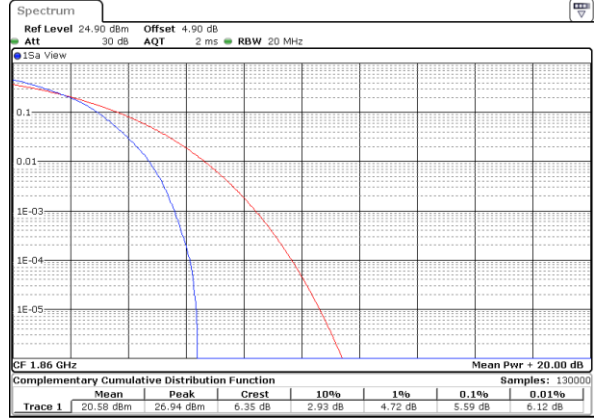

Date: 1 JAN 2018 14:22:46

Middle Channel / 1RB



Date: 1 JAN 2018 14:22:56

Middle Channel / Full RB

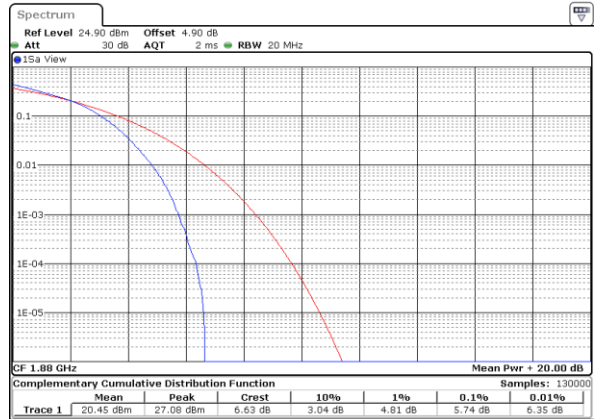

Date: 1 JAN 2018 14:23:06

Highest Channel / 1RB

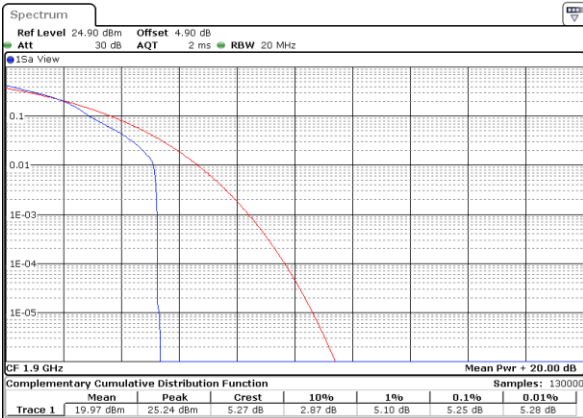

Date: 1 JAN 2018 14:23:15

Highest Channel / Full RB

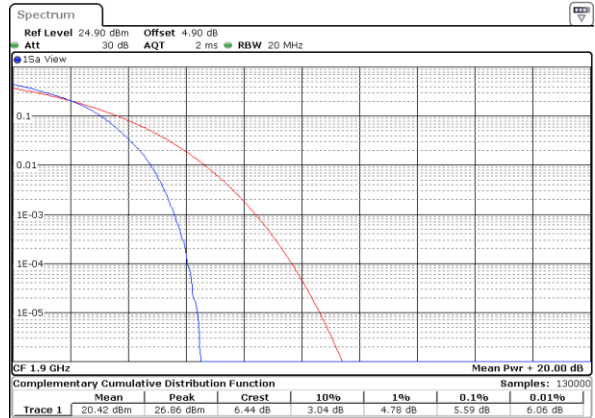

Date: 1 JAN 2018 14:23:25



LTE Band 2 / 20MHz / 64QAM

Lowest Channel / 1RB

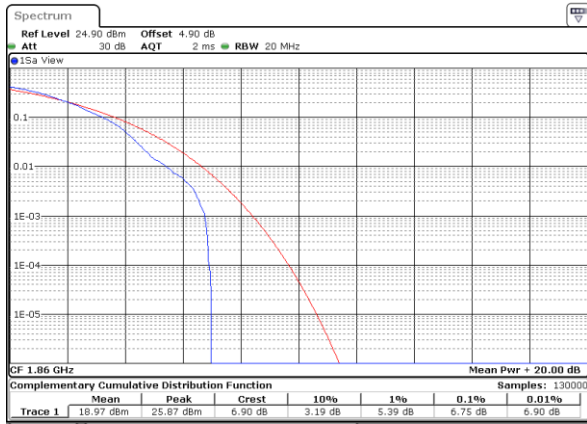

Date: 1 JAN 2018 15:44:03

Lowest Channel / Full RB

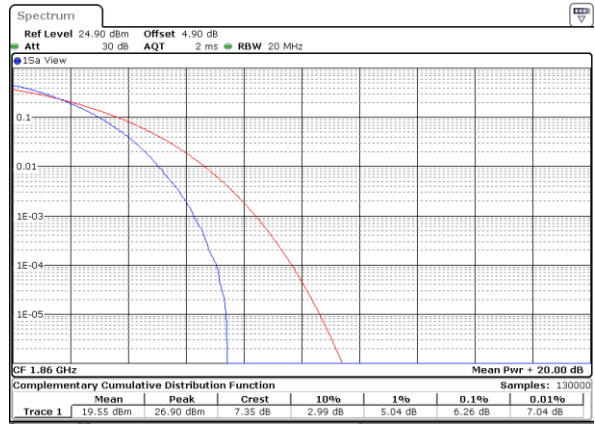

Date: 1 JAN 2018 15:44:16

Middle Channel / 1RB

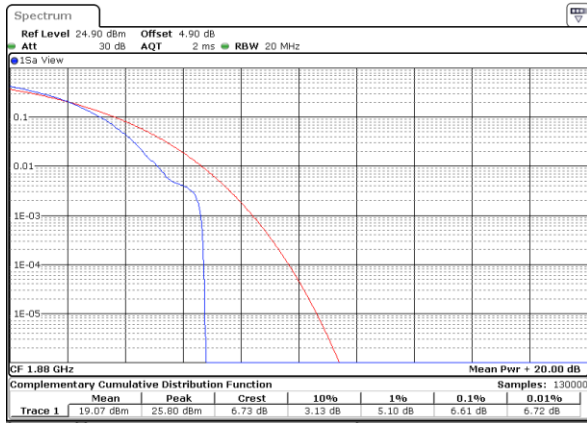

Date: 1 JAN 2018 15:44:45

Middle Channel / Full RB

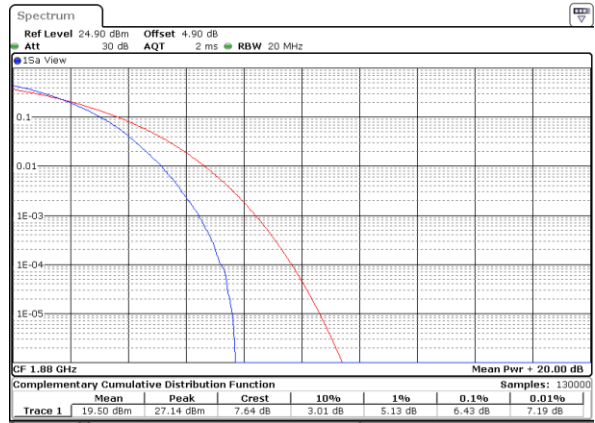

Date: 1 JAN 2018 15:44:33

Highest Channel / 1RB



Date: 1 JAN 2018 15:44:57

Highest Channel / Full RB



Date: 1 JAN 2018 15:45:11



LTE Band 4 / 20MHz / QPSK

Lowest Channel / 1RB

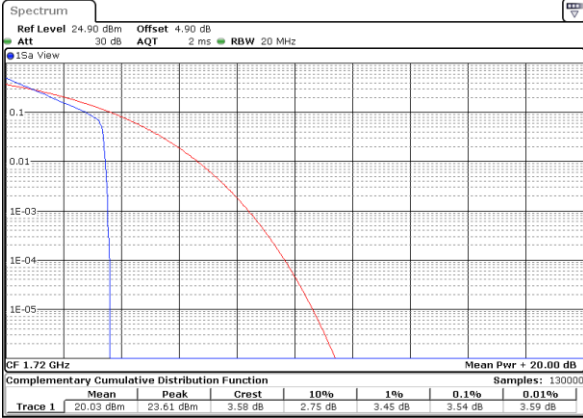

Date: 4 JAN 2018 16:28:41

Lowest Channel / Full RB

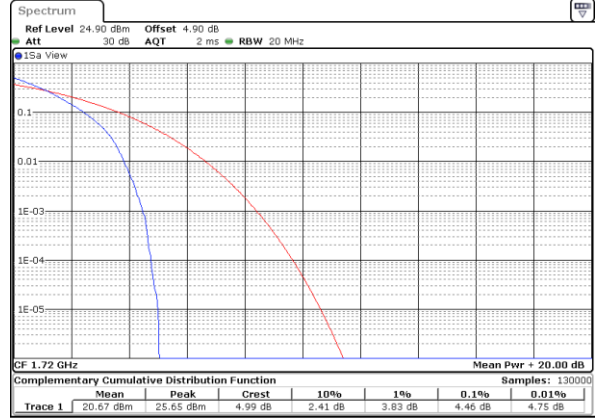

Date: 4 JAN 2018 16:28:52

Middle Channel / 1RB

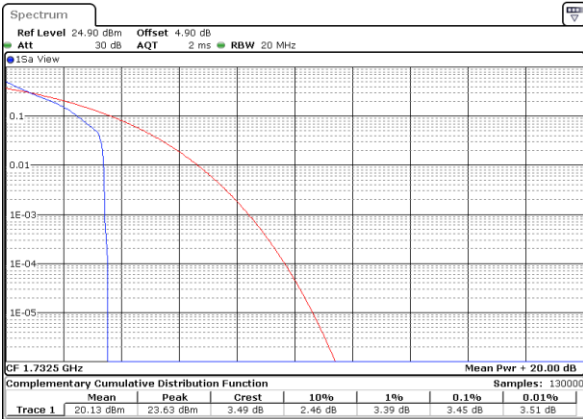

Date: 4 JAN 2018 16:29:09

Middle Channel / Full RB

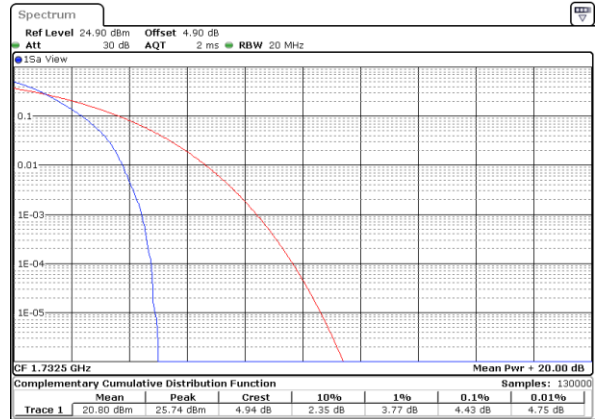

Date: 4 JAN 2018 16:29:27

Highest Channel / 1RB

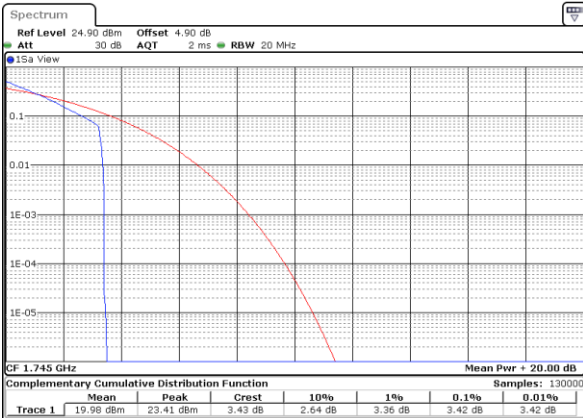

Date: 4 JAN 2018 16:29:41

Highest Channel / Full RB

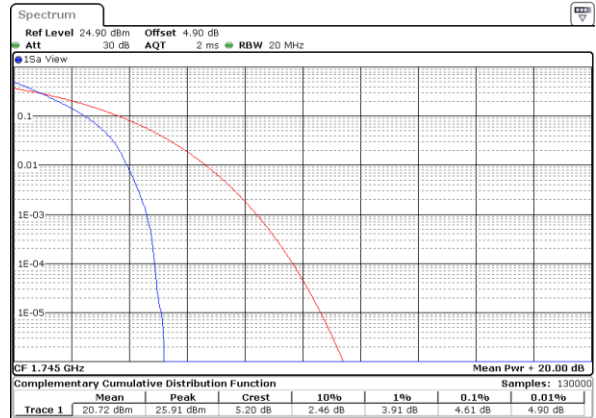

Date: 4 JAN 2018 16:30:06



LTE Band 4 / 20MHz / 16QAM

Lowest Channel / 1RB

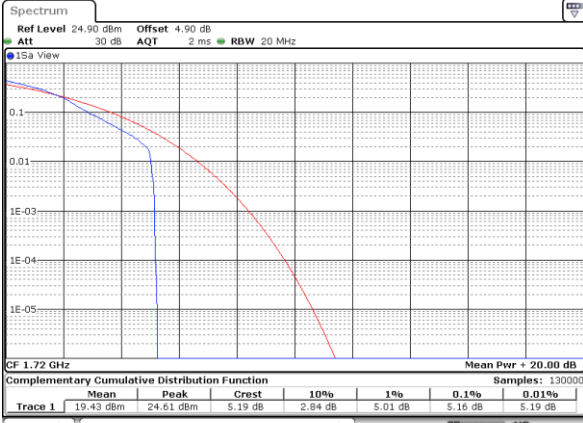

Date: 4 JAN 2018 16:27:08

Lowest Channel / Full RB

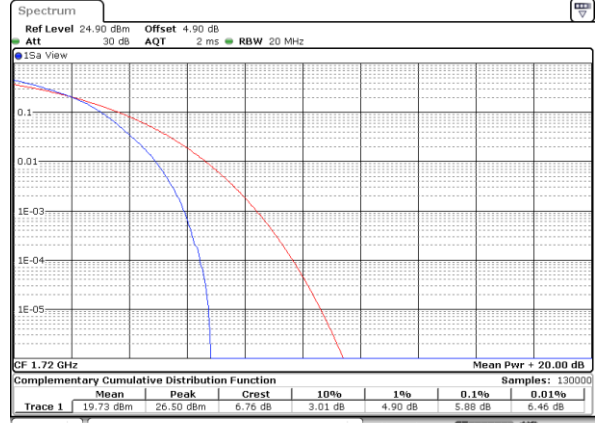

Date: 4 JAN 2018 16:27:23

Middle Channel / 1RB

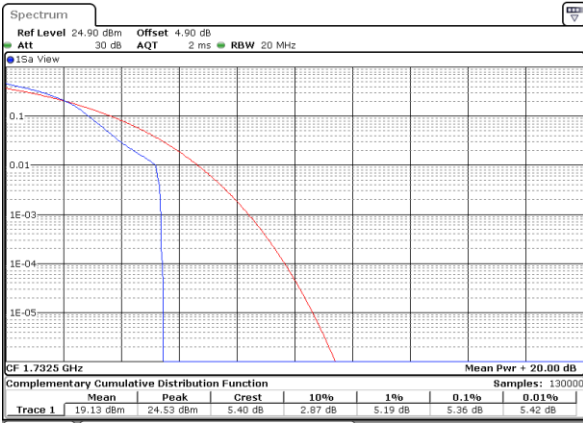

Date: 4 JAN 2018 16:27:36

Middle Channel / Full RB

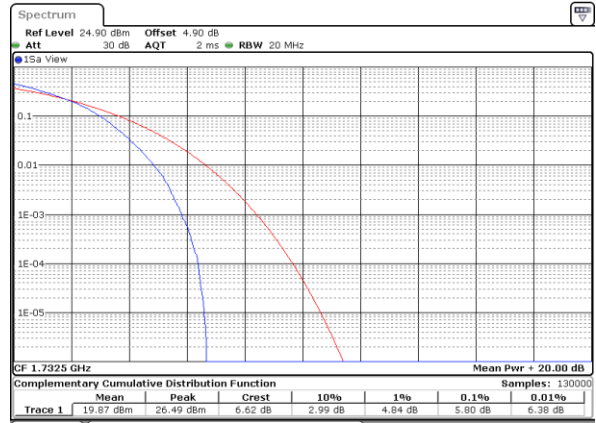

Date: 4 JAN 2018 16:27:48

Highest Channel / 1RB

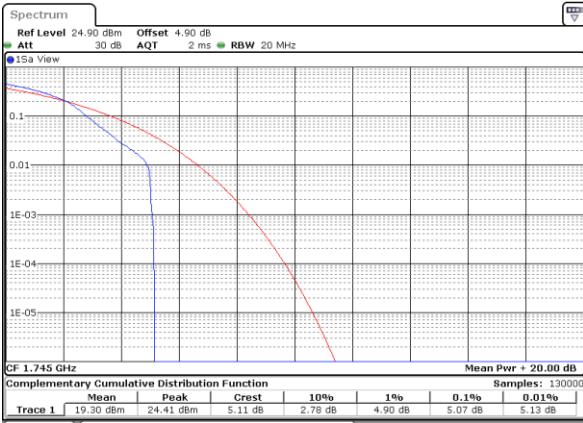

Date: 4 JAN 2018 16:28:12

Highest Channel / Full RB

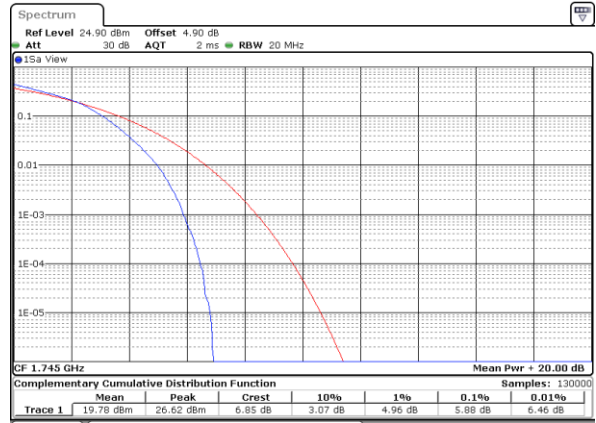

Date: 4 JAN 2018 16:28:24



LTE Band 4 / 20MHz / 64QAM

Lowest Channel / 1RB

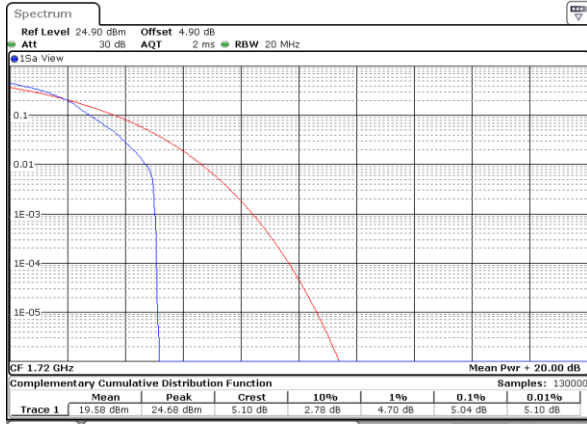

Date: 4 JAN 2018 18:18:42

Lowest Channel / Full RB

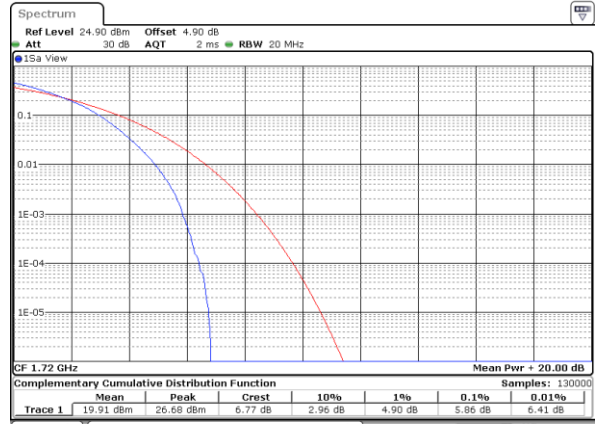

Date: 4 JAN 2018 18:18:53

Middle Channel / 1RB

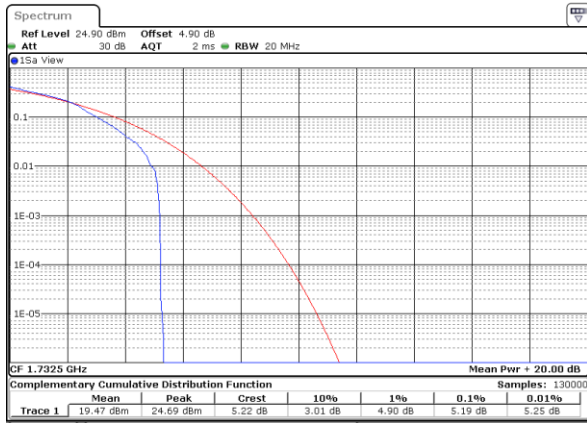

Date: 4 JAN 2018 18:19:03

Middle Channel / Full RB

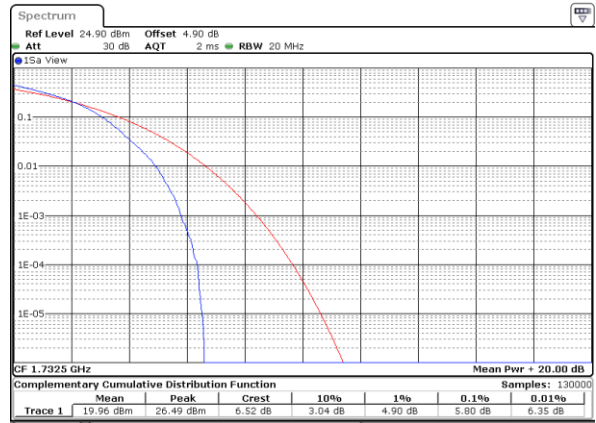

Date: 4 JAN 2018 18:19:13

Highest Channel / 1RB



Date: 4 JAN 2018 18:19:24

Highest Channel / Full RB

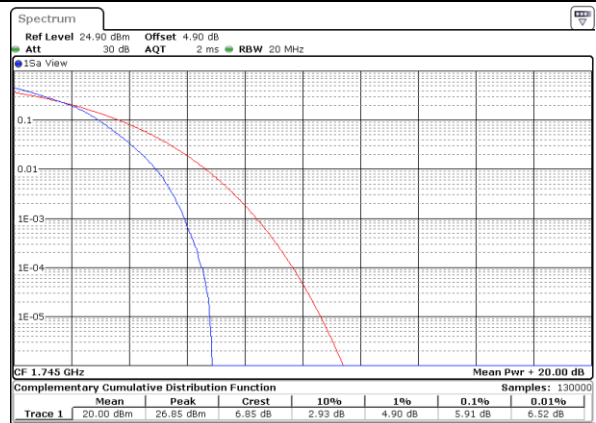

Date: 4 JAN 2018 18:19:36



LTE Band 5 / 10MHz / QPSK

Lowest Channel / 1RB

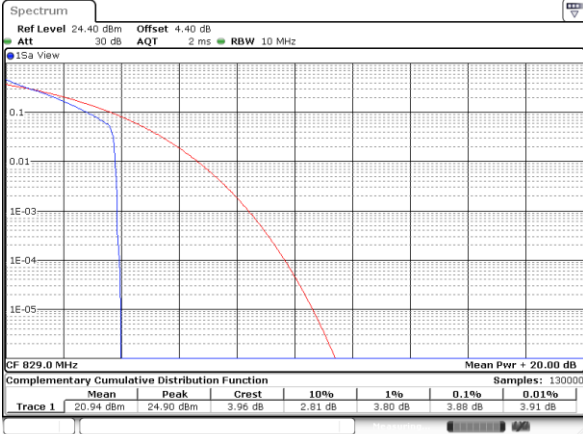

Date: 6 JAN 2018 13:04:50

Lowest Channel / Full RB

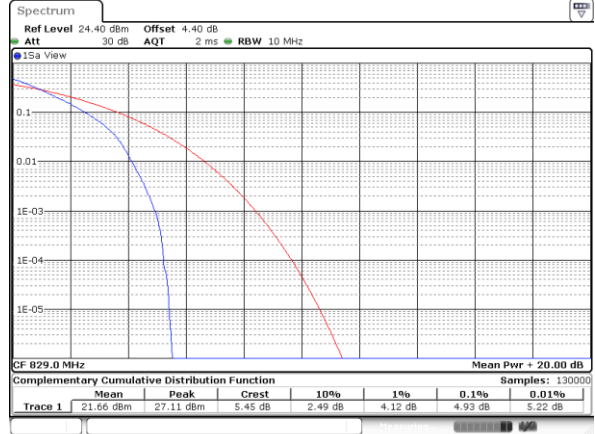

Date: 6 JAN 2018 13:05:03

Middle Channel / 1RB

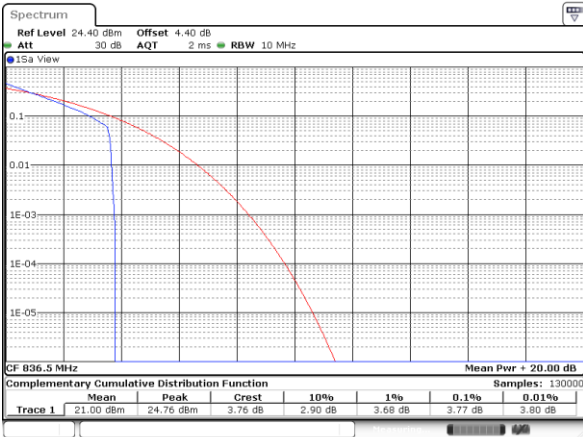

Date: 6 JAN 2018 13:05:29

Middle Channel / Full RB

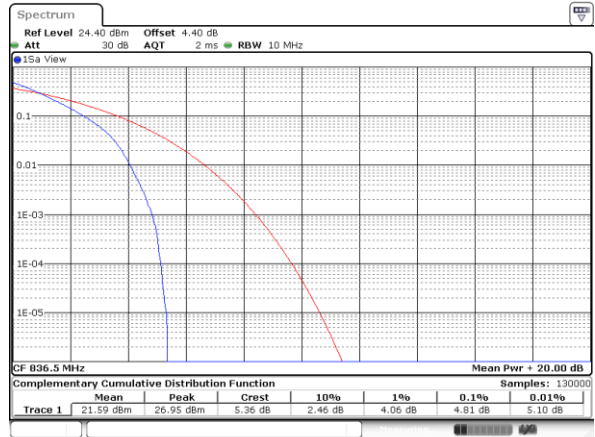

Date: 6 JAN 2018 13:05:16

Highest Channel / 1RB

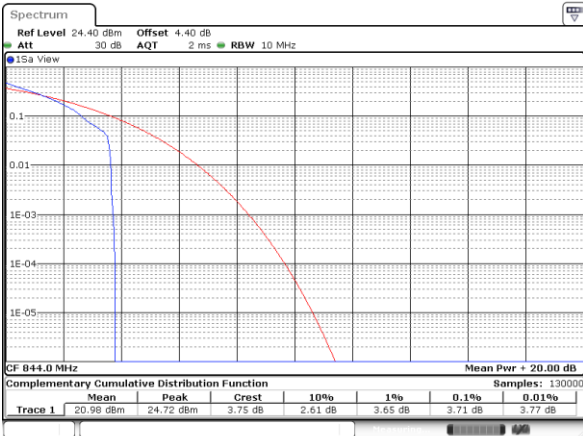

Date: 6 JAN 2018 13:05:45

Highest Channel / Full RB

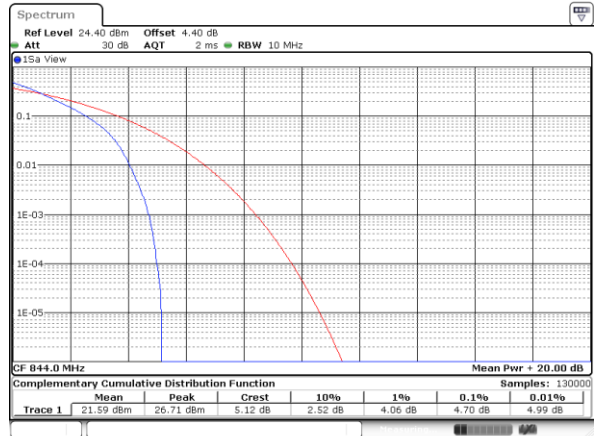

Date: 6 JAN 2018 13:05:59



LTE Band 5 / 10MHz / 16QAM

Lowest Channel / 1RB

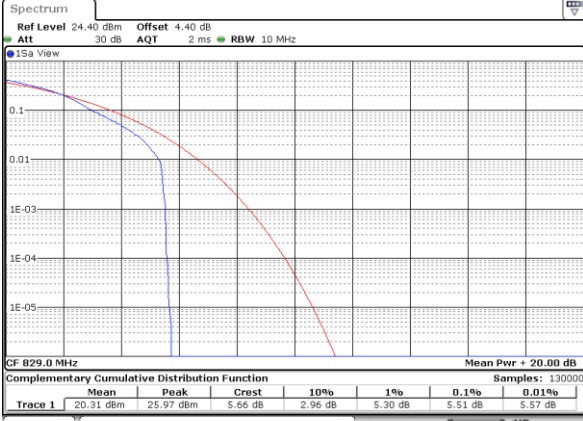

Date: 6 JAN 2018 13:02:56

Lowest Channel / Full RB

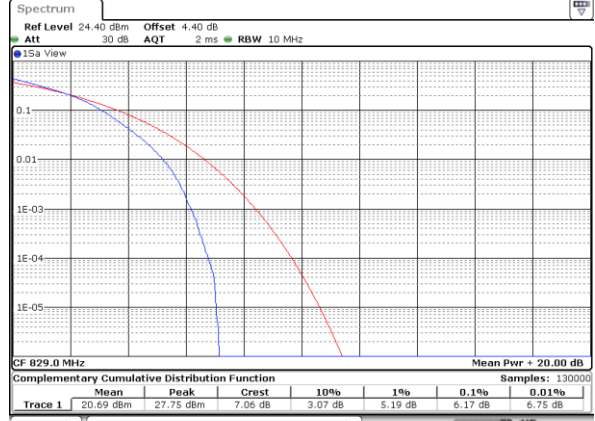

Date: 6 JAN 2018 13:03:06

Middle Channel / 1RB



Date: 6 JAN 2018 13:03:47

Middle Channel / Full RB

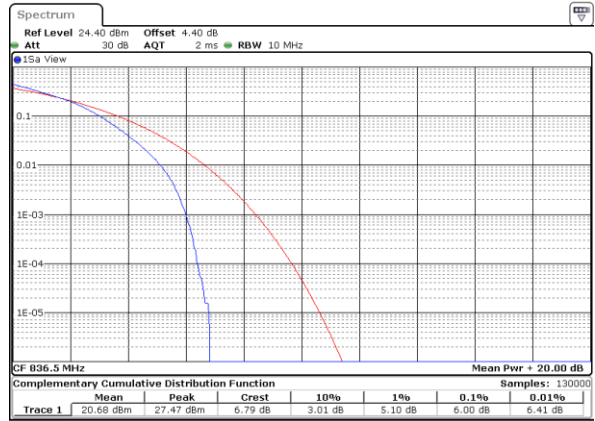

Date: 6 JAN 2018 13:03:58

Highest Channel / 1RB

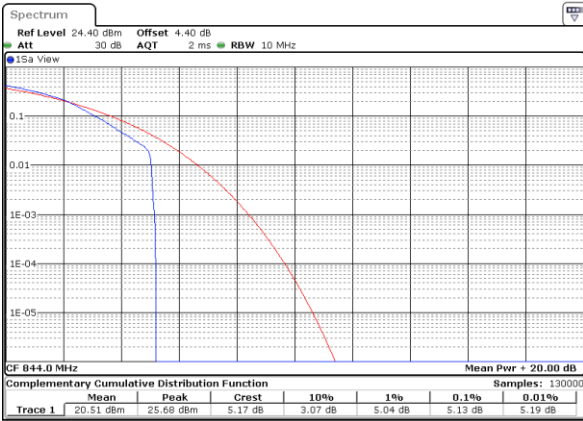

Date: 6 JAN 2018 13:04:08

Highest Channel / Full RB

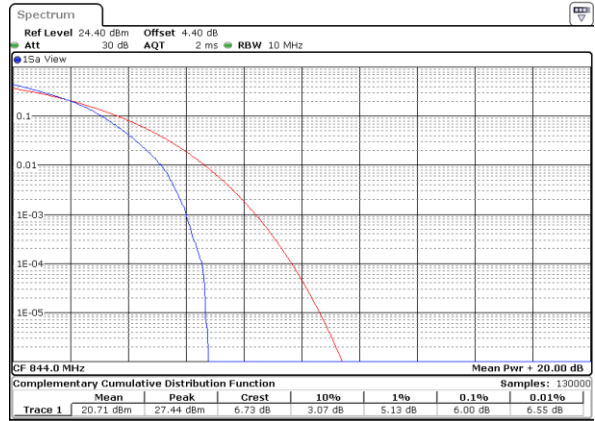

Date: 6 JAN 2018 13:04:24





LTE Band 5 / 10MHz / 64QAM

Lowest Channel / 1RB

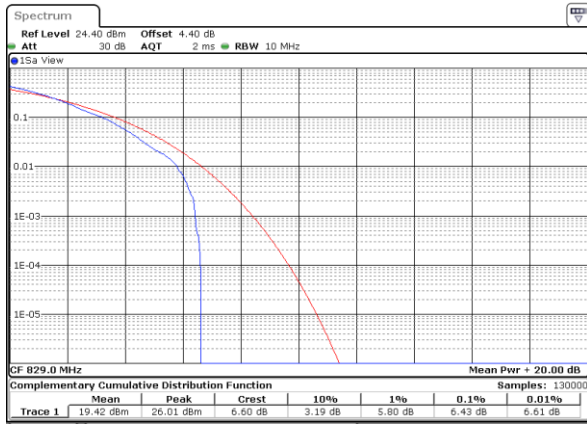

Date: 6 JAN 2018 14:07:21

Lowest Channel / Full RB

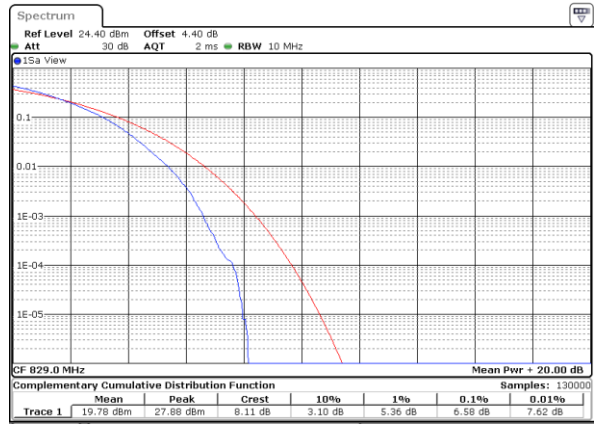

Date: 6 JAN 2018 14:07:48

Middle Channel / 1RB

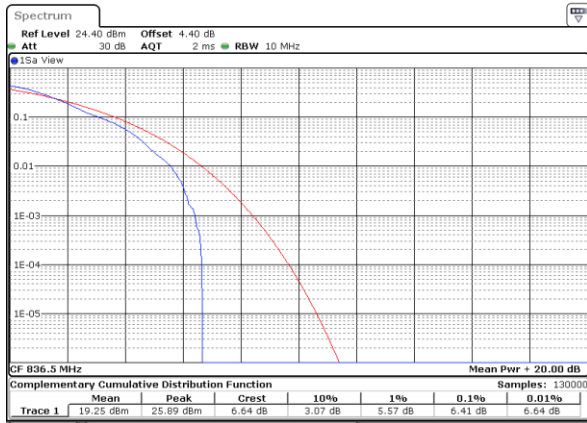

Date: 6 JAN 2018 14:08:32

Middle Channel / Full RB

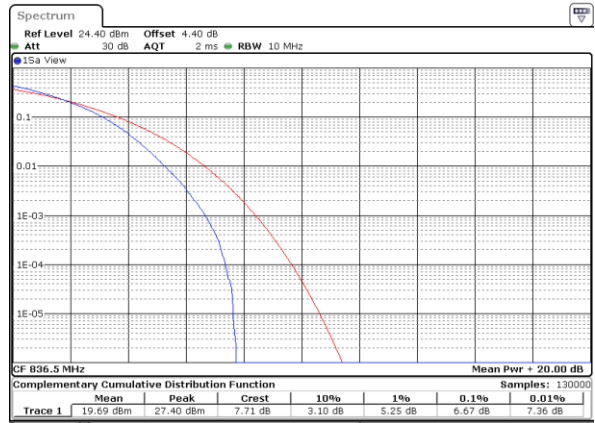

Date: 6 JAN 2018 14:08:02

Highest Channel / 1RB



Date: 6 JAN 2018 14:09:01

Highest Channel / Full RB



Date: 6 JAN 2018 14:09:14



LTE Band 7 / 20MHz / QPSK

Lowest Channel / 1RB

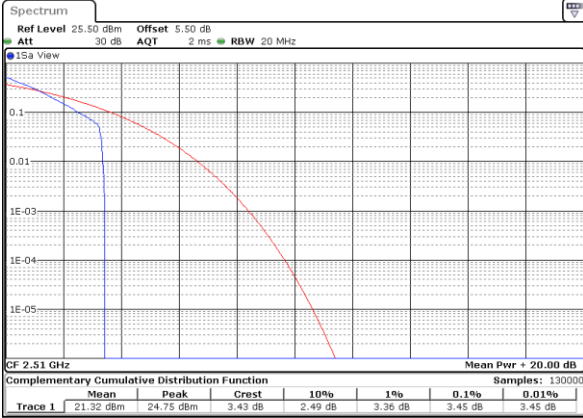

Date: 6 JAN 2018 10:19:41

Lowest Channel / Full RB

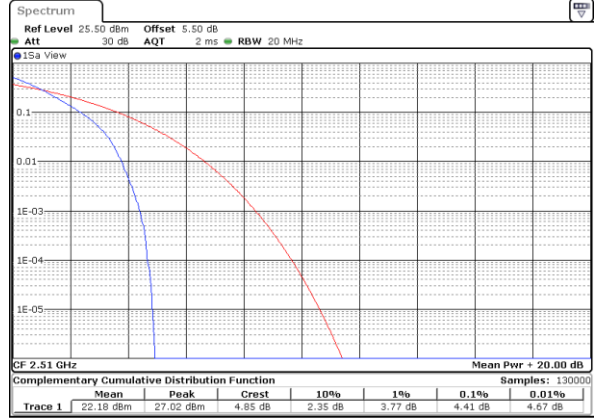

Date: 6 JAN 2018 10:19:52

Middle Channel / 1RB

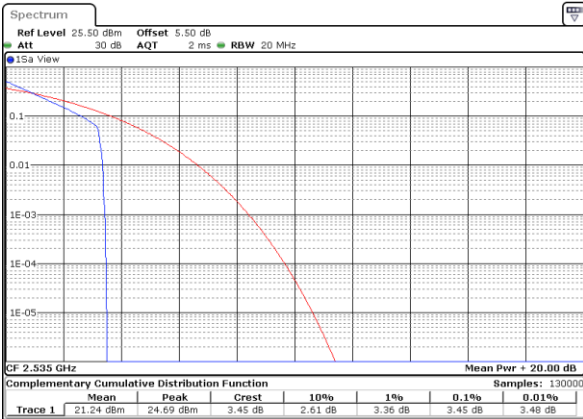

Date: 6 JAN 2018 10:20:35

Middle Channel / Full RB

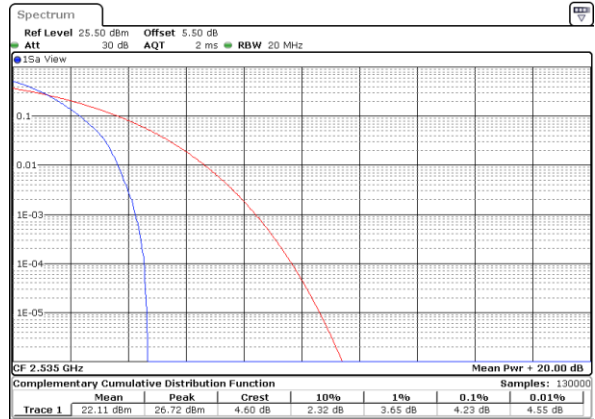

Date: 6 JAN 2018 10:20:25

Highest Channel / 1RB

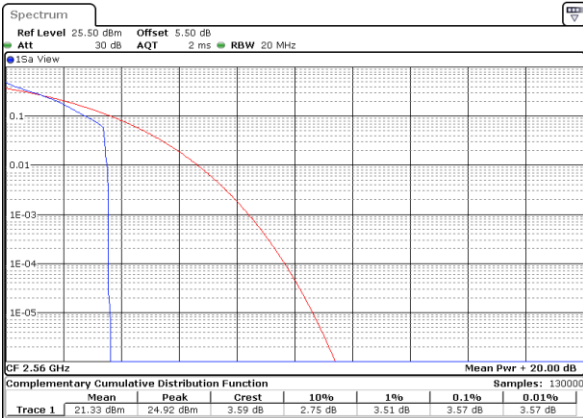

Date: 6 JAN 2018 10:21:06

Highest Channel / Full RB

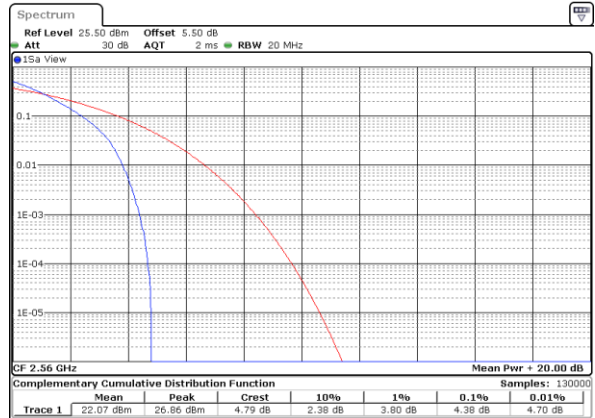

Date: 6 JAN 2018 10:21:16



LTE Band 7 / 20MHz / 16QAM

Lowest Channel / 1RB

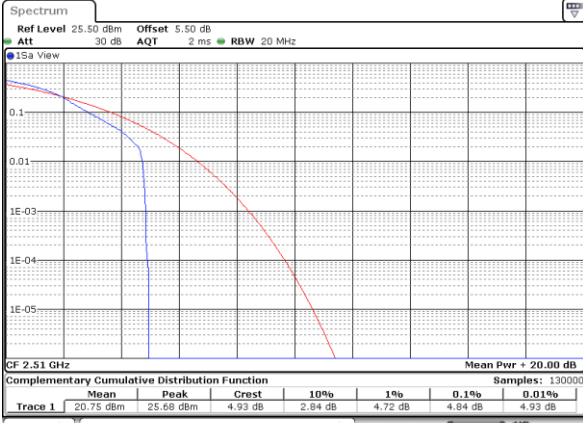

Date: 6 JAN 2018 10:19:31

Lowest Channel / Full RB

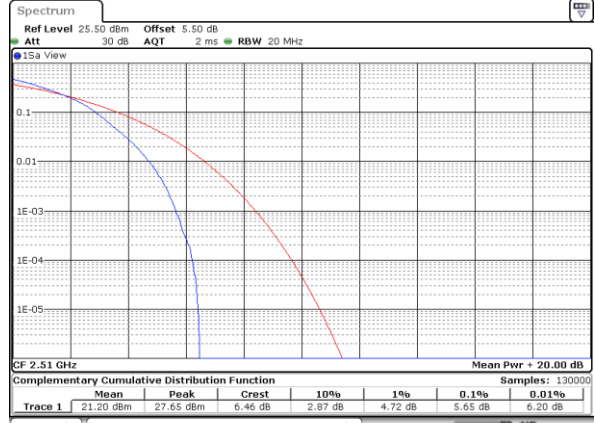

Date: 6 JAN 2018 10:20:03

Middle Channel / 1RB

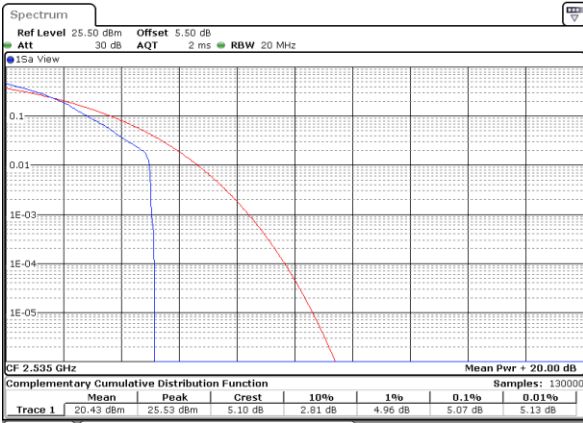

Date: 6 JAN 2018 10:20:45

Middle Channel / Full RB

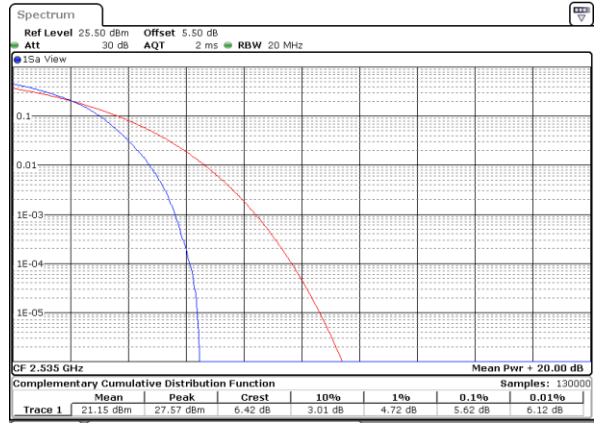

Date: 6 JAN 2018 10:20:14

Highest Channel / 1RB

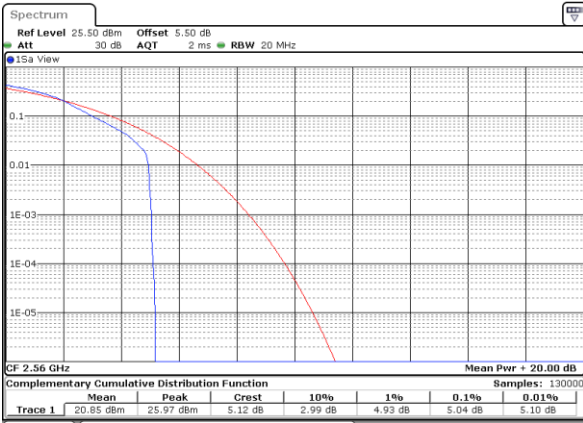

Date: 6 JAN 2018 10:20:56

Highest Channel / Full RB

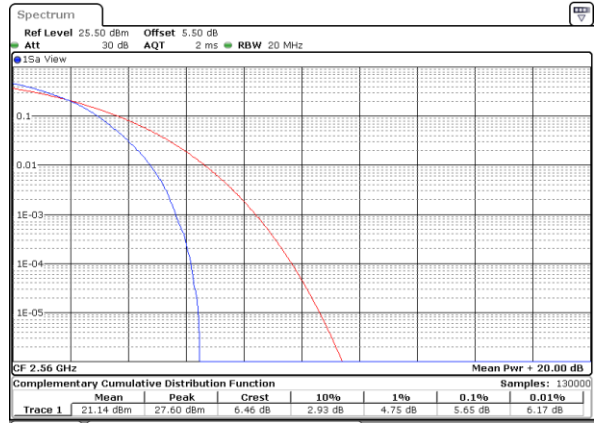

Date: 6 JAN 2018 10:21:26



LTE Band 7 / 20MHz / 64QAM

Lowest Channel / 1RB

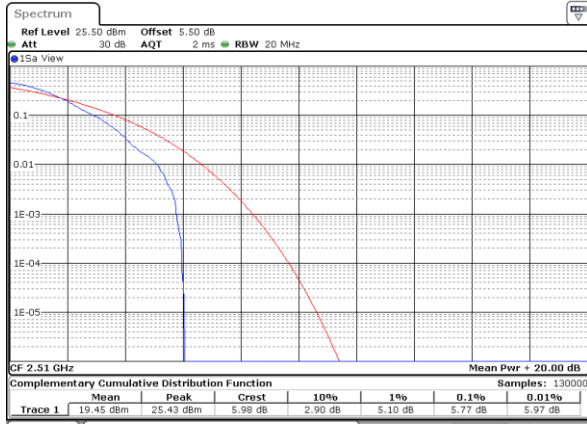

Date: 6 JAN 2018 11:27:27

Lowest Channel / Full RB

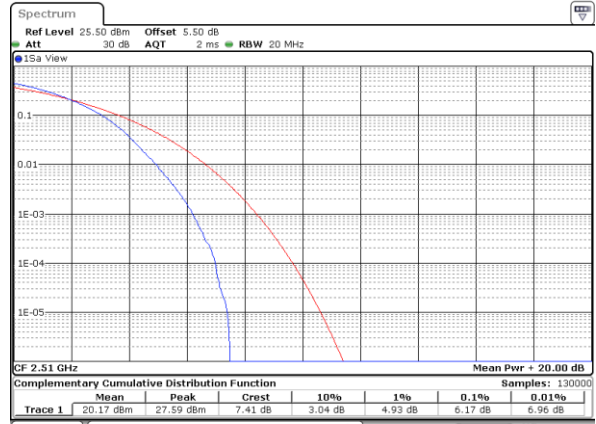

Date: 6 JAN 2018 11:28:13

Middle Channel / 1RB

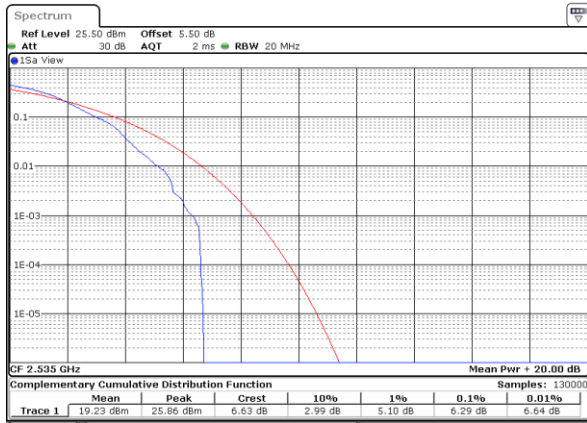

Date: 6 JAN 2018 11:29:05

Middle Channel / Full RB

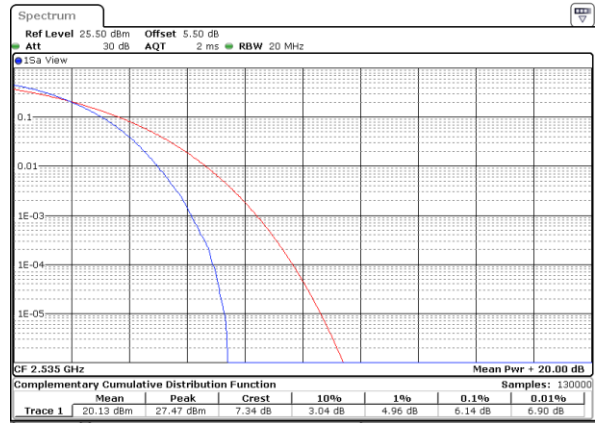

Date: 6 JAN 2018 11:28:39

Highest Channel / 1RB



Date: 6 JAN 2018 11:29:55

Highest Channel / Full RB



Date: 6 JAN 2018 11:30:09



LTE Band 12 / 10MHz / QPSK

Lowest Channel / 1RB

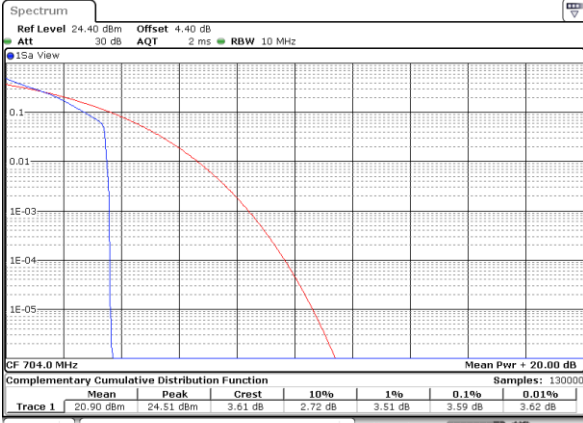

Date: 6 JAN 2018 15:51:30

Lowest Channel / Full RB

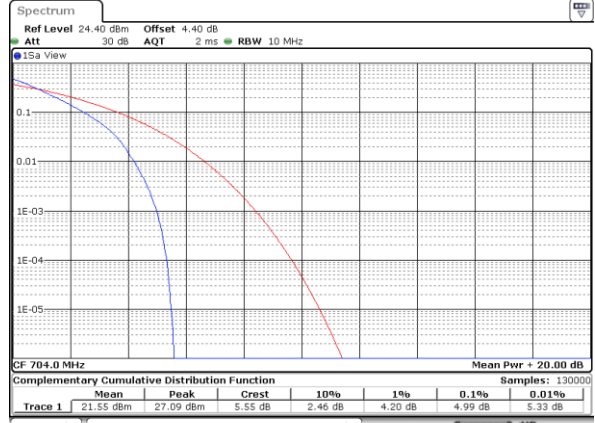

Date: 6 JAN 2018 15:53:42

Middle Channel / 1RB

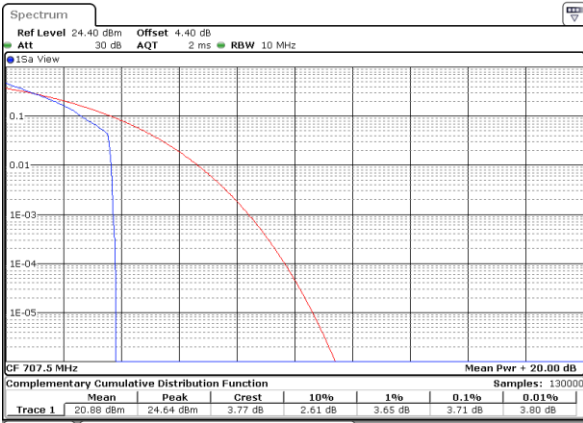

Date: 6 JAN 2018 15:54:22

Middle Channel / Full RB

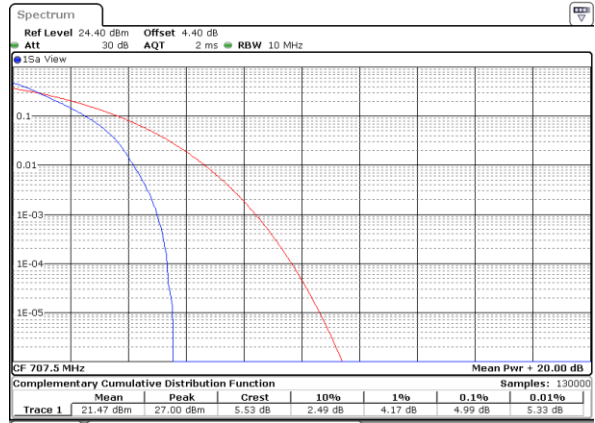

Date: 6 JAN 2018 15:54:12

Highest Channel / 1RB

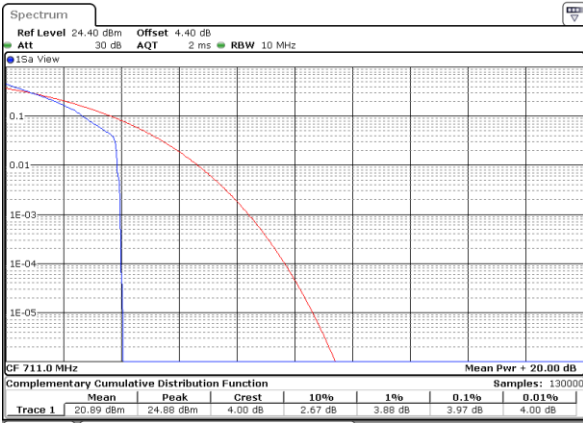

Date: 6 JAN 2018 15:55:26

Highest Channel / Full RB

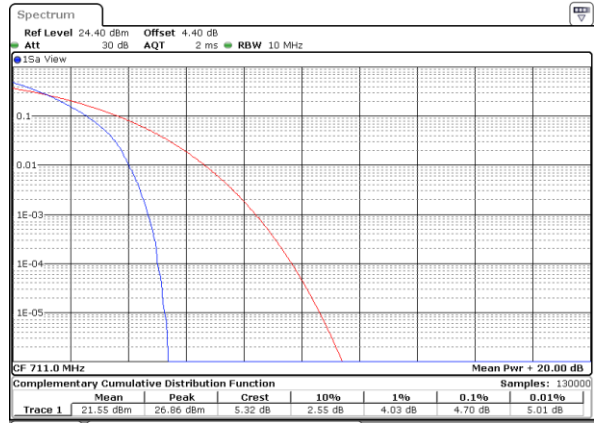

Date: 6 JAN 2018 15:55:36



LTE Band 12 / 10MHz / 16QAM

Lowest Channel / 1RB

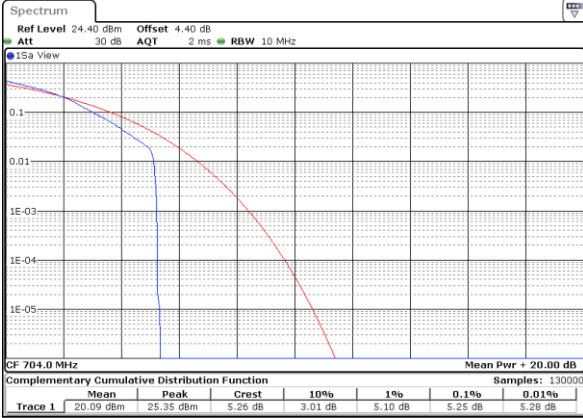

Date: 6 JAN 2018 15:49:52

Lowest Channel / Full RB

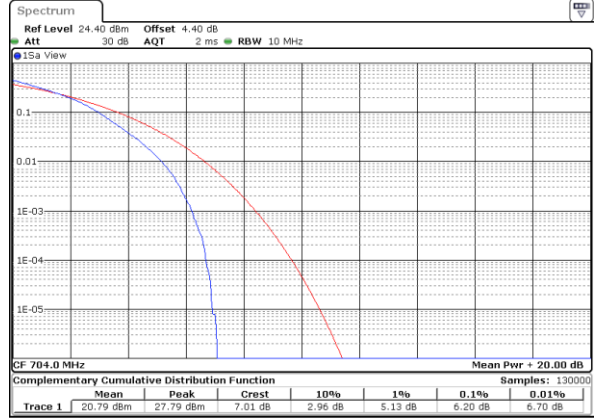

Date: 6 JAN 2018 15:53:52

Middle Channel / 1RB

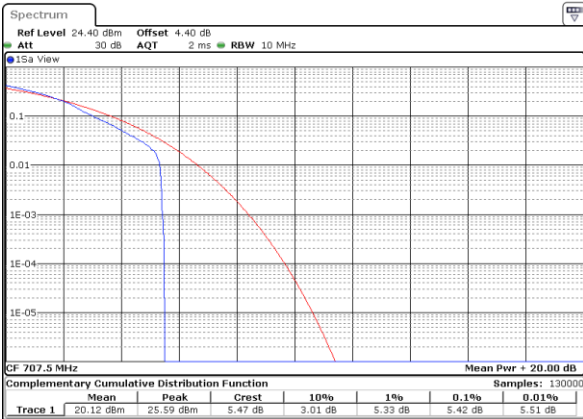

Date: 6 JAN 2018 15:55:01

Middle Channel / Full RB

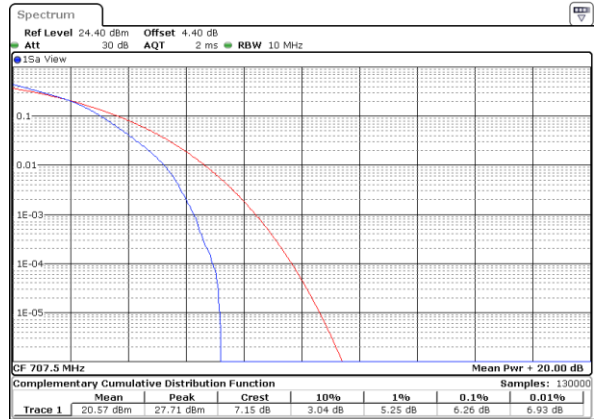

Date: 6 JAN 2018 15:54:03

Highest Channel / 1RB

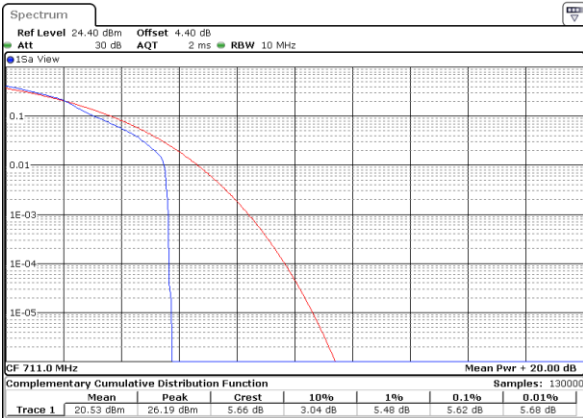

Date: 6 JAN 2018 15:55:13

Highest Channel / Full RB

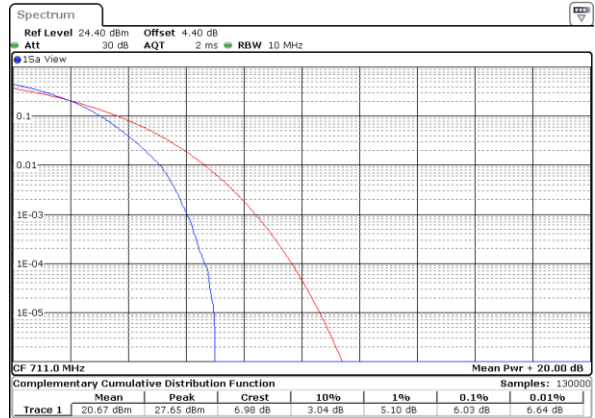

Date: 6 JAN 2018 15:56:04



LTE Band 12 / 10MHz / 64QAM

Lowest Channel / 1RB

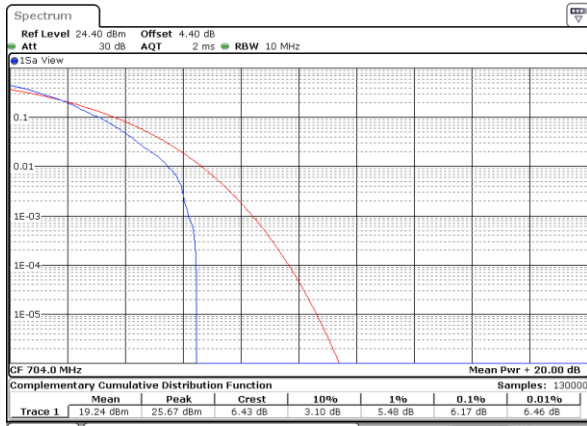

Date: 6 JAN 2018 16:46:34

Lowest Channel / Full RB

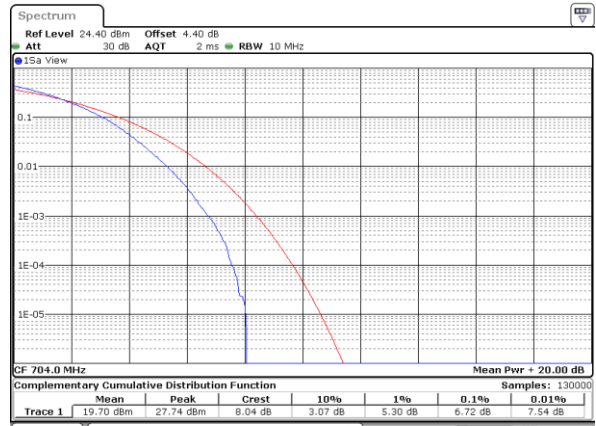

Date: 6 JAN 2018 16:46:43

Middle Channel / 1RB

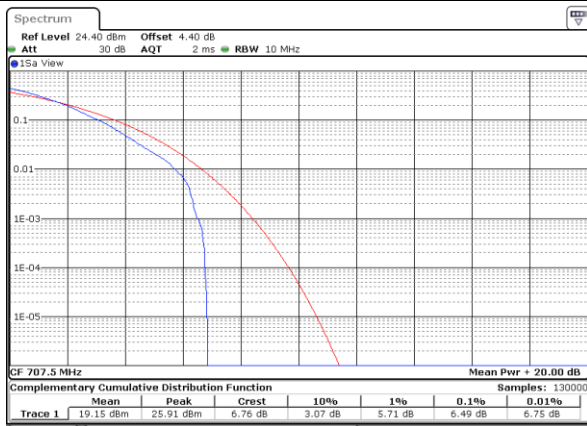

Date: 6 JAN 2018 16:47:29

Middle Channel / Full RB

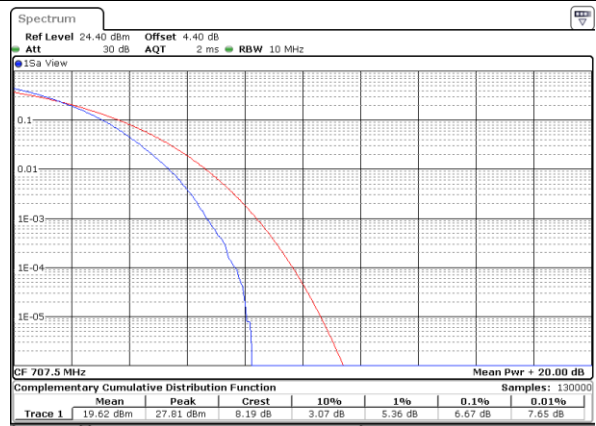

Date: 6 JAN 2018 16:47:08

Highest Channel / 1RB



Date: 6 JAN 2018 16:47:52

Highest Channel / Full RB

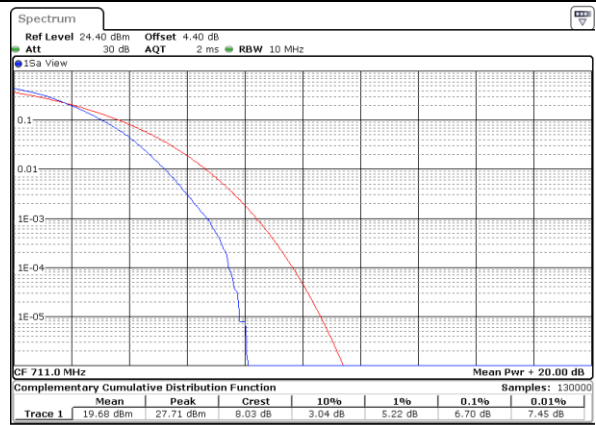

Date: 6 JAN 2018 16:48:03