



FCC RF Test Report

APPLICANT : Motorola Mobility LLC
EQUIPMENT : Mobile Cellular Phone
BRAND NAME : Motorola
MODEL NAME : XT1926-6, XT1926-7
FCC ID : IHDT56WL4
STANDARD : FCC Part 15 Subpart C §15.247
CLASSIFICATION : (DTS) Digital Transmission System

The product was received on Dec. 27, 2017 and testing was completed on Jan. 22, 2018. We, Sporton International (Kunshan) Inc., would like to declare that the tested sample has been evaluated in accordance with the test procedures and has been in compliance with the applicable technical standards.

The test results in this report apply exclusively to the tested model / sample. Without written approval of Sporton International (Kunshan) Inc., the test report shall not be reproduced except in full.



Approved by: James Huang / Manager

Sporton International (Kunshan) Inc.

**No.3-2 Ping-Xiang Rd, Kunshan Development Zone Kunshan City Jiangsu Province 215335
China**



TABLE OF CONTENTS

SUMMARY OF TEST RESULT 4

1 GENERAL DESCRIPTION..... 5

1.1 Applicant 5

1.2 Manufacturer 5

1.3 Product Feature of Equipment Under Test..... 5

1.4 Product Specification of Equipment Under Test..... 6

1.5 Modification of EUT 6

1.6 Accessory List 7

1.7 Testing Location 8

1.8 Applicable Standards 9

2 TEST CONFIGURATION OF EQUIPMENT UNDER TEST..... 10

2.1 Descriptions of Test Mode 10

2.2 Test Mode 11

2.3 Connection Diagram of Test System 12

2.4 Support Unit used in test configuration and system 13

2.5 EUT Operation Test Setup 13

2.6 Measurement Results Explanation Example 13

3 TEST RESULT 14

3.1 6dB Bandwidth Measurement 14

3.2 Peak Output Power Measurement 19

3.3 Power Spectral Density Measurement 20

3.4 Conducted Band Edges and Spurious Emission Measurement 29

3.5 Radiated Band Edges and Spurious Emission Measurement 38

3.6 AC Conducted Emission Measurement 42

3.7 Antenna Requirements 46

4 LIST OF MEASURING EQUIPMENT 47

5 UNCERTAINTY OF EVALUATION..... 48

APPENDIX A. CONDUCTED TEST RESULTS

APPENDIX B. RADIATED SPURIOUS EMISSION

APPENDIX C. DUTY CYCLE PLOTS

APPENDIX D. SETUP PHOTOGRAPHS



REVISION HISTORY

REPORT NO.	VERSION	DESCRIPTION	ISSUED DATE
FR7D2702B	Rev. 01	Initial issue of report	Feb. 01, 2018



SUMMARY OF TEST RESULT

Report Section	FCC Rule	Description	Limit	Result	Remark
3.1	15.247(a)(2)	6dB Bandwidth	$\geq 0.5\text{MHz}$	Pass	-
3.2	15.247(b)(3)	Peak Output Power	$\leq 30\text{dBm}$	Pass	-
3.3	15.247(e)	Power Spectral Density	$\leq 8\text{dBm}/3\text{kHz}$	Pass	-
3.4	15.247(d)	Conducted Band Edges and Spurious Emission	$\leq 20\text{dBc}$	Pass	-
3.5	15.247(d)	Radiated Band Edges and Spurious Emission	15.209(a) & 15.247(d)	Pass	Under limit 3.24 dB at 34.85 MHz
3.6	15.207	AC Conducted Emission	15.207(a)	Pass	Under limit 15.33 dB at 0.199 MHz
3.7	15.203 & 15.247(b)	Antenna Requirement	N/A	Pass	-



1 General Description

1.1 Applicant

Motorola Mobility LLC
222 W,Merchandise Mart Plaza, Chicago IL 60654 USA

1.2 Manufacturer

Motorola Mobility LLC
222 W,Merchandise Mart Plaza, Chicago IL 60654 USA

1.3 Product Feature of Equipment Under Test

Product Feature	
Equipment	Mobile Cellular Phone
Brand Name	Motorola
Model Name	XT1926-6, XT1926-7
FCC ID	IHDT56WL4
EUT supports Radios application	GSM/GPRS/EGPRS/WCDMA/HSPA/DC-HSDPA/HSPA+ /LTE/NFC/ WLAN 2.4GHz 802.11b/g/n HT20/ WLAN 5GHz 802.11a/n HT20/HT40/ WLAN 5GHz 802.11ac VHT20/VHT40/VHT80/ Bluetooth v3.0+EDR/ Bluetooth v4.0 LE/ Bluetooth v4.1 LE/ Bluetooth v4.2 LE/ Bluetooth v5.0 LE
IMEI Code	Conducted: 3518533090015717/351853090015725 Conduction: 351881090004332 Radiation: 351853090016053/351853090016061
HW Version	DVT1B
SW Version	evert_n-userdebug 8.0.0 OPW27.88 1825 intcfg,test-keys
EUT Stage	Identical Prototype

Remark:

- The above EUT's information was declared by manufacturer. Please refer to the specifications or user's manual for more detailed description.
- There are two types of EUT: sample 1 (XT1926-7) is dual SIM card, sample 2 (XT1926-6) is single SIM card. Except the SIM card slot, all the others are the same. The difference has no influence on RF test, we only choose sample 1 to perform full test.



1.4 Product Specification of Equipment Under Test

Standards-related Product Specification	
Tx/Rx Frequency Range	2402 MHz ~ 2480 MHz
Number of Channels	40
Carrier Frequency of Each Channel	40 Channel(37 hopping + 3 advertising channel)
Maximum Output Power to Antenna	Bluetooth v4.2 LE 0.79 dBm (0.0012 W) Bluetooth v5.0 LE 0.92 dBm (0.0012 W)
Antenna Type / Gain	PIFA Antenna with gain -2.8 dBi
Type of Modulation	Bluetooth LE : GFSK

1.5 Modification of EUT

No modifications are made to the EUT during all test items.



1.6 Accessory List

Specification of Accessory			
AC Adapter 1(US)	Brand Name	Motorola (Salom)	Model Name SC-22
	Power Rating	I/P: 100-240 Vac, 500mA, O/P: 5Vdc,3000mA or 9Vdc,1600mA or 12Vdc,1200mA	
AC Adapter 1(EU)	Brand Name	Motorola (Salom)	Model Name SC-23
	Power Rating	I/P: 100-240 Vac, 500mA, O/P: 5Vdc,3000mA or 9Vdc,1600mA or 12Vdc,1200mA	
AC Adapter 1(UK)	Brand Name	Motorola (Salom)	Model Name SC-24
	Power Rating	I/P: 100-240 Vac, 500mA, O/P: 5Vdc,3000mA or 9Vdc,1600mA or 12Vdc,1200mA	
AC Adapter 1(IN)	Brand Name	Motorola (Salom)	Model Name SC-25
	Power Rating	I/P: 100-240 Vac, 500mA, O/P: 5Vdc,3000mA or 9Vdc,1600mA or 12Vdc,1200mA	
AC Adapter 1(AU)	Brand Name	Motorola (Salom)	Model Name SC-26
	Power Rating	I/P: 100-240 Vac, 500mA, O/P: 5Vdc,3000mA or 9Vdc,1600mA or 12Vdc,1200mA	
AC Adapter 1(AR)	Brand Name	Motorola (Salom)	Model Name SC-27
	Power Rating	I/P: 100-240 Vac, 500mA, O/P: 5Vdc,3000mA or 9Vdc,1600mA or 12Vdc,1200mA	
AC Adapter 2(US)	Brand Name	Motorola (Chenyang)	Model Name SC-22
	Power Rating	I/P: 100-240 Vac, 500mA, O/P: 5Vdc,3000mA or 9Vdc,1600mA or 12Vdc,1200mA	
AC Adapter 2(EU)	Brand Name	Motorola (Chenyang)	Model Name SC-23
	Power Rating	I/P: 100-240 Vac, 500mA, O/P: 5Vdc,3000mA or 9Vdc,1600mA or 12Vdc,1200mA	
AC Adapter 2(UK)	Brand Name	Motorola (Chenyang)	Model Name SC-24
	Power Rating	I/P: 100-240 Vac, 500mA, O/P: 5Vdc,3000mA or 9Vdc,1600mA or 12Vdc,1200mA	
AC Adapter 2(IN)	Brand Name	Motorola (Chenyang)	Model Name SC-25
	Power Rating	I/P: 100-240 Vac, 500mA, O/P: 5Vdc,3000mA or 9Vdc,1600mA or 12Vdc,1200mA	
AC Adapter 2(AU)	Brand Name	Motorola (Chenyang)	Model Name SC-26
	Power Rating	I/P: 100-240 Vac, 500mA, O/P: 5Vdc,3000mA or 9Vdc,1600mA or 12Vdc,1200mA	
AC Adapter 2(AR)	Brand Name	Motorola (chenyang)	Model Name SC-27
	Power Rating	I/P: 100-240 Vac, 500mA, O/P: 5Vdc,3000mA or 9Vdc,1600mA or 12Vdc,1200mA	
Battery	Brand Name	Motorola (ATL)	Model Name JT40
	Power Rating	3.8Vdc,3200mAh	Type Li-ion Polymer
Earphone 1	Brand Name	Motorola (Jiahe)	Model Name LS-118M-12
	Signal Line Type	1.2 meter, non-shielded cable, without ferrite core	
Earphone 2	Brand Name	Motorola (Lianyun)	Model Name TS910A-38AMS01WHR-M
	Signal Line Type	1.2 meter, non-shielded cable, without ferrite core	
USB Cable	Brand Name	Motorola (Liqi)	Model Name L32B-053000100-ALL
	Signal Line Type	1.0 meter, shielded cable, without ferrite core	



1.7 Testing Location

Sporton International (Kunshan) Inc. is accredited to ISO 17025 by National Voluntary Laboratory Accreditation Program (NVLAP code: 600155-0) and the FCC designation No is CN5013.

Test Site	Sporton International (Kunshan) Inc.		
Test Site Location	No.3-2 Ping-Xiang Rd, Kunshan Development Zone Kunshan City Jiangsu Province 215335 China TEL : +86-512-57900158 FAX : +86-512-57900958		
Test Site No.	Sporton Site No.		FCC Test Firm Registration No.
	TH01-KS	CO01-KS	630927

Note: The test site complies with ANSI C63.4 2014 requirement.

Sporton International (Shenzhen) Inc. is accredited to ISO 17025 by National Voluntary Laboratory Accreditation Program (NVLAP code: 600156-0) and the FCC designation No is CN5019.

Test Site	Sporton International (Shenzhen) Inc.		
Test Site Location	No. 3 Bldg the third floor of south, Shahe River west, Fengzeyuan Warehouse, Nanshan District Shenzhen City Guangdong Province 518055 China TEL: +86-755-3320-2398		
Test Site No.	Sporton Site No.		FCC Test Firm Registration No.
	03CH01-SZ		577730

Note: The test site complies with ANSI C63.4 2014 requirement.



1.8 Applicable Standards

According to the specifications of the manufacturer, the EUT must comply with the requirements of the following standards:

- ♦ FCC Part 15 Subpart C §15.247
- ♦ FCC KDB Publication No. 558074 D01 DTS Meas. Guidance v04
- ♦ ANSI C63.10-2013

Remark:

1. All test items were verified and recorded according to the standards and without any deviation during the test.
2. This EUT has also been tested and complied with the requirements of FCC Part 15, Subpart B, recorded in a separate test report.



2 Test Configuration of Equipment Under Test

2.1 Descriptions of Test Mode

The RF output power was recorded in the following table:

Channel	Frequency	Bluetooth LE RF Output Power	
		Data Rate / Modulation	
		GFSK	
		v4.2	v5.0
Ch00	2402MHz	-0.49 dBm	-0.32 dBm
Ch19	2440MHz	-1.47 dBm	-1.22 dBm
Ch39	2480MHz	0.79 dBm	0.92 dBm

- a. The EUT has been associated with peripherals and configuration operated in a manner tended to maximize its emission characteristics in a typical application. Frequency range investigated: conduction (150 kHz to 30 MHz), radiation (9 kHz to the 10th harmonic of the highest fundamental frequency or to 40 GHz, whichever is lower). Pre-scanned tests, X, Y, Z in three orthogonal panels to determine the final configuration (Z plane as worst plane) from all possible combinations.
- b. AC power line Conducted Emission was tested under maximum output power.



2.2 Test Mode

The following summary table is showing all test modes to demonstrate in compliance with the standard.

Summary table of Test Cases	
Test Item	Data Rate / Modulation
	Bluetooth – LE / GFSK
Conducted TCs	Mode 1: Bluetooth Tx CH00_2402 MHz_1Mbps Mode 2: Bluetooth Tx CH19_2440 MHz_1Mbps Mode 3: Bluetooth Tx CH39_2480 MHz_1Mbps
Radiated TCs	Mode 1: Bluetooth Tx CH00_2402 MHz_1Mbps Mode 2: Bluetooth Tx CH19_2440 MHz_1Mbps Mode 3: Bluetooth Tx CH39_2480 MHz_1Mbps
AC Conducted Emission	Mode 1: GSM850 Idle + Bluetooth Link + WLAN Link(2.4G) + USB Cable(Charging from Adapter 1) + Earphone
Remark: For Radiated TCs, The tests were performance with Adapter 1, Earphone 1 and USB Cable 1.	

2.3 Connection Diagram of Test System

<Bluetooth – LE Tx Mode>

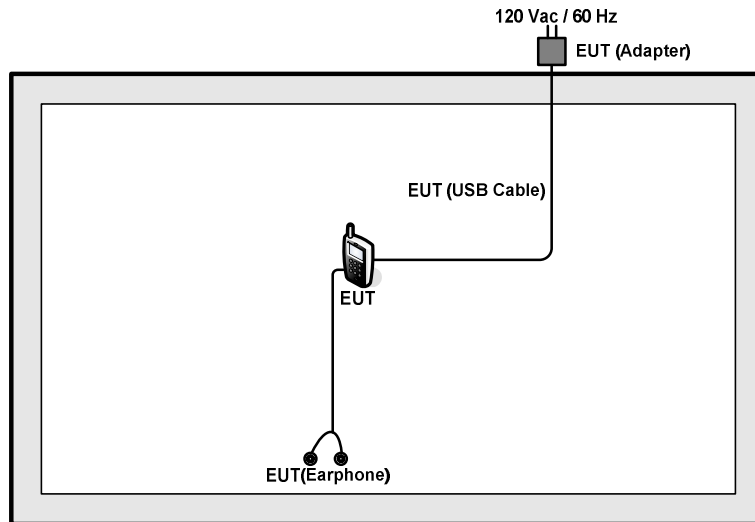

<AC Conducted Emission Mode>

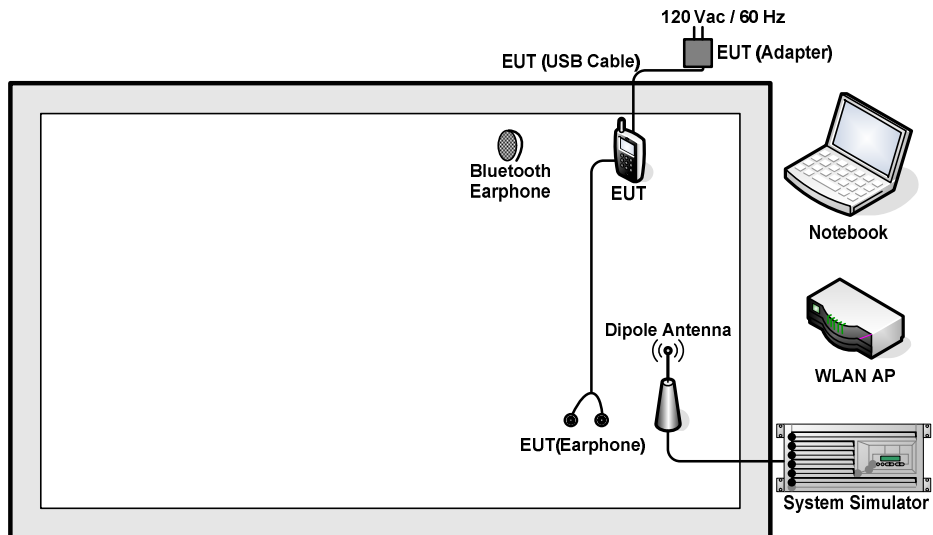

2.4 Support Unit used in test configuration and system

Item	Equipment	Trade Name	Model Name	FCC ID	Data Cable	Power Cord
1.	System Simulator	Anritsu	MT8820C	N/A	N/A	Unshielded, 1.8 m
2.	WLAN AP	D-Link	DIR-855	KA2DIR855A2	N/A	Unshielded, 1.8 m
3.	Notebook	Lenovo	G480	N/A	N/A	AC I/P: Unshielded, 1.8 m DC O/P: Shielded, 1.8 m
4.	Bluetooth Earphone	Lenovo	LBH308	N/A	N/A	N/A
5.	SD Card	Kingston	8GB	N/A	N/A	N/A

2.5 EUT Operation Test Setup

For Bluetooth LE function, the engineering test program was provided and enabled to make EUT continuous transmit/receive.

For AC power line conducted emissions, the EUT was set to connect with the WLAN AP under large package sizes transmission.

2.6 Measurement Results Explanation Example

For all conducted test items:

The offset level is set in the spectrum analyzer to compensate the RF cable loss between EUT conducted output port and spectrum analyzer. With the offset compensation, the spectrum analyzer reading level is exactly the EUT RF output level.

Example :

The spectrum analyzer offset is derived from RF cable loss and attenuator factor.

Offset = RF cable loss.

Following shows an offset computation example with cable loss 5.5 Db.

$$\begin{aligned} \text{Offset(dB)} &= \text{RF cable loss(dB)} \\ &= 5.5 \text{ (dB)} \end{aligned}$$

3 Test Result

3.1 6dB Bandwidth Measurement

3.1.1 Limit of 6dB Bandwidth

The minimum 6 dB bandwidth shall be at least 500 kHz.

3.1.2 Measuring Instruments

The section 4.0 of List of Measuring Equipment of this test report is used for test.

3.1.3 Test Procedures

1. The testing follows FCC KDB Publication No. 558074 D01 DTS Meas. Guidance v04.
2. The RF output of EUT was connected to the spectrum analyzer by RF cable and attenuator. The path loss was compensated to the results for each measurement.
3. Set to the maximum power setting and enable the EUT transmit continuously.
4. Make the measurement with the spectrum analyzer's resolution bandwidth (RBW) = 100 kHz. Set the Video bandwidth (VBW) = 300 kHz. In order to make an accurate measurement. The 6 dB bandwidth must be greater than 500 kHz.
5. Measure and record the results in the test report.

3.1.4 Test Setup

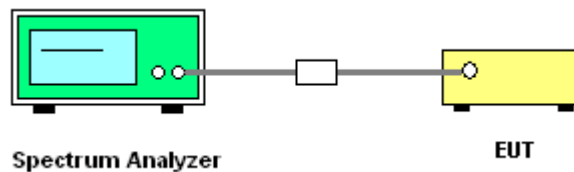



3.1.5 Test Result of 6dB Bandwidth

Test data refer to Appendix A.

Bluetooth v4.2 LE

6 dB Bandwidth Plot on Channel 00

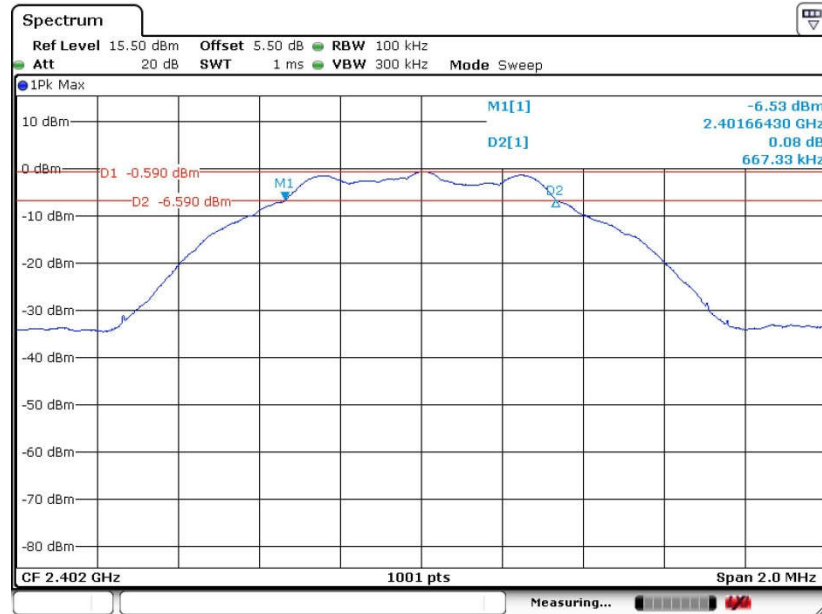

Date: 2 JAN 2018 10:46:41



6 dB Bandwidth Plot on Channel 19

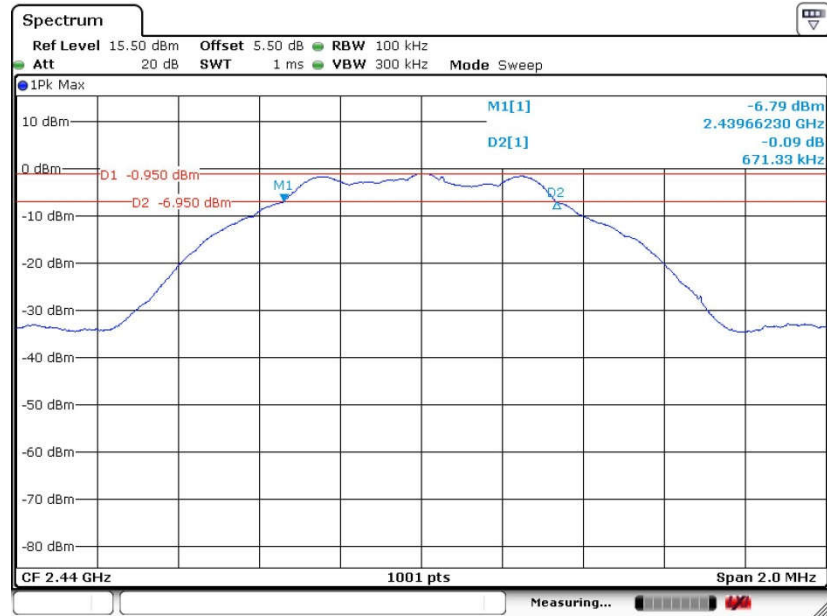

Date: 2 JAN 2018 12:34:01

6 dB Bandwidth Plot on Channel 39

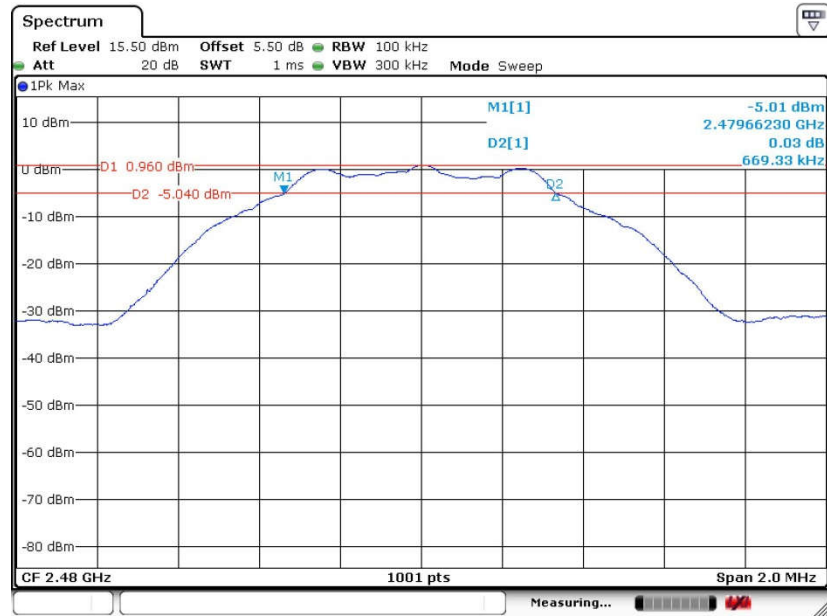

Date: 2 JAN 2018 12:38:46



Bluetooth v5.0 LE

6 dB Bandwidth Plot on Channel 00

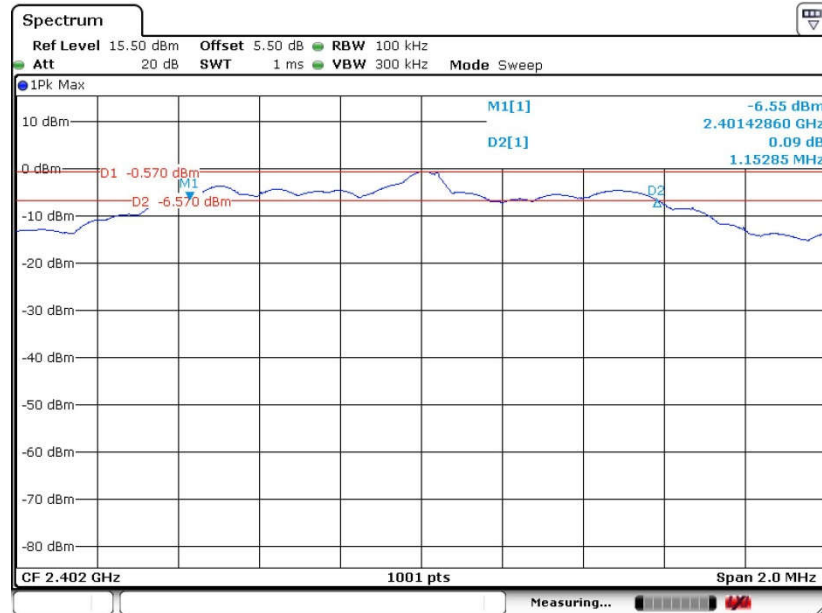

Date: 2 JAN 2018 12:50:44



6 dB Bandwidth Plot on Channel 19

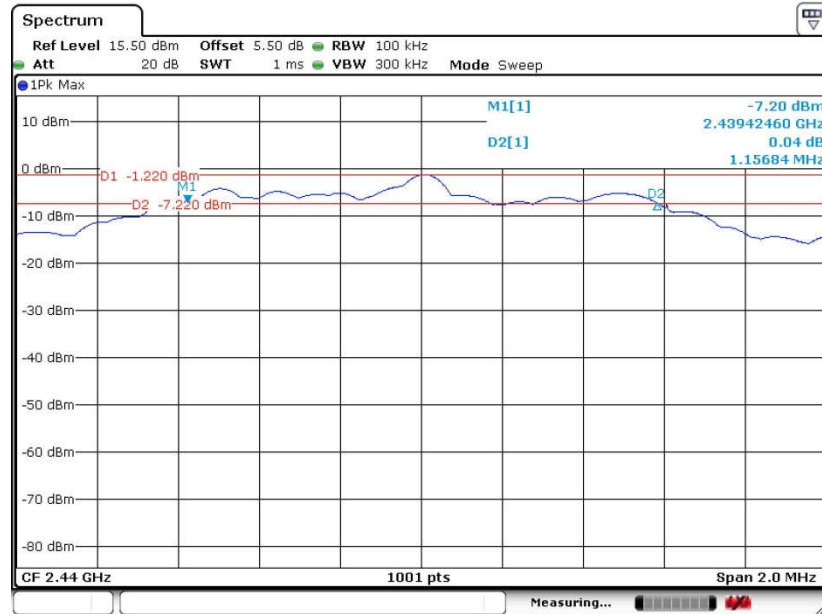

Date: 2 JAN 2018 12:58:00

6 dB Bandwidth Plot on Channel 39

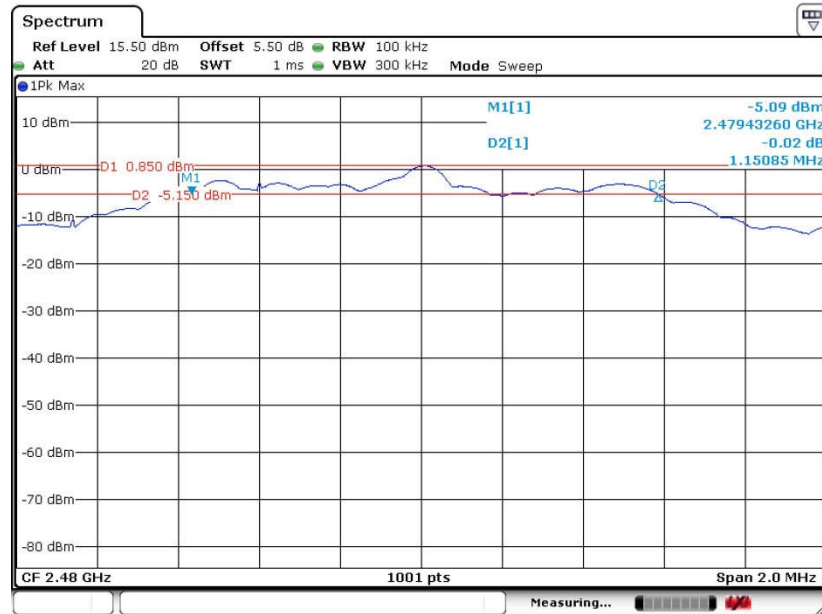

Date: 2 JAN 2018 13:04:48

3.2 Peak Output Power Measurement

3.2.1 Limit of Peak Output Power

For systems using digital modulation in the 2400-2483.5MHz, the limit for peak output power is 30dBm. If transmitting antenna of directional gain greater than 6dBi is used, the peak output power from the intentional radiator shall be reduced below the above stated value by the amount in dB that the directional gain of the antenna exceeds 6 dBi. In case of point-to-point operation, the limit has to be reduced by 1dB for every 3dB that the directional gain of the antenna exceeds 6dBi.

3.2.2 Measuring Instruments

The section 4.0 of List of Measuring Equipment of this test report is used for test.

3.2.3 Test Procedures

1. The testing follows the Measurement Procedure of FCC KDB No. 558074 DTS D01 Meas. Guidance v04 section 9.1.2 PKPM1 Peak power meter method.
2. The RF output of EUT was connected to the power meter by RF cable and attenuator. The path loss was compensated to the results for each measurement.
3. Set to the maximum power setting and enable the EUT transmit continuously.
4. Measure the conducted output power and record the results in the test report.

3.2.4 Test Setup

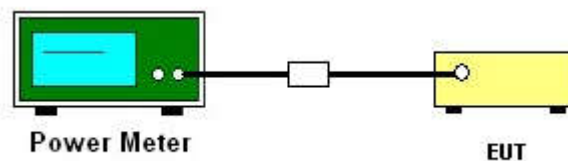

3.2.5 Test Result of Peak Output Power

Test data refers to Appendix A.

3.3 Power Spectral Density Measurement

3.3.1 Limit of Power Spectral Density

The peak power spectral density shall not be greater than 8dBm in any 3kHz band at any time interval of continuous transmission.

3.3.2 Measuring Instruments

The section 4.0 of List of Measuring Equipment of this test report is used for test.

3.3.3 Test Procedures

1. The testing follows Measurement Procedure 10.2 Method PKPSD of FCC KDB Publication No. 558074 D01 DTS Meas. Guidance v04
2. The RF output of EUT was connected to the spectrum analyzer by RF cable and attenuator. The path loss was compensated to the results for each measurement.
3. Set to the maximum power setting and enable the EUT transmit continuously.
4. Make the measurement with the spectrum analyzer's resolution bandwidth (RBW) = 3 kHz. Video bandwidth VBW = 10 kHz In order to make an accurate measurement, set the span to 1.5 times DTS Channel Bandwidth. (6dB BW)
5. Detector = peak, Sweep time = auto couple, Trace mode = max hold, Allow trace to fully stabilize. Use the peak marker function to determine the maximum power level.
6. Measure and record the results in the test report.
7. The Measured power density (dBm)/ 100kHz is a reference level and used as 20dBc down limit line for Conducted Band Edges and Conducted Spurious Emission.

3.3.4 Test Setup

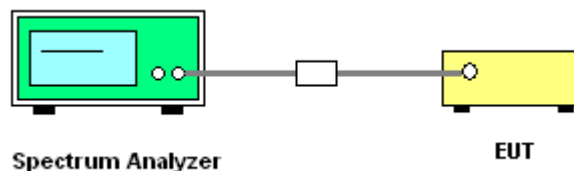

3.3.5 Test Result of Power Spectral Density

Test data refers to Appendix A.



3.3.6 Test Result of Power Spectral Density Plots (100kHz)

Bluetooth v4.2 LE

PSD 100kHz Plot on Channel 00

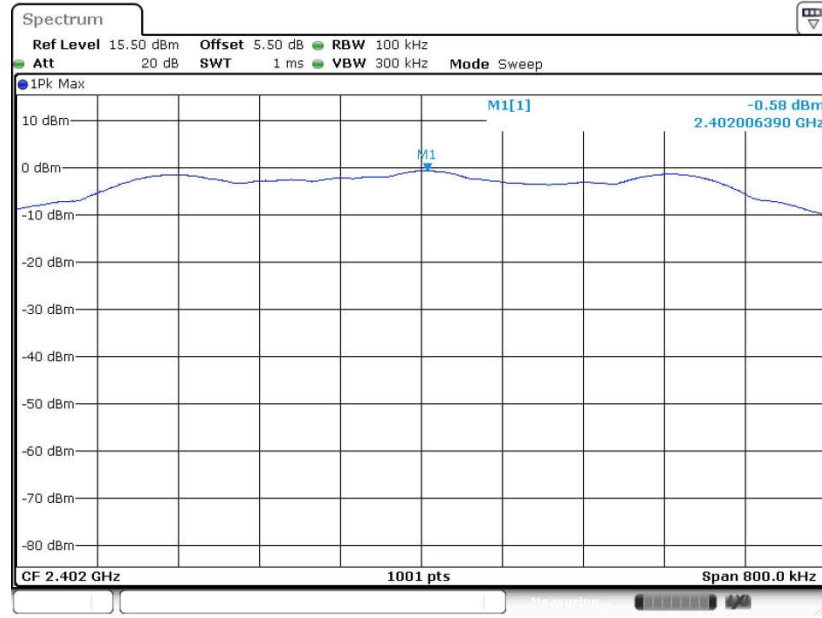

Date: 2 JAN 2018 10:47:22



PSD 100kHz Plot on Channel 19

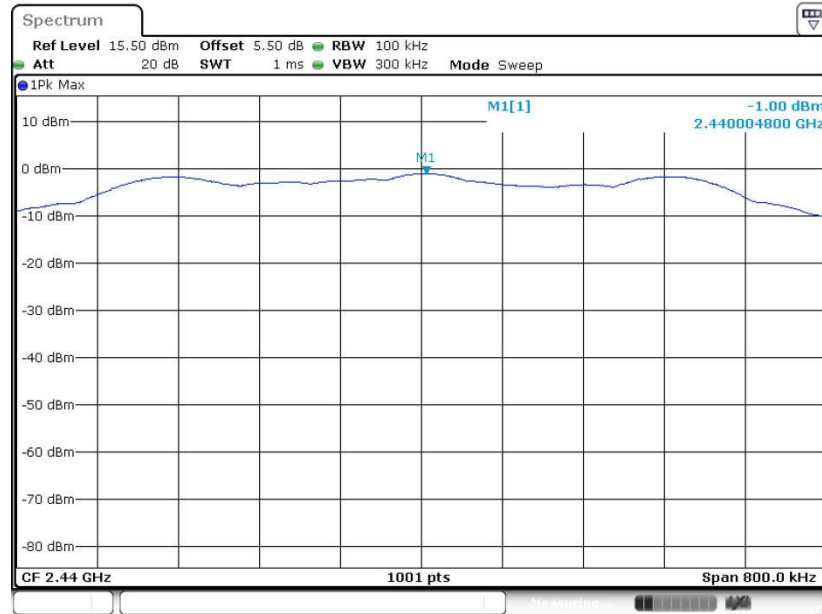

Date: 2 JAN 2018 12:34:38

PSD 100kHz Plot on Channel 39

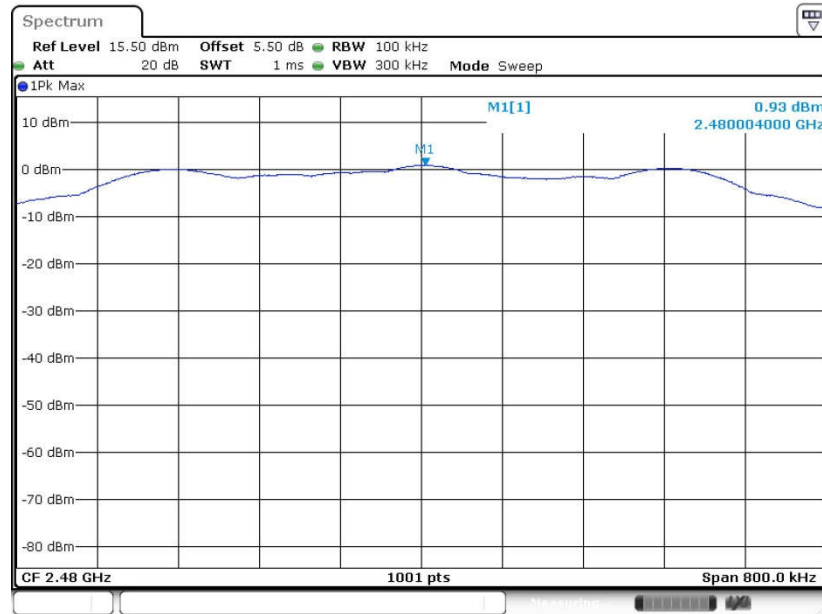

Date: 2 JAN 2018 12:39:27



Bluetooth v5.0 LE

PSD 100kHz Plot on Channel 00

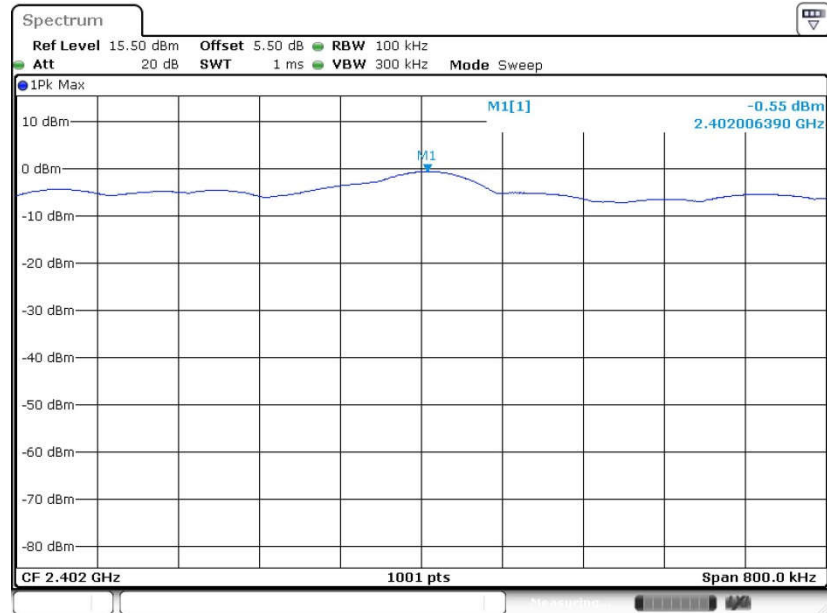

Date: 2 JAN 2018 12:52:05



PSD 100kHz Plot on Channel 19

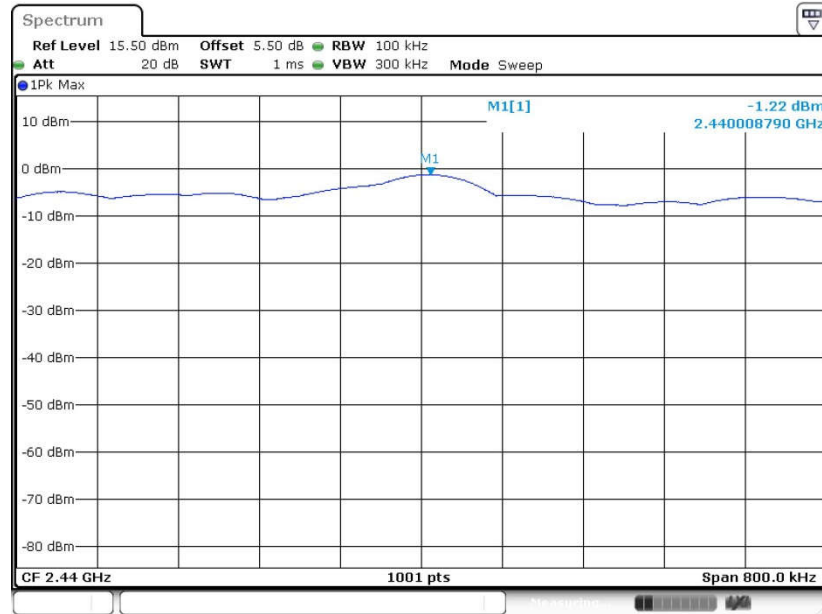

Date: 2 JAN 2018 12:59:41

PSD 100kHz Plot on Channel 39

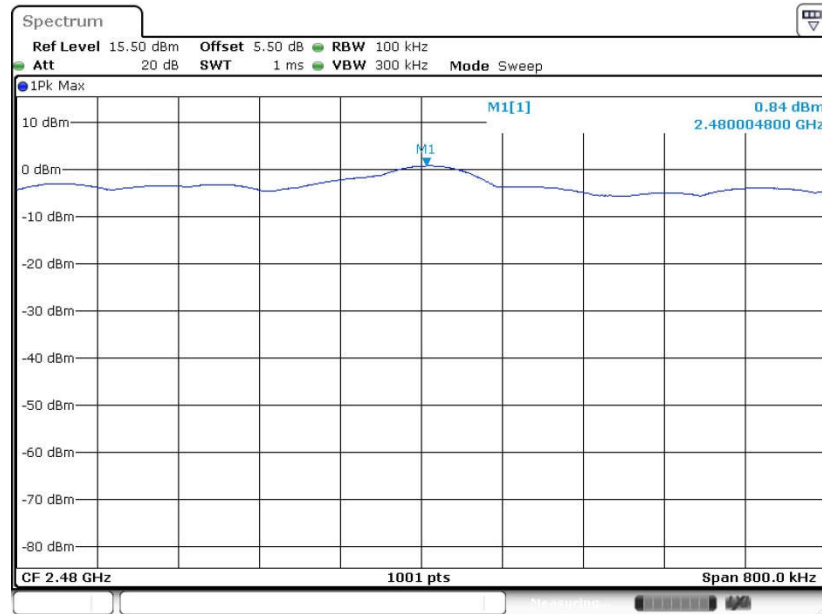

Date: 2 JAN 2018 13:06:02



3.3.7 Test Result of Power Spectral Density Plots (3kHz)

Bluetooth v4.2 LE

PSD 3kHz Plot on Channel 00

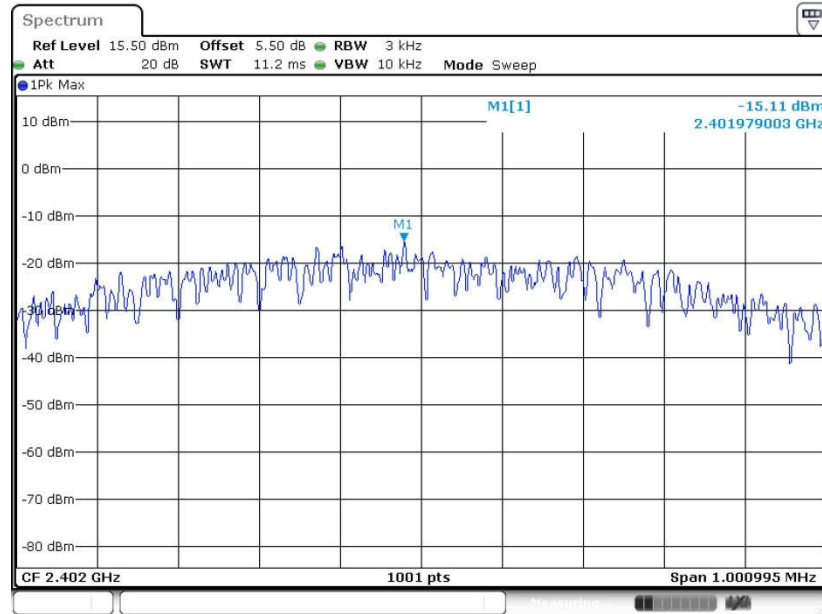

Date: 2 JAN 2018 10:47:09



PSD 3kHz Plot on Channel 19

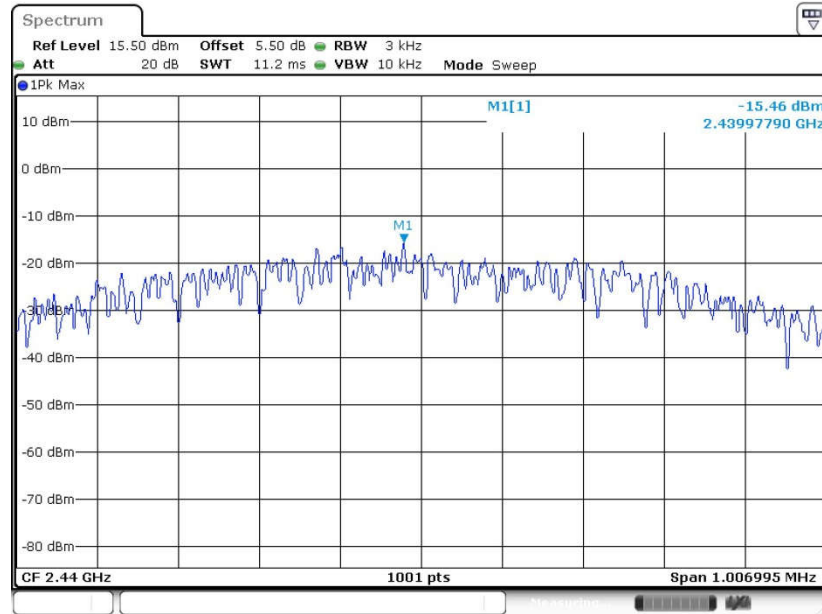

Date: 2 JAN 2018 12:34:26

PSD 3kHz Plot on Channel 39

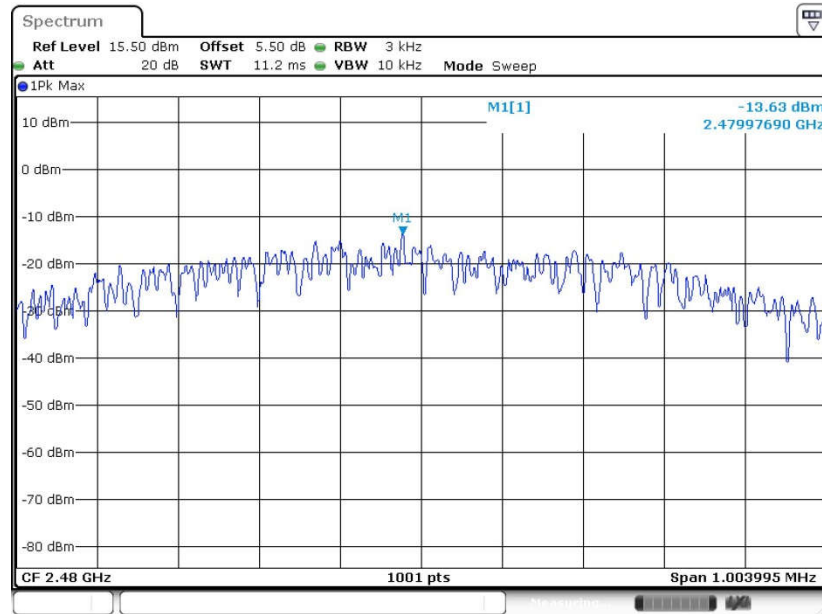

Date: 2 JAN 2018 12:39:10



Bluetooth v5.0 LE

PSD 3kHz Plot on Channel 00

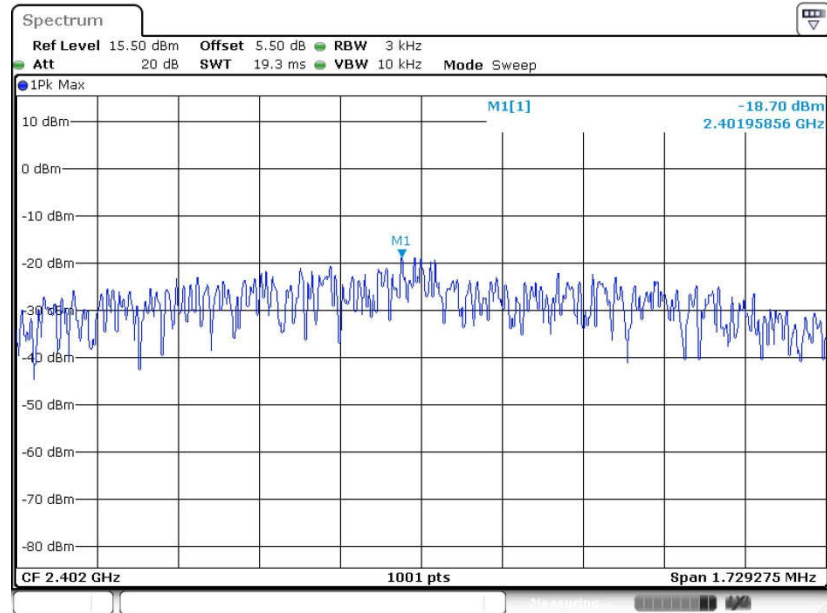

Date: 2 JAN 2018 12:51:20



PSD 3kHz Plot on Channel 19

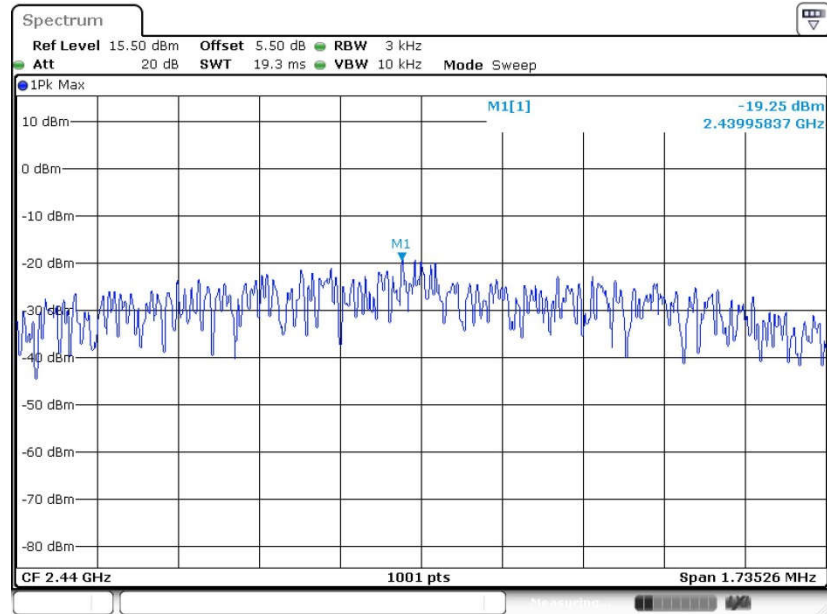

Date: 2 JAN 2018 12:59:01

PSD 3kHz Plot on Channel 39

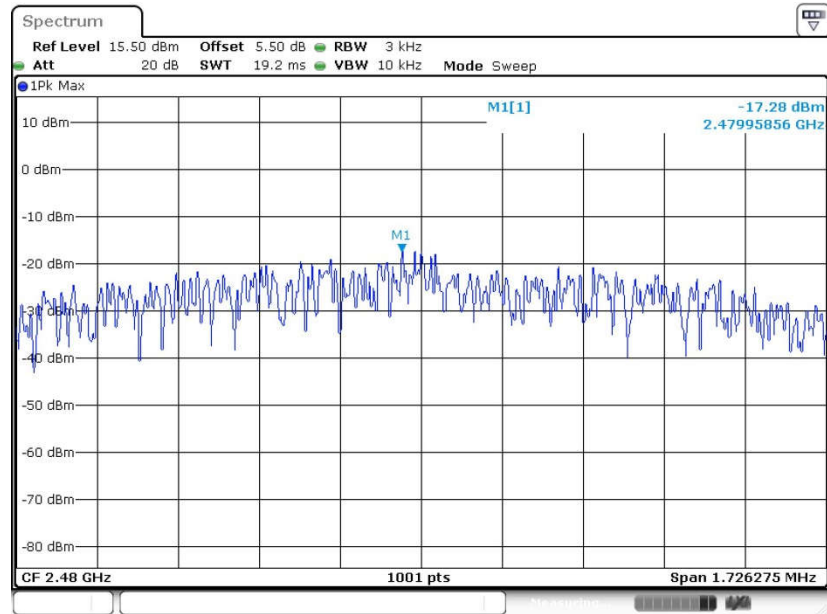

Date: 2 JAN 2018 13:05:36

3.4 Conducted Band Edges and Spurious Emission Measurement

3.4.1 Limit of Conducted Band Edges and Spurious Emission

All harmonics/spurious must be at least 20 dB down from the highest emission level within the authorized band.

3.4.2 Measuring Instruments

The section 4.0 of List of Measuring Equipment of this test report is used for test.

3.4.3 Test Procedure

1. The testing follows FCC KDB Publication No. 558074 D01 DTS Meas. Guidance v04.
2. The RF output of EUT was connected to the spectrum analyzer by RF cable and attenuator. The path loss was compensated to the results for each measurement.
3. Set to the maximum power setting and enable the EUT transmit continuously.
4. Set RBW = 100 kHz, VBW=300 kHz, Peak Detector. Unwanted Emissions measured in any 100 kHz bandwidth outside of the authorized frequency band shall be attenuated by at least 20 dB relative to the maximum in-band peak PSD level in 100 kHz when maximum peak conducted output power procedure is used. If the transmitter complies with the conducted power limits based on the use of RMS averaging over a time interval, the attenuation required under this paragraph shall be 30 dB instead of 20 dB.
5. Measure and record the results in the test report.
6. The RF fundamental frequency should be excluded against the limit line in the operating frequency band.

3.4.4 Test Setup

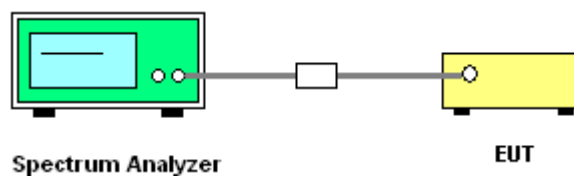



3.4.5 Test Result of Conducted Band Edges Plots

Bluetooth v4.2 LE

Low Band Edge Plot on Channel 00

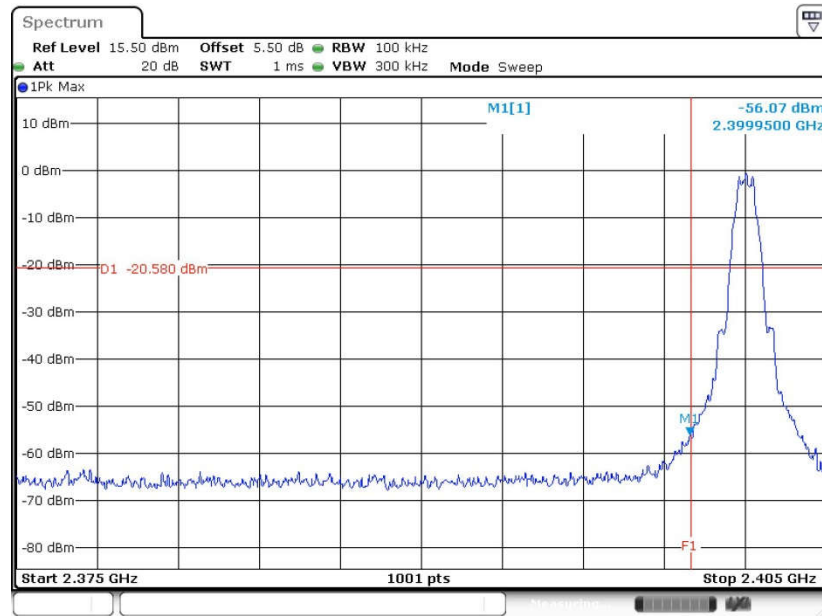

Date: 2 JAN 2018 10:47:39

High Band Edge Plot on Channel 39

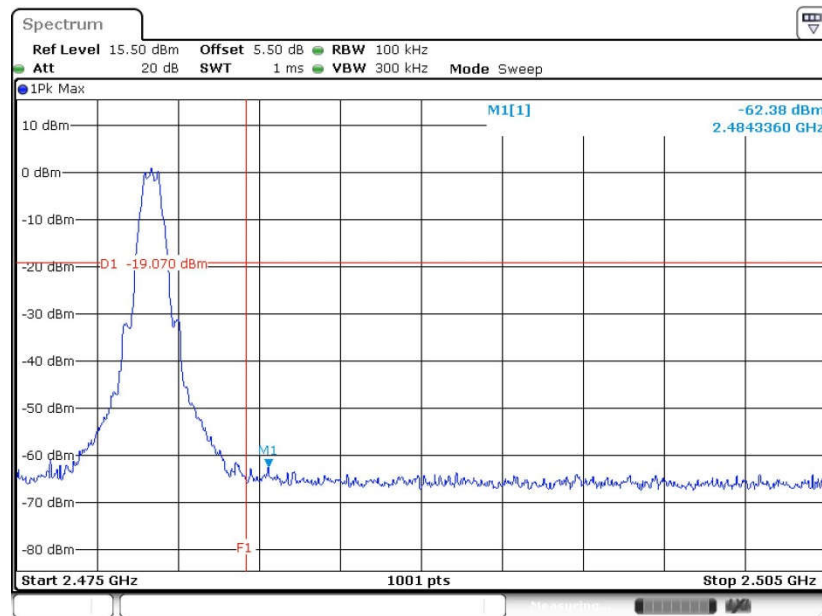

Date: 2 JAN 2018 12:39:38



Bluetooth v5.0 LE

Low Band Edge Plot on Channel 00

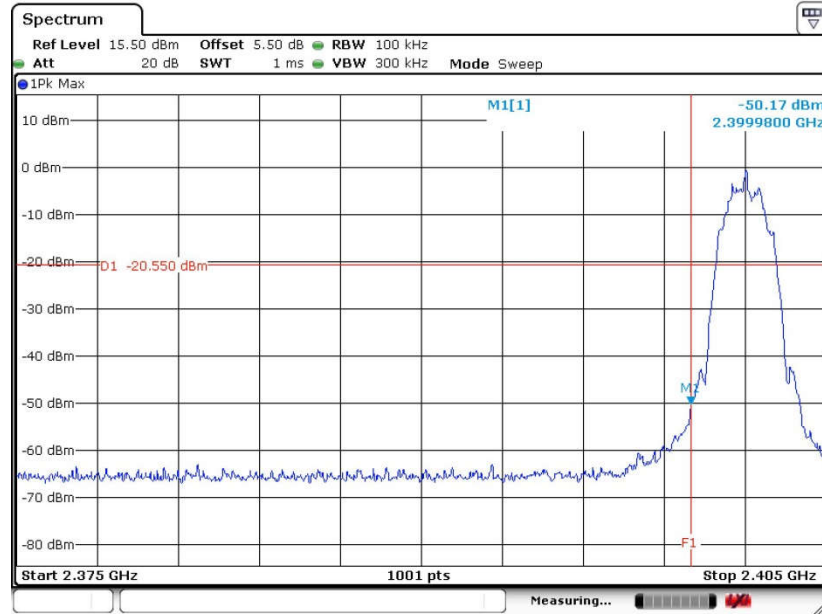

Date: 2 JAN 2018 12:53:22

High Band Edge Plot on Channel 39

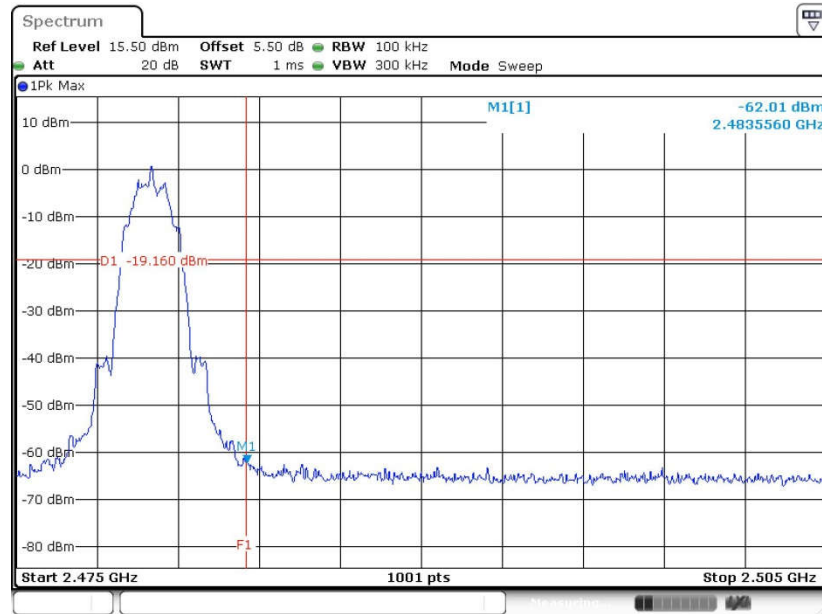

Date: 2 JAN 2018 13:06:21



3.4.6 Test Result of Conducted Spurious Emission Plots

Bluetooth v4.2 LE

Conducted Spurious Emission Plot on Bluetooth LE 1Mbps GFSK Channel 00

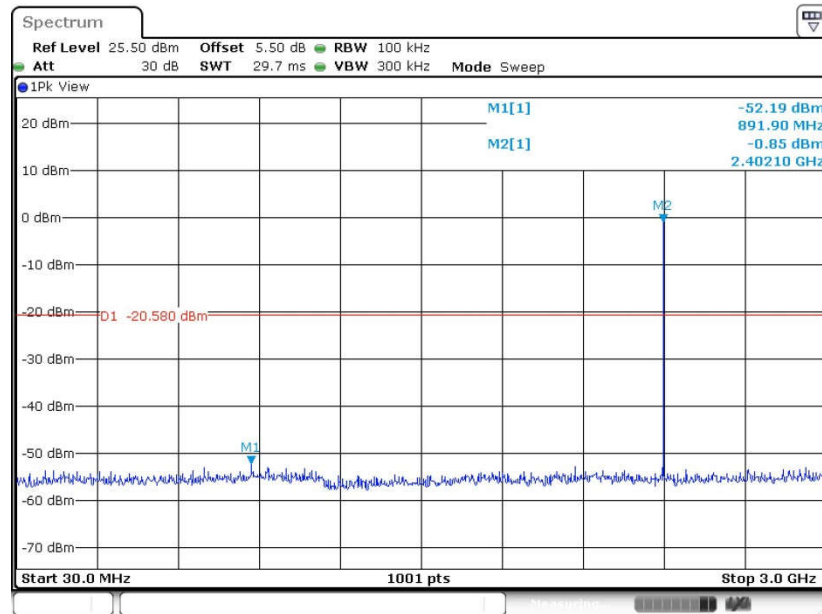

Date: 2 JAN 2018 10:47:58

Conducted Spurious Emission Plot on Bluetooth LE 1Mbps GFSK Channel 00

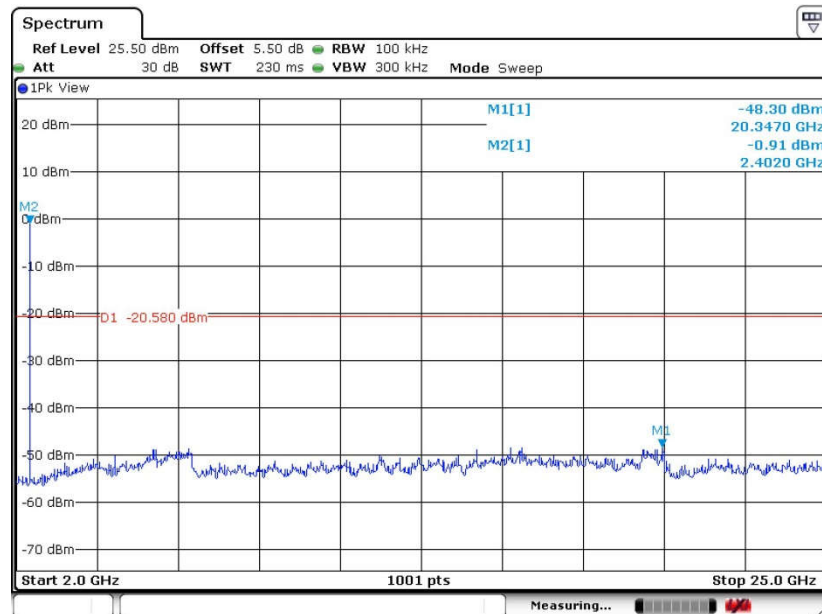

Date: 2 JAN 2018 10:48:27



Conducted Spurious Emission Plot on Bluetooth LE 1Mbps
GFSK Channel 19

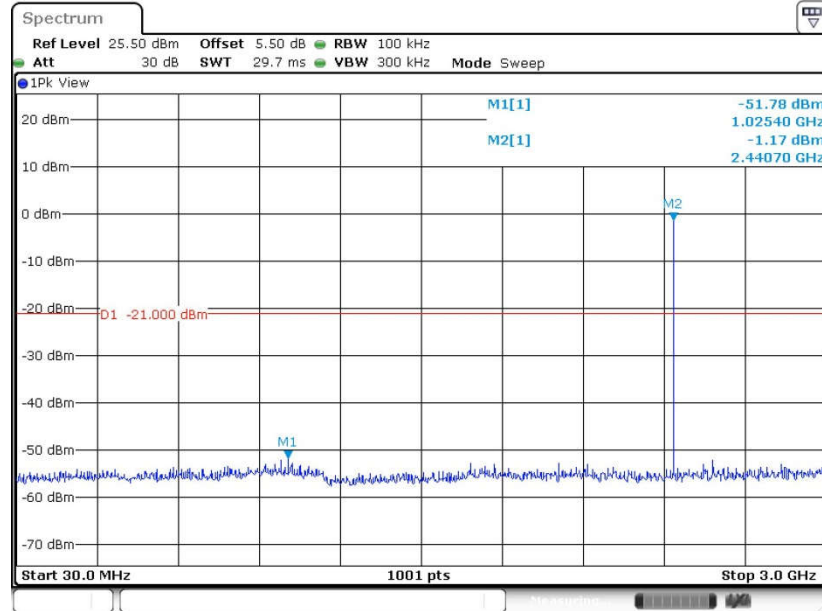

Date: 2 JAN 2018 12:35:53

Conducted Spurious Emission Plot on Bluetooth LE 1Mbps
GFSK Channel 19

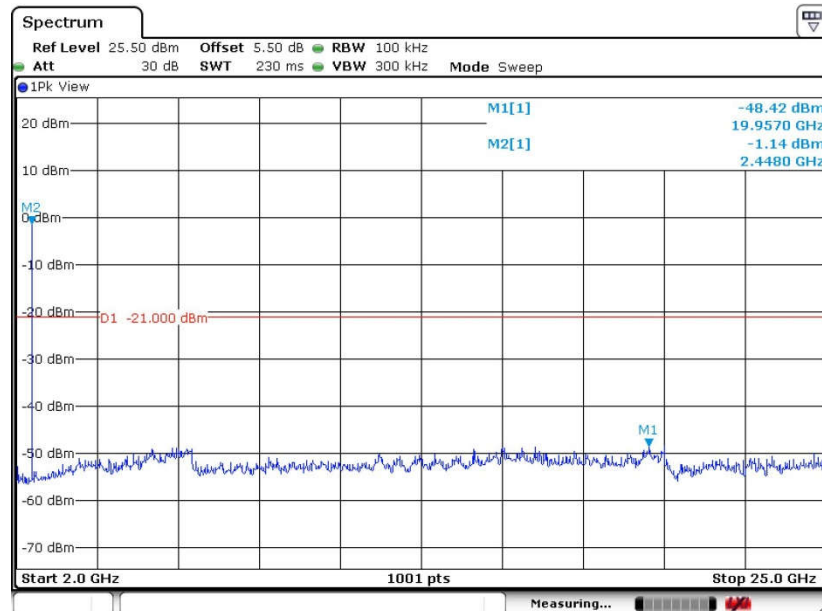

Date: 2 JAN 2018 12:35:06



Conducted Spurious Emission Plot on Bluetooth LE 1Mbps
GFSK Channel 39

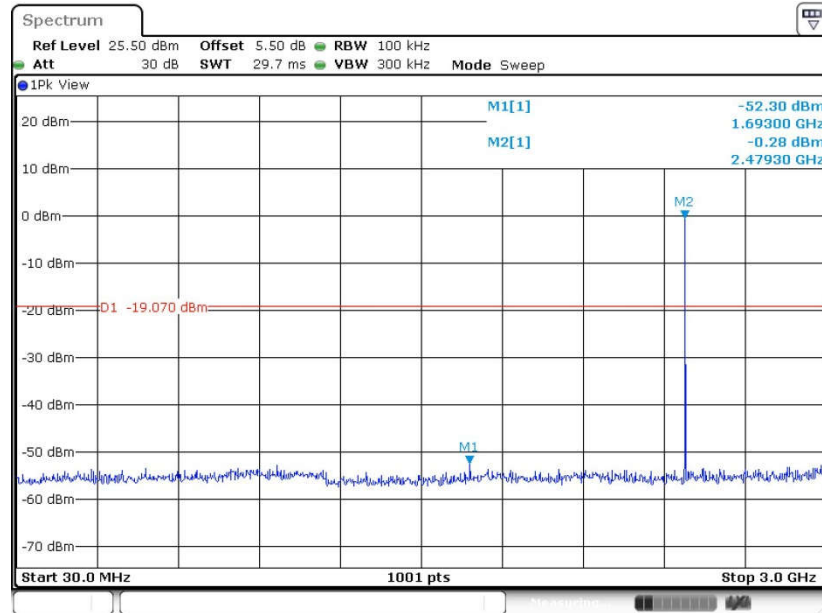

Date: 2 JAN 2018 12:42:07

Conducted Spurious Emission Plot on Bluetooth LE 1Mbps
GFSK Channel 39

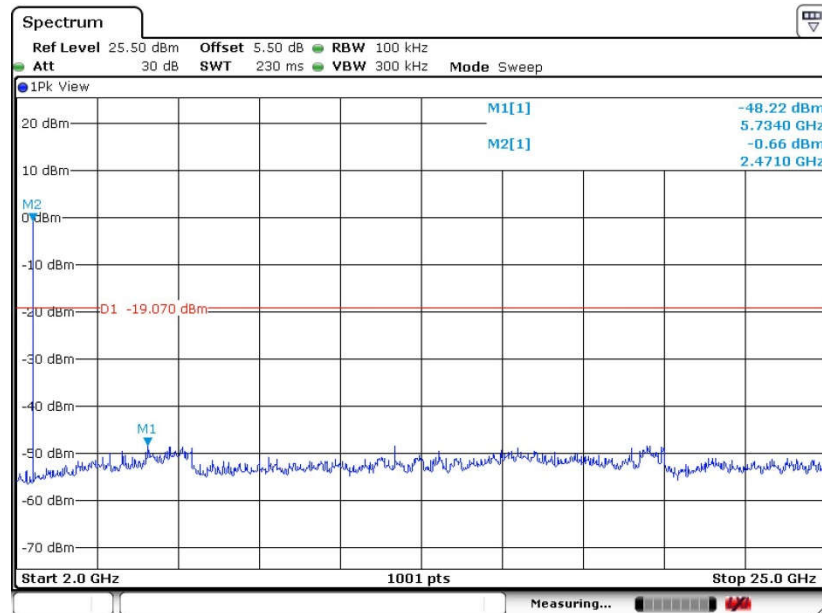

Date: 2 JAN 2018 12:40:30



Bluetooth v5.0 LE

Conducted Spurious Emission Plot on Bluetooth LE 1Mbps GFSK Channel 00

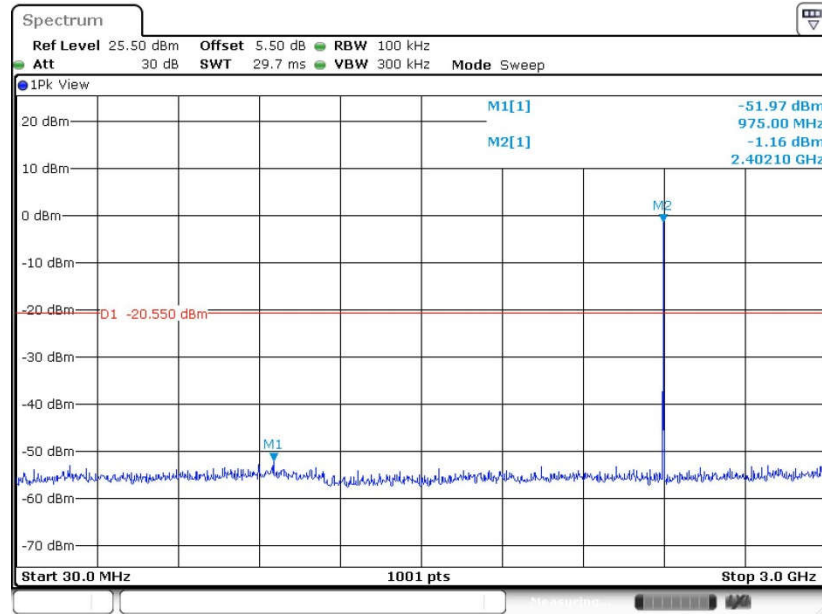

Date: 2 JAN 2018 12:53:40

Conducted Spurious Emission Plot on Bluetooth LE 1Mbps GFSK Channel 00

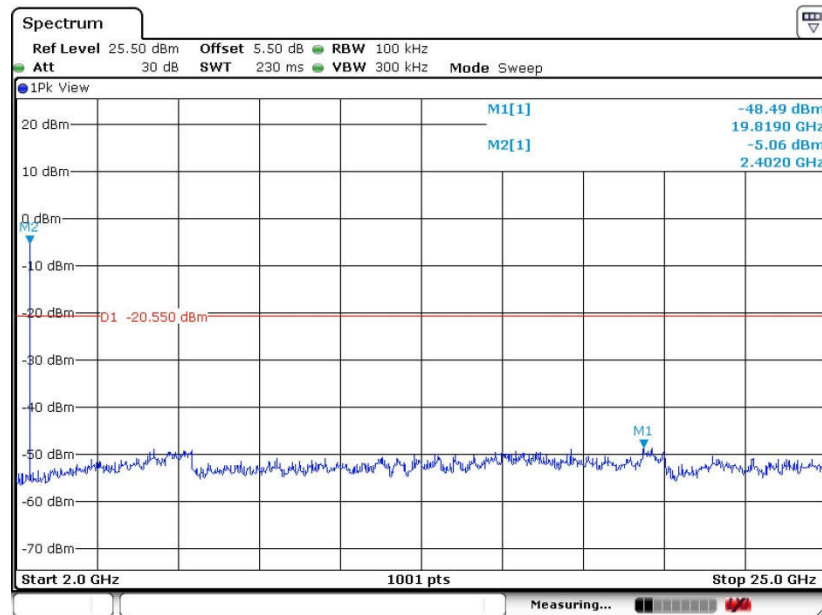

Date: 2 JAN 2018 12:54:10



Conducted Spurious Emission Plot on Bluetooth LE 1Mbps GFSK Channel 19

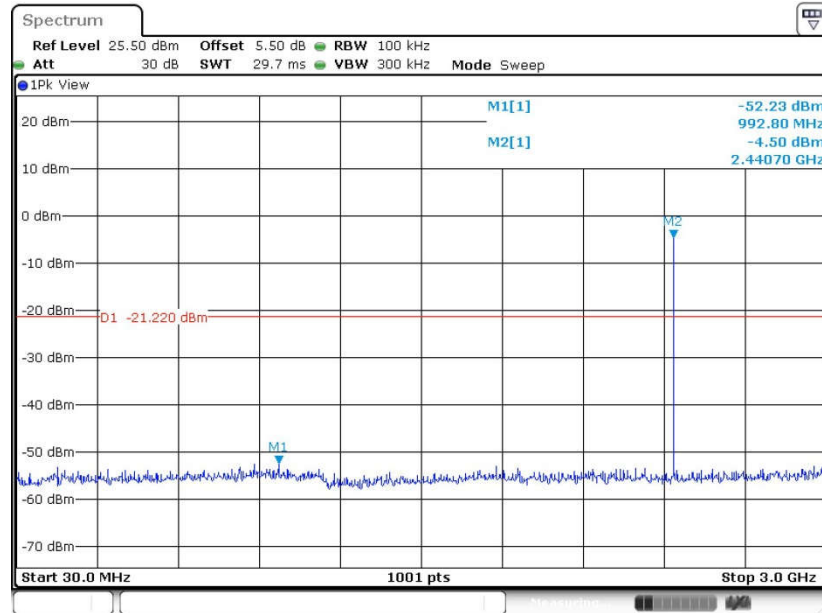

Date: 2 JAN 2018 13:01:13

Conducted Spurious Emission Plot on Bluetooth LE 1Mbps GFSK Channel 19

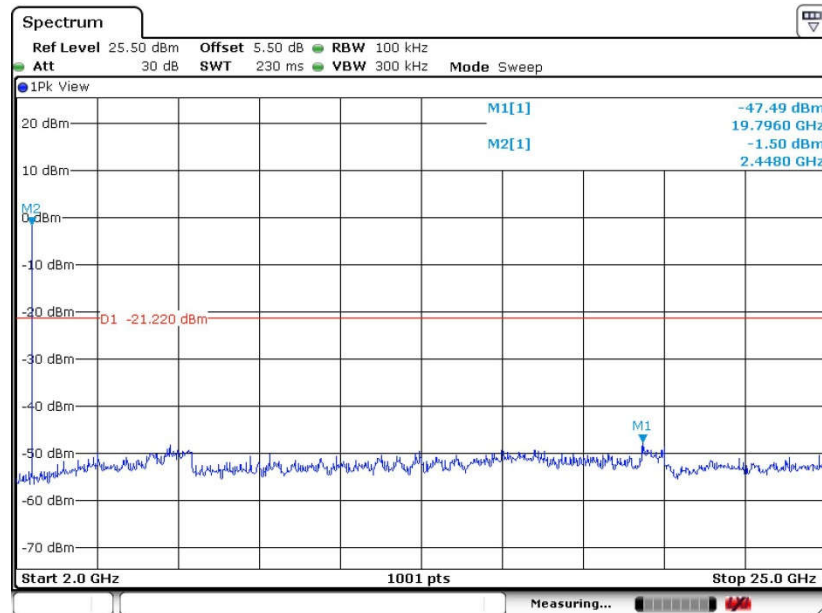

Date: 2 JAN 2018 13:00:28



Conducted Spurious Emission Plot on Bluetooth LE 1Mbps GFSK Channel 39

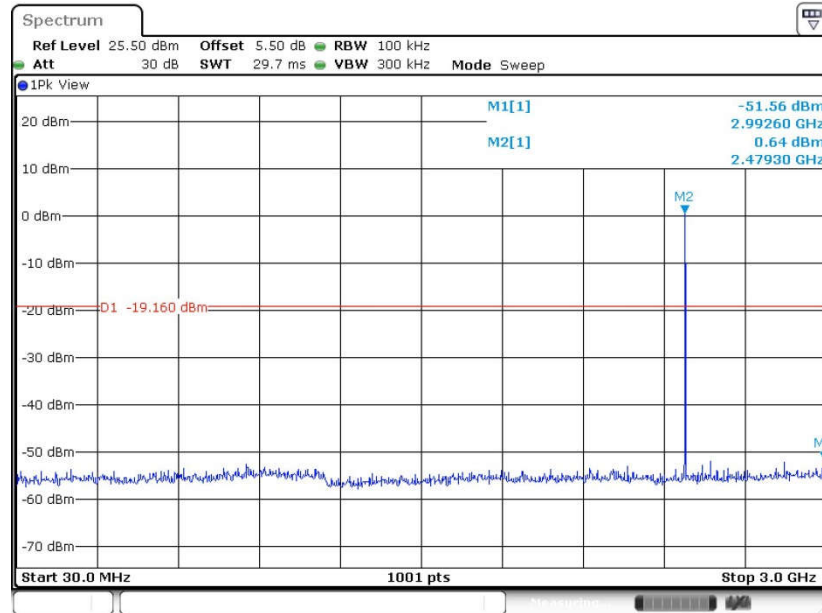

Date: 2 JAN 2018 13:07:32

Conducted Spurious Emission Plot on Bluetooth LE 1Mbps GFSK Channel 39

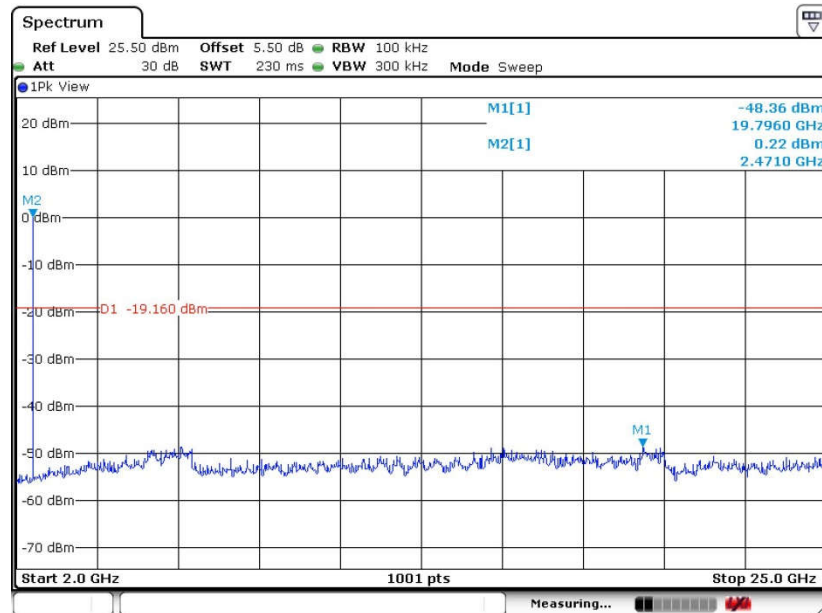

Date: 2 JAN 2018 13:07:59



3.5 Radiated Band Edges and Spurious Emission Measurement

3.5.1 Limit of Radiated Band Edges and Spurious Emission

In any 100 kHz bandwidth outside the intentional radiator frequency band, all harmonics/spurious must be at least 20 dB below the highest emission level within the authorized band. If the output power of this device was measured by spectrum analyzer, the attenuation under this paragraph shall be 30 dB instead of 20 dB. In addition, radiated emissions which fall in the restricted bands must also comply with the limits as below.

Frequency (MHz)	Field Strength (microvolts/meter)	Measurement Distance (meters)
0.009 – 0.490	2400/F(kHz)	300
0.490 – 1.705	24000/F(kHz)	30
1.705 – 30.0	30	30
30 – 88	100	3
88 – 216	150	3
216 - 960	200	3
Above 960	500	3

3.5.2 Measuring Instruments

The section 4.0 of List of Measuring Equipment of this test report is used for test.



3.5.3 Test Procedures

1. The testing follows FCC KDB Publication No. 558074 D01 DTS Meas. Guidance v04.
2. The EUT was arranged to its worst case and then tune the antenna tower (from 1 m to 4 m) and turntable (from 0 degree to 360 degrees) to find the maximum reading. A pre-amp and a high pass filter are used for the test in order to get better signal level.
3. The EUT was placed on a turntable with 0.8 meter for frequency below 1GHz and 1.5 meter for frequency above 1GHz respectively above ground.
4. The EUT was set 3 meters from the interference receiving antenna, which was mounted on the top of a variable height antenna tower.
5. Corrected Reading: Antenna Factor + Cable Loss + Read Level - Preamp Factor = Level
6. For measurement below 1GHz, If the emission level of the EUT measured by the peak detector is 3 dB lower than the applicable limit, the peak emission level will be reported. Otherwise, the emission measurement will be repeated using the quasi-peak detector and reported.
7. Use the following spectrum analyzer settings:
 - (1) Span shall wide enough to fully capture the emission being measured;
 - (2) Set RBW=100 kHz for $f < 1$ GHz; VBW \geq RBW; Sweep = auto; Detector function = peak; Trace = max hold;
 - (3) Set RBW = 1 MHz, VBW= 3MHz for $f \geq 1$ GHz for peak measurement.
For average measurement:
 - VBW = 10 Hz, when duty cycle is no less than 98 percent.
 - VBW $\geq 1/T$, when duty cycle is less than 98 percent where T is the minimum transmission duration over which the transmitter is on and is transmitting at its maximum power control level for the tested mode of operation.

3.5.4 Test Setup

For radiated emissions below 30MHz

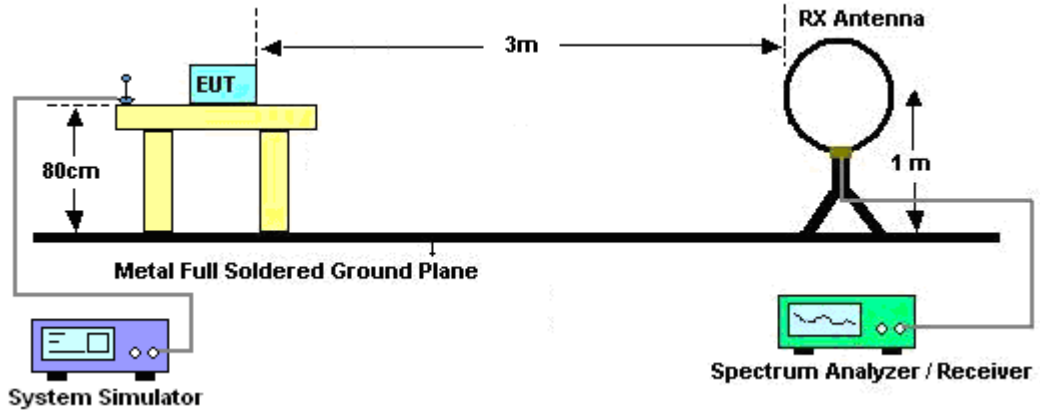

For radiated emissions from 30MHz to 1GHz

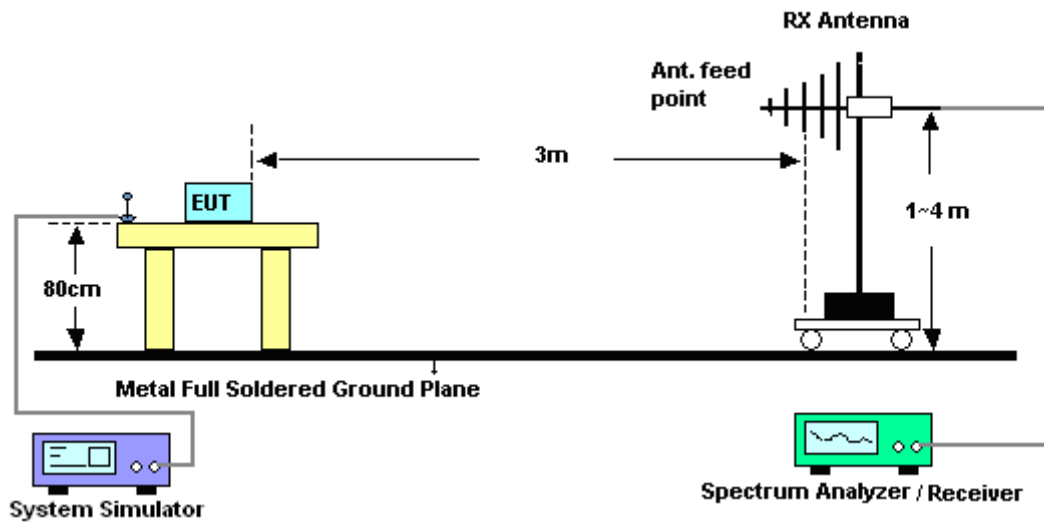

For radiated emissions above 1GHz

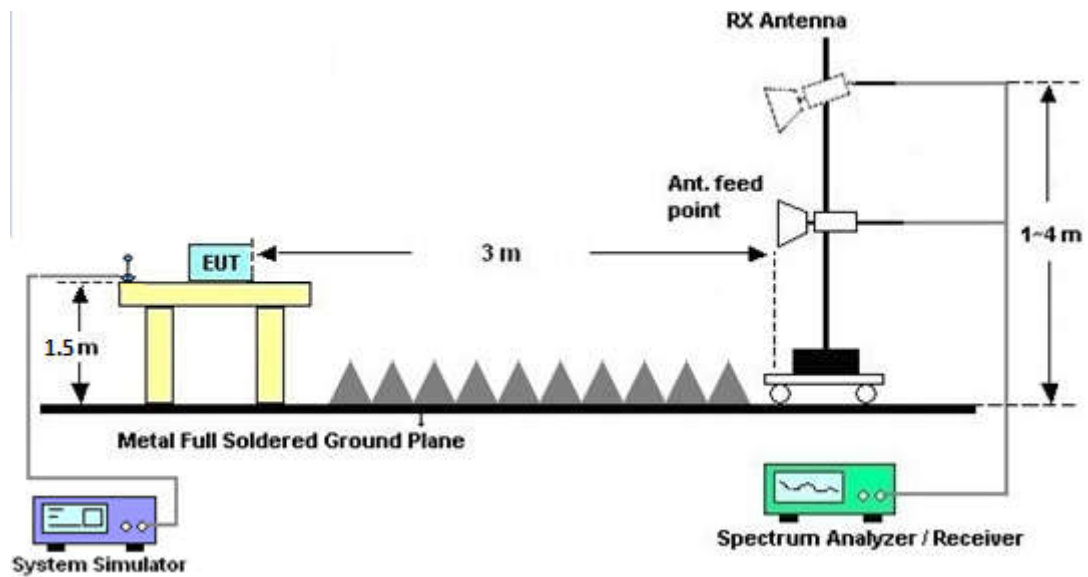

3.5.5 Test Results of Radiated Spurious Emissions (9 kHz ~ 30 MHz)

The low frequency, which started from 9 kHz to 30MHz, was pre-scanned and the result which was 20dB lower than the limit line was not reported.

3.5.6 Test Result of Radiated Spurious at Band Edges

Please refer to Appendix B.

3.5.7 Duty Cycle

Please refer to Appendix C.

3.5.8 Test Result of Radiated Spurious Emission (30MHz ~ 10th Harmonic)

Please refer to Appendix B.



3.6 AC Conducted Emission Measurement

3.6.1 Limit of AC Conducted Emission

For equipment that is designed to be connected to the public utility (AC) power line, the radio frequency voltage that is conducted back onto the AC power line on any frequency or frequencies within the band 150 kHz to 30 MHz shall not exceed the limits in the following table.

Frequency of emission (MHz)	Conducted limit (dBµV)	
	Quasi-peak	Average
0.15-0.5	66 to 56*	56 to 46*
0.5-5	56	46
5-30	60	50

*Decreases with the logarithm of the frequency.

3.6.2 Measuring Instruments

The section 4.0 of List of Measuring Equipment of this test report is used for test.

3.6.3 Test Procedures

1. The EUT was placed 0.4 meter from the conducting wall of the shielding room was kept at least 80 centimeters from any other grounded conducting surface.
2. Connect EUT to the power mains through a line impedance stabilization network (LISN).
3. All the support units are connecting to the other LISN.
4. The LISN provides 50 ohm coupling impedance for the measuring instrument.
5. The FCC states that a 50 ohm, 50 microhenry LISN should be used.
6. Both sides of AC line were checked for maximum conducted interference.
7. The frequency range from 150 kHz to 30 MHz was searched.
8. Set the test-receiver system to Peak Detect Function and specified bandwidth (IF Bandwidth = 9kHz) with Maximum Hold Mode. Then measurement is also conducted by Average Detector and Quasi-Peak Detector Function respectively.

3.6.4 Test Setup

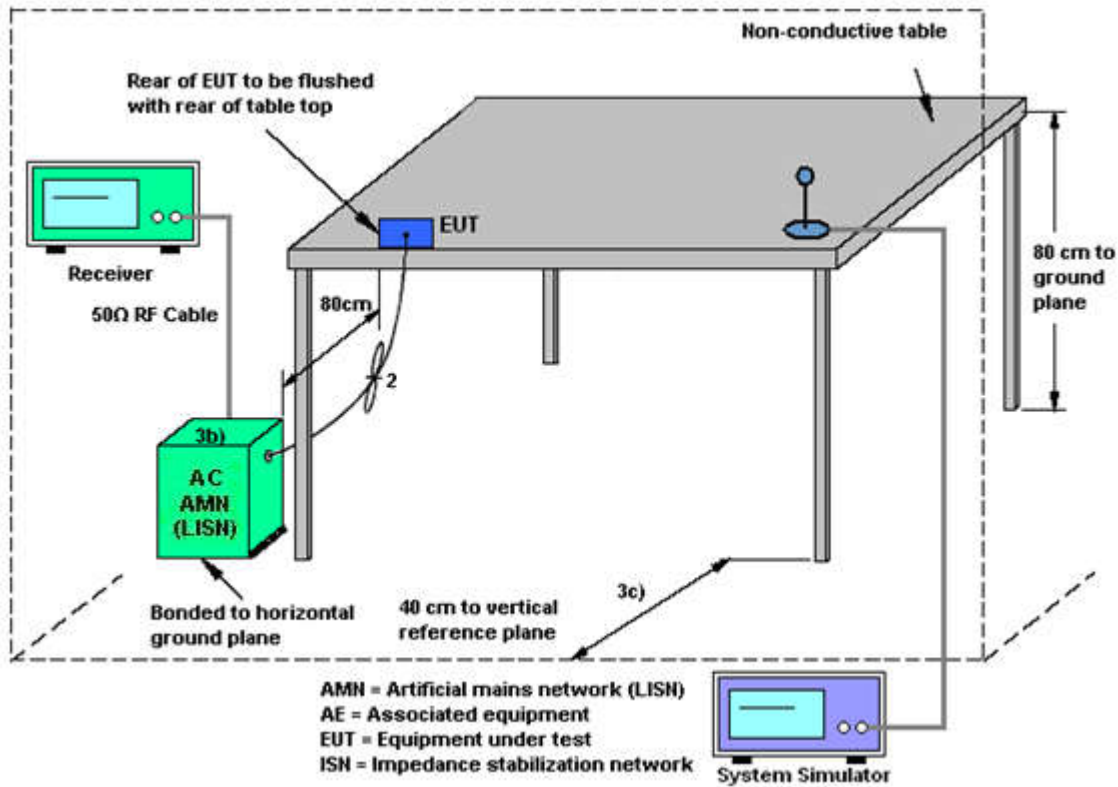



3.6.5 Test Result of AC Conducted Emission

Test Mode :	Mode 1	Temperature :	22~24°C
Test Engineer :	Eko Guan	Relative Humidity :	40~42%
Test Voltage :	120Vac / 60Hz	Phase :	Line
Function Type :	GSM850 Idle + Bluetooth Link + WLAN Link(2.4G) + USB Cable(Charging from Adapter 1) + Earphone		

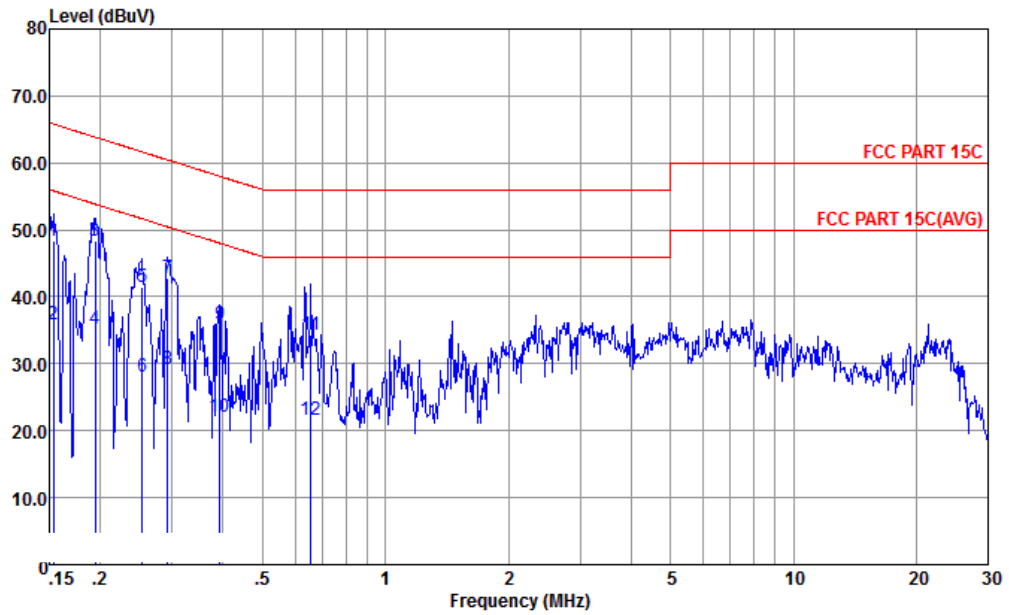

Site : CO01-KS
 Condition : FCC PART 15C LISN-L-171013-060103 LINE
 Project : (FR) 7D2702
 mode : Mode 1

	Freq	Level	Over Limit	Limit Line	Read Level	LISN Factor	Cable Loss	Remark
	MHz	dBuV	dB	dBuV	dBuV	dB	dB	
1	0.153	48.37	-17.45	65.82	37.60	0.16	10.61	QP
2	0.153	35.97	-19.85	55.82	25.20	0.16	10.61	Average
3 *	0.194	48.27	-15.57	63.84	37.60	0.20	10.47	QP
4	0.194	35.27	-18.57	53.84	24.60	0.20	10.47	Average
5	0.253	41.45	-20.19	61.64	30.79	0.22	10.44	QP
6	0.253	28.15	-23.49	51.64	17.49	0.22	10.44	Average
7	0.292	42.85	-17.61	60.46	32.20	0.22	10.43	QP
8	0.292	29.25	-21.21	50.46	18.60	0.22	10.43	Average
9	0.393	35.85	-22.14	57.99	25.20	0.24	10.41	QP
10	0.393	22.15	-25.84	47.99	11.50	0.24	10.41	Average
11	0.658	34.25	-21.75	56.00	23.80	0.26	10.19	QP
12	0.658	21.65	-24.35	46.00	11.20	0.26	10.19	Average



Test Mode :	Mode 1	Temperature :	22~24°C
Test Engineer :	Eko Guan	Relative Humidity :	40~42%
Test Voltage :	120Vac / 60Hz	Phase :	Neutral
Function Type :	GSM850 Idle + Bluetooth Link + WLAN Link(2.4G) + USB Cable(Charging from Adapter 1) + Earphone		

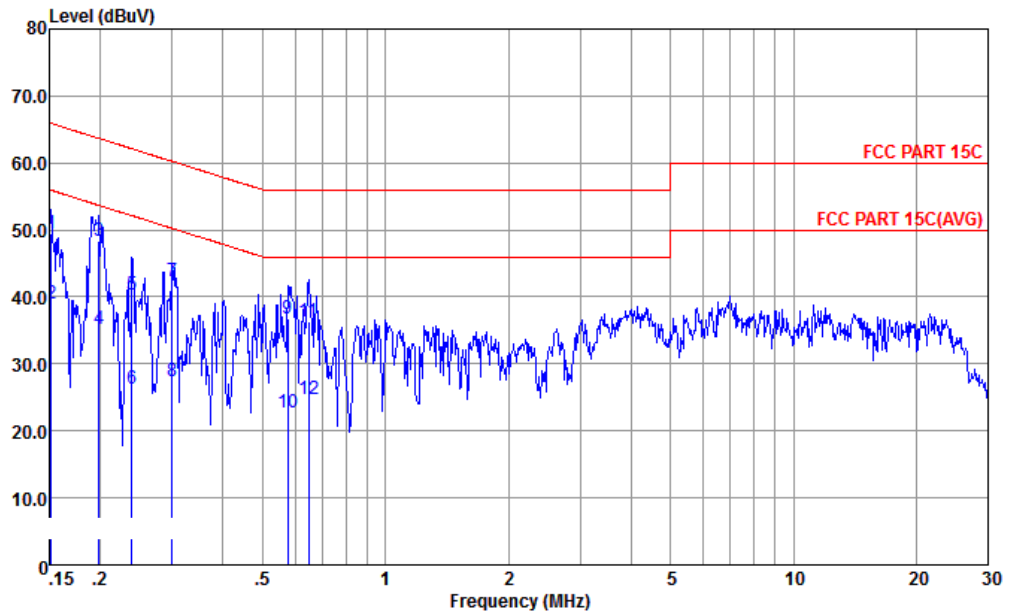

Site : CO01-KS
 Condition : FCC PART 15C LISN-N-171013-060103 NEUTRAL
 Project : (FR) 7D2702
 mode : Mode 1

	Freq	Level	Over Limit	Limit Line	Read Level	LISN Factor	Cable Loss	Remark
	MHz	dBuV	dB	dBuV	dBuV	dB	dB	
1	0.152	49.39	-16.52	65.91	38.50	0.28	10.61	QP
2	0.152	39.09	-16.82	55.91	28.20	0.28	10.61	Average
3 *	0.199	48.34	-15.33	63.67	37.60	0.28	10.46	QP
4	0.199	35.24	-18.43	53.67	24.50	0.28	10.46	Average
5	0.239	40.32	-21.81	62.13	29.60	0.28	10.44	QP
6	0.239	26.22	-25.91	52.13	15.50	0.28	10.44	Average
7	0.300	42.31	-17.93	60.24	31.60	0.28	10.43	QP
8	0.300	27.51	-22.73	50.24	16.80	0.28	10.43	Average
9	0.576	36.74	-19.26	56.00	26.20	0.29	10.25	QP
10	0.576	22.84	-23.16	46.00	12.30	0.29	10.25	Average
11	0.647	36.29	-19.71	56.00	25.79	0.30	10.20	QP
12	0.647	24.79	-21.21	46.00	14.29	0.30	10.20	Average



3.7 Antenna Requirements

3.7.1 Standard Applicable

If directional gain of transmitting antennas is greater than 6dBi, the power shall be reduced by the same level in dB comparing to gain minus 6dBi. The use of a permanently attached antenna or of an antenna that uses a unique coupling to the intentional radiator shall be considered sufficient to comply with the rule.

3.7.2 Antenna Anti-Replacement Construction

An embedded-in antenna design is used.

3.7.3 Antenna Gain

The antenna peak gain of EUT is less than 6 dBi. Therefore, it is not necessary to reduce maximum peak output power limit.



4 List of Measuring Equipment

Instrument	Manufacturer	Model No.	Serial No.	Characteristics	Calibration Date	Test Date	Due Date	Remark
Spectrum Analyzer	R&S	FSV40	101040	10Hz~40GHz	Aug. 08, 2017	Jan. 02, 2018	Aug. 07, 2018	Conducted (TH01-KS)
Pulse Power Sensor	Anritsu	MA2411B	0917070	300MHz~40GHz	Jan. 19, 2017	Jan. 02, 2018	Jan. 19, 2018	Conducted (TH01-KS)
Power Meter	Anritsu	ML2495A	1005002	50MHz Bandwidth	Jan. 19, 2017	Jan. 02, 2018	Jan. 19, 2018	Conducted (TH01-KS)
EMI Test Receiver&SA	Agilent	N9038A	MY52260185	20Hz~26.5GHz	Apr. 20, 2017	Jan. 13, 2018	Apr. 19, 2018	Radiation (03CH01-SZ)
Loop Antenna	R&S	HFH2-Z2	100354	9kHz~30MHz	May 14, 2017	Jan. 13, 2018	May 13, 2018	Radiation (03CH01-SZ)
Bilog Antenna	TeseQ	CBL6112D	23188	30MHz~2GHz	Apr. 25, 2017	Jan. 13, 2018	Apr. 24, 2018	Radiation (03CH01-SZ)
Double Ridge Horn Antenna	ETS Lindgren	3117	119436	1GHz~18GHz	Jul. 28, 2017	Jan. 13, 2018	Jul. 27, 2018	Radiation (03CH01-SZ)
SHF-EHF Horn	com-power	AH-840	101071	18GHz~40GHz	Jun. 16, 2017	Jan. 13, 2018	Jun. 15, 2018	Radiation (03CH01-SZ)
LF Amplifier	Burgeon	BPA-530	102209	0.01~3000Mhz	Apr. 20, 2017	Jan. 13, 2018	Apr. 19, 2018	Radiation (03CH01-SZ)
HF Amplifier	MITEQ	AMF-7D-0010 1800-30-10P-R	1707137	1GHz~18GHz	Oct. 19, 2017	Jan. 13, 2018	Oct. 18, 2018	Radiation (03CH01-SZ)
HF Amplifier	KEYSIGHT	83017A	MY53270104	0.5GHz~26.5GHz	Oct. 19, 2017	Jan. 13, 2018	Oct. 18, 2018	Radiation (03CH01-SZ)
AC Power Source	Chroma	61601	616010001985	N/A	NCR	Jan. 13, 2018	NCR	Radiation (03CH01-SZ)
Turn Table	EM	EM1000	N/A	0~360 degree	NCR	Jan. 13, 2018	NCR	Radiation (03CH01-SZ)
Antenna Mast	EM	EM1000	N/A	1 m~4 m	NCR	Jan. 13, 2018	NCR	Radiation (03CH01-SZ)
EMI Receiver	R&S	ESCI7	100768	9kHz~7GHz;	Apr. 20, 2017	Jan. 22, 2018	Apr. 19, 2018	Conduction (CO01-KS)
AC LISN	MessTec	AN3016	060103	9kHz~30MHz	Oct. 13, 2017	Jan. 22, 2018	Oct. 12, 2018	Conduction (CO01-KS)
AC LISN (for auxiliary equipment)	MessTec	AN3016	060105	9kHz~30MHz	Oct. 13, 2017	Jan. 22, 2018	Oct. 12, 2018	Conduction (CO01-KS)
AC Power Source	Chroma	61602	ABP00000811	AC 0V~300V, 45Hz~1000Hz	Oct. 12, 2017	Jan. 22, 2018	Oct. 11, 2018	Conduction (CO01-KS)



5 Uncertainty of Evaluation

Uncertainty of Conducted Emission Measurement (150 kHz ~ 30 MHz)

Measuring Uncertainty for a Level of Confidence of 95% ($U = 2Uc(y)$)	2.3dB
---	-------

Uncertainty of Radiated Emission Measurement (30 MHz ~ 1000 MHz)

Measuring Uncertainty for a Level of Confidence of 95% ($U = 2Uc(y)$)	4.8dB
---	-------

Uncertainty of Radiated Emission Measurement (1000 MHz ~ 18000 MHz)

Measuring Uncertainty for a Level of Confidence of 95% ($U = 2Uc(y)$)	5.0dB
---	-------

Uncertainty of Radiated Emission Measurement (18000 MHz ~ 40000 MHz)

Measuring Uncertainty for a Level of Confidence of 95% ($U = 2Uc(y)$)	4.3dB
---	-------



Appendix A. Conducted Test Results

BT V4.2 Low Energy

Test Engineer:	Silent Hai	Temperature:	21~25	°C
Test Date:	2018/1/2	Relative Humidity:	51~55	%

TEST RESULTS DATA
6dB and 99% Occupied Bandwidth

Mod.	Data Rate	N _{TX}	CH.	Freq. (MHz)	99% Occupied BW (MHz)	6dB BW (MHz)	6dB BW Limit (MHz)	Pass/Fail
BLE	1Mbps	1	0	2402	1.02	0.67	0.50	Pass
BLE	1Mbps	1	19	2440	1.02	0.67	0.50	Pass
BLE	1Mbps	1	39	2480	1.03	0.67	0.50	Pass

TEST RESULTS DATA
Peak Power Table

Mod.	Data Rate	N _{TX}	CH.	Freq. (MHz)	Peak Conducted Power (dBm)	Conducted Power Limit (dBm)	DG (dBi)	EIRP Power (dBm)	EIRP Power Limit (dBm)	Pass /Fail
BLE	1Mbps	1	0	2402	-0.49	30.00	-2.80	-3.29	36.00	Pass
BLE	1Mbps	1	19	2440	-1.47	30.00	-2.80	-4.27	36.00	Pass
BLE	1Mbps	1	39	2480	0.79	30.00	-2.80	-2.01	36.00	Pass

TEST RESULTS DATA
Average Power Table
(Reporting Only)

Mod.	Data Rate	N _{TX}	CH.	Freq. (MHz)	Duty Factor (dB)	Average Conducted Power (dBm)
BLE	1Mbps	1	0	2402	2.03	-0.76
BLE	1Mbps	1	19	2440	2.03	-1.71
BLE	1Mbps	1	39	2480	2.03	0.59

TEST RESULTS DATA
Peak Power Density

Mod.	Data Rate	N _{TX}	CH.	Freq. (MHz)	Peak PSD (dBm /100kHz)	Peak PSD (dBm /3kHz)	DG (dBi)	Peak PSD Limit (dBm /3kHz)	Pass/Fail
BLE	1Mbps	1	0	2402	-0.58	-15.11	-2.80	8.00	Pass
BLE	1Mbps	1	19	2440	-1.00	-15.46	-2.80	8.00	Pass
BLE	1Mbps	1	39	2480	0.93	-13.63	-2.80	8.00	Pass

Note: PSD (dBm/ 100kHz) is a reference level used for Conducted Band Edges and Conducted Spurious Emission 20dBc limit.

BT V5.0 Low Energy

Test Engineer:	Silent Hai	Temperature:	21~25	°C
Test Date:	2018/1/2	Relative Humidity:	51~55	%

TEST RESULTS DATA
6dB and 99% Occupied Bandwidth

Mod.	Data Rate	N _{TX}	CH.	Freq. (MHz)	99% Occupied BW (MHz)	6dB BW (MHz)	6dB BW Limit (MHz)	Pass/Fail
BLE	1Mbps	1	0	2402	2.03	1.15	0.50	Pass
BLE	1Mbps	1	19	2440	2.03	1.16	0.50	Pass
BLE	1Mbps	1	39	2480	2.03	1.15	0.50	Pass

TEST RESULTS DATA
Peak Power Table

Mod.	Data Rate	N _{TX}	CH.	Freq. (MHz)	Peak Conducted Power (dBm)	Conducted Power Limit (dBm)	DG (dBi)	EIRP Power (dBm)	EIRP Power Limit (dBm)	Pass /Fail
BLE	1Mbps	1	0	2402	-0.32	30.00	-2.80	-3.12	36.00	Pass
BLE	1Mbps	1	19	2440	-1.22	30.00	-2.80	-4.02	36.00	Pass
BLE	1Mbps	1	39	2480	0.92	30.00	-2.80	-1.88	36.00	Pass

TEST RESULTS DATA
Average Power Table
(Reporting Only)

Mod.	Data Rate	N _{TX}	CH.	Freq. (MHz)	Duty Factor (dB)	Average Conducted Power (dBm)
BLE	1Mbps	1	0	2402	4.81	-0.71
BLE	1Mbps	1	19	2440	4.81	-1.48
BLE	1Mbps	1	39	2480	4.81	0.48

TEST RESULTS DATA
Peak Power Density

Mod.	Data Rate	N _{TX}	CH.	Freq. (MHz)	Peak PSD (dBm /100kHz)	Peak PSD (dBm /3kHz)	DG (dBi)	Peak PSD Limit (dBm /3kHz)	Pass/Fail
BLE	1Mbps	1	0	2402	-0.55	-18.70	-2.80	8.00	Pass
BLE	1Mbps	1	19	2440	-1.22	-19.25	-2.80	8.00	Pass
BLE	1Mbps	1	39	2480	0.84	-17.28	-2.80	8.00	Pass

Note: PSD (dBm/ 100kHz) is a reference level used for Conducted Band Edges and Conducted Spurious Emission 20dBc limit.



Appendix B. Radiated Spurious Emission

Bluetooth v4.2 LE

2.4GHz 2400~2483.5MHz

BLE (Band Edge @ 3m)

BLE	Note	Frequency	Level	Over Limit	Limit Line	Read Level	Antenna Factor	Cable Loss	Preamp Factor	Ant Pos	Table Pos	Peak Avg.	Pol.
		(MHz)	(dBμV/m)	(dB)	(dBμV/m)	(dBμV)	(dB/m)	(dB)	(dB)	(cm)	(deg)	(P/A)	(H/V)
BLE CH 00 2402MHz		2319.24	46.92	-27.08	74	41.7	31.57	6.65	33	270	324	P	H
		2365.23	34.95	-19.05	54	29.68	31.54	6.73	33	270	324	A	H
	*	2402	84.28	-	-	78.97	31.5	6.81	33	270	324	P	H
	*	2402	83.46	-	-	78.15	31.5	6.81	33	270	324	A	H
		2332.365	47.21	-26.79	74	41.99	31.57	6.65	33	100	100	P	V
		2380.035	34.98	-19.02	54	29.73	31.52	6.73	33	100	100	A	V
	*	2402	88.81	-	-	83.5	31.5	6.81	33	100	100	P	V
	*	2402	87.99	-	-	82.68	31.5	6.81	33	100	100	A	V
BLE CH 19 2440MHz		2349.2	47.52	-26.48	74	42.24	31.55	6.73	33	281	322	P	H
		2368.52	35.07	-18.93	54	29.82	31.52	6.73	33	281	322	A	H
	*	2440	83.35	-	-	77.78	31.71	6.86	33	281	322	P	H
	*	2440	82.46	-	-	76.89	31.71	6.86	33	281	322	A	H
		2499.51	47.44	-26.56	74	41.6	31.93	6.91	33	281	322	P	H
		2484.04	36.29	-17.71	54	30.52	31.86	6.91	33	281	322	A	H
		2337.02	46.39	-27.61	74	41.19	31.55	6.65	33	283	84	P	V
		2383.36	35.17	-18.83	54	29.92	31.52	6.73	33	283	84	A	V
	*	2440	86.88	-	-	81.31	31.71	6.86	33	283	84	P	V
	*	2440	85.77	-	-	80.2	31.71	6.86	33	283	84	A	V
		2484.25	47.46	-26.54	74	41.69	31.86	6.91	33	283	84	P	V
		2484.11	37.57	-16.43	54	31.8	31.86	6.91	33	283	84	A	V



BLE CH 39 2480MHz	*	2480	86.08	-	-	80.31	31.86	6.91	33	348	179	P	H
	*	2480	85.29	-	-	79.52	31.86	6.91	33	348	179	A	H
		2486.84	46.85	-27.15	74	41.08	31.86	6.91	33	348	179	P	H
		2485.08	35.46	-18.54	54	29.69	31.86	6.91	33	348	179	A	H
	*	2480	91.41	-	-	85.64	31.86	6.91	33	141	127	P	V
	*	2480	90.63	-	-	84.86	31.86	6.91	33	141	127	A	V
		2484	47.25	-26.75	74	41.48	31.86	6.91	33	141	127	P	V
		2484.16	35.47	-18.53	54	29.7	31.86	6.91	33	141	127	A	V
Remark	<ol style="list-style-type: none"> No other spurious found. All results are PASS against Peak and Average limit line. 												



**2.4GHz 2400~2483.5MHz
BLE (Harmonic @ 3m)**

BLE	Note	Frequency (MHz)	Level (dBμV/m)	Over Limit (dB)	Limit Line (dBμV/m)	Read Level (dBμV)	Antenna Factor (dB/m)	Cable Loss (dB)	Preamp Factor (dB)	Ant Pos (cm)	Table Pos (deg)	Peak Avg. (P/A)	Pol. (H/V)
BLE CH 00 2402MHz		4804	46.71	-27.29	74	60.26	33.78	10.89	58.22	161	360	P	H
		4804	44.43	-29.57	74	57.98	33.78	10.89	58.22	161	360	P	V
BLE CH 19 2440MHz		4880	45.34	-28.66	74	58.77	33.75	10.92	58.1	160	360	P	H
		7320	49.13	-24.87	74	58.22	35.49	13.29	57.87	160	360	P	H
		4880	44.82	-29.18	74	58.25	33.75	10.92	58.1	160	360	P	V
		7320	48.65	-25.35	74	57.74	35.49	13.29	57.87	160	360	P	V
BLE CH 39 2480MHz		4960	44.79	-29.21	74	58.01	33.72	11.02	57.96	160	360	P	H
		7440	47.94	-26.06	74	56.66	35.71	13.06	57.49	160	360	P	H
		4960	45.11	-28.89	74	58.33	33.72	11.02	57.96	160	360	P	V
		7440	48.57	-25.43	74	57.29	35.71	13.06	57.49	160	360	P	V
Remark	1. No other spurious found. 2. All results are PASS against Peak and Average limit line.												



Emission below 1GHz

2.4GHz BLE (LF)

BLE	Note	Frequency	Level	Over	Limit	Read	Antenna	Cable	Preamp	Ant	Table	Peak	Pol.
		(MHz)	(dBμV/m)	(dB)	(dBμV/m)	(dBμV)	(dB/m)	(dB)	(dB)	(cm)	(deg)	(P/A)	(H/V)
2.4GHz BLE LF		30.97	25.65	-14.35	40	29.58	27.42	0.25	31.6	100	0	P	H
		94.99	21.2	-22.3	43.5	33.51	18.4	0.79	31.5	-	-	P	H
		192.96	26.94	-16.56	43.5	38.92	17.67	1.57	31.22	-	-	P	H
		435.46	31.28	-14.72	46	33.79	26.07	2.52	31.1	-	-	P	H
		685.72	30.61	-15.39	46	30.96	27.61	3.24	31.2	-	-	P	H
		980.6	33.21	-20.79	54	30.14	30.38	4.11	31.42	-	-	P	H
		34.85	36.6	-3.4	40	41.58	26.3	0.32	31.6	100	100	P	V
		194.9	28.62	-14.88	43.5	40.59	17.65	1.59	31.21	-	-	P	V
		447.1	30.82	-15.18	46	32.79	26.57	2.56	31.1	-	-	P	V
		579.02	30.23	-15.77	46	32.16	26.33	2.94	31.2	-	-	P	V
		891.36	31.4	-14.6	46	30.74	28.16	3.8	31.3	-	-	P	V
		990.3	34.01	-19.99	54	30.71	30.59	4.16	31.45	-	-	P	V
Remark	1. No other spurious found. 2. All results are PASS against limit line.												



Bluetooth v5.0 LE

2.4GHz 2400~2483.5MHz

BLE (Band Edge @ 3m)

BLE	Note	Frequency (MHz)	Level (dBμV/m)	Over Limit (dB)	Limit Line (dBμV/m)	Read Level (dBμV)	Antenna Factor (dB/m)	Cable Loss (dB)	Preamp Factor (dB)	Ant Pos (cm)	Table Pos (deg)	Peak Avg. (P/A)	Pol. (H/V)
BLE CH 00 2402MHz		2325.54	46.52	-27.48	74	41.3	31.57	6.65	33	100	27	P	H
		2366.175	36.3	-17.7	54	31.03	31.54	6.73	33	100	27	A	H
	*	2402	81.51	-	-	76.2	31.5	6.81	33	100	27	P	H
	*	2402	80.02	-	-	74.71	31.5	6.81	33	100	27	A	H
		2320.71	47.13	-26.87	74	41.91	31.57	6.65	33	154	92	P	V
		2317.56	36.5	-17.5	54	31.28	31.57	6.65	33	154	92	A	V
	*	2402	89.27	-	-	83.96	31.5	6.81	33	154	92	P	V
	*	2402	87.4	-	-	82.09	31.5	6.81	33	154	92	A	V
BLE CH 19 2440MHz		2359.98	47.1	-26.9	74	41.83	31.54	6.73	33	122	176	P	H
		2322.04	36.53	-17.47	54	31.31	31.57	6.65	33	122	176	A	H
	*	2440	80.52	-	-	74.95	31.71	6.86	33	122	176	P	H
	*	2440	78.98	-	-	73.41	31.71	6.86	33	122	176	A	H
		2492.44	46.86	-27.14	74	41.02	31.93	6.91	33	122	176	P	H
		2493.7	36.85	-17.15	54	31.01	31.93	6.91	33	122	176	A	H
		2365.44	46.37	-27.63	74	41.1	31.54	6.73	33	126	72	P	V
		2370.06	36.2	-17.8	54	30.95	31.52	6.73	33	126	72	A	V
	*	2440	87.74	-	-	82.17	31.71	6.86	33	126	72	P	V
	*	2440	86.29	-	-	80.72	31.71	6.86	33	126	72	A	V
		2484.6	48.02	-25.98	74	42.25	31.86	6.91	33	126	72	P	V
		2483.97	37.61	-16.39	54	31.84	31.86	6.91	33	126	72	A	V



BLE CH 39 2480MHz	*	2480	84.86	-	-	79.09	31.86	6.91	33	100	179	P	H
	*	2480	83.57	-	-	77.8	31.86	6.91	33	100	179	A	H
		2486.24	47.34	-26.66	74	41.57	31.86	6.91	33	100	179	P	H
		2485.8	37.09	-16.91	54	31.32	31.86	6.91	33	100	179	A	H
	*	2480	91.29	-	-	85.52	31.86	6.91	33	126	135	P	V
	*	2480	89.86	-	-	84.09	31.86	6.91	33	126	135	A	V
		2483.8	48.25	-25.75	74	42.48	31.86	6.91	33	126	135	P	V
		2485.08	37.14	-16.86	54	31.37	31.86	6.91	33	126	135	A	V
Remark	1. No other spurious found. 2. All results are PASS against Peak and Average limit line.												



2.4GHz 2400~2483.5MHz
BLE (Harmonic @ 3m)

BLE	Note	Frequency (MHz)	Level (dBμV/m)	Over Limit (dB)	Limit Line (dBμV/m)	Read Level (dBμV)	Antenna Factor (dB/m)	Cable Loss (dB)	Preamp Factor (dB)	Ant Pos (cm)	Table Pos (deg)	Peak Avg. (P/A)	Pol. (H/V)
BLE CH 00 2402MHz		4804	44.35	-29.65	74	57.9	33.78	10.89	58.22	160	360	P	H
		4804	43.89	-30.11	74	57.44	33.78	10.89	58.22	160	360	P	V
BLE CH 19 2440MHz		4880	44.44	-29.56	74	57.87	33.75	10.92	58.1	160	360	P	H
		7320	48.74	-25.26	74	57.83	35.49	13.29	57.87	160	360	P	H
		4880	44.36	-29.64	74	57.79	33.75	10.92	58.1	160	360	P	V
BLE CH 39 2480MHz		7320	48.08	-25.92	74	57.17	35.49	13.29	57.87	160	360	P	V
		4960	44.5	-29.5	74	57.72	33.72	11.02	57.96	160	360	P	H
		7440	47.37	-26.63	74	56.09	35.71	13.06	57.49	160	360	P	H
		4960	44.29	-29.71	74	57.51	33.72	11.02	57.96	160	360	P	V
		7440	47.84	-26.16	74	56.56	35.71	13.06	57.49	160	360	P	V
Remark	1. No other spurious found. 2. All results are PASS against Peak and Average limit line.												



Emission below 1GHz

2.4GHz BLE (LF)

BLE	Note	Frequency	Level	Over	Limit	Read	Antenna	Cable	Preamp	Ant	Table	Peak	Pol.
		(MHz)	(dBμV/m)	(dB)	(dBμV/m)	(dBμV)	(dB/m)	(dB)	(dB)	(cm)	(deg)	(P/A)	(H/V)
2.4GHz BLE LF		30	26.3	-13.7	40	29.97	27.7	0.23	31.6	100	0	P	H
		189.08	26.59	-16.91	43.5	38.58	17.71	1.54	31.24	-	-	P	H
		431.58	30.97	-15.03	46	33.67	25.9	2.5	31.1	-	-	P	H
		641.1	30.11	-15.89	46	30.89	27.29	3.13	31.2	-	-	P	H
		891.36	31.1	-14.9	46	30.44	28.16	3.8	31.3	-	-	P	H
		964.11	32.13	-21.87	54	29.45	30.02	4.02	31.36	-	-	P	H
		34.85	36.76	-3.24	40	41.74	26.3	0.32	31.6	100	100	P	V
		94.99	20.27	-23.23	43.5	32.58	18.4	0.79	31.5	-	-	P	V
		190.05	28.92	-14.58	43.5	40.91	17.7	1.55	31.24	-	-	P	V
		437.4	30.73	-15.27	46	33.15	26.15	2.53	31.1	-	-	P	V
		662.44	30.47	-15.53	46	31.01	27.48	3.18	31.2	-	-	P	V
		957.32	32.39	-13.61	46	29.86	29.87	3.98	31.32	-	-	P	V
Remark	1. No other spurious found. 2. All results are PASS against limit line.												



Note symbol

*	Fundamental Frequency which can be ignored. However, the level of any unwanted emissions shall not exceed the level of the fundamental frequency.
!	Test result is over limit line.
P/A	Peak or Average
H/V	Horizontal or Vertical



A calculation example for radiated spurious emission is shown as below:

WIFI	Note	Frequency	Level	Over	Limit	Read	Antenna	Cable	Preamp	Ant	Table	Peak	Pol.
Ant.				Limit	Line	Level	Factor	Loss	Factor	Pos	Pos	Avg.	
1+2		(MHz)	(dBμV/m)	(dB)	(dBμV/m)	(dBμV)	(dB/m)	(dB)	(dB)	(cm)	(deg)	(P/A)	(H/V)
802.11b		2390	55.45	-18.55	74	54.51	32.22	4.58	35.86	103	308	P	H
CH 01													
2412MHz		2390	43.54	-10.46	54	42.6	32.22	4.58	35.86	103	308	A	H

- Level(dBμV/m) =
Antenna Factor(dB/m) + Cable Loss(dB) + Read Level(dBμV) - Preamp Factor(dB)
- Over Limit(dB) = Level(dBμV/m) – Limit Line(dBμV/m)

For Peak Limit @ 2390MHz:

- Level(dBμV/m)
= Antenna Factor(dB/m) + Cable Loss(dB) + Read Level(dBμV) - Preamp Factor(dB)
= 32.22(dB/m) + 4.58(dB) + 54.51(dBμV) – 35.86 (dB)
= 55.45 (dBμV/m)
- Over Limit(dB)
= Level(dBμV/m) – Limit Line(dBμV/m)
= 55.45(dBμV/m) – 74(dBμV/m)
= -18.55(dB)

For Average Limit @ 2390MHz:

- Level(dBμV/m)
= Antenna Factor(dB/m) + Cable Loss(dB) + Read Level(dBμV) - Preamp Factor(dB)
= 32.22(dB/m) + 4.58(dB) + 42.6(dBμV) – 35.86 (dB)
= 43.54 (dBμV/m)
- Over Limit(dB)
= Level(dBμV/m) – Limit Line(dBμV/m)
= 43.54(dBμV/m) – 54(dBμV/m)
= -10.46(dB)

Both peak and average measured complies with the limit line, so test result is “PASS”.



Appendix C. Duty Cycle Plots

Band	Duty Cycle(%)	T(ms)	1/T(kHz)	VBW Setting
Bluetooth v4.2 LE	62.59	0.393	2.545	3KHz
Bluetooth v5.0 LE	33.03	0.207	4.831	10KHZ

Bluetooth v4.2 LE

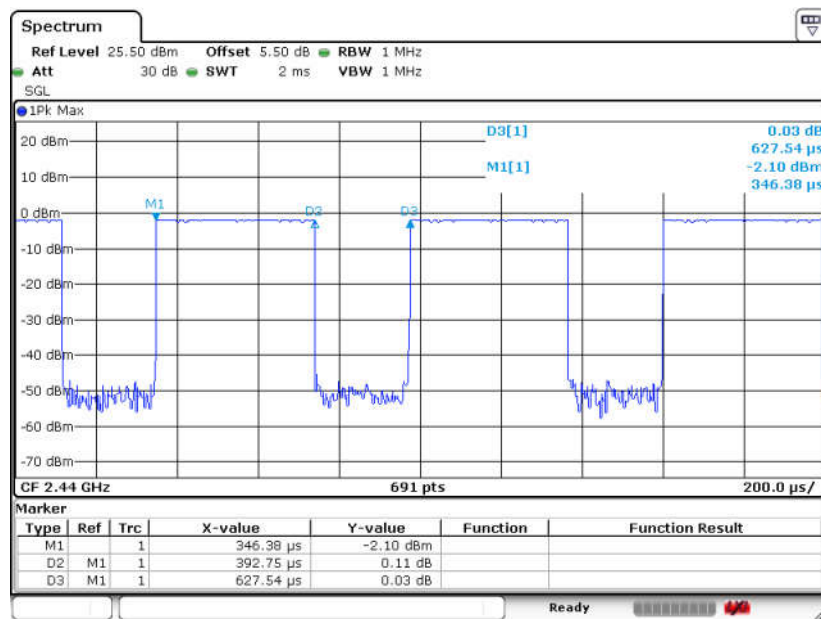



Bluetooth v5.0 LE

