



FCC RF Test Report

APPLICANT : Motorola Mobility LLC
EQUIPMENT : Mobile Cellular Phone
BRAND NAME : Motorola
MODEL NAME : XT1926-5
FCC ID : IHDT56WL3
STANDARD : 47 CFR Part 2, 22(H), 24(E), 27(M)
CLASSIFICATION : PCS Licensed Transmitter Held to Ear (PCE)

The product was received on Dec. 28, 2017 and testing was completed on Mar. 07, 2018. We, Sporton International (Kunshan) Inc., would like to declare that the tested sample has been evaluated in accordance with the test procedures given in ANSI/TIA-603-E and has been in compliance with the applicable technical standards.

This report contains data that were produced under subcontract by Laboratory SPORTON INTERNATIONAL INC.

The test results in this report apply exclusively to the tested model / sample. Without written approval of Sporton International (Kunshan) Inc., the test report shall not be reproduced except in full.



Approved by: James Huang / Manager

Sporton International (Kunshan) Inc.

No.3-2 Ping-Xiang Rd, Kunshan Development Zone Kunshan City Jiangsu Province 215335 China



TABLE OF CONTENTS

1 GENERAL DESCRIPTION 5
1.1 Applicant 5
1.2 Manufacturer 5
1.3 Product Feature of Equipment Under Test 5
1.4 Product Specification of Equipment Under Test 6
1.5 Modification of EUT 6
1.6 Re-use of Measured Data 7
1.7 Maximum ERP/EIRP Power, Frequency Tolerance, and Emission Designator 8
1.8 Testing Location 11
1.9 Applicable Standards 12
2 TEST CONFIGURATION OF EQUIPMENT UNDER TEST 13
2.1 Test Mode 13
2.2 Connection Diagram of Test System 15
2.3 Support Unit used in test configuration and system 16
2.4 Measurement Results Explanation Example 16
2.5 Frequency List of Low/Middle/High Channels 17
3 CONDUCTED TEST ITEMS 19
3.1 Measuring Instruments 19
3.2 Test Setup 19
3.3 Test Result of Conducted Test 19
3.4 Conducted Output Power and ERP/EIRP 20
3.5 Peak-to-Average Ratio 21
3.6 Occupied Bandwidth 22
3.7 Conducted Band Edge 23
3.8 Conducted Spurious Emission 25
3.9 Frequency Stability 26
4 RADIATED TEST ITEMS 27
4.1 Measuring Instruments 27
4.2 Test Setup 27
4.3 Test Result of Radiated Test 27
4.4 Radiated Spurious Emission 28
5 LIST OF MEASURING EQUIPMENT 29
6 UNCERTAINTY OF EVALUATION 30
APPENDIX A. TEST RESULTS OF CONDUCTED TEST
APPENDIX B. TEST RESULTS OF RADIATED TEST
APPENDIX C. TEST SETUP PHOTOGRAPHS
APPENDIX D. REFERENCE REPORT



REVISION HISTORY

REPORT NO.	VERSION	DESCRIPTION	ISSUED DATE
FG7D2702-05B	Rev. 01	Initial issue of report	Mar. 12, 2018



SUMMARY OF TEST RESULT

Report Section	FCC Rule	Description	Limit	Result	Remark
3.4	§2.1046	Conducted Output Power	Reporting Only	PASS	-
	§22.913(a)(2)	Effective Radiated Power (Band 5) (Band 26)	ERP < 7 Watt	PASS	-
	§24.232(c) §27.50(h)(2)	Equivalent Isotropic Radiated Power (Band 2) (Band 7) (Band 38)	EIRP < 2Watt	PASS	-
3.5	N/A	Peak-to-Average Ratio	<13 dB	PASS	-
3.6	§2.1049	Occupied Bandwidth	Reporting Only	PASS	-
3.7	§2.1051 §22.917(a)	Conducted Band Edge Measurement (Band 5) (Band 26)	< 43+10log ₁₀ (P[Watts])	PASS	-
	§27.53(m)(4)	Conducted Band Edge Measurement (Band 7) (Band 38)	§27.53(m)(4)		
3.8	§2.1051 §22.917(a)	Conducted Spurious Emission (Band 5) (Band 26)	< 43+10log ₁₀ (P[Watts])	PASS	-
	§2.1051 §27.53(m)(4)	Conducted Spurious Emission (Band 7)(Band 38)	< 55+10log ₁₀ (P[Watts])		
3.9	§2.1055 §22.355	Frequency Stability Temperature & Voltage	< 2.5 ppm for Part 22H	PASS	-
	§2.1055 §27.54		Within Authorized Band		
4.4	§2.1053 §22.917(a) §24.238(a)	Radiated Spurious Emission (Band 2) (Band 5) (Band 26)	< 43+10log ₁₀ (P[Watts])	PASS	Under limit 16.18 dB at 15606.000 MHz
	§2.1053 §27.53(m)(4)	Radiated Spurious Emission (Band 7)(Band 38)	< 55+10log ₁₀ (P[Watts])		



1 General Description

1.1 Applicant

Motorola Mobility LLC
222 W,Merchandise Mart Plaza, Chicago IL 60654 USA

1.2 Manufacturer

Motorola Mobility LLC
222 W,Merchandise Mart Plaza, Chicago IL 60654 USA

1.3 Product Feature of Equipment Under Test

Product Feature	
Equipment	Mobile Cellular Phone
Brand Name	Motorola
Model Name	XT1926-5
FCC ID	IHDT56WL3
EUT supports Radios application	GSM/GPRS/EGPRS/WCDMA/HSPA/DC-HSDPA/ HSPA+(16QAM uplink is not supported)/LTE/NFC WLAN 2.4GHz 802.11b/g/n HT20 WLAN 5GHz 802.11a/n HT20/HT40 WLAN 5GHz 802.11ac VHT20/VHT40/VHT80 Bluetooth v3.0+EDR/ Bluetooth v4.0 LE/ Bluetooth v4.1 LE/ Bluetooth v4.2 LE/ Bluetooth v5.0 LE
IMEI Code	Conducted: 351855090020373 for LTE B5 351855090019391/351855090019409 for LTE B7/B26/38 Radiation: 351855090018310/351855090018328
HW Version	DVT1B
SW Version	evert_n-userdebug 8.0.0 OPW27.88 1825 intcfg,test-keys
EUT Stage	Identical Prototype



1.4 Product Specification of Equipment Under Test

Standards-related Product Specification	
Tx Frequency	LTE Band 2 : 1850.7 MHz ~ 1909.3 MHz LTE Band 5 : 824.7 MHz ~ 848.3 MHz LTE Band 7 : 2502.5 MHz ~ 2567.5 MHz LTE Band 26 : 824.7MHz ~ 848.3 MHz LTE Band 38 : 2572.5MHz ~ 2617.5MHz
Rx Frequency	LTE Band 2 : 1930.7 MHz ~ 1989.3 MHz LTE Band 5 : 869.7 MHz ~ 893.3 MHz LTE Band 7 : 2622.5MHz ~ 2687.5 MHz LTE Band 26 : 869.7MHz ~ 893.3MHz LTE Band 38 : 2572.5MHz ~ 2617.5MHz
Bandwidth	LTE Band 2 : 1.4MHz / 3MHz / 5MHz / 10MHz / 15MHz / 20MHz LTE Band 5 : 1.4MHz / 3MHz / 5MHz / 10MHz LTE Band 7 : 5MHz / 10MHz / 15MHz / 20MHz LTE Band 26 : 1.4MHz / 3MHz / 5MHz / 10MHz / 15MHz LTE Band 38 : 5MHz / 10MHz / 15MHz / 20MHz
Maximum Output Power to Antenna	LTE Band 2 : 23.20 dBm LTE Band 5 : 23.47 dBm LTE Band 7 : 23.32 dBm LTE Band 26 : 23.33 dBm LTE Band 38 : 22.84 dBm
Antenna Gain	LTE Band 2 : -0.60 dBi LTE Band 5 : -3.30 dBi LTE Band 7 : -2.10 dBi for Antenna #2, -0.50 dBi for Antenna #3 LTE Band 26 : -3.30 dBi LTE Band 38 : -2.30 dBi for Antenna #2, -0.50 dBi for Antenna #3
Type of Modulation	QPSK / 16QAM / 64QAM

1.5 Modification of EUT

No modifications are made to the EUT during all test items.



1.6 Re-use of Measured Data

1.6.1 Introduction Section

This application re-uses data collected on a similar device. The subject device of this application (Model: XT1926-5, FCC ID: IHDT56WL3) is electrically identical to the reference device (Model: XT1926-6, XT1926-7, FCC ID: IHDT56WL4) for the portions of the circuitry corresponding to the data being re-used, as treated by KDB Publication 178919 D01.

1.6.2 Difference Section

For details concerning the similarity with respect to component placement, mechanical/electrical design etc., please refer to the Product Equality Declaration.

The re-used RF data includes the following bands provided in Appendix D (Sporton RF Report No. FG7D2702B for the reference device Model: XT1926-6, XT1926-7, FCC ID: IHDT56WL4):

1.6.3 Spot Check Verification Data Section

In order to confirm hardware similarity of the subject device with the reference device, spot check measurements were performed on the subject device for conducted spurious emission and conducted Band-edge, the test result were consistent with FCC ID: IHDT56WL4 and added new Band 26/ 38 to full test and LTE Band 5/7 to full re-test.

Assertions concerning the similarity of these devices are based on representations by the applicant. The applicant accepts full responsibility for the validity of the similarity claim, and for the determination that verification test data are sufficient to support it.

1.6.4 Reference detail Section:

Equipment Class	Reference FCC ID	Folder Test	Report Title/Section
PCE (2G/3G)	IHDT56WL4	Part22H.24E.27L (FG7D2702A)	All Conducted Items(except WCDMA Band V) sections applicable
PCE (LTE)	IHDT56WL4	Part22H.24E.27L.27M. 27H (FG7D2702B)	All Conducted Items sections applicable for LTE Band 2



1.7 Maximum ERP/EIRP Power, Frequency Tolerance, and Emission Designator

LTE Band 2		QPSK			16QAM		
BW (MHz)	Frequency Range (MHz)	Emission Designator (99%OBW)	Frequency Tolerance (ppm)	Maximum EIRP(W)	Emission Designator (99%OBW)	Frequency Tolerance (ppm)	Maximum EIRP(W)
1.4	1850.7 ~ 1909.3	-	-	0.1786	-	-	0.1589
3	1851.5 ~ 1908.5	-	-	0.1811	-	-	0.1607
5	1852.5 ~ 1907.5	-	-	0.1816	-	-	0.1607
10	1855.0 ~ 1905.0	-	-	0.1816	-	-	0.1644
15	1857.5 ~ 1902.5	-	-	0.1791	-	-	0.1626
20	1860.0 ~ 1900.0	-	-	0.1820	-	-	0.1656
LTE Band 2		64QAM					
BW (MHz)	Frequency Range (MHz)	Emission Designator (99%OBW)		Frequency Tolerance (ppm)	Maximum EIRP(W)		
1.4	1850.7 ~ 1909.3	-		-	0.1349		
3	1851.5 ~ 1908.5	-		-	0.1349		
5	1852.5 ~ 1907.5	-		-	0.1349		
10	1855.0 ~ 1905.0	-		-	0.1380		
15	1857.5 ~ 1902.5	-		-	0.1368		
20	1860.0 ~ 1900.0	-		-	0.1377		
LTE Band 5		QPSK			16QAM		
BW (MHz)	Frequency Range (MHz)	Emission Designator (99%OBW)	Frequency Tolerance (ppm)	Maximum ERP(W)	Emission Designator (99%OBW)	Frequency Tolerance (ppm)	Maximum ERP(W)
1.4	824.7 ~ 848.3	1M10G7D	-	0.0628	1M09W7D	-	0.0553
3	825.5 ~ 847.5	2M73G7D	-	0.0628	2M73W7D	-	0.0545
5	826.5 ~ 846.5	4M51G7D	-	0.0625	4M52W7D	-	0.0551
10	829.0 ~ 844.0	9M05G7D	0.0054	0.0634	9M03W7D	-	0.0555
LTE Band 5		64QAM					
BW (MHz)	Frequency Range (MHz)	Emission Designator (99%OBW)		Frequency Tolerance (ppm)	Maximum EIRP(W)		
1.4	824.7 ~ 848.3	1M09G7D		-	0.0448		
3	825.5 ~ 847.5	2M75G7D		-	0.0451		
5	826.5 ~ 846.5	4M52G7D		-	0.0448		
10	829.0 ~ 844.0	9M05G7D		-	0.0451		



LTE Band 7		QPSK				16QAM			
BW (MHz)	Frequency Range (MHz)	Emission Designator (99%OBW)	Frequency Tolerance (ppm)	Maximum EIRP(W)		Emission Designator (99%OBW)	Frequency Tolerance (ppm)	Maximum EIRP(W)	
				Ant.2	Ant.3			Ant.2	Ant.3
5	2502.5 ~ 2567.5	4M53G7D	-	0.1312	0.1897	4M52W7D	-	0.1114	0.1611
10	2505.0 ~ 2565.0	9M05G7D	0.0032	0.1297	0.1875	9M05W7D	-	0.1117	0.1614
15	2507.5 ~ 2562.5	13M5G7D	-	0.1318	0.1905	13M4W7D	-	0.1104	0.1596
20	2510.0 ~ 2560.0	18M5G7D	-	0.1324	0.1914	18M5W7D	-	0.1099	0.1589
LTE Band 7		64QAM							
BW (MHz)	Frequency Range (MHz)	Emission Designator (99%OBW)	Frequency Tolerance (ppm)	Maximum EIRP(W)				Maximum EIRP(W)	
				Ant.2	Ant.3	Ant.2	Ant.3		
5	2502.5 ~ 2567.5	4M51W7D	-	-	-	0.0881	-	0.1274	-
10	2505.0 ~ 2565.0	9M05W7D	-	-	-	0.0891	-	0.1288	-
15	2507.5 ~ 2562.5	13M5W7D	-	-	-	0.0902	-	0.1303	-
20	2510.0 ~ 2560.0	18M4W7D	-	-	-	0.0910	-	0.1315	-
LTE Band 26		QPSK			16QAM				
BW (MHz)	Frequency Range (MHz)	Emission Designator (99%OBW)	Frequency Tolerance (ppm)	Maximum ERP(W)	Emission Designator (99%OBW)	Frequency Tolerance (ppm)	Maximum ERP(W)		
1.4	824.7 ~ 848.3	1M09G7D	-	0.0586	1M09W7D	-	0.0515		
3	825.5 ~ 847.5	2M73G7D	-	0.0598	2M73W7D	-	0.0522		
5	826.5 ~ 846.5	4M51G7D	-	0.0600	4M51W7D	-	0.0519		
10	829.0 ~ 844.0	9M05G7D	0.0086	0.0600	9M05W7D	-	0.0521		
15	831.5 ~ 841.5	13M5G7D	-	0.0614	13M4W7D	-	0.0538		
CH26765	821.5	13M4G7D	-	0.0610	13M5W7D	-	0.0527		
LTE Band 26		64QAM							
BW (MHz)	Frequency Range (MHz)	Emission Designator (99%OBW)	Frequency Tolerance (ppm)			Maximum ERP(W)			
1.4	824.7 ~ 848.3	1M09W7D	-	-	-	0.0430	-		
3	825.5 ~ 847.5	2M73W7D	-	-	-	0.0442	-		
5	826.5 ~ 846.5	4M54W7D	-	-	-	0.0427	-		
10	829.0 ~ 844.0	9M11W7D	-	-	-	0.0432	-		
15	831.5 ~ 841.5	13M4W7D	-	-	-	0.0441	-		
CH26765	821.5	13M4W7D	-	-	-	0.0434	-		



LTE Band 38		QPSK				16QAM			
BW (MHz)	Frequency Range (MHz)	Emission Designator (99%OBW)	Frequency Tolerance (ppm)	Maximum EIRP(W)		Emission Designator (99%OBW)	Frequency Tolerance (ppm)	Maximum EIRP(W)	
				Ant.2	Ant.3			Ant.2	Ant.3
5	2572.5 ~ 2617.5	4M49G7D	-	0.1130	0.1710	4M51W7D	-	0.0925	0.1400
10	2575.0 ~ 2615.0	9M07G7D	0.0023	0.1127	0.1706	9M05W7D	-	0.0938	0.1419
15	2577.5 ~ 2612.5	13M5G7D	-	0.1122	0.1698	13M6W7D	-	0.0923	0.1396
20	2580.0 ~ 2610.0	18M4G7D	-	0.1132	0.1714	18M5W7D	-	0.0916	0.1387
LTE Band 38		64QAM							
BW (MHz)	Frequency Range (MHz)	Emission Designator (99%OBW)	Frequency Tolerance (ppm)	Maximum EIRP(W)					
				Ant.2	Ant.3	Ant.2	Ant.3	Ant.2	Ant.3
5	2572.5 ~ 2617.5	4M51W7D	-			0.0767		0.1161	
10	2575.0 ~ 2615.0	9M07W7D	-			0.0745		0.1127	
15	2577.5 ~ 2612.5	13M5W7D	-			0.0745		0.1127	
20	2580.0 ~ 2610.0	18M4W7D	-			0.0733		0.1109	



1.8 Testing Location

Sporton International (Kunshan) Inc. is accredited to ISO 17025 by National Voluntary Laboratory Accreditation Program (NVLAP code: 600155-0) and the FCC designation No. is CN5013.

Test Site	Sporton International (Kunshan) Inc.		
Test Site Location	No.3-2 Ping-Xiang Rd, Kunshan Development Zone Kunshan City Jiangsu Province 215335 China TEL : +86-512-57900158 FAX : +86-512-57900958		
Test Site No.	Sporton Site No.	FCC Test Firm Registration No.	
	TH01-KS	630927	

Note: The test site complies with ANSI C63.4 2014 requirement.

SPORTON INTERNATIONAL INC. is accredited to ISO 17025 by Taiwan Accreditation Foundation (TAF code : 1190) and under the FCC-recognized accredited testing laboratories by Mutual Recognition Agreement (MRA) in FCC Test.

Test Site	SPORTON INTERNATIONAL INC.		
Test Site Location	No.58, Aly. 75, Ln. 564 Wenhua 3rd Rd. Guishan Dist. Taoyuan City Taiwan TEL: +886-3-327-3456 FAX: +886-3-328-4978		
Test Site No.	Sporton Site No.	FCC designation No.	FCC Test Firm Registration No.
	03CH12-HY	TW0007	214511

Note:

1. The test site complies with ANSI C63.4 2014 requirement.
2. Test data subcontracted: radiated spurious emissions only in section 4.4 of this report.



1.9 Applicable Standards

According to the specifications of the manufacturer, the EUT must comply with the requirements of the following standards:

- ♦ 47 CFR Part 2, 22(H), 24(E), 27(M)
- ♦ ANSI/TIA-603-E
- ♦ FCC KDB 971168 D01 Power Meas License Digital Systems v03
- ♦ FCC KDB 412172 D01 Determining ERP and EIRP v01r01

Remark:

1. All test items were verified and recorded according to the standards and without any deviation during the test.
2. This EUT has also been tested and complied with the requirements of FCC Part 15, Subpart B, recorded in a separate test report.



2 Test Configuration of Equipment Under Test

2.1 Test Mode

Antenna port conducted and radiated test items listed below are performed according to KDB 971168 D01 Power Meas License Digital Systems v03 with maximum output power.

Radiated measurements are performed by rotating the EUT in three different orthogonal test planes to find the maximum emission.

Test Items	Band	Bandwidth (MHz)						Modulation			RB #			Test Channel		
		1.4	3	5	10	15	20	QPSK	16QAM	64QAM	1	Half	Full	L	M	H
Max. Output Power	2	√	√	√	√	√	√	√	√	√	√	√	√	√	√	√
	5	√	√	√	√	-	-	√	√	√	√	√	√	√	√	√
	7	-	-	√	√	√	√	√	√	√	√	√	√	√	√	√
	38	-	-	√	√	√	√	√	√	√	√	√	√	√	√	√
	26	√	√	√	√	√	-	√	√	√	√	√	√	√	√	√
Peak-to-Average Ratio	2						√	√	√	√	√		√	-	-	-
	5				√	-	-	√	√	√	√		√	√	√	√
	7	-	-				√	√	√	√	√		√	√	√	√
	38	-	-				√	√	√	√	√		√	√	√	√
	26					√	-	√	√	√	√		√	√	√	√

Test Items	Band	Bandwidth (MHz)						Modulation			RB #			Test Channel		
		1.4	3	5	10	15	20	QPSK	16QAM	64QAM	1	Half	Full	L	M	H
26dB and 99% Bandwidth	2	√	√	√	√	√	√	√	√	√			√	-	-	-
	5	√	√	√	√	-	-	√	√	√			√	√	√	√
	7	-	-	√	√	√	√	√	√	√			√	√	√	√
	38	-	-	√	√	√	√	√	√	√			√	√	√	√
	26	√	√	√	√	√	-	√	√	√			√	√	√	√
Conducted Band Edge	2	√	√	√	√	√	√	√	√	√	√		√	-		-
	5	√	√	√	√	-	-	√	√	√	√		√	√		√
	7	-	-	√	√	√	√	√	√	√	√		√	√		√
	38	-	-	√	√	√	√	√	√	√	√		√	√		√
	26	√	√	√	√	√	-	√	√	√	√		√	√		√



Test Items	Band	Bandwidth (MHz)						Modulation			RB #			Test Channel		
		1.4	3	5	10	15	20	QPSK	16QAM	64QAM	1	Half	Full	L	M	H
Conducted Spurious Emission	2	√	√	√	√	√	√	√	√	√	√			-	-	-
	5	√	√	√	√	-	-	√	√	√	√			√	√	√
	7	-	-	√	√	√	√	√	√	√	√			√	√	√
	38	-	-	√	√	√	√	√	√	√	√			√	√	√
	26	√	√	√	√	√	-	√	√	√	√			√	√	√
Frequency Stability	2				√			√					√		-	
	5				√	-	-	√					√		√	
	7	-	-		√			√					√		√	
	38	-	-		√			√					√		√	
	26				√		-	√					√		√	

Test Items	Band	Bandwidth (MHz)						Modulation			RB #			Test Channel		
		1.4	3	5	10	15	20	QPSK	16QAM	64QAM	1	Half	Full	L	M	H
E.R.P./ E.I.R.P.	2	√	√	√	√	√	√	√	√	√	√			√	√	√
	5	√	√	√	√	-	-	√	√	√	√			√	√	√
	7	-	-	√	√	√	√	√	√	√	√			√	√	√
	38	-	-	√	√	√	√	√	√	√	√			√	√	√
	26	√	√	√	√	√	-	√	√	√	√			√	√	√
Radiated Spurious Emission	2						√	√			√			√	√	√
	5				√	-	-	√			√			√	√	√
	7	-	-				√	√			√			√	√	√
	38	-	-				√	√			√			√	√	√
	26					√	-	√			√			√	√	√

Note

- The mark "√" means that this configuration is chosen for testing
- The mark "-" means that this bandwidth is not supported.
- The device is investigated from 30MHz to 10 times of fundamental signal for radiated spurious emission test under different BW/RB size/offset and modulations in exploratory test. Subsequently, only the worst case emissions are reported.
- Antenna #2 and Antenna #3 support LTE Band 7/38, the two antenna could switch Main Antenna and Diversity Antenna for each other.

2.2 Connection Diagram of Test System

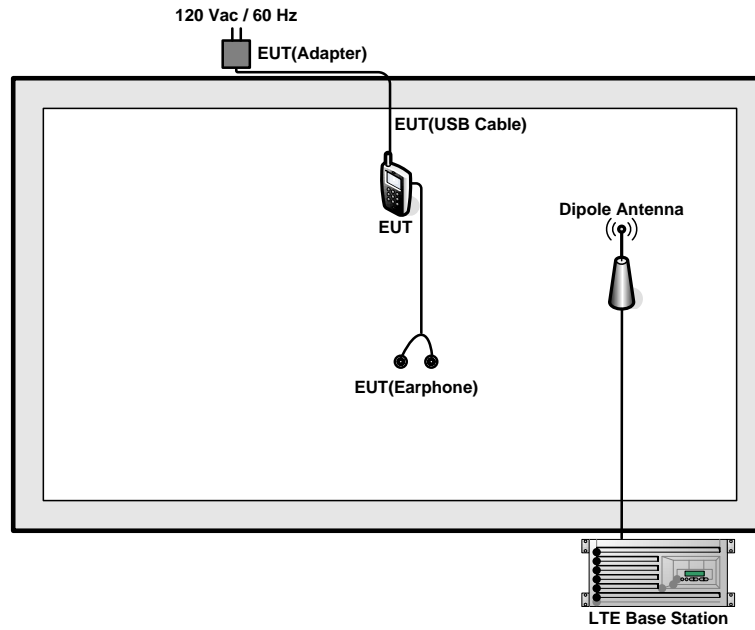



2.3 Support Unit used in test configuration and system

Item	Equipment	Trade Name	Model No.	FCC ID	Data Cable	Power Cord
1.	LTE Base Station	Anritsu	MT8820C	N/A	N/A	Unshielded, 1.8 m
2.	DC Power Supply	GW	GPS-3030D	N/A	N/A	Unshielded, 1.8 m

2.4 Measurement Results Explanation Example

For all conducted test items:

The offset level is set in the spectrum analyzer to compensate the RF cable loss between EUT conducted output port and spectrum analyzer. With the offset compensation, the spectrum analyzer reading level is exactly the EUT RF output level.

The spectrum analyzer offset is derived from RF cable loss.

Offset = RF cable loss.

Following shows an offset computation example with cable loss 4.5 dB.

Example :

$$\begin{aligned} \text{Offset(dB)} &= \text{RF cable loss(dB)}. \\ &= 4.5 \text{ (dB)} \end{aligned}$$



2.5 Frequency List of Low/Middle/High Channels

LTE Band 2 Channel and Frequency List				
BW [MHz]	Channel/Frequency(MHz)	Lowest	Middle	Highest
20	Channel	18700	18900	19100
	Frequency	1860	1880	1900
15	Channel	18675	18900	19125
	Frequency	1857.5	1880	1902.5
10	Channel	18650	18900	19150
	Frequency	1855	1880	1905
5	Channel	18625	18900	19175
	Frequency	1852.5	1880	1907.5
3	Channel	18615	18900	19185
	Frequency	1851.5	1880	1908.5
1.4	Channel	18607	18900	19193
	Frequency	1850.7	1880	1909.3

LTE Band 5 Channel and Frequency List				
BW [MHz]	Channel/Frequency(MHz)	Lowest	Middle	Highest
10	Channel	20450	20525	20600
	Frequency	829	836.5	844
5	Channel	20425	20525	20625
	Frequency	826.5	836.5	846.5
3	Channel	20415	20525	20635
	Frequency	825.5	836.5	847.5
1.4	Channel	20407	20525	20643
	Frequency	824.7	836.5	848.3



LTE Band 7 Channel and Frequency List				
BW [MHz]	Channel/Frequency(MHz)	Lowest	Middle	Highest
20	Channel	20850	21100	21350
	Frequency	2510	2535	2560
15	Channel	20825	21100	21375
	Frequency	2507.5	2535	2562.5
10	Channel	20800	21100	21400
	Frequency	2505	2535	2565
5	Channel	20775	21100	21425
	Frequency	2502.5	2535	2567.5

LTE Band 26 Channel and Frequency List				
BW [MHz]	Channel/Frequency(MHz)	Lowest	Middle	Highest
15	Channel	26865	26915	26965
	Frequency	831.5	836.5	841.5
10	Channel	26840	26915	26990
	Frequency	829	836.5	844
5	Channel	26815	26915	27015
	Frequency	826.5	836.5	846.5
3	Channel	26805	26915	27025
	Frequency	825.5	836.5	847.5
1.4	Channel	26797	26915	27033
	Frequency	824.7	836.5	848.3

LTE Band 38 Channel and Frequency List				
BW [MHz]	Channel/Frequency(MHz)	Lowest	Middle	Highest
20	Channel	37850	38000	38150
	Frequency	2580	2595	2610
15	Channel	37825	38000	38175
	Frequency	2577.5	2595	2612.5
10	Channel	37800	38000	38200
	Frequency	2575	2595	2615
5	Channel	37775	38000	38225
	Frequency	2572.5	2595	2617.5

3 Conducted Test Items

3.1 Measuring Instruments

See list of measuring instruments of this test report.

3.2 Test Setup

3.2.1 Conducted Output Power



3.2.2 Peak-to-Average Ratio, Occupied Bandwidth ,Conducted Band-Edge and Conducted Spurious Emission

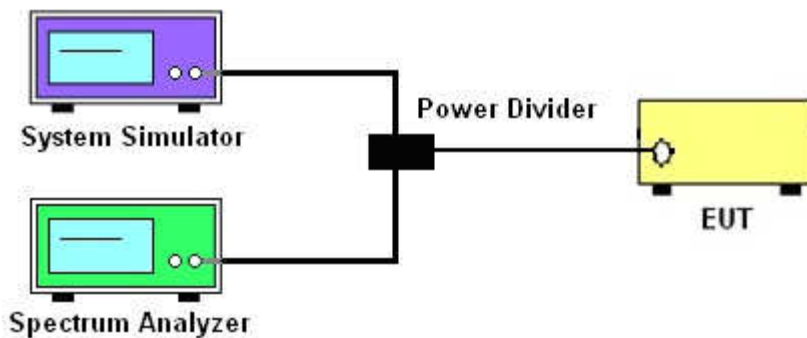

3.2.3 Frequency Stability

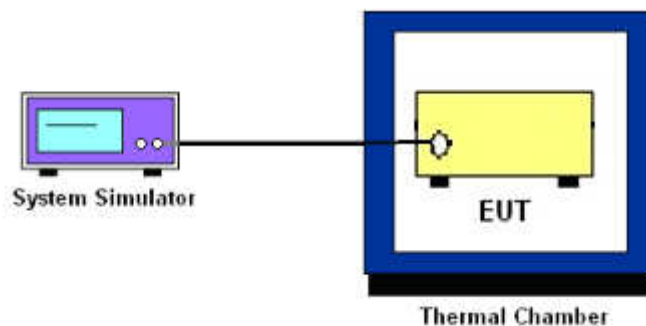

3.3 Test Result of Conducted Test

Please refer to Appendix A.



3.4 Conducted Output Power and ERP/EIRP

3.4.1 Description of the Conducted Output Power Measurement and ERP/EIRP Measurement

A system simulator was used to establish communication with the EUT. Its parameters were set to force the EUT transmitting at maximum output power. The measured power in the radio frequency on the transmitter output terminals shall be reported.

The ERP of mobile transmitters must not exceed 7 Watts for LTE Band 5 and Band 26.

The EIRP of mobile transmitters must not exceed 2 Watts for LTE Band 2 Band 7 and Band 38.

According to KDB 412172 D01 Power Approach,

$EIRP = P_T + G_T - L_C$, $ERP = EIRP - 2.15$, where

P_T = transmitter output power in dBm

G_T = gain of the transmitting antenna in dBi

L_C = signal attenuation in the connecting cable between the transmitter and antenna in dB

3.4.2 Test Procedures

1. The transmitter output port was connected to the system simulator.
2. Set EUT at maximum power through the system simulator.
3. Select lowest, middle, and highest channels for each band and different modulation.
4. Measure and record the power level from the system simulator.



3.5 Peak-to-Average Ratio

3.5.1 Description of the PAR Measurement

Power Complementary Cumulative Distribution Function (CCDF) curves provide a means for characterizing the power peaks of a digitally modulated signal on a statistical basis. A CCDF curve depicts the probability of the peak signal amplitude exceeding the average power level. Most contemporary measurement instrumentation include the capability to produce CCDF curves for an input signal provided that the instrument's resolution bandwidth can be set wide enough to accommodate the entire input signal bandwidth. In measuring transmissions in this band using an average power technique, the peak-to-average ratio (PAR) of the transmission may not exceed 13 dB.

3.5.2 Test Procedures

1. The testing follows FCC KDB 971168 v03 Section 5.7.1.
2. The EUT was connected to spectrum and system simulator via a power divider.
3. Set the CCDF (Complementary Cumulative Distribution Function) option in spectrum analyzer.
4. The highest RF powers were measured and recorded the maximum PAPR level associated with a probability of 0.1 %.
5. Record the deviation as Peak to Average Ratio.



3.6 Occupied Bandwidth

3.6.1 Description of Occupied Bandwidth Measurement

The occupied bandwidth is the width of a frequency band such that, below the lower and above the upper frequency limits, the mean powers emitted are each equal to a specified percentage 0.5% of the total mean transmitted power.

The 26 dB emission bandwidth is defined as the frequency range between two points, one above and one below the carrier frequency, at which the spectral density of the emission is attenuated 26 dB below the maximum in-band spectral density of the modulated signal. Spectral density (power per unit bandwidth) is to be measured with a detector of resolution bandwidth equal to approximately 1.0% of the emission bandwidth.

3.6.2 Test Procedures

1. The testing follows FCC KDB 971168 v03 Section 4.1 and 4.2.
2. The EUT was connected to spectrum analyzer and system simulator via a power divider.
3. The spectrum analyzer center frequency is set to the nominal EUT channel center frequency. The span range for the spectrum analyzer shall be between two and five times the anticipated OBW.
4. The nominal resolution bandwidth (RBW) shall be in the range of 1 to 5 % of the anticipated OBW, and the VBW shall be at least 3 times the RBW.
5. Set the detection mode to peak, and the trace mode to max hold.
6. Determine the reference value: Set the EUT to transmit a modulated signal. Allow the trace to stabilize. Set the spectrum analyzer marker to the highest level of the displayed trace.
(this is the reference value)
7. Determine the “-26 dB down amplitude” as equal to (Reference Value – X).
8. Place two markers, one at the lowest and the other at the highest frequency of the envelope of the spectral display such that each marker is at or slightly below the “-X dB down amplitude” determined in step 6. If a marker is below this “-X dB down amplitude” value it shall be placed as close as possible to this value. The OBW is the positive frequency difference between the two markers.
9. Use the 99 % power bandwidth function of the spectrum analyzer and report the measured bandwidth.



3.7 Conducted Band Edge

3.7.1 Description of Conducted Band Edge Measurement

22.917(a)

For operations in the 824 – 849 MHz band, the FCC limit is $43 + 10\log_{10}(P[\text{Watts}])$ dB below the transmitter power P(Watts) in a 100kHz bandwidth. However, in the 1MHz bands immediately outside and adjacent to the licensee's frequency block, a resolution bandwidth of at least one percent of the emission bandwidth of the fundamental emission of the transmitter may be employed.

24.238 (a)

For operations in the 1850-1910 and 1930-1990 MHz band, the FCC limit is $43 + 10\log_{10}(P[\text{Watts}])$ dB below the transmitter power P(Watts) in a 1MHz bandwidth. However, in the 1 MHz bands immediately outside and adjacent to the frequency block a resolution bandwidth of at least one percent of the emission bandwidth of the fundamental emission of the transmitter may be employed.

27.53(m)(4)

For mobile digital stations, the attenuation factor shall be not less than $40 + 10 \log (P)$ dB on all frequencies between the channel edge and 5 megahertz from the channel edge, $43 + 10 \log (P)$ dB on all frequencies between 5 megahertz and X megahertz from the channel edge, and $55 + 10 \log (P)$ dB on all frequencies more than X megahertz from the channel edge, where X is the greater of 6 megahertz or the actual emission bandwidth as defined in paragraph (m)(6) of this section. In addition, the attenuation factor shall not be less that $43 + 10 \log (P)$ dB on all frequencies between 2490.5 MHz and 2496 MHz and $55 + 10 \log (P)$ dB at or below 2490.5 MHz. Mobile Satellite Service licensees operating on frequencies below 2495 MHz may also submit a documented interference complaint against BRS licensees operating on channel BRS Channel 1 on the same terms and conditions as adjacent channel BRS or EBS licensees.



3.7.2 Test Procedures

1. The testing follows FCC KDB 971168 v03 Section 6.0.
2. The EUT was connected to spectrum analyzer and system simulator via a power divider.
3. The band edges of low and high channels for the highest RF powers were measured.
4. Set RBW \geq 1% EBW in the 1MHz band immediately outside and adjacent to the band edge.
5. Beyond the 1 MHz band from the band edge, RBW=1MHz was used.
6. Offset has included the duty factor for LTE Band 38. Duty factor = $10 \log (1/x)$, where x is the measured duty cycle.
7. Set spectrum analyzer with RMS detector.
8. The RF fundamental frequency should be excluded against the limit line in the operating frequency band.
9. Checked that all the results comply with the emission limit line.

Example:

The limit line is derived from $43 + 10\log(P)$ dB below the transmitter power P(Watts)

$$= P(W) - [43 + 10\log(P)] \text{ (dB)}$$

$$= [30 + 10\log(P)] \text{ (dBm)} - [43 + 10\log(P)] \text{ (dB)} = -13\text{dBm}.$$

10. For LTE Band 7, 38, the other 40 dB, and 55 dB have additionally applied same calculation above.



3.8 Conducted Spurious Emission

3.8.1 Description of Conducted Spurious Emission Measurement

The power of any emission outside of the authorized operating frequency ranges must be lower than the transmitter power (P) by a factor of at least $43 + 10 \log (P)$ dB.

For Band 7,38:

The power of any emission outside of the authorized operating frequency ranges must be lower than the transmitter power (P) by a factor of at least $55 + 10 \log (P)$ dB.

It is measured by means of a calibrated spectrum analyzer and scanned from 30 MHz up to a frequency including its 10th harmonic.

3.8.2 Test Procedures

1. The testing follows FCC KDB 971168 v03 Section 6.0.
2. The EUT was connected to spectrum analyzer and system simulator via a power divider.
3. The RF output of EUT was connected to the spectrum analyzer by RF cable and attenuator. The path loss was compensated to the results for each measurement.
4. The middle channel for the highest RF power within the transmitting frequency was measured.
5. The conducted spurious emission for the whole frequency range was taken.
6. Make the measurement with the spectrum analyzer's RBW = 1MHz, VBW = 3MHz.
7. Offset has included the duty factor for LTE Band 41. Duty factor = $10 \log (1/x)$, where x is the measured duty cycle
8. Set spectrum analyzer with RMS detector.
9. Taking the record of maximum spurious emission.
10. The RF fundamental frequency should be excluded against the limit line in the operating frequency band.
11. The limit line is derived from $43 + 10 \log (P)$ dB below the transmitter power P(Watts)
= $P(W) - [43 + 10 \log (P)]$ (dB)
= $[30 + 10 \log (P)]$ (dBm) - $[43 + 10 \log (P)]$ (dB)
= -13dBm.
12. For Band 7, 38
The limit line is derived from $55 + 10 \log (P)$ dB below the transmitter power P(Watts)
= $P(W) - [55 + 10 \log (P)]$ (dB)
= $[30 + 10 \log (P)]$ (dBm) - $[55 + 10 \log (P)]$ (dB)
= -25dBm.



3.9 Frequency Stability

3.9.1 Description of Frequency Stability Measurement

The frequency stability shall be measured by variation of ambient temperature and variation of primary supply voltage to ensure that the fundamental emission stays within the authorized frequency block. The frequency stability of the transmitter shall be maintained within $\pm 0.00025\%$ ($\pm 2.5\text{ppm}$) of the center frequency.

3.9.2 Test Procedures for Temperature Variation

1. The testing follows FCC KDB 971168 v03 Section 9.0.
2. The EUT was set up in the thermal chamber and connected with the system simulator.
3. With power OFF, the temperature was decreased to -30°C and the EUT was stabilized before testing. Power was applied and the maximum change in frequency was recorded within one minute.
4. With power OFF, the temperature was raised in 10°C step up to 50°C . The EUT was stabilized at each step for at least half an hour. Power was applied and the maximum frequency change was recorded within one minute.

3.9.3 Test Procedures for Voltage Variation

1. The testing follows FCC KDB 971168 v03 Section 9.0.
2. The EUT was placed in a temperature chamber at $20\pm 5^{\circ}\text{C}$ and connected with the system simulator.
3. The power supply voltage to the EUT was varied from 85% to 115% of the nominal value measured at the input to the EUT.
4. The variation in frequency was measured for the worst case.

4 Radiated Test Items

4.1 Measuring Instruments

See list of measuring instruments of this test report.

4.2 Test Setup

4.2.1 For radiated test from 30MHz to 1GHz

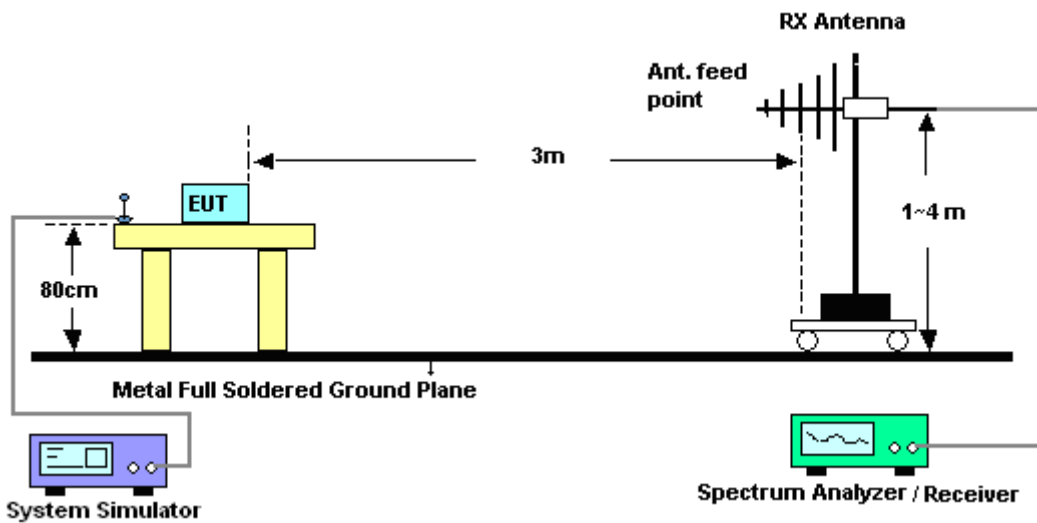

4.2.2 For radiated test above 1GHz

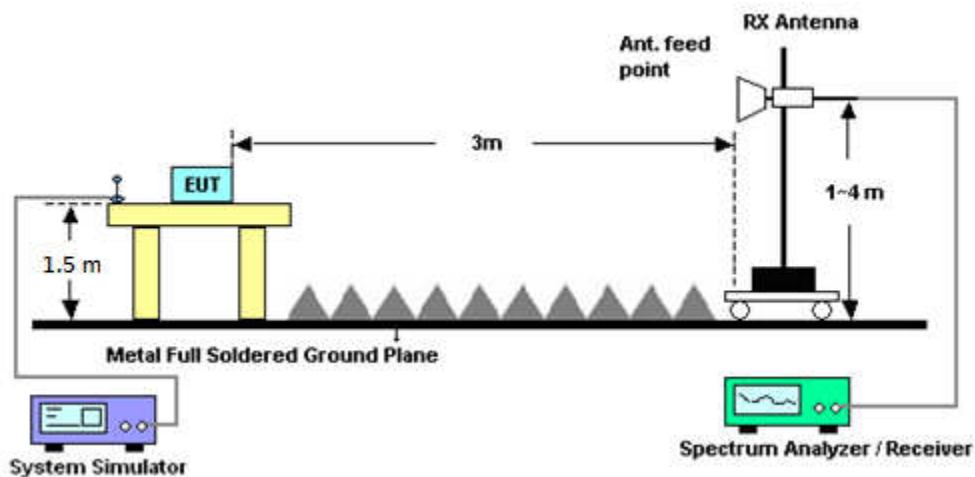

4.3 Test Result of Radiated Test

Please refer to Appendix B.



4.4 Radiated Spurious Emission

4.4.1 Description of Radiated Spurious Emission

The radiated spurious emission was measured by substitution method according to ANSI/TIA-603-E. The power of any emission outside of the authorized operating frequency ranges must be attenuated below the transmitter power (P) by a factor of at least $43 + 10 \log (P)$ dB.

For Band 7, 38

The power of any emission outside of the authorized operating frequency ranges must be attenuated below the transmitter power (P) by a factor of at least $55 + 10 \log (P)$ dB.

The spectrum is scanned from 30 MHz up to a frequency including its 10th harmonic.

4.4.2 Test Procedures

1. The testing follows FCC KDB 971168 v03 Section 5.8 and ANSI/TIA-603-E Section 2.2.12.
2. The EUT was placed on a turntable with 0.8 meter height for frequency below 1GHz and 1.5 meter height for frequency above 1GHz respectively above ground.
3. The EUT was set 3 meters from the receiving antenna mounted on the antenna tower.
4. The table was rotated 360 degrees to determine the position of the highest spurious emission.
5. The height of the receiving antenna is varied between 1m to 4m to search the maximum spurious emission for both horizontal and vertical polarizations.
6. During the measurement, the system simulator parameters were set to force the EUT transmitting at maximum output power.
7. Make the measurement with the spectrum analyzer's RBW = 1MHz, VBW = 3MHz, taking the record of maximum spurious emission.
8. A horn antenna was substituted in place of the EUT and was driven by a signal generator.
9. Tune the output power of signal generator to the same emission level with EUT maximum spurious emission.
10. $EIRP (dBm) = S.G. Power - Tx Cable Loss + Tx Antenna Gain$
11. $ERP (dBm) = EIRP - 2.15$
12. The RF fundamental frequency should be excluded against the limit line in the operating frequency band.

The limit line is derived from $43 + 10\log(P)$ dB below the transmitter power P(Watts)
 $= P(W) - [43 + 10\log(P)] (dB)$
 $= [30 + 10\log(P)] (dBm) - [43 + 10\log(P)] (dB)$
 $= -13dBm.$

13. For Band 7, 38:

The limit line is derived from $55 + 10\log(P)$ dB below the transmitter power P(Watts)
 $EIRP (dBm) = S.G. Power - Tx Cable Loss + Tx Antenna Gain$
 $ERP (dBm) = EIRP - 2.15$



5 List of Measuring Equipment

Instrument	Manufacturer	Model No.	Serial No.	Characteristics	Calibration Date	Test Date	Due Date	Remark
Spectrum Analyzer	R&S	FSV40	101040	10Hz~40GHz	Aug. 08, 2017	Jan. 14, 2018~ Mar. 07, 2018	Aug. 07, 2018	Conducted (TH01-KS)
Radio communication	Anritsu	MT8820C	6201300652	2G/3G/LTE_full band	Aug. 08, 2017	Jan. 14, 2018~ Mar. 07, 2018	Aug. 07, 2018	Conducted (TH01-KS)
Thermal Chamber	Hongzhan	LP-150U	HZ014011440	-40~+150°C 20%~95%RH	Apr. 18, 2017	Jan. 14, 2018~ Mar. 07, 2018	Apr. 17, 2018	Conducted (TH01-KS)
Amplifier	MITEQ	TTA1840-35-HG	1871923	18GHz~40GHz,VS WR : 2.5:1 max	Jul. 18, 2017	Feb. 13, 2018 ~ Feb. 22, 2018	Jul. 17, 2018	Radiation (03CH12-HY)
Bilog Antenna	TESEQ	CBL 6111D&N-6-	35414&AT-N0602	30MHz~1GHz	Oct. 14, 2017	Feb. 13, 2018 ~ Feb. 22, 2018	Oct. 13, 2018	Radiation (03CH12-HY)
Horn Antenna	SCHWARZBECK	BBHA 9120D	9120D-1328	1GHz ~ 18GHz	Oct. 20, 2017	Feb. 13, 2018 ~ Feb. 22, 2018	Oct. 19, 2018	Radiation (03CH12-HY)
Hygrometer	TECPEL	DTM-303B	TP140349	N/A	Oct. 12, 2017	Feb. 13, 2018 ~ Feb. 22, 2018	Oct. 11, 2018	Radiation (03CH12-HY)
Preamplifier	COM-POWER	PA-103	161075	10MHz~1GHz	Mar. 23, 2017	Feb. 13, 2018 ~ Feb. 22, 2018	Mar. 22, 2018	Radiation (03CH12-HY)
Preamplifier	Keysight	83017A	MY53270148	1GHz~26.5GHz	Jan. 15, 2018	Feb. 13, 2018 ~ Feb. 22, 2018	Jan. 14, 2019	Radiation (03CH12-HY)
Controller	EMEC	EM1000	N/A	Control Turn table & Ant Mast	NCR	Feb. 13, 2018 ~ Feb. 22, 2018	NCR	Radiation (03CH12-HY)
Antenna Mast	EMEC	AM-BS-450 0-B	N/A	1m~4m	NCR	Feb. 13, 2018 ~ Feb. 22, 2018	NCR	Radiation (03CH12-HY)
Turn Table	EMEC	TT2000	N/A	0~360 Degree	NCR	Feb. 13, 2018 ~ Feb. 22, 2018	NCR	Radiation (03CH12-HY)
SHF-EHF Horn Antenna	SCHWARZBECK	BBHA 9170	BBHA9170576	18GHz ~ 40GHz	Apr. 27, 2017	Feb. 13, 2018 ~ Feb. 22, 2018	Apr. 26, 2018	Radiation (03CH12-HY)
Spectrum Analyzer	Keysight	N9010A	MY55370526	10Hz~44GHz	Mar. 15, 2017	Feb. 13, 2018 ~ Feb. 22, 2018	Mar. 14, 2018	Radiation (03CH12-HY)

NCR: No Calibration Required



6 Uncertainty of Evaluation

Uncertainty of Radiated Emission Measurement (30 MHz ~ 1000 MHz)

Measuring Uncertainty for a Level of Confidence of 95% ($U = 2Uc(y)$)	3.4dB
---	-------

Uncertainty of Radiated Emission Measurement (1000 MHz ~ 18000 MHz)

Measuring Uncertainty for a Level of Confidence of 95% ($U = 2Uc(y)$)	3.7dB
---	-------

Uncertainty of Radiated Emission Measurement (18000 MHz ~ 40000 MHz)

Measuring Uncertainty for a Level of Confidence of 95% ($U = 2Uc(y)$)	4.0dB
---	-------



Appendix A. Test Results of Conducted Test

Conducted Output Power(Average power)

LTE Band 2 Maximum Average Power [dBm]						
BW [MHz]	RB Size	RB Offset	Mod	Lowest	Middle	Highest
20	1	0	QPSK	23.12	23.14	23.17
20	1	49		23.17	23.20	23.19
20	1	99		23.08	23.19	23.10
20	50	0		22.41	22.48	22.33
20	50	24		22.40	22.46	22.47
20	50	50		22.36	22.36	22.42
20	100	0		22.38	22.44	22.36
20	1	0	16-QAM	22.79	22.67	22.76
20	1	49		22.70	22.79	22.63
20	1	99		22.63	22.78	22.68
20	50	0		21.54	21.54	21.46
20	50	24		21.53	21.58	21.45
20	50	50		21.48	21.52	21.47
20	100	0		21.51	21.52	21.42
20	1	0	64QAM	21.75	21.80	21.74
20	1	49		21.90	21.96	21.92
20	1	99		21.90	21.99	21.95
20	50	0		20.75	20.76	20.71
20	50	24		20.75	20.79	20.70
20	50	50		20.80	20.83	20.88
20	100	0		20.72	20.79	20.75
15	1	0	QPSK	23.02	23.12	23.13
15	1	37		22.86	23.12	23.04
15	1	74		22.89	23.03	23.06
15	36	0		22.13	22.32	22.30
15	36	20		22.25	22.39	22.34
15	36	39		22.17	22.30	22.26
15	75	0		22.23	22.32	22.28
15	1	0	16-QAM	22.49	22.64	22.65



15	1	37		22.43	22.65	22.50
15	1	74		22.42	22.71	22.59
15	36	0		21.26	21.42	21.40
15	36	20		21.38	21.51	21.38
15	36	39		21.37	21.43	21.40
15	75	0		21.44	21.44	21.39
15	1	0	64QAM	21.78	21.89	21.80
15	1	37		21.95	21.96	21.90
15	1	74		21.90	21.92	21.82
15	36	0		20.70	20.79	20.75
15	36	20		20.80	20.84	20.81
15	36	39		20.75	20.81	20.80
15	75	0		20.70	20.78	20.79
15	75	0				



LTE Band 2 Maximum Average Power [dBm]						
BW [MHz]	RB Size	RB Offset	Mod	Lowest	Middle	Highest
10	1	0	QPSK	23.13	23.19	23.11
10	1	25		23.01	23.14	23.09
10	1	49		23.05	23.13	23.01
10	25	0		22.11	22.34	22.30
10	25	12		22.11	22.37	22.33
10	25	25		22.17	22.30	22.28
10	50	0		22.19	22.33	22.31
10	1	0	16-QAM	22.58	22.72	22.56
10	1	25		22.46	22.65	22.53
10	1	49		22.57	22.76	22.58
10	25	0		21.29	21.43	21.36
10	25	12		21.27	21.44	21.38
10	25	25		21.33	21.44	21.34
10	50	0		21.36	21.42	21.38
10	1	0	64QAM	21.92	21.98	22.00
10	1	25		21.95	21.96	21.90
10	1	49		21.90	21.99	21.92
10	25	0		20.78	20.80	20.79
10	25	12		20.82	20.80	20.70
10	25	25		20.75	20.77	20.76
10	50	0		20.70	20.80	20.71
5	1	0	QPSK	23.01	23.19	23.02
5	1	12		22.94	23.11	23.06
5	1	24		22.87	23.05	22.99
5	12	0		22.16	22.30	22.26
5	12	7		22.11	22.36	22.30
5	12	13		22.10	22.32	22.28
5	25	0		22.09	22.28	22.26
5	1	0	16-QAM	22.49	22.64	22.52
5	1	12		22.52	22.66	22.58
5	1	24		22.44	22.64	22.59
5	12	0		21.29	21.45	21.36
5	12	7		21.28	21.45	21.39



5	12	13	64QAM	21.25	21.44	21.35
5	25	0		21.23	21.40	21.37
5	1	0		21.80	21.86	21.80
5	1	12		21.88	21.90	21.83
5	1	24		21.87	21.88	21.85
5	12	0		20.80	20.85	20.81
5	12	7		20.82	20.88	20.80
5	12	13		20.74	20.81	20.89
5	25	0		20.65	20.77	20.78



LTE Band 2 Maximum Average Power [dBm]						
BW [MHz]	RB Size	RB Offset	Mod	Lowest	Middle	Highest
3	1	0	QPSK	23.01	23.18	23.02
3	1	8		23.03	23.10	23.02
3	1	14		22.97	23.07	23.00
3	8	0		22.22	22.33	22.25
3	8	4		22.24	22.37	22.27
3	8	7		22.25	22.31	22.23
3	15	0		22.21	22.29	22.25
3	1	0	16-QAM	22.56	22.63	22.57
3	1	8		22.60	22.66	22.62
3	1	14		22.43	22.59	22.56
3	8	0		21.35	21.46	21.37
3	8	4		21.47	21.52	21.44
3	8	7		21.29	21.48	21.41
3	15	0		21.25	21.42	21.37
3	1	0	64QAM	21.80	21.87	21.82
3	1	8		21.89	21.90	21.85
3	1	14		21.84	21.85	21.80
3	8	0		20.82	20.83	20.80
3	8	4		20.83	20.85	20.81
3	8	7		20.80	20.81	20.75
3	15	0		20.71	20.75	20.70
1.4	1	0	QPSK	22.86	23.07	22.94
1.4	1	3		22.92	23.12	23.04
1.4	1	5		22.86	23.01	22.93
1.4	3	0		22.87	23.03	23.00
1.4	3	1		22.92	23.10	23.03
1.4	3	3		22.87	23.05	23.01
1.4	6	0		22.08	22.24	22.18
1.4	1	0	16-QAM	22.41	22.55	22.48
1.4	1	3		22.46	22.61	22.60
1.4	1	5		22.40	22.60	22.53
1.4	3	0		22.22	22.37	22.27
1.4	3	1		22.24	22.42	22.32



1.4	3	3	64QAM	22.16	22.35	22.26
1.4	6	0		21.28	21.46	21.36
1.4	1	0		21.69	21.88	21.90
1.4	1	3		21.69	21.85	21.80
1.4	1	5		21.81	21.84	21.75
1.4	3	0		21.80	21.83	21.89
1.4	3	1		21.75	21.86	21.83
1.4	3	3		21.62	21.85	21.80
1.4	6	0		20.79	20.73	20.80



LTE Band 5 Maximum Average Power [dBm]						
BW [MHz]	RB Size	RB Offset	Mod	Lowest	Middle	Highest
10	1	0	QPSK	23.27	23.30	23.31
10	1	25		23.31	23.47	23.36
10	1	49		23.34	23.35	23.29
10	25	0		22.42	22.52	22.42
10	25	12		22.38	22.51	22.43
10	25	25		22.45	22.45	22.37
10	50	0		22.38	22.49	22.44
10	1	0	16-QAM	22.68	22.70	22.79
10	1	25		22.70	22.89	22.78
10	1	49		22.83	22.77	22.67
10	25	0		21.52	21.66	21.58
10	25	12		21.53	21.66	21.56
10	25	25		21.56	21.58	21.53
10	50	0		21.50	21.63	21.58
10	1	0	64QAM	21.65	21.80	21.70
10	1	25		21.75	21.99	21.89
10	1	49		21.70	21.91	21.82
10	25	0		20.65	20.83	20.76
10	25	12		20.69	20.85	20.80
10	25	25		20.67	20.81	20.74
10	50	0		20.65	20.80	20.72
5	1	0	QPSK	23.24	23.36	23.27
5	1	12		23.32	23.41	23.32
5	1	24		23.29	23.38	23.26
5	12	0		22.30	22.52	22.39
5	12	7		22.44	22.53	22.44
5	12	13		22.41	22.49	22.38
5	25	0		22.40	22.49	22.37
5	1	0	16-QAM	22.65	22.73	22.75
5	1	12		22.73	22.86	22.74
5	1	24		22.70	22.76	22.66
5	12	0		21.43	21.65	21.61
5	12	7		21.55	21.68	21.58
5	12	13		21.51	21.66	21.54



5	25	0		21.49	21.62	21.51
5	1	0	64QAM	21.84	21.94	21.80
5	1	12		21.86	21.96	21.80
5	1	24		21.86	21.95	21.84
5	12	0		20.80	20.91	20.82
5	12	7		20.81	20.93	20.76
5	12	13		20.70	20.88	20.75
5	25	0		20.70	20.81	20.75



LTE Band 5 Maximum Average Power [dBm]						
BW [MHz]	RB Size	RB Offset	Mod	Lowest	Middle	Highest
3	1	0	QPSK	23.29	23.43	23.25
3	1	8		23.27	23.40	23.26
3	1	14		23.36	23.38	23.29
3	8	0		22.31	22.47	22.39
3	8	4		22.32	22.49	22.42
3	8	7		22.38	22.47	22.38
3	15	0		22.38	22.45	22.39
3	1	0	16-QAM	22.66	22.81	22.77
3	1	8		22.64	22.77	22.73
3	1	14		22.72	22.81	22.62
3	8	0		21.48	21.69	21.60
3	8	4		21.51	21.70	21.64
3	8	7		21.55	21.68	21.57
3	15	0		21.53	21.63	21.53
3	1	0	64QAM	21.84	21.99	21.95
3	1	8		21.85	21.98	21.92
3	1	14		21.86	21.97	21.87
3	8	0		20.80	20.86	20.82
3	8	4		20.80	20.89	20.81
3	8	7		20.80	20.85	20.75
3	15	0		20.60	20.79	20.75
1.4	1	0	QPSK	23.19	23.34	23.22
1.4	1	3		23.28	23.43	23.32
1.4	1	5		23.16	23.32	23.19
1.4	3	0		23.23	23.39	23.26
1.4	3	1		23.28	23.41	23.31
1.4	3	3		23.24	23.37	23.25
1.4	6	0		22.21	22.39	22.27
1.4	1	0	16-QAM	22.58	22.80	22.65
1.4	1	3		22.63	22.88	22.65
1.4	1	5		22.56	22.75	22.55
1.4	3	0		22.37	22.55	22.42
1.4	3	1		22.39	22.54	22.45



1.4	3	3	64QAM	22.36	22.54	22.40
1.4	6	0		21.46	21.60	21.48
1.4	1	0		21.81	21.94	21.86
1.4	1	3		21.80	21.96	21.80
1.4	1	5		21.85	21.87	21.80
1.4	3	0		21.75	21.84	21.74
1.4	3	1		21.82	21.91	21.96
1.4	3	3		21.74	21.87	21.80
1.4	6	0		20.62	20.73	20.70



LTE Band 7 Maximum Average Power [dBm]						
BW [MHz]	RB Size	RB Offset	Mod	Lowest	Middle	Highest
20	1	0	QPSK	23.29	22.98	22.88
20	1	49		23.28	22.85	22.96
20	1	99		23.32	22.89	22.99
20	50	0		22.39	21.94	21.95
20	50	24		22.38	21.96	22.00
20	50	50		22.38	21.92	22.09
20	100	0		22.39	21.92	21.99
20	1	0	16-QAM	22.45	22.22	22.22
20	1	49		22.48	22.10	22.23
20	1	99		22.51	22.21	22.29
20	50	0		21.34	21.02	21.04
20	50	24		21.36	21.02	21.04
20	50	50		21.35	21.01	21.13
20	100	0		21.31	21.01	21.03
20	1	0	64QAM	21.56	21.23	21.33
20	1	49		21.60	21.26	21.35
20	1	99		21.69	21.37	21.45
20	50	0		20.67	20.30	20.44
20	50	24		20.50	20.19	20.40
20	50	50		20.56	20.22	20.33
20	100	0		20.45	20.18	20.27
15	1	0	QPSK	23.24	22.99	22.89
15	1	37		23.21	22.87	22.96
15	1	74		23.30	22.83	23.03
15	36	0		22.28	21.94	21.94
15	36	20		22.31	21.95	22.08
15	36	39		22.32	21.90	22.01
15	75	0		22.32	21.92	21.93
15	1	0	16-QAM	22.50	22.24	22.22
15	1	37		22.53	22.14	22.28
15	1	74		22.50	22.09	22.34
15	36	0		21.35	20.99	20.98
15	36	20		21.41	21.01	21.08



15	36	39	64QAM	21.35	20.96	21.09
15	75	0		21.35	20.99	21.02
15	1	0		21.65	21.31	21.35
15	1	37		21.55	21.22	21.23
15	1	74		21.50	21.20	21.20
15	36	0		20.38	20.16	20.18
15	36	20		20.52	20.20	20.16
15	36	39		20.46	20.20	20.26
15	75	0		20.46	20.15	20.23



LTE Band 7 Maximum Average Power [dBm]						
BW [MHz]	RB Size	RB Offset	Mod	Lowest	Middle	Highest
10	1	0	QPSK	23.23	22.87	22.94
10	1	25		23.20	22.86	22.97
10	1	49		23.18	22.77	22.99
10	25	0		22.26	21.89	21.98
10	25	12		22.28	21.89	22.03
10	25	25		22.31	21.89	21.99
10	50	0		22.27	21.93	21.97
10	1	0	16-QAM	22.51	22.14	22.25
10	1	25		22.51	22.13	22.15
10	1	49		22.58	22.08	22.19
10	25	0		21.32	20.97	21.07
10	25	12		21.39	20.96	21.05
10	25	25		21.36	20.96	21.03
10	50	0		21.37	20.98	20.98
10	1	0	64QAM	21.49	21.18	21.23
10	1	25		21.55	21.23	21.26
10	1	49		21.60	21.27	21.30
10	25	0		20.35	20.14	20.19
10	25	12		20.36	20.17	20.25
10	25	25		20.32	20.17	20.26
10	50	0		20.30	20.14	20.20
5	1	0	QPSK	23.24	22.86	22.91
5	1	12		23.28	22.87	22.95
5	1	24		23.27	22.86	22.91
5	12	0		22.28	21.88	21.97
5	12	7		22.32	21.91	21.88
5	12	13		22.29	21.89	21.89
5	25	0		22.30	21.89	21.93
5	1	0	16-QAM	22.49	22.09	22.07
5	1	12		22.56	22.10	22.11
5	1	24		22.57	22.09	22.14
5	12	0		21.32	20.94	20.99
5	12	7		21.34	20.94	21.04



5	12	13	64QAM	21.35	20.95	21.01
5	25	0		21.32	20.94	21.03
5	1	0		21.48	21.19	21.25
5	1	12		21.53	21.23	21.26
5	1	24		21.55	21.26	21.30
5	12	0		20.49	20.15	20.30
5	12	7		20.52	20.17	20.32
5	12	13		20.56	20.19	20.32
5	25	0		20.50	20.10	20.26



LTE Band 26 Maximum Average Power [dBm]						
BW [MHz]	RB Size	RB Offset	Mod	Lowest	Middle	Highest
15	1	0	QPSK	23.23	23.18	23.25
15	1	37		23.33	23.20	23.21
15	1	74		23.27	23.08	23.14
15	36	0		22.40	22.19	22.23
15	36	20		22.38	22.17	22.21
15	36	39		22.35	22.10	22.27
15	75	0		22.38	22.08	22.18
15	1	0	16-QAM	22.64	22.67	22.72
15	1	37		22.76	22.58	22.60
15	1	74		22.74	22.68	22.66
15	36	0		21.53	21.57	21.37
15	36	20		21.53	21.44	21.37
15	36	39		21.49	21.41	21.44
15	75	0		21.51	21.47	21.32
15	1	0	64QAM	21.72	21.69	21.70
15	1	37		21.89	21.77	21.80
15	1	74		21.87	21.80	21.85
15	36	0		20.76	20.67	20.71
15	36	20		20.74	20.62	20.65
15	36	39		20.72	20.70	20.64
15	75	0		20.71	20.59	20.63



LTE Band 26 Maximum Average Power [dBm]						
BW [MHz]	RB Size	RB Offset	Mod	Lowest	Middle	Highest
10	1	0	QPSK	23.11	23.20	23.23
10	1	25		23.20	23.18	23.18
10	1	49		23.01	23.12	23.11
10	25	0		22.04	22.18	22.26
10	25	12		22.01	22.19	22.25
10	25	25		22.19	22.20	22.22
10	50	0		22.15	22.41	22.21
10	1	0	16-QAM	22.31	22.45	22.62
10	1	25		22.51	22.54	22.57
10	1	49		22.59	22.58	22.52
10	25	0		21.30	21.55	21.37
10	25	12		21.28	21.51	21.39
10	25	25		21.27	21.44	21.32
10	50	0		21.19	21.46	21.37
10	1	0	64QAM	21.53	21.56	21.75
10	1	25		21.60	21.61	21.80
10	1	49		21.61	21.65	21.75
10	25	0		20.55	20.61	20.62
10	25	12		20.57	20.66	20.64
10	25	25		20.44	20.58	20.60
10	50	0		20.51	20.63	20.63
5	1	0	QPSK	23.01	23.22	23.18
5	1	12		23.04	23.23	23.14
5	1	24		23.00	23.18	23.12
5	12	0		22.10	22.35	22.24
5	12	7		22.21	22.27	22.24
5	12	13		22.22	22.29	22.20
5	25	0		22.18	22.30	22.18
5	1	0	16-QAM	22.54	22.44	22.60
5	1	12		22.51	22.51	22.58
5	1	24		22.45	22.49	22.48
5	12	0		21.32	21.48	21.41
5	12	7		21.29	21.55	21.40



5	12	13	64QAM	21.41	21.52	21.37
5	25	0		21.46	21.52	21.34
5	1	0		21.72	21.63	21.65
5	1	12		21.61	21.67	21.75
5	1	24		21.66	21.69	21.70
5	12	0		20.55	20.67	20.65
5	12	7		20.63	20.65	20.60
5	12	13		20.60	20.61	20.55
5	25	0		20.55	20.62	20.69



LTE Band 26 Maximum Average Power [dBm]						
BW [MHz]	RB Size	RB Offset	Mod	Lowest	Middle	Highest
3	1	0	QPSK	23.11	23.22	23.15
3	1	8		23.03	23.21	23.15
3	1	14		23.01	23.19	23.10
3	8	0		22.10	22.33	22.21
3	8	4		22.11	22.41	22.22
3	8	7		22.09	22.45	22.19
3	15	0		22.09	22.39	22.21
3	1	0	16-QAM	22.37	22.59	22.63
3	1	8		22.33	22.55	22.60
3	1	14		22.38	22.61	22.49
3	8	0		21.23	21.51	21.41
3	8	4		21.30	21.54	21.46
3	8	7		21.28	21.56	21.40
3	15	0		21.17	21.49	21.34
3	1	0	64QAM	21.63	21.56	21.70
3	1	8		21.56	21.58	21.75
3	1	14		21.59	21.60	21.90
3	8	0		20.55	20.59	20.78
3	8	4		20.52	20.63	20.89
3	8	7		20.53	20.67	20.65
3	15	0		20.56	20.60	20.55
1.4	1	0	QPSK	23.03	23.11	23.05
1.4	1	3		23.05	23.09	23.10
1.4	1	5		22.98	23.06	23.01
1.4	3	0		23.01	23.01	23.10
1.4	3	1		22.99	23.02	23.13
1.4	3	3		23.06	23.03	23.10
1.4	6	0		22.21	22.44	22.13
1.4	1	0	16-QAM	22.34	22.43	22.56
1.4	1	3		22.25	22.47	22.54
1.4	1	5		22.41	22.57	22.45
1.4	3	0		22.33	22.53	22.28
1.4	3	1		22.29	22.56	22.26



1.4	3	3	64QAM	22.32	22.44	22.18
1.4	6	0		21.29	21.51	21.30
1.4	1	0		21.56	21.62	21.75
1.4	1	3		21.57	21.64	21.78
1.4	1	5		21.49	21.67	21.65
1.4	3	0		21.61	21.72	21.60
1.4	3	1		21.57	21.68	21.63
1.4	3	3		21.62	21.69	21.70
1.4	6	0		20.51	20.49	20.52



LTE Band 38 Maximum Average Power [dBm]						
BW [MHz]	RB Size	RB Offset	Mod	Lowest	Middle	Highest
20	1	0	QPSK	22.84	22.66	22.73
20	1	49		22.72	22.61	22.73
20	1	99		22.69	22.55	22.68
20	50	0		21.84	21.68	21.69
20	50	24		21.79	21.70	21.73
20	50	50		21.74	21.66	21.76
20	100	0		21.74	21.70	21.71
20	1	0	16-QAM	21.92	21.82	21.86
20	1	49		21.80	21.76	21.87
20	1	99		21.81	21.72	21.85
20	50	0		20.92	20.80	20.79
20	50	24		20.90	20.84	20.84
20	50	50		20.85	20.74	20.88
20	100	0		20.92	20.78	20.79
20	1	0	64QAM	20.95	20.86	20.90
20	1	49		20.90	20.80	20.85
20	1	99		20.85	20.78	20.81
20	50	0		20.13	20.10	20.15
20	50	24		20.16	20.09	20.05
20	50	50		20.15	20.08	20.03
20	100	0		20.19	20.13	20.19
15	1	0	QPSK	22.80	22.69	22.68
15	1	37		22.76	22.59	22.72
15	1	74		22.74	22.61	22.79
15	36	0		21.81	21.64	21.71
15	36	20		21.79	21.69	21.79
15	36	39		21.76	21.68	21.82
15	75	0		21.79	21.63	21.68
15	1	0	16-QAM	21.95	21.84	21.84
15	1	37		21.86	21.73	21.90
15	1	74		21.93	21.81	21.85
15	36	0		20.86	20.77	20.77
15	36	20		20.87	20.79	20.87
15	36	39		20.89	20.73	20.85



15	75	0		20.88	20.78	20.81
15	1	0	64QAM	21.02	20.91	20.90
15	1	37		21.00	20.85	20.75
15	1	74		20.95	20.87	20.80
15	36	0		20.16	20.11	20.16
15	36	20		20.00	20.04	20.13
15	36	39		20.19	20.10	20.15
15	75	0		20.25	20.13	20.16



LTE Band 38 Maximum Average Power [dBm]						
BW [MHz]	RB Size	RB Offset	Mod	Lowest	Middle	Highest
10	1	0	QPSK	22.81	22.59	22.80
10	1	25		22.82	22.57	22.76
10	1	49		22.81	22.60	22.81
10	25	0		21.91	21.61	21.81
10	25	12		21.84	21.64	21.88
10	25	25		21.87	21.63	21.81
10	50	0		21.87	21.59	21.90
10	1	0	16-QAM	22.02	21.79	21.96
10	1	25		21.94	21.75	21.92
10	1	49		21.95	21.74	21.97
10	25	0		20.98	20.72	20.90
10	25	12		20.94	20.73	20.96
10	25	25		20.95	20.73	20.95
10	50	0		20.97	20.75	20.96
10	1	0	64QAM	21.02	20.87	20.99
10	1	25		20.99	20.83	20.95
10	1	49		20.92	20.83	20.93
10	25	0		20.23	20.11	20.16
10	25	12		20.25	20.12	20.16
10	25	25		20.26	20.08	20.15
10	50	0		20.36	20.09	20.18
5	1	0	QPSK	22.82	22.57	22.78
5	1	12		22.83	22.57	22.80
5	1	24		22.78	22.54	22.74
5	12	0		21.84	21.61	21.85
5	12	7		21.83	21.62	21.83
5	12	13		21.86	21.58	21.81
5	25	0		21.84	21.64	21.78
5	1	0	16-QAM	21.95	21.71	21.87
5	1	12		21.96	21.75	21.96
5	1	24		21.95	21.73	21.90
5	12	0		20.90	20.68	20.91
5	12	7		20.94	20.70	20.90



5	12	13	64QAM	20.91	20.66	20.91
5	25	0		20.96	20.77	20.94
5	1	0		21.02	20.80	21.00
5	1	12		21.00	20.77	21.03
5	1	24		21.12	20.82	21.15
5	12	0		20.25	20.08	20.25
5	12	7		20.16	20.09	20.15
5	12	13		20.16	20.07	20.12
5	25	0		20.26	20.12	20.15



ERP/EIRP

LTE Band 2 ($G_T - L_C = -0.60$ dB) QPSK									
Bandwidth	1.4M			3M			5M		
Channel	18607	18900	19193	18615	18900	19185	18625	18900	19175
	(Low)	(Mid)	(High)	(Low)	(Mid)	(High)	(Low)	(Mid)	(High)
Frequency	1850.7	1880	1909.3	1851.5	1880	1908.5	1852.5	1880	1907.5
(MHz)									
Conducted Power (dBm)	22.92	23.12	23.04	23.01	23.18	23.02	23.01	23.19	23.02
Conducted Power (Watts)	0.1959	0.2051	0.2014	0.2000	0.2080	0.2004	0.2000	0.2084	0.2004
EIRP(dBm)	22.32	22.52	22.44	22.41	22.58	22.42	22.41	22.59	22.42
EIRP(Watts)	0.1706	0.1786	0.1754	0.1742	0.1811	0.1746	0.1742	0.1816	0.1746

LTE Band 2 ($G_T - L_C = -0.60$ dB) QPSK									
Bandwidth	10M			15M			20M		
Channel	18650	18900	19150	18675	18900	19125	18650	18900	19100
	(Low)	(Mid)	(High)	(Low)	(Mid)	(High)	(Low)	(Mid)	(High)
Frequency	1855	1880	1905	1857.5	1880	1902.5	1860	1880	1900
(MHz)									
Conducted Power (dBm)	23.13	23.19	23.11	23.02	23.12	23.13	23.17	23.20	23.19
Conducted Power (Watts)	0.2056	0.2084	0.2046	0.2004	0.2051	0.2056	0.2075	0.2089	0.2084
EIRP(dBm)	22.53	22.59	22.51	22.42	22.52	22.53	22.57	22.60	22.59
EIRP(Watts)	0.1791	0.1816	0.1782	0.1746	0.1786	0.1791	0.1807	0.1820	0.1816



LTE Band 2 ($G_T - L_C = -0.60$ dB) 16QAM									
Bandwidth	1.4M			3M			5M		
Channel	18607	18900	19193	18615	18900	19185	18625	18900	19175
	(Low)	(Mid)	(High)	(Low)	(Mid)	(High)	(Low)	(Mid)	(High)
Frequency (MHz)	1850.7	1880	1909.3	1851.5	1880	1908.5	1852.5	1880	1907.5
Conducted Power (dBm)	22.46	22.61	22.60	22.60	22.66	22.62	22.52	22.66	22.58
Conducted Power (Watts)	0.1762	0.1824	0.1820	0.1820	0.1845	0.1828	0.1786	0.1845	0.1811
EIRP(dBm)	21.86	22.01	22.00	22.00	22.06	22.02	21.92	22.06	21.98
EIRP(Watts)	0.1535	0.1589	0.1585	0.1585	0.1607	0.1592	0.1556	0.1607	0.1578

LTE Band 2 ($G_T - L_C = -0.60$ dB) 16QAM									
Bandwidth	10M			15M			20M		
Channel	18650	18900	19150	18675	18900	19125	18650	18900	19100
	(Low)	(Mid)	(High)	(Low)	(Mid)	(High)	(Low)	(Mid)	(High)
Frequency (MHz)	1855	1880	1905	1857.5	1880	1902.5	1860	1880	1900
Conducted Power (dBm)	22.57	22.76	22.58	22.42	22.71	22.59	22.79	22.67	22.76
Conducted Power (Watts)	0.1807	0.1888	0.1811	0.1746	0.1866	0.1816	0.1901	0.1849	0.1888
EIRP(dBm)	21.97	22.16	21.98	21.82	22.11	21.99	22.19	22.07	22.16
EIRP(Watts)	0.1574	0.1644	0.1578	0.1521	0.1626	0.1581	0.1656	0.1611	0.1644



LTE Band 2 ($G_T - L_C = -0.60$ dB) 64QAM									
Bandwidth	1.4M			3M			5M		
Channel	18607	18900	19193	18615	18900	19185	18625	18900	19175
	(Low)	(Mid)	(High)	(Low)	(Mid)	(High)	(Low)	(Mid)	(High)
Frequency	1850.7	1880	1909.3	1851.5	1880	1908.5	1852.5	1880	1907.5
(MHz)									
Conducted Power (dBm)	21.69	21.88	21.90	21.89	21.90	21.85	21.88	21.90	21.83
Conducted Power (Watts)	0.1476	0.1542	0.1549	0.1545	0.1549	0.1531	0.1542	0.1549	0.1524
EIRP(dBm)	21.09	21.28	21.30	21.29	21.30	21.25	21.28	21.30	21.23
EIRP(Watts)	0.1285	0.1343	0.1349	0.1346	0.1349	0.1334	0.1343	0.1349	0.1327

LTE Band 2 ($G_T - L_C = -0.60$ dB) 64QAM									
Bandwidth	10M			15M			20M		
Channel	18650	18900	19150	18675	18900	19125	18650	18900	19100
	(Low)	(Mid)	(High)	(Low)	(Mid)	(High)	(Low)	(Mid)	(High)
Frequency	1855	1880	1905	1857.5	1880	1902.5	1860	1880	1900
(MHz)									
Conducted Power (dBm)	21.92	21.98	22.00	21.95	21.96	21.90	21.90	21.99	21.95
Conducted Power (Watts)	0.1556	0.1578	0.1585	0.1567	0.1570	0.1549	0.1549	0.1581	0.1567
EIRP(dBm)	21.32	21.38	21.40	21.35	21.36	21.30	21.30	21.39	21.35
EIRP(Watts)	0.1355	0.1374	0.1380	0.1365	0.1368	0.1349	0.1349	0.1377	0.1365



LTE Band 5 ($G_T - L_C = -3.30$ dB) QPSK									
Bandwidth	1.4M			3M			5M		
Channel	20407	20525	20643	20415	20525	20635	20425	20525	20625
	(Low)	(Mid)	(High)	(Low)	(Mid)	(High)	(Low)	(Mid)	(High)
Frequency (MHz)	824.7	836.5	848.3	825.5	836.5	847.5	826.5	836.5	846.5
Conducted Power (dBm)	23.28	23.43	23.32	23.29	23.43	23.25	23.32	23.41	23.32
Conducted Power (Watts)	0.2128	0.2203	0.2148	0.2133	0.2203	0.2113	0.2148	0.2193	0.2148
ERP(dBm)	17.83	17.98	17.87	17.84	17.98	17.80	17.87	17.96	17.87
ERP(Watts)	0.0607	0.0628	0.0612	0.0608	0.0628	0.0603	0.0612	0.0625	0.0612

LTE Band 5 ($G_T - L_C = -3.30$ dB) QPSK			
Bandwidth	10M		
Channel	20450	20525	20600
	(Low)	(Mid)	(High)
Frequency (MHz)	829	836.5	844
Conducted Power (dBm)	23.31	23.47	23.36
Conducted Power (Watts)	0.2143	0.2223	0.2168
ERP(dBm)	17.86	18.02	17.91
ERP(Watts)	0.0611	0.0634	0.0618



LTE Band 5 ($G_T - L_C = -3.30$ dB) 16QAM									
Bandwidth	1.4M			3M			5M		
Channel	20407	20525	20643	20415	20525	20635	20425	20525	20625
	(Low)	(Mid)	(High)	(Low)	(Mid)	(High)	(Low)	(Mid)	(High)
Frequency (MHz)	824.7	836.5	848.3	825.5	836.5	847.5	826.5	836.5	846.5
Conducted Power (dBm)	22.63	22.88	22.65	22.66	22.81	22.77	22.73	22.86	22.74
Conducted Power (Watts)	0.1832	0.1941	0.1841	0.1845	0.1910	0.1892	0.1875	0.1932	0.1879
ERP(dBm)	17.18	17.43	17.20	17.21	17.36	17.32	17.28	17.41	17.29
ERP(Watts)	0.0522	0.0553	0.0525	0.0526	0.0545	0.0540	0.0535	0.0551	0.0536

LTE Band 5 ($G_T - L_C = -3.30$ dB) 16QAM			
Bandwidth	10M		
Channel	20450	20525	20600
	(Low)	(Mid)	(High)
Frequency (MHz)	829	836.5	844
Conducted Power (dBm)	22.70	22.89	22.78
Conducted Power (Watts)	0.1862	0.1945	0.1897
ERP(dBm)	17.25	17.44	17.33
ERP(Watts)	0.0531	0.0555	0.0541



LTE Band 5 ($G_T - L_C = -3.30$ dB) 64QAM									
Bandwidth	1.4M			3M			5M		
Channel	20407	20525	20643	20415	20525	20635	20425	20525	20625
	(Low)	(Mid)	(High)	(Low)	(Mid)	(High)	(Low)	(Mid)	(High)
Frequency (MHz)	824.7	836.5	848.3	825.5	836.5	847.5	826.5	836.5	846.5
Conducted Power (dBm)	21.80	21.96	21.80	21.84	21.99	21.95	21.86	21.96	21.80
Conducted Power (Watts)	0.1514	0.1570	0.1514	0.1528	0.1581	0.1567	0.1535	0.1570	0.1514
ERP(dBm)	16.35	16.51	16.35	16.39	16.54	16.50	16.41	16.51	16.35
ERP(Watts)	0.0432	0.0448	0.0432	0.0436	0.0451	0.0447	0.0438	0.0448	0.0432

LTE Band 5 ($G_T - L_C = -3.30$ dB) 64QAM			
Bandwidth	10M		
Channel	20450	20525	20600
	(Low)	(Mid)	(High)
Frequency (MHz)	829	836.5	844
Conducted Power (dBm)	21.75	21.99	21.89
Conducted Power (Watts)	0.1496	0.1581	0.1545
ERP(dBm)	16.30	16.54	16.44
ERP(Watts)	0.0427	0.0451	0.0441



< Antenna #2 >

LTE Band 7 (G _T - L _C = -2.10 dB) QPSK			
Bandwidth	5M		
Channel	20775	21100	21425
	(Low)	(Mid)	(High)
Frequency	2502.5	2535	2567.5
(MHz)			
Conducted Power (dBm)	23.28	22.87	22.95
Conducted Power (Watts)	0.2128	0.1936	0.1972
EIRP(dBm)	21.18	20.77	20.85
EIRP(Watts)	0.1312	0.1194	0.1216

LTE Band 7 (G _T - L _C = -2.10 dB) QPSK									
Bandwidth	10M			15M			20M		
Channel	20800	21100	21400	20825	21100	21375	20850	21100	21350
	(Low)	(Mid)	(High)	(Low)	(Mid)	(High)	(Low)	(Mid)	(Mid)
Frequency	2505	2535	2565	2507.5	2535	2562.5	2510	2535	2560
(MHz)									
Conducted Power (dBm)	23.23	22.87	22.94	23.30	22.83	23.03	23.32	22.89	22.99
Conducted Power (Watts)	0.2104	0.1936	0.1968	0.2138	0.1919	0.2009	0.2148	0.1945	0.1991
EIRP(dBm)	21.13	20.77	20.84	21.20	20.73	20.93	21.22	20.79	20.89
EIRP(Watts)	0.1297	0.1194	0.1213	0.1318	0.1183	0.1239	0.1324	0.1199	0.1227



LTE Band 7 ($G_T - L_C = -2.10$ dB) 16QAM			
Bandwidth	5M		
Channel	20775	21100	21425
	(Low)	(Mid)	(High)
Frequency (MHz)	2502.5	2535	2567.5
	Conducted Power (dBm)	22.57	22.09
Conducted Power (Watts)	0.1807	0.1618	0.1637
EIRP(dBm)	20.47	19.99	20.04
EIRP(Watts)	0.1114	0.0998	0.1009

LTE Band 7 ($G_T - L_C = -2.10$ dB) 16QAM									
Bandwidth	10M			15M			20M		
Channel	20800	21100	21400	20825	21100	21375	20850	21100	21350
	(Low)	(Mid)	(High)	(Low)	(Mid)	(High)	(Low)	(Mid)	(Mid)
Frequency (MHz)	2505	2535	2565	2507.5	2535	2562.5	2510	2535	2560
	Conducted Power (dBm)	22.58	22.08	22.19	22.53	22.14	22.28	22.51	22.21
Conducted Power (Watts)	0.1811	0.1614	0.1656	0.1791	0.1637	0.1690	0.1782	0.1663	0.1694
EIRP(dBm)	20.48	19.98	20.09	20.43	20.04	20.18	20.41	20.11	20.19
EIRP(Watts)	0.1117	0.0995	0.1021	0.1104	0.1009	0.1042	0.1099	0.1026	0.1045



LTE Band 7 ($G_T - L_C = -2.10$ dB) 64QAM			
Bandwidth	5M		
Channel	20775	21100	21425
	(Low)	(Mid)	(High)
Frequency (MHz)	2502.5	2535	2567.5
	Conducted Power (dBm)	21.55	21.26
Conducted Power (Watts)	0.1429	0.1337	0.1349
EIRP(dBm)	19.45	19.16	19.20
EIRP(Watts)	0.0881	0.0824	0.0832

LTE Band 7 ($G_T - L_C = -2.10$ dB) 64QAM									
Bandwidth	10M			15M			20M		
Channel	20800	21100	21400	20825	21100	21375	20850	21100	21350
	(Low)	(Mid)	(High)	(Low)	(Mid)	(High)	(Low)	(Mid)	(Mid)
Frequency (MHz)	2505	2535	2565	2507.5	2535	2562.5	2510	2535	2560
	Conducted Power (dBm)	21.60	21.27	21.30	21.65	21.31	21.35	21.69	21.37
Conducted Power (Watts)	0.1445	0.1340	0.1349	0.1462	0.1352	0.1365	0.1476	0.1371	0.1396
EIRP(dBm)	19.50	19.17	19.20	19.55	19.21	19.25	19.59	19.27	19.35
EIRP(Watts)	0.0891	0.0826	0.0832	0.0902	0.0834	0.0841	0.0910	0.0845	0.0861



< Antenna #3 >

LTE Band 7 (G _T - L _C = -0.50 dB) QPSK			
Bandwidth	5M		
Channel	20775	21100	21425
	(Low)	(Mid)	(High)
Frequency	2502.5	2535	2567.5
(MHz)			
Conducted Power (dBm)	23.28	22.87	22.95
Conducted Power (Watts)	0.2128	0.1936	0.1972
EIRP(dBm)	22.78	22.37	22.45
EIRP(Watts)	0.1897	0.1726	0.1758

LTE Band 7 (G _T - L _C = -0.50 dB) QPSK									
Bandwidth	10M			15M			20M		
Channel	20800	21100	21400	20825	21100	21375	20850	21100	21350
	(Low)	(Mid)	(High)	(Low)	(Mid)	(High)	(Low)	(Mid)	(Mid)
Frequency	2505	2535	2565	2507.5	2535	2562.5	2510	2535	2560
(MHz)									
Conducted Power (dBm)	23.23	22.87	22.94	23.30	22.83	23.03	23.32	22.89	22.99
Conducted Power (Watts)	0.2104	0.1936	0.1968	0.2138	0.1919	0.2009	0.2148	0.1945	0.1991
EIRP(dBm)	22.73	22.37	22.44	22.80	22.33	22.53	22.82	22.39	22.49
EIRP(Watts)	0.1875	0.1726	0.1754	0.1905	0.1710	0.1791	0.1914	0.1734	0.1774



LTE Band 7 ($G_T - L_C = -0.50$ dB) 16QAM			
Bandwidth	5M		
Channel	20775	21100	21425
	(Low)	(Mid)	(High)
Frequency (MHz)	2502.5	2535	2567.5
	Conducted Power (dBm)	22.57	22.09
Conducted Power (Watts)	0.1807	0.1618	0.1637
EIRP(dBm)	22.07	21.59	21.64
EIRP(Watts)	0.1611	0.1442	0.1459

LTE Band 7 ($G_T - L_C = -0.50$ dB) 16QAM									
Bandwidth	10M			15M			20M		
Channel	20800	21100	21400	20825	21100	21375	20850	21100	21350
	(Low)	(Mid)	(High)	(Low)	(Mid)	(High)	(Low)	(Mid)	(Mid)
Frequency (MHz)	2505	2535	2565	2507.5	2535	2562.5	2510	2535	2560
	Conducted Power (dBm)	22.58	22.08	22.19	22.53	22.14	22.28	22.51	22.21
Conducted Power (Watts)	0.1811	0.1614	0.1656	0.1791	0.1637	0.1690	0.1782	0.1663	0.1694
EIRP(dBm)	22.08	21.58	21.69	22.03	21.64	21.78	22.01	21.71	21.79
EIRP(Watts)	0.1614	0.1439	0.1476	0.1596	0.1459	0.1507	0.1589	0.1483	0.1510



LTE Band 7 ($G_T - L_C = -0.50$ dB) 64QAM			
Bandwidth	5M		
Channel	20775	21100	21425
	(Low)	(Mid)	(High)
Frequency (MHz)	2502.5	2535	2567.5
	Conducted Power (dBm)	21.55	21.26
Conducted Power (Watts)	0.1429	0.1337	0.1349
EIRP(dBm)	21.05	20.76	20.80
EIRP(Watts)	0.1274	0.1191	0.1202

LTE Band 7 ($G_T - L_C = -0.50$ dB) 64QAM									
Bandwidth	10M			15M			20M		
Channel	20800	21100	21400	20825	21100	21375	20850	21100	21350
	(Low)	(Mid)	(High)	(Low)	(Mid)	(High)	(Low)	(Mid)	(Mid)
Frequency (MHz)	2505	2535	2565	2507.5	2535	2562.5	2510	2535	2560
	Conducted Power (dBm)	21.60	21.27	21.30	21.65	21.31	21.35	21.69	21.37
Conducted Power (Watts)	0.1445	0.1340	0.1349	0.1462	0.1352	0.1365	0.1476	0.1371	0.1396
EIRP(dBm)	21.10	20.77	20.80	21.15	20.81	20.85	21.19	20.87	20.95
EIRP(Watts)	0.1288	0.1194	0.1202	0.1303	0.1205	0.1216	0.1315	0.1222	0.1245



LTE Band 26 (G _T - L _C = -3.30 dB) QPSK									
Bandwidth	1.4M			3M			5M		
Channel	26797	26915	27033	26805	26915	27025	26815	26915	27015
	(Low)	(Mid)	(High)	(Low)	(Mid)	(High)	(Low)	(Mid)	(High)
Frequency	824.7	836.5	848.3	825.5	836.5	847.5	826.5	836.5	846.5
(MHz)									
Conducted Power (dBm)	22.99	23.02	23.13	23.11	23.22	23.15	23.04	23.23	23.14
Conducted Power (Watts)	0.1991	0.2004	0.2056	0.2046	0.2099	0.2065	0.2014	0.2104	0.2061
ERP(dBm)	17.54	17.57	17.68	17.66	17.77	17.70	17.59	17.78	17.69
ERP(Watts)	0.0568	0.0571	0.0586	0.0583	0.0598	0.0589	0.0574	0.0600	0.0587

LTE Band 26 (G _T - L _C = -3.30 dB) QPSK							
Bandwidth	10M			15M			15M
Channel	26840	26915	26990	26865	26915	26965	26765
	(Low)	(Mid)	(High)	(Low)	(Mid)	(High)	(Low)
Frequency	829	836.5	844	831.5	836.5	841.5	821.5
(MHz)							
Conducted Power (dBm)	23.11	23.20	23.23	23.33	23.20	23.21	23.30
Conducted Power (Watts)	0.2046	0.2089	0.2104	0.2153	0.2089	0.2094	0.2138
ERP(dBm)	17.66	17.75	17.78	17.88	17.75	17.76	17.85
ERP(Watts)	0.0583	0.0596	0.0600	0.0614	0.0596	0.0597	0.0610



LTE Band 26 (G _T - L _C = -3.30 dB) 16QAM									
Bandwidth	1.4M			3M			5M		
Channel	26797	26915	27033	26805	26915	27025	26815	26915	27015
	(Low)	(Mid)	(High)	(Low)	(Mid)	(High)	(Low)	(Mid)	(High)
Frequency	824.7	836.5	848.3	825.5	836.5	847.5	826.5	836.5	846.5
(MHz)									
Conducted Power (dBm)	22.41	22.57	22.45	22.37	22.59	22.63	22.54	22.44	22.60
Conducted Power (Watts)	0.1742	0.1807	0.1758	0.1726	0.1816	0.1832	0.1795	0.1754	0.1820
ERP(dBm)	16.96	17.12	17.00	16.92	17.14	17.18	17.09	16.99	17.15
ERP(Watts)	0.0497	0.0515	0.0501	0.0492	0.0518	0.0522	0.0512	0.0500	0.0519

LTE Band 26 (G _T - L _C = -3.30 dB) 16QAM							
Bandwidth	10M			15M			15M
Channel	26840	26915	26990	26865	26915	26965	26765
	(Low)	(Mid)	(High)	(Low)	(Mid)	(High)	(Low)
Frequency	829	836.5	844	831.5	836.5	841.5	821.5
(MHz)							
Conducted Power (dBm)	22.31	22.45	22.62	22.76	22.58	22.60	22.67
Conducted Power (Watts)	0.1702	0.1758	0.1828	0.1888	0.1811	0.1820	0.1849
ERP(dBm)	16.86	17.00	17.17	17.31	17.13	17.15	17.22
ERP(Watts)	0.0485	0.0501	0.0521	0.0538	0.0516	0.0519	0.0527



LTE Band 26 (G _T - L _C = -3.30 dB) 64QAM									
Bandwidth	1.4M			3M			5M		
Channel	26797	26915	27033	26805	26915	27025	26815	26915	27015
	(Low)	(Mid)	(High)	(Low)	(Mid)	(High)	(Low)	(Mid)	(High)
Frequency	824.7	836.5	848.3	825.5	836.5	847.5	826.5	836.5	846.5
(MHz)									
Conducted Power (dBm)	21.57	21.64	21.78	21.59	21.60	21.90	21.61	21.67	21.75
Conducted Power (Watts)	0.1435	0.1459	0.1507	0.1442	0.1445	0.1549	0.1449	0.1469	0.1496
ERP(dBm)	16.12	16.19	16.33	16.14	16.15	16.45	16.16	16.22	16.30
ERP(Watts)	0.0409	0.0416	0.0430	0.0411	0.0412	0.0442	0.0413	0.0419	0.0427

LTE Band 26 (G _T - L _C = -3.30 dB) 64QAM							
Bandwidth	10M			15M			15M
Channel	26840	26915	26990	26865	26915	26965	26765
	(Low)	(Mid)	(High)	(Low)	(Mid)	(High)	(Low)
Frequency	829	836.5	844	831.5	836.5	841.5	821.5
(MHz)							
Conducted Power (dBm)	21.60	21.61	21.80	21.89	21.77	21.80	21.82
Conducted Power (Watts)	0.1445	0.1449	0.1514	0.1545	0.1503	0.1514	0.1521
ERP(dBm)	16.15	16.16	16.35	16.44	16.32	16.35	16.37
ERP(Watts)	0.0412	0.0413	0.0432	0.0441	0.0429	0.0432	0.0434



< Antenna #2 >

LTE Band 38 (G _T - L _C = -2.30 dB) QPSK			
Bandwidth	5M		
Channel	37775	38000	38225
	(Low)	(Mid)	(High)
Frequency	2572.5	2595	2617.5
(MHz)			
Conducted Power (dBm)	22.83	22.57	22.80
Conducted Power (Watts)	0.1919	0.1807	0.1905
EIRP(dBm)	20.53	20.27	20.50
EIRP(Watts)	0.1130	0.1064	0.1122

LTE Band 38 (G _T - L _C = -2.30 dB) QPSK									
Bandwidth	10M			15M			20M		
Channel	37800	38000	38200	37825	38000	38175	37850	38000	38150
	(Low)	(Mid)	(High)	(Low)	(Mid)	(High)	(Low)	(Mid)	(Mid)
Frequency	2575	2595	2615	2577.5	2595	2612.5	2580	2595	2610
(MHz)									
Conducted Power (dBm)	22.82	22.57	22.76	22.80	22.69	22.68	22.84	22.66	22.73
Conducted Power (Watts)	0.1914	0.1807	0.1888	0.1905	0.1858	0.1854	0.1923	0.1845	0.1875
EIRP(dBm)	20.52	20.27	20.46	20.50	20.39	20.38	20.54	20.36	20.43
EIRP(Watts)	0.1127	0.1064	0.1112	0.1122	0.1094	0.1091	0.1132	0.1086	0.1104



LTE Band 38 (G _T - L _C = -2.30 dB) 16QAM			
Bandwidth	5M		
Channel	37775	38000	38225
	(Low)	(Mid)	(High)
Frequency	2572.5	2595	2617.5
(MHz)			
Conducted Power (dBm)	21.96	21.75	21.96
Conducted Power (Watts)	0.1570	0.1496	0.1570
EIRP(dBm)	19.66	19.45	19.66
EIRP(Watts)	0.0925	0.0881	0.0925

LTE Band 38 (G _T - L _C = -2.30 dB) 16QAM									
Bandwidth	10M			15M			20M		
Channel	37800	38000	38200	37825	38000	38175	37850	38000	38150
	(Low)	(Mid)	(High)	(Low)	(Mid)	(High)	(Low)	(Mid)	(Mid)
Frequency	2575	2595	2615	2577.5	2595	2612.5	2580	2595	2610
(MHz)									
Conducted Power (dBm)	22.02	21.79	21.96	21.95	21.84	21.84	21.92	21.82	21.86
Conducted Power (Watts)	0.1592	0.1510	0.1570	0.1567	0.1528	0.1528	0.1556	0.1521	0.1535
EIRP(dBm)	19.72	19.49	19.66	19.65	19.54	19.54	19.62	19.52	19.56
EIRP(Watts)	0.0938	0.0889	0.0925	0.0923	0.0899	0.0899	0.0916	0.0895	0.0904



LTE Band 38 (G _T - L _C = -2.30 dB) 64QAM			
Bandwidth	5M		
Channel	37775	38000	38225
	(Low)	(Mid)	(High)
Frequency (MHz)	2572.5	2595	2617.5
	Conducted Power (dBm)	21.12	20.82
Conducted Power (Watts)	0.1294	0.1208	0.1303
EIRP(dBm)	18.82	18.52	18.85
EIRP(Watts)	0.0762	0.0711	0.0767

LTE Band 38 (G _T - L _C = -2.30 dB) 64QAM									
Bandwidth	10M			15M			20M		
Channel	37800	38000	38200	37825	38000	38175	37850	38000	38150
	(Low)	(Mid)	(High)	(Low)	(Mid)	(High)	(Low)	(Mid)	(Mid)
Frequency (MHz)	2575	2595	2615	2577.5	2595	2612.5	2580	2595	2610
	Conducted Power (dBm)	21.02	20.87	20.99	21.02	20.91	20.90	20.95	20.86
Conducted Power (Watts)	0.1265	0.1222	0.1256	0.1265	0.1233	0.1230	0.1245	0.1219	0.1230
EIRP(dBm)	18.72	18.57	18.69	18.72	18.61	18.60	18.65	18.56	18.60
EIRP(Watts)	0.0745	0.0719	0.0740	0.0745	0.0726	0.0724	0.0733	0.0718	0.0724



< Antenna #3 >

LTE Band 38 (G _T - L _C = -0.50 dB) QPSK			
Bandwidth	5M		
Channel	37775	38000	38225
	(Low)	(Mid)	(High)
Frequency	2572.5	2595	2617.5
(MHz)			
Conducted Power (dBm)	22.83	22.57	22.80
Conducted Power (Watts)	0.1919	0.1807	0.1905
EIRP(dBm)	22.33	22.07	22.30
EIRP(Watts)	0.1710	0.1611	0.1698

LTE Band 38 (G _T - L _C = -0.50 dB) QPSK									
Bandwidth	10M			15M			20M		
Channel	37800	38000	38200	37825	38000	38175	37850	38000	38150
	(Low)	(Mid)	(High)	(Low)	(Mid)	(High)	(Low)	(Mid)	(Mid)
Frequency	2575	2595	2615	2577.5	2595	2612.5	2580	2595	2610
(MHz)									
Conducted Power (dBm)	22.82	22.57	22.76	22.80	22.69	22.68	22.84	22.66	22.73
Conducted Power (Watts)	0.1914	0.1807	0.1888	0.1905	0.1858	0.1854	0.1923	0.1845	0.1875
EIRP(dBm)	22.32	22.07	22.26	22.30	22.19	22.18	22.34	22.16	22.23
EIRP(Watts)	0.1706	0.1611	0.1683	0.1698	0.1656	0.1652	0.1714	0.1644	0.1671



LTE Band 38 (G _T - L _C = -0.50 dB) 16QAM			
Bandwidth	5M		
Channel	37775	38000	38225
	(Low)	(Mid)	(High)
Frequency	2572.5	2595	2617.5
(MHz)			
Conducted Power (dBm)	21.96	21.75	21.96
Conducted Power (Watts)	0.1570	0.1496	0.1570
EIRP(dBm)	21.46	21.25	21.46
EIRP(Watts)	0.1400	0.1334	0.1400

LTE Band 38 (G _T - L _C = -0.50 dB) 16QAM									
Bandwidth	10M			15M			20M		
Channel	37800	38000	38200	37825	38000	38175	37850	38000	38150
	(Low)	(Mid)	(High)	(Low)	(Mid)	(High)	(Low)	(Mid)	(Mid)
Frequency	2575	2595	2615	2577.5	2595	2612.5	2580	2595	2610
(MHz)									
Conducted Power (dBm)	22.02	21.79	21.96	21.95	21.84	21.84	21.92	21.82	21.86
Conducted Power (Watts)	0.1592	0.1510	0.1570	0.1567	0.1528	0.1528	0.1556	0.1521	0.1535
EIRP(dBm)	21.52	21.29	21.46	21.45	21.34	21.34	21.42	21.32	21.36
EIRP(Watts)	0.1419	0.1346	0.1400	0.1396	0.1361	0.1361	0.1387	0.1355	0.1368



LTE Band 38 (G _T - L _C = -0.50 dB) 64QAM			
Bandwidth	5M		
Channel	37775	38000	38225
	(Low)	(Mid)	(High)
Frequency (MHz)	2572.5	2595	2617.5
	Conducted Power (dBm)	21.12	20.82
Conducted Power (Watts)	0.1294	0.1208	0.1303
EIRP(dBm)	20.62	20.32	20.65
EIRP(Watts)	0.1153	0.1076	0.1161

LTE Band 38 (G _T - L _C = -0.50 dB) 64QAM									
Bandwidth	10M			15M			20M		
Channel	37800	38000	38200	37825	38000	38175	37850	38000	38150
	(Low)	(Mid)	(High)	(Low)	(Mid)	(High)	(Low)	(Mid)	(Mid)
Frequency (MHz)	2575	2595	2615	2577.5	2595	2612.5	2580	2595	2610
	Conducted Power (dBm)	21.02	20.87	20.99	21.02	20.91	20.90	20.95	20.86
Conducted Power (Watts)	0.1265	0.1222	0.1256	0.1265	0.1233	0.1230	0.1245	0.1219	0.1230
EIRP(dBm)	20.52	20.37	20.49	20.52	20.41	20.40	20.45	20.36	20.40
EIRP(Watts)	0.1127	0.1089	0.1119	0.1127	0.1099	0.1096	0.1109	0.1086	0.1096



Peak-to-Average Ratio

Mode	LTE Band 5 / 10MHz				
Mod.	QPSK		16QAM		Limit: 13dB
RB Size	1RB	Full RB	1RB	Full RB	Result
Lowest CH	3.86	4.84	5.28	6.09	PASS
Middle CH	3.83	5.04	5.22	6.26	
Highest CH	3.86	4.99	5.04	6.12	
Mod.	64QAM		Limit: 13dB		
RB Size	1RB	Full RB	Result		
Lowest CH	5.42	6.14	PASS		
Middle CH	5.57	6.32			
Highest CH	5.48	6.23			

Mode	LTE Band 7 / 20MHz				
Mod.	QPSK		16QAM		Limit: 13dB
RB Size	1RB	Full RB	1RB	Full RB	Result
Lowest CH	3.39	4.64	4.96	5.86	PASS
Middle CH	3.33	4.41	4.93	5.68	
Highest CH	3.54	4.41	5.19	5.74	
Mod.	64QAM		Limit: 13dB		
RB Size	1RB	Full RB	Result		
Lowest CH	5.01	5.80	PASS		
Middle CH	4.93	5.65			
Highest CH	5.36	5.71			

Mode	LTE Band 26 / 15MHz				
Mod.	QPSK		16QAM		Limit: 13dB
RB Size	1RB	Full RB	1RB	Full RB	Result
Lowest CH	3.8	4.96	5.07	6.2	PASS
Middle CH	3.68	4.87	5.48	6.17	
Highest CH	3.91	4.93	5.83	6.17	
Mod.	64QAM		Limit: 13dB		
RB Size	1RB	Full RB	Result		
Lowest CH	6.75	6.87	PASS		
Middle CH	6.72	6.72			
Highest CH	6.49	6.72			



Mode	LTE Band 38 / 20MHz				
Mod.	QPSK		16QAM		Limit: 13dB
RB Size	1RB	Full RB	1RB	Full RB	Result
Lowest CH	5.45	6.14	5.54	6.14	PASS
Middle CH	5.59	5.39	6.23	6.75	
Highest CH	4.90	5.86	6.14	6.14	
Mod.	64QAM		Limit: 13dB		
RB Size	1RB	Full RB	Result		
Lowest CH	6.90	6.49	PASS		
Middle CH	6.43	6.58			
Highest CH	6.75	6.64			



LTE Band 5 / 10MHz / QPSK

Lowest Channel / 1RB

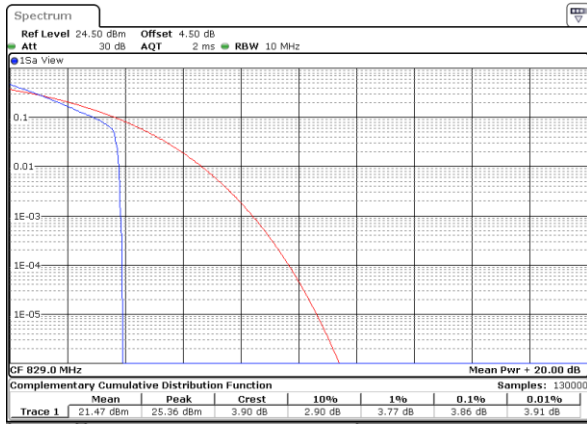

Date: 14 JAN 2018 21:35:48

Lowest Channel / Full RB

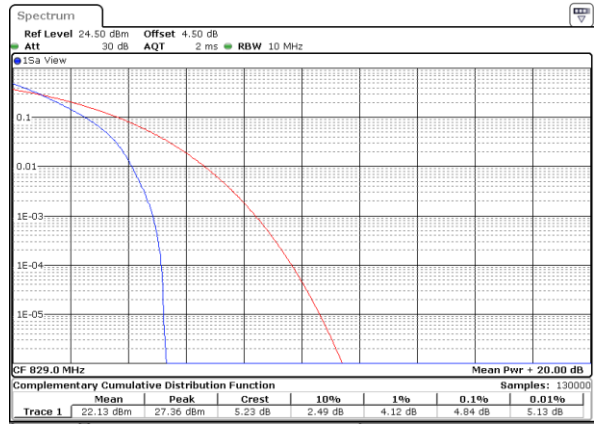

Date: 14 JAN 2018 21:35:38

Middle Channel / 1RB

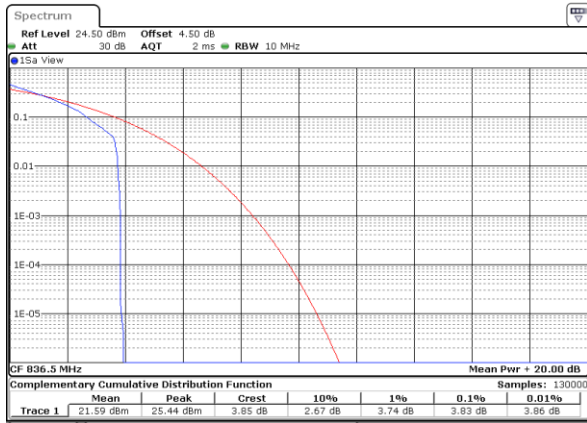

Date: 14 JAN 2018 21:36:00

Middle Channel / Full RB

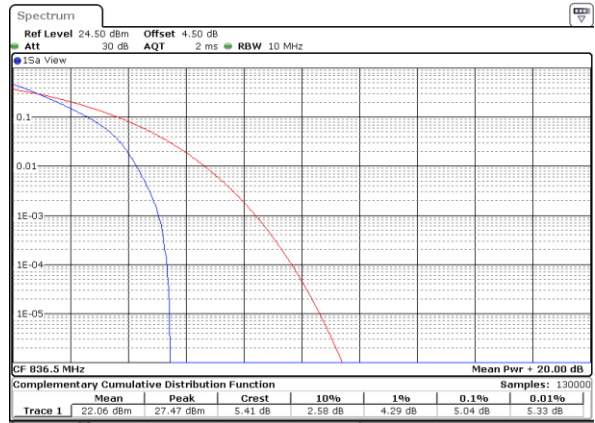

Date: 14 JAN 2018 21:35:26

Highest Channel / 1RB

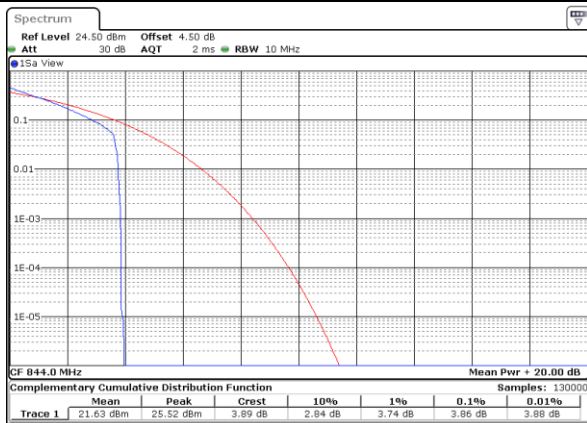

Date: 14 JAN 2018 21:36:11

Highest Channel / Full RB

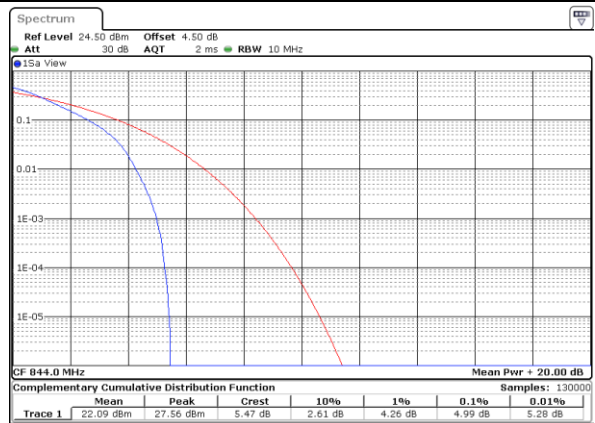

Date: 14 JAN 2018 21:35:15



LTE Band 5 / 10MHz / 16QAM

Lowest Channel / 1RB

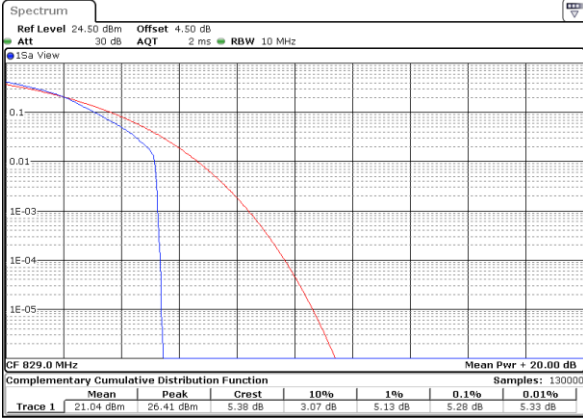

Date: 14 JAN 2018 21:34:01

Lowest Channel / Full RB

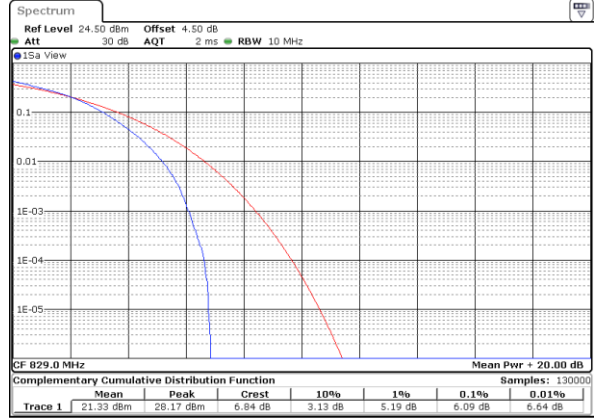

Date: 14 JAN 2018 21:34:09

Middle Channel / 1RB

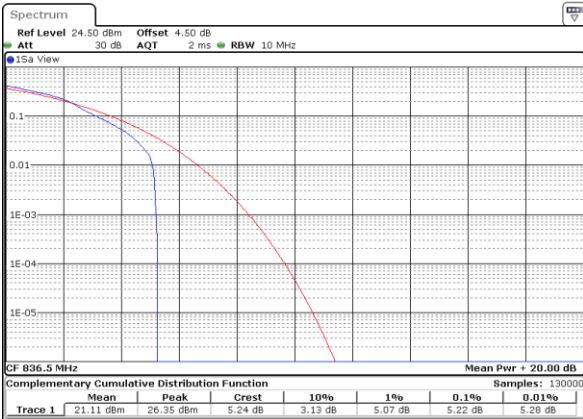

Date: 14 JAN 2018 21:34:18

Middle Channel / Full RB

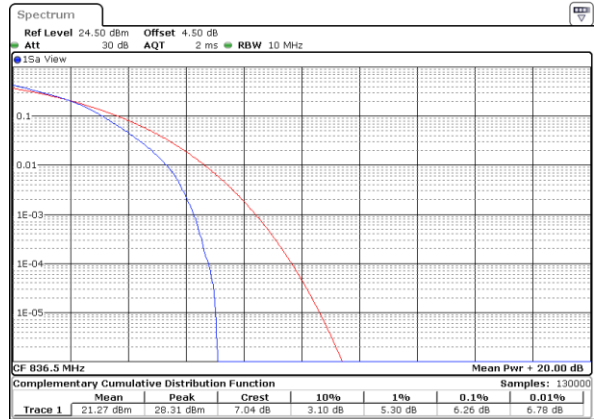

Date: 14 JAN 2018 21:34:27

Highest Channel / 1RB

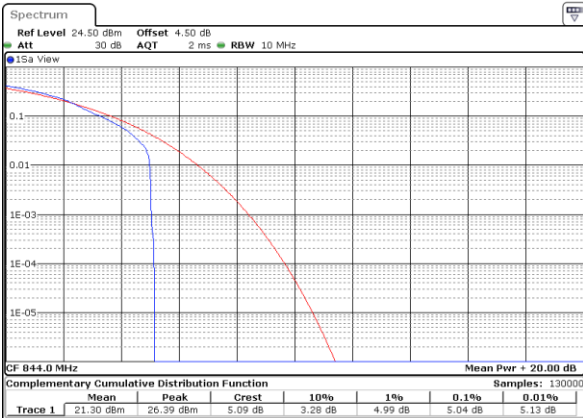

Date: 14 JAN 2018 21:34:36

Highest Channel / Full RB

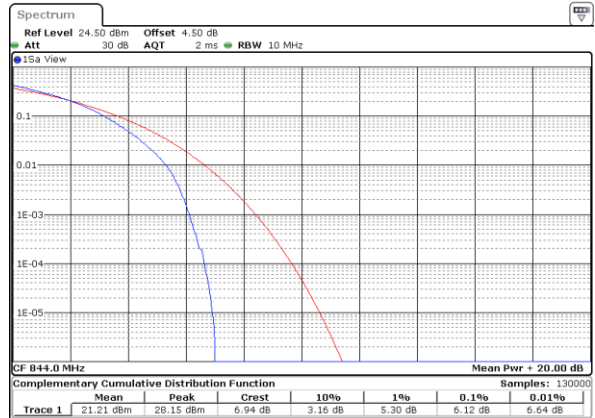

Date: 14 JAN 2018 21:34:45



LTE Band 5 / 10MHz / 64QAM

Lowest Channel / 1RB

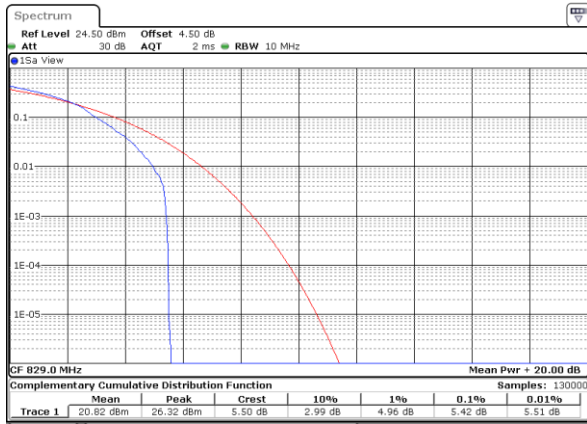

Date: 14 JAN 2018 21:36:49

Lowest Channel / Full RB

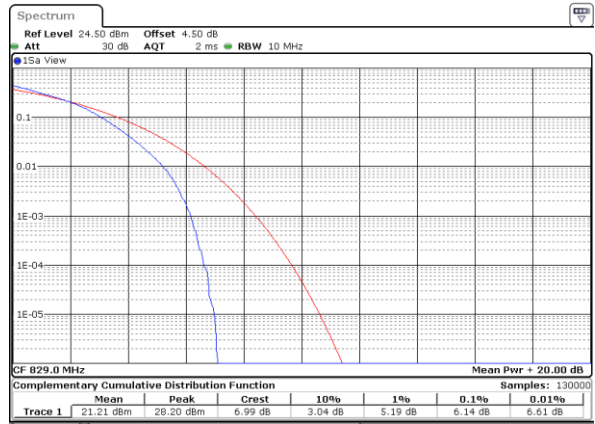

Date: 14 JAN 2018 21:37:03

Middle Channel / 1RB

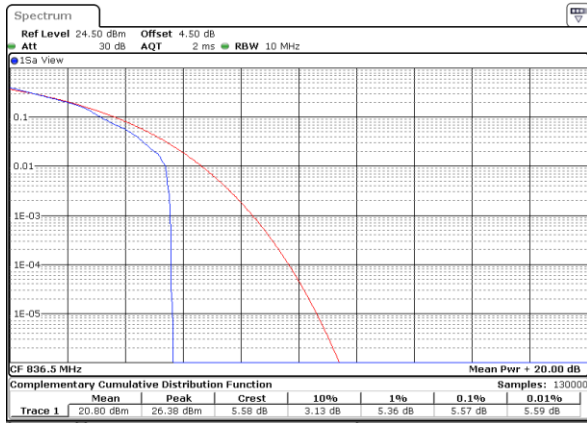

Date: 14 JAN 2018 21:36:35

Middle Channel / Full RB

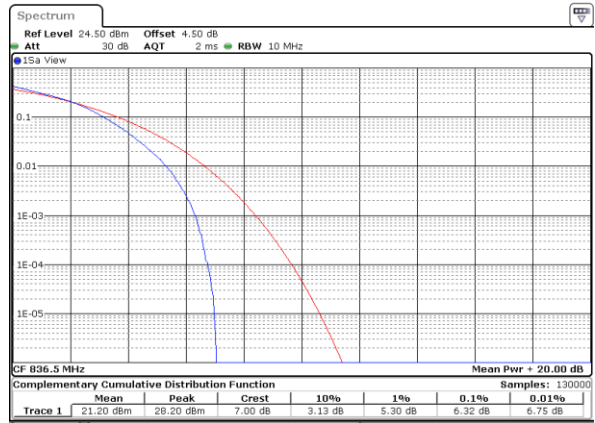

Date: 14 JAN 2018 21:37:29

Highest Channel / 1RB

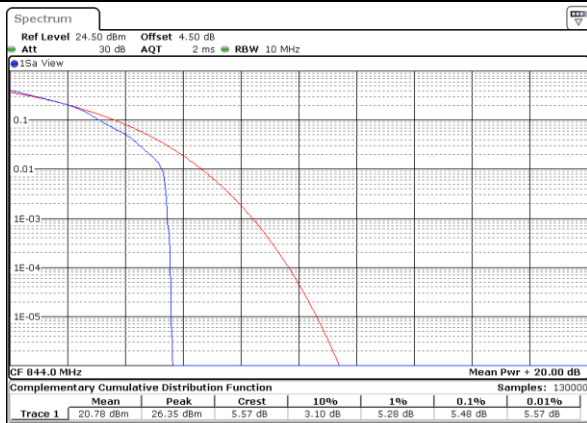

Date: 14 JAN 2018 21:36:24

Highest Channel / Full RB



Date: 14 JAN 2018 21:37:40



LTE Band 7 / 20MHz / QPSK

Lowest Channel / 1RB

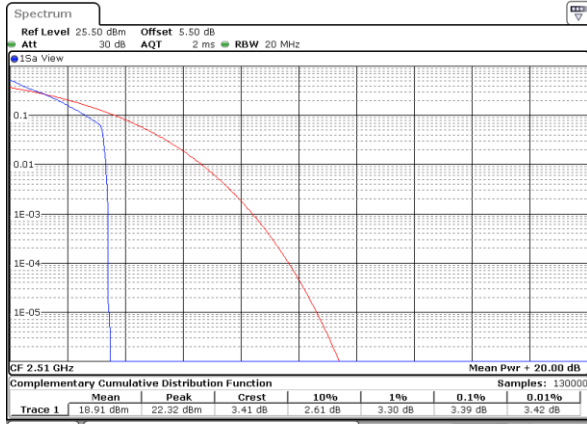

Date: 7 MAR 2018 09:44:58

Lowest Channel / Full RB

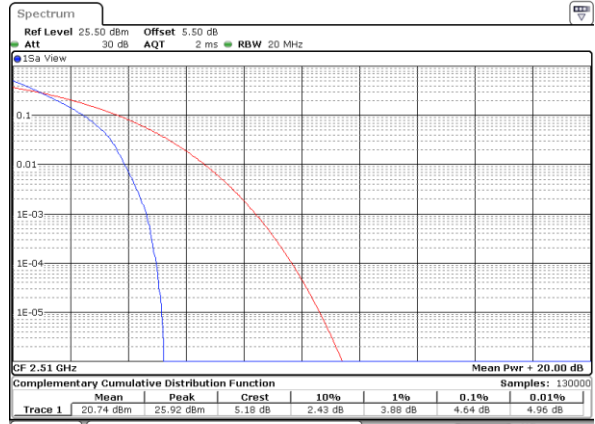

Date: 7 MAR 2018 09:45:24

Middle Channel / 1RB

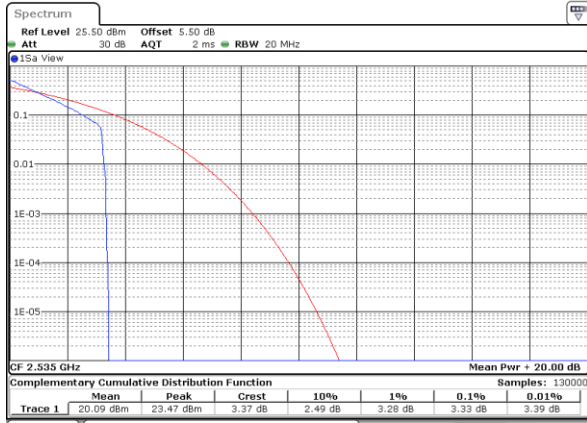

Date: 7 MAR 2018 09:46:00

Middle Channel / Full RB

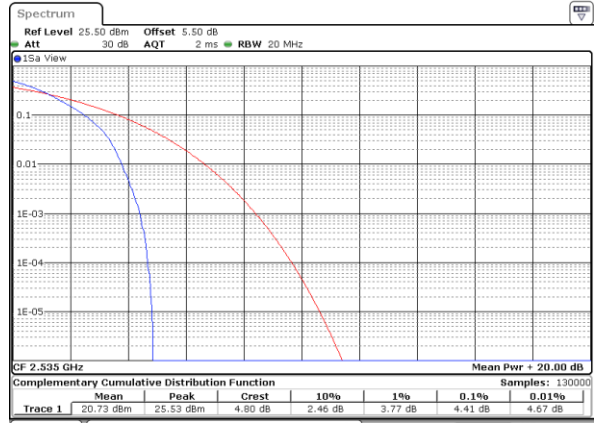

Date: 7 MAR 2018 09:45:33

Highest Channel / 1RB

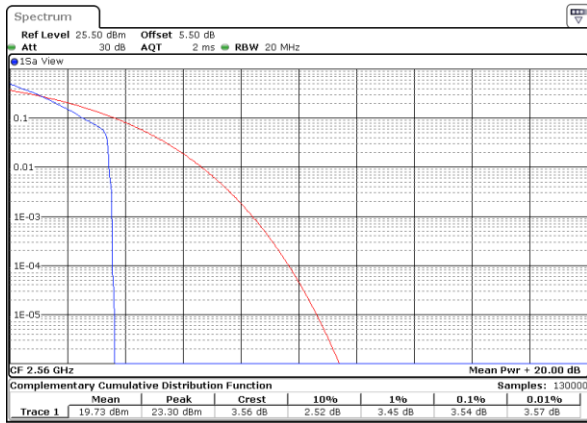

Date: 7 MAR 2018 09:46:09

Highest Channel / Full RB

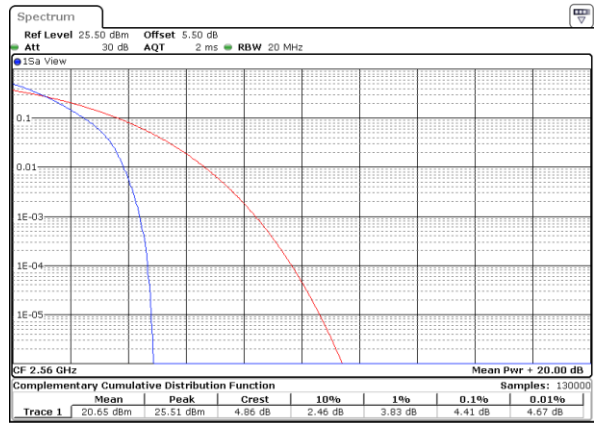

Date: 7 MAR 2018 09:46:37



LTE Band 7 / 20MHz / 16QAM

Lowest Channel / 1RB

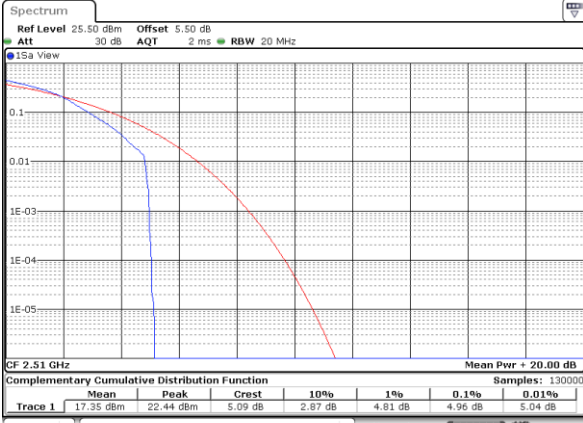

Date: 7 MAR 2018 09:45:07

Lowest Channel / Full RB

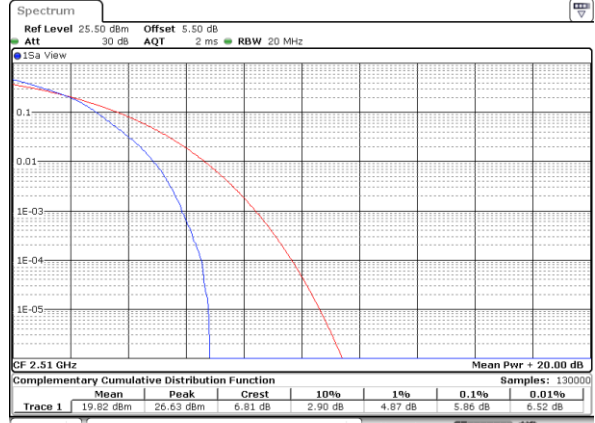

Date: 7 MAR 2018 09:45:16

Middle Channel / 1RB

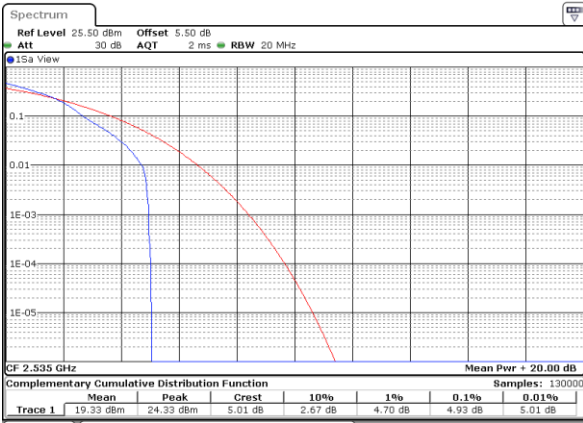

Date: 7 MAR 2018 09:45:50

Middle Channel / Full RB

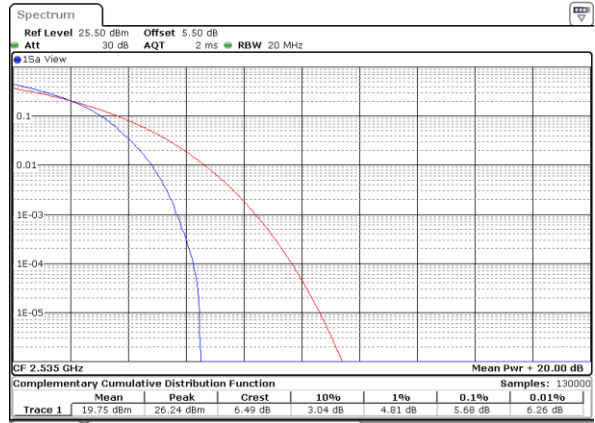

Date: 7 MAR 2018 09:45:41

Highest Channel / 1RB



Date: 7 MAR 2018 09:46:19

Highest Channel / Full RB

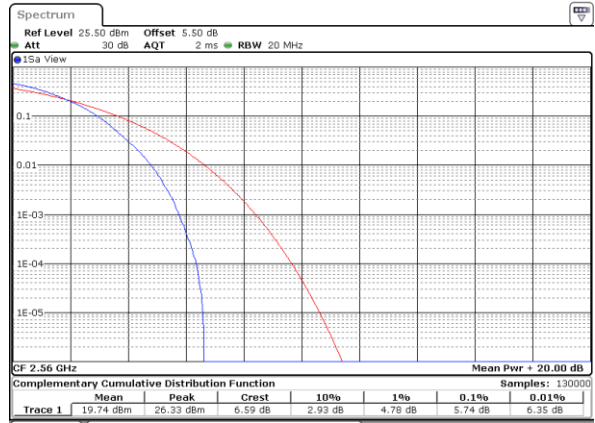

Date: 7 MAR 2018 09:46:28



LTE Band 7 / 20MHz / 64QAM

Lowest Channel / 1RB

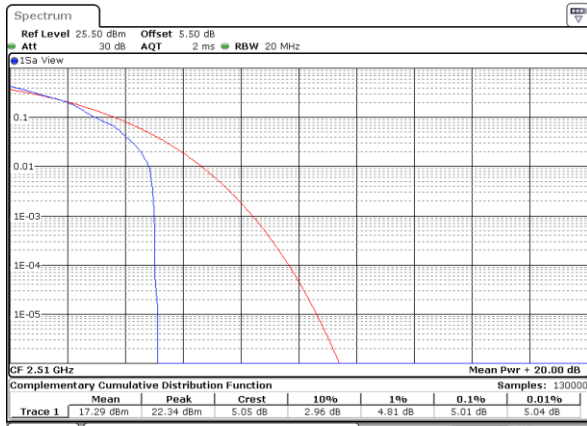

Date: 7 MAR 2016 10:29:49

Lowest Channel / Full RB

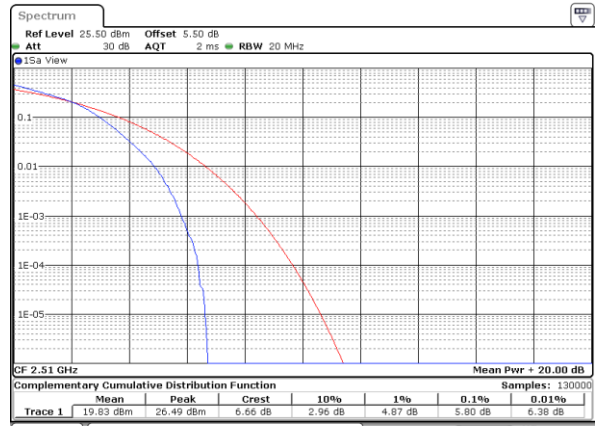

Date: 7 MAR 2016 10:30:53

Middle Channel / 1RB

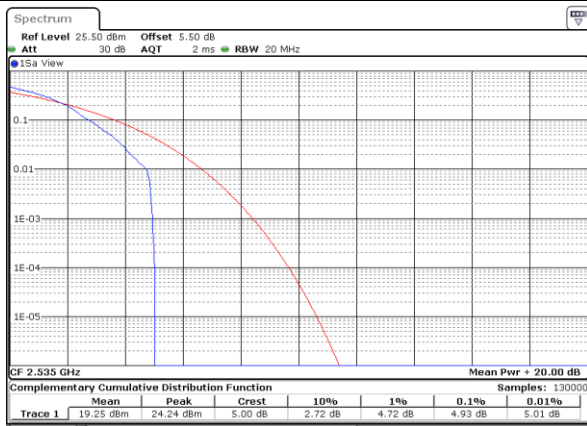

Date: 7 MAR 2016 10:30:01

Middle Channel / Full RB

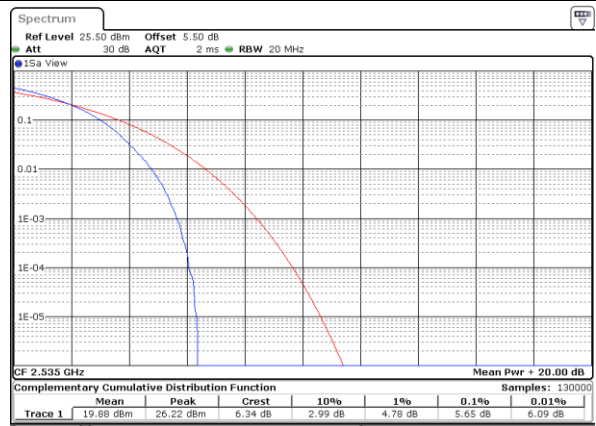

Date: 7 MAR 2016 10:30:38

Highest Channel / 1RB

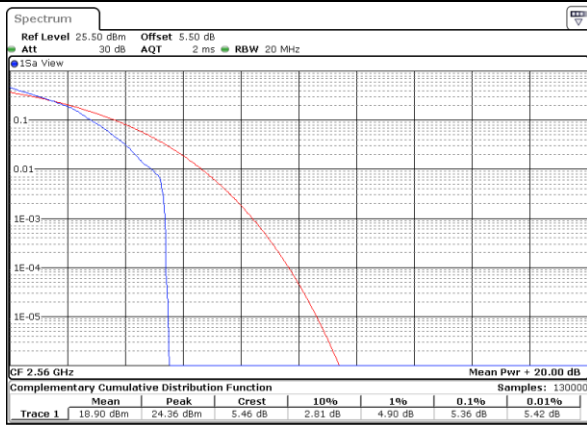

Date: 7 MAR 2016 10:30:14

Highest Channel / Full RB

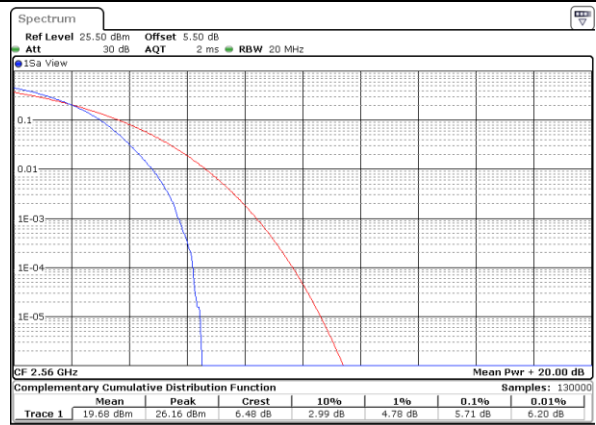

Date: 7 MAR 2016 10:30:27



LTE Band 26 / 15MHz / QPSK

Lowest Channel / 1RB

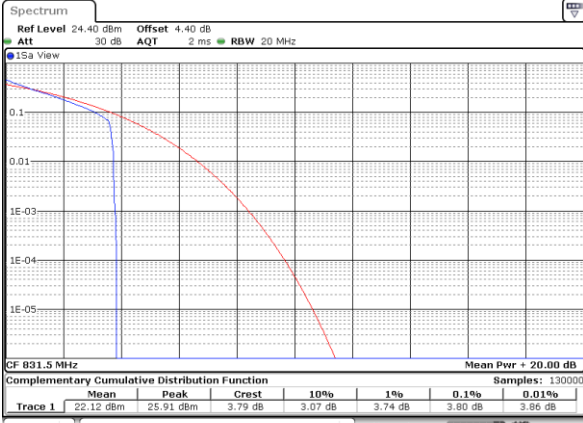

Date: 18 JAN 2018 16:15:01

Lowest Channel / Full RB

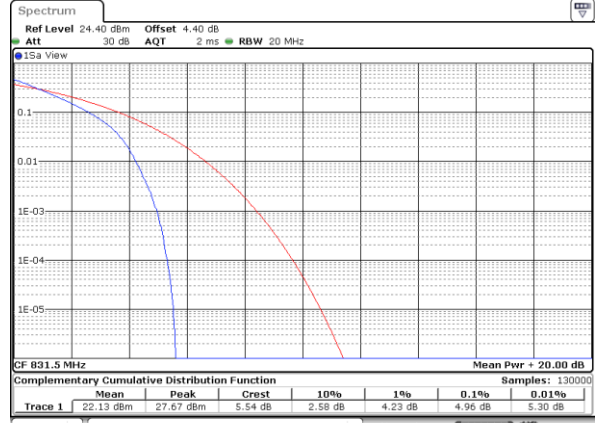

Date: 18 JAN 2018 16:16:22

Middle Channel / 1RB

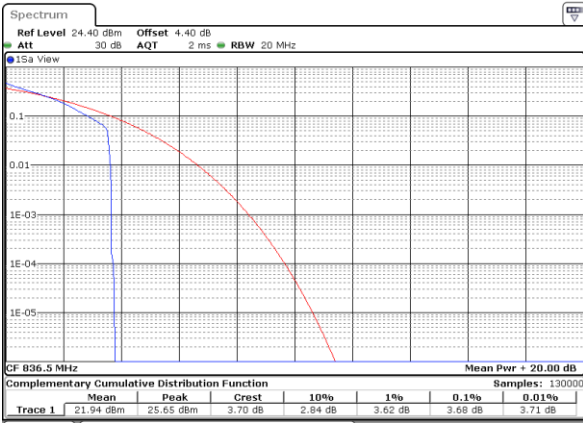

Date: 18 JAN 2018 16:17:37

Middle Channel / Full RB

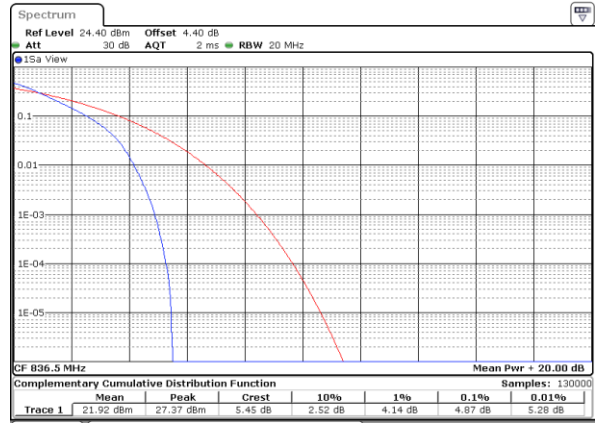

Date: 18 JAN 2018 16:16:35

Highest Channel / 1RB

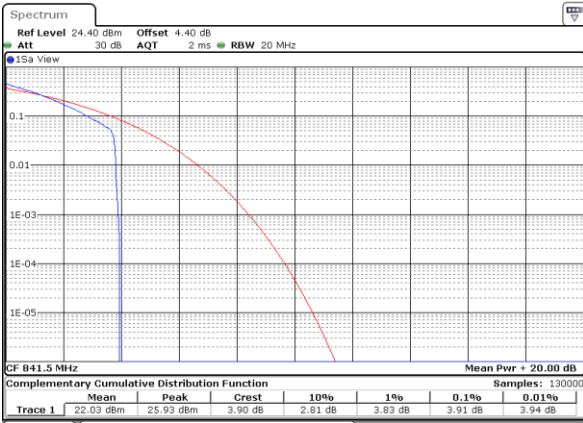

Date: 18 JAN 2018 16:17:50

Highest Channel / Full RB

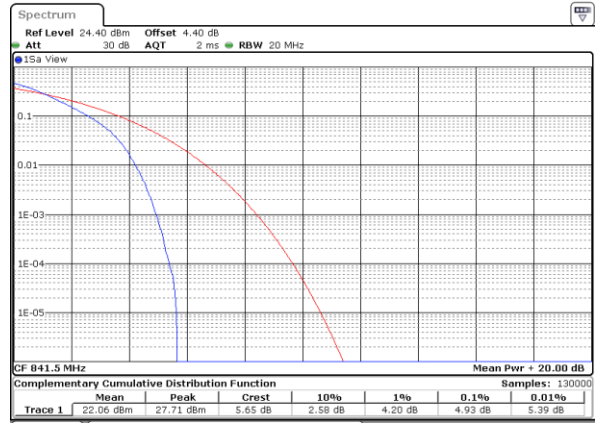

Date: 18 JAN 2018 16:18:56



LTE Band 26 / 15MHz / 16QAM

Lowest Channel / 1RB

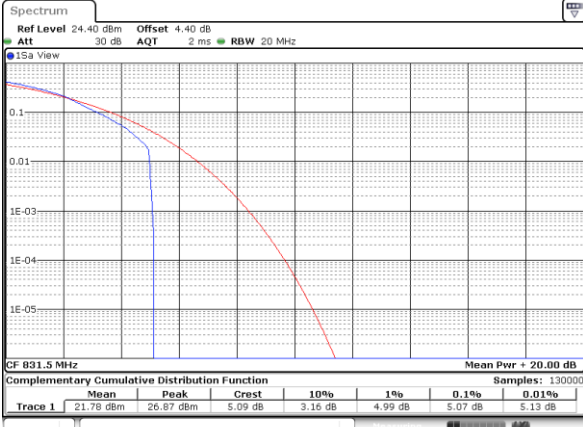

Date: 18 JAN 2018 16:15:14

Lowest Channel / Full RB

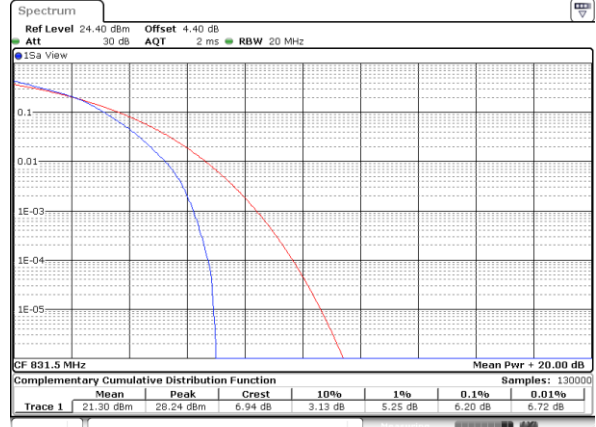

Date: 18 JAN 2018 16:16:10

Middle Channel / 1RB

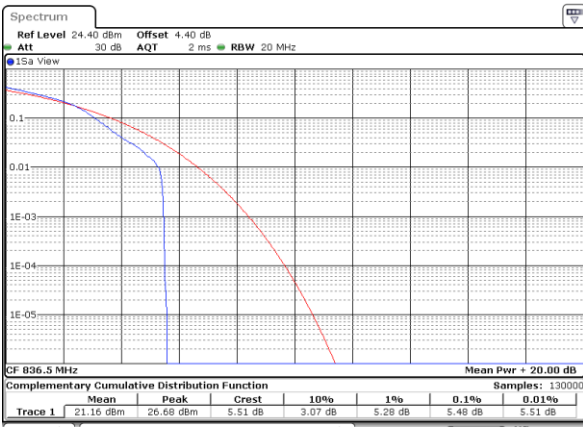

Date: 18 JAN 2018 16:17:25

Middle Channel / Full RB

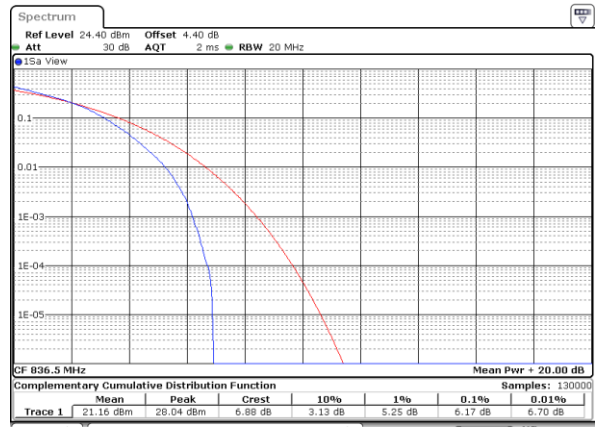

Date: 18 JAN 2018 16:16:47

Highest Channel / 1RB

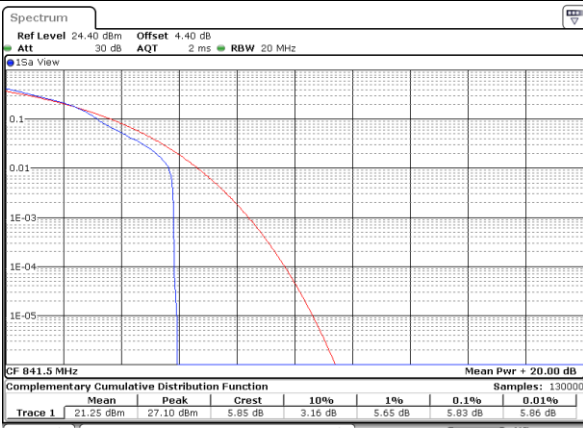

Date: 18 JAN 2018 16:18:03

Highest Channel / Full RB

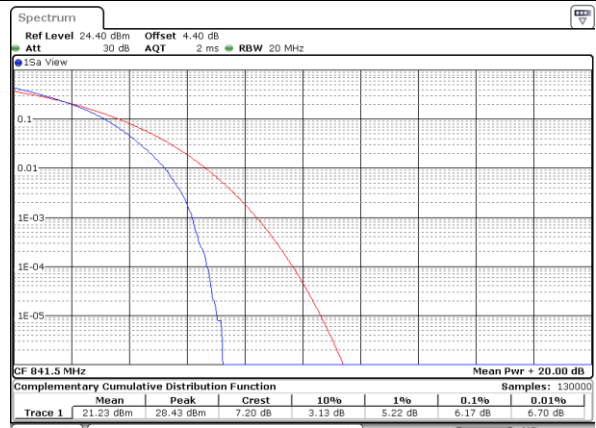

Date: 18 JAN 2018 16:18:43



LTE Band 26 / 15MHz / 64QAM

Lowest Channel / 1RB

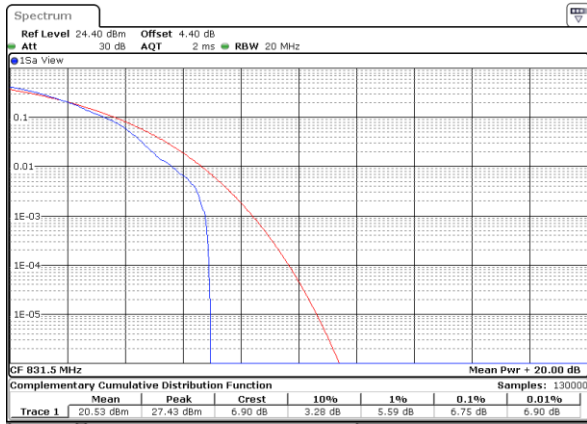

Date: 18 JAN 2018 16:15:42

Lowest Channel / Full RB

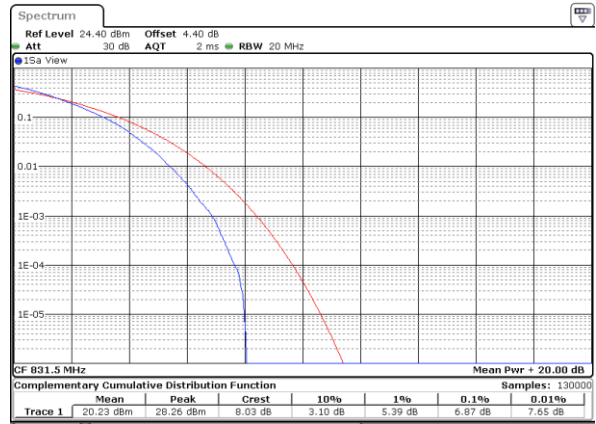

Date: 18 JAN 2018 16:15:57

Middle Channel / 1RB

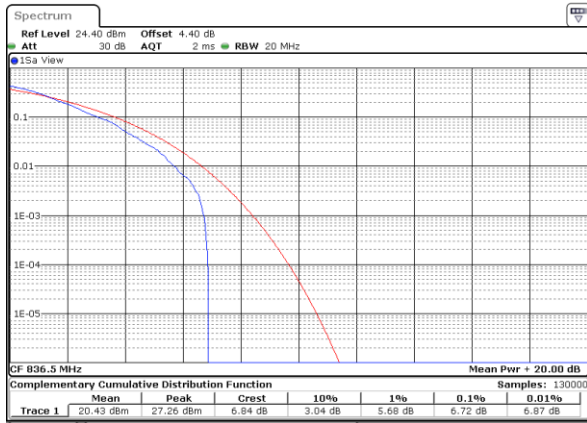

Date: 18 JAN 2018 16:17:14

Middle Channel / Full RB



Date: 18 JAN 2018 16:17:01

Highest Channel / 1RB

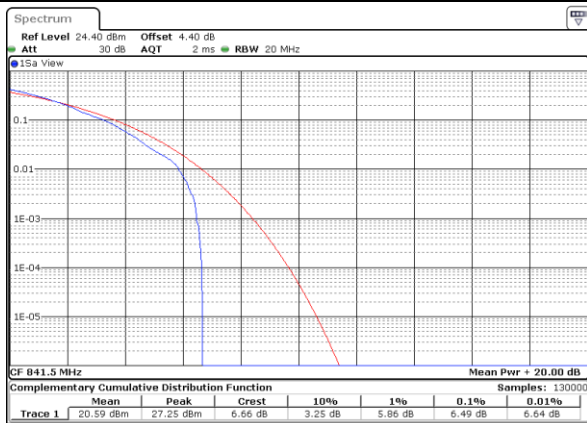

Date: 18 JAN 2018 16:18:17

Highest Channel / Full RB



Date: 18 JAN 2018 16:18:31



LTE Band 38 / 20MHz / QPSK

Lowest Channel / 1RB

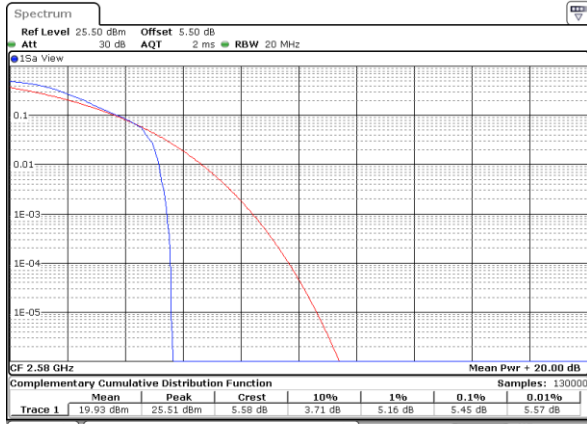

Date: 16 JAN 2018 23:20:39

Lowest Channel / Full RB

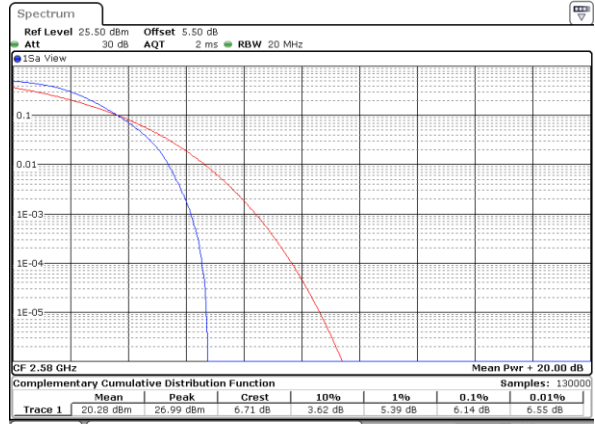

Date: 16 JAN 2018 23:50:44

Middle Channel / 1RB

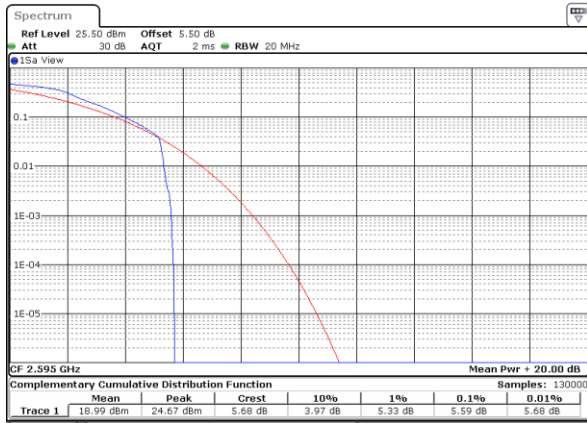

Date: 17 JAN 2018 00:32:01

Middle Channel / Full RB

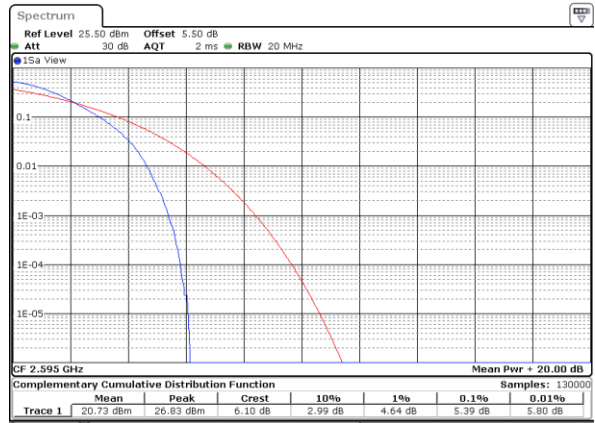

Date: 16 JAN 2018 23:59:23

Highest Channel / 1RB



Date: 17 JAN 2018 00:29:10

Highest Channel / Full RB



Date: 17 JAN 2018 00:23:02



LTE Band 38 / 20MHz / 16QAM

Lowest Channel / 1RB

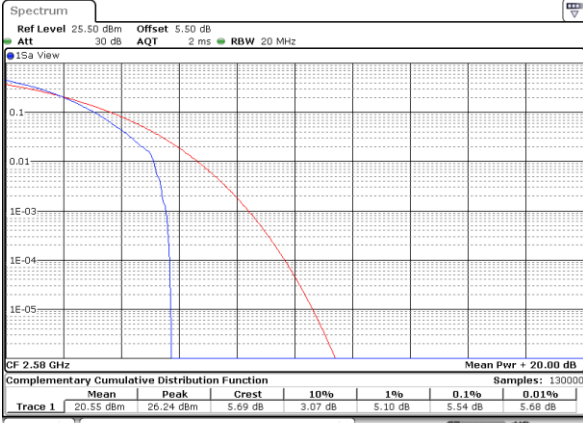

Date: 16 JAN 2018 23:21:38

Lowest Channel / Full RB

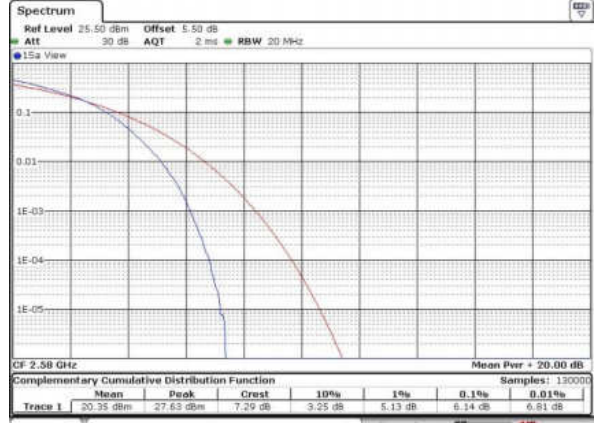

Date: 16 JAN 2018 22:51:28

Middle Channel / 1RB

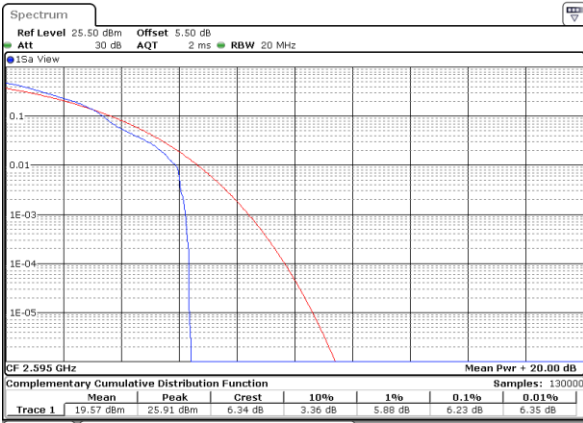

Date: 17 JAN 2018 00:03:25

Middle Channel / Full RB

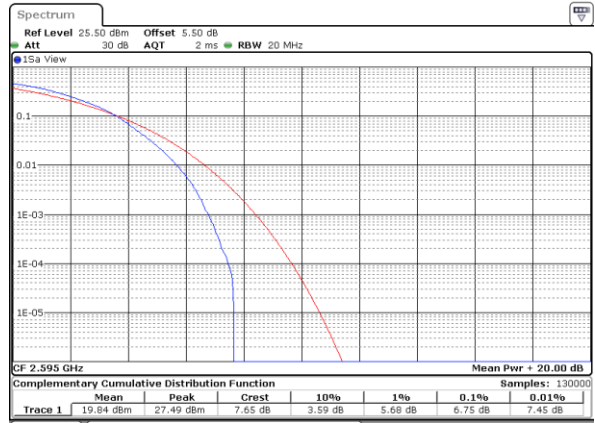

Date: 16 JAN 2018 23:59:37

Highest Channel / 1RB

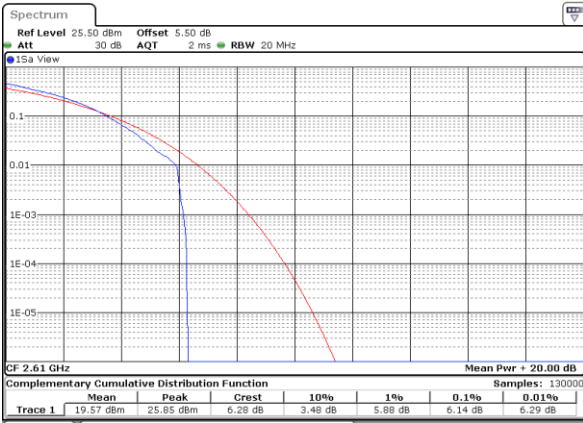

Date: 17 JAN 2018 00:30:02

Highest Channel / Full RB

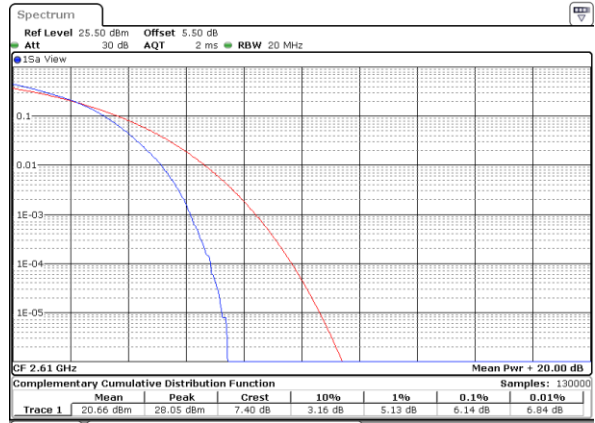

Date: 17 JAN 2018 00:04:01



LTE Band 38 / 20MHz / 64QAM

Lowest Channel / 1RB

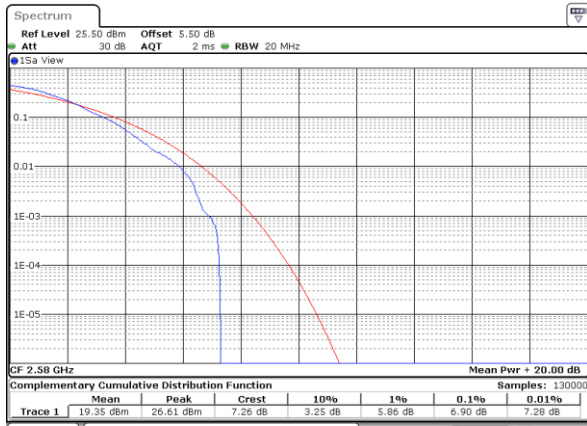

Date: 16 JAN 2018 23:25:36

Lowest Channel / Full RB

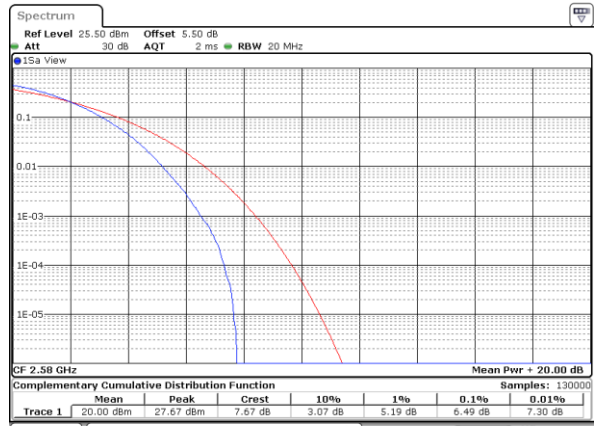

Date: 16 JAN 2018 23:47:20

Middle Channel / 1RB

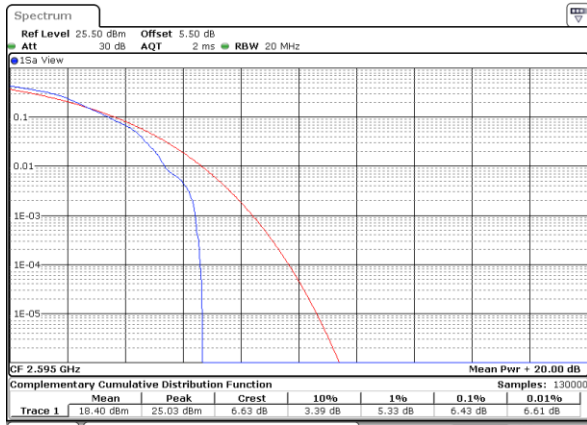

Date: 17 JAN 2018 00:02:13

Middle Channel / Full RB

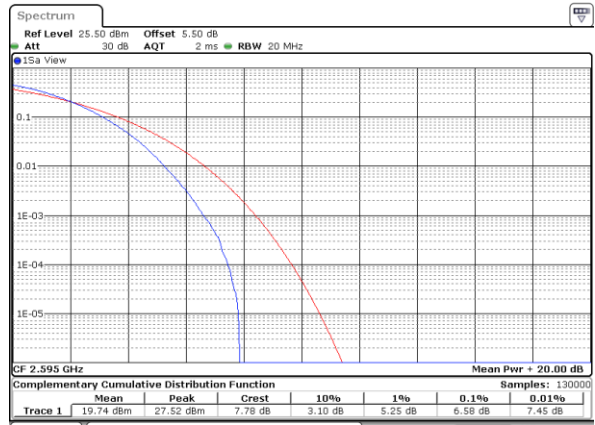

Date: 17 JAN 2018 00:00:34

Highest Channel / 1RB

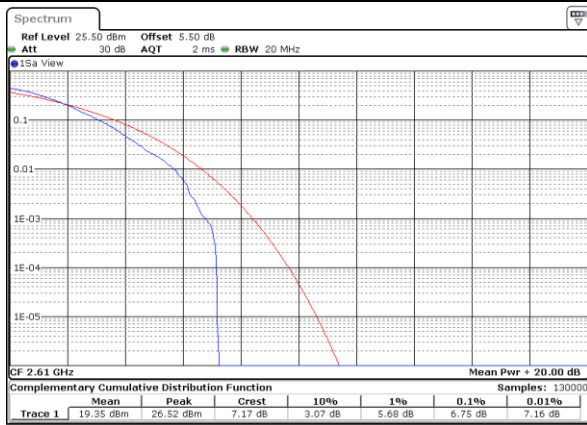

Date: 17 JAN 2018 00:31:16

Highest Channel / Full RB



Date: 17 JAN 2018 00:10:03



26dB Bandwidth

Mode	LTE Band 5 : 26dB BW(MHz)											
	1.4MHz		3MHz		5MHz		10MHz		1.4MHz	3MHz	5MHz	10MHz
Mod.	QPSK	16QAM	QPSK	16QAM	QPSK	16QAM	QPSK	16QAM	64QAM	64QAM	64QAM	64QAM
Lowest CH	1.23	1.22	3.05	3.02	4.87	4.87	9.71	9.79	1.23	3.01	4.88	9.81
Middle CH	1.24	1.22	3.06	3.03	4.93	4.98	9.89	9.93	1.23	3.06	4.88	9.77
Highest CH	1.23	1.24	3.02	2.97	4.90	4.92	9.89	9.65	1.23	3.00	4.92	9.69

Mode	LTE Band 7 : 26dB BW(MHz)											
	5MHz		10MHz		15MHz		20MHz		5MHz	10MHz	15MHz	20MHz
Mod.	QPSK	16QAM	QPSK	16QAM	QPSK	16QAM	QPSK	16QAM	64QAM	64QAM	64QAM	64QAM
Lowest CH	4.98	4.82	9.79	9.85	14.48	14.45	20.26	20.26	4.91	9.85	14.42	20.38
Middle CH	4.95	4.87	9.75	9.83	14.54	14.54	20.10	20.06	4.91	9.83	14.33	20.18
Highest CH	4.95	4.92	9.71	9.77	14.36	14.48	20.18	19.98	4.94	9.77	14.30	20.18

Mode	LTE Band 26 : 26dB BW(MHz)											
	1.4MHz		3MHz		5MHz		10MHz		15MHz		CH26765	
Mod.	QPSK	16QAM	QPSK	16QAM	QPSK	16QAM	QPSK	16QAM	QPSK	16QAM	QPSK	16QAM
Lowest CH	1.22	1.228	3.027	3.009	4.885	4.955	9.69	9.75	14.476	14.116	14.625	14.685
Middle CH	1.222	1.234	2.997	2.979	4.925	4.905	9.89	9.67	14.176	14.505	-	-
Highest CH	1.234	1.228	3.069	2.985	4.815	4.895	9.67	9.83	14.416	14.386	-	-
BW	1.4MHz	3MHz	5MHz	10MHz	15MHz	CH26765						
Mod.	64QAM	64QAM	64QAM	64QAM	64QAM	64QAM						
Lowest CH	1.2112	2.985	4.885	9.71	14.266	14.206						
Middle CH	1.2364	3.021	4.875	9.83	14.146							
Highest CH	1.2056	3.0569	4.845	9.87	14.176							

Mode	LTE Band 38 : 26dB BW(MHz)											
	5MHz		10MHz		15MHz		20MHz		5MHz	10MHz	15MHz	20MHz
Mod.	QPSK	16QAM	QPSK	16QAM	QPSK	16QAM	QPSK	16QAM	64QAM	64QAM	64QAM	64QAM
Lowest CH	4.90	4.78	9.69	9.79	14.54	14.24	20.38	20.22	4.78	9.69	14.30	20.10
Middle CH	4.86	4.94	9.73	9.65	14.39	14.42	20.10	20.10	4.78	9.69	14.39	20.22
Highest CH	4.98	4.93	9.67	9.73	14.51	14.36	20.10	20.06	4.91	9.75	14.33	20.06



LTE Band 5

Lowest Channel / 1.4MHz / QPSK

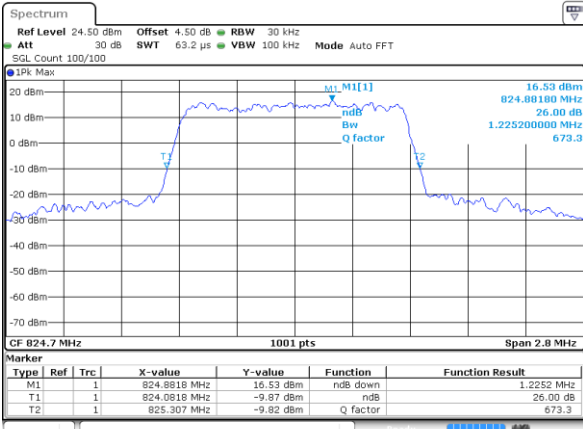

Date: 14 JAN 2018 20:10:16

Lowest Channel / 1.4MHz / 16QAM

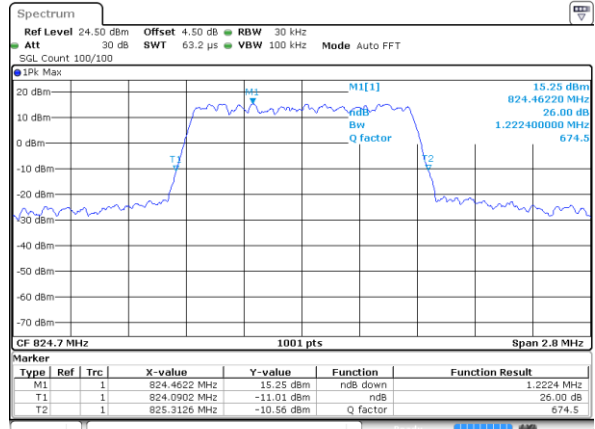

Date: 14 JAN 2018 20:10:06

Middle Channel / 1.4MHz / QPSK

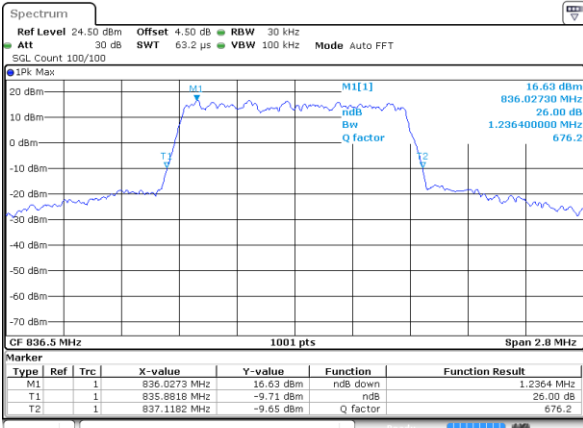

Date: 14 JAN 2018 20:19:04

Middle Channel / 1.4MHz / 16QAM

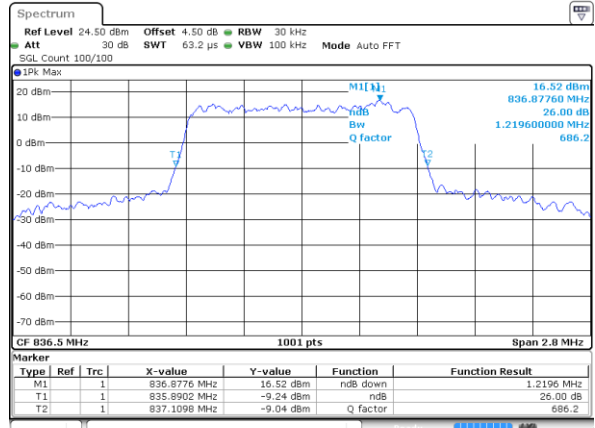

Date: 14 JAN 2018 20:19:14

Highest Channel / 1.4MHz / QPSK

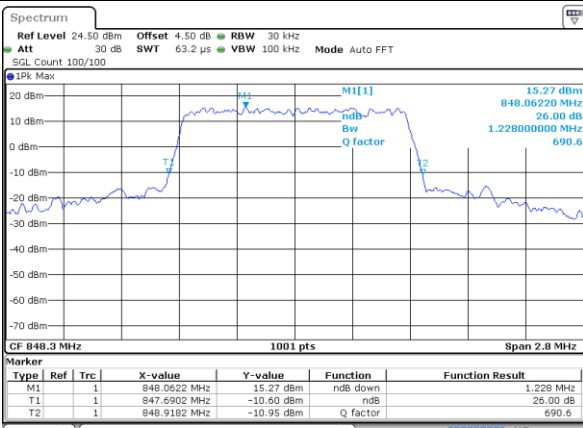

Date: 14 JAN 2018 20:21:33

Highest Channel / 1.4MHz / 16QAM

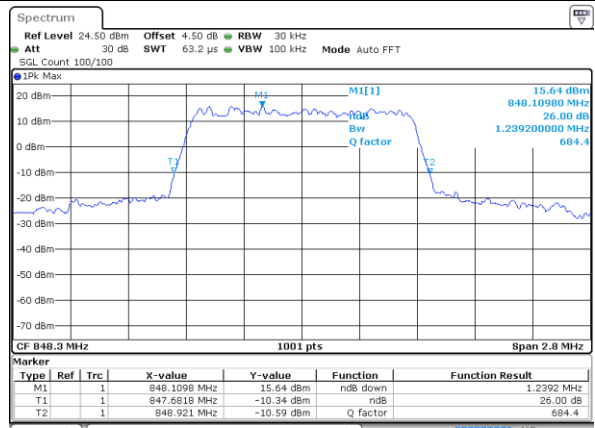

Date: 14 JAN 2018 20:21:43



LTE Band 5

Lowest Channel / 3MHz / QPSK

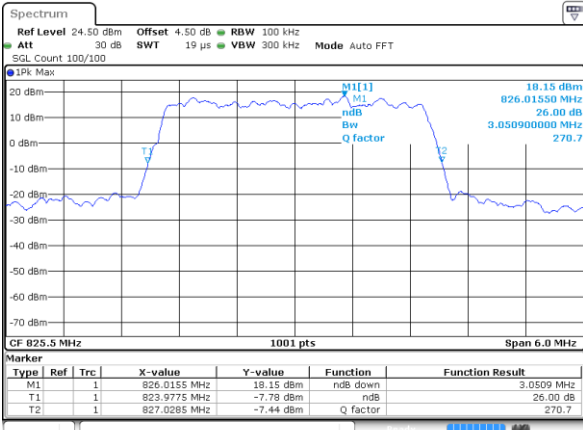

Date: 14 JAN 2018 20:30:31

Lowest Channel / 3MHz / 16QAM

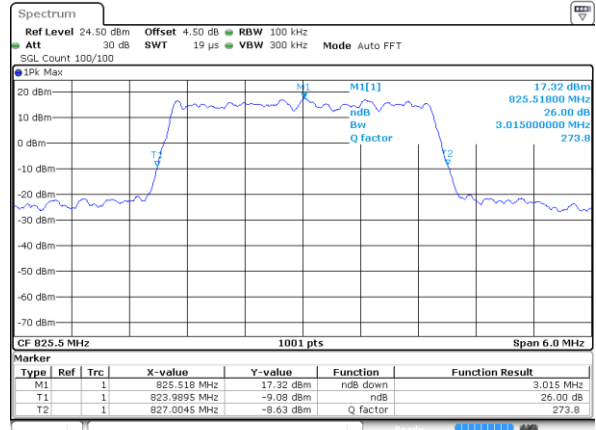

Date: 14 JAN 2018 20:30:41

Middle Channel / 3MHz / QPSK

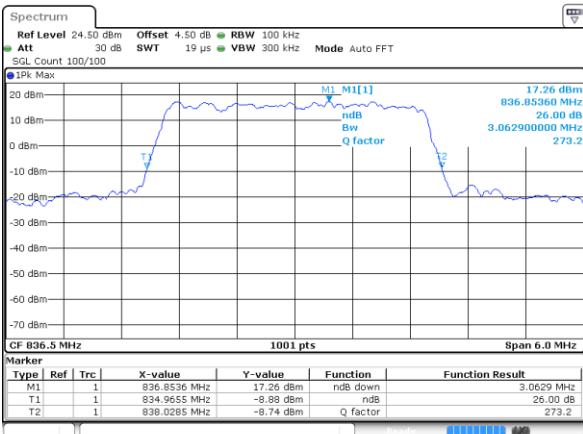

Date: 14 JAN 2018 20:39:30

Middle Channel / 3MHz / 16QAM

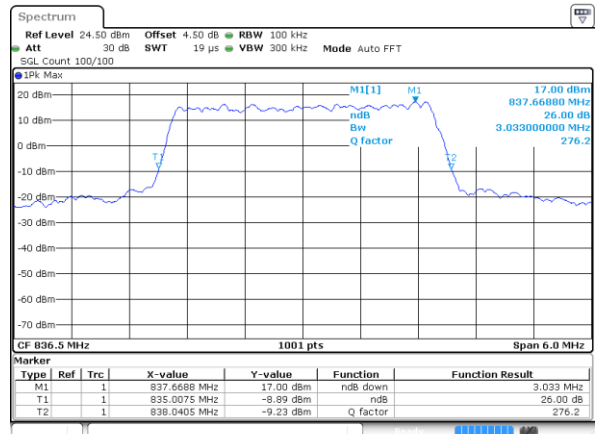

Date: 14 JAN 2018 20:39:40

Highest Channel / 3MHz / QPSK

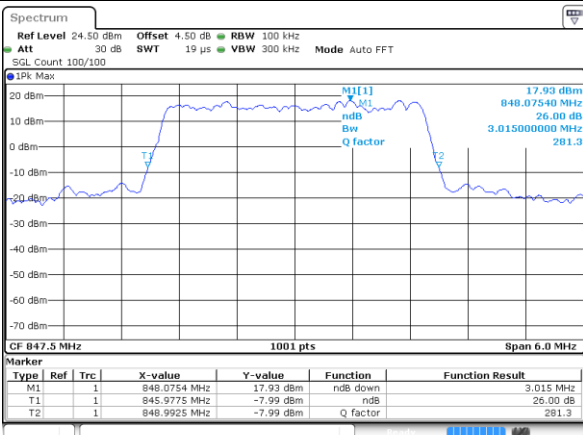

Date: 14 JAN 2018 20:41:58

Highest Channel / 3MHz / 16QAM

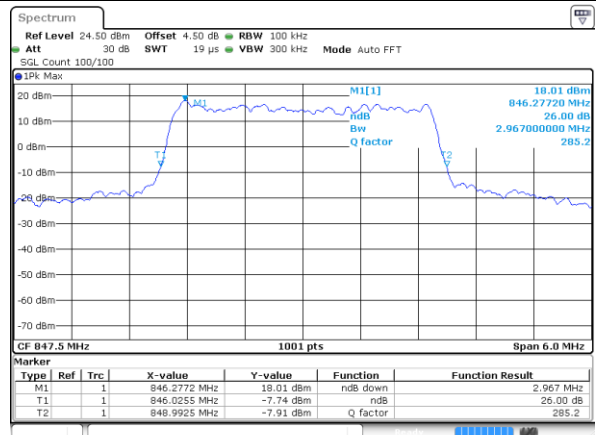

Date: 14 JAN 2018 20:42:08