

# FCC SAR Test Report

APPLICANT : Motorola Mobility LLC  
EQUIPMENT : Mobile Cellular Phone  
BRAND NAME : Motorola  
MODEL NAME : 10012  
FCC ID : IHDT56WH1  
STANDARD : FCC 47 CFR Part 2 (2.1093)  
ANSI/IEEE C95.1-1992  
IEEE 1528-2013

We, Sporton International (KunShan) INC., would like to declare that the tested sample has been evaluated in accordance with the procedures and had been in compliance with the applicable technical standards.

The test results in this report apply exclusively to the tested model / sample. Without written approval of Sporton International (KunShan) INC., the test report shall not be reproduced except in full.



---

Prepared by: Mark Qu / Manager



---

Approved by: Jones Tsai / Manager

**Sporton International (KunShan) INC.**  
**No.3-2, Pingxiang Road, Kunshan Development Zone, Jiangsu, China**



Table of Contents

1. Statement of Compliance ..... 4
2. Administration Data ..... 5
3. Guidance Applied..... 5
4. Equipment Under Test (EUT) Information ..... 6
4.1 General Information ..... 6
4.2 Specification of Accessory ..... 7
4.3 General LTE SAR Test and Reporting Considerations ..... 8
5. RF Exposure Limits.....11
5.1 Uncontrolled Environment ..... 11
5.2 Controlled Environment..... 11
6. Specific Absorption Rate (SAR) .....12
6.1 Introduction ..... 12
6.2 SAR Definition..... 12
7. System Description and Setup .....13
7.1 E-Field Probe ..... 14
7.2 Data Acquisition Electronics (DAE) ..... 14
7.3 Phantom..... 15
7.4 Device Holder..... 16
8. Measurement Procedures .....17
8.1 Spatial Peak SAR Evaluation ..... 17
8.2 Power Reference Measurement..... 18
8.3 Area Scan ..... 18
8.4 Zoom Scan..... 19
8.5 Volume Scan Procedures ..... 19
8.6 Power Drift Monitoring..... 19
9. Test Equipment List .....20
10. System Verification .....21
10.1 Tissue Simulating Liquids ..... 21
10.2 Tissue Verification ..... 22
10.3 System Performance Check Results ..... 23
11. RF Exposure Positions .....24
11.1 Ear and handset reference point ..... 24
11.2 Definition of the cheek position..... 25
11.3 Definition of the tilt position..... 26
11.4 Body Worn Accessory ..... 27
11.5 Product Specific 10g SAR Exposure ..... 27
11.6 Wireless Router..... 28
12. Conducted RF Output Power (Unit: dBm).....29
13. Bluetooth Exclusions Applied .....92
14. Antenna Location .....93
15. SAR Test Results .....94
15.1 Head SAR ..... 97
15.2 Hotspot SAR ..... 101
15.3 Body Worn Accessory SAR ..... 106
15.4 Product specific 10g SAR ..... 109
15.5 Repeated SAR Measurement ..... 111
16. Simultaneous Transmission Analysis .....112
16.1 Head Exposure Conditions ..... 113
16.2 Hotspot Exposure Conditions..... 115
16.3 Body-Worn Accessory Exposure Conditions ..... 117
16.4 Product Specific 10g SAR Exposure Conditions ..... 118
17. Uncertainty Assessment .....119
18. References .....122
Appendix A. Plots of System Performance Check
Appendix B. Plots of High SAR Measurement
Appendix C. DASy Calibration Certificate
Appendix D. Test Setup Photos



### Revision History

REPORT NO.	VERSION	DESCRIPTION	ISSUED DATE
FA760212	Rev. 01	Initial issue of report	Jul. 12, 2017



### 1. Statement of Compliance

The maximum results of Specific Absorption Rate (SAR) found during testing for **Motorola Mobility LLC, Mobile Cellular Phone, 10012**, are as follows.

**<1g SAR>**

Equipment Class	Frequency Band		Highest SAR Summary			Highest Simultaneous Transmission 1g SAR (W/kg)
			Head (Separation 0mm)	Hotspot (Separation 10mm)	Body-worn (Separation 10mm)	
			1g SAR (W/kg)			
Licensed	GSM	GSM850	0.13	0.32	0.30	1.50
		GSM1900	<0.10	1.15	0.98	
	WCDMA	Band V	0.16	0.61	0.33	
		Band IV	0.36	0.98	0.80	
		Band II	0.25	1.00	0.77	
	CDMA2000	BC10	0.22	0.45	0.36	
		BC0	0.31	0.57	0.37	
		BC1	0.32	0.98	0.80	
	LTE	Band 12/Band 17	0.14	0.29	0.29	
		Band 13	0.23	0.39	0.34	
		Band 26/Band 5	0.21	0.42	0.31	
		Band 66/Band 4	0.34	0.64	0.64	
		Band 25/Band 2	0.19	0.90	0.77	
Band 7		0.42	<b>1.17</b>	<b>0.99</b>		
DTS	WLAN	2.4GHz WLAN	0.36	<0.10	<0.10	1.17
NII		5GHz WLAN	<b>1.08</b>	0.10	0.13	1.50
Date of Testing:			2017.6.10 ~ 2017.7.9			

**<10g SAR>**

Equipment Class	Frequency Band		Highest SAR Summary	Highest Simultaneous Transmission 10g SAR (W/kg)
			Product Specific 10g SAR (W/kg) (Separation 0mm)	
Licensed	WCDMA	Band IV	2.97	3.90
		Band II	<b>3.41</b>	
	CDMA2000	BC1	3.20	
	LTE	Band 66/Band 4	3.31	
		Band 25/Band 2	3.27	
NII	WLAN	5GHz WLAN	1.11	3.90

This device is in compliance with Specific Absorption Rate (SAR) for general population/uncontrolled exposure limits (1.6W/kg as averaged over any 1 gram of tissue; 10-gram SAR for Product Specific 10g SAR, limit: 4.0W/kg) specified in FCC 47 CFR part 2 (2.1093) and ANSI/IEEE C95.1-1992, and had been tested in accordance with the measurement methods and procedures specified in IEEE 1528-2013 and FCC KDB publications.



## **2. Administration Data**

<b>Testing Laboratory</b>	
<b>Test Site</b>	Sporton International (KunShan) INC.
<b>Test Site Location</b>	No.3-2, Pingxiang Road, Kunshan Development Zone, Jiangsu, China TEL: 86-0512-5790-0158 FAX: 86-0512-5790-0958

<b>Applicant</b>	
<b>Company Name</b>	Motorola Mobility LLC
<b>Address</b>	222 W, Merchandise Mart Plaza, Chicago IL 60654 USA

<b>Manufacturer</b>	
<b>Company Name</b>	Motorola Mobility LLC
<b>Address</b>	222 W, Merchandise Mart Plaza, Chicago IL 60654 USA

## **3. Guidance Applied**

The Specific Absorption Rate (SAR) testing specification, method, and procedure for this device is in accordance with the following standards:

- FCC 47 CFR Part 2 (2.1093)
- ANSI/IEEE C95.1-1992
- IEEE 1528-2013
- FCC KDB 865664 D01 SAR Measurement 100 MHz to 6 GHz v01r04
- FCC KDB 865664 D02 SAR Reporting v01r02
- FCC KDB 447498 D01 General RF Exposure Guidance v06
- FCC KDB 648474 D04 SAR Evaluation Considerations for Wireless Handsets v01r03
- FCC KDB 248227 D01 802.11 Wi-Fi SAR v02r02
- FCC KDB 941225 D01 3G SAR Procedures v03r01
- FCC KDB 941225 D05 SAR for LTE Devices v02r05
- FCC KDB 941225 D05A Rel.10 LTE SAR Test Guidance v01r02
- FCC KDB 941225 D06 Hotspot Mode SAR v02r01



### 4. Equipment Under Test (EUT) Information

#### 4.1 General Information

Product Feature & Specification	
Equipment Name	Mobile Cellular Phone
Brand Name	Motorola
Model Name	10012
FCC ID	IHDT56WH1
IMEI Code	WWAN SAR Test Sample: 355666080014433 WLAN SAR Test Sample: 355666080017444
Wireless Technology and Frequency Range	GSM850: 824.2 MHz ~ 848.8 MHz GSM1900: 1850.2 MHz ~ 1909.8 MHz WCDMA Band II: 1852.4 MHz ~ 1907.6 MHz WCDMA Band IV: 1712.4 MHz ~ 1752.6 MHz WCDMA Band V: 826.4 MHz ~ 846.6 MHz CDMA2000 BC0: 824.7 MHz ~ 848.31 MHz CDMA 2000 BC1: 1851.25 MHz ~ 1908.75 MHz CDMA 2000 BC10: 817.9 MHz ~ 823.1 MHz LTE Band 2: 1850.7 MHz ~ 1909.3 MHz LTE Band 4: 1710.7 MHz ~ 1754.3 MHz LTE Band 5: 824.7 MHz ~ 848.3 MHz LTE Band 7: 2502.5 MHz ~ 2567.5 MHz LTE Band 12: 699.7 MHz ~ 715.3 MHz LTE Band 13: 779.5 MHz ~ 784.5 MHz LTE Band 17: 706.5 MHz ~ 713.5 MHz LTE Band 25: 1850.7 MHz ~ 1914.3 MHz LTE Band 26: 814.7 MHz ~ 848.3 MHz LTE Band 38: 2572.5 MHz ~ 2617.5 MHz LTE Band 41: 2498.5 MHz ~ 2687.5 MHz LTE Band 66: 1710.7 MHz ~ 1779.3 MHz WLAN 2.4GHz Band: 2412 MHz ~ 2462 MHz WLAN 5.2GHz Band: 5180 MHz ~ 5240 MHz WLAN 5.3GHz Band: 5260 MHz ~ 5320 MHz WLAN 5.5GHz Band: 5500 MHz ~ 5700 MHz WLAN 5.8GHz Band: 5745 MHz ~ 5825 MHz Bluetooth: 2402 MHz ~ 2480 MHz
Mode	GSM/GPRS/EGPRS RMC/AMR 12.2Kbps HSDPA HSUPA DC-HSDPA HSPA+ (16QAM uplink is not supported) CDMA2000 : 1xRTT/1xEv-Do(Rev.0)/1xEv-Do(Rev.A) LTE: QPSK, 16QAM 802.11b/g/n HT20 802.11a/n HT20/HT40 Bluetooth v3.0 + EDR, Bluetooth v4.0 LE, Bluetooth v4.1 LE Bluetooth v4.2 LE
HW Version	NA DVT2
SW Version	sanders_oem_userdebug_7.1.1_NPS26.116-26_47_intcfg-test-keys_oem
GSM / (E)GPRS Transfer mode	Class B – EUT cannot support Packet Switched and Circuit Switched Network simultaneously but can automatically switch between Packet and Circuit Switched Network.
EUT Stage	Identical Prototype
<b>Remark:</b> 1. WLAN operation in 5600 MHz ~ 5650 MHz is notched. 2. 802.11n-HT40 is not supported in 2.4GHz WLAN. 3. This device supports VoIP in GPRS, EGPRS, CDMA, WCDMA and LTE (e.g. for 3rd-party VoIP), LTE supports VoLTE operation. 4. This device 2.4GHz WLAN/5.2GHz WLAN/5.8GHz WLAN support hotspot operation, and 5.2GHz WLAN/5.8GHz WLAN supports WiFi Direct (GC/GO), and 5.3GHz / 5.5GHz supports WiFi Direct (GC only). 5. This device does not support DTM operation and supports GRPS/EGPRS mode up to multi-slot class 12.	

6. There are totally three power levels of WWAN Bands. Power level 1 is for full power, power level 2 is for P-sensor on and hotspot on and power level 3 is for default power, detail descriptions of the power levels are as below:
- 1) Power level 1 - When the phone is in talking mode and receiver worked, all WWAN bands are full powers.
  - 2) Power level 2 – This device hotspot reduced power and P-sensor reduced power level are the same. So only show one reduced power level for hotspot reduced power and P-sensor reduced power for this application.
    - a) The device employs proximity sensors that detect the presence of the user’s body at the front or back faces of the device. When front or back of body worn condition is detected, WCDMA band II/IV, CDMA2000 BC1 and LTE band 2/4/25/66 reduced power will be active. (P-sensor can’t work at detecting presence of the user’s body at the four edges of the device.)
    - b) When hotspot mode is enabled, power reduction will be activated to limit the maximum power of WCDMA band II/IV, CDMA2000 BC1 and LTE band 2/4/25/66.
    - c) The power level of other WWAN bands is same as the power level 1.
  - 3) Power level 3 – Default power of WCDMA Band II/IV and LTE band 4/66, other WWAN bands default power is same as the power level 1.

**4.2 Specification of Accessory**

Specification of Accessory				
AC Adapter 1	Brand Name	Motorola(Salom)	Model Name	SC-22
	Power Rating	I/P: 100-240Vac, 500mA, O/P: 5Vdc or 9Vdc or 12Vdc, 3000mA or 1600mA or 1200mA		
AC Adapter 2	Brand Name	Motorola(chenyang)	Model Name	SC-22
	Power Rating	I/P: 100-240Vac, 500mA, O/P: 5Vdc or 9Vdc or 12Vdc, 3000mA or 1600mA or 1200mA		
AC Adapter 3	Brand Name	Motorola(LiteOn)	Model Name	SC-22
	Power Rating	I/P: 100-240Vac, 500mA, O/P: 5Vdc or 9Vdc or 12Vdc, 3000mA or 1600mA or 1200mA		
Battery	Brand Name	Motorola (ATL)	Model Name	HG30
	Power Rating	3.8Vdc,3000mAh	Type	Li-ion, Polymer
Earphone 1	Brand Name	Motorola(JuWei)	Model Name	JWEP0998-W09R
	Signal Line Type	1.2 meter, non-shielded cable, without ferrite core		
Earphone 2	Brand Name	Motorola( Newleader)	Model Name	NLD-EM307K-02SF
	Signal Line Type	1.2 meter, non-shielded cable, without ferrite core		
USB Cable	Brand Name	Motorola(Saibao)	Model Name	SWT-A075A
	Signal Line Type	1.0meter, shielded cable, without core		



4.3 General LTE SAR Test and Reporting Considerations

Summarized necessary items addressed in KDB 941225 D05 v02r05																																							
FCC ID	IHDT56WH1																																						
Equipment Name	Mobile Cellular Phone																																						
Operating Frequency Range of each LTE transmission band	LTE Band 2: 1850.7 MHz ~ 1909.3 MHz LTE Band 4: 1710.7 MHz ~ 1754.3 MHz LTE Band 5: 824.7 MHz ~ 848.3 MHz LTE Band 7: 2502.5 MHz ~ 2567.5 MHz LTE Band 12: 699.7 MHz ~ 715.3 MHz LTE Band 13: 779.5 MHz ~ 784.5 MHz LTE Band 17: 706.5 MHz ~ 713.5 MHz LTE Band 25: 1850.7 MHz ~ 1914.3 MHz LTE Band 26: 814.7 MHz ~ 848.3 MHz LTE Band 38: 2572.5 MHz ~ 2617.5 MHz LTE Band 41: 2498.5 MHz ~ 2687.5 MHz LTE Band 66: 1710.7 MHz ~ 1779.3 MHz																																						
Channel Bandwidth	LTE Band 2: 1.4MHz, 3MHz, 5MHz, 10MHz, 15MHz, 20MHz LTE Band 4: 1.4MHz, 3MHz, 5MHz, 10MHz, 15MHz, 20MHz LTE Band 5: 1.4MHz, 3MHz, 5MHz, 10MHz LTE Band 7: 5MHz, 10MHz, 15MHz, 20MHz LTE Band 12: 1.4MHz, 3MHz, 5MHz, 10MHz LTE Band 13: 5MHz, 10MHz LTE Band 17: 5MHz, 10MHz LTE Band 25: 1.4MHz, 3MHz, 5MHz, 10MHz, 15MHz, 20MHz LTE Band 26: 1.4MHz, 3MHz, 5MHz, 10MHz, 15MHz LTE Band 38: 5MHz, 10MHz, 15MHz, 20MHz LTE Band 41: 5MHz, 10MHz, 15MHz, 20MHz LTE Band 66: 1.4MHz, 3MHz, 5MHz, 10MHz, 15MHz, 20MHz																																						
uplink modulations used	QPSK, and 16QAM																																						
LTE Voice / Data requirements	Voice and Data																																						
LTE Release Version	R10, Cat 6																																						
CA Support	Yes, Downlink Only																																						
LTE MPR permanently built-in by design	<table border="1"> <caption>Table 6.2.3-1: Maximum Power Reduction (MPR) for Power Class 3</caption> <thead> <tr> <th rowspan="2">Modulation</th> <th colspan="6">Channel bandwidth / Transmission bandwidth (RB)</th> <th rowspan="2">MPR (dB)</th> </tr> <tr> <th>1.4 MHz</th> <th>3.0 MHz</th> <th>5 MHz</th> <th>10 MHz</th> <th>15 MHz</th> <th>20 MHz</th> </tr> </thead> <tbody> <tr> <td>QPSK</td> <td>&gt; 5</td> <td>&gt; 4</td> <td>&gt; 8</td> <td>&gt; 12</td> <td>&gt; 16</td> <td>&gt; 18</td> <td>≤ 1</td> </tr> <tr> <td>16 QAM</td> <td>≤ 5</td> <td>≤ 4</td> <td>≤ 8</td> <td>≤ 12</td> <td>≤ 16</td> <td>≤ 18</td> <td>≤ 1</td> </tr> <tr> <td>16 QAM</td> <td>&gt; 5</td> <td>&gt; 4</td> <td>&gt; 8</td> <td>&gt; 12</td> <td>&gt; 16</td> <td>&gt; 18</td> <td>≤ 2</td> </tr> </tbody> </table>	Modulation	Channel bandwidth / Transmission bandwidth (RB)						MPR (dB)	1.4 MHz	3.0 MHz	5 MHz	10 MHz	15 MHz	20 MHz	QPSK	> 5	> 4	> 8	> 12	> 16	> 18	≤ 1	16 QAM	≤ 5	≤ 4	≤ 8	≤ 12	≤ 16	≤ 18	≤ 1	16 QAM	> 5	> 4	> 8	> 12	> 16	> 18	≤ 2
Modulation	Channel bandwidth / Transmission bandwidth (RB)						MPR (dB)																																
	1.4 MHz	3.0 MHz	5 MHz	10 MHz	15 MHz	20 MHz																																	
QPSK	> 5	> 4	> 8	> 12	> 16	> 18	≤ 1																																
16 QAM	≤ 5	≤ 4	≤ 8	≤ 12	≤ 16	≤ 18	≤ 1																																
16 QAM	> 5	> 4	> 8	> 12	> 16	> 18	≤ 2																																
LTE A-MPR	In the base station simulator configuration, Network Setting value is set to NS_01 to disable A-MPR during SAR testing and the LTE SAR tests was transmitting on all TTI frames (Maximum TTI)																																						
Spectrum plots for RB configuration	A properly configured base station simulator was used for the SAR and power measurement; therefore, spectrum plots for each RB allocation and offset configuration are not included in the SAR report.																																						
Power reduction applied to satisfy SAR compliance	Yes, 1. The device employs proximity sensors that detect the presence of the user's body at the front or back faces of the device. When front or back body worn condition is detected, WCDMA band IV/II, CDMA2000 BC1 and LTE band 2/4/25/66 reduced power will be active. (P-sensor can't work at detecting presence of the user's body at the four edges of the device.) 2. When hotspot mode is enabled, power reduction will be activated to limit the maximum power of WCDMA band IV/II, CDMA2000 BC1 and LTE band 2/4/25/66.																																						
LTE Carrier Aggregation Combinations	Inter-Band and Intra-Band possible combinations and the detail power verification please referred to section 12.																																						
LTE Carrier Aggregation Additional Information	This device does not support full CA features on 3GPP Release 10. It supports a maximum of 2 carriers in the downlink only. All uplink communications are identical to the Release 8 Specifications. Uplink communications are done on the PCC. Due to carrier capability, only the combinations listed above are supported. The following LTE Release features are not supported: Relay, HetNet, Enhanced MIMO, eICI, WiFi Offloading, MDH, eMBMA, Cross-Carrier Scheduling, Enhanced SC-FDMA.																																						



Transmission (H, M, L) channel numbers and frequencies in each LTE band												
LTE Band 2												
	Bandwidth 1.4 MHz		Bandwidth 3 MHz		Bandwidth 5 MHz		Bandwidth 10 MHz		Bandwidth 15 MHz		Bandwidth 20 MHz	
	Ch. #	Freq. (MHz)	Ch. #	Freq. (MHz)	Ch. #	Freq. (MHz)	Ch. #	Freq. (MHz)	Ch. #	Freq. (MHz)	Ch. #	Freq. (MHz)
L	18607	1850.7	18615	1851.5	18625	1852.5	18650	1855	18675	1857.5	18700	1860
M	18900	1880	18900	1880	18900	1880	18900	1880	18900	1880	18900	1880
H	19193	1909.3	19185	1908.5	19175	1907.5	19150	1905	19125	1902.5	19100	1900
LTE Band 4												
	Bandwidth 1.4 MHz		Bandwidth 3 MHz		Bandwidth 5 MHz		Bandwidth 10 MHz		Bandwidth 15 MHz		Bandwidth 20 MHz	
	Ch. #	Freq. (MHz)	Ch. #	Freq. (MHz)	Ch. #	Freq. (MHz)	Ch. #	Freq. (MHz)	Ch. #	Freq. (MHz)	Ch. #	Freq. (MHz)
L	19957	1710.7	19965	1711.5	19975	1712.5	20000	1715	20025	1717.5	20050	1720
M	20175	1732.5	20175	1732.5	20175	1732.5	20175	1732.5	20175	1732.5	20175	1732.5
H	20393	1754.3	20385	1753.5	20375	1752.5	20350	1750	20325	1747.5	20300	1745
LTE Band 5												
	Bandwidth 1.4 MHz		Bandwidth 3 MHz		Bandwidth 5 MHz		Bandwidth 10 MHz					
	Ch. #	Freq. (MHz)	Ch. #	Freq. (MHz)	Ch. #	Freq. (MHz)	Ch. #	Freq. (MHz)	Ch. #	Freq. (MHz)	Ch. #	Freq. (MHz)
L	20407	824.7	20415	825.5	20425	826.5	20450	829				
M	20525	836.5	20525	836.5	20525	836.5	20525	836.5				
H	20643	848.3	20635	847.5	20625	846.5	20600	844				
LTE Band 7												
	Bandwidth 5 MHz		Bandwidth 10 MHz		Bandwidth 15 MHz		Bandwidth 20 MHz					
	Ch. #	Freq. (MHz)	Ch. #	Freq. (MHz)	Ch. #	Freq. (MHz)	Ch. #	Freq. (MHz)	Ch. #	Freq. (MHz)	Ch. #	Freq. (MHz)
L	20775	2502.5	20800	2505	20825	2507.5	20850	2510				
M	21100	2535	21100	2535	21100	2535	21100	2535				
H	21425	2567.5	21400	2565	21375	2562.5	21350	2560				
LTE Band 12												
	Bandwidth 1.4 MHz		Bandwidth 3 MHz		Bandwidth 5 MHz		Bandwidth 10 MHz					
	Ch. #	Freq. (MHz)	Ch. #	Freq. (MHz)	Ch. #	Freq. (MHz)	Ch. #	Freq. (MHz)	Ch. #	Freq. (MHz)	Ch. #	Freq. (MHz)
L	23017	699.7	23025	700.5	23035	701.5	23060	704				
M	23095	707.5	23095	707.5	23095	707.5	23095	707.5				
H	23173	715.3	23165	714.5	23155	713.5	23130	711				
LTE Band 13												
	Bandwidth 5 MHz				Bandwidth 10 MHz							
	Channel #		Freq.(MHz)		Channel #		Freq.(MHz)		Channel #		Freq.(MHz)	
L	23205		779.5		23230		782		23230		782	
M	23230		782									
H	23255		784.5									
LTE Band 17												
	Bandwidth 5 MHz				Bandwidth 10 MHz							
	Channel #		Freq.(MHz)		Channel #		Freq. (MHz)		Channel #		Freq. (MHz)	
L	23755		706.5		23780		709		23780		709	
M	23790		710		23790		710		23790		710	
H	23825		713.5		23800		711		23800		711	
LTE Band 25												
	Bandwidth 1.4 MHz		Bandwidth 3 MHz		Bandwidth 5 MHz		Bandwidth 10 MHz		Bandwidth 15 MHz		Bandwidth 20 MHz	
	Ch. #	Freq. (MHz)	Ch. #	Freq. (MHz)	Ch. #	Freq. (MHz)	Ch. #	Freq. (MHz)	Ch. #	Freq. (MHz)	Ch. #	Freq. (MHz)
L	26047	1850.7	26055	1851.5	26065	1852.5	26090	1855	26115	1857.5	26140	1860
M	26340	1880	26340	1880	26340	1880	26340	1880	26340	1880	26340	1880
H	26683	1914.3	26675	1913.5	26665	1912.5	26640	1910	26615	1907.5	26590	1905



LTE Band 26												
	Bandwidth 1.4 MHz		Bandwidth 3 MHz		Bandwidth 5 MHz		Bandwidth 10 MHz		Bandwidth 15 MHz			
	Ch. #	Freq. (MHz)	Ch. #	Freq. (MHz)	Ch. #	Freq. (MHz)	Ch. #	Freq. (MHz)	Ch. #	Freq. (MHz)		
L	26697	814.7	26705	815.5	26715	816.5	26740	819	26765	821.5		
M	26865	831.5	26865	831.5	26865	831.5	26865	831.5	26865	831.5		
H	27033	848.3	27025	847.5	27015	846.5	26990	844	26965	841.5		
LTE Band 38												
	Bandwidth 5 MHz		Bandwidth 10 MHz		Bandwidth 15 MHz		Bandwidth 20 MHz					
	Ch. #	Freq. (MHz)	Ch. #	Freq. (MHz)	Ch. #	Freq. (MHz)	Ch. #	Freq. (MHz)				
L	37775	2572.5	37800	2575	37825	2577.5	37850	2580				
M	38000	2595	38000	2595	38000	2595	38000	2595				
H	38225	2617.5	38200	2615	38175	2612.5	38150	2610				
LTE Band 41												
	Bandwidth 5 MHz		Bandwidth 10 MHz		Bandwidth 15 MHz		Bandwidth 20 MHz					
	Ch. #	Freq. (MHz)	Ch. #	Freq. (MHz)	Ch. #	Freq. (MHz)	Ch. #	Freq. (MHz)				
L	39675	2498.5	39700	2501	39725	2503.5	39750	2506				
L	40148	2545.8	40160	2547	40173	2548.3	40185	2549.5				
M	40620	2593	40620	2593	40620	2593	40620	2593				
H	41093	2640.3	41080	2639	41068	2637.8	41055	2636.5				
H	41565	2687.5	41540	2685	41515	2682.5	41490	2680				
LTE Band 66												
	Bandwidth 1.4 MHz		Bandwidth 3 MHz		Bandwidth 5 MHz		Bandwidth 10 MHz		Bandwidth 15 MHz		Bandwidth 20 MHz	
	Ch. #	Freq. (MHz)	Ch. #	Freq. (MHz)	Ch. #	Freq. (MHz)	Ch. #	Freq. (MHz)	Ch. #	Freq. (MHz)	Ch. #	Freq. (MHz)
L	131979	1710.7	131987	1711.5	131997	1712.5	132022	1715	132047	1717.5	132072	1720
M	132322	1745	132322	1745	132322	1745	132322	1745	132322	1745	132322	1745
H	132665	1779.3	132657	1778.5	132647	1777.5	132622	1775	132597	1772.5	132572	1770

## **5. RF Exposure Limits**

### **5.1 Uncontrolled Environment**

Uncontrolled Environments are defined as locations where there is the exposure of individuals who have no knowledge or control of their exposure. The general population/uncontrolled exposure limits are applicable to situations in which the general public may be exposed or in which persons who are exposed as a consequence of their employment may not be made fully aware of the potential for exposure or cannot exercise control over their exposure. Members of the general public would come under this category when exposure is not employment-related; for example, in the case of a wireless transmitter that exposes persons in its vicinity.

### **5.2 Controlled Environment**

Controlled Environments are defined as locations where there is exposure that may be incurred by persons who are aware of the potential for exposure, (i.e. as a result of employment or occupation). In general, occupational/controlled exposure limits are applicable to situations in which persons are exposed as a consequence of their employment, who have been made fully aware of the potential for exposure and can exercise control over their exposure. The exposure category is also applicable when the exposure is of a transient nature due to incidental passage through a location where the exposure levels may be higher than the general population/uncontrolled limits, but the exposed person is fully aware of the potential for exposure and can exercise control over his or her exposure by leaving the area or by some other appropriate means.

**Limits for Occupational/Controlled Exposure (W/kg)**

Whole-Body	Partial-Body	Hands, Wrists, Feet and Ankles
0.4	8.0	20.0

**Limits for General Population/Uncontrolled Exposure (W/kg)**

Whole-Body	Partial-Body	Hands, Wrists, Feet and Ankles
0.08	1.6	4.0

Whole-Body SAR is averaged over the entire body, partial-body SAR is averaged over any 1gram of tissue defined as a tissue volume in the shape of a cube. SAR for hands, wrists, feet and ankles is averaged over any 10 grams of tissue defined as a tissue volume in the shape of a cube.

## **6. Specific Absorption Rate (SAR)**

### **6.1 Introduction**

SAR is related to the rate at which energy is absorbed per unit mass in an object exposed to a radio field. The SAR distribution in a biological body is complicated and is usually carried out by experimental techniques or numerical modeling. The standard recommends limits for two tiers of groups, occupational/controlled and general population/uncontrolled, based on a person's awareness and ability to exercise control over his or her exposure. In general, occupational/controlled exposure limits are higher than the limits for general population/uncontrolled.

### **6.2 SAR Definition**

The SAR definition is the time derivative (rate) of the incremental energy (dW) absorbed by (dissipated in) an incremental mass (dm) contained in a volume element (dv) of a given density ( $\rho$ ). The equation description is as below:

$$SAR = \frac{d}{dt} \left( \frac{dW}{dm} \right) = \frac{d}{dt} \left( \frac{dW}{\rho dv} \right)$$

SAR is expressed in units of Watts per kilogram (W/kg)

$$SAR = \frac{\sigma |E|^2}{\rho}$$

Where:  $\sigma$  is the conductivity of the tissue,  $\rho$  is the mass density of the tissue and E is the RMS electrical field strength.

## 7. System Description and Setup

The DASY system used for performing compliance tests consists of the following items:

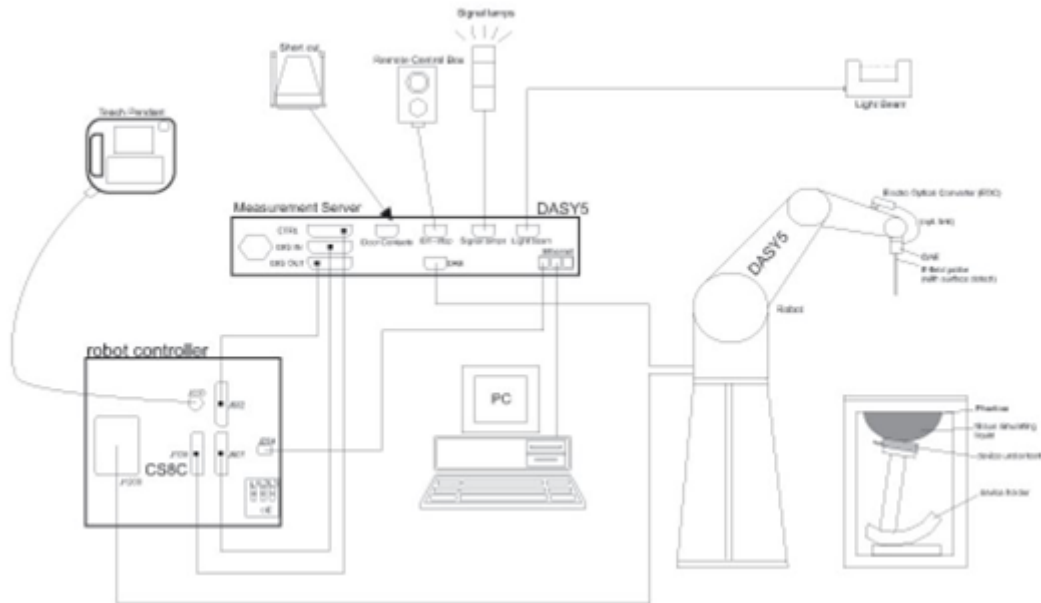

- A standard high precision 6-axis robot with controller, teach pendant and software. An arm extension for accommodating the data acquisition electronics (DAE).
- An isotropic Field probe optimized and calibrated for the targeted measurement.
- A data acquisition electronics (DAE) which performs the signal amplification, signal multiplexing, AD-conversion, offset measurements, mechanical surface detection, collision detection, etc. The unit is battery powered with standard or rechargeable batteries. The signal is optically transmitted to the EOC.
- The Electro-optical converter (EOC) performs the conversion from optical to electrical signals for the digital communication to the DAE. To use optical surface detection, a special version of the EOC is required. The EOC signal is transmitted to the measurement server.
- The function of the measurement server is to perform the time critical tasks such as signal filtering, control of the robot operation and fast movement interrupts.
- The Light Beam used is for probe alignment. This improves the (absolute) accuracy of the probe positioning.
- A computer running WinXP or Win7 and the DASY5 software.
- Remote control and teach pendant as well as additional circuitry for robot safety such as warning lamps, etc.
- The phantom, the device holder and other accessories according to the targeted measurement.

**7.1 E-Field Probe**

The SAR measurement is conducted with the dosimetric probe (manufactured by SPEAG).The probe is specially designed and calibrated for use in liquid with high permittivity. The dosimetric probe has special calibration in liquid at different frequency. This probe has a built in optical surface detection system to prevent from collision with phantom.

**<EX3DV4 Probe>**

<b>Construction</b>	Symmetric design with triangular core Built-in shielding against static charges PEEK enclosure material (resistant to organic solvents, e.g., DGBE)	
<b>Frequency</b>	10 MHz – >6 GHz Linearity: ±0.2 dB (30 MHz – 6 GHz)	
<b>Directivity</b>	±0.3 dB in TSL (rotation around probe axis) ±0.5 dB in TSL (rotation normal to probe axis)	
<b>Dynamic Range</b>	10 µW/g – >100 mW/g Linearity: ±0.2 dB (noise: typically <1 µW/g)	
<b>Dimensions</b>	Overall length: 337 mm (tip: 20 mm) Tip diameter: 2.5 mm (body: 12 mm) Typical distance from probe tip to dipole centers: 1 mm	

**7.2 Data Acquisition Electronics (DAE)**

The data acquisition electronics (DAE) consists of a highly sensitive electrometer-grade preamplifier with auto-zeroing, a channel and gain-switching multiplexer, a fast 16 bit AD-converter and a command decoder and control logic unit. Transmission to the measurement server is accomplished through an optical downlink for data and status information as well as an optical uplink for commands and the clock.

The input impedance of the DAE is 200 MOhm; the inputs are symmetrical and floating. Common mode rejection is above 80 dB.



**Fig 5.1 Photo of DAE**

**7.3 Phantom**

**<SAM Twin Phantom>**

<b>Shell Thickness</b>	2 ± 0.2 mm; Center ear point: 6 ± 0.2 mm
<b>Filling Volume</b>	Approx. 25 liters
<b>Dimensions</b>	Length: 1000 mm; Width: 500 mm; Height: adjustable feet
<b>Measurement Areas</b>	Left Hand, Right Hand, Flat Phantom



The bottom plate contains three pair of bolts for locking the device holder. The device holder positions are adjusted to the standard measurement positions in the three sections. A white cover is provided to tap the phantom during off-periods to prevent water evaporation and changes in the liquid parameters. On the phantom top, three reference markers are provided to identify the phantom position with respect to the robot.

**<ELI Phantom>**

<b>Shell Thickness</b>	2 ± 0.2 mm (sagging: <1%)
<b>Filling Volume</b>	Approx. 30 liters
<b>Dimensions</b>	Major ellipse axis: 600 mm Minor axis: 400 mm

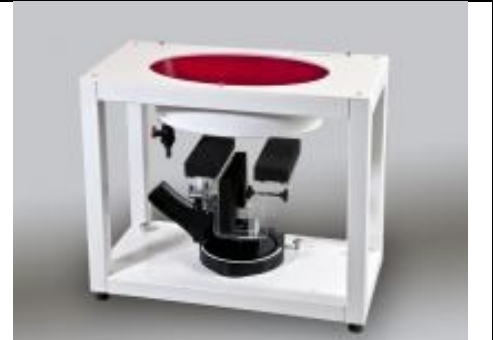

The ELI phantom is intended for compliance testing of handheld and body-mounted wireless devices in the frequency range of 30 MHz to 6 GHz. ELI4 is fully compatible with standard and all known tissue simulating liquids.

## 7.4 Device Holder

### <Mounting Device for Hand-Held Transmitter>

In combination with the Twin SAM V5.0/V5.0c or ELI phantoms, the Mounting Device for Hand-Held Transmitters enables rotation of the mounted transmitter device to specified spherical coordinates. At the heads, the rotation axis is at the ear opening. Transmitter devices can be easily and accurately positioned according to IEC 62209-1, IEEE 1528, FCC, or other specifications. The device holder can be locked for positioning at different phantom sections (left head, right head, flat). And upgrade kit to Mounting Device to enable easy mounting of wider devices like big smart-phones, e-books, small tablets, etc. It holds devices with width up to 140 mm.



Mounting Device for Hand-Held Transmitters

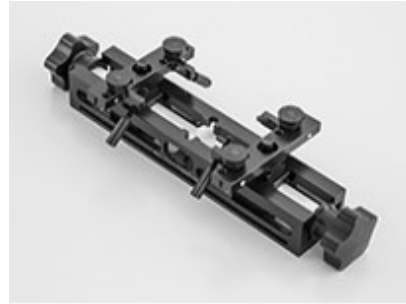

Mounting Device Adaptor for Wide-Phones

### <Mounting Device for Laptops and other Body-Worn Transmitters>

The extension is lightweight and made of POM, acrylic glass and foam. It fits easily on the upper part of the mounting device in place of the phone positioned. The extension is fully compatible with the SAM Twin and ELI phantoms.



Mounting Device for Laptops

## **8. Measurement Procedures**

The measurement procedures are as follows:

### <Conducted power measurement>

- (a) For WWAN power measurement, use base station simulator to configure EUT WWAN transmission in conducted connection with RF cable, at maximum power in each supported wireless interface and frequency band.
- (b) Read the WWAN RF power level from the base station simulator.
- (c) For WLAN/BT power measurement, use engineering software to configure EUT WLAN/BT continuously transmission, at maximum RF power in each supported wireless interface and frequency band
- (d) Connect EUT RF port through RF cable to the power meter, and measure WLAN/BT output power

### <SAR measurement>

- (a) Use base station simulator to configure EUT WWAN transmission in radiated connection, and engineering software to configure EUT WLAN/BT continuously transmission, at maximum RF power, in the highest power channel.
- (b) Place the EUT in the positions as Appendix D demonstrates.
- (c) Set scan area, grid size and other setting on the DASY software.
- (d) Measure SAR results for the highest power channel on each testing position.
- (e) Find out the largest SAR result on these testing positions of each band
- (f) Measure SAR results for other channels in worst SAR testing position if the reported SAR of highest power channel is larger than 0.8 W/kg

According to the test standard, the recommended procedure for assessing the peak spatial-average SAR value consists of the following steps:

- (a) Power reference measurement
- (b) Area scan
- (c) Zoom scan
- (d) Power drift measurement

### **8.1 Spatial Peak SAR Evaluation**

The procedure for spatial peak SAR evaluation has been implemented according to the test standard. It can be conducted for 1g and 10g, as well as for user-specific masses. The DASY software includes all numerical procedures necessary to evaluate the spatial peak SAR value.

The base for the evaluation is a "cube" measurement. The measured volume must include the 1g and 10g cubes with the highest averaged SAR values. For that purpose, the center of the measured volume is aligned to the interpolated peak SAR value of a previously performed area scan.

The entire evaluation of the spatial peak values is performed within the post-processing engine (SEMCAD). The system always gives the maximum values for the 1g and 10g cubes. The algorithm to find the cube with highest averaged SAR is divided into the following stages:

- (a) Extraction of the measured data (grid and values) from the Zoom Scan
- (b) Calculation of the SAR value at every measurement point based on all stored data (A/D values and measurement parameters)
- (c) Generation of a high-resolution mesh within the measured volume
- (d) Interpolation of all measured values from the measurement grid to the high-resolution grid
- (e) Extrapolation of the entire 3-D field distribution to the phantom surface over the distance from sensor to surface
- (f) Calculation of the averaged SAR within masses of 1g and 10g

**8.2 Power Reference Measurement**

The Power Reference Measurement and Power Drift Measurements are for monitoring the power drift of the device under test in the batch process. The minimum distance of probe sensors to surface determines the closest measurement point to phantom surface. This distance cannot be smaller than the distance of sensor calibration points to probe tip as defined in the probe properties.

**8.3 Area Scan**

The area scan is used as a fast scan in two dimensions to find the area of high field values, before doing a fine measurement around the hot spot. The sophisticated interpolation routines implemented in DASY software can find the maximum found in the scanned area, within a range of the global maximum. The range (in dB0 is specified in the standards for compliance testing. For example, a 2 dB range is required in IEEE standard 1528 and IEC 62209 standards, whereby 3 dB is a requirement when compliance is assessed in accordance with the ARIB standard (Japan), if only one zoom scan follows the area scan, then only the absolute maximum will be taken as reference. For cases where multiple maximums are detected, the number of zoom scans has to be increased accordingly.

Area scan parameters extracted from FCC KDB 865664 D01v01r04 SAR measurement 100 MHz to 6 GHz.

	≤ 3 GHz	> 3 GHz
Maximum distance from closest measurement point (geometric center of probe sensors) to phantom surface	5 ± 1 mm	$\frac{1}{2} \cdot \delta \cdot \ln(2) \pm 0.5$ mm
Maximum probe angle from probe axis to phantom surface normal at the measurement location	30° ± 1°	20° ± 1°
Maximum area scan spatial resolution: $\Delta x_{Area}$ , $\Delta y_{Area}$	≤ 2 GHz: ≤ 15 mm 2 – 3 GHz: ≤ 12 mm	3 – 4 GHz: ≤ 12 mm 4 – 6 GHz: ≤ 10 mm
	When the x or y dimension of the test device, in the measurement plane orientation, is smaller than the above, the measurement resolution must be ≤ the corresponding x or y dimension of the test device with at least one measurement point on the test device.	

### 8.4 Zoom Scan

Zoom scans are used to assess the peak spatial SAR values within a cubic averaging volume containing 1 gram and 10 gram of simulated tissue. The zoom scan measures points (refer to table below) within a cube whose base faces are centered on the maxima found in a preceding area scan job within the same procedure. When the measurement is done, the zoom scan evaluates the averaged SAR for 1 gram and 10 gram and displays these values next to the job's label.

Zoom scan parameters extracted from FCC KDB 865664 D01v01r04 SAR measurement 100 MHz to 6 GHz.

		≤ 3 GHz	> 3 GHz	
Maximum zoom scan spatial resolution: $\Delta x_{Zoom}, \Delta y_{Zoom}$		$\leq 2$ GHz: $\leq 8$ mm 2 – 3 GHz: $\leq 5$ mm*	3 – 4 GHz: $\leq 5$ mm* 4 – 6 GHz: $\leq 4$ mm*	
Maximum zoom scan spatial resolution, normal to phantom surface	uniform grid: $\Delta z_{Zoom}(n)$	$\leq 5$ mm	3 – 4 GHz: $\leq 4$ mm 4 – 5 GHz: $\leq 3$ mm 5 – 6 GHz: $\leq 2$ mm	
	graded grid	$\Delta z_{Zoom}(1)$ : between 1 <sup>st</sup> two points closest to phantom surface	$\leq 4$ mm	3 – 4 GHz: $\leq 3$ mm 4 – 5 GHz: $\leq 2.5$ mm 5 – 6 GHz: $\leq 2$ mm
		$\Delta z_{Zoom}(n>1)$ : between subsequent points	$\leq 1.5 \cdot \Delta z_{Zoom}(n-1)$	
Minimum zoom scan volume	x, y, z	$\geq 30$ mm	3 – 4 GHz: $\geq 28$ mm 4 – 5 GHz: $\geq 25$ mm 5 – 6 GHz: $\geq 22$ mm	
Note: $\delta$ is the penetration depth of a plane-wave at normal incidence to the tissue medium; see draft standard IEEE P1528-2011 for details. * When zoom scan is required and the <i>reported</i> SAR from the <i>area scan based 1-g SAR estimation</i> procedures of KDB 447498 is $\leq 1.4$ W/kg, $\leq 8$ mm, $\leq 7$ mm and $\leq 5$ mm zoom scan resolution may be applied, respectively, for 2 GHz to 3 GHz, 3 GHz to 4 GHz and 4 GHz to 6 GHz.				

### 8.5 Volume Scan Procedures

The volume scan is used to assess overlapping SAR distributions for antennas transmitting in different frequency bands. It is equivalent to an oversized zoom scan used in standalone measurements. The measurement volume will be used to enclose all the simultaneous transmitting antennas. For antennas transmitting simultaneously in different frequency bands, the volume scan is measured separately in each frequency band. In order to sum correctly to compute the 1g aggregate SAR, the EUT remain in the same test position for all measurements and all volume scan use the same spatial resolution and grid spacing. When all volume scan were completed, the software, SEMCAD postprocessor can combine and subsequently superpose these measurement data to calculating the multiband SAR.

### 8.6 Power Drift Monitoring

All SAR testing is under the EUT install full charged battery and transmit maximum output power. In DASYS measurement software, the power reference measurement and power drift measurement procedures are used for monitoring the power drift of EUT during SAR test. Both these procedures measure the field at a specified reference position before and after the SAR testing. The software will calculate the field difference in dB. If the power drifts more than 5%, the SAR will be retested.



**9. Test Equipment List**

Manufacturer	Name of Equipment	Type/Model	Serial Number	Calibration	
				Last Cal.	Due Date
SPEAG	750MHz System Validation Kit	D750V3	1065	2016/11/21	2017/11/20
SPEAG	835MHz System Validation Kit	D835V2	4d091	2016/11/22	2017/11/21
SPEAG	1750MHz System Validation Kit	D1750V2	1069	2016/11/23	2017/11/22
SPEAG	1900MHz System Validation Kit	D1900V2	5d118	2016/11/24	2017/11/23
SPEAG	2450MHz System Validation Kit	D2450V2	840	2016/11/25	2017/11/24
SPEAG	2600MHz System Validation Kit	D2600V2	1061	2016/11/24	2017/11/23
SPEAG	5000MHz System Validation Kit	D5GHzV2	1113	2016/12/13	2017/12/12
SPEAG	Data Acquisition Electronics	DAE4	1279	2017/5/2	2018/5/1
SPEAG	Data Acquisition Electronics	DAE4	1210	2017/5/25	2018/5/24
SPEAG	Dosimetric E-Field Probe	EX3DV4	3954	2016/11/28	2017/11/27
SPEAG	Dosimetric E-Field Probe	EX3DV4	3857	2017/5/26	2018/5/25
SPEAG	SAM Twin Phantom	QD 000 P40 CB	TP-1479	NCR	NCR
SPEAG	SAM Twin Phantom	QD 000 P40 CB	TP-1839	NCR	NCR
SPEAG	SAM Twin Phantom	QD 000 P40 CB	TP-1842	NCR	NCR
SPEAG	Phone Positioner	N/A	N/A	NCR	NCR
Anritsu	Radio communication analyzer	MT8820C	6201300654	2016/8/8	2017/8/7
Agilent	Wireless Communication Test Set	E5515C	MY52102706	2017/4/18	2018/4/17
Agilent	ENA Series Network Analyzer	E5071C	MY46111157	2017/4/18	2018/4/17
SPEAG	DAK Kit	DAK3.5	1144	2016/11/23	2017/11/22
R&S	Signal Generator	SMR40	100455	2017/1/19	2018/1/18
Anritsu	Power Sensor	MA2411B	1644003	2016/12/23	2017/12/22
Anritsu	Power Meter	ML2495A	1531197	2016/12/23	2017/12/22
Anritsu	Power Sensor	MA2411B	1644004	2016/12/23	2017/12/22
Anritsu	Power Meter	ML2495A	1531198	2016/12/23	2017/12/22
R&S	CBT BLUETOOTH TESTER	CBT	101137	2016/8/9	2017/8/8
R&S	Spectrum Analyzer	FSV7	101631	2016/8/8	2017/8/7
WISEWIND	Hygrometer	WISEWIND 0905	905	2017/4/20	2018/4/19
JM	DIGITAC THERMOMETER	JM222	AA1207166	2017/4/19	2018/4/18
ARRA	Power Divider	A3200-2	N/A	Note	
Agilent	Dual Directional Coupler	778D	50422	Note	
PASTERNAK	Dual Directional Coupler	PE2214-10	N/A	Note	
MCL	Attenuation1	BW-S10W5+	N/A	Note	
MCL	Attenuation2	BW-S10W5+	N/A	Note	
MCL	Attenuation3	BW-S10W5+	N/A	Note	
AR	Amplifier	5S1G4	333096	Note	
mini-circuits	Amplifier	ZVE-3W-83+	162601250	Note	

**Note:**

Prior to system verification and validation, the path loss from the signal generator to the system check source and the power meter, which includes the amplifier, cable, attenuator and directional coupler, was measured by the network analyzer. The reading of the power meter was offset by the path loss difference between the path to the power meter and the path to the system check source to monitor the actual power level fed to the system check

## 10. System Verification

### 10.1 Tissue Simulating Liquids

For the measurement of the field distribution inside the SAM phantom with DASY, the phantom must be filled with around 25 liters of homogeneous body tissue simulating liquid. For head SAR testing, the liquid height from the ear reference point (ERP) of the phantom to the liquid top surface is larger than 15 cm, which is shown in Fig. 10.1. For body SAR testing, the liquid height from the center of the flat phantom to the liquid top surface is larger than 15 cm, which is shown in Fig. 10.2.

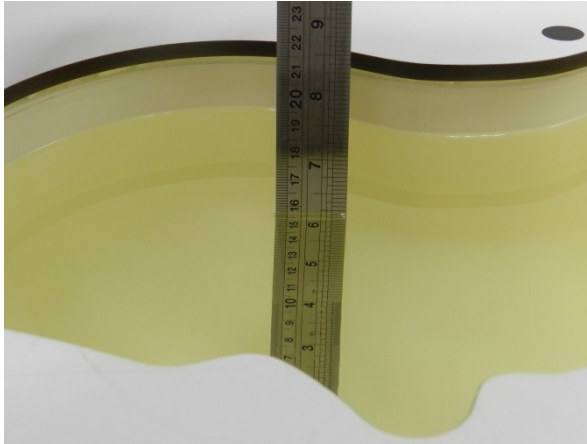

Fig 10.1 Photo of Liquid Height for Head SAR

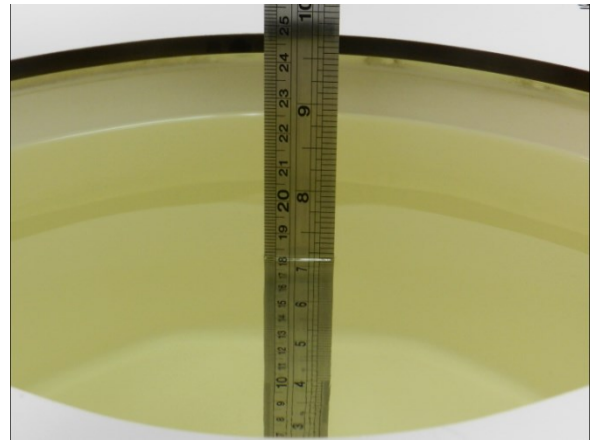

Fig 10.2 Photo of Liquid Height for Body SAR



**10.2 Tissue Verification**

The following tissue formulations are provided for reference only as some of the parameters have not been thoroughly verified. The composition of ingredients may be modified accordingly to achieve the desired target tissue parameters required for routine SAR evaluation.

Frequency (MHz)	Water (%)	Sugar (%)	Cellulose (%)	Salt (%)	Preventol (%)	DGBE (%)	Conductivity ( $\sigma$ )	Permittivity ( $\epsilon_r$ )
<b>For Head</b>								
750	41.1	57.0	0.2	1.4	0.2	0	0.89	41.9
835	40.3	57.9	0.2	1.4	0.2	0	0.90	41.5
1800, 1900, 2000	55.2	0	0	0.3	0	44.5	1.40	40.0
2450	55.0	0	0	0	0	45.0	1.80	39.2
2600	54.8	0	0	0.1	0	45.1	1.96	39.0
<b>For Body</b>								
750	51.7	47.2	0	0.9	0.1	0	0.96	55.5
835	50.8	48.2	0	0.9	0.1	0	0.97	55.2
1800, 1900, 2000	70.2	0	0	0.4	0	29.4	1.52	53.3
2450	68.6	0	0	0	0	31.4	1.95	52.7
2600	68.1	0	0	0.1	0	31.8	2.16	52.5

**Simulating Liquid for 5GHz, Manufactured by SPEAG**

Ingredients	(% by weight)
Water	64~78%
Mineral oil	11~18%
Emulsifiers	9~15%
Additives and Salt	2~3%

**<Tissue Dielectric Parameter Check Results>**

Frequency (MHz)	Tissue Type	Liquid Temp. (°C)	Conductivity ( $\sigma$ )	Permittivity ( $\epsilon_r$ )	Conductivity Target ( $\sigma$ )	Permittivity Target ( $\epsilon_r$ )	Delta ( $\sigma$ ) (%)	Delta ( $\epsilon_r$ ) (%)	Limit (%)	Date
750	Head	22.6	0.903	41.728	0.89	41.90	1.46	-0.41	±5	2017.7.1
835	Head	22.6	0.904	41.521	0.90	41.50	0.44	0.05	±5	2017.7.1
1750	Head	22.7	1.363	39.993	1.37	40.10	-0.51	-0.27	±5	2017.7.8
1900	Head	22.7	1.440	40.233	1.40	40.00	2.86	0.58	±5	2017.7.8
2450	Head	22.8	1.883	38.166	1.80	39.20	4.61	-2.64	±5	2017.7.9
2600	Head	22.8	2.058	37.577	1.96	39.00	5.00	-3.65	±5	2017.7.9
5250	Head	22.9	4.776	36.018	4.71	35.90	1.40	0.33	±5	2017.7.2
5600	Head	22.9	5.146	35.478	5.07	35.50	1.50	-0.06	±5	2017.7.2
5750	Head	22.9	5.311	35.242	5.22	35.40	1.74	-0.45	±5	2017.7.2
750	Body	22.6	0.980	56.962	0.96	55.50	2.08	2.63	±5	2017.6.29
835	Body	22.7	0.991	54.291	0.97	55.20	2.16	-1.65	±5	2017.6.10
1750	Body	22.7	1.449	54.495	1.49	53.40	-2.75	2.05	±5	2017.7.1
1900	Body	22.8	1.540	51.409	1.52	53.30	1.32	-3.55	±5	2017.6.29
2450	Body	22.9	2.018	52.429	1.95	52.70	3.49	-0.51	±5	2017.7.5
2600	Body	22.9	2.196	51.310	2.16	52.50	1.67	-2.27	±5	2017.7.5
5250	Body	22.9	5.539	48.005	5.36	48.90	3.34	-1.83	±5	2017.7.5
5600	Body	22.9	6.006	47.402	5.77	48.50	4.09	-2.26	±5	2017.7.5
5750	Body	22.9	6.214	47.167	5.94	48.30	4.61	-2.35	±5	2017.7.5

**10.3 System Performance Check Results**

Comparing to the original SAR value provided by SPEAG, the verification data should be within its specification of 10 %. Below table shows the target SAR and measured SAR after normalized to 1W input power. The table below indicates the system performance check can meet the variation criterion and the plots can be referred to Appendix A of this report.

**<1g SAR>:**

Date	Frequency (MHz)	Tissue Type	Input Power (mW)	Dipole S/N	Probe S/N	DAE S/N	Measured 1g SAR (W/kg)	Targeted 1g SAR (W/kg)	Normalized 1g SAR (W/kg)	Deviation (%)
2017.7.1	750	Head	250	1065	3954	1279	2.18	8.32	8.72	4.81
2017.7.1	835	Head	250	4d091	3954	1279	2.40	9.31	9.6	3.11
2017.7.8	1750	Head	250	1069	3954	1279	8.76	37.50	35.04	-6.56
2017.7.8	1900	Head	250	5d118	3954	1279	9.80	40.40	39.2	-2.97
2017.7.9	2450	Head	250	840	3954	1279	13.80	54.00	55.2	2.22
2017.7.9	2600	Head	250	1061	3954	1279	14.80	56.00	59.2	5.71
2017.7.2	5250	Head	100	1113	3954	1279	8.15	76.40	81.5	6.68
2017.7.2	5600	Head	100	1113	3954	1279	7.71	80.80	77.1	-4.58
2017.7.2	5750	Head	100	1113	3954	1279	7.56	80.30	75.6	-5.85
2017.6.29	750	Body	250	1065	3954	1279	2.26	8.71	9.04	3.79
2017.6.10	835	Body	250	4d091	3954	1279	2.38	9.68	9.52	-1.65
2017.7.1	1750	Body	250	1069	3857	1210	8.94	37.70	35.76	-5.15
2017.6.29	1900	Body	250	5d118	3857	1210	9.81	40.80	39.24	-3.82
2017.7.5	2450	Body	250	840	3954	1279	12.60	50.90	50.4	-0.98
2017.7.5	2600	Body	250	1061	3954	1279	14.40	55.40	57.6	3.97
2017.7.5	5250	Body	100	1113	3954	1279	7.48	76.10	74.8	-1.71
2017.7.5	5600	Body	100	1113	3954	1279	8.41	79.80	84.1	5.39
2017.7.5	5750	Body	100	1113	3954	1279	7.18	75.20	71.8	-4.52

**<10g SAR>:**

Date	Frequency (MHz)	Tissue Type	Input Power (mW)	Dipole S/N	Probe S/N	DAE S/N	Measured 10g SAR (W/kg)	Targeted 10g SAR (W/kg)	Normalized 10g SAR (W/kg)	Deviation (%)
2017.7.1	1750	Body	250	1069	3857	1210	4.97	20.30	19.88	-2.07
2017.6.29	1900	Body	250	5d118	3857	1210	5.21	21.30	20.84	-2.16
2017.7.5	5250	Body	100	1113	3954	1279	2.08	21.50	20.80	-3.26
2017.7.5	5600	Body	100	1113	3954	1279	2.33	22.60	23.30	3.10

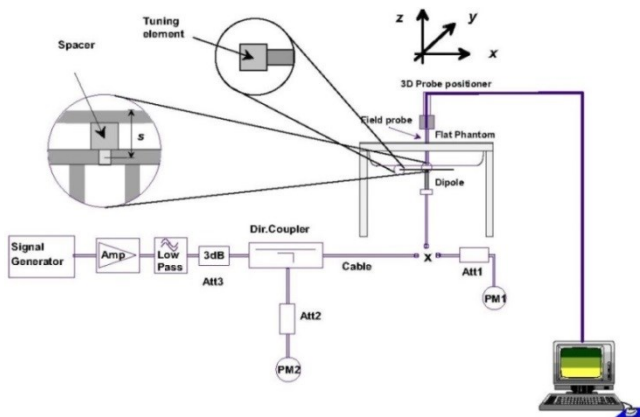

**Fig 8.3.1 System Performance Check Setup**

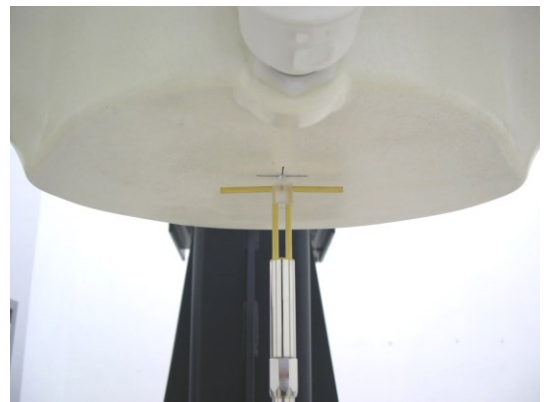

**Fig 8.3.2 Setup Photo**

## 11. RF Exposure Positions

### 11.1 Ear and handset reference point

Figure 9.1.1 shows the front, back, and side views of the SAM phantom. The center-of-mouth reference point is labeled “M,” the left ear reference point (ERP) is marked “LE,” and the right ERP is marked “RE.” Each ERP is 15 mm along the B-M (back-mouth) line behind the entrance-to-ear-canal (EEC) point, as shown in Figure 9.1.2 The Reference Plane is defined as passing through the two ear reference points and point M. The line N-F (neck-front), also called the reference pivoting line, is normal to the Reference Plane and perpendicular to both a line passing through RE and LE and the B-M line (see Figure 9.1.3). Both N-F and B-M lines should be marked on the exterior of the phantom shell to facilitate handset positioning. Posterior to the N-F line the ear shape is a flat surface with 6 mm thickness at each ERP, and forward of the N-F line the ear is truncated, as illustrated in Figure 9.1.2. The ear truncation is introduced to preclude the ear lobe from interfering with handset tilt, which could lead to unstable positioning at the cheek.

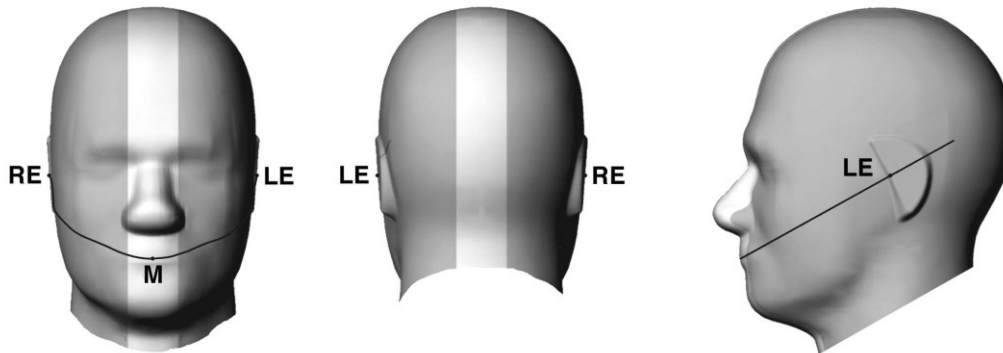

Fig 9.1.1 Front, back, and side views of SAM twin phantom

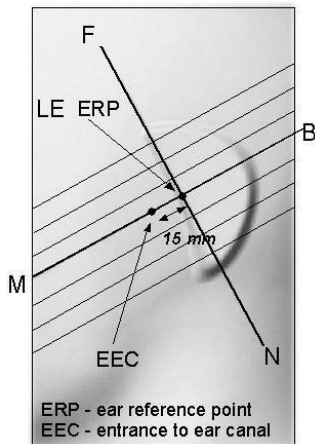

Fig 9.1.2 Close-up side view of phantom showing the ear region.

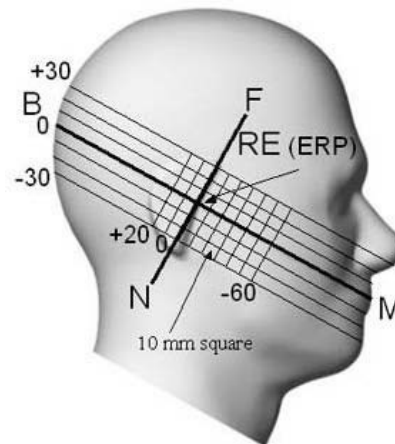

Fig 9.1.3 Side view of the phantom showing relevant markings and seven cross-sectional plane locations

### 11.2 Definition of the cheek position

1. Ready the handset for talk operation, if necessary. For example, for handsets with a cover piece (flip cover), open the cover. If the handset can transmit with the cover closed, both configurations must be tested.
2. Define two imaginary lines on the handset—the vertical centerline and the horizontal line. The vertical centerline passes through two points on the front side of the handset—the midpoint of the width  $w_t$  of the handset at the level of the acoustic output (point A in Figure 9.2.1 and Figure 9.2.2), and the midpoint of the width  $w_b$  of the bottom of the handset (point B). The horizontal line is perpendicular to the vertical centerline and passes through the center of the acoustic output (see Figure 9.2.1). The two lines intersect at point A. Note that for many handsets, point A coincides with the center of the acoustic output; however, the acoustic output may be located elsewhere on the horizontal line. Also note that the vertical centerline is not necessarily parallel to the front face of the handset (see Figure 9.2.2), especially for clamshell handsets, handsets with flip covers, and other irregularly-shaped handsets.
3. Position the handset close to the surface of the phantom such that point A is on the (virtual) extension of the line passing through points RE and LE on the phantom (see Figure 9.2.3), such that the plane defined by the vertical centerline and the horizontal line of the handset is approximately parallel to the sagittal plane of the phantom.
4. Translate the handset towards the phantom along the line passing through RE and LE until handset point A touches the pinna at the ERP.
5. While maintaining the handset in this plane, rotate it around the LE-RE line until the vertical centerline is in the plane normal to the plane containing B-M and N-F lines, i.e., the Reference Plane.
6. Rotate the handset around the vertical centerline until the handset (horizontal line) is parallel to the N-F line.
7. While maintaining the vertical centerline in the Reference Plane, keeping point A on the line passing through RE and LE, and maintaining the handset contact with the pinna, rotate the handset about the N-F line until any point on the handset is in contact with a phantom point below the pinna on the cheek. See Figure 9.2.3. The actual rotation angles should be documented in the test report.

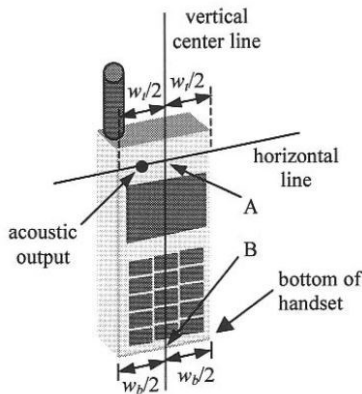

Fig 9.2.1 Handset vertical and horizontal reference lines—“fixed case”

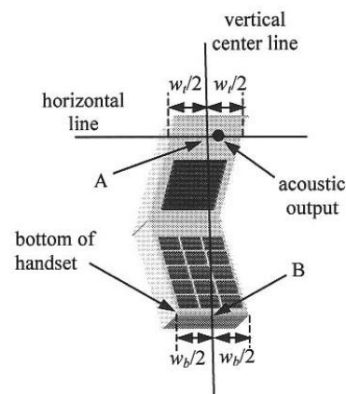

Fig 9.2.2 Handset vertical and horizontal reference lines—“clam-shell case”

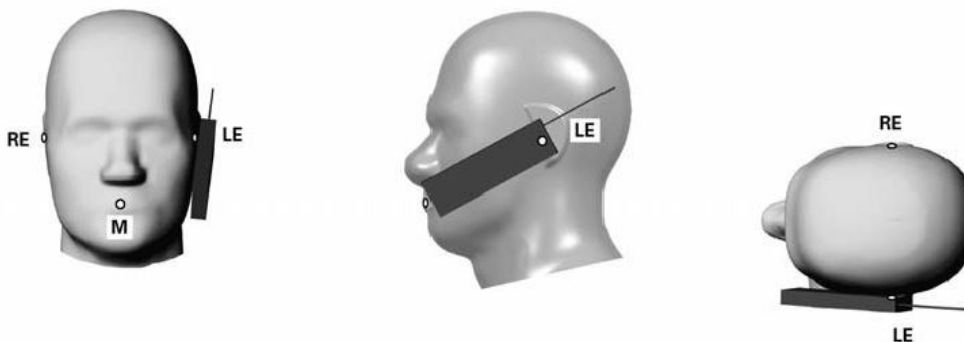
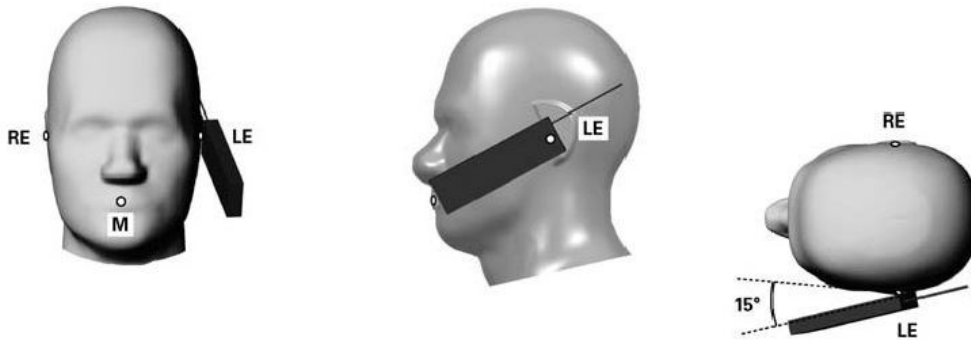

Fig 9.2.3 cheek or touch position. The reference points for the right ear (RE), left ear (LE), and mouth (M), which establish the Reference Plane for handset positioning, are indicated.

**11.3 Definition of the tilt position**

1. Ready the handset for talk operation, if necessary. For example, for handsets with a cover piece (flip cover), open the cover. If the handset can transmit with the cover closed, both configurations must be tested.
2. While maintaining the orientation of the handset, move the handset away from the pinna along the line passing through RE and LE far enough to allow a rotation of the handset away from the cheek by 15°.
3. Rotate the handset around the horizontal line by 15°.
4. While maintaining the orientation of the handset, move the handset towards the phantom on the line passing through RE and LE until any part of the handset touches the ear. The tilt position is obtained when the contact point is on the pinna. See Figure 9.3.1. If contact occurs at any location other than the pinna, e.g., the antenna at the back of the phantom head, the angle of the handset should be reduced. In this case, the tilt position is obtained if any point on the handset is in contact with the pinna and a second point



**Fig 9.3.1 Tilt position. The reference points for the right ear (RE), left ear (LE), and mouth (M), which define the Reference Plane for handset positioning, are indicated.**

## 11.4 Body Worn Accessory

Body-worn operating configurations are tested with the belt-clips and holsters attached to the device and positioned against a flat phantom in a normal use configuration (see Figure 9.4). Per KDB648474 D04v01r03, body-worn accessory exposure is typically related to voice mode operations when handsets are carried in body-worn accessories. The body-worn accessory procedures in FCC KDB 447498 D01v06 should be used to test for body-worn accessory SAR compliance, without a headset connected to it. This enables the test results for such configuration to be compatible with that required for hotspot mode when the body-worn accessory test separation distance is greater than or equal to that required for hotspot mode, when applicable. When the reported SAR for body-worn accessory, measured without a headset connected to the handset is  $> 1.2 \text{ W/kg}$ , the highest reported SAR configuration for that wireless mode and frequency band should be repeated for that body-worn accessory with a handset attached to the handset.

Accessories for body-worn operation configurations are divided into two categories: those that do not contain metallic components and those that do contain metallic components. When multiple accessories that do not contain metallic components are supplied with the device, the device is tested with only the accessory that dictates the closest spacing to the body. Then multiple accessories that contain metallic components are tested with the device with each accessory. If multiple accessories share an identical metallic component (i.e. the same metallic belt-clip used with different holsters with no other metallic components) only the accessory that dictates the closest spacing to the body is tested.

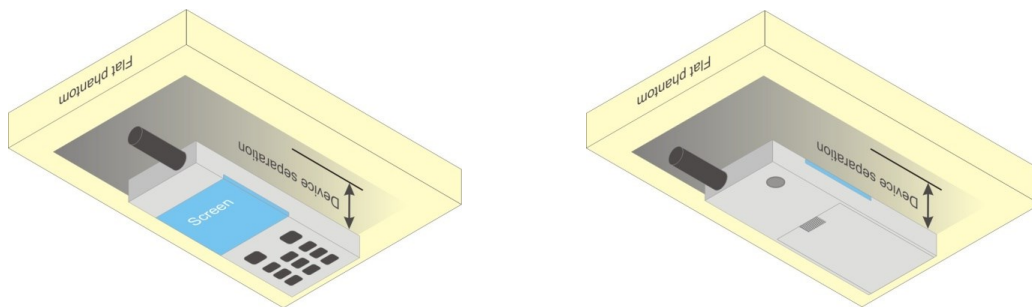

Fig 9.4 Body Worn Position

## 11.5 Product Specific 10g SAR Exposure

For smart phones with a display diagonal dimension  $> 15.0 \text{ cm}$  or an overall diagonal dimension  $> 16.0 \text{ cm}$  that provide similar mobile web access and multimedia support found in mini-tablets or UMPC mini-tablets that support voice calls next to the ear, According to KDB648474 D04v01r03, the following phablet procedures should be applied to evaluate SAR compliance for each applicable wireless mode and frequency band. Devices marketed as phablets, regardless of form factors and operating characteristics must be tested as a phablet to determine SAR compliance

1. The normally required head and body-worn accessory SAR test procedures for handsets, including hotspot mode, must be applied.

2. The UMPC mini-tablet procedures must also be applied to test the SAR of all surfaces and edges with an antenna located at  $\leq 25 \text{ mm}$  from that surface or edge, in direct contact with a flat phantom, for 10-g extremity SAR according to the body-equivalent tissue dielectric parameters in KDB 865664 to address interactive hand use exposure conditions.6 The UMPC mini-tablet 1-g SAR at 5 mm is not required. When hotspot mode applies, 10-g extremity SAR is required only for the surfaces and edges with hotspot mode 1-g reported SAR  $> 1.2 \text{ W/kg}$ .



### **11.6 Wireless Router**

Some battery-operated handsets have the capability to transmit and receive user through simultaneous transmission of WIFI simultaneously with a separate licensed transmitter. The FCC has provided guidance in FCC KDB Publication 941225 D06 v02r01 where SAR test considerations for handsets (L x W  $\geq$  9 cm x 5 cm) are based on a composite test separation distance of 10mm from the front, back and edges of the device containing transmitting antennas within 2.5cm of their edges, determined from general mixed use conditions for this type of devices. Since the hotspot SAR results may overlap with the body-worn accessory SAR requirements, the more conservative configurations can be considered, thus excluding some body-worn accessory SAR tests.

When the user enables the personal wireless router functions for the handset, actual operations include simultaneous transmission of both the WIFI transmitter and another licensed transmitter. Both transmitters often do not transmit at the same transmitting frequency and thus cannot be evaluated for SAR under actual use conditions due to the limitations of the SAR assessment probes. Therefore, SAR must be evaluated for each frequency transmission and mode separately and spatially summed with the WIFI transmitter according to FCC KDB Publication 447498 D01v06 publication procedures. The "Portable Hotspot" feature on the handset was NOT activated during SAR assessments, to ensure the SAR measurements were evaluated for a single transmission frequency RF signal at a time.



## 12. Conducted RF Output Power (Unit: dBm)

### <GSM Conducted Power>

- Per KDB 447498 D01v06, the maximum output power channel is used for SAR testing and for further SAR test reduction.
- Per KDB 941225 D01v03r01, for SAR test reduction for GSM / GPRS / EDGE modes is determined by the source-based time-averaged output power including tune-up tolerance. The mode with highest specified time-averaged output power should be tested for SAR compliance in the applicable exposure conditions. For modes with the same specified maximum output power and tolerance, the higher number time-slot configuration should be tested. Therefore, the GPRS (4Tx slots) for GSM850/GSM1900 are considered as the primary mode.
- Other configurations of GSM / GPRS / EDGE are considered as secondary modes. The 3G SAR test reduction procedure is applied, when the maximum output power and tune-up tolerance specified for production units in a secondary mode is  $\leq \frac{1}{4}$  dB higher than the primary mode, SAR measurement is not required for the secondary mode.

### <Power Level 1 for Full Power Mode>

GSM850 Tx Channel	Burst Average Power (dBm)			Tune-up Limit (dBm)	Frame-Average Power (dBm)			Tune-up Limit (dBm)
	128	189	251		128	189	251	
Frequency (MHz)	824.2	836.4	848.8		824.2	836.4	848.8	
GSM 1 Tx slot	33.37	33.52	33.35	34.00	24.37	24.52	24.35	25.00
GPRS 1 Tx slot	33.35	33.50	33.33	34.00	24.35	24.50	24.33	25.00
GPRS 2 Tx slots	32.40	32.15	32.23	33.00	26.40	26.15	26.23	27.00
GPRS 3 Tx slots	31.20	31.32	31.06	31.50	26.94	27.06	26.80	27.24
GPRS 4 Tx slots	29.88	29.94	29.84	30.50	26.88	26.94	26.84	27.50
EDGE 1 Tx slot	26.38	26.33	26.17	27.00	17.38	17.33	17.17	18.00
EDGE 2 Tx slots	25.03	24.94	24.87	25.50	19.03	18.94	18.87	19.50
EDGE 3 Tx slots	23.92	23.84	23.76	24.50	19.66	19.58	19.50	20.24
EDGE 4 Tx slots	22.81	22.75	22.63	23.50	19.81	19.75	19.63	20.50
<b>GSM1900</b>								
Tx Channel	Burst Average Power (dBm)			Tune-up Limit (dBm)	Frame-Average Power (dBm)			Tune-up Limit (dBm)
	512	661	810		512	661	810	
Frequency (MHz)	1850.2	1880	1909.8		1850.2	1880	1909.8	
GSM 1 Tx slot	30.17	30.08	30.03	30.50	21.17	21.08	21.03	21.50
GPRS 1 Tx slot	30.15	30.07	30.01	30.50	21.15	21.07	21.01	21.50
GPRS 2 Tx slots	27.43	27.42	27.41	27.50	21.43	21.42	21.41	21.50
GPRS 3 Tx slots	25.45	25.44	25.41	25.50	21.19	21.18	21.15	21.24
GPRS 4 Tx slots	24.12	24.09	24.09	24.50	21.12	21.09	21.09	21.50
EDGE 1 Tx slot	26.42	26.73	26.39	27.00	17.42	17.73	17.39	18.00
EDGE 2 Tx slots	26.43	26.62	26.33	27.00	20.43	20.62	20.33	21.00
EDGE 3 Tx slots	25.11	25.32	25.01	25.50	20.85	21.06	20.75	21.24
EDGE 4 Tx slots	23.73	23.96	23.62	24.00	20.73	20.96	20.62	21.00

**Remark:** The frame-averaged power is linearly scaled the maximum burst averaged power over 8 time slots.

The calculated method are shown as below:

Frame-averaged power = Maximum burst averaged power (1 Tx Slot) - 9 dB

Frame-averaged power = Maximum burst averaged power (2 Tx Slots) - 6 dB

Frame-averaged power = Maximum burst averaged power (3 Tx Slots) - 4.26 dB

Frame-averaged power = Maximum burst averaged power (4 Tx Slots) - 3 dB

**<WCDMA Conducted Power>**

1. The following tests were conducted according to the test requirements outlines in 3GPP TS 34.121 specification.
2. The procedures in KDB 941225 D01v03r01 are applied for 3GPP Rel. 6 HSPA to configure the device in the required sub-test mode(s) to determine SAR test exclusion.
3. For DC-HSDPA, the device was configured according to the H-Set 12, Fixed Reference Channel (FRC) configuration in Table C.8.1.12 of 3GPP TS 34.121-1, with the primary and the secondary serving HS-DSCH Cell enabled during the power measurement.

A summary of these settings are illustrated below:

**HSDPA Setup Configuration:**

- a. The EUT was connected to Base Station Agilent E5515C referred to the Setup Configuration.
- b. The RF path losses were compensated into the measurements.
- c. A call was established between EUT and Base Station with following setting:
  - i. Set Gain Factors ( $\beta_c$  and  $\beta_d$ ) and parameters were set according to each
  - ii. Specific sub-test in the following table, C10.1.4, quoted from the TS 34.121
  - iii. Set RMC 12.2Kbps + HSDPA mode.
  - iv. Set Cell Power = -86 dBm
  - v. Set HS-DSCH Configuration Type to FRC (H-set 1, QPSK)
  - vi. Select HSDPA Uplink Parameters
  - vii. Set Delta ACK, Delta NACK and Delta CQI = 8
  - viii. Set Ack-Nack Repetition Factor to 3
  - ix. Set CQI Feedback Cycle (k) to 4 ms
  - x. Set CQI Repetition Factor to 2
  - xi. Power Ctrl Mode = All Up bits
- d. The transmitted maximum output power was recorded.

**Table C.10.1.4:  $\beta$  values for transmitter characteristics tests with HS-DPCCH**

Sub-test	$\beta_c$	$\beta_d$	$\beta_d$ (SF)	$\beta_c/\beta_d$	$\beta_{HS}$ (Note 1, Note 2)	CM (dB) (Note 3)	MPR (dB) (Note 3)
1	2/15	15/15	64	2/15	4/15	0.0	0.0
2	12/15 (Note 4)	15/15 (Note 4)	64	12/15 (Note 4)	24/15	1.0	0.0
3	15/15	8/15	64	15/8	30/15	1.5	0.5
4	15/15	4/15	64	15/4	30/15	1.5	0.5

Note 1:  $\Delta_{ACK}, \Delta_{NACK}$  and  $\Delta_{CQI} = 30/15$  with  $\beta_{HS} = 30/15 * \beta_c$ .

Note 2: For the HS-DPCCH power mask requirement test in clause 5.2C, 5.7A, and the Error Vector Magnitude (EVM) with HS-DPCCH test in clause 5.13.1A, and HSDPA EVM with phase discontinuity in clause 5.13.1AA,  $\Delta_{ACK}$  and  $\Delta_{NACK} = 30/15$  with  $\beta_{HS} = 30/15 * \beta_c$ , and  $\Delta_{CQI} = 24/15$  with  $\beta_{HS} = 24/15 * \beta_c$ .

Note 3: CM = 1 for  $\beta_c/\beta_d = 12/15, \beta_{HS}/\beta_c = 24/15$ . For all other combinations of DPDCH, DPCCH and HS-DPCCH the MPR is based on the relative CM difference. This is applicable for only UEs that support HSDPA in release 6 and later releases.

Note 4: For subtest 2 the  $\beta_c/\beta_d$  ratio of 12/15 for the TFC during the measurement period (TF1, TF0) is achieved by setting the signalled gain factors for the reference TFC (TF1, TF1) to  $\beta_c = 11/15$  and  $\beta_d = 15/15$ .

**Setup Configuration**

**HSUPA Setup Configuration:**

- a. The EUT was connected to Base Station Agilent E5515C referred to the Setup Configuration.
- b. The RF path losses were compensated into the measurements.
- c. A call was established between EUT and Base Station with following setting \* :
  - i. Call Configs = 5.2B, 5.9B, 5.10B, and 5.13.2B with QPSK
  - ii. Set the Gain Factors ( $\beta_c$  and  $\beta_d$ ) and parameters (AG Index) were set according to each specific sub-test in the following table, C11.1.3, quoted from the TS 34.121
  - iii. Set Cell Power = -86 dBm
  - iv. Set Channel Type = 12.2k + HSPA
  - v. Set UE Target Power
  - vi. Power Ctrl Mode= Alternating bits
  - vii. Set and observe the E-TFCl
  - viii. Confirm that E-TFCl is equal to the target E-TFCl of 75 for sub-test 1, and other subtest's E-TFCl
- d. The transmitted maximum output power was recorded.

**Table C.11.1.3:  $\beta$  values for transmitter characteristics tests with HS-DPCCH and E-DCH**

Sub-test	$\beta_c$	$\beta_d$	$\beta_d$ (SF)	$\beta_c/\beta_d$	$\beta_{HS}$ (Note1)	$\beta_{ec}$	$\beta_{ed}$ (Note 4) (Note 5)	$\beta_{ed}$ (SF)	$\beta_{ed}$ (Codes)	CM (dB) (Note 2)	MPR (dB) (Note 2) (Note 6)	AG Index (Note 5)	E-TFCl
1	11/15 (Note 3)	15/15 (Note 3)	64	11/15 (Note 3)	22/15	209/25	1309/225	4	1	1.0	0.0	20	75
2	6/15	15/15	64	6/15	12/15	12/15	94/75	4	1	3.0	2.0	12	67
3	15/15	9/15	64	15/9	30/15	30/15	$\beta_{ed1}: 47/15$ $\beta_{ed2}: 47/15$	4	2	2.0	1.0	15	92
4	2/15	15/15	64	2/15	4/15	2/15	56/75	4	1	3.0	2.0	17	71
5	15/15	0	-	-	5/15	5/15	47/15	4	1	1.0	0.0	12	67

Note 1: For sub-test 1 to 4,  $\Delta_{ACK}$ ,  $\Delta_{NACK}$  and  $\Delta_{CQI} = 30/15$  with  $\beta_{hs} = 30/15 * \beta_c$ . For sub-test 5,  $\Delta_{ACK}$ ,  $\Delta_{NACK}$  and  $\Delta_{CQI} = 5/15$  with  $\beta_{hs} = 5/15 * \beta_c$ .

Note 2: CM = 1 for  $\beta_c/\beta_d = 12/15$ ,  $\beta_{hs}/\beta_c = 24/15$ . For all other combinations of DPDCH, DPCCH, HS-DPCCH, E-DPDCH and E-DPCCH the MPR is based on the relative CM difference.

Note 3: For subtest 1 the  $\beta_c/\beta_d$  ratio of 11/15 for the TFC during the measurement period (TF1, TF0) is achieved by setting the signalled gain factors for the reference TFC (TF1, TF1) to  $\beta_c = 10/15$  and  $\beta_d = 15/15$ .

Note 4: In case of testing by UE using E-DPDCH Physical Layer category 1, Sub-test 3 is omitted according to TS25.306 Table 5.1g.

Note 5:  $\beta_{ed}$  can not be set directly; it is set by Absolute Grant Value.

Note 6: For subtests 2, 3 and 4, UE may perform E-DPDCH power scaling at max power which could results in slightly smaller MPR values.

**Setup Configuration**

**DC-HSDPA 3GPP release 8 Setup Configuration:**

- a. The EUT was connected to Base Station Agilent E5515C referred to the Setup Configuration below
- b. The RF path losses were compensated into the measurements.
- c. A call was established between EUT and Base Station with following setting:
  - i. Set RMC 12.2Kbps + HSDPA mode.
  - ii. Set Cell Power = -25 dBm
  - iii. Set HS-DSCH Configuration Type to FRC (H-set 12, QPSK)
  - iv. Select HSDPA Uplink Parameters
  - v. Set Gain Factors ( $\beta_c$  and  $\beta_d$ ) and parameters were set according to each Specific sub-test in the following table, C10.1.4, quoted from the TS 34.121
    - a). Subtest 1:  $\beta_c/\beta_d=2/15$
    - b). Subtest 2:  $\beta_c/\beta_d=12/15$
    - c). Subtest 3:  $\beta_c/\beta_d=15/8$
    - d). Subtest 4:  $\beta_c/\beta_d=15/4$
  - vi. Set Delta ACK, Delta NACK and Delta CQI = 8
  - vii. Set Ack-Nack Repetition Factor to 3
  - viii. Set CQI Feedback Cycle (k) to 4 ms
  - ix. Set CQI Repetition Factor to 2
  - x. Power Ctrl Mode = All Up bits
- d. The transmitted maximum output power was recorded.

The following tests were conducted according to the test requirements outlines in 3GPP TS 34.121 specification. A summary of these settings are illustrated below:

**C.8.1.12 Fixed Reference Channel Definition H-Set 12**

**Table C.8.1.12: Fixed Reference Channel H-Set 12**

Parameter	Unit	Value
Nominal Avg. Inf. Bit Rate	kbps	60
Inter-TTI Distance	TTI's	1
Number of HARQ Processes	Processes	6
Information Bit Payload ( $N_{INF}$ )	Bits	120
Number Code Blocks	Blocks	1
Binary Channel Bits Per TTI	Bits	960
Total Available SML's in UE	SML's	19200
Number of SML's per HARQ Proc.	SML's	3200
Coding Rate		0.15
Number of Physical Channel Codes	Codes	1
Modulation		QPSK
Note 1: The RMC is intended to be used for DC-HSDPA mode and both cells shall transmit with identical parameters as listed in the table. Note 2: Maximum number of transmission is limited to 1, i.e., retransmission is not allowed. The redundancy and constellation version 0 shall be used.		

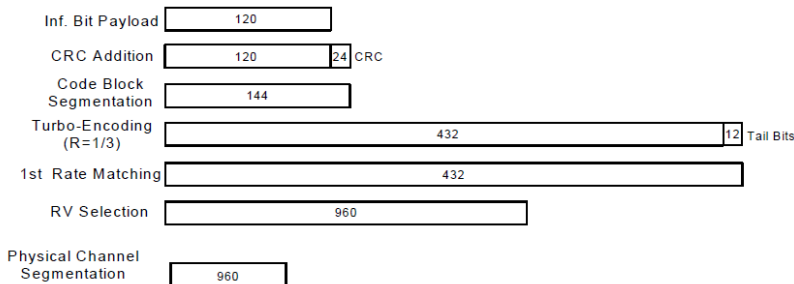

**Figure C.8.19: Coding rate for Fixed reference Channel H-Set 12 (QPSK)**

**Setup Configuration**



**<WCDMA Conducted Power>**

**General Note:**

1. Per KDB 941225 D01v03r01, for SAR testing is measured using a 12.2 kbps RMC with TPC bits configured to all "1's".
2. Per KDB 941225 D01v03r01, RMC 12.2kbps setting is used to evaluate SAR. The maximum output power and tune-up tolerance specified for production units in HSDPA / HSUPA / DC-HSDPA is  $\leq \frac{1}{4}$  dB higher than RMC 12.2Kbps or when the highest reported SAR of the RMC12.2Kbps is scaled by the ratio of specified maximum output power and tune-up tolerance of HSDPA / HSUPA / DC-HSDPA to RMC12.2Kbps and the adjusted SAR is  $\leq 1.2$  W/kg, SAR measurement is not required for HSDPA / HSUPA / DC-HSDPA, and according to the following RF output power, the output power results of the secondary modes (HSUPA, HSDPA, DC-HSDPA) are less than  $\frac{1}{4}$  dB higher than the primary modes; therefore, SAR measurement is not required for HSDPA / HSUPA / DC-HSDPA.

**<Power Level 1 for Full Power Mode>**

Band		WCDMA Band II			Tune-up Limit (dBm)	WCDMA Band IV			Tune-up Limit (dBm)	WCDMA Band V			Tune-up Limit (dBm)
Tx Channel		9262	9400	9538		1312	1413	1513		4132	4182	4233	
Rx Channel		9662	9800	9938		1537	1638	1738		4357	4407	4458	
Frequency (MHz)		1852.4	1880	1907.6	1712.4	1732.6	1752.6	826.4	836.4	846.6			
3GPP Rel 99	AMR 12.2Kbps	24.01	24.09	24.15	24.50	24.03	23.93	24.20	24.50	24.17	24.39	24.46	24.50
3GPP Rel 99	RMC 12.2Kbps	24.03	24.10	<b>24.17</b>	24.50	24.05	23.94	<b>24.21</b>	24.50	24.19	24.41	<b>24.47</b>	24.50
3GPP Rel 6	HSDPA Subtest-1	23.20	23.21	23.31	23.50	23.01	23.20	23.12	23.50	23.01	23.18	23.20	23.50
3GPP Rel 6	HSDPA Subtest-2	23.18	23.20	23.29	23.50	23.04	23.05	23.01	23.50	23.14	23.24	23.24	23.50
3GPP Rel 6	HSDPA Subtest-3	22.59	22.65	22.70	23.00	22.43	22.62	22.71	23.00	22.45	22.65	22.70	23.00
3GPP Rel 6	HSDPA Subtest-4	22.67	22.66	22.64	23.00	22.41	22.48	22.70	23.00	22.56	22.21	22.35	23.00
3GPP Rel 8	DC-HSDPA Subtest-1	23.18	23.20	23.28	23.50	23.01	23.18	23.12	23.50	23.01	23.15	23.18	23.50
3GPP Rel 8	DC-HSDPA Subtest-2	23.15	23.18	23.21	23.50	23.05	23.04	23.11	23.50	23.08	23.18	23.25	23.50
3GPP Rel 8	DC-HSDPA Subtest-3	22.55	22.68	22.68	23.00	22.41	22.58	22.70	23.00	22.41	22.61	22.68	23.00
3GPP Rel 8	DC-HSDPA Subtest-4	22.61	22.65	22.65	23.00	22.43	22.51	22.65	23.00	22.48	22.18	22.66	23.00
3GPP Rel 6	HSUPA Subtest-1	22.63	22.88	23.09	23.50	22.95	22.90	23.01	23.50	23.07	23.27	23.43	24.00
3GPP Rel 6	HSUPA Subtest-2	20.60	20.78	20.91	21.50	20.88	20.77	20.80	21.50	21.16	21.36	21.52	22.00
3GPP Rel 6	HSUPA Subtest-3	21.61	21.91	21.93	22.50	21.90	21.78	21.81	22.50	22.11	22.36	22.52	23.00
3GPP Rel 6	HSUPA Subtest-4	20.67	20.89	20.98	21.50	20.98	20.88	20.90	21.50	21.16	21.44	21.58	22.00
3GPP Rel 6	HSUPA Subtest-5	22.60	22.80	23.00	23.50	22.90	22.80	22.91	23.50	23.00	23.20	23.30	24.00



**<Power Level 2 for Hotspot On/P-Sensor On>**

Band		WCDMA Band II			Tune-up Limit (dBm)	WCDMA Band IV			Tune-up Limit (dBm)
Tx Channel		9262	9400	9538		1312	1413	1513	
Rx Channel		9662	9800	9938		1537	1638	1738	
Frequency (MHz)		1852.4	1880	1907.6		1712.4	1732.6	1752.6	
3GPP Rel 99	AMR 12.2Kbps	18.70	19.07	19.60	20.00	16.15	16.85	17.10	17.50
3GPP Rel 99	RMC 12.2Kbps	18.71	19.09	19.61	20.00	16.17	16.87	17.11	17.50
3GPP Rel 6	HSDPA Subtest-1	17.89	18.21	18.74	19.00	15.16	16.15	16.01	16.50
3GPP Rel 6	HSDPA Subtest-2	17.85	18.19	18.76	19.00	15.21	16.02	15.92	16.50
3GPP Rel 6	HSDPA Subtest-3	17.29	17.62	18.12	18.50	14.55	15.54	15.63	16.00
3GPP Rel 6	HSDPA Subtest-4	17.36	17.66	18.07	18.50	14.56	15.43	15.59	16.00
3GPP Rel 8	DC-HSDPA Subtest-1	17.82	18.18	18.68	19.00	15.13	16.12	16.01	16.50
3GPP Rel 8	DC-HSDPA Subtest-2	17.81	18.11	18.63	19.00	15.18	16.11	16.01	16.50
3GPP Rel 8	DC-HSDPA Subtest-3	17.28	17.65	18.12	18.50	14.63	15.53	15.91	16.00
3GPP Rel 8	DC-HSDPA Subtest-4	17.38	17.55	18.18	18.50	14.72	15.38	15.58	16.00
3GPP Rel 6	HSUPA Subtest-1	17.33	17.85	18.51	19.00	15.07	15.82	15.93	16.50
3GPP Rel 6	HSUPA Subtest-2	15.35	15.78	16.29	17.00	13.03	13.72	13.69	14.50
3GPP Rel 6	HSUPA Subtest-3	16.28	16.90	17.40	18.00	14.07	14.75	14.72	15.50
3GPP Rel 6	HSUPA Subtest-4	15.37	15.86	16.40	17.00	13.10	13.80	13.82	14.50
3GPP Rel 6	HSUPA Subtest-5	17.29	17.80	18.43	19.00	15.05	15.75	15.80	16.50

**<Power Level 3 for Default Power Mode>**

Band		WCDMA Band II			Tune-up Limit (dBm)	WCDMA Band IV			Tune-up Limit (dBm)
Tx Channel		9262	9400	9538		1312	1413	1513	
Rx Channel		9662	9800	9938		1537	1638	1738	
Frequency (MHz)		1852.4	1880	1907.6		1712.4	1732.6	1752.6	
3GPP Rel 99	AMR 12.2Kbps	21.24	21.80	22.24	23.00	23.23	23.49	23.74	24.00
3GPP Rel 99	RMC 12.2Kbps	21.25	21.81	22.28	23.00	23.25	23.51	23.76	24.00
3GPP Rel 6	HSDPA Subtest-1	20.64	21.40	21.84	22.00	21.97	22.31	22.54	23.00
3GPP Rel 6	HSDPA Subtest-2	20.62	21.49	21.89	22.00	22.00	22.41	22.59	23.00
3GPP Rel 6	HSDPA Subtest-3	20.18	20.97	21.35	21.50	21.51	21.95	22.13	22.50
3GPP Rel 6	HSDPA Subtest-4	20.22	20.95	21.44	21.50	21.50	21.96	22.14	22.50
3GPP Rel 8	DC-HSDPA Subtest-1	20.61	21.48	21.81	22.00	21.95	22.28	22.51	23.00
3GPP Rel 8	DC-HSDPA Subtest-2	20.63	21.41	21.83	22.00	21.98	22.38	22.58	23.00
3GPP Rel 8	DC-HSDPA Subtest-3	20.21	20.94	21.43	21.50	21.48	21.96	22.13	22.50
3GPP Rel 8	DC-HSDPA Subtest-4	20.24	20.11	20.74	21.50	21.51	21.98	22.11	22.50
3GPP Rel 6	HSUPA Subtest-1	19.89	20.61	21.24	21.50	22.00	22.37	22.63	23.00
3GPP Rel 6	HSUPA Subtest-2	17.87	18.49	19.10	19.50	20.00	20.43	20.52	21.00
3GPP Rel 6	HSUPA Subtest-3	18.90	19.63	20.11	20.50	21.03	21.45	21.55	22.00
3GPP Rel 6	HSUPA Subtest-4	17.93	18.62	19.13	19.50	20.10	20.43	20.62	21.00
3GPP Rel 6	HSUPA Subtest-5	19.87	20.51	21.19	21.50	22.00	22.40	22.70	23.00



<CDMA2000 Conducted Power>

General Note:

1. Per KDB 941225 D01v03r01, SAR for head exposure is measured in RC3 with the handset configured to transmit at full rate in SO55.
2. Per KDB 941225 D01v03r01, in hotspot mode EUT is treated as data device and SAR is tested with Ev-Do Rev 0 (RTAP 153.6kbps) as the primary mode.
3. Per KDB 941225 D01v03r01, for Body-worn accessory SAR is measured in RC3 with the handset configured in TDSO/SO32 to transmit at full rate on FCH only with all other code channels disabled. The body-worn accessory procedures in KDB Publication 447498 are applied. The 3G SAR test reduction procedure is applied to the multiple code channel configuration (FCH+SCH), with FCH only as the primary mode.

<Full Power Mode>

Band	CDMA2000 BC0			Tune-up Limit (dBm)	CDMA2000 BC1			Tune-up Limit (dBm)	CDMA2000 BC10			Tune-up Limit (dBm)
	Tx Channel	1013	384		777	25	600		1175	476	580	
Frequency (MHz)	824.7	836.52	848.31		1851.25	1880	1908.75		817.9	820.5	823.1	
RC1 SO55	24.04	24.08	24.37	24.50	23.94	23.74	23.93	24.50	24.34	24.36	24.35	24.50
RC3 SO55	24.05	24.10	24.39	24.50	23.69	23.50	23.72	24.50	24.40	24.37	24.38	24.50
RC3 SO32 (F+SCH)	24.06	24.11	24.39	24.50	23.72	23.54	23.67	24.50	24.39	24.37	24.33	24.50
RC3 SO32 (+SCH)	24.09	24.06	24.43	24.50	23.68	23.56	23.63	24.50	24.43	24.37	24.36	24.50
RTAP 153.6Kbps	23.66	23.74	23.98	24.50	23.67	23.49	23.65	24.50	23.91	23.89	23.90	24.50
RETAP 4096Bits	23.67	23.73	23.99	24.50	23.62	23.47	23.66	24.50	23.94	23.92	24.28	24.50

<Power Level 2 for Hotspot On/P-Sensor On>

Band	CDMA2000 BC1			Tune-up Limit (dBm)
Tx Channel	25	600	1175	
Frequency (MHz)	1851.25	1880	1908.75	
RC1 SO55	18.80	19.54	19.67	20.00
RC3 SO55	18.67	19.32	19.54	20.00
RC3 SO32 (F+SCH)	18.56	19.36	19.53	20.00
RC3 SO32 (+SCH)	18.69	19.46	19.68	20.00
RTAP 153.6Kbps	18.96	19.47	19.67	20.00
RETAP 4096Bits	18.70	19.48	19.69	20.00

**<LTE Conducted Power>****General Note:**

1. Anritsu MT8820C base station simulator was used to setup the connection with EUT; the frequency band, channel bandwidth, RB allocation configuration, modulation type are set in the base station simulator to configure EUT transmitting at maximum power and at different configurations which are requested to be reported to FCC, for conducted power measurement and SAR testing.
2. Per KDB 941225 D05v02r05, when a properly configured base station simulator is used for the SAR and power measurements, spectrum plots for each RB allocation and offset configuration is not required.
3. Per KDB 941225 D05v02r05, start with the largest channel bandwidth and measure SAR for QPSK with 1 RB allocation, using the RB offset and required test channel combination with the highest maximum output power for RB offsets at the upper edge, middle and lower edge of each required test channel.
4. Per KDB 941225 D05v02r05, 50% RB allocation for QPSK SAR testing follows 1RB QPSK allocation procedure.
5. Per KDB 941225 D05v02r05, For QPSK with 100% RB allocation, SAR is not required when the highest maximum output power for 100 % RB allocation is less than the highest maximum output power in 50% and 1 RB allocations and the highest reported SAR for 1 RB and 50% RB allocation are  $\leq 0.8$  W/kg. Otherwise, SAR is measured for the highest output power channel; and if the reported SAR is  $> 1.45$  W/kg, the remaining required test channels must also be tested.
6. Per KDB 941225 D05v02r05, 16QAM output power for each RB allocation configuration is  $>$  not  $\frac{1}{2}$  dB higher than the same configuration in QPSK and the reported SAR for the QPSK configuration is  $\leq 1.45$  W/kg; Per KDB 941225 D05v02r05, 16QAM SAR testing is not required.
7. Per KDB 941225 D05v02r05, Smaller bandwidth output power for each RB allocation configuration is  $>$  not  $\frac{1}{2}$  dB higher than the same configuration in the largest supported bandwidth, and the reported SAR for the largest supported bandwidth is  $\leq 1.45$  W/kg; Per KDB 941225 D05v02r05, smaller bandwidth SAR testing is not required.
8. For LTE B4 / B5 / B12 / B13 / B17 / B26 the maximum bandwidth does not support three non-overlapping channels, per KDB 941225 D05v02r05, when a device supports overlapping channel assignment in a channel bandwidth configuration, the middle channel of the group of overlapping channels should be selected for testing.
9. LTE band 17 / 2 / 5 / 38 / 4 SAR test was covered by Band 12 / 25 / 26 / 41 / 66; according to April 2015 TCB workshop, SAR test for overlapping LTE bands can be reduced if
  - a. the maximum output power, including tolerance, for the smaller band is  $\leq$  the larger band to qualify for the SAR test exclusion
  - b. the channel bandwidth and other operating parameters for the smaller band are fully supported by the larger band

**<Power Level 1 for Full Power Mode>**

**<LTE Band 2>**

BW [MHz]	Modulation	RB Size	RB Offset	Power Low Ch. / Freq.	Power Middle Ch. / Freq.	Power High Ch. / Freq.	Tune-up limit (dBm)	MPR (dB)
Channel				18700	18900	19100		
Frequency (MHz)				1860	1880	1900		
20	QPSK	1	0	23.78	23.61	23.53	24.5	0
20	QPSK	1	49	23.79	24.21	24.10		
20	QPSK	1	99	23.36	23.43	23.62		
20	QPSK	50	0	22.77	22.78	22.74	23.5	1
20	QPSK	50	24	22.75	22.70	22.64		
20	QPSK	50	50	22.75	22.71	22.62		
20	QPSK	100	0	22.72	22.74	22.65	23.5	1
20	16QAM	1	0	22.47	22.60	22.76		
20	16QAM	1	49	22.59	22.60	22.66		
20	16QAM	1	99	22.52	22.49	22.52	22.5	2
20	16QAM	50	0	21.77	21.76	21.89		
20	16QAM	50	24	21.87	21.85	21.70		
20	16QAM	50	50	21.94	21.84	21.71	22.5	2
20	16QAM	100	0	21.70	21.84	21.57		
Channel				18675	18900	19125		
Frequency (MHz)				1857.5	1880	1902.5		
15	QPSK	1	0	23.54	23.48	23.65	24.5	0
15	QPSK	1	37	24.11	24.08	23.82		
15	QPSK	1	74	23.61	23.65	23.56		
15	QPSK	36	0	22.69	22.76	22.68	23.5	1
15	QPSK	36	20	22.77	22.80	22.70		
15	QPSK	36	39	22.62	22.77	22.70		
15	QPSK	75	0	22.70	22.77	22.68	23.5	1
15	16QAM	1	0	22.46	22.49	22.48		
15	16QAM	1	37	22.51	22.61	22.63		
15	16QAM	1	74	22.48	22.41	22.56	22.5	2
15	16QAM	36	0	21.72	21.79	21.71		
15	16QAM	36	20	21.64	21.83	21.80		
15	16QAM	36	39	21.81	21.81	21.69	22.5	2
15	16QAM	75	0	21.83	21.90	21.78		



Channel				18650	18900	19150	Tune-up limit (dBm)	MPR (dB)
Frequency (MHz)				1855	1880	1905		
10	QPSK	1	0	23.48	23.53	23.57	24.5	0
10	QPSK	1	25	23.91	24.09	23.94		
10	QPSK	1	49	23.55	23.66	23.81		
10	QPSK	25	0	22.67	22.79	22.67	23.5	1
10	QPSK	25	12	22.65	22.79	22.67		
10	QPSK	25	25	22.68	22.76	22.63		
10	QPSK	50	0	22.71	22.76	22.64	23.5	1
10	16QAM	1	0	22.59	22.57	22.71		
10	16QAM	1	25	22.51	22.56	22.59		
10	16QAM	1	49	22.56	22.57	22.58	22.5	2
10	16QAM	25	0	21.63	21.94	21.77		
10	16QAM	25	12	21.99	21.96	21.76		
10	16QAM	25	25	22.08	21.87	21.70	22.5	2
10	16QAM	50	0	21.60	21.89	21.65		
Channel				18625	18900	19175	Tune-up limit (dBm)	MPR (dB)
Frequency (MHz)				1852.5	1880	1907.5		
5	QPSK	1	0	23.60	23.67	23.67	24.5	0
5	QPSK	1	12	24.11	24.02	23.70		
5	QPSK	1	24	23.53	23.44	23.45		
5	QPSK	12	0	22.60	22.82	22.67	23.5	1
5	QPSK	12	7	22.60	22.73	22.65		
5	QPSK	12	13	22.68	22.76	22.67		
5	QPSK	25	0	22.62	22.72	22.59	23.5	1
5	16QAM	1	0	22.47	22.44	22.53		
5	16QAM	1	12	22.43	22.52	22.53		
5	16QAM	1	24	22.44	22.52	22.38	22.5	2
5	16QAM	12	0	21.57	21.51	21.58		
5	16QAM	12	7	21.82	21.79	21.63		
5	16QAM	12	13	21.91	21.81	21.68	22.5	2
5	16QAM	25	0	21.77	21.62	21.73		



Channel				18615	18900	19185	Tune-up limit (dBm)	MPR (dB)
Frequency (MHz)				1851.5	1880	1908.5		
3	QPSK	1	0	23.46	23.69	23.64	24.5	0
3	QPSK	1	8	23.75	23.98	23.65		
3	QPSK	1	14	23.66	23.81	23.55		
3	QPSK	8	0	22.72	22.90	22.58	23.5	1
3	QPSK	8	4	22.74	22.86	22.67		
3	QPSK	8	7	22.69	22.76	22.71		
3	QPSK	15	0	22.62	22.78	22.66	23.5	1
3	16QAM	1	0	22.55	22.61	22.63		
3	16QAM	1	8	22.45	22.56	22.45		
3	16QAM	1	14	22.53	22.57	22.53	22.5	2
3	16QAM	8	0	21.73	21.86	21.77		
3	16QAM	8	4	21.69	21.86	21.95		
3	16QAM	8	7	21.73	21.90	21.77	22.5	2
3	16QAM	15	0	21.64	21.54	21.47		
Channel				18607	18900	19193	Tune-up limit (dBm)	MPR (dB)
Frequency (MHz)				1850.7	1880	1909.3		
1.4	QPSK	1	0	23.58	23.88	23.66	24.5	0
1.4	QPSK	1	3	23.58	23.88	23.78		
1.4	QPSK	1	5	23.71	23.87	23.46		
1.4	QPSK	3	0	23.71	23.99	23.87		
1.4	QPSK	3	1	23.79	23.85	23.93		
1.4	QPSK	3	3	23.69	23.86	23.76	23.5	1
1.4	QPSK	6	0	22.54	22.85	22.62		
1.4	16QAM	1	0	22.83	22.90	22.50	23.5	1
1.4	16QAM	1	3	22.47	22.62	22.70		
1.4	16QAM	1	5	22.44	22.61	22.80		
1.4	16QAM	3	0	22.60	22.77	22.85		
1.4	16QAM	3	1	22.62	22.74	22.63		
1.4	16QAM	3	3	22.68	22.91	22.69	22.5	2
1.4	16QAM	6	0	21.62	21.89	21.47		



<LTE Band 4>

BW [MHz]	Modulation	RB Size	RB Offset	Power Low Ch. / Freq.	Power Middle Ch. / Freq.	Power High Ch. / Freq.	Tune-up limit (dBm)	MPR (dB)
Channel				20050	20175	20300		
Frequency (MHz)				1720	1732.5	1745		
20	QPSK	1	0	23.46	23.32	23.38	24.5	0
20	QPSK	1	49	23.97	24.02	23.84		
20	QPSK	1	99	23.11	23.42	23.44		
20	QPSK	50	0	22.74	22.77	22.63	23.5	1
20	QPSK	50	24	22.61	22.62	22.49		
20	QPSK	50	50	22.52	22.48	22.33		
20	QPSK	100	0	22.57	22.58	22.54	23.5	1
20	16QAM	1	0	22.52	22.44	22.53		
20	16QAM	1	49	22.37	22.35	22.26		
20	16QAM	1	99	22.13	22.14	22.22	22.5	2
20	16QAM	50	0	21.73	21.70	21.73		
20	16QAM	50	24	21.56	21.57	21.53		
20	16QAM	50	50	21.55	21.65	21.36	22.5	2
20	16QAM	100	0	21.59	21.62	21.59		
Channel				20025	20175	20325		
Frequency (MHz)				1717.5	1732.5	1747.5		
15	QPSK	1	0	23.71	23.46	23.60	24.5	0
15	QPSK	1	37	23.78	23.83	23.46		
15	QPSK	1	74	23.47	23.45	23.37		
15	QPSK	36	0	22.72	22.68	22.60	23.5	1
15	QPSK	36	20	22.64	22.55	22.51		
15	QPSK	36	39	22.61	22.53	22.36		
15	QPSK	75	0	22.58	22.63	22.51	23.5	1
15	16QAM	1	0	22.42	22.32	22.48		
15	16QAM	1	37	22.38	22.28	22.13		
15	16QAM	1	74	22.32	22.22	22.31	22.5	2
15	16QAM	36	0	21.77	21.66	21.54		
15	16QAM	36	20	21.54	21.62	21.46		
15	16QAM	36	39	21.61	21.60	21.36	22.5	2
15	16QAM	75	0	21.65	21.71	21.46		



Channel				20000	20175	20350	Tune-up limit (dBm)	MPR (dB)
Frequency (MHz)				1715	1732.5	1750		
10	QPSK	1	0	23.51	23.15	22.98	24.5	0
10	QPSK	1	25	24.00	23.88	23.67		
10	QPSK	1	49	23.21	23.15	23.19		
10	QPSK	25	0	22.76	22.53	22.45	23.5	1
10	QPSK	25	12	22.68	22.54	22.39		
10	QPSK	25	25	22.57	22.54	22.37		
10	QPSK	50	0	22.71	22.54	22.42	23.5	1
10	16QAM	1	0	22.49	22.23	22.00		
10	16QAM	1	25	22.29	22.23	22.23		
10	16QAM	1	49	22.27	22.01	22.00	22.5	2
10	16QAM	25	0	21.74	21.54	21.50		
10	16QAM	25	12	21.75	21.47	21.45		
10	16QAM	25	25	21.54	21.44	21.34	22.5	2
10	16QAM	50	0	21.68	21.62	21.57		
Channel				19975	20175	20375	Tune-up limit (dBm)	MPR (dB)
Frequency (MHz)				1712.5	1732.5	1752.5		
5	QPSK	1	0	23.36	23.11	22.82	24.5	0
5	QPSK	1	12	23.70	23.76	23.45		
5	QPSK	1	24	23.37	23.34	23.27		
5	QPSK	12	0	22.73	22.57	22.32	23.5	1
5	QPSK	12	7	22.71	22.58	22.39		
5	QPSK	12	13	22.68	22.63	22.47		
5	QPSK	25	0	22.71	22.61	22.30	23.5	1
5	16QAM	1	0	22.43	22.35	22.19		
5	16QAM	1	12	22.11	22.23	22.13		
5	16QAM	1	24	22.27	22.18	22.34	22.5	2
5	16QAM	12	0	21.71	21.52	21.37		
5	16QAM	12	7	21.88	21.68	21.33		
5	16QAM	12	13	21.85	21.62	21.45	22.5	2
5	16QAM	25	0	21.79	21.61	21.47		



Channel				19965	20175	20385	Tune-up limit (dBm)	MPR (dB)
Frequency (MHz)				1711.5	1732.5	1753.5		
3	QPSK	1	0	23.46	22.98	22.99	24.5	0
3	QPSK	1	8	23.58	23.21	23.33		
3	QPSK	1	14	22.63	22.51	22.59		
3	QPSK	8	0	22.31	22.12	22.13	23.5	1
3	QPSK	8	4	22.12	22.00	22.11		
3	QPSK	8	7	22.68	22.15	22.40		
3	QPSK	15	0	22.60	22.58	22.27	23.5	1
3	16QAM	1	0	22.41	22.43	21.97		
3	16QAM	1	8	22.13	22.25	21.95		
3	16QAM	1	14	22.47	22.38	22.24	22.5	2
3	16QAM	8	0	21.66	21.62	21.28		
3	16QAM	8	4	21.71	21.51	21.38		
3	16QAM	8	7	21.84	21.65	21.44	22.5	2
3	16QAM	15	0	21.89	21.59	20.98		
Channel				19957	20175	20393	Tune-up limit (dBm)	MPR (dB)
Frequency (MHz)				1710.7	1732.5	1754.3		
1.4	QPSK	1	0	23.59	23.47	23.22	24.5	0
1.4	QPSK	1	3	23.66	23.63	23.42		
1.4	QPSK	1	5	23.54	23.46	23.44		
1.4	QPSK	3	0	23.66	23.65	23.43		
1.4	QPSK	3	1	23.86	23.69	23.45		
1.4	QPSK	3	3	23.65	23.63	23.44		
1.4	QPSK	6	0	22.64	22.56	22.35	23.5	1
1.4	16QAM	1	0	22.43	22.37	22.17	23.5	1
1.4	16QAM	1	3	22.40	22.62	22.18		
1.4	16QAM	1	5	22.49	22.34	22.31		
1.4	16QAM	3	0	22.79	22.55	22.04		
1.4	16QAM	3	1	22.66	22.63	21.96		
1.4	16QAM	3	3	22.73	22.81	22.34		
1.4	16QAM	6	0	21.67	21.51	21.28	22.5	2



<LTE Band 5>

BW [MHz]	Modulation	RB Size	RB Offset	Power Low Ch. / Freq.	Power Middle Ch. / Freq.	Power High Ch. / Freq.	Tune-up limit (dBm)	MPR (dB)
Channel				20450	20525	20600		
Frequency (MHz)				829	836.5	844		
10	QPSK	1	0	23.56	23.58	23.34	24.5	0
10	QPSK	1	25	23.80	23.89	24.02		
10	QPSK	1	49	23.21	23.35	23.36		
10	QPSK	25	0	22.69	22.65	22.68	23.5	1
10	QPSK	25	12	22.62	22.58	22.65		
10	QPSK	25	25	22.59	22.55	22.58		
10	QPSK	50	0	22.58	22.64	22.66	23.5	1
10	16QAM	1	0	22.28	22.38	22.38		
10	16QAM	1	25	22.36	22.41	22.38		
10	16QAM	1	49	22.38	22.33	22.38	22.5	2
10	16QAM	25	0	21.56	21.75	21.57		
10	16QAM	25	12	21.59	21.68	21.58		
10	16QAM	25	25	21.84	21.83	21.63	22.5	2
10	16QAM	50	0	21.56	21.55	21.57		
Channel				20425	20525	20625		
Frequency (MHz)				826.5	836.5	846.5		
5	QPSK	1	0	23.41	23.15	23.26	24.5	0
5	QPSK	1	12	23.77	23.72	23.74		
5	QPSK	1	24	23.31	23.15	23.28		
5	QPSK	12	0	22.65	22.58	22.71	23.5	1
5	QPSK	12	7	22.63	22.59	22.69		
5	QPSK	12	13	22.64	22.53	22.68		
5	QPSK	25	0	22.64	22.58	22.67	23.5	1
5	16QAM	1	0	22.25	22.36	22.37		
5	16QAM	1	12	22.74	22.37	22.39		
5	16QAM	1	24	22.44	22.27	22.37	22.5	2
5	16QAM	12	0	21.49	21.43	21.50		
5	16QAM	12	7	21.64	21.69	21.60		
5	16QAM	12	13	21.55	21.52	21.68	22.5	2
5	16QAM	25	0	21.75	21.51	21.63		



Channel				20415	20525	20635	Tune-up limit (dBm)	MPR (dB)
Frequency (MHz)				825.5	836.5	847.5		
3	QPSK	1	0	23.32	23.33	23.34	24.5	0
3	QPSK	1	8	23.56	23.57	23.84		
3	QPSK	1	14	23.52	23.45	23.27		
3	QPSK	8	0	22.72	22.77	22.84	23.5	1
3	QPSK	8	4	22.65	22.61	22.68		
3	QPSK	8	7	22.61	22.56	22.68		
3	QPSK	15	0	22.61	22.61	22.67	23.5	1
3	16QAM	1	0	22.35	22.31	22.51		
3	16QAM	1	8	22.47	22.38	22.40		
3	16QAM	1	14	22.47	22.67	22.41	22.5	2
3	16QAM	8	0	21.63	21.53	21.62		
3	16QAM	8	4	21.64	21.43	21.72		
3	16QAM	8	7	21.67	21.49	21.64	22.5	2
3	16QAM	15	0	21.53	21.51	21.60		
Channel				20407	20525	20643	Tune-up limit (dBm)	MPR (dB)
Frequency (MHz)				824.7	836.5	848.3		
1.4	QPSK	1	0	23.35	23.58	23.65	24.5	0
1.4	QPSK	1	3	23.46	23.62	23.69		
1.4	QPSK	1	5	23.62	23.62	23.54		
1.4	QPSK	3	0	23.66	23.64	23.68		
1.4	QPSK	3	1	23.59	23.77	23.75		
1.4	QPSK	3	3	23.48	23.63	23.74	23.5	1
1.4	QPSK	6	0	22.50	22.52	22.69		
1.4	16QAM	1	0	22.25	22.36	22.38	23.5	1
1.4	16QAM	1	3	22.36	22.42	22.48		
1.4	16QAM	1	5	22.47	22.21	22.34		
1.4	16QAM	3	0	22.38	22.52	22.68		
1.4	16QAM	3	1	22.41	22.51	22.62		
1.4	16QAM	3	3	22.51	22.44	22.91	22.5	2
1.4	16QAM	6	0	21.50	21.42	21.66		



<LTE Band 7>

BW [MHz]	Modulation	RB Size	RB Offset	Power Low Ch. / Freq.	Power Middle Ch. / Freq.	Power High Ch. / Freq.	Tune-up limit (dBm)	MPR (dB)
Channel				20850	21100	21350		
Frequency (MHz)				2510	2535	2560		
20	QPSK	1	0	23.39	23.46	23.58	24.5	0
20	QPSK	1	49	23.68	24.23	24.05		
20	QPSK	1	99	23.48	23.86	23.44		
20	QPSK	50	0	22.81	22.93	22.83	23.5	1
20	QPSK	50	24	22.77	22.84	22.77		
20	QPSK	50	50	22.72	22.83	22.79		
20	QPSK	100	0	22.85	22.87	22.79	23.5	1
20	16QAM	1	0	22.61	22.68	22.71		
20	16QAM	1	49	22.55	22.64	22.52		
20	16QAM	1	99	22.52	22.54	22.35	22.5	2
20	16QAM	50	0	21.82	21.81	21.74		
20	16QAM	50	24	21.77	21.82	21.64		
20	16QAM	50	50	21.76	21.78	21.61	22.5	2
20	16QAM	100	0	21.81	21.82	21.71		
Channel				20825	21100	21375		
Frequency (MHz)				2507.5	2535	2562.5		
15	QPSK	1	0	23.78	23.71	23.44	24.5	0
15	QPSK	1	37	24.04	24.13	23.93		
15	QPSK	1	74	23.75	23.79	23.61		
15	QPSK	36	0	22.97	22.90	22.76	23.5	1
15	QPSK	36	20	22.92	22.93	22.81		
15	QPSK	36	39	22.82	22.81	22.84		
15	QPSK	75	0	22.85	22.91	22.83	23.5	1
15	16QAM	1	0	22.72	22.68	22.56		
15	16QAM	1	37	22.56	22.68	22.51		
15	16QAM	1	74	22.56	22.65	22.57	22.5	2
15	16QAM	36	0	21.80	21.76	21.66		
15	16QAM	36	20	21.75	21.77	21.79		
15	16QAM	36	39	21.70	21.74	21.68	22.5	2
15	16QAM	75	0	21.83	21.88	21.73		



Channel				20800	21100	21400	Tune-up limit (dBm)	MPR (dB)
Frequency (MHz)				2505	2535	2565		
10	QPSK	1	0	23.54	23.63	23.48	24.5	0
10	QPSK	1	25	24.08	24.15	24.11		
10	QPSK	1	49	23.61	23.60	23.75		
10	QPSK	25	0	22.87	22.90	22.82	23.5	1
10	QPSK	25	12	22.87	22.88	22.81		
10	QPSK	25	25	22.84	22.90	22.76		
10	QPSK	50	0	22.96	22.87	22.87	23.5	1
10	16QAM	1	0	22.63	22.46	22.56		
10	16QAM	1	25	22.59	22.71	22.58		
10	16QAM	1	49	22.55	22.63	22.56	22.5	2
10	16QAM	25	0	21.79	21.84	21.76		
10	16QAM	25	12	21.94	21.89	21.85		
10	16QAM	25	25	22.11	21.96	21.75	22.5	2
10	16QAM	50	0	21.73	21.85	21.71		
Channel				20775	21100	21425	Tune-up limit (dBm)	MPR (dB)
Frequency (MHz)				2502.5	2535	2567.5		
5	QPSK	1	0	23.69	23.43	23.36	24.5	0
5	QPSK	1	12	24.12	24.10	23.94		
5	QPSK	1	24	23.59	23.54	23.34		
5	QPSK	12	0	22.79	22.96	22.79	23.5	1
5	QPSK	12	7	22.97	22.97	22.78		
5	QPSK	12	13	22.95	22.89	22.77		
5	QPSK	25	0	22.89	22.89	22.76	23.5	1
5	16QAM	1	0	22.53	22.63	22.44		
5	16QAM	1	12	22.54	22.59	22.49		
5	16QAM	1	24	22.58	22.55	22.40	22.5	2
5	16QAM	12	0	21.96	21.76	21.62		
5	16QAM	12	7	21.94	21.91	21.88		
5	16QAM	12	13	21.82	21.78	21.91	22.5	2
5	16QAM	25	0	21.96	21.86	21.80		



<LTE Band 12>

BW [MHz]	Modulation	RB Size	RB Offset	Power Low Ch. / Freq.	Power Middle Ch. / Freq.	Power High Ch. / Freq.	Tune-up limit (dBm)	MPR (dB)
Channel				23060	23095	23130		
Frequency (MHz)				704	707.5	711		
10	QPSK	1	0	23.49	23.50	23.68	24.5	0
10	QPSK	1	25	23.83	23.85	24.44		
10	QPSK	1	49	23.58	23.71	23.64		
10	QPSK	25	0	22.97	22.99	23.02	23.5	1
10	QPSK	25	12	22.85	22.96	22.96		
10	QPSK	25	25	22.81	22.98	23.01		
10	QPSK	50	0	22.93	22.94	23.01	23.5	1
10	16QAM	1	0	22.51	22.51	22.68		
10	16QAM	1	25	22.68	22.72	22.79		
10	16QAM	1	49	22.66	22.71	22.70	22.5	2
10	16QAM	25	0	21.97	21.94	21.96		
10	16QAM	25	12	21.80	21.94	22.19		
10	16QAM	25	25	22.22	21.96	21.89	22.5	2
10	16QAM	25	0	21.88	21.90	21.92		
10	16QAM	50	0	21.88	21.90	21.92		
Channel				23035	23095	23155	Tune-up limit (dBm)	MPR (dB)
Frequency (MHz)				701.5	707.5	713.5		
5	QPSK	1	0	23.51	23.54	23.66	24.5	0
5	QPSK	1	12	24.11	24.26	24.00		
5	QPSK	1	24	23.60	23.58	23.55		
5	QPSK	12	0	22.90	22.98	23.00	23.5	1
5	QPSK	12	7	22.98	23.05	22.94		
5	QPSK	12	13	22.88	22.91	22.98		
5	QPSK	25	0	22.97	22.95	22.93	23.5	1
5	16QAM	1	0	22.70	22.67	22.75		
5	16QAM	1	12	23.04	22.68	22.76		
5	16QAM	1	24	22.67	22.55	22.61	22.5	2
5	16QAM	12	0	21.92	21.87	21.79		
5	16QAM	12	7	21.88	22.03	21.87		
5	16QAM	12	13	21.78	21.89	21.73	22.5	2
5	16QAM	12	0	21.96	22.12	21.92		



Channel				23025	23095	23165	Tune-up limit (dBm)	MPR (dB)
Frequency (MHz)				700.5	707.5	714.5		
3	QPSK	1	0	23.61	23.84	23.72	24.5	0
3	QPSK	1	8	23.96	24.11	24.01		
3	QPSK	1	14	23.79	23.98	23.84		
3	QPSK	8	0	22.97	23.01	23.04	23.5	1
3	QPSK	8	4	23.01	22.97	22.95		
3	QPSK	8	7	23.00	22.93	23.04		
3	QPSK	15	0	23.07	22.97	23.02	23.5	1
3	16QAM	1	0	23.09	22.79	22.88		
3	16QAM	1	8	22.75	22.47	22.64		
3	16QAM	1	14	22.76	22.70	22.79	22.5	2
3	16QAM	8	0	22.00	21.95	22.08		
3	16QAM	8	4	21.95	22.02	22.16		
3	16QAM	8	7	21.95	21.98	22.11	22.5	2
3	16QAM	15	0	21.88	21.94	21.95		
Channel				23017	23095	23173	Tune-up limit (dBm)	MPR (dB)
Frequency (MHz)				699.7	707.5	715.3		
1.4	QPSK	1	0	23.89	23.95	23.87	24.5	0
1.4	QPSK	1	3	23.96	24.02	23.89		
1.4	QPSK	1	5	23.99	23.87	23.88		
1.4	QPSK	3	0	24.00	23.96	23.93		
1.4	QPSK	3	1	24.09	24.01	24.05		
1.4	QPSK	3	3	23.98	23.99	24.07		
1.4	QPSK	6	0	22.96	23.00	22.99	23.5	1
1.4	16QAM	1	0	22.85	22.81	22.97	23.5	1
1.4	16QAM	1	3	22.73	23.20	22.65		
1.4	16QAM	1	5	22.78	22.75	22.72		
1.4	16QAM	3	0	22.96	22.92	22.76		
1.4	16QAM	3	1	22.98	22.99	22.97		
1.4	16QAM	3	3	23.01	23.00	23.18		
1.4	16QAM	6	0	21.86	21.89	21.93	22.5	2



<LTE Band 13>

BW [MHz]	Modulation	RB Size	RB Offset	Power Low Ch. / Freq.	Power Middle Ch. / Freq.	Power High Ch. / Freq.	Tune-up limit (dBm)	MPR (dB)
Channel				23230				
Frequency (MHz)				782				
10	QPSK	1	0		23.69		24.5	0
10	QPSK	1	25		24.24			
10	QPSK	1	49		23.53			
10	QPSK	25	0		22.81		23.5	1
10	QPSK	25	12		22.77			
10	QPSK	25	25		22.78			
10	QPSK	50	0		22.76		23.5	1
10	16QAM	1	0		22.64			
10	16QAM	1	25		22.60			
10	16QAM	1	49		22.61		22.5	2
10	16QAM	25	0		21.71			
10	16QAM	25	12		21.95			
10	16QAM	25	25		21.69		22.5	2
10	16QAM	50	0		21.78			
Channel				23205	23230	23255		
Frequency (MHz)				779.5	782	784.5		
5	QPSK	1	0	23.56	23.33	23.61	24.5	0
5	QPSK	1	12	23.61	24.13	23.86		
5	QPSK	1	24	23.58	23.59	23.61		
5	QPSK	12	0	22.79	22.80	22.77	23.5	1
5	QPSK	12	7	22.85	22.83	22.76		
5	QPSK	12	13	22.80	22.77	22.88		
5	QPSK	25	0	22.82	22.84	22.74	23.5	1
5	16QAM	1	0	22.62	22.57	22.61		
5	16QAM	1	12	22.71	22.29	22.69		
5	16QAM	1	24	22.61	22.56	22.59	22.5	2
5	16QAM	12	0	21.88	21.91	21.85		
5	16QAM	12	7	21.71	21.84	21.71		
5	16QAM	12	13	21.64	21.91	21.74	22.5	2
5	16QAM	25	0	21.84	21.68	21.67		



<LTE Band 17>

BW [MHz]	Modulation	RB Size	RB Offset	Power Low Ch. / Freq.	Power Middle Ch. / Freq.	Power High Ch. / Freq.	Tune-up limit (dBm)	MPR (dB)
Channel				23780	23790	23800		
Frequency (MHz)				709	710	711		
10	QPSK	1	0	23.52	23.41	23.53	24.5	0
10	QPSK	1	25	24.10	24.04	23.92		
10	QPSK	1	49	23.54	23.55	23.43		
10	QPSK	25	0	22.84	22.81	22.78	23.5	1
10	QPSK	25	12	22.81	22.76	22.75		
10	QPSK	25	25	22.80	22.77	22.71		
10	QPSK	50	0	22.78	22.74	22.73	23.5	1
10	16QAM	1	0	22.54	22.46	22.39		
10	16QAM	1	25	22.56	22.51	22.41		
10	16QAM	1	49	22.54	22.43	22.40	22.5	2
10	16QAM	25	0	21.73	21.66	21.75		
10	16QAM	25	12	21.79	21.70	21.74		
10	16QAM	25	25	21.98	21.70	21.69	22.5	2
10	16QAM	50	0	21.85	21.73	21.71		
Channel				23755	23790	23825		
Frequency (MHz)				706.5	710	713.5		
5	QPSK	1	0	23.34	23.56	23.45	24.5	0
5	QPSK	1	12	24.09	24.09	24.00		
5	QPSK	1	24	23.51	23.36	23.36		
5	QPSK	12	0	22.77	22.74	22.69	23.5	1
5	QPSK	12	7	22.75	22.78	22.76		
5	QPSK	12	13	22.76	22.76	22.67		
5	QPSK	25	0	22.80	22.72	22.69	23.5	1
5	16QAM	1	0	22.37	22.40	22.33		
5	16QAM	1	12	22.45	22.41	22.15		
5	16QAM	1	24	22.37	22.39	22.41	22.5	2
5	16QAM	12	0	21.64	21.84	21.59		
5	16QAM	12	7	21.90	21.77	21.69		
5	16QAM	12	13	21.68	21.83	21.76	22.5	2
5	16QAM	25	0	21.86	21.91	21.71		



<LTE Band 25>

BW [MHz]	Modulation	RB Size	RB Offset	Power Low Ch. / Freq.	Power Middle Ch. / Freq.	Power High Ch. / Freq.	Tune-up limit (dBm)	MPR (dB)
Channel				26140	26340	26590		
Frequency (MHz)				1860	1880	1905		
20	QPSK	1	0	23.42	23.44	23.47	24.5	0
20	QPSK	1	49	24.15	23.94	23.63		
20	QPSK	1	99	23.49	23.36	22.80		
20	QPSK	50	0	22.87	22.72	22.64	23.5	1
20	QPSK	50	24	22.65	22.74	22.67		
20	QPSK	50	50	22.63	22.71	22.62		
20	QPSK	100	0	22.78	22.71	22.63	23.5	1
20	16QAM	1	0	22.54	22.56	22.34		
20	16QAM	1	49	22.40	22.62	22.50		
20	16QAM	1	99	22.35	22.54	22.13	22.5	2
20	16QAM	50	0	21.82	21.97	21.70		
20	16QAM	50	24	21.79	21.83	21.65		
20	16QAM	50	50	21.67	21.65	21.63	22.5	2
20	16QAM	100	0	21.65	21.84	21.61		
Channel				26115	26340	26615		
Frequency (MHz)				1857.5	1880	1907.5		
15	QPSK	1	0	23.46	23.91	23.69	24.5	0
15	QPSK	1	37	23.78	23.74	24.11		
15	QPSK	1	74	23.71	23.57	22.71		
15	QPSK	36	0	22.69	22.88	22.74	23.5	1
15	QPSK	36	20	22.76	22.75	22.67		
15	QPSK	36	39	22.74	22.75	22.70		
15	QPSK	75	0	22.72	22.86	22.68	23.5	1
15	16QAM	1	0	22.75	22.69	22.60		
15	16QAM	1	37	22.61	22.58	22.52		
15	16QAM	1	74	22.41	22.65	22.04	23.5	1
15	16QAM	36	0	21.79	21.87	21.69		
15	16QAM	36	20	21.77	21.77	21.65		
15	16QAM	36	39	21.74	21.87	21.54	22.5	2
15	16QAM	75	0	21.82	21.78	21.71		
15	16QAM	75	0	21.82	21.78	21.71		



Channel				26090	26340	26640	Tune-up limit (dBm)	MPR (dB)
Frequency (MHz)				1855	1880	1910		
10	QPSK	1	0	23.55	23.80	23.38	24.5	0
10	QPSK	1	25	23.68	23.80	23.46		
10	QPSK	1	49	23.43	23.60	22.99		
10	QPSK	25	0	22.71	22.83	22.68	23.5	1
10	QPSK	25	12	22.72	22.80	22.62		
10	QPSK	25	25	22.71	22.72	22.62		
10	QPSK	50	0	22.77	22.76	22.63	23.5	1
10	16QAM	1	0	22.78	22.66	22.51		
10	16QAM	1	25	22.60	22.62	22.54		
10	16QAM	1	49	22.44	22.71	22.32	22.5	2
10	16QAM	25	0	21.74	21.83	21.70		
10	16QAM	25	12	21.74	21.83	21.71		
10	16QAM	25	25	21.81	21.65	21.71	22.5	2
10	16QAM	50	0	21.76	21.64	21.47		
Channel				26065	26340	26665	Tune-up limit (dBm)	MPR (dB)
Frequency (MHz)				1852.5	1880	1912.5		
5	QPSK	1	0	23.66	23.51	23.46	24.5	0
5	QPSK	1	12	23.87	23.69	23.60		
5	QPSK	1	24	23.34	23.54	23.24		
5	QPSK	12	0	22.76	22.64	22.63	23.5	1
5	QPSK	12	7	22.80	22.74	22.63		
5	QPSK	12	13	22.74	22.72	22.64		
5	QPSK	25	0	22.68	22.78	22.63	23.5	1
5	16QAM	1	0	22.65	22.89	22.72		
5	16QAM	1	12	22.53	22.62	22.46		
5	16QAM	1	24	22.49	22.50	22.49	22.5	2
5	16QAM	12	0	21.60	21.74	21.65		
5	16QAM	12	7	21.56	21.83	21.80		
5	16QAM	12	13	21.59	21.72	21.83	22.5	2
5	16QAM	25	0	21.69	21.69	21.57		



Channel				26055	26340	26675	Tune-up limit (dBm)	MPR (dB)
Frequency (MHz)				1851.5	1880	1913.5		
3	QPSK	1	0	23.72	23.60	23.67	24.5	0
3	QPSK	1	8	23.81	23.85	23.78		
3	QPSK	1	14	23.31	23.52	23.45		
3	QPSK	8	0	22.96	22.82	23.01	23.5	1
3	QPSK	8	4	22.89	22.77	22.58		
3	QPSK	8	7	22.65	22.71	22.64		
3	QPSK	15	0	22.65	22.72	22.60	23.5	1
3	16QAM	1	0	22.45	22.57	22.63		
3	16QAM	1	8	22.47	23.01	22.50		
3	16QAM	1	14	22.55	22.55	22.41	22.5	2
3	16QAM	8	0	21.79	21.81	21.76		
3	16QAM	8	4	21.70	21.84	21.64		
3	16QAM	8	7	21.78	21.84	21.73	22.5	2
3	16QAM	15	0	21.78	21.75	21.37		
Channel				26047	26340	26683	Tune-up limit (dBm)	MPR (dB)
Frequency (MHz)				1850.7	1880	1914.3		
1.4	QPSK	1	0	23.50	23.73	23.56	24.5	0
1.4	QPSK	1	3	23.69	23.78	23.58		
1.4	QPSK	1	5	23.49	23.77	23.47		
1.4	QPSK	3	0	23.90	23.73	23.62		
1.4	QPSK	3	1	23.83	23.76	23.71		
1.4	QPSK	3	3	23.88	23.86	23.60		
1.4	QPSK	6	0	22.67	22.74	22.63	23.5	1
1.4	16QAM	1	0	22.57	22.59	22.48	23.5	1
1.4	16QAM	1	3	22.57	22.55	22.46		
1.4	16QAM	1	5	22.45	22.56	22.51		
1.4	16QAM	3	0	22.71	22.86	22.55		
1.4	16QAM	3	1	22.73	22.90	22.53		
1.4	16QAM	3	3	22.80	22.98	22.76		
1.4	16QAM	6	0	21.57	21.80	21.41	22.5	2



<LTE Band 26>

BW [MHz]	Modulation	RB Size	RB Offset	Power Low Ch. / Freq.	Power Middle Ch. / Freq.	Power High Ch. / Freq.	Tune-up limit (dBm)	MPR (dB)
Channel				26765	26865	26965		
Frequency (MHz)				821.5	831.5	841.5		
15	QPSK	1	0	23.65	23.78	23.76	24.5	0
15	QPSK	1	37	24.19	23.85	24.28		
15	QPSK	1	74	23.70	23.76	23.71		
15	QPSK	36	0	22.81	22.85	22.88	23.5	1
15	QPSK	36	20	22.71	22.79	22.83		
15	QPSK	36	39	22.77	22.71	22.85		
15	QPSK	75	0	22.79	22.81	22.83	23.5	1
15	16QAM	1	0	22.66	22.62	22.62		
15	16QAM	1	37	22.59	22.64	22.57		
15	16QAM	1	74	22.70	22.59	22.52	22.5	2
15	16QAM	36	0	21.76	21.76	21.75		
15	16QAM	36	20	21.74	21.76	21.81		
15	16QAM	36	39	21.84	21.70	21.85	22.5	2
15	16QAM	75	0	21.82	21.70	21.80		
Channel				26740	26865	26990		
Frequency (MHz)				819	831.5	844		
10	QPSK	1	0	23.61	23.60	23.54	24.5	0
10	QPSK	1	25	23.99	24.08	24.06		
10	QPSK	1	49	23.80	23.54	23.53		
10	QPSK	25	0	22.78	22.80	22.84	23.5	1
10	QPSK	25	12	22.87	22.83	22.87		
10	QPSK	25	25	22.77	22.78	22.78		
10	QPSK	50	0	22.86	22.78	22.83	23.5	1
10	16QAM	1	0	22.67	22.69	22.64		
10	16QAM	1	25	22.59	22.67	22.52		
10	16QAM	1	49	22.59	22.55	22.54	22.5	2
10	16QAM	25	0	22.06	22.02	21.84		
10	16QAM	25	12	21.85	21.73	21.91		
10	16QAM	25	25	21.73	21.69	21.98	22.5	2
10	16QAM	50	0	21.86	21.80	21.86		



Channel				26715	26865	27015	Tune-up limit (dBm)	MPR (dB)
Frequency (MHz)				816.5	831.5	846.5		
5	QPSK	1	0	23.59	23.36	23.52	24.5	0
5	QPSK	1	12	24.12	24.06	24.03		
5	QPSK	1	24	23.44	23.35	23.38		
5	QPSK	12	0	22.84	22.92	22.81	23.5	1
5	QPSK	12	7	22.89	22.81	22.88		
5	QPSK	12	13	22.87	22.80	22.82		
5	QPSK	25	0	22.82	22.82	22.80		
5	16QAM	1	0	22.61	22.58	22.56	23.5	1
5	16QAM	1	12	22.57	22.64	22.46		
5	16QAM	1	24	22.53	22.43	22.45		
5	16QAM	12	0	21.76	21.67	21.72	22.5	2
5	16QAM	12	7	21.88	21.86	21.93		
5	16QAM	12	13	21.79	21.92	21.93		
5	16QAM	25	0	21.82	21.77	21.90		
Channel				26705	26865	27025	Tune-up limit (dBm)	MPR (dB)
Frequency (MHz)				815.5	831.5	847.5		
3	QPSK	1	0	23.87	23.73	23.46	24.5	0
3	QPSK	1	8	24.00	23.88	23.69		
3	QPSK	1	14	23.82	23.70	23.49		
3	QPSK	8	0	22.83	23.05	22.81	23.5	1
3	QPSK	8	4	22.83	22.83	22.82		
3	QPSK	8	7	22.86	22.75	22.85		
3	QPSK	15	0	22.83	22.75	22.83		
3	16QAM	1	0	22.93	22.72	22.61	23.5	1
3	16QAM	1	8	22.56	22.68	22.52		
3	16QAM	1	14	22.60	22.55	22.63		
3	16QAM	8	0	21.85	22.00	21.96	22.5	2
3	16QAM	8	4	21.89	21.89	21.87		
3	16QAM	8	7	21.80	21.90	21.90		
3	16QAM	15	0	21.77	21.78	21.75		
Channel				26697	26865	27033	Tune-up limit (dBm)	MPR (dB)
Frequency (MHz)				814.7	831.5	848.3		
1.4	QPSK	1	0	23.81	23.70	23.85	24.5	0
1.4	QPSK	1	3	23.83	23.91	23.83		
1.4	QPSK	1	5	23.84	23.77	23.75		
1.4	QPSK	3	0	23.85	23.89	24.08		
1.4	QPSK	3	1	23.90	23.96	23.99		
1.4	QPSK	3	3	23.93	23.96	23.79		
1.4	QPSK	6	0	22.75	22.89	22.84	23.5	1
1.4	16QAM	1	0	22.68	22.75	22.62	23.5	1
1.4	16QAM	1	3	22.56	22.62	22.57		
1.4	16QAM	1	5	22.68	22.58	22.44		
1.4	16QAM	3	0	22.83	22.74	23.10		
1.4	16QAM	3	1	22.82	22.84	23.08		
1.4	16QAM	3	3	22.91	22.93	23.14		
1.4	16QAM	6	0	21.89	21.88	21.77	22.5	2



<LTE Band 66>

BW [MHz]	Modulation	RB Size	RB Offset	Power Low Ch. / Freq.	Power Middle Ch. / Freq.	Power High Ch. / Freq.	Tune-up limit (dBm)	MPR (dB)
Channel				132072	132322	132572		
Frequency (MHz)				1720	1745	1770		
20	QPSK	1	0	23.41	23.50	23.78	24.5	0
20	QPSK	1	49	24.22	24.34	24.04		
20	QPSK	1	99	23.36	23.82	23.63		
20	QPSK	50	0	22.80	22.87	22.80	23.5	1
20	QPSK	50	24	22.74	22.86	22.75		
20	QPSK	50	50	22.68	22.83	22.71		
20	QPSK	100	0	22.70	22.85	22.81	23.5	1
20	16QAM	1	0	22.54	22.65	22.63		
20	16QAM	1	49	22.50	22.63	22.53		
20	16QAM	1	99	22.36	22.57	22.43	22.5	2
20	16QAM	50	0	21.78	21.75	21.69		
20	16QAM	50	24	21.67	21.88	21.72		
20	16QAM	50	50	21.60	21.73	21.63	22.5	2
20	16QAM	100	0	21.74	21.86	21.72		
20	16QAM	100	0	21.74	21.86	21.72		
Channel				132047	132322	132597		
Frequency (MHz)				1717.5	1745	1772.5		
15	QPSK	1	0	23.62	23.44	23.69	24.5	0
15	QPSK	1	37	24.01	24.03	23.89		
15	QPSK	1	74	23.66	23.90	23.65		
15	QPSK	36	0	22.63	22.82	22.82	23.5	1
15	QPSK	36	20	22.65	22.81	22.75		
15	QPSK	36	39	22.69	22.81	22.71		
15	QPSK	75	0	22.65	22.77	22.78	23.5	1
15	16QAM	1	0	22.55	22.60	22.49		
15	16QAM	1	37	22.44	22.52	22.42		
15	16QAM	1	74	22.36	22.52	22.43	22.5	2
15	16QAM	36	0	21.52	21.65	21.73		
15	16QAM	36	20	21.56	21.74	21.69		
15	16QAM	36	39	21.54	21.74	21.78	22.5	2
15	16QAM	75	0	21.69	21.75	21.74		



Channel				132022	132322	132622	Tune-up limit (dBm)	MPR (dB)
Frequency (MHz)				1715	1745	1775		
10	QPSK	1	0	23.39	23.44	23.53	24.5	0
10	QPSK	1	25	23.92	24.24	23.58		
10	QPSK	1	49	23.30	23.77	23.36		
10	QPSK	25	0	22.69	22.72	22.75	23.5	1
10	QPSK	25	12	22.69	22.88	22.74		
10	QPSK	25	25	22.66	22.81	22.71		
10	QPSK	50	0	22.69	22.84	22.75	23.5	1
10	16QAM	1	0	22.43	22.27	22.53		
10	16QAM	1	25	22.42	22.57	22.46		
10	16QAM	1	49	22.32	22.56	22.34	22.5	2
10	16QAM	25	0	21.87	21.80	21.76		
10	16QAM	25	12	21.79	21.99	21.69		
10	16QAM	25	25	21.67	21.56	21.68	22.5	2
10	16QAM	50	0	21.72	21.85	21.70		
Channel				131997	132322	132647	Tune-up limit (dBm)	MPR (dB)
Frequency (MHz)				1712.5	1745	1777.5		
5	QPSK	1	0	23.23	23.50	23.29	24.5	0
5	QPSK	1	12	23.94	24.09	23.96		
5	QPSK	1	24	23.39	23.59	23.51		
5	QPSK	12	0	22.63	22.87	22.68	23.5	1
5	QPSK	12	7	22.68	22.92	22.77		
5	QPSK	12	13	22.65	22.80	22.70		
5	QPSK	25	0	22.69	22.85	22.78	23.5	1
5	16QAM	1	0	22.40	22.46	22.49		
5	16QAM	1	12	22.33	22.42	22.38		
5	16QAM	1	24	22.31	22.55	22.47	22.5	2
5	16QAM	12	0	21.53	21.78	21.72		
5	16QAM	12	7	21.61	21.93	21.74		
5	16QAM	12	13	21.78	21.92	21.75	22.5	2
5	16QAM	25	0	21.61	21.96	21.73		



Channel				131987	132322	132657	Tune-up limit (dBm)	MPR (dB)
Frequency (MHz)				1711.5	1745	1778.5		
3	QPSK	1	0	23.44	23.31	23.48	24.5	0
3	QPSK	1	8	23.56	23.21	23.78		
3	QPSK	1	14	23.36	23.25	23.34		
3	QPSK	8	0	22.52	22.36	22.31	23.5	1
3	QPSK	8	4	22.69	22.63	22.80		
3	QPSK	8	7	22.78	22.76	22.72		
3	QPSK	15	0	22.68	22.85	22.76	23.5	1
3	16QAM	1	0	22.42	22.50	22.53		
3	16QAM	1	8	22.17	22.93	22.42		
3	16QAM	1	14	22.45	22.58	22.60	22.5	2
3	16QAM	8	0	21.63	21.40	21.83		
3	16QAM	8	4	21.70	21.70	21.79		
3	16QAM	8	7	21.71	21.78	21.84	22.5	2
3	16QAM	15	0	21.61	21.80	21.84		
Channel				131979	132322	132665	Tune-up limit (dBm)	MPR (dB)
Frequency (MHz)				1710.7	1745	1779.3		
1.4	QPSK	1	0	23.50	23.82	23.79	24.5	0
1.4	QPSK	1	3	23.67	23.95	23.92		
1.4	QPSK	1	5	23.68	23.78	23.80		
1.4	QPSK	3	0	23.87	23.88	23.81		
1.4	QPSK	3	1	23.81	24.07	24.01		
1.4	QPSK	3	3	23.72	23.77	23.90	23.5	1
1.4	QPSK	6	0	22.73	22.78	22.88		
1.4	16QAM	1	0	22.53	22.65	22.43	23.5	1
1.4	16QAM	1	3	22.42	22.40	22.49		
1.4	16QAM	1	5	22.53	22.50	22.37		
1.4	16QAM	3	0	22.59	22.87	23.08		
1.4	16QAM	3	1	22.98	23.10	23.06		
1.4	16QAM	3	3	22.92	23.08	23.02	22.5	2
1.4	16QAM	6	0	21.45	21.60	21.52		

**<Power Level 2 for Hotspot On/P-Sensor On>**

**<LTE Band 2>**

BW [MHz]	Modulation	RB Size	RB Offset	Power Low Ch. / Freq.	Power Middle Ch. / Freq.	Power High Ch. / Freq.	Tune-up limit (dBm)	MPR (dB)
Channel				18700	18900	19100	19.5	0
Frequency (MHz)				1860	1880	1900		
20	QPSK	1	0	18.69	18.89	18.43	19.5	0
20	QPSK	1	49	19.45	19.48	18.98		
20	QPSK	1	99	18.94	18.52	18.28		
20	QPSK	50	0	19.14	19.21	18.78	19.5	0
20	QPSK	50	24	19.16	19.07	18.69		
20	QPSK	50	50	19.16	18.99	18.72		
20	QPSK	100	0	19.18	19.08	18.68	19.5	0
20	16QAM	1	0	18.78	19.11	18.66		
20	16QAM	1	49	18.96	18.98	18.55		
20	16QAM	1	99	18.86	18.71	18.39	19.5	0
20	16QAM	50	0	19.19	19.13	18.88		
20	16QAM	50	24	19.26	19.22	18.75		
20	16QAM	50	50	19.08	19.02	18.69	19.5	0
20	16QAM	100	0	19.18	19.12	18.76		
Channel				18675	18900	19125		
Frequency (MHz)				1857.5	1880	1902.5		
15	QPSK	1	0	18.91	19.07	18.74	19.5	0
15	QPSK	1	37	19.23	19.35	18.89		
15	QPSK	1	74	19.20	18.79	18.49		
15	QPSK	36	0	19.11	19.10	18.66	19.5	0
15	QPSK	36	20	19.15	19.11	18.69		
15	QPSK	36	39	19.08	19.01	18.69		
15	QPSK	75	0	19.09	19.09	18.67	19.5	0
15	16QAM	1	0	18.61	18.97	18.69		
15	16QAM	1	37	19.03	18.93	18.82		
15	16QAM	1	74	19.01	18.68	18.47	19.5	0
15	16QAM	36	0	19.01	19.12	18.72		
15	16QAM	36	20	19.10	19.05	18.66		
15	16QAM	36	39	19.14	18.85	18.65	19.5	0
15	16QAM	75	0	19.12	19.12	18.72		



Channel				18650	18900	19150	Tune-up limit (dBm)	MPR (dB)
Frequency (MHz)				1855	1880	1905		
10	QPSK	1	0	18.70	18.88	18.42	19.5	0
10	QPSK	1	25	19.19	19.33	19.01		
10	QPSK	1	49	18.83	18.59	18.34		
10	QPSK	25	0	18.87	19.14	18.69	19.5	0
10	QPSK	25	12	18.96	19.13	18.69		
10	QPSK	25	25	19.07	18.99	18.62		
10	QPSK	50	0	19.01	19.11	18.69	19.5	0
10	16QAM	1	0	18.74	18.95	18.55		
10	16QAM	1	25	19.00	18.97	18.51		
10	16QAM	1	49	18.85	18.61	18.45	19.5	0
10	16QAM	25	0	19.12	18.99	18.75		
10	16QAM	25	12	19.01	19.18	18.71		
10	16QAM	25	25	19.12	19.22	18.67	19.5	0
10	16QAM	50	0	19.15	19.14	18.74		
Channel				18625	18900	19175		
Frequency (MHz)				1852.5	1880	1907.5		
5	QPSK	1	0	18.68	18.76	18.21	19.5	0
5	QPSK	1	12	19.27	19.01	18.82		
5	QPSK	1	24	18.73	18.67	18.21		
5	QPSK	12	0	18.96	19.09	18.70	19.5	0
5	QPSK	12	7	18.81	19.08	18.77		
5	QPSK	12	13	19.00	19.02	18.66		
5	QPSK	25	0	18.93	19.02	18.69	19.5	0
5	16QAM	1	0	18.64	18.85	18.34		
5	16QAM	1	12	18.77	18.92	18.47		
5	16QAM	1	24	18.74	18.66	18.40	19.5	0
5	16QAM	12	0	18.90	18.95	18.52		
5	16QAM	12	7	19.06	19.03	18.51		
5	16QAM	12	13	19.05	19.07	18.82	19.5	0
5	16QAM	25	0	18.99	19.26	18.74		



Channel				18615	18900	19185	Tune-up limit (dBm)	MPR (dB)
Frequency (MHz)				1851.5	1880	1908.5		
3	QPSK	1	0	18.76	19.13	18.55	19.5	0
3	QPSK	1	8	18.80	19.22	18.61		
3	QPSK	1	14	18.55	18.89	18.37		
3	QPSK	8	0	18.81	19.02	18.63	19.5	0
3	QPSK	8	4	18.91	19.11	18.67		
3	QPSK	8	7	18.98	19.12	18.67		
3	QPSK	15	0	18.90	19.02	18.58	19.5	0
3	16QAM	1	0	18.61	18.83	18.26		
3	16QAM	1	8	18.50	19.05	18.36		
3	16QAM	1	14	18.60	18.60	18.50	19.5	0
3	16QAM	8	0	18.94	19.30	18.66		
3	16QAM	8	4	18.97	19.29	18.65		
3	16QAM	8	7	19.03	19.15	18.63	19.5	0
3	16QAM	15	0	18.94	19.09	18.62		
Channel				18607	18900	19193	Tune-up limit (dBm)	MPR (dB)
Frequency (MHz)				1850.7	1880	1909.3		
1.4	QPSK	1	0	18.83	18.95	18.60	19.5	0
1.4	QPSK	1	3	18.89	19.13	18.44		
1.4	QPSK	1	5	18.93	18.78	18.66		
1.4	QPSK	3	0	19.00	19.05	18.66		
1.4	QPSK	3	1	19.05	19.10	18.72		
1.4	QPSK	3	3	18.96	19.12	18.56		
1.4	QPSK	6	0	18.84	19.04	18.63	19.5	0
1.4	16QAM	1	0	18.70	18.81	18.52	19.5	0
1.4	16QAM	1	3	18.52	18.87	18.43		
1.4	16QAM	1	5	18.62	18.79	18.68		
1.4	16QAM	3	0	18.74	18.92	18.58		
1.4	16QAM	3	1	19.10	18.95	18.64		
1.4	16QAM	3	3	18.85	19.05	18.88		
1.4	16QAM	6	0	18.75	18.89	18.52	19.5	0



<LTE Band 4>

BW [MHz]	Modulation	RB Size	RB Offset	Power Low Ch. / Freq.	Power Middle Ch. / Freq.	Power High Ch. / Freq.	Tune-up limit (dBm)	MPR (dB)
Channel				20050	20175	20300		
Frequency (MHz)				1720	1732.5	1745		
20	QPSK	1	0	15.38	15.60	15.73	16.5	0
20	QPSK	1	49	15.78	16.30	16.22		
20	QPSK	1	99	15.39	15.72	16.18		
20	QPSK	50	0	15.77	15.86	16.03	16.5	0
20	QPSK	50	24	15.84	15.70	15.89		
20	QPSK	50	50	15.86	15.76	15.98		
20	QPSK	100	0	15.82	15.84	15.94	16.5	0
20	16QAM	1	0	15.58	15.61	15.89		
20	16QAM	1	49	15.59	15.64	15.77		
20	16QAM	1	99	15.37	15.55	15.88	16.5	0
20	16QAM	50	0	14.82	14.93	15.01		
20	16QAM	50	24	14.90	14.76	14.94		
20	16QAM	50	50	14.89	14.83	14.93	16.5	0
20	16QAM	100	0	14.88	14.80	14.88		
Channel				20025	20175	20325		
Frequency (MHz)				1717.5	1732.5	1747.5		
15	QPSK	1	0	15.71	15.77	15.90	16.5	0
15	QPSK	1	37	16.08	15.80	15.93		
15	QPSK	1	74	15.69	15.68	16.08		
15	QPSK	36	0	15.83	15.88	15.90	16.5	0
15	QPSK	36	20	15.85	15.72	15.90		
15	QPSK	36	39	15.91	15.81	15.95		
15	QPSK	75	0	15.87	15.88	16.00	16.5	0
15	16QAM	1	0	15.62	15.60	15.83		
15	16QAM	1	37	15.62	15.40	15.99		
15	16QAM	1	74	15.63	15.48	15.92	16.5	0
15	16QAM	36	0	14.77	14.85	14.93		
15	16QAM	36	20	14.97	14.70	14.84		
15	16QAM	36	39	14.79	14.77	14.88	16.5	0
15	16QAM	75	0	14.84	14.86	15.04		



Channel				20000	20175	20350	Tune-up limit (dBm)	MPR (dB)
Frequency (MHz)				1715	1732.5	1750		
10	QPSK	1	0	15.48	15.46	15.70	16.5	0
10	QPSK	1	25	15.69	16.26	16.17		
10	QPSK	1	49	15.54	15.83	15.98		
10	QPSK	25	0	15.77	15.83	16.04	16.5	0
10	QPSK	25	12	15.79	15.82	16.05		
10	QPSK	25	25	15.86	15.71	16.04		
10	QPSK	50	0	15.80	15.82	16.02	16.5	0
10	16QAM	1	0	15.49	15.50	15.47		
10	16QAM	1	25	15.57	15.61	15.72		
10	16QAM	1	49	15.56	15.48	15.64	16.5	0
10	16QAM	25	0	14.93	14.82	15.00		
10	16QAM	25	12	14.95	14.79	14.99		
10	16QAM	25	25	14.84	14.67	15.02	16.5	0
10	16QAM	50	0	14.85	14.78	14.93		
Channel				19975	20175	20375	Tune-up limit (dBm)	MPR (dB)
Frequency (MHz)				1712.5	1732.5	1752.5		
5	QPSK	1	0	15.30	15.60	15.79	16.5	0
5	QPSK	1	12	15.85	15.70	15.97		
5	QPSK	1	24	15.47	15.47	15.83		
5	QPSK	12	0	15.73	15.86	16.05	16.5	0
5	QPSK	12	7	15.81	15.84	16.00		
5	QPSK	12	13	15.78	15.79	16.07		
5	QPSK	25	0	15.72	15.79	16.06	16.5	0
5	16QAM	1	0	15.33	15.60	15.55		
5	16QAM	1	12	15.40	15.40	15.77		
5	16QAM	1	24	15.48	15.45	15.96	16.5	0
5	16QAM	12	0	14.56	14.83	15.12		
5	16QAM	12	7	14.77	14.88	14.90		
5	16QAM	12	13	14.75	14.77	15.05	16.5	0
5	16QAM	25	0	14.79	14.76	15.22		



Channel				19965	20175	20385	Tune-up limit (dBm)	MPR (dB)
Frequency (MHz)				1711.5	1732.5	1753.5		
3	QPSK	1	0	15.54	15.65	15.88	16.5	0
3	QPSK	1	8	15.74	15.73	16.19		
3	QPSK	1	14	15.62	15.67	15.90		
3	QPSK	8	0	15.78	15.97	16.02	16.5	0
3	QPSK	8	4	15.83	15.80	15.93		
3	QPSK	8	7	15.72	15.81	15.96		
3	QPSK	15	0	15.75	15.78	15.92	16.5	0
3	16QAM	1	0	15.35	15.62	15.66		
3	16QAM	1	8	15.43	15.16	15.74		
3	16QAM	1	14	15.53	15.53	15.79	16.5	0
3	16QAM	8	0	14.86	14.95	14.95		
3	16QAM	8	4	14.83	14.87	15.10		
3	16QAM	8	7	14.72	14.82	15.11	16.5	0
3	16QAM	15	0	14.52	14.98	14.95		
Channel				19957	20175	20393	Tune-up limit (dBm)	MPR (dB)
Frequency (MHz)				1710.7	1732.5	1754.3		
1.4	QPSK	1	0	15.69	15.75	15.89	16.5	0
1.4	QPSK	1	3	15.75	15.74	16.20		
1.4	QPSK	1	5	15.70	15.68	15.91		
1.4	QPSK	3	0	15.79	15.98	16.03		
1.4	QPSK	3	1	15.84	15.81	15.94		
1.4	QPSK	3	3	15.72	15.82	15.97		
1.4	QPSK	6	0	15.76	15.79	15.93	16.5	0
1.4	16QAM	1	0	15.36	15.63	15.67	16.5	0
1.4	16QAM	1	3	15.44	15.49	15.75		
1.4	16QAM	1	5	15.54	15.54	15.80		
1.4	16QAM	3	0	14.87	14.96	14.96		
1.4	16QAM	3	1	14.84	15.15	15.11		
1.4	16QAM	3	3	14.63	14.83	15.12		
1.4	16QAM	6	0	14.54	14.99	14.96	16.5	0



<LTE Band 25>

BW [MHz]	Modulation	RB Size	RB Offset	Power Low Ch. / Freq.	Power Middle Ch. / Freq.	Power High Ch. / Freq.	Tune-up limit (dBm)	MPR (dB)
Channel				26140	26340	26590		
Frequency (MHz)				1860	1880	1905		
20	QPSK	1	0	18.48	18.51	18.28	19.5	0
20	QPSK	1	49	18.98	18.68	18.88		
20	QPSK	1	99	18.68	18.31	18.15		
20	QPSK	50	0	18.75	18.73	18.60	19.5	0
20	QPSK	50	24	18.69	18.70	18.58		
20	QPSK	50	50	18.69	18.72	18.51		
20	QPSK	100	0	18.74	18.72	18.53	19.5	0
20	16QAM	1	0	18.56	18.44	18.21		
20	16QAM	1	49	18.38	18.49	18.22		
20	16QAM	1	99	18.38	18.39	18.22	19.5	0
20	16QAM	50	0	18.75	18.66	18.68		
20	16QAM	50	24	18.76	18.78	18.68		
20	16QAM	50	50	18.69	18.72	18.41	19.5	0
20	16QAM	100	0	18.71	18.72	18.51		
Channel				26115	26340	26615		
Frequency (MHz)				1857.5	1880	1907.5		
15	QPSK	1	0	18.55	18.64	18.52	19.5	0
15	QPSK	1	37	18.89	19.07	18.88		
15	QPSK	1	74	18.61	18.62	18.24		
15	QPSK	36	0	18.59	18.70	18.51	19.5	0
15	QPSK	36	20	18.56	18.64	18.51		
15	QPSK	36	39	18.63	18.64	18.42		
15	QPSK	75	0	18.60	18.68	18.46	19.5	0
15	16QAM	1	0	18.42	18.50	18.29		
15	16QAM	1	37	18.39	18.43	18.26		
15	16QAM	1	74	18.30	18.29	18.18	19.5	0
15	16QAM	36	0	18.64	18.75	18.49		
15	16QAM	36	20	18.58	18.64	18.51		
15	16QAM	36	39	18.53	18.72	18.42	19.5	0
15	16QAM	75	0	18.62	18.68	18.44		



Channel				26090	26340	26640	Tune-up limit (dBm)	MPR (dB)
Frequency (MHz)				1855	1880	1910		
10	QPSK	1	0	18.29	18.63	18.17	19.5	0
10	QPSK	1	25	18.46	18.88	18.60		
10	QPSK	1	49	18.32	18.31	18.25		
10	QPSK	25	0	18.54	18.65	18.42	19.5	0
10	QPSK	25	12	18.53	18.59	18.43		
10	QPSK	25	25	18.52	18.59	18.47		
10	QPSK	50	0	18.62	18.66	18.45	19.5	0
10	16QAM	1	0	18.37	18.36	18.11		
10	16QAM	1	25	18.30	18.34	18.20		
10	16QAM	1	49	18.19	18.38	18.18	19.5	0
10	16QAM	25	0	18.56	18.82	18.50		
10	16QAM	25	12	18.74	18.59	18.51		
10	16QAM	25	25	18.63	18.67	18.45	19.5	0
10	16QAM	50	0	18.55	18.65	18.55		
Channel				26065	26340	26665	Tune-up limit (dBm)	MPR (dB)
Frequency (MHz)				1852.5	1880	1912.5		
5	QPSK	1	0	18.41	18.40	18.26	19.5	0
5	QPSK	1	12	18.76	18.57	18.43		
5	QPSK	1	24	18.52	18.28	18.06		
5	QPSK	12	0	18.49	18.57	18.50	19.5	0
5	QPSK	12	7	18.47	18.64	18.57		
5	QPSK	12	13	18.53	18.59	18.43		
5	QPSK	25	0	18.52	18.59	18.40	19.5	0
5	16QAM	1	0	18.23	18.34	18.15		
5	16QAM	1	12	18.29	18.33	18.10		
5	16QAM	1	24	18.21	18.27	18.06	19.5	0
5	16QAM	12	0	18.55	18.58	18.31		
5	16QAM	12	7	18.45	18.55	18.30		
5	16QAM	12	13	18.48	18.56	18.60	19.5	0
5	16QAM	25	0	18.37	18.67	18.30		



Channel				26055	26340	26675	Tune-up limit (dBm)	MPR (dB)
Frequency (MHz)				1851.5	1880	1913.5		
3	QPSK	1	0	18.31	18.51	18.26	19.5	0
3	QPSK	1	8	18.41	18.42	18.41		
3	QPSK	1	14	18.43	18.41	18.47		
3	QPSK	8	0	18.46	18.45	18.43	19.5	0
3	QPSK	8	4	18.45	18.48	18.44		
3	QPSK	8	7	18.35	18.54	18.40		
3	QPSK	15	0	18.37	18.48	18.31	19.5	0
3	16QAM	1	0	18.24	18.04	18.09		
3	16QAM	1	8	18.14	18.02	18.04		
3	16QAM	1	14	18.15	18.08	18.07	19.5	0
3	16QAM	8	0	18.40	18.40	18.44		
3	16QAM	8	4	18.43	18.55	18.52		
3	16QAM	8	7	18.47	18.59	18.34	19.5	0
3	16QAM	15	0	18.26	18.65	18.52		
Channel				26047	26340	26683	Tune-up limit (dBm)	MPR (dB)
Frequency (MHz)				1850.7	1880	1914.3		
1.4	QPSK	1	0	18.38	18.28	18.23	19.5	0
1.4	QPSK	1	3	18.47	18.50	18.27		
1.4	QPSK	1	5	18.36	18.19	18.31		
1.4	QPSK	3	0	18.41	18.56	18.34		
1.4	QPSK	3	1	18.50	18.59	18.43		
1.4	QPSK	3	3	18.48	18.48	18.26	19.5	0
1.4	QPSK	6	0	18.34	18.43	18.18		
1.4	16QAM	1	0	18.09	18.27	18.05	19.5	0
1.4	16QAM	1	3	18.04	18.05	18.07		
1.4	16QAM	1	5	18.08	18.28	19.15		
1.4	16QAM	3	0	18.39	18.35	18.29		
1.4	16QAM	3	1	18.24	18.35	18.24		
1.4	16QAM	3	3	18.62	18.68	18.31	19.5	0
1.4	16QAM	6	0	18.50	18.57	18.20		



<LTE Band 66>

BW [MHz]	Modulation	RB Size	RB Offset	Power Low Ch. / Freq.	Power Middle Ch. / Freq.	Power High Ch. / Freq.	Tune-up limit (dBm)	MPR (dB)
Channel				132072	132322	132572		
Frequency (MHz)				1720	1745	1770		
20	QPSK	1	0	15.19	15.25	15.54	16.5	0
20	QPSK	1	49	15.24	15.37	16.31		
20	QPSK	1	99	15.06	15.33	15.70		
20	QPSK	50	0	15.17	15.63	16.10	16.5	0
20	QPSK	50	24	15.10	15.62	16.09		
20	QPSK	50	50	15.16	15.70	16.08		
20	QPSK	100	0	15.22	15.72	16.10	16.5	0
20	16QAM	1	0	15.04	15.08	15.38		
20	16QAM	1	49	15.07	15.69	15.96		
20	16QAM	1	99	15.15	15.41	15.51	16.5	0
20	16QAM	50	0	15.10	15.81	16.18		
20	16QAM	50	24	15.19	15.68	16.04		
20	16QAM	50	50	15.25	15.63	16.13	16.5	0
20	16QAM	100	0	15.12	15.56	16.07		
Channel				132047	132322	132597	Tune-up limit (dBm)	MPR (dB)
Frequency (MHz)				1717.5	1745	1772.5		
15	QPSK	1	0	15.10	15.14	15.96	16.5	0
15	QPSK	1	37	15.16	15.29	16.22		
15	QPSK	1	74	15.18	15.62	15.67		
15	QPSK	36	0	15.13	15.54	16.03	16.5	0
15	QPSK	36	20	15.00	15.63	16.06		
15	QPSK	36	39	15.10	15.64	16.05		
15	QPSK	75	0	15.05	15.66	16.07	16.5	0
15	16QAM	1	0	15.12	15.54	15.99		
15	16QAM	1	37	15.23	15.55	15.92		
15	16QAM	1	74	15.12	15.59	15.32	16.5	0
15	16QAM	36	0	15.01	15.56	16.00		
15	16QAM	36	20	15.10	15.74	16.03		
15	16QAM	36	39	15.11	15.70	16.00	16.5	0
15	16QAM	75	0	15.15	15.79	16.09		



Channel				132022	132322	132622	Tune-up limit (dBm)	MPR (dB)
Frequency (MHz)				1715	1745	1775		
10	QPSK	1	0	14.58	15.59	15.72	16.5	0
10	QPSK	1	25	14.96	15.76	15.85		
10	QPSK	1	49	15.05	15.38	15.81		
10	QPSK	25	0	14.88	15.67	16.11	16.5	0
10	QPSK	25	12	14.84	15.67	16.05		
10	QPSK	25	25	14.97	15.67	16.12		
10	QPSK	50	0	14.94	15.67	16.12	16.5	0
10	16QAM	1	0	14.60	15.30	15.93		
10	16QAM	1	25	14.89	15.61	16.41		
10	16QAM	1	49	14.74	15.16	15.29	16.5	0
10	16QAM	25	0	14.97	15.86	16.17		
10	16QAM	25	12	15.15	15.68	15.99		
10	16QAM	25	25	15.03	15.78	16.15	16.5	0
10	16QAM	50	0	14.91	15.56	16.12		
Channel				131997	132322	132647	Tune-up limit (dBm)	MPR (dB)
Frequency (MHz)				1712.5	1745	1777.5		
5	QPSK	1	0	14.54	15.56	15.87	16.5	0
5	QPSK	1	12	15.06	15.80	16.29		
5	QPSK	1	24	14.83	15.28	15.80		
5	QPSK	12	0	14.71	15.60	16.17	16.5	0
5	QPSK	12	7	14.73	15.66	16.19		
5	QPSK	12	13	14.88	15.64	16.15		
5	QPSK	25	0	14.80	15.69	16.18	16.5	0
5	16QAM	1	0	14.68	15.51	15.52		
5	16QAM	1	12	15.21	15.12	16.19		
5	16QAM	1	24	14.55	15.24	15.81	16.5	0
5	16QAM	12	0	14.78	15.44	16.25		
5	16QAM	12	7	15.07	15.50	16.00		
5	16QAM	12	13	14.91	15.74	15.99	16.5	0
5	16QAM	25	0	15.04	15.63	16.25		



Channel				131987	132322	132657	Tune-up limit (dBm)	MPR (dB)
Frequency (MHz)				1711.5	1745	1778.5		
3	QPSK	1	0	14.58	15.23	16.29	16.5	0
3	QPSK	1	8	14.81	15.68	16.42		
3	QPSK	1	14	14.93	15.52	15.76		
3	QPSK	8	0	14.70	15.76	16.35	16.5	0
3	QPSK	8	4	14.82	15.74	16.28		
3	QPSK	8	7	14.76	15.75	16.16		
3	QPSK	15	0	14.80	15.68	16.18	16.5	0
3	16QAM	1	0	14.85	15.16	15.94		
3	16QAM	1	8	14.70	15.78	15.78		
3	16QAM	1	14	14.58	15.41	15.11	16.5	0
3	16QAM	8	0	14.86	15.79	16.47		
3	16QAM	8	4	14.89	15.58	16.08		
3	16QAM	8	7	15.04	15.78	15.89	16.5	0
3	16QAM	15	0	14.90	15.57	16.18		
Channel				131979	132322	132665	Tune-up limit (dBm)	MPR (dB)
Frequency (MHz)				1710.7	1745	1779.3		
1.4	QPSK	1	0	14.56	15.49	16.19	16.5	0
1.4	QPSK	1	3	14.65	15.72	16.32		
1.4	QPSK	1	5	14.75	15.72	16.19		
1.4	QPSK	3	0	14.79	15.82	16.10		
1.4	QPSK	3	1	14.94	15.80	16.30		
1.4	QPSK	3	3	14.88	15.74	16.18		
1.4	QPSK	6	0	14.69	15.59	16.15	16.5	0
1.4	16QAM	1	0	14.56	15.62	16.14	16.5	0
1.4	16QAM	1	3	14.73	15.72	15.85		
1.4	16QAM	1	5	14.69	15.33	15.86		
1.4	16QAM	3	0	14.79	15.59	16.10		
1.4	16QAM	3	1	14.89	15.73	16.28		
1.4	16QAM	3	3	14.87	15.80	16.27		
1.4	16QAM	6	0	14.83	15.80	16.04	16.5	0



**<Power Level 3 for Default Power Mode>**

**<LTE Band 4>**

BW [MHz]	Modulation	RB Size	RB Offset	Power Low Ch. / Freq.	Power Middle Ch. / Freq.	Power High Ch. / Freq.	Tune-up limit (dBm)	MPR (dB)
Channel				20050	20175	20300		
Frequency (MHz)				1720	1732.5	1745		
20	QPSK	1	0	22.33	22.62	22.63	23.5	0
20	QPSK	1	49	22.65	22.82	22.73		
20	QPSK	1	99	22.24	22.81	22.79		
20	QPSK	50	0	21.73	21.77	21.98	22.5	1
20	QPSK	50	24	21.83	21.61	21.81		
20	QPSK	50	50	21.84	21.68	21.91		
20	QPSK	100	0	21.82	21.76	21.97	22.5	1
20	16QAM	1	0	21.45	21.71	21.78		
20	16QAM	1	49	21.49	21.53	21.57		
20	16QAM	1	99	21.41	21.45	21.79	21.5	2
20	16QAM	50	0	20.80	20.76	20.94		
20	16QAM	50	24	20.71	20.68	20.86		
20	16QAM	50	50	20.73	20.75	20.90	21.5	2
20	16QAM	100	0	20.68	20.61	20.85		
Channel				20025	20175	20325		
Frequency (MHz)				1717.5	1732.5	1747.5		
15	QPSK	1	0	22.63	22.51	22.90	23.5	0
15	QPSK	1	37	23.08	22.64	23.15		
15	QPSK	1	74	22.77	22.45	23.05		
15	QPSK	36	0	21.74	21.80	21.90	22.5	1
15	QPSK	36	20	21.86	21.64	21.82		
15	QPSK	36	39	21.83	21.73	21.97		
15	QPSK	75	0	21.79	21.79	21.92	22.5	1
15	16QAM	1	0	21.54	21.63	21.76		
15	16QAM	1	37	21.19	21.35	21.68		
15	16QAM	1	74	21.54	21.41	21.89	21.5	2
15	16QAM	36	0	20.68	20.77	20.85		
15	16QAM	36	20	20.75	20.62	20.85		
15	16QAM	36	39	20.71	20.70	20.92	21.5	2
15	16QAM	75	0	20.78	20.73	20.94		



Channel				20000	20175	20350	Tune-up limit (dBm)	MPR (dB)
Frequency (MHz)				1715	1732.5	1750		
10	QPSK	1	0	22.40	22.34	22.56	23.5	0
10	QPSK	1	25	22.73	23.14	23.41		
10	QPSK	1	49	22.38	22.44	22.93		
10	QPSK	25	0	21.75	21.85	22.02	22.5	1
10	QPSK	25	12	21.77	21.80	21.95		
10	QPSK	25	25	21.85	21.69	22.01		
10	QPSK	50	0	21.68	21.82	21.93	22.5	1
10	16QAM	1	0	21.49	21.44	21.35		
10	16QAM	1	25	21.54	21.49	21.72		
10	16QAM	1	49	21.53	21.49	21.88	21.5	2
10	16QAM	25	0	20.91	20.85	21.06		
10	16QAM	25	12	20.90	20.77	20.98		
10	16QAM	25	25	20.73	20.67	21.07	21.5	2
10	16QAM	50	0	20.68	20.62	20.57		
Channel				19975	20175	20375	Tune-up limit (dBm)	MPR (dB)
Frequency (MHz)				1712.5	1732.5	1752.5		
5	QPSK	1	0	22.19	22.39	22.51	23.5	0
5	QPSK	1	12	22.76	22.58	23.12		
5	QPSK	1	24	22.33	22.26	22.87		
5	QPSK	12	0	21.70	21.80	22.00	22.5	1
5	QPSK	12	7	21.69	21.91	22.01		
5	QPSK	12	13	21.64	21.75	22.05		
5	QPSK	25	0	21.68	21.65	22.01	22.5	1
5	16QAM	1	0	21.39	21.54	21.72		
5	16QAM	1	12	21.35	21.41	21.77		
5	16QAM	1	24	21.45	21.41	21.95	21.5	2
5	16QAM	12	0	20.65	20.76	21.08		
5	16QAM	12	7	20.69	20.89	21.02		
5	16QAM	12	13	20.71	20.74	21.15	21.5	2
5	16QAM	25	0	20.74	20.67	21.17		



Channel				19965	20175	20385	Tune-up limit (dBm)	MPR (dB)
Frequency (MHz)				1711.5	1732.5	1753.5		
3	QPSK	1	0	22.39	22.55	22.59	23.5	0
3	QPSK	1	8	22.71	22.56	22.73		
3	QPSK	1	14	22.66	22.42	22.95		
3	QPSK	8	0	21.56	21.87	22.05	22.5	1
3	QPSK	8	4	21.72	21.65	21.95		
3	QPSK	8	7	21.69	21.82	22.05		
3	QPSK	15	0	21.70	21.68	21.88	22.5	1
3	16QAM	1	0	21.51	21.64	21.61		
3	16QAM	1	8	21.91	21.36	21.65		
3	16QAM	1	14	21.47	21.43	21.95	21.5	2
3	16QAM	8	0	20.72	20.88	21.18		
3	16QAM	8	4	20.77	20.81	20.81		
3	16QAM	8	7	20.76	20.83	21.11	21.5	2
3	16QAM	15	0	20.94	20.66	20.90		
Channel				19957	20175	20393	Tune-up limit (dBm)	MPR (dB)
Frequency (MHz)				1710.7	1732.5	1754.3		
1.4	QPSK	1	0	22.53	22.56	22.78	23.5	0
1.4	QPSK	1	3	22.59	22.73	22.81		
1.4	QPSK	1	5	22.32	22.56	22.85		
1.4	QPSK	3	0	22.81	22.77	23.02		
1.4	QPSK	3	1	22.68	23.02	23.15		
1.4	QPSK	3	3	22.69	22.91	23.08		
1.4	QPSK	6	0	21.67	21.86	22.04	22.5	1
1.4	16QAM	1	0	21.51	21.69	22.13	22.5	1
1.4	16QAM	1	3	21.41	21.55	22.20		
1.4	16QAM	1	5	21.53	21.62	22.25		
1.4	16QAM	3	0	21.72	21.86	22.28		
1.4	16QAM	3	1	21.69	21.84	22.24		
1.4	16QAM	3	3	21.69	21.89	22.25		
1.4	16QAM	6	0	20.56	20.70	20.72	21.5	2



<LTE Band 66>

BW [MHz]	Modulation	RB Size	RB Offset	Power Low Ch. / Freq.	Power Middle Ch. / Freq.	Power High Ch. / Freq.	Tune-up limit (dBm)	MPR (dB)
Channel				132072	132322	132572		
Frequency (MHz)				1720	1745	1770		
20	QPSK	1	0	22.15	22.45	22.13	23.5	0
20	QPSK	1	49	22.28	22.47	22.27		
20	QPSK	1	99	22.27	22.45	22.26		
20	QPSK	50	0	21.79	22.08	21.95	22.5	1
20	QPSK	50	24	21.74	21.81	21.65		
20	QPSK	50	50	21.66	21.77	21.59		
20	QPSK	100	0	21.68	21.85	21.70	22.5	1
20	16QAM	1	0	21.25	21.66	21.63		
20	16QAM	1	49	21.40	21.58	21.39		
20	16QAM	1	99	21.45	21.48	21.28	21.5	2
20	16QAM	50	0	20.71	20.81	20.78		
20	16QAM	50	24	20.70	20.95	20.66		
20	16QAM	50	50	20.67	20.89	20.71	21.5	2
20	16QAM	100	0	20.78	20.87	20.71		
Channel				132047	132322	132597		
Frequency (MHz)				1717.5	1745	1772.5		
15	QPSK	1	0	21.96	22.34	22.12	23.5	0
15	QPSK	1	37	22.42	22.52	22.18		
15	QPSK	1	74	22.12	22.37	22.15		
15	QPSK	36	0	21.57	21.89	21.76	22.5	1
15	QPSK	36	20	21.60	21.87	21.68		
15	QPSK	36	39	21.69	21.82	21.66		
15	QPSK	75	0	21.60	21.85	21.71	22.5	1
15	16QAM	1	0	21.36	21.57	21.93		
15	16QAM	1	37	21.34	21.51	21.59		
15	16QAM	1	74	21.43	21.55	21.27	21.5	2
15	16QAM	36	0	20.60	20.89	20.73		
15	16QAM	36	20	20.66	20.87	20.64		
15	16QAM	36	39	20.63	20.83	20.61	21.5	2
15	16QAM	75	0	20.78	20.87	20.82		



Channel				132022	132322	132622	Tune-up limit (dBm)	MPR (dB)
Frequency (MHz)				1715	1745	1775		
10	QPSK	1	0	21.84	22.22	22.03	23.5	0
10	QPSK	1	25	22.52	22.73	22.53		
10	QPSK	1	49	21.87	22.40	21.95		
10	QPSK	25	0	21.75	22.10	21.87	22.5	1
10	QPSK	25	12	21.74	22.01	21.83		
10	QPSK	25	25	21.72	22.00	21.89		
10	QPSK	50	0	21.80	21.98	21.89	22.5	1
10	16QAM	1	0	21.34	21.82	21.59		
10	16QAM	1	25	21.55	21.78	21.55		
10	16QAM	1	49	21.34	21.72	21.14	21.5	2
10	16QAM	25	0	20.58	21.00	20.89		
10	16QAM	25	12	21.05	21.16	21.12		
10	16QAM	25	25	20.64	21.01	21.15	21.5	2
10	16QAM	50	0	20.80	21.15	20.90		
Channel				131997	132322	132647	Tune-up limit (dBm)	MPR (dB)
Frequency (MHz)				1712.5	1745	1777.5		
5	QPSK	1	0	21.70	22.19	21.91	23.5	0
5	QPSK	1	12	22.26	22.70	22.47		
5	QPSK	1	24	21.82	22.45	21.91		
5	QPSK	12	0	21.67	21.98	21.87	22.5	1
5	QPSK	12	7	21.67	22.12	21.94		
5	QPSK	12	13	21.63	22.02	21.86		
5	QPSK	25	0	21.68	22.06	21.85	22.5	1
5	16QAM	1	0	21.34	21.72	21.61		
5	16QAM	1	12	21.62	21.56	21.52		
5	16QAM	1	24	21.41	21.61	21.58	21.5	2
5	16QAM	12	0	20.55	20.99	21.00		
5	16QAM	12	7	20.78	21.13	20.87		
5	16QAM	12	13	20.68	21.20	21.07	21.5	2
5	16QAM	25	0	20.73	21.18	21.04		



Channel				131987	132322	132657	Tune-up limit (dBm)	MPR (dB)
Frequency (MHz)				1711.5	1745	1778.5		
3	QPSK	1	0	22.21	22.29	22.04	23.5	0
3	QPSK	1	8	22.25	22.48	22.35		
3	QPSK	1	14	22.02	22.37	22.24		
3	QPSK	8	0	21.67	22.10	21.86	22.5	1
3	QPSK	8	4	21.78	22.03	21.87		
3	QPSK	8	7	21.69	22.09	21.91		
3	QPSK	15	0	21.66	22.02	21.91	22.5	1
3	16QAM	1	0	21.20	21.74	21.47		
3	16QAM	1	8	21.84	21.62	21.57		
3	16QAM	1	14	21.29	21.81	21.73	21.5	2
3	16QAM	8	0	20.73	21.09	20.98		
3	16QAM	8	4	20.80	21.19	20.73		
3	16QAM	8	7	20.70	21.20	21.09	21.5	2
3	16QAM	15	0	20.72	21.05	20.94		
Channel				131979	132322	132665	Tune-up limit (dBm)	MPR (dB)
Frequency (MHz)				1710.7	1745	1779.3		
1.4	QPSK	1	0	22.07	22.33	22.14	23.5	0
1.4	QPSK	1	3	22.14	22.50	22.19		
1.4	QPSK	1	5	22.05	22.41	22.13		
1.4	QPSK	3	0	22.22	22.53	22.32		
1.4	QPSK	3	1	22.26	22.44	22.36		
1.4	QPSK	3	3	22.16	22.48	22.34		
1.4	QPSK	6	0	21.56	22.03	21.76	22.5	1
1.4	16QAM	1	0	21.68	21.46	21.61	22.5	1
1.4	16QAM	1	3	21.57	21.43	21.42		
1.4	16QAM	1	5	21.68	21.44	21.36		
1.4	16QAM	3	0	21.65	21.85	21.61		
1.4	16QAM	3	1	21.59	21.90	21.71		
1.4	16QAM	3	3	21.61	22.12	21.81		
1.4	16QAM	6	0	20.43	21.00	20.59	21.5	2

**<TDD LTE SAR Measurement>**

TDD LTE configuration setup for SAR measurement

SAR was tested with a fixed periodic duty factor according to the highest transmission duty factor implemented for the device and supported by 3GPP.

- a. 3GPP TS 36.211 section 4.2 for Type 2 Frame Structure and Table 4.2-2 for uplink-downlink configurations
- b. "special subframe S" contains both uplink and downlink transmissions, it has been taken into consideration to determine the transmission duty factor according to the worst case uplink and downlink cyclic prefix requirements for UpPTS
- c. Establishing connections with base station simulators ensure a consistent means for testing SAR and recommended for evaluating SAR. The Anritsu MT8820C (firmware: #22.52#004) was used for LTE output power measurements and SAR testing.

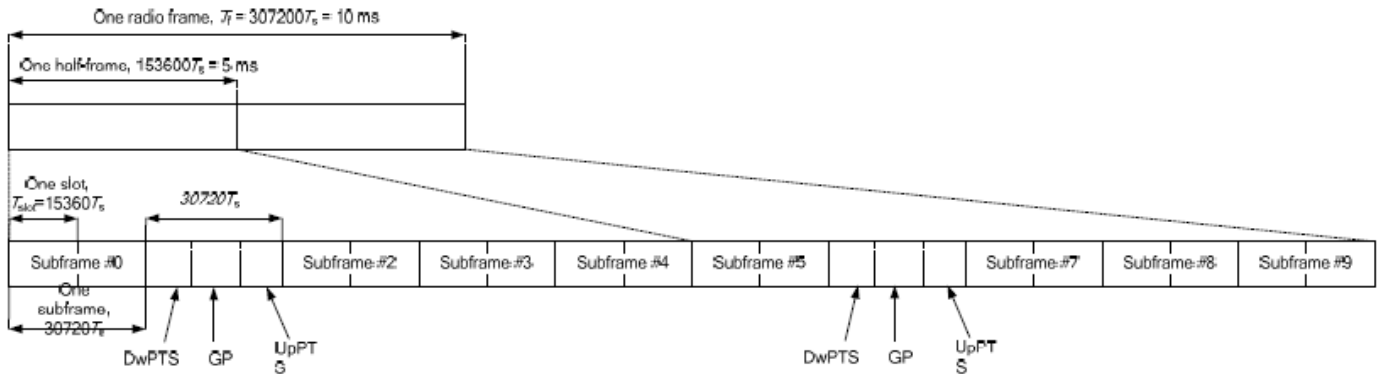

**Figure 4.2-1: Frame structure type 2 (for 5 ms switch-point periodicity).**

**Table 4.2-2: Uplink-downlink configurations.**

Uplink-downlink configuration	Downlink-to-Uplink Switch-point periodicity	Subframe number									
		0	1	2	3	4	5	6	7	8	9
0	5 ms	D	S	U	U	U	D	S	U	U	U
1	5 ms	D	S	U	U	D	D	S	U	U	D
2	5 ms	D	S	U	D	D	D	S	U	D	D
3	10 ms	D	S	U	U	U	D	D	D	D	D
4	10 ms	D	S	U	U	D	D	D	D	D	D
5	10 ms	D	S	U	D	D	D	D	D	D	D
6	5 ms	D	S	U	U	U	D	S	U	U	D

**Table 4.2-1: Configuration of special subframe (lengths of DwPTS/GP/UpPTS).**

Special subframe configuration	Normal cyclic prefix in downlink			Extended cyclic prefix in downlink		
	DwPTS	UpPTS		DwPTS	UpPTS	
		Normal cyclic prefix in uplink	Extended cyclic prefix in uplink		Normal cyclic prefix in uplink	Extended cyclic prefix in uplink
0	6592 · Ts	2192 · Ts	2560 · Ts	7680 · Ts	2192 · Ts	2560 · Ts
1	19760 · Ts			20480 · Ts		
2	21952 · Ts			23040 · Ts		
3	24144 · Ts			25600 · Ts		
4	26336 · Ts			7680 · Ts	4384 · Ts	5120 · Ts
5	6592 · Ts	4384 · Ts	5120 · Ts	20480 · Ts		
6	19760 · Ts			23040 · Ts		
7	21952 · Ts			12800 · Ts		
8	24144 · Ts			-	-	-
9	13168 · Ts			-	-	-

Special subframe (30720·T <sub>s</sub> ): Normal cyclic prefix in downlink (UpPTS)			
	Special subframe configuration	Normal cyclic prefix in uplink	Extended cyclic prefix in uplink
Uplink duty factor in one special subframe	0~4	7.13%	8.33%
	5~9	14.3%	16.7%

Special subframe(30720·T <sub>s</sub> ): Extended cyclic prefix in downlink (UpPTS)			
	Special subframe configuration	Normal cyclic prefix in uplink	Extended cyclic prefix in uplink
Uplink duty factor in one special subframe	0~3	7.13%	8.33%
	4~7	14.3%	16.7%

The highest duty factor is resulted from:

- i. Uplink-downlink configuration: 0. In a half-frame consisted of 5 subframes, uplink operation is in 3 uplink subframes and 1 special subframe.
- ii. special subframe configuration: 5-9 for normal cyclic prefix in downlink, 4-7 for extended cyclic prefix in downlink
- iii. for special subframe with extended cyclic prefix in uplink, the total uplink duty factor in one half-frame is:  
 $(3+0.167)/5 = 63.3\%$
- iv. for special subframe with normal cyclic prefix in uplink, the total uplink duty factor in one half-frame is:  
 $(3+0.143)/5 = 62.9\%$
- v. For TDD LTE SAR measurement, the duty cycle 1:1.59 (62.9 %) was used perform testing and considering the theoretical duty cycle of 63.3% for extended cyclic prefix in the uplink, and the theoretical duty cycle of 62.9% for normal cyclic prefix in uplink, a scaling factor of extended cyclic prefix  $63.3\%/62.9\% = 1.006$  is applied to scale-up the measured SAR result. The scaled TDD LTE SAR = measured SAR (W/kg)\* Tune-up Scaling Factor\* scaling factor for extended cyclic prefix.

**<Power Level 1 for Full Power Mode>**

**<LTE Band 38>**

BW [MHz]	Modulation	RB Size	RB Offset	Power Low Ch. / Freq.	Power Middle Ch. / Freq.	Power High Ch. / Freq.	Tune-up limit (dBm)	MPR (dB)
Channel				37850	38000	38150		
Frequency (MHz)				2580	2595	2610		
20	QPSK	1	0	22.63	22.59	22.51	23.5	0
20	QPSK	1	49	22.83	22.55	22.66		
20	QPSK	1	99	22.69	22.51	22.49		
20	QPSK	50	0	21.70	21.52	21.56	22.5	1
20	QPSK	50	24	21.64	21.48	21.47		
20	QPSK	50	50	21.59	21.47	21.48		
20	QPSK	100	0	21.87	21.70	21.42		
20	16QAM	1	0	20.95	21.09	21.20	22.5	1
20	16QAM	1	49	21.84	21.40	21.41		
20	16QAM	1	99	20.78	21.07	21.07		
20	16QAM	50	0	20.86	20.92	20.51	21.5	2
20	16QAM	50	24	21.04	20.62	20.70		
20	16QAM	50	50	21.01	20.47	20.65		
20	16QAM	100	0	20.73	20.57	20.48		
Channel				37825	38000	38175	Tune-up limit (dBm)	MPR (dB)
Frequency (MHz)				2577.5	2595	2612.5		
15	QPSK	1	0	22.65	22.59	22.45	23.5	0
15	QPSK	1	37	22.95	22.70	22.68		
15	QPSK	1	74	22.57	22.53	22.36		
15	QPSK	36	0	21.85	21.52	21.71	22.5	1
15	QPSK	36	20	21.83	21.44	21.48		
15	QPSK	36	39	21.58	21.46	21.70		
15	QPSK	75	0	21.65	21.47	21.52		
15	16QAM	1	0	21.63	21.45	21.14	22.5	1
15	16QAM	1	37	21.73	21.67	21.63		
15	16QAM	1	74	21.11	20.73	20.98		
15	16QAM	36	0	20.91	20.68	20.64	21.5	2
15	16QAM	36	20	20.86	20.67	20.85		
15	16QAM	36	39	20.73	20.59	20.61		
15	16QAM	75	0	21.00	20.59	20.56		



Channel				37800	38000	38200	Tune-up limit (dBm)	MPR (dB)
Frequency (MHz)				2575	2595	2615		
10	QPSK	1	0	22.65	22.55	22.61	23.5	0
10	QPSK	1	25	23.37	23.22	22.64		
10	QPSK	1	49	22.70	22.44	22.49		
10	QPSK	25	0	21.84	21.49	21.55	22.5	1
10	QPSK	25	12	21.64	21.52	21.47		
10	QPSK	25	25	21.62	21.47	21.44		
10	QPSK	50	0	21.62	21.50	21.44	22.5	1
10	16QAM	1	0	21.39	21.35	20.83		
10	16QAM	1	25	21.28	21.63	21.68		
10	16QAM	1	49	21.08	21.30	20.92	21.5	2
10	16QAM	25	0	20.97	20.55	20.86		
10	16QAM	25	12	21.00	21.09	20.84		
10	16QAM	25	25	20.93	20.94	20.76	21.5	2
10	16QAM	50	0	21.00	20.45	20.49		
Channel				37775	38000	38225		
Frequency (MHz)				2572.5	2595	2617.5		
5	QPSK	1	0	22.65	22.36	22.44	23.5	0
5	QPSK	1	12	22.80	22.54	22.84		
5	QPSK	1	24	22.60	22.40	22.23		
5	QPSK	12	0	21.65	21.41	21.46	22.5	1
5	QPSK	12	7	21.87	21.45	21.46		
5	QPSK	12	13	21.63	21.43	21.45		
5	QPSK	25	0	21.82	21.47	21.46	22.5	1
5	16QAM	1	0	21.42	21.16	21.29		
5	16QAM	1	12	21.44	21.58	21.61		
5	16QAM	1	24	21.37	21.23	21.17	21.5	2
5	16QAM	12	0	20.93	20.81	20.46		
5	16QAM	12	7	20.75	20.79	20.46		
5	16QAM	12	13	20.88	20.76	20.44	21.5	2
5	16QAM	25	0	20.94	21.12	20.51		



<LTE Band 41>

BW [MHz]	Modulation	RB Size	RB Offset	Power Low Ch. / Freq.	Power Low Middle Ch. / Freq.	Power Middle Ch. / Freq.	Power High Middle Ch. / Freq.	Power High Ch. / Freq.	Tune-up limit (dBm)	MPR (dB)
Channel				39750	40185	40620	41055	41490		
Frequency (MHz)				2506	2549.5	2593	2636.5	2680		
20	QPSK	1	0	23.69	23.67	23.58	23.42	23.60	24.5	0
20	QPSK	1	49	23.86	23.68	23.70	23.42	23.55		
20	QPSK	1	99	23.67	23.56	23.55	23.55	23.58		
20	QPSK	50	0	22.67	22.65	22.57	22.66	22.59	23.5	1
20	QPSK	50	24	22.75	22.74	22.54	22.55	22.74		
20	QPSK	50	50	22.71	22.68	22.46	22.51	22.40		
20	QPSK	100	0	22.82	22.81	22.47	22.59	22.54	23.5	1
20	16QAM	1	0	22.10	22.26	22.05	21.73	22.19		
20	16QAM	1	49	22.51	22.38	22.77	22.25	22.37		
20	16QAM	1	99	21.79	22.03	22.07	21.98	22.09	22.5	2
20	16QAM	50	0	21.68	21.86	21.52	21.54	21.62		
20	16QAM	50	24	21.58	21.86	21.55	21.34	21.58		
20	16QAM	50	50	21.60	21.73	21.71	21.42	21.54	22.5	2
20	16QAM	100	0	21.65	21.62	21.44	21.49	21.59		
Channel				39725	40173	40620	41068	41515	Tune-up limit (dBm)	MPR (dB)
Frequency (MHz)				2503.5	2548.3	2593	2637.8	2682.5		
15	QPSK	1	0	23.49	23.66	23.64	23.28	23.52	24.5	0
15	QPSK	1	37	23.91	23.96	23.72	23.69	23.90		
15	QPSK	1	74	23.76	23.82	23.49	23.49	23.60		
15	QPSK	36	0	22.66	22.61	22.50	22.60	22.50	23.5	1
15	QPSK	36	20	22.83	22.86	22.53	22.58	22.58		
15	QPSK	36	39	22.70	22.59	22.46	22.50	22.54		
15	QPSK	75	0	22.74	22.61	22.45	22.61	22.67	23.5	1
15	16QAM	1	0	22.21	22.17	22.12	22.36	22.10		
15	16QAM	1	37	22.74	22.73	22.11	22.40	22.29		
15	16QAM	1	74	22.26	22.21	21.91	22.12	22.14	22.5	2
15	16QAM	36	0	21.58	21.67	21.58	21.49	21.58		
15	16QAM	36	20	21.58	21.54	21.61	21.39	21.67		
15	16QAM	36	39	21.75	21.59	21.57	21.83	21.64	22.5	2
15	16QAM	75	0	21.74	21.91	21.58	21.57	21.64		



Channel				39700	40160	40620	41080	41540	Tune-up limit (dBm)	MPR (dB)
Frequency (MHz)				2501	2547	2593	2639	2685		
10	QPSK	1	0	23.74	23.60	23.62	23.62	23.77	24.5	0
10	QPSK	1	25	23.97	23.75	23.76	23.86	24.01		
10	QPSK	1	49	23.85	23.66	23.55	23.57	23.88		
10	QPSK	25	0	22.69	22.84	22.54	22.63	22.69	23.5	1
10	QPSK	25	12	22.80	22.88	22.51	22.62	22.59		
10	QPSK	25	25	22.74	22.62	22.45	22.56	22.70		
10	QPSK	50	0	22.76	22.86	22.49	22.59	22.55		
10	16QAM	1	0	22.26	22.41	22.27	22.23	22.47	23.5	1
10	16QAM	1	25	23.00	22.26	22.27	22.12	22.33		
10	16QAM	1	49	22.03	22.42	22.13	22.27	22.39		
10	16QAM	25	0	21.87	21.88	21.76	21.70	21.92	22.5	2
10	16QAM	25	12	21.97	21.80	21.64	21.60	21.89		
10	16QAM	25	25	21.92	21.83	21.67	21.72	21.63		
10	16QAM	50	0	21.66	21.61	21.64	21.41	21.53		
Channel				39675	40148	40620	41093	41565	Tune-up limit (dBm)	MPR (dB)
Frequency (MHz)				2498.5	2545.8	2593	2640.30	2687.5		
5	QPSK	1	0	23.50	23.63	23.35	23.37	23.65	24.5	0
5	QPSK	1	12	23.88	23.84	23.63	23.67	23.90		
5	QPSK	1	24	23.57	23.51	23.42	23.28	23.73		
5	QPSK	12	0	22.65	22.56	22.51	22.62	22.52	23.5	1
5	QPSK	12	7	22.67	22.84	22.50	22.36	22.76		
5	QPSK	12	13	22.66	22.60	22.38	22.64	22.69		
5	QPSK	25	0	22.66	22.83	22.49	22.64	22.65		
5	16QAM	1	0	22.18	22.31	22.27	22.14	22.31	23.5	1
5	16QAM	1	12	22.81	22.62	22.09	22.37	22.78		
5	16QAM	1	24	22.65	22.35	22.16	22.23	22.27		
5	16QAM	12	0	21.47	21.65	21.43	21.56	21.61	22.5	2
5	16QAM	12	7	21.70	21.52	21.47	21.97	21.75		
5	16QAM	12	13	21.68	21.67	21.46	21.39	21.76		
5	16QAM	25	0	21.55	21.86	21.71	21.71	21.97		

**<LTE Carrier Aggregation>**

**General Note:**

This device supports Carrier Aggregation on downlink for inter and intra band. For the device supports bands and bandwidths and configurations are provided as follow table was according to 3GPP.

E-UTRA CA configuration / Bandwidth combination set							
E-UTRA CA configuration	Uplink CA configurations	Component carriers in order of increasing carrier frequency				Maximum aggregated bandwidth [MHz]	Bandwidth combination set
		Channel bandwidths for carrier [MHz]	Channel bandwidths for carrier [MHz]	Channel bandwidths for carrier [MHz]	Channel bandwidths for carrier [MHz]		
CA_41C	-	10	20			40	0
		15	15, 20				
		20	10, 15, 20				
		5, 10	20			40	1
		15	15, 20				
		20	5, 10, 15, 20				
		10	15, 20			40	2
		15	10, 15, 20				
		20	10, 15, 20				
		10	20			40	3
20	20						
CA_66C	-	5	20			40	0
		10	15, 20				
		15	10, 15, 20				
		20	5, 10, 15, 20				
CA_2A-2A	-	5, 10, 15, 20	5, 10, 15, 20			40	0
CA_4A-4A	-	5, 10, 15, 20	5, 10, 15, 20			40	0
		5, 10	5, 10			20	1
CA_66A-66A	-	5, 10, 15, 20	5, 10, 15, 20			40	1



E-UTRA CA configuration / Bandwidth combination set										
E-UTRA CA Configuration	Uplink CA configurations	E- UTRA Bands	1.4 MHz	3 MHz	5 MHz	10 MHz	15 MHz	20 MHz	Maximum aggregated bandwidth [MHz]	Bandwidth combination set
CA_2A-4A	-	2	Yes	Yes	Yes	Yes	Yes	Yes	40	0
		4			Yes	Yes	Yes	Yes		
		2			Yes	Yes			20	1
		4			Yes	Yes				
		2			Yes	Yes	Yes	Yes	40	2
4			Yes	Yes	Yes	Yes				
CA_2A-5A	-	2			Yes	Yes	Yes	Yes	30	0
		5			Yes	Yes				
		2			Yes	Yes			20	1
		5			Yes	Yes				
CA_2A-12A	-	2			Yes	Yes	Yes	Yes	30	0
		12			Yes	Yes				
		2			Yes	Yes	Yes	Yes	30	1
		12		Yes	Yes	Yes				
		2			Yes	Yes			20	2
12			Yes	Yes						
CA_2A-13A	-	2			Yes	Yes	Yes	Yes	30	0
		13				Yes				
		2			Yes	Yes			20	1
		13				Yes				
CA_2A-17A	-	2			Yes	Yes			20	0
		17			Yes	Yes				
CA_2A-66A	-	2	Yes	Yes	Yes	Yes	Yes	Yes	40	0
		66			Yes	Yes	Yes	Yes		
		2			Yes	Yes			20	1
		66			Yes	Yes				
		2			Yes	Yes	Yes	Yes	40	2
66			Yes	Yes	Yes	Yes				
CA_4A-5A	-	4			Yes	Yes			20	0
		5			Yes	Yes				
		4			Yes	Yes	Yes	Yes	30	0
		5			Yes	Yes				
CA_4A-12A	-	4	Yes	Yes	Yes	Yes			20	0
		12			Yes	Yes				
		4	Yes	Yes	Yes	Yes	Yes	Yes	30	1
		12			Yes	Yes				
		4			Yes	Yes	Yes	Yes	30	2
		12		Yes	Yes	Yes				
		4			Yes	Yes			20	3
		12			Yes	Yes				
		4			Yes	Yes	Yes	Yes	30	4
		12			Yes	Yes				
4			Yes	Yes	Yes		20	5		
12			Yes	Yes						
CA_4A-13A	-	4			Yes	Yes	Yes	Yes	30	0
		13				Yes				
		4			Yes	Yes			20	1
		13				Yes				
CA_4A-17A	-	4			Yes	Yes			20	0
		17			Yes	Yes				



E-UTRA CA configuration / Bandwidth combination set										
E-UTRA CA Configuration	Uplink CA configurations	E- UTRA Bands	1.4 MHz	3 MHz	5 MHz	10 MHz	15 MHz	20 MHz	Maximum aggregated bandwidth [MHz]	Bandwidth combination set
CA_5A-66A	-	5			Yes	Yes			30	0
		66			Yes	Yes	Yes	Yes		
CA_12A-66A	-	12			Yes	Yes			20	0
		66	Yes	Yes	Yes	Yes				
		12			Yes	Yes			30	1
		66	Yes	Yes	Yes	Yes	Yes	Yes		
		12		Yes	Yes	Yes			30	2
		66			Yes	Yes	Yes	Yes		
		12			Yes	Yes			20	3
		66			Yes	Yes				
		12			Yes	Yes			30	4
		66			Yes	Yes	Yes	Yes		
		12			Yes				20	5
		66			Yes	Yes	Yes			
CA_13A-66A	-	13			Yes	Yes			30	0
		66			Yes	Yes	Yes	Yes		

**LTE Carrier Aggregation Conducted Power (Downlink)**

**General Note:**

- i. According to KDB941225 D05A v01r02, Uplink maximum output power measurement with downlink carrier aggregation active should be measured, using the highest output channel measured without downlink carrier aggregation, to confirm that uplink maximum output power with downlink carrier aggregation active remains within the specified tune-up tolerance limits and not more than ¼ dB higher than the maximum output measured without downlink carrier aggregation active.
- ii. Uplink maximum output power with downlink carrier aggregation active does not show more than ¼ dB higher than the maximum output power without downlink carrier aggregation active, therefore SAR evaluation with downlink carrier aggregation active can be excluded.
- iii. The device supports downlink carrier aggregation only. Uplink carrier aggregation is not supported. For power measurement were control and acknowledge data is sent on uplink channels that operate identical to specifications when downlink carrier aggregation is inactive.
- iv. Selected highest measured power when downlink carrier aggregation is inactive for conducted power comparison with downlink carrier aggregation is active, to confirm that when downlink carrier aggregation is active uplink maximum output power remains within the specified tune-up tolerance limits and not more than ¼ dB higher than the maximum output power measured when downlink carrier aggregation inactive.
- v. For inter-band CA, the SCC selected highest bandwidth and near the middle of its transmission band. For SCC DL RB size and offset will base on the PCC corresponding RB allocation.
- vi. For non-contiguous intra-band CA, the SCC selected to provide maximum separation from the PCC and must remain fully within the downlink transmission band. For SCC DL RB size and offset will base on the PCC corresponding RB allocation.
- vii. For Intra-band, contiguous CA, the downlink channels selected to perform the uplink power measurement must satisfy 3GPP channel spacing (5.4.1A of 3GPP TS 36.521 or equivalent) and channel bandwidth (5.4.2A) requirements.

$$\text{Nominal channel spacing} = \left\lceil \frac{BW_{\text{Channel}(1)} + BW_{\text{Channel}(2)} - 0.1|BW_{\text{Channel}(1)} - BW_{\text{Channel}(2)}|}{0.6} \right\rceil 0.3 \text{ [MHz]}$$



<Power Level 1 for Full Power Mode>

Configure	PCC						SCC				Power		
	LTE Band	BW (MHz)	Freq. (MHz)	Channel	UL# RB	UL RB Offset	LTE Band	BW (MHz)	Freq. (MHz)	Channel	LTE Rel 10 Tx.Power (dBm)	LTE Rel 8 Tx.Power (dBm)	
Inter-Band	Band 2	20M	1880	18900	1	49	Band 4	20M	2132.5	2175	24.20	24.21	
	Band 4	20M	1732.5	20175	1	49	Band 2	20M	1960	900	24.01	24.02	
	Band 2	20M	1880	18900	1	49	Band 5	10M	881.5	2525	24.20	24.21	
	Band 5	10M	844	20600	1	25	Band 2	20M	1960	900	24.00	24.02	
	Band 2	20M	1880	18900	1	49	Band 12	10M	737.5	5095	24.18	24.21	
	Band 12	10M	711	23130	1	25	Band 2	20M	1960	900	24.41	24.44	
	Band 2	20M	1880	18900	1	49	Band 13	10M	751	5230	24.16	24.21	
	Band 13	10M	782	23230	1	25	Band 2	20M	1960	900	24.18	24.24	
	Band 2	20M	1880	18900	1	49	Band 17	10M	740	5790	24.15	24.21	
	Band 17	10M	709	23780	1	25	Band 2	20M	1960	900	24.08	24.10	
	Band 2	20M	1880	18900	1	49	Band 66	20M	2155	66886	24.18	24.21	
	Band 66	20M	1745	132322	1	49	Band 2	20M	1960	900	24.30	24.34	
	Band 4	20M	1732.5	20175	1	49	Band 5	10M	881.5	2525	24.01	24.02	
	Band 5	10M	844	20600	1	25	Band 4	20M	2132.5	2175	24.01	24.02	
	Band 4	20M	1732.5	20175	1	49	Band 12	10M	737.5	5095	24.00	24.02	
	Band 12	10M	711	23130	1	25	Band 4	20M	2132.5	2175	24.38	24.44	
	Band 4	20M	1732.5	20175	1	49	Band 13	10M	751	5230	23.98	24.02	
	Band 13	10M	782	23230	1	25	Band 4	20M	2132.5	2175	24.16	24.24	
	Band 4	20M	1732.5	20175	1	49	Band 17	10M	740	5790	24.01	24.02	
	Band 17	10M	709	23780	1	25	Band 4	20M	2132.5	2175	24.06	24.10	
	Band 5	10M	844	20600	1	25	Band 66	20M	2155	66886	24.01	24.02	
	Band 66	20M	1745	132322	1	49	Band 5	10M	881.5	2525	24.28	24.34	
	Band 12	10M	711	23130	1	25	Band 66	20M	2155	66886	24.41	24.44	
Band 66	20M	1745	132322	1	49	Band 12	10M	737.5	5095	24.19	24.34		
Band 13	10M	782	23230	1	25	Band 66	20M	2155	66886	24.18	24.24		
Band 66	20M	1745	132322	1	49	Band 13	10M	751	5230	24.30	24.34		
Intra-Band	Contiguous	Band 41	20M	2506	39750	1	49	Band 41	20M	2525.8	39948	23.85	23.86
		Band 66	20M	1745	132322	1	49	Band 66	20M	2174.8	67084	24.29	24.34
	Non-Contiguous	Band 2	20M	1880	18900	1	49	Band 2	5M	1932.5	625	24.16	24.21
		Band 4	20M	1732.5	20175	1	49	Band 4	5M	2112.5	1975	24.01	24.02
		Band 66	20M	1745	132322	1	49	Band 66	5M	2112.5	66461	24.28	24.34

**<Power Level 2 for Hotspot On/P-Sensor On>**

Configure		PCC					SCC				Power		
		LTE Band	BW (MHz)	Freq. (MHz)	Channel	UL# RB	UL RB Offset	LTE Band	BW (MHz)	Freq. (MHz)	Channel	LTE Rel 10 Tx.Power (dBm)	LTE Rel 8 Tx.Power (dBm)
Inter-Band		Band 2	20M	1880	18900	1	49	Band 4	20M	2132.5	2175	19.51	19.52
		Band 4	20M	1732.5	20175	1	49	Band 2	20M	1960	900	16.28	16.30
		Band 2	20M	1880	18900	1	49	Band 66	20M	2155	66886	19.51	19.52
		Band 66	20M	1770	132572	1	49	Band 2	20M	1960	900	16.27	16.31
Intra-Band	Contiguous	Band 66	20M	1770	132572	1	49	Band 66	20M	2174.8	67084	16.25	16.31
	Non-Contiguous	Band 2	20M	1880	18900	1	49	Band 2	5M	1932.5	625	19.50	19.52
		Band 4	20M	1732.5	20175	1	49	Band 4	5M	2112.5	1975	16.30	16.30
		Band 66	20M	1770	132572	1	49	Band 66	5M	2112.5	66461	16.25	16.31

**<Power Level 3 for Default Power Mode>**

Configure		PCC					SCC				Power		
		LTE Band	BW (MHz)	Freq. (MHz)	Channel	UL# RB	UL RB Offset	LTE Band	BW (MHz)	Freq. (MHz)	Channel	LTE Rel 10 Tx.Power (dBm)	LTE Rel 8 Tx.Power (dBm)
Intra-Band	Contiguous	Band 66	20M	1745	132322	1	49	Band 66	20M	2174.8	67084	22.43	22.47
	Non-Contiguous	Band 4	20M	1732.5	20175	1	49	Band 4	5M	2112.5	1975	22.80	22.82
		Band 66	20M	1745	132322	1	49	Band 66	5M	2112.5	66461	22.41	22.47

### <WLAN Conducted Power>

#### General Note:

1. Per KDB 248227 D01v02r02, SAR test reduction is determined according to 802.11 transmission mode configurations and certain exposure conditions with multiple test positions. In the 2.4 GHz band, separate SAR procedures are applied to DSSS and OFDM configurations to simplify DSSS test requirements. For OFDM, in both 2.4 and 5 GHz bands, an initial test configuration must be determined for each standalone and aggregated frequency band, according to the transmission mode configuration with the highest maximum output power specified for production units to perform SAR measurements. If the same highest maximum output power applies to different combinations of channel bandwidths, modulations and data rates, additional procedures are applied to determine which test configurations require SAR measurement. When applicable, an initial test position may be applied to reduce the number of SAR measurements required for next to the ear, UMPC mini-tablet or hotspot mode configurations with multiple test positions.
2. For 2.4 GHz 802.11b DSSS, either the initial test position procedure for multiple exposure test positions or the DSSS procedure for fixed exposure position is applied; these are mutually exclusive. For 2.4 GHz and 5 GHz OFDM configurations, the initial test configuration is applied to measure SAR using either the initial test position procedure for multiple exposure test position configurations or the initial test configuration procedures for fixed exposure test conditions. Based on the reported SAR of the measured configurations and maximum output power of the transmission mode configurations that are not included in the initial test configuration, the subsequent test configuration and initial test position procedures are applied to determine if SAR measurements are required for the remaining OFDM transmission configurations. In general, the number of test channels that require SAR measurement is minimized based on maximum output power measured for the test sample(s).
3. For OFDM transmission configurations in the 2.4 GHz and 5 GHz bands, When the same maximum power is specified for multiple transmission modes in a frequency band, the largest channel bandwidth, lowest order modulation, lowest data rate and lowest order 802.11a/g/n/ac mode is used for SAR measurement, on the highest measured output power channel for each frequency band.
4. DSSS and OFDM configurations are considered separately according to the required SAR procedures. SAR is measured in the initial test position using the 802.11 transmission mode configuration required by the DSSS procedure or initial test configuration and subsequent test configuration(s) according to the OFDM procedures.18 The initial test position procedure is described in the following:
  - a. When the reported SAR of the initial test position is  $\leq 0.4$  W/kg, further SAR measurement is not required for the other test positions in that exposure configuration and 802.11 transmission mode combinations within the frequency band or aggregated band.
  - b. When the reported SAR of the test position is  $> 0.4$  W/kg, SAR is repeated for the 802.11 transmission mode configuration tested in the initial test position to measure the subsequent next closet/smallest test separation distance and maximum coupling test position on the highest maximum output power channel, until the report SAR is  $\leq 0.8$  W/kg or all required test position are tested.
  - c. For all positions/configurations, when the reported SAR is  $> 0.8$  W/kg, SAR is measured for these test positions/configurations on the subsequent next highest measured output power channel(s) until the reported SAR is  $\leq 1.2$  W/kg or all required channels are tested.



<2.4GHz WLAN>

	Mode	Channel	Frequency (MHz)	Average power (dBm)	Tune-Up Limit	Duty Cycle %
2.4GHz WLAN	802.11b 1Mbps	1	2412	10.20	10.50	97.59
		6	2437	9.39	10.50	
		11	2462	9.87	10.50	
	802.11g 6Mbps	1	2412	11.92	12.50	87.04
		6	2437	11.02	12.50	
		11	2462	12.07	12.50	
	802.11n-HT20 MCS0	1	2412	11.39	12.00	86.52
		6	2437	10.65	12.00	
		11	2462	11.60	12.00	

<5GHz WLAN>

	Mode	Channel	Frequency (MHz)	Average power (dBm)	Tune-Up Limit	Duty Cycle %
5.2GHz WLAN	802.11a 6Mbps	36	5180	13.21	14.00	87.50
		40	5200	12.85	14.00	
		44	5220	13.26	14.00	
		48	5240	13.59	14.00	
	802.11n-HT20 MCS0	36	5180	13.18	14.00	85.99
		40	5200	12.85	14.00	
		44	5220	13.42	14.00	
		48	5240	13.69	14.00	
	802.11n-HT40 MCS0	38	5190	13.83	14.50	85.90
		46	5230	14.12	14.50	

	Mode	Channel	Frequency (MHz)	Average power (dBm)	Tune-Up Limit	Duty Cycle %
5.3GHz WLAN	802.11a 6Mbps	52	5260	13.46	14.00	87.50
		56	5280	13.53	14.00	
		60	5300	12.80	14.00	
		64	5320	13.00	14.00	
	802.11n-HT20 MCS0	52	5260	13.30	14.00	85.99
		56	5280	13.43	14.00	
		60	5300	12.85	14.00	
		64	5320	12.98	14.00	
	802.11n-HT40 MCS0	54	5270	14.13	14.50	85.90
		62	5310	13.51	14.50	



	Mode	Channel	Frequency (MHz)	Average power (dBm)	Tune-Up Limit	Duty Cycle %
5.5GHz WLAN	802.11a 6Mbps	100	5500	13.31	14.00	87.50
		116	5580	12.99	14.00	
		132	5660	12.83	14.00	
		140	5700	13.15	14.00	
	802.11n-HT20 MCS0	100	5500	13.32	14.00	85.99
		116	5580	13.12	14.00	
		132	5660	12.87	14.00	
		140	5700	13.28	14.00	
	802.11n-HT40 MCS0	102	5510	13.78	14.50	85.90
		110	5550	13.89	14.50	
		134	5670	13.67	14.50	

	Mode	Channel	Frequency (MHz)	Average power (dBm)	Tune-Up Limit	Duty Cycle %
5.8GHz WLAN	802.11a MCS0	149	5745	12.65	14.00	87.50
		157	5785	13.45	14.00	
		165	5825	12.51	14.00	
	802.11n-HT20 MCS0	149	5745	12.71	14.00	85.99
		157	5785	13.38	14.00	
		165	5825	12.39	14.00	
	802.11n-HT40 MCS0	151	5755	13.99	14.50	85.90
		159	5795	13.89	14.50	

### 13. Bluetooth Exclusions Applied

Mode Band	Average power(dBm)	
	Bluetooth v3.0+EDR	Bluetooth v4.0/4.1/4.2 LE
2.4GHz Bluetooth	11.0	6.5

**Note:**

Per KDB 447498 D01v06, the 1-g and 10-g SAR test exclusion thresholds for 100 MHz to 6 GHz at *test separation distances* ≤ 50 mm are determined by:

$$[(\text{max. power of channel, including tune-up tolerance, mW}) / (\text{min. test separation distance, mm})] \cdot [\sqrt{f(\text{GHz})}] \leq 3.0 \text{ for 1-g SAR and } \leq 7.5 \text{ for 10-g extremity SAR}$$

- f(GHz) is the RF channel transmit frequency in GHz
- Power and distance are rounded to the nearest mW and mm before calculation
- The result is rounded to one decimal place for comparison

Bluetooth Max Power (dBm)	Frequency (GHz)	Separation Distance (mm)		Exclusion Thresholds	
		1-g SAR	10-g extremity SAR	1-g SAR	10-g extremity SAR
11.0	2.48	10	<5	2.0	4.1

**Note:**

1. Per KDB 447498 D01v06, a distance of 10 mm is applied to determine 1g SAR test exclusion. The test exclusion threshold is 2.0 which is ≤ 3, SAR testing is not required.
2. Per KDB 447498 D01v06, when the minimum test separation distance is < 5 mm, a distance of 5 mm is applied to determine SAR 10g SAR test exclusion. The test exclusion threshold is 4.1 which is ≤ 7.5, SAR testing is not required.

### 14. Antenna Location

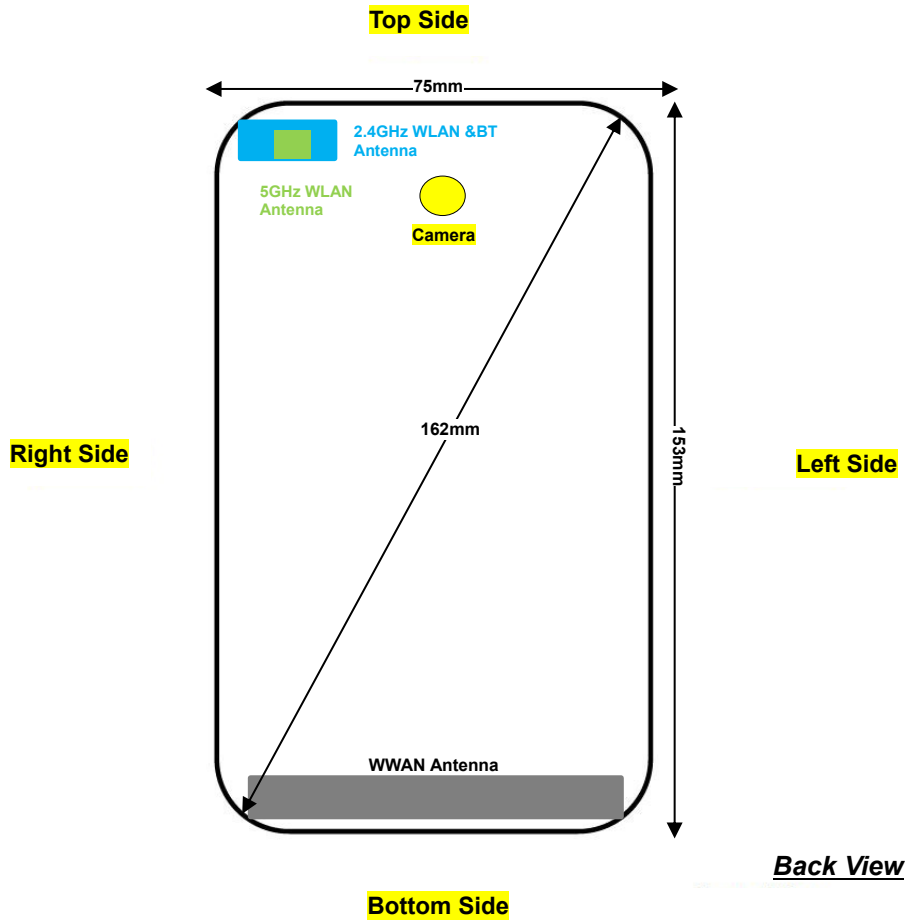

Distance of the Antenna to the EUT surface/edge						
Antennas	Back	Front	Top Side	Bottom Side	Right Side	Left Side
WWAN Antenna	≤ 25mm	≤ 25mm	>25mm	≤ 25mm	≤ 25mm	≤ 25mm
2.4GHz WLAN & BT	≤ 25mm	≤ 25mm	≤ 25mm	>25mm	≤ 25mm	>25mm
5GHz WLAN	≤ 25mm	≤ 25mm	≤ 25mm	>25mm	≤ 25mm	>25mm

Positions for SAR tests; Hotspot mode						
Antennas	Back	Front	Top Side	Bottom Side	Right Side	Left Side
WWAN Antenna	Yes	Yes	No	Yes	Yes	Yes
2.4GHz WLAN & BT	Yes	Yes	Yes	No	Yes	No
5GHz WLAN	Yes	Yes	Yes	No	Yes	No

**General Note:**

Referring to KDB 941225 D06 v02r01, when the overall device length and width are ≥ 9cm\*5cm, the test distance is 10 mm. SAR must be measured for all sides and surfaces with a transmitting antenna located within 25mm from that surface or edge.



## **15. SAR Test Results**

### **General Note:**

1. Per KDB 447498 D01v06, the reported SAR is the measured SAR value adjusted for maximum tune-up tolerance.
  - a. Tune-up scaling Factor = tune-up limit power (mW) / EUT RF power (mW), where tune-up limit is the maximum rated power among all production units.
  - b. For SAR testing of WLAN signal with non-100% duty cycle, the measured SAR is scaled-up by the duty cycle scaling factor which is equal to "1/(duty cycle)"
  - c. For WWAN: Reported SAR(W/kg)= Measured SAR(W/kg)\*Tune-up Scaling Factor
  - d. For WLAN: Reported SAR(W/kg)= Measured SAR(W/kg)\* Duty Cycle scaling factor \* Tune-up scaling factor
  - e. For TDD LTE SAR measurement, the duty cycle 1:1.59 (62.9 %) was used perform testing and considering the theoretical duty cycle of 63.3% for extended cyclic prefix in the uplink, and the theoretical duty cycle of 62.9% for normal cyclic prefix in uplink, a scaling factor of extended cyclic prefix 63.3%/62.9% = 1.006 is applied to scale-up the measured SAR result. The Reported TDD LTE SAR = measured SAR (W/kg)\* Tune-up Scaling Factor\* scaling factor for extended cyclic prefix.
2. Per KDB 447498 D01v06, for each exposure position, testing of other required channels within the operating mode of a frequency band is not required when the *reported* 1-g or 10-g SAR for the mid-band or highest output power channel is:
  - $\leq 0.8$  W/kg or 2.0 W/kg, for 1-g or 10-g respectively, when the transmission band is  $\leq 100$  MHz
  - $\leq 0.6$  W/kg or 1.5 W/kg, for 1-g or 10-g respectively, when the transmission band is between 100 MHz and 200 MHz
  - $\leq 0.4$  W/kg or 1.0 W/kg, for 1-g or 10-g respectively, when the transmission band is  $\geq 200$  MHz
3. Per KDB 865664 D01v01r04, for each frequency band, repeated SAR measurement is required only when the measured SAR is  $\geq 0.8$ W/kg.
4. Per KDB 648474 D04v01r03, when the reported SAR for a body-worn accessory measured without a headset connected to the handset is  $\leq 1.2$  W/kg, SAR testing with a headset connected to the handset is not required.
5. Per KDB648474 D04v01r03, for smart phones with a display diagonal dimension  $> 15.0$  cm or an overall diagonal dimension  $> 16.0$  cm, when hotspot mode applies, 10-g extremity SAR is required only for the surfaces and edges with hotspot mode 1-g reported SAR  $> 1.2$  W/kg, however, when power reduction applies to hotspot mode the measured SAR must be scaled to the maximum output power, including tolerance, allowed for phablet modes to compare with the 1.2 W/kg SAR test reduction threshold.
  - a. WLAN 5.3/5.5GHz tested the product specific 10g SAR since it has no hotspot mode.
  - b. When 10-g product specific 10g SAR is considered, SAR thresholds is specified in the procedures for SAR test reduction and exclusion should be multiplied by 2.5.
6. There are totally three power levels of WWAN Antenna. Power level 1 is for full power, power level 2 is for P-sensor on and hotspot on and power level 3 is for default power, detail descriptions of the power levels are as below:
  - 1) Power level 1 - When the phone is in talking mode and receiver worked, all bands are full powers.
  - 2) Power level 2 – This device hotspot reduced power and P-sensor reduced power level are the same. So only show one reduced power level for hotspot reduced power and P-sensor reduced power for this application.
    - a) The device employs proximity sensors that detect the presence of the user's body at the front or back faces of the device. When front or back body worn condition is detected, WCDMA band II/IV, CDMA2000 BC1 and LTE band 2/4/25/66 reduced power will be active. (P-sensor can't work at detecting presence of the user's body at the four edges of the device.)
    - b) When hotspot mode is enabled, power reduction will be activated to limit the maximum power of WCDMA band II/IV, CDMA2000 BC1 and LTE band 2/4/25/66.
  - 3) Power level 3 – Default power of WCDMA Band II/IV and LTE band 4/66, other WWAN bands default power is same as the power level 1.



**GSM Note:**

1. Per KDB 941225 D01v03r01, for SAR test reduction for GSM / GPRS / EDGE modes is determined by the source-based time-averaged output power including tune-up tolerance. The mode with highest specified time-averaged output power should be tested for SAR compliance in the applicable exposure conditions. For modes with the same specified maximum output power and tolerance, the higher number time-slot configuration should be tested. Therefore, the GPRS (4Tx slots) for GSM850/GSM1900 are considered as the primary mode.
2. Other configurations of GSM / GPRS / EDGE are considered as secondary modes. The 3G SAR test reduction procedure is applied, when the maximum output power and tune-up tolerance specified for production units in a secondary mode is  $\leq 1/4$  dB higher than the primary mode, SAR measurement is not required for the secondary mode.

**WCDMA Note:**

1. Per KDB 941225 D01v03r01, for SAR testing is measured using a 12.2 kbps RMC with TPC bits configured to all "1's".
2. Per KDB 941225 D01v03r01, RMC 12.2kbps setting is used to evaluate SAR. The maximum output power and tune-up tolerance specified for production units in HSDPA / HSUPA / DC-HSDPA is  $\leq 1/4$  dB higher than RMC 12.2Kbps or when the highest reported SAR of the RMC12.2Kbps is scaled by the ratio of specified maximum output power and tune-up tolerance of HSDPA / HSUPA / DC-HSDPA to RMC12.2Kbps and the adjusted SAR is  $\leq 1.2$  W/kg, SAR measurement is not required for HSDPA / HSUPA / DC-HSDPA, and according to the following RF output power, the output power results of the secondary modes (HSUPA, HSDPA, DC-HSDPA) are less than  $1/4$  dB higher than the primary modes; therefore, SAR measurement is not required for HSDPA / HSUPA / DC-HSDPA.

**CDMA Note:**

1. Per KDB 941225 D01v03r01, SAR for next to the ear head exposure is measured in RC3 with the handset configured to transmit at full rate in SO55.
2. Per KDB 941225 D01v03r01, in Hotspot mode EUT is treated as data device and SAR is tested with Ev-Do Rev 0 (RTAP 153.6kbps) as the primary mode.
3. Per KDB 941225 D01v03r01, for Body-worn accessory SAR is measured in RC3 with the handset configured in TDSO/SO32 to transmit at full rate on FCH only with all other code channels disabled. The body-worn accessory procedures in KDB Publication 447498 are applied. The 3G SAR test reduction procedure is applied to the multiple code channel configuration (FCH+SCH), with FCH only as the primary mode.

**LTE Note:**

1. Per KDB 941225 D05v02r05, start with the largest channel bandwidth and measure SAR for QPSK with 1 RB allocation, using the RB offset and required test channel combination with the highest maximum output power for RB offsets at the upper edge, middle and lower edge of each required test channel.
2. Per KDB 941225 D05v02r05, 50% RB allocation for QPSK SAR testing follows 1RB QPSK allocation procedure.
3. Per KDB 941225 D05v02r05, For QPSK with 100% RB allocation, SAR is not required when the highest maximum output power for 100 % RB allocation is less than the highest maximum output power in 50% and 1 RB allocations and the highest reported SAR for 1 RB and 50% RB allocation are  $\leq 0.8$  W/kg. Otherwise, SAR is measured for the highest output power channel; and if the reported SAR is  $> 1.45$  W/kg, the remaining required test channels must also be tested.
4. Per KDB 941225 D05v02r05, 16QAM output power for each RB allocation configuration is  $>$  not  $\frac{1}{2}$  dB higher than the same configuration in QPSK and the reported SAR for the QPSK configuration is  $\leq 1.45$  W/kg; Per KDB 941225 D05v02r05, 16QAM SAR testing is not required.
5. Per KDB 941225 D05v02r05, Smaller bandwidth output power for each RB allocation configuration is  $>$  not  $\frac{1}{2}$  dB higher than the same configuration in the largest supported bandwidth, and the reported SAR for the largest supported bandwidth is  $\leq 1.45$  W/kg; Per KDB 941225 D05v02r05, smaller bandwidth SAR testing is not required.
6. For LTE B4 / B5 / B12 / B13 / B17 / B26 the maximum bandwidth does not support three non-overlapping channels, per KDB 941225 D05v02r05, when a device supports overlapping channel assignment in a channel bandwidth configuration, the middle channel of the group of overlapping channels should be selected for testing.
7. LTE band 17 / 2 / 5 / 38 / 4 SAR test was covered by Band 12 / 25 / 26 / 41 / 66; according to April 2015 TCB workshop, SAR test for overlapping LTE bands can be reduced if
  - a. The maximum output power, including tolerance, for the smaller band is  $\leq$  the larger band to qualify for the SAR test exclusion.
  - b. The channel bandwidth and other operating parameters for the smaller band are fully supported by the larger band.

**WLAN Note:**

1. Per KDB 248227 D01v02r02, for 2.4GHz 802.11g/n SAR testing is not required when the highest reported SAR for DSSS is adjusted by the ratio of OFDM to DSSS specified maximum output power and the adjusted SAR is  $\leq 1.2$  W/kg.
2. Per KDB 248227 D01v02r02, U-NII-1 SAR testing is not required when the U-NII-2A band highest reported SAR for a test configuration is  $\leq 1.2$  W/kg, SAR is not required for U-NII-1 band.
3. When the reported SAR of the test position is  $> 0.4$  W/kg, SAR is repeated for the 802.11 transmission mode configuration tested in the initial test position to measure the subsequent next closet/smallest test separation distance and maximum coupling test position on the highest maximum output power channel, until the report SAR is  $\leq 0.8$  W/kg or all required test position are tested.
4. For all positions / configurations, when the reported SAR is  $> 0.8$  W/kg, SAR is measured for these test positions / configurations on the subsequent next highest measured output power channel(s) until the reported SAR is  $\leq 1.2$  W/kg or all required channels are tested.
5. During SAR testing the WLAN transmission was verified using a spectrum analyzer.



**15.1 Head SAR**

**<GSM SAR>**

Plot No.	Band	Mode	Test Position	Power Level	Ch.	Freq. (MHz)	Average Power (dBm)	Tune-Up Limit (dBm)	Tune-up Scaling Factor	Power Drift (dB)	Measured 1g SAR (W/kg)	Reported 1g SAR (W/kg)
01	GSM850	GPRS 4 Tx slots	Right Cheek	1	189	836.4	29.94	30.5	1.138	0.09	0.111	<b>0.126</b>
	GSM850	GPRS 4 Tx slots	Right Tilted	1	189	836.4	29.94	30.5	1.138	-0.01	0.054	0.061
	GSM850	GPRS 4 Tx slots	Left Cheek	1	189	836.4	29.94	30.5	1.138	0.03	0.103	0.117
	GSM850	GPRS 4 Tx slots	Left Tilted	1	189	836.4	29.94	30.5	1.138	-0.12	0.054	0.061
	GSM1900	GPRS 4 Tx slots	Right Cheek	1	512	1850.2	24.12	24.5	1.091	0.02	0.022	0.024
	GSM1900	GPRS 4 Tx slots	Right Tilted	1	512	1850.2	24.12	24.5	1.091	0.14	0.020	0.022
02	GSM1900	GPRS 4 Tx slots	Left Cheek	1	512	1850.2	24.12	24.5	1.091	0.01	0.051	<b>0.056</b>
	GSM1900	GPRS 4 Tx slots	Left Tilted	1	512	1850.2	24.12	24.5	1.091	0.17	0.018	0.020

**<WCDMA SAR>**

Plot No.	Band	Mode	Test Position	Power Level	Ch.	Freq. (MHz)	Average Power (dBm)	Tune-Up Limit (dBm)	Tune-up Scaling Factor	Power Drift (dB)	Measured 1g SAR (W/kg)	Reported 1g SAR (W/kg)
03	WCDMA Band V	RMC12.2Kbps	Right Cheek	1	4233	846.6	24.47	24.5	1.007	0.1	0.158	<b>0.159</b>
	WCDMA Band V	RMC12.2Kbps	Right Tilted	1	4233	846.6	24.47	24.5	1.007	-0.03	0.090	0.091
	WCDMA Band V	RMC12.2Kbps	Left Cheek	1	4233	846.6	24.47	24.5	1.007	0.07	0.143	0.144
	WCDMA Band V	RMC12.2Kbps	Left Tilted	1	4233	846.6	24.47	24.5	1.007	-0.13	0.095	0.096
	WCDMA Band IV	RMC12.2Kbps	Right Cheek	1	1513	1752.6	24.21	24.5	1.069	0.03	0.223	0.238
	WCDMA Band IV	RMC12.2Kbps	Right Tilted	1	1513	1752.6	24.21	24.5	1.069	-0.11	0.188	0.201
04	WCDMA Band IV	RMC12.2Kbps	Left Cheek	1	1513	1752.6	24.21	24.5	1.069	0.05	0.333	<b>0.356</b>
	WCDMA Band IV	RMC12.2Kbps	Left Tilted	1	1513	1752.6	24.21	24.5	1.069	-0.04	0.174	0.186
	WCDMA Band II	RMC12.2Kbps	Right Cheek	1	9538	1907.6	24.17	24.5	1.079	0.03	0.159	0.172
	WCDMA Band II	RMC12.2Kbps	Right Tilted	1	9538	1907.6	24.17	24.5	1.079	-0.17	0.139	0.150
05	WCDMA Band II	RMC12.2Kbps	Left Cheek	1	9538	1907.6	24.17	24.5	1.079	0.08	0.227	<b>0.245</b>
	WCDMA Band II	RMC12.2Kbps	Left Tilted	1	9538	1907.6	24.17	24.5	1.079	0.07	0.069	0.074



<CDMA2000 SAR>

Plot No.	Band	Mode	Test Position	Power Level	Ch.	Freq. (MHz)	Average Power (dBm)	Tune-Up Limit (dBm)	Tune-up Scaling Factor	Power Drift (dB)	Measured 1g SAR (W/kg)	Reported 1g SAR (W/kg)
06	CDMA2000 BC10	RC3 SO55	Right Cheek	1	476	817.9	24.4	24.5	1.023	-0.06	0.219	0.224
	CDMA2000 BC10	RC3 SO55	Right Tilted	1	476	817.9	24.4	24.5	1.023	-0.03	0.109	0.112
	CDMA2000 BC10	RC3 SO55	Left Cheek	1	476	817.9	24.4	24.5	1.023	0.06	0.187	0.191
	CDMA2000 BC10	RC3 SO55	Left Tilted	1	476	817.9	24.4	24.5	1.023	-0.09	0.105	0.107
07	CDMA2000 BC0	RC3 SO55	Right Cheek	1	777	848.31	24.39	24.5	1.026	-0.03	0.301	0.309
	CDMA2000 BC0	RC3 SO55	Right Tilted	1	777	848.31	24.39	24.5	1.026	-0.16	0.161	0.165
	CDMA2000 BC0	RC3 SO55	Left Cheek	1	777	848.31	24.39	24.5	1.026	0.04	0.249	0.255
	CDMA2000 BC0	RC3 SO55	Left Tilted	1	777	848.31	24.39	24.5	1.026	-0.09	0.138	0.142
	CDMA2000 BC1	RC3 SO55	Right Cheek	1	1175	1908.75	23.72	24.5	1.197	0.03	0.118	0.141
	CDMA2000 BC1	RC3 SO55	Right Tilted	1	1175	1908.75	23.72	24.5	1.197	0.06	0.098	0.117
08	CDMA2000 BC1	RC3 SO55	Left Cheek	1	1175	1908.75	23.72	24.5	1.197	0.01	0.268	0.321
	CDMA2000 BC1	RC3 SO55	Left Tilted	1	1175	1908.75	23.72	24.5	1.197	0.02	0.094	0.112



<FDD LTE SAR>

Plot No.	Band	BW (MHz)	Modulation	RB Size	RB Offset	Test Position	Power Level	Ch.	Freq. (MHz)	Average Power (dBm)	Tune-Up Limit (dBm)	Tune-up Scaling Factor	Power Drift (dB)	Measured 1g SAR (W/kg)	Reported 1g SAR (W/kg)
09	LTE Band 12	10M	QPSK	1	25	Right Cheek	1	23095	707.5	23.85	24.5	1.161	0.02	0.123	<b>0.143</b>
	LTE Band 12	10M	QPSK	25	0	Right Cheek	1	23095	707.5	22.99	23.5	1.125	0.03	0.090	0.101
	LTE Band 12	10M	QPSK	1	25	Right Tilted	1	23095	707.5	23.85	24.5	1.161	0.01	0.065	0.075
	LTE Band 12	10M	QPSK	25	0	Right Tilted	1	23095	707.5	22.99	23.5	1.125	0.1	0.049	0.055
	LTE Band 12	10M	QPSK	1	25	Left Cheek	1	23095	707.5	23.85	24.5	1.161	0.03	0.109	0.127
	LTE Band 12	10M	QPSK	25	0	Left Cheek	1	23095	707.5	22.99	23.5	1.125	0.1	0.078	0.088
	LTE Band 12	10M	QPSK	1	25	Left Tilted	1	23095	707.5	23.85	24.5	1.161	0.05	0.059	0.069
	LTE Band 12	10M	QPSK	25	0	Left Tilted	1	23095	707.5	22.99	23.5	1.125	0.11	0.044	0.049
	LTE Band 13	10M	QPSK	1	25	Right Cheek	1	23230	782	24.24	24.5	1.062	0.05	0.189	0.201
	LTE Band 13	10M	QPSK	25	0	Right Cheek	1	23230	782	22.81	23.5	1.172	0.02	0.153	0.179
	LTE Band 13	10M	QPSK	1	25	Right Tilted	1	23230	782	24.24	24.5	1.062	-0.13	0.106	0.113
	LTE Band 13	10M	QPSK	25	0	Right Tilted	1	23230	782	22.81	23.5	1.172	-0.01	0.083	0.097
10	LTE Band 13	10M	QPSK	1	25	Left Cheek	1	23230	782	24.24	24.5	1.062	0.07	0.212	<b>0.225</b>
	LTE Band 13	10M	QPSK	25	0	Left Cheek	1	23230	782	22.81	23.5	1.172	0.03	0.169	0.198
	LTE Band 13	10M	QPSK	1	25	Left Tilted	1	23230	782	24.24	24.5	1.062	0.07	0.141	0.150
	LTE Band 13	10M	QPSK	25	0	Left Tilted	1	23230	782	22.81	23.5	1.172	0.01	0.098	0.115
11	LTE Band 26	15M	QPSK	1	37	Right Cheek	1	26865	831.5	23.85	24.5	1.161	0.06	0.184	<b>0.214</b>
	LTE Band 26	15M	QPSK	36	0	Right Cheek	1	26865	831.5	22.85	23.5	1.161	0.03	0.134	0.156
	LTE Band 26	15M	QPSK	1	37	Right Tilted	1	26865	831.5	23.85	24.5	1.161	-0.12	0.107	0.124
	LTE Band 26	15M	QPSK	36	0	Right Tilted	1	26865	831.5	22.85	23.5	1.161	-0.16	0.075	0.087
	LTE Band 26	15M	QPSK	1	37	Left Cheek	1	26865	831.5	23.85	24.5	1.161	0.07	0.174	0.202
	LTE Band 26	15M	QPSK	36	0	Left Cheek	1	26865	831.5	22.85	23.5	1.161	0.03	0.135	0.157
	LTE Band 26	15M	QPSK	1	37	Left Tilted	1	26865	831.5	23.85	24.5	1.161	-0.1	0.113	0.131
	LTE Band 26	15M	QPSK	36	0	Left Tilted	1	26865	831.5	22.85	23.5	1.161	-0.12	0.088	0.102
	LTE Band 66	20M	QPSK	1	49	Right Cheek	1	132322	1745	24.34	24.5	1.038	0.03	0.127	0.132
	LTE Band 66	20M	QPSK	50	0	Right Cheek	1	132322	1745	22.87	23.5	1.156	0.01	0.068	0.079
	LTE Band 66	20M	QPSK	1	49	Right Tilted	1	132322	1745	24.34	24.5	1.038	0.03	0.076	0.079
	LTE Band 66	20M	QPSK	50	0	Right Tilted	1	132322	1745	22.87	23.5	1.156	-0.12	0.043	0.050
12	LTE Band 66	20M	QPSK	1	49	Left Cheek	1	132322	1745	24.34	24.5	1.038	0.09	0.327	<b>0.339</b>
	LTE Band 66	20M	QPSK	50	0	Left Cheek	1	132322	1745	22.87	23.5	1.156	0.07	0.177	0.205
	LTE Band 66	20M	QPSK	1	49	Left Tilted	1	132322	1745	24.34	24.5	1.038	-0.01	0.166	0.172
	LTE Band 66	20M	QPSK	50	0	Left Tilted	1	132322	1745	22.87	23.5	1.156	-0.07	0.089	0.103
	LTE Band 25	20M	QPSK	1	49	Right Cheek	1	26140	1860	24.15	24.5	1.084	-0.01	0.083	0.090
	LTE Band 25	20M	QPSK	50	0	Right Cheek	1	26140	1860	22.87	23.5	1.156	0.07	0.052	0.060
	LTE Band 25	20M	QPSK	1	49	Right Tilted	1	26140	1860	24.15	24.5	1.084	0.03	0.062	0.067
	LTE Band 25	20M	QPSK	50	0	Right Tilted	1	26140	1860	22.87	23.5	1.156	0.03	0.039	0.045
13	LTE Band 25	20M	QPSK	1	49	Left Cheek	1	26140	1860	24.15	24.5	1.084	0.03	0.179	<b>0.194</b>
	LTE Band 25	20M	QPSK	50	0	Left Cheek	1	26140	1860	22.87	23.5	1.156	-0.16	0.119	0.138
	LTE Band 25	20M	QPSK	1	49	Left Tilted	1	26140	1860	24.15	24.5	1.084	0.07	0.073	0.079
	LTE Band 25	20M	QPSK	50	0	Left Tilted	1	26140	1860	22.87	23.5	1.156	-0.03	0.042	0.049
	LTE Band 7	20M	QPSK	1	49	Right Cheek	1	21100	2535	24.23	24.5	1.064	0.18	0.171	0.182
	LTE Band 7	20M	QPSK	50	0	Right Cheek	1	21100	2535	22.93	23.5	1.140	-0.03	0.135	0.154
	LTE Band 7	20M	QPSK	1	49	Right Tilted	1	21100	2535	24.23	24.5	1.064	-0.16	0.167	0.178
	LTE Band 7	20M	QPSK	50	0	Right Tilted	1	21100	2535	22.93	23.5	1.140	-0.02	0.132	0.151
14	LTE Band 7	20M	QPSK	1	49	Left Cheek	1	21100	2535	24.23	24.5	1.064	0.05	0.392	<b>0.417</b>
	LTE Band 7	20M	QPSK	50	0	Left Cheek	1	21100	2535	22.93	23.5	1.140	0.01	0.310	0.353
	LTE Band 7	20M	QPSK	1	49	Left Tilted	1	21100	2535	24.23	24.5	1.064	0.07	0.118	0.126
	LTE Band 7	20M	QPSK	50	0	Left Tilted	1	21100	2535	22.93	23.5	1.140	0.05	0.094	0.107



<TDD LTE SAR>

Plot No.	Band	BW (MHz)	Modulation	RB Size	RB Offset	Test Position	Power Level	Ch.	Freq. (MHz)	Average Power (dBm)	Tune-Up Limit (dBm)	Tune-up Scaling Factor	Duty Cycle %	Duty Cycle Scaling Factor	Power Drift (dB)	Measured 1g SAR (W/kg)	Reported 1g SAR (W/kg)
	LTE Band 41	20M	QPSK	1	49	Right Cheek	1	39750	2506	23.86	24.5	1.159	62.9	1.006	0.07	0.130	0.152
	LTE Band 41	20M	QPSK	50	24	Right Cheek	1	39750	2506	22.75	23.5	1.189	62.9	1.006	-0.01	0.063	0.075
	LTE Band 41	20M	QPSK	1	49	Right Tilted	1	39750	2506	23.86	24.5	1.159	62.9	1.006	0.18	0.107	0.125
	LTE Band 41	20M	QPSK	50	24	Right Tilted	1	39750	2506	22.75	23.5	1.189	62.9	1.006	-0.03	0.059	0.071
15	LTE Band 41	20M	QPSK	1	49	Left Cheek	1	39750	2506	23.86	24.5	1.159	62.9	1.006	0.03	0.311	<b>0.363</b>
	LTE Band 41	20M	QPSK	50	24	Left Cheek	1	39750	2506	22.75	23.5	1.189	62.9	1.006	0.06	0.171	0.204
	LTE Band 41	20M	QPSK	1	49	Left Tilted	1	39750	2506	23.86	24.5	1.159	62.9	1.006	0.07	0.078	0.091
	LTE Band 41	20M	QPSK	50	24	Left Tilted	1	39750	2506	22.75	23.5	1.189	62.9	1.006	0.07	0.038	0.045

<WLAN SAR>

Plot No.	Band	Mode	Test Position	Ch.	Freq. (MHz)	Average Power (dBm)	Tune-Up Limit (dBm)	Tune-up Scaling Factor	Duty Cycle %	Duty Cycle Scaling Factor	Power Drift (dB)	Max Area Scan SAR	Measured 1g SAR (W/kg)	Reported 1g SAR (W/kg)
	WLAN2.4GHz	802.11g 6Mbps	Right Cheek	11	2462	12.07	12.5	1.104	87.04	1.149		0.135		
	WLAN2.4GHz	802.11g 6Mbps	Right Tilted	11	2462	12.07	12.5	1.104	87.04	1.149		0.117		
16	WLAN2.4GHz	802.11g 6Mbps	Left Cheek	11	2462	12.07	12.5	1.104	87.04	1.149	-0.03	0.494	0.282	<b>0.358</b>
	WLAN2.4GHz	802.11g 6Mbps	Left Tilted	11	2462	12.07	12.5	1.104	87.04	1.149		0.383		
	WLAN 5.3GHz	802.11n-HT40 MCS0	Right Cheek	54	5270	14.13	14.5	1.089	85.9	1.164		0.651		
	WLAN 5.3GHz	802.11n-HT40 MCS0	Right Tilted	54	5270	14.13	14.5	1.089	85.9	1.164		0.462		
17	WLAN 5.3GHz	802.11n-HT40 MCS0	Left Cheek	54	5270	14.13	14.5	1.089	85.9	1.164	-0.07	1.731	0.665	<b>0.843</b>
	WLAN 5.3GHz	802.11n-HT40 MCS0	Left Tilted	54	5270	14.13	14.5	1.089	85.9	1.164	0.01	1.174	0.455	0.577
	WLAN 5.3GHz	802.11n-HT40 MCS0	Left Cheek	62	5310	13.51	14.5	1.256	85.9	1.164	-0.09		0.561	0.820
	WLAN 5.5GHz	802.11n-HT40 MCS0	Right Cheek	110	5550	13.89	14.5	1.151	85.9	1.164	0.05	0.664	0.237	0.317
	WLAN 5.5GHz	802.11n-HT40 MCS0	Right Tilted	110	5550	13.89	14.5	1.151	85.9	1.164		0.557		
18	WLAN 5.5GHz	802.11n-HT40 MCS0	Left Cheek	110	5550	13.89	14.5	1.151	85.9	1.164	-0.04	2.019	0.807	<b>1.081</b>
	WLAN 5.5GHz	802.11n-HT40 MCS0	Left Cheek	102	5510	13.78	14.5	1.180	85.9	1.164	-0.06		0.692	0.951
	WLAN 5.5GHz	802.11n-HT40 MCS0	Left Tilted	110	5550	13.89	14.5	1.151	85.9	1.164	-0.04	1.579	0.616	0.825
	WLAN 5.5GHz	802.11n-HT40 MCS0	Left Tilted	102	5510	13.78	14.5	1.180	85.9	1.164	-0.06		0.455	0.625
	WLAN 5.8GHz	802.11n-HT40 MCS0	Right Cheek	151	5755	13.99	14.5	1.125	85.9	1.164		0.541		
	WLAN 5.8GHz	802.11n-HT40 MCS0	Right Tilted	151	5755	13.99	14.5	1.125	85.9	1.164		0.409		
	WLAN 5.8GHz	802.11n-HT40 MCS0	Left Cheek	151	5755	13.99	14.5	1.125	85.9	1.164	-0.07	1.676	0.669	0.876
19	WLAN 5.8GHz	802.11n-HT40 MCS0	Left Cheek	159	5795	13.89	14.5	1.151	85.9	1.164	-0.03		0.675	<b>0.904</b>
	WLAN 5.8GHz	802.11n-HT40 MCS0	Left Tilted	151	5755	13.99	14.5	1.125	85.9	1.164	-0.03	1.463	0.480	0.628



**15.2 Hotspot SAR**

**<GSM SAR>**

Plot No.	Band	Mode	Test Position	Gap (mm)	Power Level	Ch.	Freq. (MHz)	Average Power (dBm)	Tune-Up Limit (dBm)	Tune-up Scaling Factor	Power Drift (dB)	Measured 1g SAR (W/kg)	Reported 1g SAR (W/kg)
	GSM850	GPRS 4 Tx slots	Front	10	1	189	836.4	29.94	30.5	1.138	-0.19	0.218	0.248
	GSM850	GPRS 4 Tx slots	Back	10	1	189	836.4	29.94	30.5	1.138	0.01	0.261	0.297
	GSM850	GPRS 4 Tx slots	Left Side	10	1	189	836.4	29.94	30.5	1.138	0.11	0.224	0.255
20	GSM850	GPRS 4 Tx slots	Right Side	10	1	189	836.4	29.94	30.5	1.138	0.19	0.285	0.324
	GSM850	GPRS 4 Tx slots	Bottom Side	10	1	189	836.4	29.94	30.5	1.138	0.01	0.060	0.068
	GSM1900	GPRS 4 Tx slots	Front	10	1	512	1850.2	24.12	24.5	1.091	0.04	0.631	0.689
	GSM1900	GPRS 4 Tx slots	Back	10	1	512	1850.2	24.12	24.5	1.091	0.06	0.900	0.982
	GSM1900	GPRS 4 Tx slots	Back	10	1	661	1880	24.09	24.5	1.099	0.02	0.883	0.970
	GSM1900	GPRS 4 Tx slots	Back	10	1	810	1909.8	24.09	24.5	1.099	0.04	0.887	0.975
	GSM1900	GPRS 4 Tx slots	Left Side	10	1	512	1850.2	24.12	24.5	1.091	0.04	0.101	0.110
	GSM1900	GPRS 4 Tx slots	Right Side	10	1	512	1850.2	24.12	24.5	1.091	0	0.025	0.027
	GSM1900	GPRS 4 Tx slots	Bottom Side	10	1	512	1850.2	24.12	24.5	1.091	0.09	0.941	1.027
21	GSM1900	GPRS 4 Tx slots	Bottom Side	10	1	661	1880	24.09	24.5	1.099	-0.01	1.050	1.154
	GSM1900	GPRS 4 Tx slots	Bottom Side	10	1	810	1909.8	24.09	24.5	1.099	0.03	0.979	1.076

**<WCDMA SAR>**

Plot No.	Band	Mode	Test Position	Gap (mm)	Power Level	Ch.	Freq. (MHz)	Average Power (dBm)	Tune-Up Limit (dBm)	Tune-up Scaling Factor	Power Drift (dB)	Measured 1g SAR (W/kg)	Reported 1g SAR (W/kg)
	WCDMA Band V	RMC 12.2Kbps	Front	10	1	4233	846.6	24.47	24.5	1.007	-0.06	0.278	0.280
	WCDMA Band V	RMC 12.2Kbps	Back	10	1	4233	846.6	24.47	24.5	1.007	-0.16	0.324	0.326
	WCDMA Band V	RMC 12.2Kbps	Left Side	10	1	4233	846.6	24.47	24.5	1.007	-0.01	0.257	0.259
22	WCDMA Band V	RMC 12.2Kbps	Right Side	10	1	4233	846.6	24.47	24.5	1.007	0.19	0.609	0.613
	WCDMA Band V	RMC 12.2Kbps	Bottom Side	10	1	4233	846.6	24.47	24.5	1.007	0.01	0.098	0.099
	WCDMA Band IV	RMC 12.2Kbps	Front	10	2	1513	1752.6	17.11	17.5	1.094	0.05	0.597	0.653
	WCDMA Band IV	RMC 12.2Kbps	Back	10	2	1513	1752.6	17.11	17.5	1.094	-0.04	0.727	0.795
	WCDMA Band IV	RMC 12.2Kbps	Left Side	10	2	1513	1752.6	17.11	17.5	1.094	-0.02	0.120	0.131
	WCDMA Band IV	RMC 12.2Kbps	Right Side	10	2	1513	1752.6	17.11	17.5	1.094	-0.03	0.053	0.058
23	WCDMA Band IV	RMC 12.2Kbps	Bottom Side	10	2	1513	1752.6	17.11	17.5	1.094	-0.03	0.894	0.978
	WCDMA Band IV	RMC 12.2Kbps	Bottom Side	10	2	1312	1712.4	16.17	17.5	1.358	0.02	0.462	0.628
	WCDMA Band IV	RMC 12.2Kbps	Bottom Side	10	2	1413	1732.6	16.87	17.5	1.156	-0.03	0.633	0.732
	WCDMA Band II	RMC 12.2Kbps	Front	10	2	9538	1907.6	19.61	20	1.094	-0.04	0.548	0.599
	WCDMA Band II	RMC 12.2Kbps	Back	10	2	9538	1907.6	19.61	20	1.094	-0.19	0.703	0.769
	WCDMA Band II	RMC 12.2Kbps	Left Side	10	2	9538	1907.6	19.61	20	1.094	0.07	0.087	0.095
	WCDMA Band II	RMC 12.2Kbps	Right Side	10	2	9538	1907.6	19.61	20	1.094	-0.05	0.037	0.040
	WCDMA Band II	RMC 12.2Kbps	Bottom Side	10	2	9538	1907.6	19.61	20	1.094	-0.04	0.842	0.921
	WCDMA Band II	RMC 12.2Kbps	Bottom Side	10	2	9262	1852.4	18.71	20	1.346	-0.04	0.741	0.997
24	WCDMA Band II	RMC 12.2Kbps	Bottom Side	10	2	9400	1880	19.09	20	1.233	0.03	0.809	0.998



<CDMA2000 SAR>

Plot No.	Band	Mode	Test Position	Gap (mm)	Power Level	Ch.	Freq. (MHz)	Average Power (dBm)	Tune-Up Limit (dBm)	Tune-up Scaling Factor	Power Drift (dB)	Measured 1g SAR (W/kg)	Reported 1g SAR (W/kg)
	CDMA2000 BC10	RTAP 153.6Kbps	Front	10	1	476	817.9	23.91	24.5	1.146	-0.16	0.268	0.307
	CDMA2000 BC10	RTAP 153.6Kbps	Back	10	1	476	817.9	23.91	24.5	1.146	-0.19	0.317	0.363
	CDMA2000 BC10	RTAP 153.6Kbps	Left Side	10	1	476	817.9	23.91	24.5	1.146	0.13	0.224	0.257
25	CDMA2000 BC10	RTAP 153.6Kbps	Right Side	10	1	476	817.9	23.91	24.5	1.146	-0.05	0.390	0.447
	CDMA2000 BC10	RTAP 153.6Kbps	Bottom Side	10	1	476	817.9	23.91	24.5	1.146	0.02	0.075	0.086
	CDMA2000 BC0	RTAP 153.6Kbps	Front	10	1	777	848.31	23.98	24.5	1.127	-0.04	0.340	0.383
	CDMA2000 BC0	RTAP 153.6Kbps	Back	10	1	777	848.31	23.98	24.5	1.127	0.03	0.391	0.441
	CDMA2000 BC0	RTAP 153.6Kbps	Left Side	10	1	777	848.31	23.98	24.5	1.127	0	0.304	0.343
26	CDMA2000 BC0	RTAP 153.6Kbps	Right Side	10	1	777	848.31	23.98	24.5	1.127	-0.05	0.505	0.569
	CDMA2000 BC0	RTAP 153.6Kbps	Bottom Side	10	1	777	848.31	23.98	24.5	1.127	0.1	0.122	0.138
	CDMA2000 BC1	RTAP 153.6Kbps	Front	10	2	1175	1908.75	19.67	20	1.079	0.03	0.523	0.564
	CDMA2000 BC1	RTAP 153.6Kbps	Back	10	2	1175	1908.75	19.67	20	1.079	0.05	0.701	0.756
	CDMA2000 BC1	RTAP 153.6Kbps	Left Side	10	2	1175	1908.75	19.67	20	1.079	0.1	0.091	0.098
	CDMA2000 BC1	RTAP 153.6Kbps	Right Side	10	2	1175	1908.75	19.67	20	1.079	0.01	0.031	0.033
27	CDMA2000 BC1	RTAP 153.6Kbps	Bottom Side	10	2	1175	1908.75	19.67	20	1.079	-0.11	0.910	0.982
	CDMA2000 BC1	RTAP 153.6Kbps	Bottom Side	10	2	25	1851.25	18.96	20	1.271	-0.11	0.757	0.962
	CDMA2000 BC1	RTAP 153.6Kbps	Bottom Side	10	2	600	1880	19.47	20	1.130	-0.09	0.797	0.900



<FDD LTE SAR>

Plot No.	Band	BW (MHz)	Modulation	RB Size	RB Offset	Test Position	Gap (mm)	Power Level	Ch.	Freq. (MHz)	Average Power (dBm)	Tune-Up Limit (dBm)	Tune-up Scaling Factor	Power Drift (dB)	Measured 1g SAR (W/kg)	Reported 1g SAR (W/kg)
	LTE Band 12	10M	QPSK	1	25	Front	10	1	23095	707.5	23.85	24.5	1.161	-0.13	0.194	0.225
	LTE Band 12	10M	QPSK	25	0	Front	10	1	23095	707.5	22.99	23.5	1.125	-0.18	0.129	0.145
28	LTE Band 12	10M	QPSK	1	25	Back	10	1	23095	707.5	23.85	24.5	1.161	0.06	0.246	0.286
	LTE Band 12	10M	QPSK	25	0	Back	10	1	23095	707.5	22.99	23.5	1.125	-0.17	0.183	0.206
	LTE Band 12	10M	QPSK	1	25	Left Side	10	1	23095	707.5	23.85	24.5	1.161	-0.13	0.116	0.135
	LTE Band 12	10M	QPSK	25	0	Left Side	10	1	23095	707.5	22.99	23.5	1.125	-0.05	0.087	0.098
	LTE Band 12	10M	QPSK	1	25	Right Side	10	1	23095	707.5	23.85	24.5	1.161	-0.01	0.169	0.196
	LTE Band 12	10M	QPSK	25	0	Right Side	10	1	23095	707.5	22.99	23.5	1.125	-0.07	0.146	0.164
	LTE Band 12	10M	QPSK	1	25	Bottom Side	10	1	23095	707.5	23.85	24.5	1.161	0.03	0.050	0.058
	LTE Band 12	10M	QPSK	25	0	Bottom Side	10	1	23095	707.5	22.99	23.5	1.125	0.01	0.036	0.040
	LTE Band 13	10M	QPSK	1	25	Front	10	1	23230	782	24.24	24.5	1.062	-0.05	0.281	0.298
	LTE Band 13	10M	QPSK	25	0	Front	10	1	23230	782	22.81	23.5	1.172	-0.17	0.229	0.268
	LTE Band 13	10M	QPSK	1	25	Back	10	1	23230	782	24.24	24.5	1.062	-0.18	0.318	0.338
	LTE Band 13	10M	QPSK	25	0	Back	10	1	23230	782	22.81	23.5	1.172	-0.15	0.262	0.307
	LTE Band 13	10M	QPSK	1	25	Left Side	10	1	23230	782	24.24	24.5	1.062	-0.05	0.310	0.329
	LTE Band 13	10M	QPSK	25	0	Left Side	10	1	23230	782	22.81	23.5	1.172	0.01	0.247	0.290
29	LTE Band 13	10M	QPSK	1	25	Right Side	10	1	23230	782	24.24	24.5	1.062	-0.16	0.368	0.391
	LTE Band 13	10M	QPSK	25	0	Right Side	10	1	23230	782	22.81	23.5	1.172	-0.05	0.289	0.339
	LTE Band 13	10M	QPSK	1	25	Bottom Side	10	1	23230	782	24.24	24.5	1.062	0.17	0.100	0.106
	LTE Band 13	10M	QPSK	25	0	Bottom Side	10	1	23230	782	22.81	23.5	1.172	0.04	0.079	0.093
	LTE Band 26	15M	QPSK	1	37	Front	10	1	26865	831.5	23.85	24.5	1.161	-0.17	0.164	0.190
	LTE Band 26	15M	QPSK	36	0	Front	10	1	26865	831.5	22.85	23.5	1.161	0.01	0.128	0.149
	LTE Band 26	15M	QPSK	1	37	Back	10	1	26865	831.5	23.85	24.5	1.161	0.07	0.268	0.311
	LTE Band 26	15M	QPSK	36	0	Back	10	1	26865	831.5	22.85	23.5	1.161	-0.1	0.192	0.223
	LTE Band 26	15M	QPSK	1	37	Left Side	10	1	26865	831.5	23.85	24.5	1.161	-0.03	0.268	0.311
	LTE Band 26	15M	QPSK	36	0	Left Side	10	1	26865	831.5	22.85	23.5	1.161	0.03	0.199	0.231
30	LTE Band 26	15M	QPSK	1	37	Right Side	10	1	26865	831.5	23.85	24.5	1.161	0.05	0.365	0.424
	LTE Band 26	15M	QPSK	36	0	Right Side	10	1	26865	831.5	22.85	23.5	1.161	-0.03	0.263	0.305
	LTE Band 26	15M	QPSK	1	37	Bottom Side	10	1	26865	831.5	23.85	24.5	1.161	0.03	0.077	0.089
	LTE Band 26	15M	QPSK	36	0	Bottom Side	10	1	26865	831.5	22.85	23.5	1.161	0.06	0.053	0.062
	LTE Band 66	20M	QPSK	1	49	Front	10	2	132572	1770	16.31	16.5	1.045	0.01	0.469	0.490
	LTE Band 66	20M	QPSK	50	0	Front	10	2	132572	1770	16.1	16.5	1.096	-0.11	0.457	0.501
31	LTE Band 66	20M	QPSK	1	49	Back	10	2	132572	1770	16.31	16.5	1.045	0.04	0.616	0.644
	LTE Band 66	20M	QPSK	50	0	Back	10	2	132572	1770	16.1	16.5	1.096	-0.11	0.585	0.641
	LTE Band 66	20M	QPSK	1	49	Left Side	10	2	132572	1770	16.31	16.5	1.045	0.03	0.093	0.097
	LTE Band 66	20M	QPSK	50	0	Left Side	10	2	132572	1770	16.1	16.5	1.096	0.01	0.092	0.101
	LTE Band 66	20M	QPSK	1	49	Right Side	10	2	132572	1770	16.31	16.5	1.045	-0.02	0.035	0.037
	LTE Band 66	20M	QPSK	50	0	Right Side	10	2	132572	1770	16.1	16.5	1.096	0.02	0.034	0.037
	LTE Band 66	20M	QPSK	1	49	Bottom Side	10	2	132572	1770	16.31	16.5	1.045	0.02	0.599	0.626
	LTE Band 66	20M	QPSK	50	0	Bottom Side	10	2	132572	1770	16.1	16.5	1.096	0.09	0.560	0.614



Plot No.	Band	BW (MHz)	Modulation	RB Size	RB Offset	Test Position	Gap (mm)	Power Level	Ch.	Freq. (MHz)	Average Power (dBm)	Tune-Up Limit (dBm)	Tune-up Scaling Factor	Power Drift (dB)	Measured 1g SAR (W/kg)	Reported 1g SAR (W/kg)
	LTE Band 25	20M	QPSK	1	49	Front	10	2	26140	1860	18.98	19.5	1.127	0.03	0.489	0.551
	LTE Band 25	20M	QPSK	50	0	Front	10	2	26140	1860	18.75	19.5	1.189	0.13	0.465	0.553
	LTE Band 25	20M	QPSK	1	49	Back	10	2	26140	1860	18.98	19.5	1.127	0.09	0.686	0.773
	LTE Band 25	20M	QPSK	50	0	Back	10	2	26140	1860	18.75	19.5	1.189	-0.07	0.564	0.670
	LTE Band 25	20M	QPSK	1	49	Left Side	10	2	26140	1860	18.98	19.5	1.127	0.14	0.071	0.080
	LTE Band 25	20M	QPSK	50	0	Left Side	10	2	26140	1860	18.75	19.5	1.189	0.14	0.070	0.083
	LTE Band 25	20M	QPSK	1	49	Right Side	10	2	26140	1860	18.98	19.5	1.127	-0.17	0.027	0.030
	LTE Band 25	20M	QPSK	50	0	Right Side	10	2	26140	1860	18.75	19.5	1.189	-0.05	0.024	0.029
	LTE Band 25	20M	QPSK	1	49	Bottom Side	10	2	26140	1860	18.98	19.5	1.127	0.09	0.707	0.797
	LTE Band 25	20M	QPSK	50	0	Bottom Side	10	2	26140	1860	18.75	19.5	1.189	0.07	0.716	0.851
	LTE Band 25	20M	QPSK	50	0	Bottom Side	10	2	26340	1880	18.73	19.5	1.194	0.06	0.725	0.866
	LTE Band 25	20M	QPSK	50	0	Bottom Side	10	2	26590	1905	18.6	19.5	1.230	0.06	0.703	0.865
32	LTE Band 25	20M	QPSK	100	0	Bottom Side	10	2	26140	1860	18.74	19.5	1.191	0.1	0.752	0.896
	LTE Band 7	20M	QPSK	1	49	Front	10	1	21100	2535	24.23	24.5	1.064	0.08	0.659	0.701
	LTE Band 7	20M	QPSK	50	0	Front	10	1	21100	2535	22.93	23.5	1.140	0.11	0.320	0.365
	LTE Band 7	20M	QPSK	1	49	Back	10	1	21100	2535	24.23	24.5	1.064	0.03	0.851	0.906
	LTE Band 7	20M	QPSK	1	49	Back	10	1	20850	2510	23.68	24.5	1.208	-0.02	0.823	0.994
	LTE Band 7	20M	QPSK	1	49	Back	10	1	21350	2560	24.05	24.5	1.109	0.1	0.771	0.855
	LTE Band 7	20M	QPSK	50	0	Back	10	1	21100	2535	22.93	23.5	1.140	0.05	0.423	0.482
	LTE Band 7	20M	QPSK	100	0	Back	10	1	21100	2535	22.87	23.5	1.156	-0.02	0.423	0.489
	LTE Band 7	20M	QPSK	1	49	Left Side	10	1	21100	2535	24.23	24.5	1.064	-0.17	0.584	0.621
	LTE Band 7	20M	QPSK	50	0	Left Side	10	1	21100	2535	22.93	23.5	1.140	0.14	0.302	0.344
	LTE Band 7	20M	QPSK	1	49	Right Side	10	1	21100	2535	24.23	24.5	1.064	0.02	0.044	0.047
	LTE Band 7	20M	QPSK	50	0	Right Side	10	1	21100	2535	22.93	23.5	1.140	-0.05	0.022	0.025
	LTE Band 7	20M	QPSK	1	49	Bottom Side	10	1	21100	2535	24.23	24.5	1.064	-0.05	1.070	1.139
33	LTE Band 7	20M	QPSK	1	49	Bottom Side	10	1	20850	2510	23.68	24.5	1.208	-0.07	0.970	1.172
	LTE Band 7	20M	QPSK	1	49	Bottom Side	10	1	21350	2560	24.05	24.5	1.109	0.03	1.040	1.154
	LTE Band 7	20M	QPSK	50	0	Bottom Side	10	1	21100	2535	22.93	23.5	1.140	0.01	0.538	0.613
	LTE Band 7	20M	QPSK	100	0	Bottom Side	10	1	21100	2535	22.87	23.5	1.156	0.03	0.519	0.600



<TDD LTE SAR>

Plot No.	Band	BW (MHz)	Modulation	RB Size	RB Offset	Test Position	Gap (mm)	Power Level	Ch.	Freq. (MHz)	Average Power (dBm)	Tune-Up Limit (dBm)	Tune-up Scaling Factor	Duty Cycle %	Duty Cycle Scaling Factor	Power Drift (dB)	Measured 1g SAR (W/kg)	Reported 1g SAR (W/kg)
	LTE Band 41	20M	QPSK	1	49	Front	10	1	39750	2506	23.86	24.5	1.159	62.9	1.006	-0.02	0.389	0.453
	LTE Band 41	20M	QPSK	50	24	Front	10	1	39750	2506	22.75	23.5	1.189	62.9	1.006	0.07	0.207	0.247
	LTE Band 41	20M	QPSK	1	49	Back	10	1	39750	2506	23.86	24.5	1.159	62.9	1.006	-0.08	0.424	0.494
	LTE Band 41	20M	QPSK	50	24	Back	10	1	39750	2506	22.75	23.5	1.189	62.9	1.006	0.06	0.254	0.304
	LTE Band 41	20M	QPSK	1	49	Left Side	10	1	39750	2506	23.86	24.5	1.159	62.9	1.006	0.1	0.316	0.368
	LTE Band 41	20M	QPSK	50	24	Left Side	10	1	39750	2506	22.75	23.5	1.189	62.9	1.006	0.03	0.173	0.207
	LTE Band 41	20M	QPSK	1	49	Right Side	10	1	39750	2506	23.86	24.5	1.159	62.9	1.006	0.03	0.010	0.011
	LTE Band 41	20M	QPSK	50	24	Right Side	10	1	39750	2506	22.75	23.5	1.189	62.9	1.006	-0.07	0.013	0.016
34	LTE Band 41	20M	QPSK	1	49	Bottom Side	10	1	39750	2506	23.86	24.5	1.159	62.9	1.006	0.12	0.667	0.778
	LTE Band 41	20M	QPSK	1	49	Bottom Side	10	1	40185	2549.5	23.68	24.5	1.208	62.9	1.006	-0.17	0.631	0.767
	LTE Band 41	20M	QPSK	1	49	Bottom Side	10	1	40620	2593	23.7	24.5	1.202	62.9	1.006	0.03	0.633	0.766
	LTE Band 41	20M	QPSK	1	49	Bottom Side	10	1	41055	2636.5	23.42	24.5	1.282	62.9	1.006	0.08	0.570	0.735
	LTE Band 41	20M	QPSK	1	49	Bottom Side	10	1	41490	2680	23.55	24.5	1.245	62.9	1.006	0.06	0.616	0.771
	LTE Band 41	20M	QPSK	50	24	Bottom Side	10	1	39750	2506	22.75	23.5	1.189	62.9	1.006	0.1	0.352	0.421
	LTE Band 41	20M	QPSK	100	0	Bottom Side	10	1	39750	2506	22.82	23.5	1.169	62.9	1.006	0.02	0.336	0.395

<WLAN SAR>

Plot No.	Band	Mode	Test Position	Gap (mm)	Ch.	Freq. (MHz)	Average Power (dBm)	Tune-Up Limit (dBm)	Tune-up Scaling Factor	Duty Cycle %	Duty Cycle Scaling Factor	Power Drift (dB)	Max Area Scan SAR	Measured 1g SAR (W/kg)	Reported 1g SAR (W/kg)
	WLAN2.4GHz	802.11g 6Mbps	Front	10	11	2462	12.07	12.5	1.104	87.04	1.149		0.055		
35	WLAN2.4GHz	802.11g 6Mbps	Back	10	11	2462	12.07	12.5	1.104	87.04	1.149	0.02	0.095	0.074	0.094
	WLAN2.4GHz	802.11g 6Mbps	Right Side	10	11	2462	12.07	12.5	1.104	87.04	1.149		0.076		
	WLAN2.4GHz	802.11g 6Mbps	Top Side	10	11	2462	12.07	12.5	1.104	87.04	1.149		0.055		
36	WLAN 5.2GHz	802.11n-HT40 MCS0	Front	10	46	5230	14.12	14.5	1.091	85.9	1.164	0.01	0.177	0.069	0.088
	WLAN 5.2GHz	802.11n-HT40 MCS0	Back	10	46	5230	14.12	14.5	1.091	85.9	1.164		0.059		
	WLAN 5.2GHz	802.11n-HT40 MCS0	Right Side	10	46	5230	14.12	14.5	1.091	85.9	1.164		0.083		
	WLAN 5.2GHz	802.11n-HT40 MCS0	Top Side	10	46	5230	14.12	14.5	1.091	85.9	1.164		0.043		
37	WLAN 5.8GHz	802.11n-HT40 MCS0	Front	10	151	5755	13.99	14.5	1.125	85.9	1.164	0.05	0.25	0.076	0.099
	WLAN 5.8GHz	802.11n-HT40 MCS0	Back	10	151	5755	13.99	14.5	1.125	85.9	1.164		0.052		
	WLAN 5.8GHz	802.11n-HT40 MCS0	Right Side	10	151	5755	13.99	14.5	1.125	85.9	1.164		0.17		
	WLAN 5.8GHz	802.11n-HT40 MCS0	Top Side	10	151	5755	13.99	14.5	1.125	85.9	1.164		0.044		



**15.3 Body Worn Accessory SAR**

**<GSM SAR>**

Plot No.	Band	Mode	Test Position	Gap (mm)	Power Level	Ch.	Freq. (MHz)	Average Power (dBm)	Tune-Up Limit (dBm)	Tune-up Scaling Factor	Power Drift (dB)	Measured 1g SAR (W/kg)	Reported 1g SAR (W/kg)
	GSM850	GPRS 4 Tx slots	Front	10	1	189	836.4	29.94	30.5	1.138	-0.19	0.218	0.248
38	GSM850	GPRS 4 Tx slots	Back	10	1	189	836.4	29.94	30.5	1.138	0.01	0.261	<b>0.297</b>
	GSM1900	GPRS 4 Tx slots	Front	10	1	512	1850.2	24.12	24.5	1.091	0.04	0.631	0.689
39	GSM1900	GPRS 4 Tx slots	Back	10	1	512	1850.2	24.12	24.5	1.091	-0.06	0.900	<b>0.982</b>
	GSM1900	GPRS 4 Tx slots	Back	10	1	661	1880	24.09	24.5	1.099	0.02	0.883	0.970
	GSM1900	GPRS 4 Tx slots	Back	10	1	810	1909.8	24.09	24.5	1.099	0.04	0.887	0.975

**<WCDMA SAR>**

Plot No.	Band	Mode	Test Position	Gap (mm)	Power Level	Ch.	Freq. (MHz)	Average Power (dBm)	Tune-Up Limit (dBm)	Tune-up Scaling Factor	Power Drift (dB)	Measured 1g SAR (W/kg)	Reported 1g SAR (W/kg)
	WCDMA Band V	RMC 12.2Kbps	Front	10	1	4233	846.6	24.47	24.5	1.007	-0.06	0.278	0.280
40	WCDMA Band V	RMC 12.2Kbps	Back	10	1	4233	846.6	24.47	24.5	1.007	-0.16	0.324	<b>0.326</b>
	WCDMA Band IV	RMC 12.2Kbps	Front	10	2	1513	1752.6	17.11	17.5	1.094	0.05	0.597	0.653
41	WCDMA Band IV	RMC 12.2Kbps	Back	10	2	1513	1752.6	17.11	17.5	1.094	-0.04	0.727	<b>0.795</b>
	WCDMA Band II	RMC 12.2Kbps	Front	10	2	9538	1907.6	19.61	20	1.094	-0.04	0.548	0.599
42	WCDMA Band II	RMC 12.2Kbps	Back	10	2	9538	1907.6	19.61	20	1.094	-0.19	0.703	<b>0.769</b>

**<CDMA2000 SAR>**

Plot No.	Band	Mode	Test Position	Gap (mm)	Power Level	Ch.	Freq. (MHz)	Average Power (dBm)	Tune-Up Limit (dBm)	Tune-up Scaling Factor	Power Drift (dB)	Measured 1g SAR (W/kg)	Reported 1g SAR (W/kg)
	CDMA2000 BC10	RC3 SO32 (F+SCH)	Front	10	1	476	817.9	24.39	24.5	1.026	-0.14	0.311	0.319
43	CDMA2000 BC10	RC3 SO32 (F+SCH)	Back	10	1	476	817.9	24.39	24.5	1.026	-0.17	0.352	<b>0.361</b>
	CDMA2000 BC0	RC3 SO32 (F+SCH)	Front	10	1	777	848.31	24.39	24.5	1.026	-0.09	0.353	0.362
44	CDMA2000 BC0	RC3 SO32 (F+SCH)	Back	10	1	777	848.31	24.39	24.5	1.026	-0.16	0.363	<b>0.372</b>
	CDMA2000 BC1	RC3 SO32 (F+SCH)	Front	10	2	1175	1908.75	19.53	20	1.114	-0.11	0.489	0.545
45	CDMA2000 BC1	RC3 SO32 (F+SCH)	Back	10	2	1175	1908.75	19.53	20	1.114	0.04	0.716	<b>0.798</b>



<FDD LTE SAR>

Plot No.	Band	BW (MHz)	Modulation	RB Size	RB Offset	Test Position	Gap (mm)	Power Level	Ch.	Freq. (MHz)	Average Power (dBm)	Tune-Up Limit (dBm)	Tune-up Scaling Factor	Power Drift (dB)	Measured 1g SAR (W/kg)	Reported 1g SAR (W/kg)
	LTE Band 12	10M	QPSK	1	25	Front	10	1	23095	707.5	23.85	24.5	1.161	-0.13	0.194	0.225
	LTE Band 12	10M	QPSK	25	0	Front	10	1	23095	707.5	22.99	23.5	1.125	-0.18	0.129	0.145
46	LTE Band 12	10M	QPSK	1	25	Back	10	1	23095	707.5	23.85	24.5	1.161	0.06	0.246	<b>0.286</b>
	LTE Band 12	10M	QPSK	25	0	Back	10	1	23095	707.5	22.99	23.5	1.125	-0.17	0.183	0.206
	LTE Band 13	10M	QPSK	1	25	Front	10	1	23230	782	24.24	24.5	1.062	-0.05	0.281	0.298
	LTE Band 13	10M	QPSK	25	0	Front	10	1	23230	782	22.81	23.5	1.172	-0.17	0.229	0.268
47	LTE Band 13	10M	QPSK	1	25	Back	10	1	23230	782	24.24	24.5	1.062	-0.18	0.318	<b>0.338</b>
	LTE Band 13	10M	QPSK	25	0	Back	10	1	23230	782	22.81	23.5	1.172	-0.15	0.262	0.307
	LTE Band 26	15M	QPSK	1	37	Front	10	1	26865	831.5	23.85	24.5	1.161	-0.17	0.164	0.190
	LTE Band 26	15M	QPSK	36	0	Front	10	1	26865	831.5	22.85	23.5	1.161	0.01	0.128	0.149
48	LTE Band 26	15M	QPSK	1	37	Back	10	1	26865	831.5	23.85	24.5	1.161	0.07	0.268	<b>0.311</b>
	LTE Band 26	15M	QPSK	36	0	Back	10	1	26865	831.5	22.85	23.5	1.161	-0.1	0.192	0.223
	LTE Band 66	20M	QPSK	1	49	Front	10	2	132572	1770	16.31	16.5	1.045	0.01	0.469	0.490
	LTE Band 66	20M	QPSK	50	0	Front	10	2	132572	1770	16.1	16.5	1.096	-0.11	0.457	0.501
49	LTE Band 66	20M	QPSK	1	49	Back	10	2	132572	1770	16.31	16.5	1.045	0.04	0.616	<b>0.644</b>
	LTE Band 66	20M	QPSK	50	0	Back	10	2	132572	1770	16.1	16.5	1.096	-0.11	0.585	0.641
	LTE Band 25	20M	QPSK	1	49	Front	10	2	26140	1860	18.98	19.5	1.127	0.03	0.489	0.551
	LTE Band 25	20M	QPSK	50	0	Front	10	2	26140	1860	18.75	19.5	1.189	0.13	0.465	0.553
50	LTE Band 25	20M	QPSK	1	49	Back	10	2	26140	1860	18.98	19.5	1.127	0.09	0.686	<b>0.773</b>
	LTE Band 25	20M	QPSK	50	0	Back	10	2	26140	1860	18.75	19.5	1.189	-0.07	0.564	0.670
	LTE Band 7	20M	QPSK	1	49	Front	10	1	21100	2535	24.23	24.5	1.064	0.08	0.659	0.701
	LTE Band 7	20M	QPSK	50	0	Front	10	1	21100	2535	22.93	23.5	1.140	0.11	0.320	0.365
	LTE Band 7	20M	QPSK	1	49	Back	10	1	21100	2535	24.23	24.5	1.064	0.03	0.851	0.906
51	LTE Band 7	20M	QPSK	1	49	Back	10	1	20850	2510	23.68	24.5	1.208	-0.02	0.823	<b>0.994</b>
	LTE Band 7	20M	QPSK	1	49	Back	10	1	21350	2560	24.05	24.5	1.109	0.1	0.771	0.855
	LTE Band 7	20M	QPSK	50	0	Back	10	1	21100	2535	22.93	23.5	1.140	0.05	0.423	0.482
	LTE Band 7	20M	QPSK	100	0	Back	10	1	21100	2535	22.87	23.5	1.156	-0.02	0.423	0.489



<TDD LTE SAR>

Plot No.	Band	BW (MHz)	Modulation	RB Size	RB Offset	Test Position	Gap (mm)	Power Level	Ch.	Freq. (MHz)	Average Power (dBm)	Tune-Up Limit (dBm)	Tune-up Scaling Factor	Duty Cycle %	Duty Cycle Scaling Factor	Power Drift (dB)	Measured 1g SAR (W/kg)	Reported 1g SAR (W/kg)
	LTE Band 41	20M	QPSK	1	49	Front	10	1	39750	2506	23.86	24.5	1.159	62.9	1.006	-0.02	0.389	0.453
	LTE Band 41	20M	QPSK	50	24	Front	10	1	39750	2506	22.75	23.5	1.189	62.9	1.006	0.07	0.207	0.247
52	LTE Band 41	20M	QPSK	1	49	Back	10	1	39750	2506	23.86	24.5	1.159	62.9	1.006	-0.08	0.424	0.494
	LTE Band 41	20M	QPSK	50	24	Back	10	1	39750	2506	22.75	23.5	1.189	62.9	1.006	0.06	0.254	0.304

<WLAN SAR>

Plot No.	Band	Mode	Test Position	Gap (mm)	Ch.	Freq. (MHz)	Average Power (dBm)	Tune-Up Limit (dBm)	Tune-up Scaling Factor	Duty Cycle %	Duty Cycle Scaling Factor	Power Drift (dB)	Max Area Scan SAR	Measured 1g SAR (W/kg)	Reported 1g SAR (W/kg)
	WLAN2.4GHz	802.11g 6Mbps	Front	10	11	2462	12.07	12.5	1.104	87.04	1.149		0.055		
53	WLAN2.4GHz	802.11g 6Mbps	Back	10	11	2462	12.07	12.5	1.104	87.04	1.149	0.02	0.095	0.074	0.094
54	WLAN 5.3GHz	802.11n-HT40 MCS0	Front	10	54	5270	14.13	14.5	1.089	85.9	1.164	0.01	0.178	0.073	0.093
	WLAN 5.3GHz	802.11n-HT40 MCS0	Back	10	54	5270	14.13	14.5	1.089	85.9	1.164		0.143		
55	WLAN 5.5GHz	802.11n-HT40 MCS0	Front	10	110	5550	13.89	14.5	1.151	85.9	1.164	0.01	0.287	0.098	0.131
	WLAN 5.5GHz	802.11n-HT40 MCS0	Back	10	110	5550	13.89	14.5	1.151	85.9	1.164		0.119		
56	WLAN 5.8GHz	802.11n-HT40 MCS0	Front	10	151	5755	13.99	14.5	1.125	85.9	1.164	0.05	0.25	0.076	0.099
	WLAN 5.8GHz	802.11n-HT40 MCS0	Back	10	151	5755	13.99	14.5	1.125	85.9	1.164		0.052		



**15.4 Product specific 10g SAR**

**<WCDMA SAR>**

Plot No.	Band	Mode	Test Position	Gap (mm)	Power Level	Ch.	Freq. (MHz)	Average Power (dBm)	Tune-Up Limit (dBm)	Tune-up Scaling Factor	Power Drift (dB)	Measured 10g SAR (W/kg)	Reported 10g SAR (W/kg)
	WCDMA Band IV	RMC 12.2Kbps	Front	0	2	1513	1752.6	17.11	17.5	1.094	-0.04	1.790	1.958
	WCDMA Band IV	RMC 12.2Kbps	Back	0	2	1513	1752.6	17.11	17.5	1.094	-0.04	2.640	2.888
	WCDMA Band IV	RMC 12.2Kbps	Back	0	2	1312	1712.4	16.17	17.5	1.358	-0.06	2.140	2.907
	WCDMA Band IV	RMC 12.2Kbps	Back	0	2	1413	1732.6	16.87	17.5	1.156	-0.08	2.490	2.879
57	WCDMA Band IV	RMC 12.2Kbps	Bottom Side	0	3	1513	1752.6	23.76	24	1.057	-0.06	2.810	<b>2.970</b>
	WCDMA Band IV	RMC 12.2Kbps	Bottom Side	0	3	1312	1712.4	23.25	24	1.189	-0.08	2.080	2.472
	WCDMA Band IV	RMC 12.2Kbps	Bottom Side	0	3	1413	1732.6	23.51	24	1.119	-0.06	2.650	2.967
	WCDMA Band II	RMC 12.2Kbps	Front	0	2	9538	1907.6	19.61	20	1.094	-0.02	1.000	1.094
	WCDMA Band II	RMC 12.2Kbps	Back	0	2	9538	1907.6	19.61	20	1.094	0.02	1.650	1.805
58	WCDMA Band II	RMC 12.2Kbps	Bottom Side	0	3	9400	1880	21.25	23	1.496	-0.08	2.280	<b>3.411</b>
	WCDMA Band II	RMC 12.2Kbps	Bottom Side	0	3	9262	1907.6	21.81	23	1.315	-0.07	2.120	2.788
	WCDMA Band II	RMC 12.2Kbps	Bottom Side	0	3	9538	1880	22.28	23	1.180	0.1	2.130	2.514

**<CDMA2000 SAR>**

Plot No.	Band	Mode	Test Position	Gap (mm)	Power Level	Ch.	Freq. (MHz)	Average Power (dBm)	Tune-Up Limit (dBm)	Tune-up Scaling Factor	Power Drift (dB)	Measured 10g SAR (W/kg)	Reported 10g SAR (W/kg)
	CDMA2000 BC1	RTAP 153.6Kbps	Front	0	2	1175	1908.75	19.67	20	1.079	0.01	1.070	1.154
	CDMA2000 BC1	RTAP 153.6Kbps	Back	0	2	1175	1908.75	19.67	20	1.079	0.01	1.430	1.543
59	CDMA2000 BC1	RTAP 153.6Kbps	Bottom Side	0	1	25	1851.25	23.67	24.5	1.211	0.03	2.640	<b>3.196</b>
	CDMA2000 BC1	RTAP 153.6Kbps	Bottom Side	0	1	600	1880	23.49	24.5	1.262	0.01	2.240	2.826
	CDMA2000 BC1	RTAP 153.6Kbps	Bottom Side	0	1	1175	1908.75	23.65	24.5	1.216	0.06	2.170	2.639



<FDD LTE SAR>

Plot No.	Band	BW (MHz)	Modulation	RB Size	RB Offset	Test Position	Gap (mm)	Power Level	Ch.	Freq. (MHz)	Average Power (dBm)	Tune-Up Limit (dBm)	Tune-up Scaling Factor	Power Drift (dB)	Measured 10g SAR (W/kg)	Reported 10g SAR (W/kg)
	LTE Band 66	20M	QPSK	1	49	Front	0	2	132572	1770	16.31	16.5	1.045	0.07	1.330	1.389
	LTE Band 66	20M	QPSK	50	0	Front	0	2	132572	1770	16.1	16.5	1.096	-0.1	1.360	1.491
	LTE Band 66	20M	QPSK	1	49	Back	0	2	132572	1770	16.31	16.5	1.045	-0.03	1.840	1.922
	LTE Band 66	20M	QPSK	50	0	Back	0	2	132572	1770	16.1	16.5	1.096	-0.03	1.810	1.985
	LTE Band 66	20M	QPSK	1	49	Bottom Side	0	3	132322	1745	22.47	23.5	1.268	0.1	2.430	3.080
	LTE Band 66	20M	QPSK	1	49	Bottom Side	0	3	132072	1720	22.28	23.5	1.324	0.01	2.200	2.914
60	LTE Band 66	20M	QPSK	1	49	Bottom Side	0	3	132572	1770	22.27	23.5	1.327	-0.11	2.490	3.305
	LTE Band 66	20M	QPSK	50	0	Bottom Side	0	3	132322	1745	22.08	22.5	1.102	0.03	1.500	1.652
	LTE Band 66	20M	QPSK	100	0	Bottom Side	0	3	132322	1745	21.85	22.5	1.161	0.03	1.480	1.719
	LTE Band 25	20M	QPSK	1	49	Front	0	2	26140	1860	18.98	19.5	1.127	0.04	0.994	1.120
	LTE Band 25	20M	QPSK	50	0	Front	0	2	26140	1860	18.75	19.5	1.189	-0.05	0.969	1.152
	LTE Band 25	20M	QPSK	1	49	Back	0	2	26140	1860	18.98	19.5	1.127	-0.08	1.350	1.522
	LTE Band 25	20M	QPSK	50	0	Back	0	2	26140	1860	18.75	19.5	1.189	-0.18	1.300	1.545
	LTE Band 25	20M	QPSK	1	49	Bottom Side	0	1	26140	1860	24.15	24.5	1.084	-0.07	2.150	2.330
	LTE Band 25	20M	QPSK	1	49	Bottom Side	0	1	26590	1905	23.63	24.5	1.222	-0.03	2.620	3.201
61	LTE Band 25	20M	QPSK	1	49	Bottom Side	0	1	26340	1880	23.94	24.5	1.138	-0.08	2.870	3.265
	LTE Band25	20M	QPSK	50	0	Bottom Side	0	1	26140	1860	22.87	23.5	1.156	-0.08	1.510	1.746
	LTE Band25	20M	QPSK	50	0	Bottom Side	0	1	26340	1880	22.72	23.5	1.197	-0.11	1.500	1.795
	LTE Band25	20M	QPSK	50	0	Bottom Side	0	1	26590	1905	22.64	23.5	1.219	-0.07	1.320	1.609
	LTE Band25	20M	QPSK	100	0	Bottom Side	0	1	26140	1860	22.78	23.5	1.180	-0.07	1.530	1.806

<WLAN SAR>

Plot No.	Band	Mode	Test Position	Gap (mm)	Ch.	Freq. (MHz)	Average Power (dBm)	Tune-Up Limit (dBm)	Tune-up Scaling Factor	Duty Cycle %	Duty Cycle Scaling Factor	Power Drift (dB)	Max Area Scan SAR	Measured 10g SAR (W/kg)	Reported 10g SAR (W/kg)
62	WLAN 5.3GHz	802.11n-HT40 MCS0	Front	0	54	5270	14.13	14.5	1.089	85.9	1.164	-0.01	5.396	0.683	0.866
	WLAN 5.3GHz	802.11n-HT40 MCS0	Back	0	54	5270	14.13	14.5	1.089	85.9	1.164		0.54		
	WLAN 5.3GHz	802.11n-HT40 MCS0	Right Side	0	54	5270	14.13	14.5	1.089	85.9	1.164		1.306		
	WLAN 5.3GHz	802.11n-HT40 MCS0	Top Side	0	54	5270	14.13	14.5	1.089	85.9	1.164		0.296		
63	WLAN 5.5GHz	802.11n-HT40 MCS0	Front	0	110	5550	13.89	14.5	1.151	85.9	1.164	-0.02	6.139	0.828	1.109
	WLAN 5.5GHz	802.11n-HT40 MCS0	Back	0	110	5550	13.89	14.5	1.151	85.9	1.164		0.769		
	WLAN 5.5GHz	802.11n-HT40 MCS0	Right Side	0	110	5550	13.89	14.5	1.151	85.9	1.164	0.01	2.262	0.228	0.305
	WLAN 5.5GHz	802.11n-HT40 MCS0	Top Side	0	110	5550	13.89	14.5	1.151	85.9	1.164		0.456		



**15.5 Repeated SAR Measurement**

**<1g SAR>**

No.	Band	Mode	BW (MHz)	Modulation	RB Size	RB Offset	Test Position	Gap (mm)	Power Level	Ch.	Freq. (MHz)	Average Power (dBm)	Tune-Up Limit (dBm)	Tune-up Scaling Factor	Duty Cycle %	Duty Cycle Scaling Factor	Power Drift (dB)	Measured 1g SAR (W/kg)	Ratio	Reported 1g SAR (W/kg)
1st	GSM1900	GPRS 4 Tx slots	-	-	-	-	Bottom Side	10	1	661	1880	24.09	24.5	1.099	-	-	-0.01	1.050	1	1.154
2nd	GSM1900	GPRS 4 Tx slots	-	-	-	-	Bottom Side	10	1	661	1880	24.09	24.5	1.099	-	-	-0.01	1.030	1.019	1.132
1st	WCDMA Band IV	RMC 12.2Kbps	-	-	-	-	Bottom Side	10	2	1513	1752.6	17.11	17.5	1.094	-	-	-0.03	0.894	1	0.978
2nd	WCDMA Band IV	RMC 12.2Kbps	-	-	-	-	Bottom Side	10	2	1513	1752.6	17.11	17.5	1.094	-	-	-0.01	0.893	1.001	0.977
1st	LTE Band 7	-	20M	QPSK	1	49	Bottom Side	10	1	21100	2535	24.23	24.5	1.064	-	-	-0.05	1.070	1	1.139
2nd	LTE Band 7	-	20M	QPSK	1	49	Bottom Side	10	1	21100	2535	24.23	24.5	1.064	-	-	-0.01	1.020	1.049	1.085
1st	WLAN 5.5GHz	802.11n-HT40 MCS0	-	-	-	-	Left Cheek	-	-	110	5550	13.89	14.5	1.151	85.9	1.164	-0.04	0.807	1	1.081
2nd	WLAN 5.5GHz	802.11n-HT40 MCS0	-	-	-	-	Left Cheek	-	-	110	5550	13.89	14.5	1.151	85.9	1.164	-0.03	0.803	1.005	1.076

**<10g SAR>**

No.	Band	Mode	BW (MHz)	Modulation	RB Size	RB Offset	Test Position	Gap (mm)	Power Level	Ch.	Freq. (MHz)	Average Power (dBm)	Tune-Up Limit (dBm)	Tune-up Scaling Factor	Power Drift (dB)	Measured 10g SAR (W/kg)	Ratio	Reported 10g SAR (W/kg)
1st	WCDMA Band IV	Bottom Side	-	-	-	-	Bottom Side	0	3	1513	1752.6	23.76	24	1.057	-0.06	2.810	1	2.970
2nd	WCDMA Band IV	Bottom Side	-	-	-	-	Bottom Side	0	3	1513	1752.6	23.76	24	1.057	-0.06	2.790	1.007	2.949
1st	LTE Band 25		20M	QPSK	1	49	Bottom Side	0	1	26340	1880	23.94	24.5	1.138	-0.08	2.870	1	3.265
2nd	LTE Band 25		20M	QPSK	1	49	Bottom Side	0	1	26340	1880	23.94	24.5	1.138	-0.18	2.810	1.021	3.197

**General Note:**

1. Per KDB 865664 D01v01r04, for each frequency band, repeated SAR measurement is required only when the measured SAR is  $\geq 0.8W/kg$ .
2. Per KDB 865664 D01v01r04, if the ratio among the repeated measurement is  $\leq 1.2$  and the measured SAR  $< 1.45W/kg$ , only one repeated measurement is required.
3. Per KDB 865664 D01v01r04, if the extremity repeated SAR is necessary, the same procedures should be adapted for measurements according to extremity and occupational exposure limits by applying a factor of 2.5 for extremity exposure and a factor of 5 for occupational exposure to the corresponding SAR thresholds.
4. The ratio is the difference in percentage between original and repeated *measured SAR*.
5. All measurement SAR result is scaled-up to account for tune-up tolerance and is compliant.

### 16. Simultaneous Transmission Analysis

No.	Simultaneous Transmission Configurations	Portable Handset			Note
		Head	Body-worn	Hotspot	
1.	GSM Voice + WLAN2.4GHz	Yes	Yes		
2.	GPRS/EDGE + WLAN2.4GHz	Yes	Yes	Yes	WWAN VoIP
3.	WCDMA + WLAN2.4GHz	Yes	Yes	Yes	WWAN VoIP
4.	CDMA + WLAN2.4GHz	Yes	Yes	Yes	WWAN VoIP
5.	LTE + WLAN2.4GHz	Yes	Yes	Yes	WWAN VoIP
6.	GSM Voice + WLAN5.3/5.5GHz	Yes	Yes		
7.	GPRS/EDGE + WLAN5.3/5.5GHz	Yes	Yes		WWAN VoIP
8.	WCDMA + WLAN5.3/5.5GHz	Yes	Yes		WWAN VoIP
9.	CDMA + WLAN5.3/5.5GHz	Yes	Yes		WWAN VoIP
10.	LTE + WLAN5.3/5.5GHz	Yes	Yes		WWAN VoIP
11.	GSM Voice + WLAN5.2/5.8GHz	Yes	Yes		
12.	GPRS/EDGE + WLAN5.2/5.8GHz	Yes	Yes	Yes	WWAN VoIP
13.	WCDMA + WLAN5.2/5.8GHz	Yes	Yes	Yes	WWAN VoIP
14.	CDMA + WLAN5.2/5.8GHz	Yes	Yes	Yes	WWAN VoIP
15.	LTE + WLAN5.2/5.8GHz	Yes	Yes	Yes	WWAN VoIP
16.	GSM Voice + Bluetooth		Yes		
17.	GPRS/EDGE + Bluetooth		Yes		WWAN VoIP
18.	WCDMA + Bluetooth		Yes		WWAN VoIP
19.	CDMA + Bluetooth		Yes		WWAN VoIP
20.	LTE + Bluetooth		Yes		WWAN VoIP

**General Note:**

- This device supports VoIP in GPRS, EGPRS, CDMA, WCDMA and LTE (e.g. for 3rd-party VoIP), LTE supports VoLTE operation.
- EUT will choose each GSM, WCDMA, CDMA and LTE according to the network signal condition; therefore, they will not operate simultaneously at any moment.
- This device 2.4GHz WLAN/ 5.2GHz WLAN/5.8GHz WLAN support hotspot operation, and 5.2GHz WLAN/5.8GHz WLAN supports WiFi Direct (GC/GO), and 5.3GHz / 5.5GHz supports WiFi Direct (GC only).
- EUT will choose either WLAN 2.4GHz or WLAN 5GHz according to the network signal condition; therefore, 2.4GHz WLAN and 5GHz WLAN will not operate simultaneously at any moment though they have independent antenna.
- WLAN 2.4GHz and Bluetooth share the same antenna so can't transmit simultaneously.
- According to the EUT character, WLAN 5GHz and Bluetooth can't transmit simultaneously.
- Chose the worst zoom scan SAR of WLAN correspondingly for co-located with WWAN analysis.
- The reported SAR summation is calculated based on the same configuration and test position.
- Per KDB 447498 D01v06, simultaneous transmission SAR is compliant if,
  - Scalar SAR summation < 1.6W/kg.
  - $SPLSR = (SAR1 + SAR2)^{1.5} / (\text{min. separation distance, mm})$ , and the peak separation distance is determined from the square root of  $[(x1-x2)^2 + (y1-y2)^2 + (z1-z2)^2]$ , where (x1, y1, z1) and (x2, y2, z2) are the coordinates of the extrapolated peak SAR locations in the zoom scan.
  - If  $SPLSR \leq 0.04$ , simultaneously transmission SAR measurement is not necessary.
  - Simultaneously transmission SAR measurement, and the reported multi-band SAR < 1.6W/kg.
- For simultaneous transmission analysis, Bluetooth SAR is estimated per KDB 447498 D01v06 based on the formula below.
  - $(\text{max. power of channel, including tune-up tolerance, mW}) / (\text{min. test separation distance, mm}) \cdot [\sqrt{f(\text{GHz})} / x] \text{ W/kg}$  for test separation distances  $\leq 50 \text{ mm}$ ; where  $x = 7.5$  for 1-g SAR, and  $x = 18.75$  for 10-g SAR.
  - When the minimum separation distance is < 5mm, the distance is used 5mm to determine SAR test exclusion.
  - 0.4 W/kg for 1-g SAR and 1.0 W/kg for 10-g SAR, when the test separation distances is > 50 mm.

**<1g SAR>**

Bluetooth Max Power (dBm)	Exposure Position	Body worn
	Test separation	10 mm
11	Estimated SAR (W/kg)	0.273

**<10g SAR>**

Bluetooth Max Power (dBm)	Exposure Position	Product specific 10g SAR
	Test separation	0 mm
11	Estimated SAR (W/kg)	0.218



**16.1 Head Exposure Conditions**

WWAN Band		Exposure Position	1	2	3	1+2 Summed 1g SAR (W/kg)	1+3 Summed 1g SAR (W/kg)
			WWAN 1g SAR (W/kg)	2.4GHz WLAN 1g SAR (W/kg)	5GHz WLAN 1g SAR (W/kg)		
GSM	GSM850	Right Cheek	0.126	0.358	1.081	0.48	1.21
		Right Tilted	0.061	0.358	1.081	0.42	1.14
		Left Cheek	0.117	0.358	1.081	0.48	1.20
		Left Tilted	0.061	0.358	1.081	0.42	1.14
	GSM1900	Right Cheek	0.024	0.358	1.081	0.38	1.11
		Right Tilted	0.022	0.358	1.081	0.38	1.10
		Left Cheek	0.056	0.358	1.081	0.41	1.14
		Left Tilted	0.020	0.358	1.081	0.38	1.10
WCDMA	Band V	Right Cheek	0.159	0.358	1.081	0.52	1.24
		Right Tilted	0.091	0.358	1.081	0.45	1.17
		Left Cheek	0.144	0.358	1.081	0.50	1.23
		Left Tilted	0.096	0.358	1.081	0.45	1.18
	Band IV	Right Cheek	0.238	0.358	1.081	0.60	1.32
		Right Tilted	0.201	0.358	1.081	0.56	1.28
		Left Cheek	0.356	0.358	1.081	0.71	1.44
		Left Tilted	0.186	0.358	1.081	0.54	1.27
	Band II	Right Cheek	0.172	0.358	1.081	0.53	1.25
		Right Tilted	0.150	0.358	1.081	0.51	1.23
		Left Cheek	0.245	0.358	1.081	0.60	1.33
		Left Tilted	0.074	0.358	1.081	0.43	1.16
CDMA2000	BC10	Right Cheek	0.224	0.358	1.081	0.58	1.31
		Right Tilted	0.112	0.358	1.081	0.47	1.19
		Left Cheek	0.191	0.358	1.081	0.55	1.27
		Left Tilted	0.107	0.358	1.081	0.47	1.19
	BC0	Right Cheek	0.309	0.358	1.081	0.67	1.39
		Right Tilted	0.165	0.358	1.081	0.52	1.25
		Left Cheek	0.255	0.358	1.081	0.61	1.34
		Left Tilted	0.142	0.358	1.081	0.50	1.22
	BC1	Right Cheek	0.141	0.358	1.081	0.50	1.22
		Right Tilted	0.117	0.358	1.081	0.48	1.20
		Left Cheek	0.321	0.358	1.081	0.68	1.40
		Left Tilted	0.112	0.358	1.081	0.47	1.19



WWAN Band		Exposure Position	1	2	3	1+2 Summed 1g SAR (W/kg)	1+3 Summed 1g SAR (W/kg)
			WWAN	2.4GHz WLAN	5GHz WLAN		
			1g SAR (W/kg)	1g SAR (W/kg)	1g SAR (W/kg)		
LTE	Band 12	Right Cheek	0.143	0.358	1.081	0.50	1.22
		Right Tilted	0.075	0.358	1.081	0.43	1.16
		Left Cheek	0.127	0.358	1.081	0.49	1.21
		Left Tilted	0.069	0.358	1.081	0.43	1.15
	Band 13	Right Cheek	0.201	0.358	1.081	0.56	1.28
		Right Tilted	0.113	0.358	1.081	0.47	1.19
		Left Cheek	0.225	0.358	1.081	0.58	1.31
		Left Tilted	0.150	0.358	1.081	0.51	1.23
	Band 26	Right Cheek	0.214	0.358	1.081	0.57	1.30
		Right Tilted	0.124	0.358	1.081	0.48	1.21
		Left Cheek	0.202	0.358	1.081	0.56	1.28
		Left Tilted	0.131	0.358	1.081	0.49	1.21
	Band 66	Right Cheek	0.132	0.358	1.081	0.49	1.21
		Right Tilted	0.079	0.358	1.081	0.44	1.16
		Left Cheek	0.339	0.358	1.081	0.70	1.42
		Left Tilted	0.172	0.358	1.081	0.53	1.25
	Band 25	Right Cheek	0.090	0.358	1.081	0.45	1.17
		Right Tilted	0.067	0.358	1.081	0.43	1.15
		Left Cheek	0.194	0.358	1.081	0.55	1.28
		Left Tilted	0.079	0.358	1.081	0.44	1.16
	Band 7	Right Cheek	0.182	0.358	1.081	0.54	1.26
		Right Tilted	0.178	0.358	1.081	0.54	1.26
		Left Cheek	0.417	0.358	1.081	0.78	1.50
		Left Tilted	0.126	0.358	1.081	0.48	1.21
	Band 41	Right Cheek	0.152	0.358	1.081	0.51	1.23
		Right Tilted	0.125	0.358	1.081	0.48	1.21
		Left Cheek	0.363	0.358	1.081	0.72	1.44
		Left Tilted	0.091	0.358	1.081	0.45	1.17



**16.2 Hotspot Exposure Conditions**

WWAN Band		Exposure Position	1	2	3	1+2 Summed 1g SAR (W/kg)	1+3 Summed 1g SAR (W/kg)
			WWAN 1g SAR (W/kg)	2.4GHz WLAN 1g SAR (W/kg)	5GHz WLAN 1g SAR (W/kg)		
GSM	GSM850	Front	0.248	0.094	0.099	0.34	0.35
		Back	0.297	0.094	0.099	0.39	0.40
		Left Side	0.255			0.26	0.26
		Right Side	0.324	0.094	0.099	0.42	0.42
		Top Side		0.094	0.099	0.09	0.10
		Bottom Side	0.068			0.07	0.07
	GSM1900	Front	0.689	0.094	0.099	0.78	0.79
		Back	0.982	0.094	0.099	1.08	1.08
		Left Side	0.110			0.11	0.11
		Right Side	0.027	0.094	0.099	0.12	0.13
		Top Side		0.094	0.099	0.09	0.10
		Bottom Side	1.154			1.15	1.15
WCDMA	Band V	Front	0.280	0.094	0.099	0.37	0.38
		Back	0.326	0.094	0.099	0.42	0.43
		Left Side	0.259			0.26	0.26
		Right Side	0.613	0.094	0.099	0.71	0.71
		Top Side		0.094	0.099	0.09	0.10
		Bottom Side	0.099			0.10	0.10
	Band IV	Front	0.653	0.094	0.099	0.75	0.75
		Back	0.795	0.094	0.099	0.89	0.89
		Left Side	0.131			0.13	0.13
		Right Side	0.058	0.094	0.099	0.15	0.16
		Top Side		0.094	0.099	0.09	0.10
		Bottom Side	0.978			0.98	0.98
	Band II	Front	0.599	0.094	0.099	0.69	0.70
		Back	0.769	0.094	0.099	0.86	0.87
		Left Side	0.095			0.10	0.10
		Right Side	0.040	0.094	0.099	0.13	0.14
		Top Side		0.094	0.099	0.09	0.10
		Bottom Side	0.998			1.00	1.00
CDMA2000	BC10	Front	0.307	0.094	0.099	0.40	0.41
		Back	0.363	0.094	0.099	0.46	0.46
		Left Side	0.257			0.26	0.26
		Right Side	0.447	0.094	0.099	0.54	0.55
		Top Side		0.094	0.099	0.09	0.10
		Bottom Side	0.086			0.09	0.09
	BC0	Front	0.383	0.094	0.099	0.48	0.48
		Back	0.441	0.094	0.099	0.54	0.54
		Left Side	0.343			0.34	0.34
		Right Side	0.569	0.094	0.099	0.66	0.67
		Top Side		0.094	0.099	0.09	0.10
		Bottom Side	0.138			0.14	0.14
	BC1	Front	0.564	0.094	0.099	0.66	0.66
		Back	0.756	0.094	0.099	0.85	0.86
		Left Side	0.098			0.10	0.10
		Right Side	0.033	0.094	0.099	0.13	0.13
		Top Side		0.094	0.099	0.09	0.10
		Bottom Side	0.982			0.98	0.98



WWAN Band		Exposure Position	1	2	3	1+2 Summed 1g SAR (W/kg)	1+3 Summed 1g SAR (W/kg)
			WWAN 1g SAR (W/kg)	2.4GHz WLAN 1g SAR (W/kg)	5GHz WLAN 1g SAR (W/kg)		
LTE	Band 12	Front	0.225	0.094	0.099	0.32	0.32
		Back	0.286	0.094	0.099	0.38	0.39
		Left Side	0.135			0.14	0.14
		Right Side	0.196	0.094	0.099	0.29	0.30
		Top Side		0.094	0.099	0.09	0.10
		Bottom Side	0.058			0.06	0.06
	Band 13	Front	0.298	0.094	0.099	0.39	0.40
		Back	0.338	0.094	0.099	0.43	0.44
		Left Side	0.329			0.33	0.33
		Right Side	0.391	0.094	0.099	0.49	0.49
		Top Side		0.094	0.099	0.09	0.10
		Bottom Side	0.106			0.11	0.11
	Band 26	Front	0.190	0.094	0.099	0.28	0.29
		Back	0.311	0.094	0.099	0.41	0.41
		Left Side	0.311			0.31	0.31
		Right Side	0.424	0.094	0.099	0.52	0.52
		Top Side		0.094	0.099	0.09	0.10
		Bottom Side	0.089			0.09	0.09
	Band 66	Front	0.501	0.094	0.099	0.60	0.60
		Back	0.644	0.094	0.099	0.74	0.74
		Left Side	0.101			0.10	0.10
		Right Side	0.037	0.094	0.099	0.13	0.14
		Top Side		0.094	0.099	0.09	0.10
		Bottom Side	0.626			0.63	0.63
	Band 25	Front	0.553	0.094	0.099	0.65	0.65
		Back	0.773	0.094	0.099	0.87	0.87
		Left Side	0.083			0.08	0.08
		Right Side	0.030	0.094	0.099	0.12	0.13
		Top Side		0.094	0.099	0.09	0.10
		Bottom Side	0.896			0.90	0.90
Band 7	Front	0.701	0.094	0.099	0.80	0.80	
	Back	0.994	0.094	0.099	1.09	1.09	
	Left Side	0.621			0.62	0.62	
	Right Side	0.047	0.094	0.099	0.14	0.15	
	Top Side		0.094	0.099	0.09	0.10	
	Bottom Side	1.172			1.17	1.17	
Band 41	Front	0.453	0.094	0.099	0.55	0.55	
	Back	0.494	0.094	0.099	0.59	0.59	
	Left Side	0.368			0.37	0.37	
	Right Side	0.016	0.094	0.099	0.11	0.12	
	Top Side		0.094	0.099	0.09	0.10	
	Bottom Side	0.778			0.78	0.78	



**16.3 Body-Worn Accessory Exposure Conditions**

WWAN Band		Exposure Position	1	2	3	4	1+2 Summed 1g SAR (W/kg)	1+3 Summed 1g SAR (W/kg)	1+4 Summed 1g SAR (W/kg)
			WWAN	2.4GHz WLAN	5GHz WLAN	Bluetooth			
			1g SAR (W/kg)	1g SAR (W/kg)	1g SAR (W/kg)	Estimated 1g SAR (W/kg)			
GSM	GSM850	Front	0.248	0.094	0.131	0.273	0.34	0.38	0.52
		Back	0.297	0.094	0.131	0.273	0.39	0.43	0.57
	GSM1900	Front	0.689	0.094	0.131	0.273	0.78	0.82	0.96
		Back	0.982	0.094	0.131	0.273	1.08	1.11	1.26
WCDMA	Band V	Front	0.280	0.094	0.131	0.273	0.37	0.41	0.55
		Back	0.326	0.094	0.131	0.273	0.42	0.46	0.60
	Band IV	Front	0.653	0.094	0.131	0.273	0.75	0.78	0.93
		Back	0.795	0.094	0.131	0.273	0.89	0.93	1.07
	Band II	Front	0.599	0.094	0.131	0.273	0.69	0.73	0.87
		Back	0.769	0.094	0.131	0.273	0.86	0.90	1.04
CDMA2000	BC10	Front	0.319	0.094	0.131	0.273	0.41	0.45	0.59
		Back	0.361	0.094	0.131	0.273	0.46	0.49	0.63
	BC0	Front	0.362	0.094	0.131	0.273	0.46	0.49	0.64
		Back	0.372	0.094	0.131	0.273	0.47	0.50	0.65
	BC1	Front	0.545	0.094	0.131	0.273	0.64	0.68	0.82
		Back	0.798	0.094	0.131	0.273	0.89	0.93	1.07
LTE	Band 12	Front	0.225	0.094	0.131	0.273	0.32	0.36	0.50
		Back	0.286	0.094	0.131	0.273	0.38	0.42	0.56
	Band 13	Front	0.298	0.094	0.131	0.273	0.39	0.43	0.57
		Back	0.338	0.094	0.131	0.273	0.43	0.47	0.61
	Band 26	Front	0.190	0.094	0.131	0.273	0.28	0.32	0.46
		Back	0.311	0.094	0.131	0.273	0.41	0.44	0.58
	Band 66	Front	0.501	0.094	0.131	0.273	0.60	0.63	0.77
		Back	0.644	0.094	0.131	0.273	0.74	0.78	0.92
	Band 25	Front	0.553	0.094	0.131	0.273	0.65	0.68	0.83
		Back	0.773	0.094	0.131	0.273	0.87	0.90	1.05
	Band 7	Front	0.701	0.094	0.131	0.273	0.80	0.83	0.97
		Back	0.994	0.094	0.131	0.273	1.09	1.13	1.27
	Band 41	Front	0.453	0.094	0.131	0.273	0.55	0.58	0.73
		Back	0.494	0.094	0.131	0.273	0.59	0.63	0.77

**16.4 Product Specific 10g SAR Exposure Conditions**

WWAN Band		Exposure Position	1	2	3	1+2 Summed 10g SAR (W/kg)	1+3 Summed 10g SAR (W/kg)
			WWAN	5GHz WLAN	Bluetooth		
			10g SAR (W/kg)	10g SAR (W/kg)	Estimated 10g SAR (W/kg)		
WCDMA	Band IV	Front	1.958	1.109	0.218	3.07	2.18
		Back	2.888	1.109	0.218	3.90	3.11
		Bottom Side	2.970			2.97	2.97
	Band II	Front	1.094	1.109	0.218	2.20	1.31
		Back	1.805	1.109	0.218	2.91	2.02
		Bottom Side	3.411			3.41	3.41
CDMA2000	BC1	Front	1.154	1.109	0.218	2.26	1.37
		Back	1.543	1.109	0.218	2.65	1.76
		Bottom Side	3.196			3.20	3.20
LTE	Band 66	Front	1.491	1.109	0.218	2.60	1.71
		Back	1.985	1.109	0.218	3.09	2.20
		Bottom Side	3.305			3.31	3.31
	Band 25	Front	1.152	1.109	0.218	2.26	1.37
		Back	1.545	1.109	0.218	2.65	1.76
		Bottom Side	3.265			3.27	3.27

Test Engineer: Nick Hu

## **17. Uncertainty Assessment**

The component of uncertainty may generally be categorized according to the methods used to evaluate them. The evaluation of uncertainty by the statistical analysis of a series of observations is termed a Type A evaluation of uncertainty. The evaluation of uncertainty by means other than the statistical analysis of a series of observation is termed a Type B evaluation of uncertainty. Each component of uncertainty, however evaluated, is represented by an estimated standard deviation, termed standard uncertainty, which is determined by the positive square root of the estimated variance.

A Type A evaluation of standard uncertainty may be based on any valid statistical method for treating data. This includes calculating the standard deviation of the mean of a series of independent observations; using the method of least squares to fit a curve to the data in order to estimate the parameter of the curve and their standard deviations; or carrying out an analysis of variance in order to identify and quantify random effects in certain kinds of measurement.

A type B evaluation of standard uncertainty is typically based on scientific judgment using all of the relevant information available. These may include previous measurement data, experience, and knowledge of the behavior and properties of relevant materials and instruments, manufacture’s specification, data provided in calibration reports and uncertainties assigned to reference data taken from handbooks. Broadly speaking, the uncertainty is either obtained from an outdoor source or obtained from an assumed distribution, such as the normal distribution, rectangular or triangular distributions indicated in table below.

<b>Uncertainty Distributions</b>	<b>Normal</b>	<b>Rectangular</b>	<b>Triangular</b>	<b>U-Shape</b>
Multi-plying Factor <sup>(a)</sup>	1/k <sup>(b)</sup>	1/√3	1/√6	1/√2

(a) standard uncertainty is determined as the product of the multiplying factor and the estimated range of variations in the measured quantity

(b)  $\kappa$  is the coverage factor

**Table 17.1. Standard Uncertainty for Assumed Distribution**

The combined standard uncertainty of the measurement result represents the estimated standard deviation of the result. It is obtained by combining the individual standard uncertainties of both Type A and Type B evaluation using the usual “root-sum-squares” (RSS) methods of combining standard deviations by taking the positive square root of the estimated variances.

Expanded uncertainty is a measure of uncertainty that defines an interval about the measurement result within which the measured value is confidently believed to lie. It is obtained by multiplying the combined standard uncertainty by a coverage factor. Typically, the coverage factor ranges from 2 to 3. Using a coverage factor allows the true value of a measured quantity to be specified with a defined probability within the specified uncertainty range. For purpose of this document, a coverage factor two is used, which corresponds to confidence interval of about 95 %. The DASY uncertainty Budget is shown in the following tables.

Error Description	Uncertainty Value (±%)	Probability	Divisor	(Ci) 1g	(Ci) 10g	Standard Uncertainty (1g) (±%)	Standard Uncertainty (10g) (±%)
<b>Measurement System</b>							
Probe Calibration	6.0	N	1	1	1	6.0	6.0
Axial Isotropy	4.7	R	1.732	0.7	0.7	1.9	1.9
Hemispherical Isotropy	9.6	R	1.732	0.7	0.7	3.9	3.9
Boundary Effects	1.0	R	1.732	1	1	0.6	0.6
Linearity	4.7	R	1.732	1	1	2.7	2.7
System Detection Limits	1.0	R	1.732	1	1	0.6	0.6
Modulation Response	3.2	R	1.732	1	1	1.8	1.8
Readout Electronics	0.3	N	1	1	1	0.3	0.3
Response Time	0.0	R	1.732	1	1	0.0	0.0
Integration Time	2.6	R	1.732	1	1	1.5	1.5
RF Ambient Noise	3.0	R	1.732	1	1	1.7	1.7
RF Ambient Reflections	3.0	R	1.732	1	1	1.7	1.7
Probe Positioner	0.4	R	1.732	1	1	0.2	0.2
Probe Positioning	2.9	R	1.732	1	1	1.7	1.7
Max. SAR Eval.	2.0	R	1.732	1	1	1.2	1.2
<b>Test Sample Related</b>							
Device Positioning	3.0	N	1	1	1	3.0	3.0
Device Holder	3.6	N	1	1	1	3.6	3.6
Power Drift	5.0	R	1.732	1	1	2.9	2.9
Power Scaling	0.0	R	1.732	1	1	0.0	0.0
<b>Phantom and Setup</b>							
Phantom Uncertainty	6.1	R	1.732	1	1	3.5	3.5
SAR correction	0.0	R	1.732	1	0.84	0.0	0.0
Liquid Conductivity Repeatability	0.2	N	1	0.78	0.71	0.1	0.1
Liquid Conductivity (target)	5.0	R	1.732	0.78	0.71	2.3	2.0
Liquid Conductivity (mea.)	2.5	R	1.732	0.78	0.71	1.1	1.0
Temp. unc. - Conductivity	3.4	R	1.732	0.78	0.71	1.5	1.4
Liquid Permittivity Repeatability	0.15	N	1	0.23	0.26	0.0	0.0
Liquid Permittivity (target)	5.0	R	1.732	0.23	0.26	0.7	0.8
Liquid Permittivity (mea.)	2.5	R	1.732	0.23	0.26	0.3	0.4
Temp. unc. - Permittivity	0.83	R	1.732	0.23	0.26	0.1	0.1
<b>Combined Std. Uncertainty</b>						11.4%	11.4%
<b>Coverage Factor for 95 %</b>						K=2	K=2
<b>Expanded STD Uncertainty</b>						22.9%	22.7%

**Table 17.2. Uncertainty Budget for frequency range 300 MHz to 3 GHz**

Error Description	Uncertainty Value (±%)	Probability	Divisor	(Ci) 1g	(Ci) 10g	Standard Uncertainty (1g) (±%)	Standard Uncertainty (10g) (±%)
<b>Measurement System</b>							
Probe Calibration	6.55	N	1	1	1	6.6	6.6
Axial Isotropy	4.7	R	1.732	0.7	0.7	1.9	1.9
Hemispherical Isotropy	9.6	R	1.732	0.7	0.7	3.9	3.9
Boundary Effects	2.0	R	1.732	1	1	1.2	1.2
Linearity	4.7	R	1.732	1	1	2.7	2.7
System Detection Limits	1.0	R	1.732	1	1	0.6	0.6
Modulation Response	3.2	R	1.732	1	1	1.8	1.8
Readout Electronics	0.3	N	1	1	1	0.3	0.3
Response Time	0.0	R	1.732	1	1	0.0	0.0
Integration Time	2.6	R	1.732	1	1	1.5	1.5
RF Ambient Noise	3.0	R	1.732	1	1	1.7	1.7
RF Ambient Reflections	3.0	R	1.732	1	1	1.7	1.7
Probe Positioner	0.4	R	1.732	1	1	0.2	0.2
Probe Positioning	6.7	R	1.732	1	1	3.9	3.9
Max. SAR Eval.	4.0	R	1.732	1	1	2.3	2.3
<b>Test Sample Related</b>							
Device Positioning	3.0	N	1	1	1	3.0	3.0
Device Holder	3.6	N	1	1	1	3.6	3.6
Power Drift	5.0	R	1.732	1	1	2.9	2.9
Power Scaling	0.0	R	1.732	1	1	0.0	0.0
<b>Phantom and Setup</b>							
Phantom Uncertainty	6.6	R	1.732	1	1	3.8	3.8
SAR correction	0.0	R	1.732	1	0.84	0.0	0.0
Liquid Conductivity Repeatability	0.2	N	1	0.78	0.71	0.1	0.1
Liquid Conductivity (target)	5.0	R	1.732	0.78	0.71	2.3	2.0
Liquid Conductivity (mea.)	2.5	R	1.732	0.78	0.71	1.1	1.0
Temp. unc. - Conductivity	3.4	R	1.732	0.78	0.71	1.5	1.4
Liquid Permittivity Repeatability	0.15	N	1	0.23	0.26	0.0	0.0
Liquid Permittivity (target)	5.0	R	1.732	0.23	0.26	0.7	0.8
Liquid Permittivity (mea.)	2.5	R	1.732	0.23	0.26	0.3	0.4
Temp. unc. - Permittivity	0.83	R	1.732	0.23	0.26	0.1	0.1
<b>Combined Std. Uncertainty</b>						12.5%	12.5%
<b>Coverage Factor for 95 %</b>						K=2	K=2
<b>Expanded STD Uncertainty</b>						25.1%	25.0%

**Table 17.3. Uncertainty Budget for frequency range 3 GHz to 6 GHz**



## **18. References**

- [1] FCC 47 CFR Part 2 "Frequency Allocations and Radio Treaty Matters; General Rules and Regulations"
- [2] ANSI/IEEE Std. C95.1-1992, "IEEE Standard for Safety Levels with Respect to Human Exposure to Radio Frequency Electromagnetic Fields, 3 kHz to 300 GHz", September 1992
- [3] IEEE Std. 1528-2013, "IEEE Recommended Practice for Determining the Peak Spatial-Average Specific Absorption Rate (SAR) in the Human Head from Wireless Communications Devices: Measurement Techniques", Sep 2013
- [4] SPEAG DASY System Handbook
- [5] FCC KDB 248227 D01 v02r02, "SAR Guidance for IEEE 802.11 (WiFi) Transmitters", Oct 2015.
- [6] FCC KDB 447498 D01 v06, "Mobile and Portable Device RF Exposure Procedures and Equipment Authorization Policies", Oct 2015
- [7] FCC KDB 648474 D04 v01r03, "SAR Evaluation Considerations for Wireless Handsets", Oct 2015.
- [8] FCC KDB 941225 D01 v03r01, "3G SAR MEAUREMENT PROCEDURES", Oct 2015
- [9] FCC KDB 941225 D05 v02r05, "SAR Evaluation Considerations for LTE Devices", Dec 2015
- [10] FCC KDB 941225 D05A v01r02, "Rel. 10 LTE SAR Test Guidance and KDB Inquiries", Oct 2015
- [11] FCC KDB 941225 D06 v02r01, "SAR Evaluation Procedures for Portable Devices with Wireless Router Capabilities", Oct 2015.
- [12] FCC KDB 865664 D01 v01r04, "SAR Measurement Requirements for 100 MHz to 6 GHz", Aug 2015.
- [13] FCC KDB 865664 D02 v01r02, "RF Exposure Compliance Reporting and Documentation Considerations" Oct 2015.



## **Appendix A. Plots of System Performance Check**

The plots are shown as follows.

### System Check\_Head\_750MHz

**DUT: D750V3 - SN:1065**

Communication System: UID 0, CW (0); Frequency: 750 MHz; Duty Cycle: 1:1

Medium: HSL\_750 Medium parameters used:  $f = 750 \text{ MHz}$ ;  $\sigma = 0.903 \text{ S/m}$ ;  $\epsilon_r = 41.728$ ;  $\rho = 1000 \text{ kg/m}^3$

Ambient Temperature :  $23.6 \text{ }^\circ\text{C}$ ; Liquid Temperature :  $22.6 \text{ }^\circ\text{C}$

DASY5 Configuration:

- Probe: EX3DV4 - SN3954; ConvF(10.98, 10.98, 10.98); Calibrated: 2016.11.28;
- Sensor-Surface: 2mm (Mechanical Surface Detection)
- Electronics: DAE4 Sn1279; Calibrated: 2017.5.2
- Phantom: SAM1; Type: SAM; Serial: TP-1842
- Measurement SW: DASY52, Version 52.8 (8); SEMCAD X Version 14.6.10 (7331)

**Pin=250mW/Area Scan (61x61x1):** Interpolated grid:  $dx=1.500 \text{ mm}$ ,  $dy=1.500 \text{ mm}$   
Maximum value of SAR (interpolated) =  $2.72 \text{ W/kg}$

**Pin=250mW/Zoom Scan (5x5x7)/Cube 0:** Measurement grid:  $dx=8\text{mm}$ ,  $dy=8\text{mm}$ ,  $dz=5\text{mm}$   
Reference Value =  $49.70 \text{ V/m}$ ; Power Drift =  $0.03 \text{ dB}$   
Peak SAR (extrapolated) =  $3.23 \text{ W/kg}$   
**SAR(1 g) =  $2.18 \text{ W/kg}$ ; SAR(10 g) =  $1.45 \text{ W/kg}$**   
Maximum value of SAR (measured) =  $2.75 \text{ W/kg}$

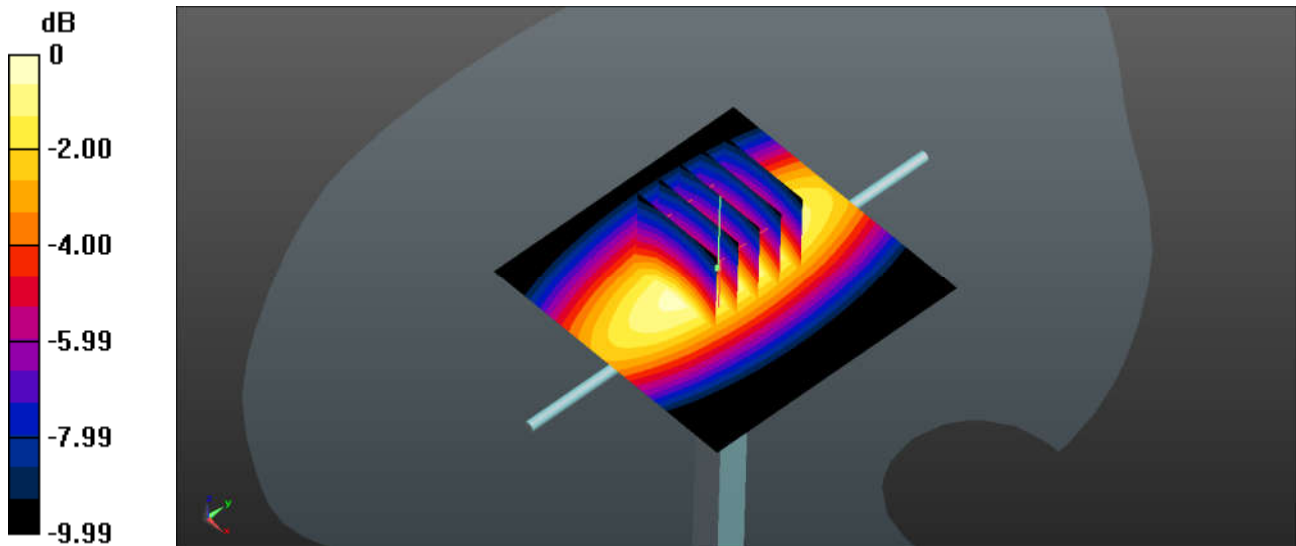

0 dB =  $2.75 \text{ W/kg} = 4.39 \text{ dBW/kg}$

### System Check\_Head\_835MHz

**DUT: D835V2 - SN:4d091**

Communication System: UID 0, CW (0); Frequency: 835 MHz; Duty Cycle: 1:1

Medium: HSL\_850 Medium parameters used:  $f = 835 \text{ MHz}$ ;  $\sigma = 0.904 \text{ S/m}$ ;  $\epsilon_r = 41.521$ ;  $\rho = 1000 \text{ kg/m}^3$

Ambient Temperature :  $23.6 \text{ }^\circ\text{C}$ ; Liquid Temperature :  $22.6 \text{ }^\circ\text{C}$

DASY5 Configuration:

- Probe: EX3DV4 - SN3954; ConvF(10.52, 10.52, 10.52); Calibrated: 2016.11.28;
- Sensor-Surface: 2mm (Mechanical Surface Detection)
- Electronics: DAE4 Sn1279; Calibrated: 2017.5.2
- Phantom: SAM1; Type: SAM; Serial: TP-1842
- Measurement SW: DASY52, Version 52.8 (8); SEMCAD X Version 14.6.10 (7331)

**Pin=250mW/Area Scan (61x61x1):** Interpolated grid:  $dx=1.500 \text{ mm}$ ,  $dy=1.500 \text{ mm}$   
Maximum value of SAR (interpolated) =  $3.01 \text{ W/kg}$

**Pin=250mW/Zoom Scan (5x5x7)/Cube 0:** Measurement grid:  $dx=8\text{mm}$ ,  $dy=8\text{mm}$ ,  $dz=5\text{mm}$   
Reference Value =  $52.85 \text{ V/m}$ ; Power Drift =  $-0.13 \text{ dB}$   
Peak SAR (extrapolated) =  $3.40 \text{ W/kg}$   
**SAR(1 g) =  $2.4 \text{ W/kg}$ ; SAR(10 g) =  $1.63 \text{ W/kg}$**   
Maximum value of SAR (measured) =  $2.97 \text{ W/kg}$

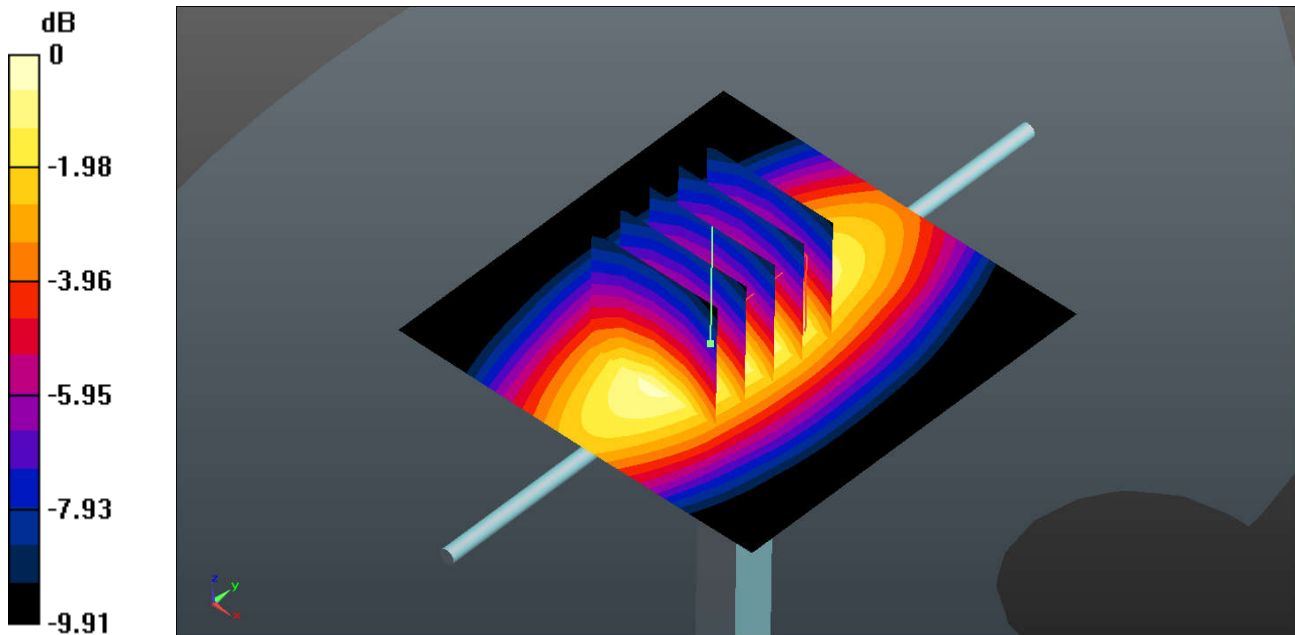

0 dB =  $2.97 \text{ W/kg} = 4.73 \text{ dBW/kg}$

### System Check\_Head\_1750MHz

**DUT: D1750V2 - SN:1069**

Communication System: UID 0, CW; Frequency: 1750 MHz; Duty Cycle: 1:1

Medium: HSL\_1750 Medium parameters used:  $f = 1750$  MHz;  $\sigma = 1.363$  S/m;  $\epsilon_r = 39.993$ ;  $\rho = 1000$  kg/m<sup>3</sup>

Ambient Temperature : 23.6 °C; Liquid Temperature : 22.7 °C

DASY5 Configuration:

- Probe: EX3DV4 - SN3954; ConvF(8.58, 8.58, 8.58); Calibrated: 2016.11.28;
- Sensor-Surface: 2mm (Mechanical Surface Detection)
- Electronics: DAE4 Sn1279; Calibrated: 2017.5.2
- Phantom: SAM1; Type: SAM; Serial: TP-1842
- Measurement SW: DASY52, Version 52.8 (8); SEMCAD X Version 14.6.10 (7331)

**Pin=250mW/Area Scan (61x61x1):** Interpolated grid: dx=1.500 mm, dy=1.500 mm  
Maximum value of SAR (interpolated) = 13.1 W/kg

**Pin=250mW/Zoom Scan (5x5x7)/Cube 0:** Measurement grid: dx=8mm, dy=8mm, dz=5mm  
Reference Value = 84.13 V/m; Power Drift = -0.03 dB  
Peak SAR (extrapolated) = 14.7 W/kg  
**SAR(1 g) = 8.76 W/kg; SAR(10 g) = 4.87 W/kg**  
Maximum value of SAR (measured) = 12.0 W/kg

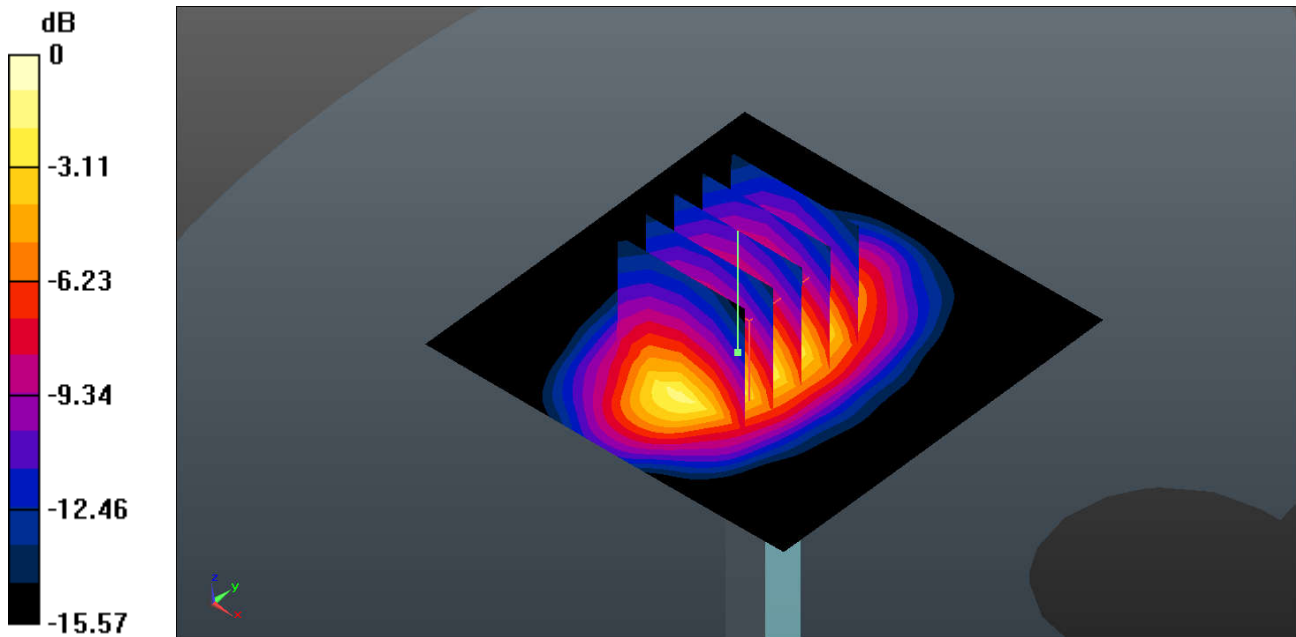

0 dB = 12.0 W/kg = 10.79 dBW/kg

### System Check\_Head\_1900MHz

**DUT: D1900V2 - SN:5d118**

Communication System: UID 0, CW (0); Frequency: 1900 MHz; Duty Cycle: 1:1

Medium: HSL\_1900 Medium parameters used:  $f = 1900$  MHz;  $\sigma = 1.44$  S/m;  $\epsilon_r = 40.233$ ;  $\rho = 1000$  kg/m<sup>3</sup>

Ambient Temperature : 23.6 °C; Liquid Temperature : 22.7 °C

DASY5 Configuration:

- Probe: EX3DV4 - SN3954; ConvF(8.32, 8.32, 8.32); Calibrated: 2016.11.28;
- Sensor-Surface: 2mm (Mechanical Surface Detection)
- Electronics: DAE4 Sn1279; Calibrated: 2017.5.2
- Phantom: SAM1; Type: SAM; Serial: TP-1842
- Measurement SW: DASY52, Version 52.8 (8); SEMCAD X Version 14.6.10 (7331)

**Pin=250mW/Area Scan (61x61x1):** Interpolated grid: dx=1.500 mm, dy=1.500 mm  
Maximum value of SAR (interpolated) = 12.6 W/kg

**Pin=250mW/Zoom Scan (5x5x7)/Cube 0:** Measurement grid: dx=8mm, dy=8mm, dz=5mm  
Reference Value = 83.10 V/m; Power Drift = -0.00 dB  
Peak SAR (extrapolated) = 15.7 W/kg  
**SAR(1 g) = 9.8 W/kg; SAR(10 g) = 4.69 W/kg**  
Maximum value of SAR (measured) = 12.6 W/kg

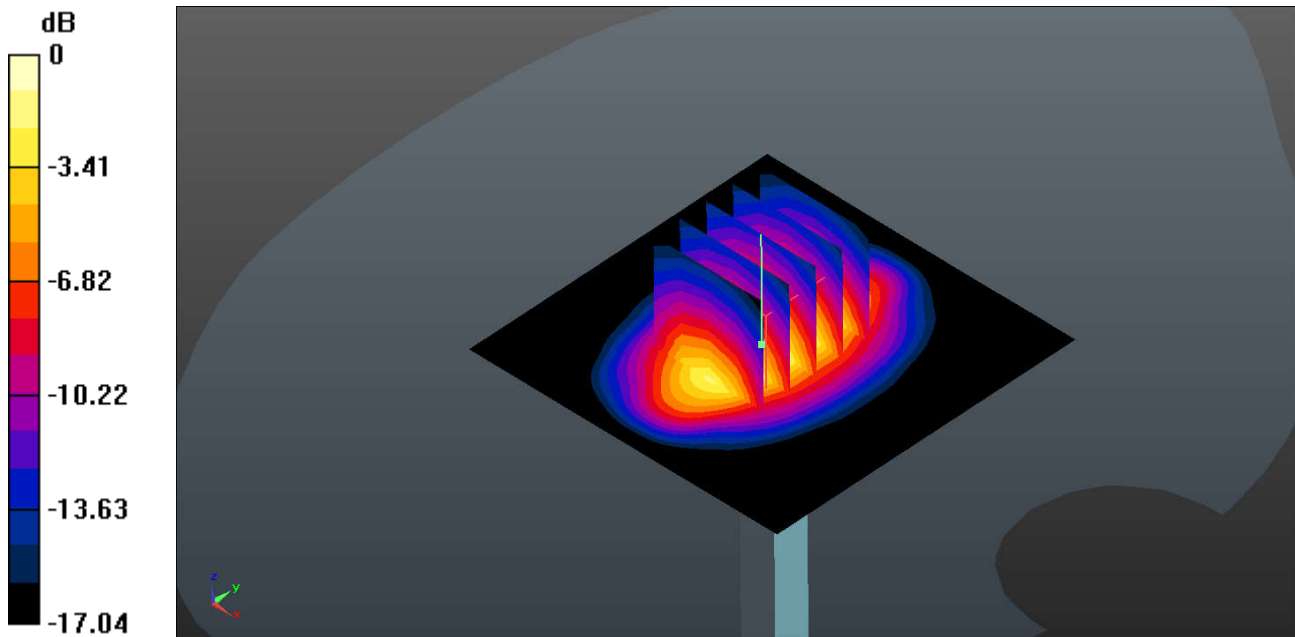

0 dB = 12.6 W/kg = 11.00 dBW/kg

### System Check\_Head\_2450MHz

**DUT: D2450V2 - SN:840**

Communication System: UID 0, CW (0); Frequency: 2450 MHz; Duty Cycle: 1:1

Medium: HSL\_2450 Medium parameters used:  $f = 2450$  MHz;  $\sigma = 1.883$  S/m;  $\epsilon_r = 38.166$ ;  $\rho = 1000$  kg/m<sup>3</sup>

Ambient Temperature : 23.7 °C; Liquid Temperature : 22.8 °C

DASY5 Configuration:

- Probe: EX3DV4 - SN3954; ConvF(7.44, 7.44, 7.44); Calibrated: 2016.11.28;
- Sensor-Surface: 2mm (Mechanical Surface Detection)
- Electronics: DAE4 Sn1279; Calibrated: 2017.5.2
- Phantom: SAM1; Type: SAM; Serial: TP-1842
- Measurement SW: DASY52, Version 52.8 (8); SEMCAD X Version 14.6.10 (7331)

**Pin=250mW/Area Scan (71x71x1):** Interpolated grid: dx=1.200 mm, dy=1.200 mm  
Maximum value of SAR (interpolated) = 21.4 W/kg

**Pin=250mW/Zoom Scan (7x7x7)/Cube 0:** Measurement grid: dx=5mm, dy=5mm, dz=5mm  
Reference Value = 88.32 V/m; Power Drift = -0.05 dB  
Peak SAR (extrapolated) = 28.0 W/kg  
**SAR(1 g) = 13.8 W/kg; SAR(10 g) = 6.51 W/kg**  
Maximum value of SAR (measured) = 20.9 W/kg

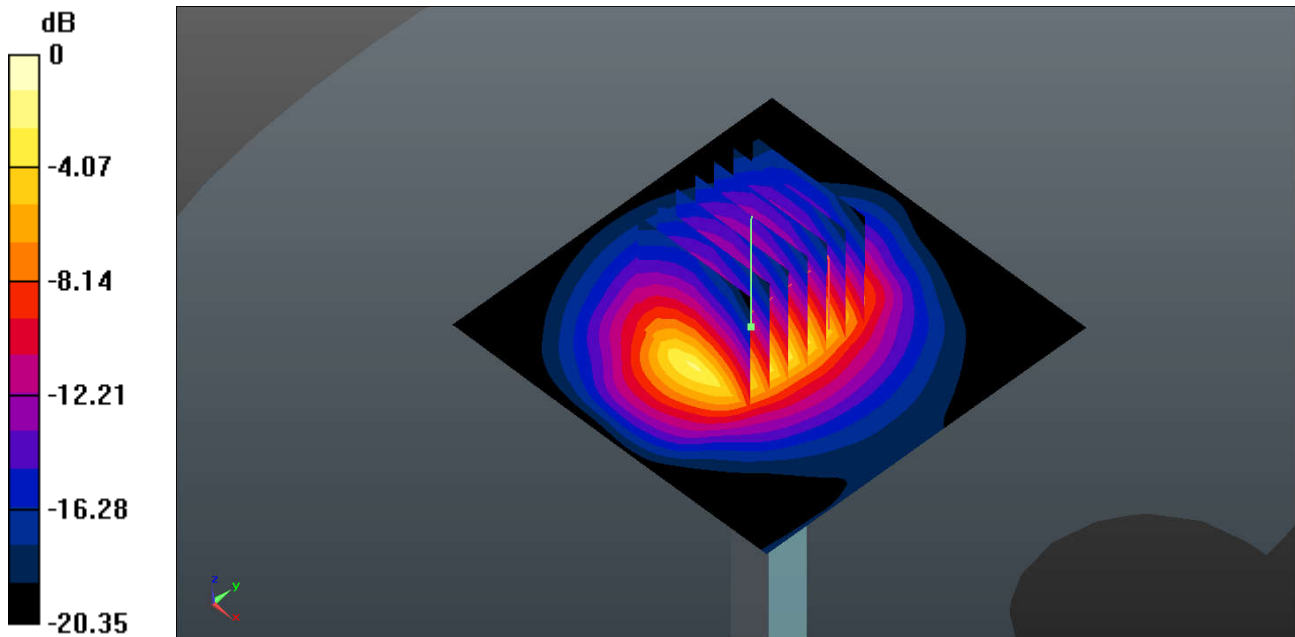

0 dB = 20.9 W/kg = 13.20 dBW/kg

### System Check\_Head\_2600MHz

**DUT: D2600V2 - SN:1061**

Communication System: UID 0, CW; Frequency: 2600 MHz; Duty Cycle: 1:1

Medium: HSL\_2600 Medium parameters used:  $f = 2600$  MHz;  $\sigma = 2.058$  S/m;  $\epsilon_r = 37.577$ ;  $\rho = 1000$  kg/m<sup>3</sup>

Ambient Temperature : 23.7 °C; Liquid Temperature : 22.8 °C

DASY5 Configuration:

- Probe: EX3DV4 - SN3954; ConvF(7.27, 7.27, 7.27); Calibrated: 2016.11.28;
- Sensor-Surface: 2mm (Mechanical Surface Detection)
- Electronics: DAE4 Sn1279; Calibrated: 2017.5.2
- Phantom: SAM1; Type: SAM; Serial: TP-1842
- Measurement SW: DASY52, Version 52.8 (8); SEMCAD X Version 14.6.10 (7331)

**Pin=250mW/Area Scan (71x71x1):** Interpolated grid: dx=1.200 mm, dy=1.200 mm  
Maximum value of SAR (interpolated) = 23.2 W/kg

**Pin=250mW/Zoom Scan (7x7x7)/Cube 0:** Measurement grid: dx=5mm, dy=5mm, dz=5mm  
Reference Value = 86.49 V/m; Power Drift = -0.05 dB  
Peak SAR (extrapolated) = 29.8 W/kg  
**SAR(1 g) = 14.8 W/kg; SAR(10 g) = 6.82 W/kg**  
Maximum value of SAR (measured) = 22.6 W/kg

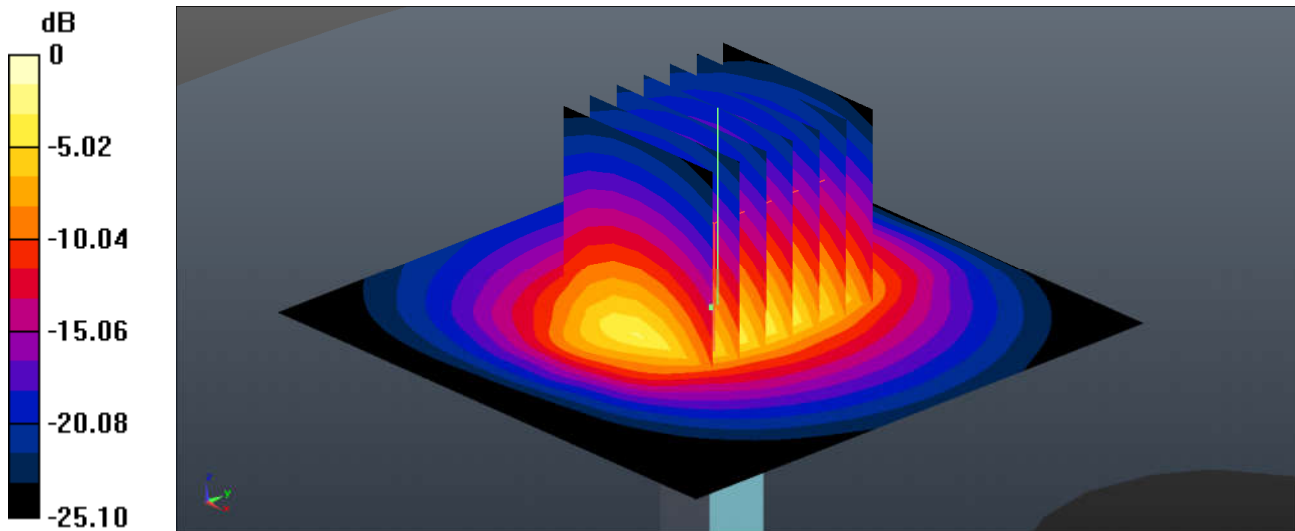

0 dB = 22.6 W/kg = 13.54 dBW/kg

### System Check\_Head\_5250MHz

#### DUT: D5GHzV2-SN:1113

Communication System: UID 0, CW (0); Frequency: 5250 MHz; Duty Cycle: 1:1

Medium: HSL\_5000 Medium parameters used:  $f = 5250$  MHz;  $\sigma = 4.776$  S/m;  $\epsilon_r = 36.018$ ;  $\rho = 1000$  kg/m<sup>3</sup>

Ambient Temperature : 23.7 °C; Liquid Temperature : 22.9 °C

#### DASY5 Configuration:

- Probe: EX3DV4 - SN3954; ConvF(5.08, 5.08, 5.08); Calibrated: 2016.11.28;
- Sensor-Surface: 1.4mm (Mechanical Surface Detection)
- Electronics: DAE4 Sn1279; Calibrated: 2017.5.2
- Phantom: SAM1; Type: SAM; Serial: TP-1842
- Measurement SW: DASY52, Version 52.8 (8); SEMCAD X Version 14.6.10 (7331)

**CW/Area Scan (71x71x1):** Interpolated grid: dx=1.000 mm, dy=1.000 mm

Maximum value of SAR (interpolated) = 17.3 W/kg

**CW/Zoom Scan (8x8x7)/Cube 0:** Measurement grid: dx=4mm, dy=4mm, dz=1.4mm

Reference Value = 40.85 V/m; Power Drift = -0.02 dB

Peak SAR (extrapolated) = 29.5 W/kg

**SAR(1 g) = 8.15 W/kg; SAR(10 g) = 2.51 W/kg**

Maximum value of SAR (measured) = 18.0 W/kg

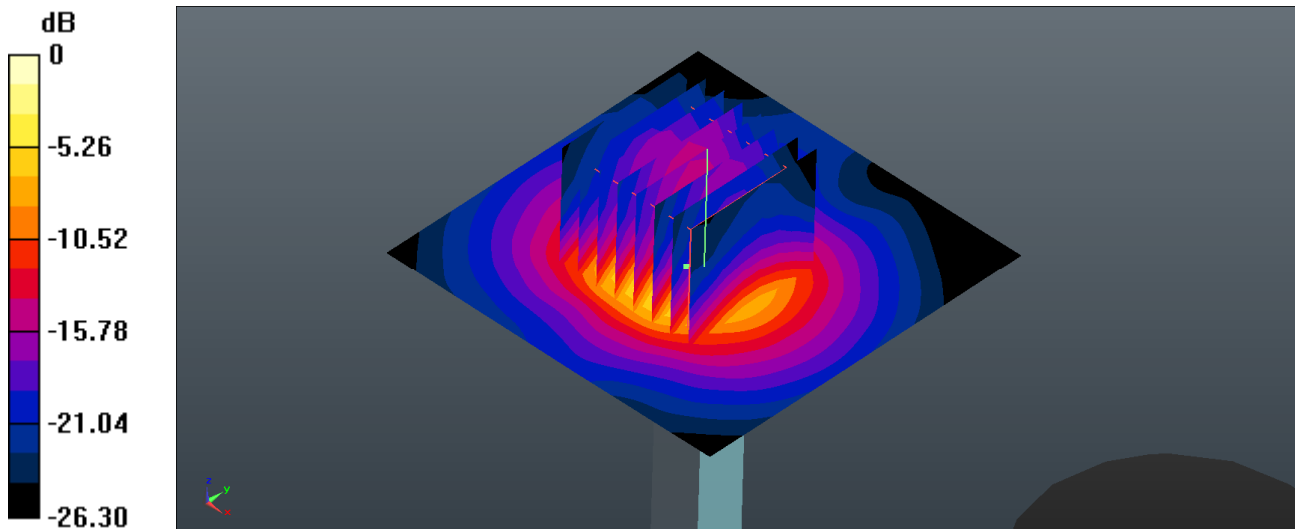

0 dB = 18.0 W/kg = 12.55 dBW/kg

### System Check\_Head\_5600MHz

**DUT: D5GHzV2-SN:1113**

Communication System: UID 0, CW (0); Frequency: 5600 MHz; Duty Cycle: 1:1

Medium: HSL\_5000 Medium parameters used:  $f = 5600$  MHz;  $\sigma = 5.146$  S/m;  $\epsilon_r = 35.478$ ;  $\rho = 1000$  kg/m<sup>3</sup>

Ambient Temperature : 23.7 °C; Liquid Temperature : 22.9 °C

DASY5 Configuration:

- Probe: EX3DV4 - SN3954; ConvF(4.7, 4.7, 4.7); Calibrated: 2016.11.28;
- Sensor-Surface: 1.4mm (Mechanical Surface Detection)
- Electronics: DAE4 Sn1279; Calibrated: 2017.5.2
- Phantom: SAM1; Type: SAM; Serial: TP-1842
- Measurement SW: DASY52, Version 52.8 (8); SEMCAD X Version 14.6.10 (7331)

**CW/Area Scan (71x71x1):** Interpolated grid: dx=1.000 mm, dy=1.000 mm

Maximum value of SAR (interpolated) = 18.0 W/kg

**CW/Zoom Scan (8x8x7)/Cube 0:** Measurement grid: dx=4mm, dy=4mm, dz=1.4mm

Reference Value = 38.96 V/m; Power Drift = -0.05 dB

Peak SAR (extrapolated) = 28.7 W/kg

**SAR(1 g) = 7.71 W/kg; SAR(10 g) = 2.39 W/kg**

Maximum value of SAR (measured) = 17.6 W/kg

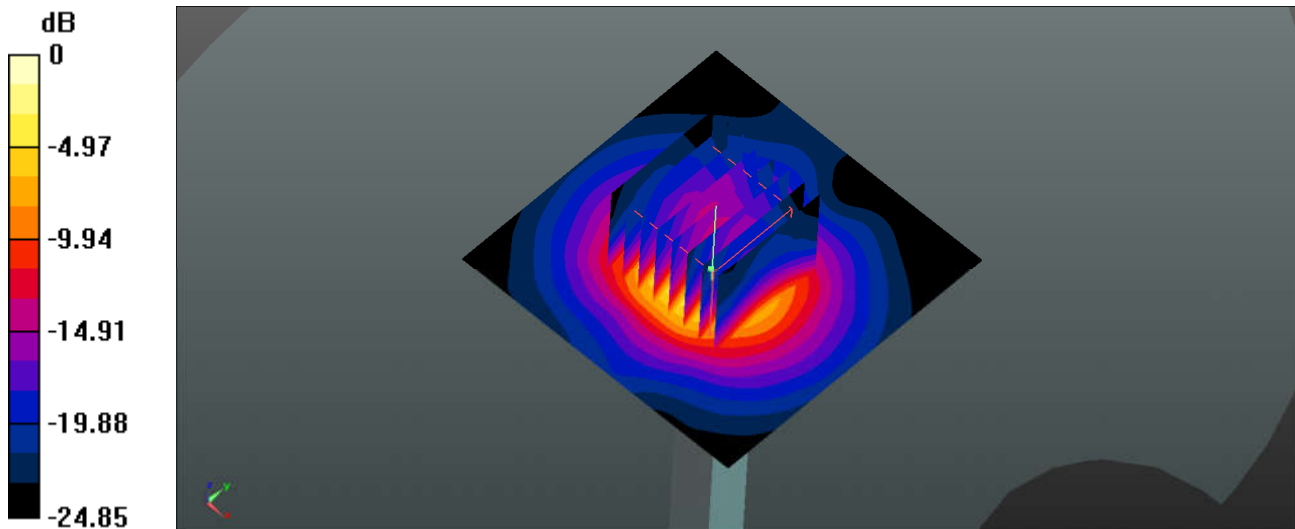

0 dB = 17.6 W/kg = 12.46 dBW/kg

### System Check\_Head\_5750MHz

#### DUT: D5GHzV2-SN:1113

Communication System: UID 0, CW (0); Frequency: 5750 MHz; Duty Cycle: 1:1

Medium: HSL\_5000 Medium parameters used:  $f = 5750$  MHz;  $\sigma = 5.311$  S/m;  $\epsilon_r = 35.242$ ;  $\rho = 1000$  kg/m<sup>3</sup>

Ambient Temperature : 23.7 °C; Liquid Temperature : 22.9 °C

#### DASY5 Configuration:

- Probe: EX3DV4 - SN3954; ConvF(4.69, 4.69, 4.69); Calibrated: 2016.11.28;
- Sensor-Surface: 1.4mm (Mechanical Surface Detection)
- Electronics: DAE4 Sn1279; Calibrated: 2017.5.2
- Phantom: SAM1; Type: SAM; Serial: TP-1842
- Measurement SW: DASY52, Version 52.8 (8); SEMCAD X Version 14.6.10 (7331)

**CW/Area Scan (71x71x1):** Interpolated grid: dx=1.000 mm, dy=1.000 mm

Maximum value of SAR (interpolated) = 16.9 W/kg

**CW/Zoom Scan (8x8x7)/Cube 0:** Measurement grid: dx=4mm, dy=4mm, dz=1.4mm

Reference Value = 37.61 V/m; Power Drift = -0.04 dB

Peak SAR (extrapolated) = 28.0 W/kg

**SAR(1 g) = 7.56 W/kg; SAR(10 g) = 2.35 W/kg**

Maximum value of SAR (measured) = 17.4 W/kg

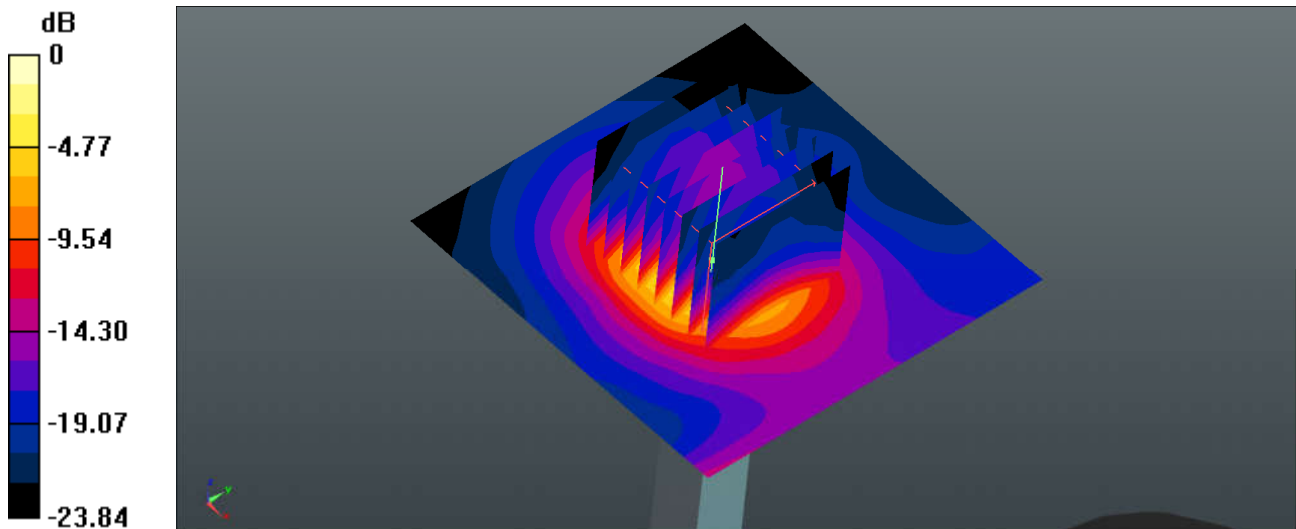

0 dB = 17.4 W/kg = 12.41 dBW/kg

### System Check\_Body\_750MHz

**DUT: D750V3 - SN:1065**

Communication System: UID 0, CW (0); Frequency: 750 MHz; Duty Cycle: 1:1

Medium: MSL\_750 Medium parameters used:  $f = 750 \text{ MHz}$ ;  $\sigma = 0.98 \text{ S/m}$ ;  $\epsilon_r = 56.962$ ;  $\rho = 1000 \text{ kg/m}^3$

Ambient Temperature :  $23.5 \text{ }^\circ\text{C}$ ; Liquid Temperature :  $22.6 \text{ }^\circ\text{C}$

DASY5 Configuration:

- Probe: EX3DV4 - SN3954; ConvF(10.54, 10.54, 10.54); Calibrated: 2016.11.28;
- Sensor-Surface: 2mm (Mechanical Surface Detection)
- Electronics: DAE4 Sn1279; Calibrated: 2017.5.2
- Phantom: SAM3; Type: SAM; Serial: TP-1839
- Measurement SW: DASY52, Version 52.8 (8); SEMCAD X Version 14.6.10 (7331)

**Pin=250mW/Area Scan (61x61x1):** Interpolated grid:  $dx=1.500 \text{ mm}$ ,  $dy=1.500 \text{ mm}$   
Maximum value of SAR (interpolated) =  $2.87 \text{ W/kg}$

**Pin=250mW/Zoom Scan (5x5x7)/Cube 0:** Measurement grid:  $dx=8\text{mm}$ ,  $dy=8\text{mm}$ ,  $dz=5\text{mm}$   
Reference Value =  $49.85 \text{ V/m}$ ; Power Drift =  $-0.13 \text{ dB}$   
Peak SAR (extrapolated) =  $3.34 \text{ W/kg}$   
**SAR(1 g) =  $2.26 \text{ W/kg}$ ; SAR(10 g) =  $1.51 \text{ W/kg}$**   
Maximum value of SAR (measured) =  $2.84 \text{ W/kg}$

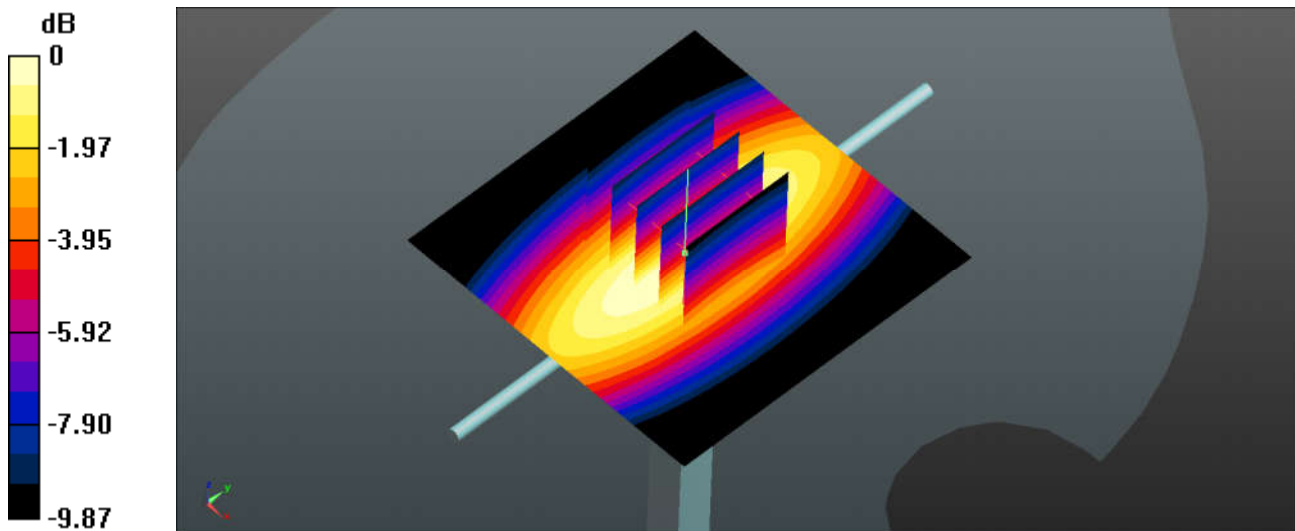

0 dB =  $2.84 \text{ W/kg}$  =  $4.53 \text{ dBW/kg}$

### System Check\_Body\_835MHz

**DUT: D835V2 - SN:4d091**

Communication System: UID 0, CW; Frequency: 835 MHz; Duty Cycle: 1:1

Medium: MSL850 Medium parameters used:  $f = 835 \text{ MHz}$ ;  $\sigma = 0.991 \text{ S/m}$ ;  $\epsilon_r = 54.291$ ;  $\rho = 1000 \text{ kg/m}^3$

Ambient Temperature :  $23.5 \text{ }^\circ\text{C}$ ; Liquid Temperature :  $22.7 \text{ }^\circ\text{C}$

DASY5 Configuration:

- Probe: EX3DV4 - SN3954; ConvF(10.32, 10.32, 10.32); Calibrated: 2016.11.28;
- Sensor-Surface: 2mm (Mechanical Surface Detection)
- Electronics: DAE4 Sn1279; Calibrated: 2017.5.2
- Phantom: SAM3; Type: SAM; Serial: TP-1839
- Measurement SW: DASY52, Version 52.8 (8); SEMCAD X Version 14.6.10 (7331)

**Pin=250mW/Area Scan (61x61x1):** Interpolated grid:  $dx=1.500 \text{ mm}$ ,  $dy=1.500 \text{ mm}$   
Maximum value of SAR (interpolated) =  $2.97 \text{ W/kg}$

**Pin=250mW/Zoom Scan (5x5x7)/Cube 0:** Measurement grid:  $dx=8\text{mm}$ ,  $dy=8\text{mm}$ ,  $dz=5\text{mm}$   
Reference Value =  $47.81 \text{ V/m}$ ; Power Drift =  $0.00 \text{ dB}$   
Peak SAR (extrapolated) =  $2.85 \text{ W/kg}$   
**SAR(1 g) =  $2.38 \text{ W/kg}$ ; SAR(10 g) =  $1.69 \text{ W/kg}$**   
Maximum value of SAR (measured) =  $2.80 \text{ W/kg}$

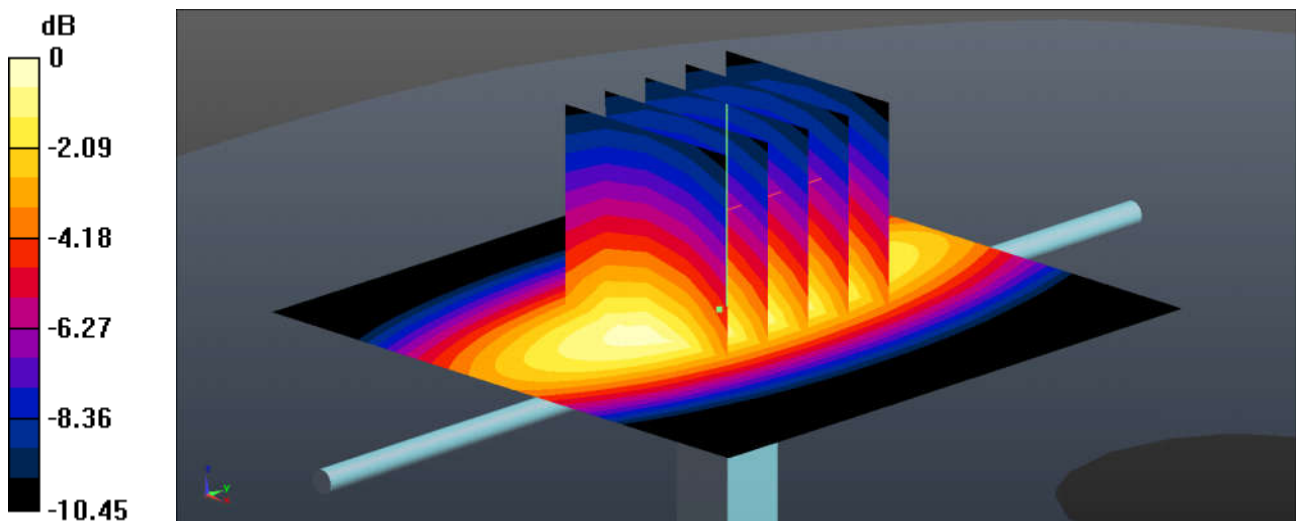

0 dB =  $2.80 \text{ W/kg}$  =  $4.47 \text{ dBW/kg}$

### System Check\_Body\_1750MHz

#### DUT: D1750V2 - SN:1069

Communication System: UID 0, CW (0); Frequency: 1750 MHz; Duty Cycle: 1:1  
Medium: MSL\_1750 Medium parameters used:  $f = 1750$  MHz;  $\sigma = 1.449$  S/m;  $\epsilon_r = 54.495$ ;  $\rho = 1000$  kg/m<sup>3</sup>  
Ambient Temperature : 23.6 °C ; Liquid Temperature : 22.7 °C

#### DASY5 Configuration:

- Probe: EX3DV4 - SN3857; ConvF(8.29, 8.29, 8.29); Calibrated: 2017.5.26;
- Sensor-Surface: 2mm (Mechanical Surface Detection)
- Electronics: DAE4 Sn1210; Calibrated: 2017.5.25
- Phantom: SAM1; Type: SAM; Serial: TP-1479
- Measurement SW: DASY52, Version 52.8 (8); SEMCAD X Version 14.6.10 (7331)

**Pin=250mW/Area Scan (61x61x1):** Interpolated grid: dx=1.500 mm, dy=1.500 mm  
Maximum value of SAR (interpolated) = 12.5 W/kg

**Pin=250mW/Zoom Scan (5x5x7)/Cube 0:** Measurement grid: dx=8mm, dy=8mm, dz=5mm  
Reference Value = 81.83 V/m; Power Drift = -0.12 dB  
Peak SAR (extrapolated) = 14.7 W/kg  
**SAR(1 g) = 8.94 W/kg; SAR(10 g) = 4.97 W/kg**  
Maximum value of SAR (measured) = 12.0 W/kg

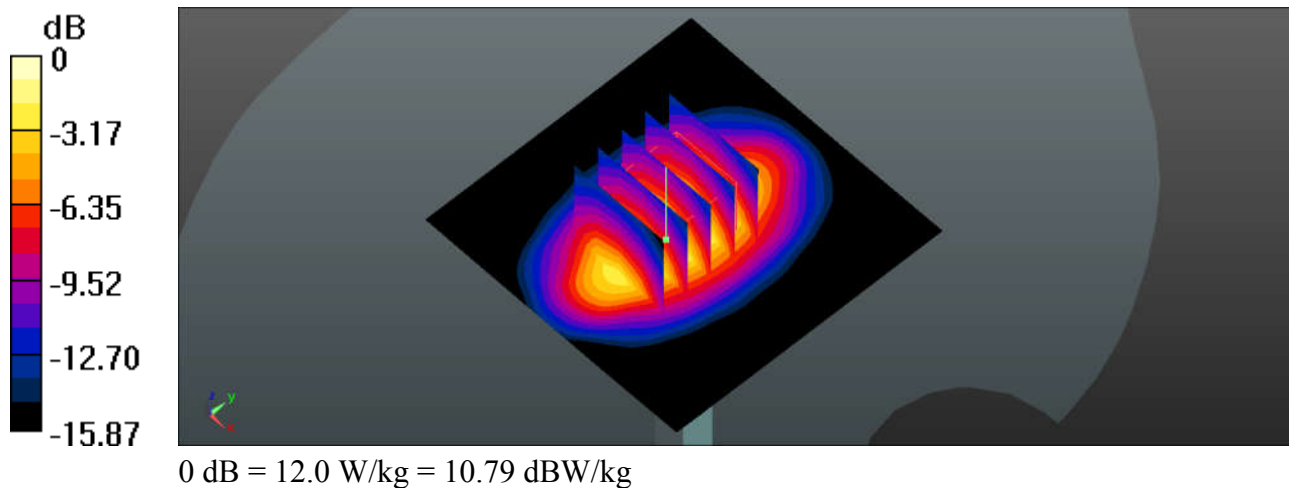

### System Check\_Body\_1900MHz

#### DUT: D1900V2 - SN:5d118

Communication System: UID 0, CW (0); Frequency: 1900 MHz; Duty Cycle: 1:1

Medium: MSL\_1900 Medium parameters used:  $f = 1900$  MHz;  $\sigma = 1.54$  S/m;  $\epsilon_r = 51.409$ ;  $\rho = 1000$  kg/m<sup>3</sup>

Ambient Temperature : 23.6 °C ; Liquid Temperature : 22.8 °C

#### DASY5 Configuration:

- Probe: EX3DV4 - SN3857; ConvF(8.08, 8.08, 8.08); Calibrated: 2017.5.26;
- Sensor-Surface: 2mm (Mechanical Surface Detection)
- Electronics: DAE4 Sn1210; Calibrated: 2017.5.25
- Phantom: SAM1; Type: SAM; Serial: TP-1479
- Measurement SW: DASY52, Version 52.8 (8); SEMCAD X Version 14.6.10 (7331)

**Pin=250mW/Area Scan (61x61x1):** Interpolated grid: dx=1.500 mm, dy=1.500 mm

Maximum value of SAR (interpolated) = 13.9 W/kg

**Pin=250mW/Zoom Scan (5x5x7)/Cube 0:** Measurement grid: dx=8mm, dy=8mm, dz=5mm

Reference Value = 86.04 V/m; Power Drift = -0.12 dB

Peak SAR (extrapolated) = 17.6 W/kg

**SAR(1 g) = 9.81 W/kg; SAR(10 g) = 5.21 W/kg**

Maximum value of SAR (measured) = 14.4 W/kg

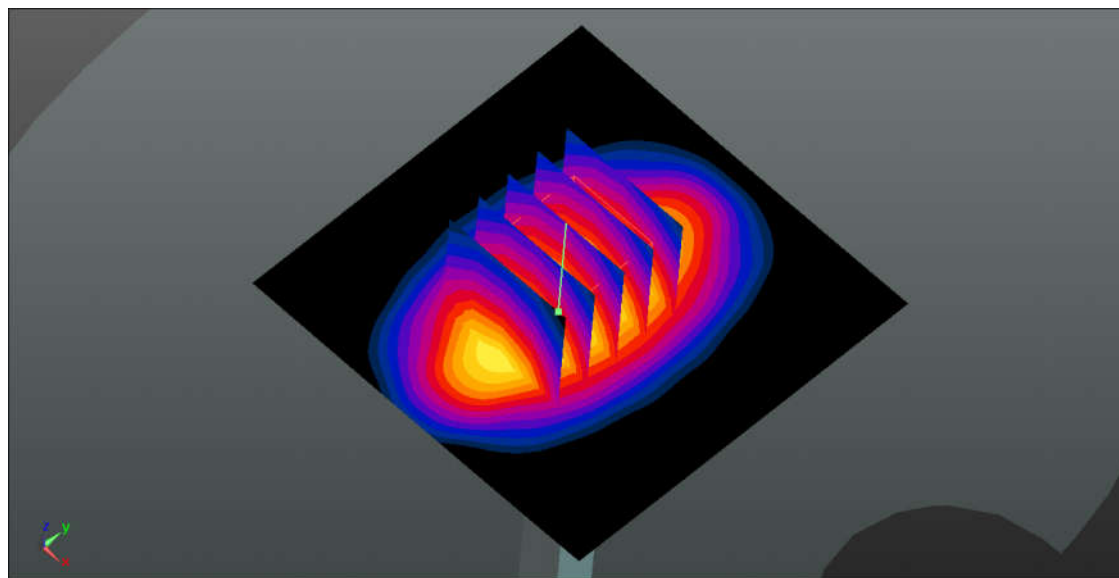
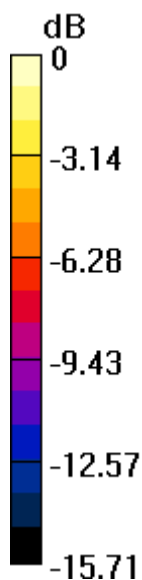

0 dB = 14.4 W/kg = 11.58 dBW/kg

### System Check\_Body\_2450MHz

**DUT: D2450V2 - SN:840**

Communication System: UID 0, CW; Frequency: 2450 MHz; Duty Cycle: 1:1

Medium: MSL\_2450 Medium parameters used:  $f = 2450$  MHz;  $\sigma = 2.018$  S/m;  $\epsilon_r = 52.429$ ;  $\rho = 1000$  kg/m<sup>3</sup>

Ambient Temperature : 23.6 °C; Liquid Temperature : 22.9 °C

DASY5 Configuration:

- Probe: EX3DV4 - SN3954; ConvF(7.55, 7.55, 7.55); Calibrated: 2016.11.28;
- Sensor-Surface: 2mm (Mechanical Surface Detection)
- Electronics: DAE4 Sn1279; Calibrated: 2017.5.2
- Phantom: SAM3; Type: SAM; Serial: TP-1839
- Measurement SW: DASY52, Version 52.8 (8); SEMCAD X Version 14.6.10 (7331)

**Pin=250mW/Area Scan (81x81x1):** Interpolated grid: dx=1.200 mm, dy=1.200 mm  
Maximum value of SAR (interpolated) = 18.9 W/kg

**Pin=250mW/Zoom Scan (7x7x7)/Cube 0:** Measurement grid: dx=5mm, dy=5mm, dz=5mm  
Reference Value = 81.89 V/m; Power Drift = -0.19 dB  
Peak SAR (extrapolated) = 23.9 W/kg  
**SAR(1 g) = 12.6 W/kg; SAR(10 g) = 6.09 W/kg**  
Maximum value of SAR (measured) = 18.6 W/kg

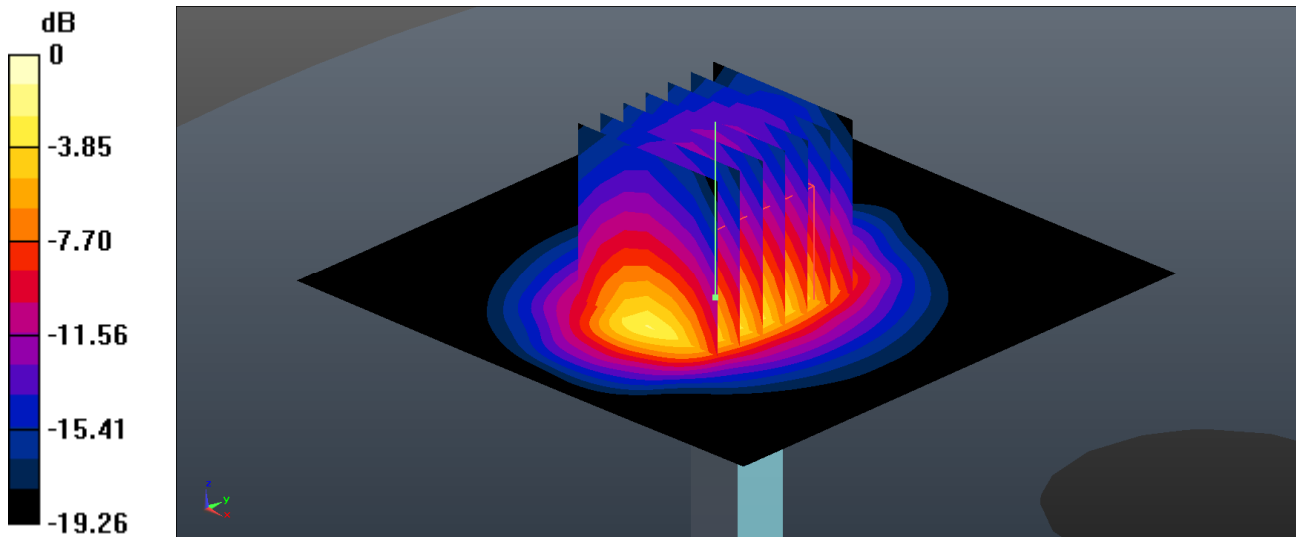

0 dB = 18.6 W/kg = 12.70 dBW/kg

### System Check\_Body\_2600MHz

**DUT: D2600V2 - SN:1061**

Communication System: UID 0, CW (0); Frequency: 2600 MHz; Duty Cycle: 1:1  
Medium: MSL\_2600 Medium parameters used:  $f = 2600$  MHz;  $\sigma = 2.196$  S/m;  $\epsilon_r = 51.31$ ;  $\rho = 1000$  kg/m<sup>3</sup>  
Ambient Temperature : 23.6 °C ; Liquid Temperature : 22.9 °C

#### DASY5 Configuration:

- Probe: EX3DV4 - SN3954; ConvF(7.05, 7.05, 7.05); Calibrated: 2016.11.28;
- Sensor-Surface: 2mm (Mechanical Surface Detection)
- Electronics: DAE4 Sn1279; Calibrated: 2017.5.2
- Phantom: SAM3; Type: SAM; Serial: TP-1839
- Measurement SW: DASY52, Version 52.8 (8); SEMCAD X Version 14.6.10 (7331)

**Pin=250mW/Area Scan (81x81x1):** Interpolated grid: dx=1.200 mm, dy=1.200 mm  
Maximum value of SAR (interpolated) = 22.2 W/kg

**Pin=250mW/Zoom Scan (7x7x7)/Cube 0:** Measurement grid: dx=5mm, dy=5mm, dz=5mm  
Reference Value = 83.27 V/m; Power Drift = -0.08 dB  
Peak SAR (extrapolated) = 28.6 W/kg  
**SAR(1 g) = 14.4 W/kg; SAR(10 g) = 6.67 W/kg**  
Maximum value of SAR (measured) = 21.9 W/kg

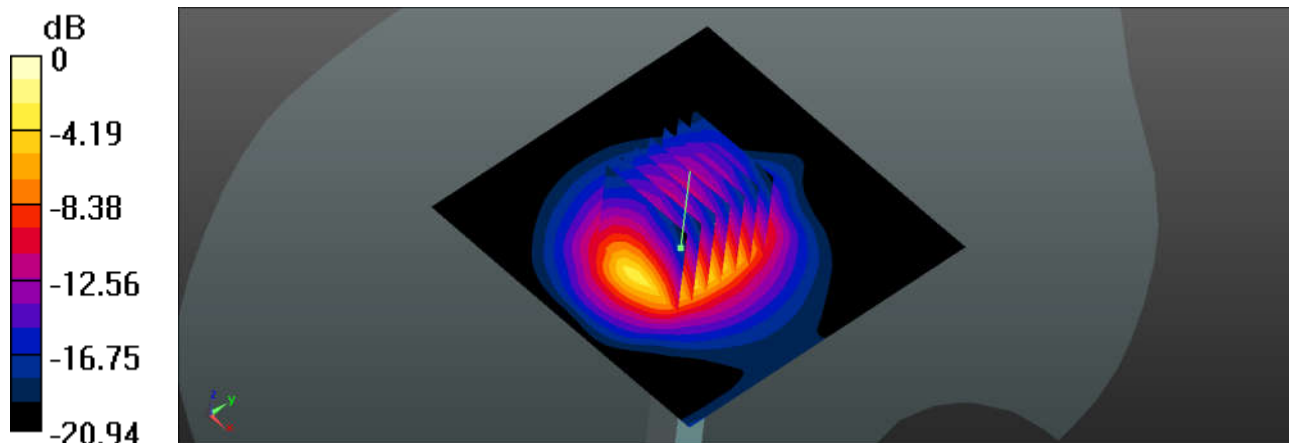

0 dB = 21.9 W/kg = 13.40 dBW/kg

### System Check\_Body\_5250MHz

#### DUT: D5GHzV2-SN:1113

Communication System: UID 0, CW (0); Frequency: 5250 MHz; Duty Cycle: 1:1

Medium: MSL\_5000 Medium parameters used:  $f = 5250$  MHz;  $\sigma = 5.539$  S/m;  $\epsilon_r = 48.005$ ;  $\rho = 1000$  kg/m<sup>3</sup>

Ambient Temperature : 23.6 °C; Liquid Temperature : 22.9 °C

#### DASY5 Configuration:

- Probe: EX3DV4 - SN3954; ConvF(4.5, 4.5, 4.5); Calibrated: 2016.11.28;
- Sensor-Surface: 1.4mm (Mechanical Surface Detection)
- Electronics: DAE4 Sn1279; Calibrated: 2017.5.2
- Phantom: SAM1; Type: SAM; Serial: TP-1842
- Measurement SW: DASY52, Version 52.8 (8); SEMCAD X Version 14.6.10 (7331)

**Pin=100mW/Area Scan (71x71x1):** Interpolated grid: dx=1.000 mm, dy=1.000 mm

Maximum value of SAR (interpolated) = 18.8 W/kg

**Pin=100mW/Zoom Scan (8x8x7)/Cube 0:** Measurement grid: dx=4mm, dy=4mm, dz=1.4mm

Reference Value = 41.08 V/m; Power Drift = -0.03 dB

Peak SAR (extrapolated) = 30.3 W/kg

**SAR(1 g) = 7.48 W/kg; SAR(10 g) = 2.08 W/kg**

Maximum value of SAR (measured) = 17.5 W/kg

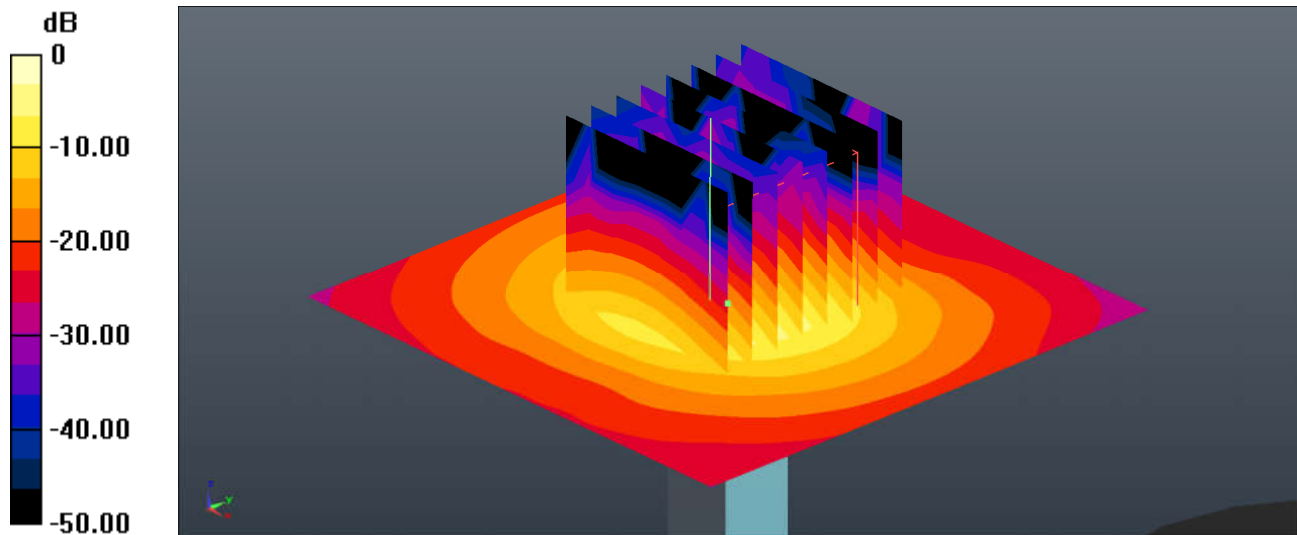

0 dB = 17.5 W/kg = 12.43 dBW/kg