



# FCC RF Test Report

**APPLICANT** : Motorola Mobility, LLC  
**EQUIPMENT** : Mobile Cellular Phone  
**BRAND NAME** : Motorola  
**MODEL NAME** : 10721, 12822  
**FCC ID** : IHDT56WB3  
**STANDARD** : FCC Part 15 Subpart C §15.247  
**CLASSIFICATION** : (DTS) Digital Transmission System

This is a variant report which is only valid together with the original test report. The product was received on Mar. 31, 2017 and testing was completed on May 07, 2017. We, SPORTON INTERNATIONAL INC., would like to declare that the tested sample has been evaluated in accordance with the test procedures and has been in compliance with the applicable technical standards.

The test results in this report apply exclusively to the tested model / sample. Without written approval of SPORTON INTERNATIONAL INC., the test report shall not be reproduced except in full.

Reviewed by: Joseph Lin / Supervisor

Approved by: Jones Tsai / Manager



## **SPORTON INTERNATIONAL INC.**

**No. 52, Hwa Ya 1<sup>st</sup> Rd., Hwa Ya Technology Park, Kwei-Shan District, Tao Yuan City, Taiwan, R.O.C.**

**SPORTON INTERNATIONAL INC.**

TEL : 886-3-327-3456

FAX : 886-3-328-4978

FCC ID : IHDT56WB3

Page Number : 1 of 19

Report Issued Date : May 26, 2017

Report Version : Rev. 01

Report Template No.: BU5-FR15CWL Version 1.3



# TABLE OF CONTENTS

**REVISION HISTORY.....3**

**SUMMARY OF TEST RESULT .....4**

**1 GENERAL DESCRIPTION.....5**

    1.1 Applicant .....5

    1.2 Manufacturer.....5

    1.3 Product Feature of Equipment Under Test.....5

    1.4 Product Specification of Equipment Under Test.....7

    1.5 Modification of EUT .....7

    1.6 Testing Location .....8

    1.7 Applicable Standards.....9

**2 TEST CONFIGURATION OF EQUIPMENT UNDER TEST .....10**

    2.1 Carrier Frequency and Channel .....10

    2.2 Test Mode.....10

    2.3 Connection Diagram of Test System.....11

    2.4 EUT Operation Test Setup .....11

**3 TEST RESULT.....12**

    3.1 Output Power Measurement.....12

    3.2 Radiated Band Edges and Spurious Emission Measurement .....13

    3.3 Antenna Requirements.....17

**4 LIST OF MEASURING EQUIPMENT.....18**

**5 UNCERTAINTY OF EVALUATION.....19**

**APPENDIX A. CONDUCTED TEST RESULTS**

**APPENDIX B. RADIATED SPURIOUS EMISSION**

**APPENDIX C. RADIATED SPURIOUS EMISSION PLOTS**

**APPENDIX D. DUTY CYCLE PLOTS**

**APPENDIX E. ORIGINAL REPORT**





### SUMMARY OF TEST RESULT

Report Section	FCC Rule	Description	Limit	Result	Remark
3.1	15.247(b)	Power Output Measurement	$\leq 30\text{dBm}$	Pass	-
3.2	15.247(d)	Radiated Band Edges and Radiated Spurious Emission	15.209(a) & 15.247(d)	Pass	Under limit 0.82 dB at 4824.000 MHz
3.3	15.203 & 15.247(b)	Antenna Requirement	N/A	Pass	-



# 1 General Description

## 1.1 Applicant

**Motorola Mobility, LLC**

222 W Merchandise Mart Plaza, Suite 1800, Chicago, IL 60654, United States

## 1.2 Manufacturer

**Motorola Mobility, LLC**

222 W Merchandise Mart Plaza, Suite 1800, Chicago, IL 60654, United States

## 1.3 Product Feature of Equipment Under Test

Product Feature	
<b>Equipment</b>	Mobile Cellular Phone
<b>Brand Name</b>	Motorola
<b>Model Name</b>	10721, 12822
<b>FCC ID</b>	IHDT56WB3
<b>IMEI Code</b>	353312080019096
<b>EUT supports Radios application</b>	CDMA/EV-DO/GSM/EGPRS/WCDMA/HSPA/LTE/NFC WLAN 11b/g/n HT20 WLAN 11a/n HT20/HT40 WLAN 11ac VHT20/VHT40/VHT80 Bluetooth BR/EDR/LE
<b>HW Version</b>	DVT2
<b>EUT Stage</b>	Identical Prototype

**Remark:**

1. The above EUT's information was declared by manufacturer. Please refer to the specifications or user's manual for more detailed description.
2. This is a variant report. All the test cases were performed on original report which can be referred to Sporton Report Number FR733129C.



<b>Accessory List</b>	
<b>AC Adapter 1</b>	Brand Name : Motorola
	Model Name : SPN5970A
<b>AC Adapter 2</b>	Brand Name : Motorola
	Model Name : SPN5993A
<b>AC Adapter 3</b>	Brand Name : Motorola
	Model Name : SPN5978A
<b>Battery 1</b>	Brand Name : Motorola
	Model Name : SNN5986A
<b>Battery 2</b>	Brand Name : Motorola
	Model Name : SNN5897A
<b>Earphone</b>	Brand Name : Motorola
	Model Name : SH38C16618
<b>USB Cable</b>	Brand Name : Motorola
	Model Name : SKN6473A
<b>USB-C Data Cable</b>	Brand Name : Motorola
	Model Name : SKN6474A



### 1.4 Product Specification of Equipment Under Test

Standards-related Product Specification										
<b>Tx/Rx Channel Frequency Range</b>	2412 MHz ~ 2462 MHz									
<b>Maximum (Peak) Output Power to antenna</b>	<p>&lt;Ant. 1&gt;            802.11b : 18.51 dBm (0.0710 W)            802.11g : 23.51 dBm (0.2244 W)            802.11n HT20 : 23.35 dBm (0.2163 W)            802.11ac VHT20 : 23.35 dBm (0.2163 W)</p> <p>&lt;Ant. 2&gt;            802.11b : 18.35 dBm (0.0684 W)            802.11g : 22.16 dBm (0.1644 W)            802.11n HT20 : 22.10 dBm (0.1622 W)            802.11ac VHT20 : 22.11 dBm (0.1626 W)</p> <p><b>MIMO &lt;Ant. 1 + 2&gt;</b>            802.11b : 21.44 dBm (0.1393 W)            802.11g : 25.63 dBm (0.3656 W)            802.11n HT20 : 25.52 dBm (0.3565 W)            802.11ac VHT20 : 25.51 dBm (0.3556 W)</p>									
<b>Antenna Type / Gain</b>	<p>&lt;Ant. 1&gt;            Fixed Internal Antenna type with gain -2.0 dBi</p> <p>&lt;Ant. 2&gt;            Fixed Internal Antenna type with gain -0.3 dBi</p>									
<b>Type of Modulation</b>	802.11b : DSSS (DBPSK / DQPSK / CCK) 802.11g/n : OFDM (BPSK / QPSK / 16QAM / 64QAM) 802.11ac : OFDM (BPSK / QPSK / 16QAM / 64QAM / 256QAM)									
<b>Antenna Function for Transmitter</b>	<table border="1"> <thead> <tr> <th></th> <th>Ant. 1</th> <th>Ant. 2</th> </tr> </thead> <tbody> <tr> <td>802.11 b/g/n/ac</td> <td>V</td> <td>V</td> </tr> <tr> <td>802.11 b/g/n/ac MIMO</td> <td>V</td> <td>V</td> </tr> </tbody> </table>		Ant. 1	Ant. 2	802.11 b/g/n/ac	V	V	802.11 b/g/n/ac MIMO	V	V
	Ant. 1	Ant. 2								
802.11 b/g/n/ac	V	V								
802.11 b/g/n/ac MIMO	V	V								

Note: MIMO Ant. 1+2 is a calculated result from sum of the power MIMO Ant. 1 and MIMO Ant. 2.

### 1.5 Modification of EUT

No modifications are made to the EUT during all test items.



### 1.6 Testing Location

Sporton Lab is accredited to ISO 17025 by Taiwan Accreditation Foundation (TAF code : 1190) and the FCC designation No. TW0007 under the FCC 2.948(e) by Mutual Recognition Agreement (MRA) in FCC Test.

<b>Test Site</b>	SPORTON INTERNATIONAL INC.
<b>Test Site Location</b>	No. 52, Hwa Ya 1 <sup>st</sup> Rd., Hwa Ya Technology Park, Kwei-Shan District, Tao Yuan City, Taiwan, R.O.C. TEL: +886-3-327-3456 FAX: +886-3-328-4978
<b>Test Site No.</b>	<b>Sporton Site No.</b> TH05-HY

**Note:** The test site complies with ANSI C63.4 2014 requirement.

<b>Test Site</b>	SPORTON INTERNATIONAL INC.
<b>Test Site Location</b>	No.58, Aly. 75, Ln. 564, Wenhua 3rd Rd. Guishan Dist, Taoyuan City, Taiwan (R.O.C.) TEL: +886-3-327-0868 FAX: +886-3-327-0855
<b>Test Site No.</b>	<b>Sporton Site No.</b> 03CH11-HY

**Note:** The test site complies with ANSI C63.4 2014 requirement.





## 1.7 Applicable Standards

According to the specifications of the manufacturer, the EUT must comply with the requirements of the following standards:

- ♦ FCC Part 15 Subpart C §15.247
- ♦ FCC KDB Publication No. 558074 D01 DTS Meas. Guidance v04
- ♦ FCC KDB 662911 D01 Multiple Transmitter Output v02r01.
- ♦ FCC KDB 644545 D03 Guidance for IEEE 802 11ac New Rules v01
- ♦ ANSI C63.10-2013

**Remark:**

1. All test items were verified and recorded according to the standards and without any deviation during the test.
2. This EUT has also been tested and complied with the requirements of FCC Part 15, Subpart B, recorded in a separate test report.



## 2 Test Configuration of Equipment Under Test

The EUT has been associated with peripherals and configuration operated in a manner tended to maximize its emission characteristics in a typical application. Frequency range investigated: radiated emission (9 kHz to the 10th harmonic of the highest fundamental frequency or to 40 GHz, whichever is lower). For radiated measurement, pre-scanned in three orthogonal panels, X, Y, Z. The worst cases (Z plane) were recorded in this report.

### 2.1 Carrier Frequency and Channel

Frequency Band	Channel	Freq. (MHz)	Channel	Freq. (MHz)
2400-2483.5 MHz	1	2412	7	2442
	2	2417	8	2447
	3	2422	9	2452
	4	2427	10	2457
	5	2432	11	2462
	6	2437	-	-

### 2.2 Test Mode

Final test mode of conducted test items and radiated spurious emissions are considering the modulation and worse data rates as below table.

Modulation	Data Rate
802.11b	1 Mbps
802.11n HT20	MCS0

**Remark:** All the radiated test cases were performance with Adapter 1 and Battery 2.

## 2.3 Connection Diagram of Test System

<WLAN Tx Mode>

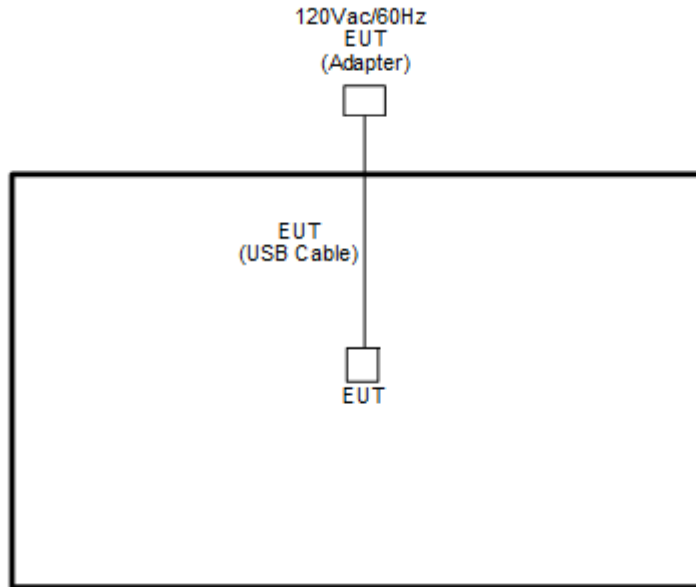

## 2.4 EUT Operation Test Setup

The RF test items, programmed RF utility, "QRCT" installed in the notebook make the EUT provide functions like channel selection and power level for continuous transmitting and receiving signals.

### 3 Test Result

#### 3.1 Output Power Measurement

##### 3.1.1 Limit of Output Power

For systems using digital modulation in the 2400-2483.5MHz, the limit for peak output power is 30dBm. If transmitting antenna of directional gain greater than 6dBi are used the peak output power from the intentional radiator shall be reduced below the above stated value by the amount in dB that the directional gain of the antenna exceeds 6 dBi. In case of point-to-point operation, the limit has to be reduced by 1dB for every 3dB that the directional gain of the antenna exceeds 6dBi.

##### 3.1.2 Measuring Instruments

The measuring equipment is listed in the section 4 of this test report.

##### 3.1.3 Test Procedures

1. The testing follows the Measurement Procedure of FCC KDB No. 558074 DTS D01 Meas. Guidance v04 section 9.1.3 PKPM1 Peak power meter method.
2. The RF output of EUT was connected to the power meter by RF cable and attenuator. The path loss was compensated to the results for each measurement.
3. Set to the maximum power setting and enable the EUT transmit continuously.
4. Measure the conducted output power and record the results in the test report.

##### 3.1.4 Test Setup

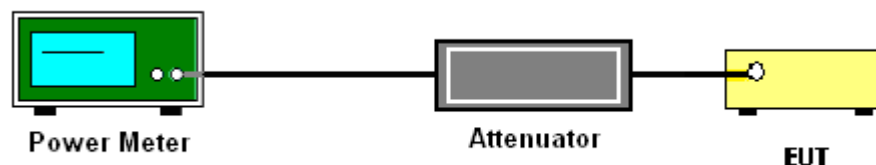

##### 3.1.5 Test Result of Peak Output Power

Please refer to Appendix A.

##### 3.1.6 Test Result of Average output Power (Reporting Only)

Please refer to Appendix A.



### 3.2 Radiated Band Edges and Spurious Emission Measurement

#### 3.2.1 Limit of Radiated band edge and Spurious Emission Measurement

In any 100 kHz bandwidth outside the intentional radiator frequency band, all harmonics/spurious must be at least 20 dB below the highest emission level within the authorized band. If the output power of this device was measured by spectrum analyzer, the attenuation under this paragraph shall be 30 dB instead of 20 dB. In addition, radiated emissions which fall in the restricted bands must also comply with the limits as below.

Frequency (MHz)	Field Strength (microvolts/meter)	Measurement Distance (meters)
0.009 – 0.490	2400/F(kHz)	300
0.490 – 1.705	24000/F(kHz)	30
1.705 – 30.0	30	30
30 – 88	100	3
88 – 216	150	3
216 - 960	200	3
Above 960	500	3

#### 3.2.2 Measuring Instruments

The measuring equipment is listed in the section 4 of this test report.



### 3.2.3 Test Procedures

1. The testing follows FCC KDB Publication No. 558074 D01 DTS Meas. Guidance v04.
2. The EUT was arranged to its worst case and then tune the antenna tower (from 1 m to 4 m) and turntable (from 0 degree to 360 degrees) to find the maximum reading. A pre-amp and a high pass filter are used for the test in order to get better signal level.
3. The EUT was placed on a turntable with 0.8 meter for frequency below 1GHz and 1.5 meter for frequency above 1GHz respectively above ground.
4. The EUT was set 3 meters from the interference receiving antenna, which was mounted on the top of a variable height antenna tower.
5. Corrected Reading: Antenna Factor + Cable Loss + Read Level - Preamp Factor = Level
6. For testing below 1GHz, if the emission level of the EUT in peak mode was 3 dB lower than the limit specified, then peak values of EUT will be reported, otherwise, the emissions will be repeated one by one using the CISPR quasi-peak method and reported.
7. For testing above 1GHz, the emission level of the EUT in peak mode was 20dB lower than average limit (that means the emission level in average mode also complies with the limit in average mode), then peak values of EUT will be reported, otherwise, the emissions will be measured in average mode again and reported.
8. Use the following spectrum analyzer settings:
  - (1) Span shall wide enough to fully capture the emission being measured;
  - (2) Set RBW=100 kHz for  $f < 1$  GHz; VBW  $\geq$  RBW; Sweep = auto; Detector function = peak; Trace = max hold;
  - (3) Set RBW = 1 MHz, VBW= 3MHz for  $f \geq 1$  GHz for peak measurement.  
For average measurement:
    - VBW = 10 Hz, when duty cycle is no less than 98 percent.
    - VBW  $\geq 1/T$ , when duty cycle is less than 98 percent where T is the minimum transmission duration over which the transmitter is on and is transmitting at its maximum power control level for the tested mode of operation.

### 3.2.4 Test Setup

For radiated emissions below 30MHz

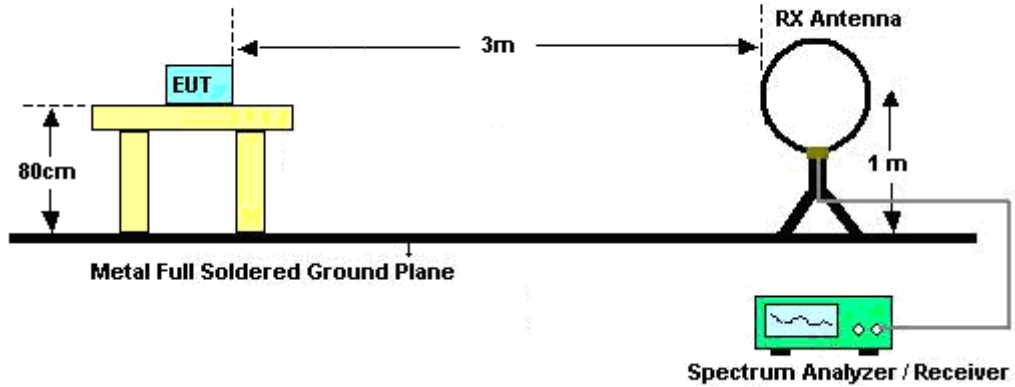

For radiated emissions from 30MHz to 1GHz

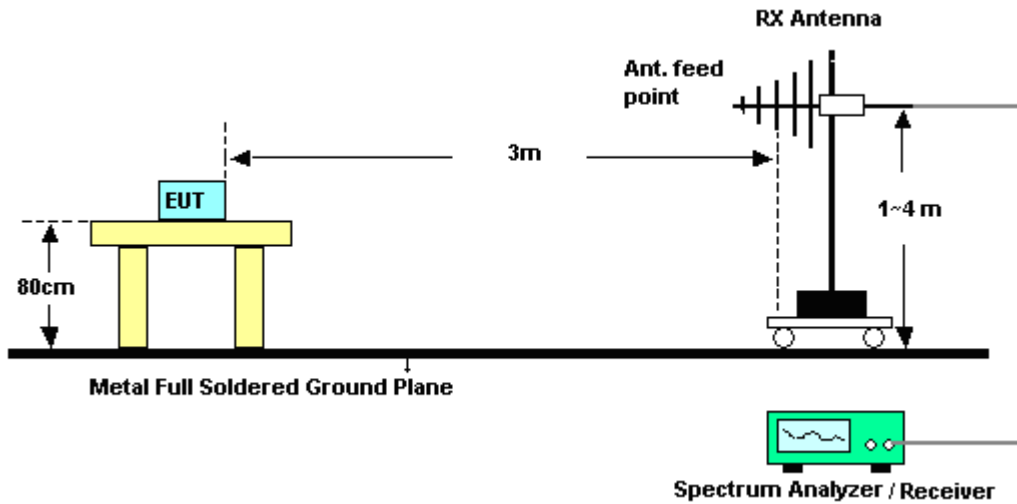

For radiated emissions above 1GHz

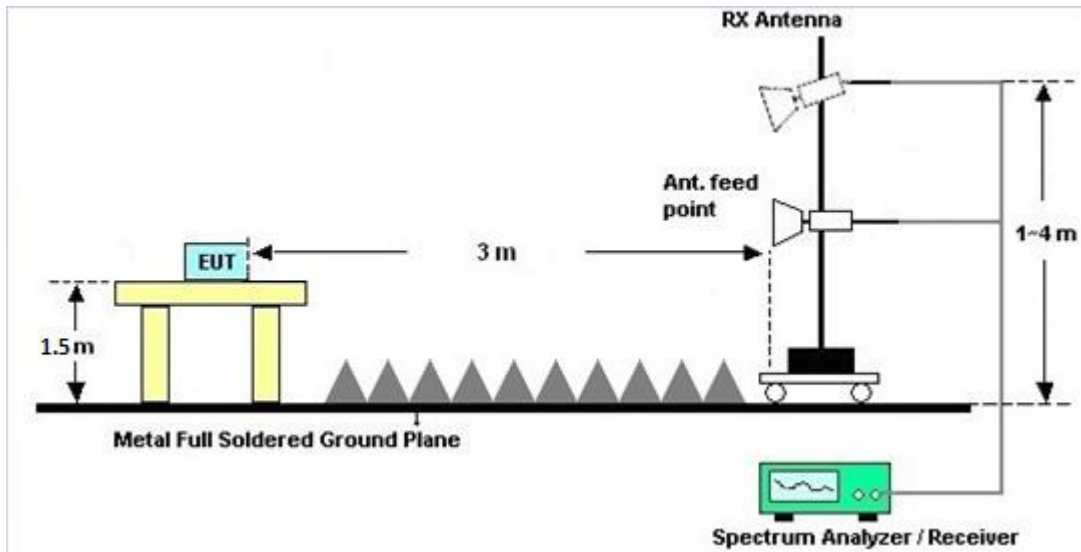

### 3.2.5 Test Results of Radiated Spurious Emissions (9kHz ~ 30MHz)

The low frequency, which started from 9 kHz to 30MHz, was pre-scanned and the result which was 20dB lower than the limit line per 15.31(o) was not reported.

### 3.2.6 Test Result of Radiated Spurious at Band Edges

Please refer to Appendix B and C.

### 3.2.7 Duty Cycle

Please refer to Appendix D.

### 3.2.8 Test Result of Radiated Spurious Emission (30MHz ~ 10<sup>th</sup> Harmonic)

Please refer to Appendix B and C.





### **3.3 Antenna Requirements**

#### **3.3.1 Standard Applicable**

If directional gain of transmitting antennas is greater than 6dBi, the power shall be reduced by the same level in dB comparing to gain minus 6dBi. For the fixed point-to-point operation, the power shall be reduced by one dB for every 3 dB that the directional gain of the antenna exceeds 6 dBi. The use of a permanently attached antenna or of an antenna that uses a unique coupling to the intentional radiator shall be considered sufficient to comply with the rule.

#### **3.3.2 Antenna Anti-Replacement Construction**

An embedded-in antenna design is used.

#### **3.3.3 Antenna Gain**

The antenna peak gain of EUT is less than 6 dBi. Therefore, it is not necessary to reduce maximum peak output power limit.



## 4 List of Measuring Equipment

Instrument	Manufacturer	Model No.	Serial No.	Characteristics	Calibration Date	Test Date	Due Date	Remark
Power Meter	Agilent	E4416A	GB412923 44	300MHz~40GHz	Dec. 26, 2016	May 04, 2017	Dec. 25, 2017	Conducted (TH05-HY)
Power Sensor	Agilent	E9327A	US404415 48	300MHz~40GHz	Dec. 26, 2016	May 04, 2017	Dec. 25, 2017	Conducted (TH05-HY)
Amplifier	SONOMA	310N	187312	9kHz~1GHz	Nov. 10, 2016	May 05, 2017~ May 07, 2017	Nov. 09, 2017	Radiation (03CH11-HY)
Loop Antenna	Rohde & Schwarz	HFH2-Z2	100315	9 kHz~30 MHz	Sep. 02, 2015	May 05, 2017~ May 07, 2017	Sep. 01, 2017	Radiation (03CH11-HY)
Bilog Antenna	TESEQ	CBL 6111D	35414	30MHz~1GHz	Oct. 15, 2016	May 05, 2017~ May 07, 2017	Oct. 14, 2017	Radiation (03CH11-HY)
Horn Antenna	SCHWARZBE CK	BBHA 9120 D	9120D-132 6	1GHz ~ 18GHz	Oct. 07, 2016	May 05, 2017~ May 07, 2017	Oct. 06, 2017	Radiation (03CH11-HY)
Preamplifier	Keysight	83017A	MY532700 80	1GHz~26.5GHz	Nov. 10, 2016	May 05, 2017~ May 07, 2017	Nov. 09, 2017	Radiation (03CH11-HY)
Spectrum Analyzer	Keysight	N9010A	MY542004 86	10Hz ~ 44GHz	Oct. 12, 2016	May 05, 2017~ May 07, 2017	Oct. 11, 2017	Radiation (03CH11-HY)
Antenna Mast	EMEC	AM-BS-4500- B	N/A	1~4m	N/A	May 05, 2017~ May 07, 2017	N/A	Radiation (03CH11-HY)
Turn Table	EMEC	TT 2000	N/A	0~360 Degree	N/A	May 05, 2017~ May 07, 2017	N/A	Radiation (03CH11-HY)
Preamplifier	MITEQ	AMF-7D-0010 1800-30-10P	1815698	1GHz~18GHz	Dec. 01, 2016	May 05, 2017~ May 07, 2017	Nov. 30, 2017	Radiation (03CH11-HY)
SHF-EHF Horn Antenna	SCHWARZBE CK	BBHA 9170	BBHA9170 584	18GHz- 40GHz	Nov. 08, 2016	May 05, 2017~ May 07, 2017	Nov. 07, 2017	Radiation (03CH11-HY)



## 5 Uncertainty of Evaluation

### Uncertainty of Radiated Emission Measurement (30 MHz ~ 1000 MHz)

Measuring Uncertainty for a Level of Confidence of 95% ( $U = 2Uc(y)$ )	5.2
---	-----

### Uncertainty of Radiated Emission Measurement (1000 MHz ~ 18000 MHz)

Measuring Uncertainty for a Level of Confidence of 95% ( $U = 2Uc(y)$ )	5.5
---	-----

### Uncertainty of Radiated Emission Measurement (18000 MHz ~ 40000 MHz)

Measuring Uncertainty for a Level of Confidence of 95% ( $U = 2Uc(y)$ )	5.2
---	-----

## Appendix A. Test Result of Conducted Test Items

Test Engineer:	Shiming Liu	Temperature:	21~25	°C
Test Date:	2017/5/4	Relative Humidity:	51~54	%

**TEST RESULTS DATA**  
**Peak Output Power**

2.4GHz Band																
Mod.	Data Rate	NTX	CH.	Freq. (MHz)	Peak Conducted Power (dBm)			Conducted Power Limit (dBm)		DG (dBi)		EIRP Power (dBm)		EIRP Power Limit (dBm)		Pass /Fail
					Ant 1	Ant 2	SUM	Ant 1	Ant 2	Ant 1	Ant 2	Ant 1	Ant 2	Ant 1	Ant 2	
11b	1Mbps	1	1	2412	18.51	18.35		30.00	30.00	-2.00	-0.30	16.51	18.05	36.00	36.00	Pass
11b	1Mbps	1	6	2437	18.50	18.25		30.00	30.00	-2.00	-0.30	16.50	17.95	36.00	36.00	Pass
11b	1Mbps	1	11	2462	18.45	18.32		30.00	30.00	-2.00	-0.30	16.45	18.02	36.00	36.00	Pass
11g	6Mbps	1	1	2412	23.27	21.78		30.00	30.00	-2.00	-0.30	21.27	21.48	36.00	36.00	Pass
11g	6Mbps	1	6	2437	23.51	22.16		30.00	30.00	-2.00	-0.30	21.51	21.86	36.00	36.00	Pass
11g	6Mbps	1	11	2462	22.90	22.04		30.00	30.00	-2.00	-0.30	20.90	21.74	36.00	36.00	Pass
HT20	MCS0	1	1	2412	22.90	21.46		30.00	30.00	-2.00	-0.30	20.90	21.16	36.00	36.00	Pass
HT20	MCS0	1	6	2437	23.35	22.10		30.00	30.00	-2.00	-0.30	21.35	21.80	36.00	36.00	Pass
HT20	MCS0	1	11	2462	22.00	21.34		30.00	30.00	-2.00	-0.30	20.00	21.04	36.00	36.00	Pass
VHT20	MCS0	1	1	2412	22.87	21.37		30.00	30.00	-2.00	-0.30	20.87	21.07	36.00	36.00	Pass
VHT20	MCS0	1	6	2437	23.35	22.11		30.00	30.00	-2.00	-0.30	21.35	21.81	36.00	36.00	Pass
VHT20	MCS0	1	11	2462	21.80	21.10		30.00	30.00	-2.00	-0.30	19.80	20.80	36.00	36.00	Pass
11b	1Mbps	2	1	2412	18.62	18.23	21.44	30.00		-0.30		21.14		36.00		Pass
11b	1Mbps	2	6	2437	18.50	18.11	21.32	30.00		-0.30		21.02		36.00		Pass
11b	1Mbps	2	11	2462	18.42	18.31	21.38	30.00		-0.30		21.08		36.00		Pass
11g	6Mbps	2	1	2412	23.00	21.52	25.33	30.00		-0.30		25.03		36.00		Pass
11g	6Mbps	2	6	2437	23.26	21.87	25.63	30.00		-0.30		25.33		36.00		Pass
11g	6Mbps	2	11	2462	22.55	21.83	25.22	30.00		-0.30		24.92		36.00		Pass
HT20	MCS0	2	1	2412	22.65	21.16	24.98	30.00		-0.30		24.68		36.00		Pass
HT20	MCS0	2	6	2437	23.13	21.79	25.52	30.00		-0.30		25.22		36.00		Pass
HT20	MCS0	2	11	2462	21.80	20.99	24.42	30.00		-0.30		24.12		36.00		Pass
VHT20	MCS0	2	1	2412	22.61	21.15	24.95	30.00		-0.30		24.65		36.00		Pass
VHT20	MCS0	2	6	2437	23.10	21.80	25.51	30.00		-0.30		25.21		36.00		Pass
VHT20	MCS0	2	11	2462	21.56	20.90	24.25	30.00		-0.30		23.95		36.00		Pass

Note: Measured power (dBm) has offset with cable loss.

**TEST RESULTS DATA**  
**Average Output Power**

2.4GHz Band									
Mod.	Data Rate	NTX	CH.	Freq. (MHz)	Duty Factor (dB)		Average Conducted Power (dBm)		
					Ant 1	Ant 2	Ant 1	Ant 2	SUM
11b	1Mbps	1	1	2412	0.00	0.00	15.50	15.50	
11b	1Mbps	1	6	2437	0.00	0.00	15.65	15.26	
11b	1Mbps	1	11	2462	0.00	0.00	15.55	15.57	
11g	6Mbps	1	1	2412	0.20	0.20	14.92	14.70	
11g	6Mbps	1	6	2437	0.20	0.20	15.65	15.10	
11g	6Mbps	1	11	2462	0.20	0.20	14.90	14.80	
HT20	MCS0	1	1	2412	0.21	0.18	14.36	13.93	
HT20	MCS0	1	6	2437	0.21	0.18	15.56	15.03	
HT20	MCS0	1	11	2462	0.21	0.18	13.40	13.38	
VHT20	MCS0	1	1	2412	0.18	0.18	14.33	13.96	
VHT20	MCS0	1	6	2437	0.18	0.18	15.63	15.06	
VHT20	MCS0	1	11	2462	0.18	0.18	12.83	12.90	
11b	1Mbps	2	1	2412	0.00	0.00	15.65	15.51	18.59
11b	1Mbps	2	6	2437	0.00	0.00	15.66	15.30	18.49
11b	1Mbps	2	11	2462	0.00	0.00	15.56	15.58	18.58
11g	6Mbps	2	1	2412	0.17	0.16	14.94	14.71	17.83
11g	6Mbps	2	6	2437	0.17	0.16	15.67	15.11	18.41
11g	6Mbps	2	11	2462	0.17	0.16	14.92	14.81	17.87
HT20	MCS0	2	1	2412	0.18	0.18	14.38	13.95	17.18
HT20	MCS0	2	6	2437	0.18	0.18	15.58	15.04	18.33
HT20	MCS0	2	11	2462	0.18	0.18	13.41	13.40	16.42
VHT20	MCS0	2	1	2412	0.18	0.18	14.34	13.97	17.17
VHT20	MCS0	2	6	2437	0.18	0.18	15.64	15.08	18.38
VHT20	MCS0	2	11	2462	0.18	0.18	12.85	12.91	15.89

Note: Measured power (dBm) has offset with cable loss.



## Appendix B. Radiated Spurious Emission

Test Engineer :	JC Liao, Jacky Hung, and Ken Wu	Temperature :	20~24°C
		Relative Humidity :	50~54%

### 2.4GHz 2400~2483.5MHz

#### WIFI 802.11b (Band Edge @ 3m)

WIFI Ant. 1+2	Note	Frequency ( MHz )	Level ( dBμV/m )	Over Limit ( dB )	Limit Line ( dBμV/m )	Read Level ( dBμV )	Antenna Factor ( dB/m )	Cable Loss ( dB )	Preamp Factor ( dB )	Ant Pos ( cm )	Table Pos ( deg )	Peak Avg. ( P/A )	Pol. ( H/V )	
802.11b CH 01 2412MHz		2367.75	51.51	-22.49	74	42.15	26.76	6.27	33.6	397	52	P	H	
		2388.96	41.03	-12.97	54	31.51	26.87	6.32	33.6	397	52	A	H	
	*	2412	106.64	-	-	97.01	26.92	6.37	33.59	397	52	P	H	
	*	2412	103.17	-	-	93.54	26.92	6.37	33.59	397	52	A	H	
													H	
														H
			2389.695	51.23	-22.77	74	41.71	26.87	6.32	33.6	115	232	P	V
			2389.905	41.06	-12.94	54	31.53	26.87	6.32	33.59	115	232	A	V
	*		2412	108.52	-	-	98.89	26.92	6.37	33.59	115	232	P	V
	*		2412	105.19	-	-	95.56	26.92	6.37	33.59	115	232	A	V
														V
														V

Remark	1. No other spurious found.
	2. All results are PASS against Peak and Average limit line.



2.4GHz 2400~2483.5MHz

WIFI 802.11b (Harmonic @ 3m)

WIFI Ant. 1+2	Note	Frequency ( MHz )	Level ( dBμV/m )	Over Limit ( dB )	Limit Line ( dBμV/m )	Read Level ( dBμV )	Antenna Factor ( dB/m )	Cable Loss ( dB )	Preamp Factor ( dB )	Ant Pos ( cm )	Table Pos ( deg )	Peak Avg. ( P/A )	Pol. ( H/V )	
802.11b CH 01 2412MHz		4824	56.25	-17.75	74	79.04	31.62	9.9	64.74	213	8	P	H	
		4824	53.18	-0.82	54	75.97	31.62	9.9	64.74	213	8	A	H	
													H	
													H	
			4824	54.96	-19.04	74	77.75	31.62	9.9	64.74	127	154	P	V
			4824	51.87	-2.13	54	74.66	31.62	9.9	64.74	127	154	A	V
														V
														V
Remark	1. No other spurious found. 2. All results are PASS against Peak and Average limit line.													





**2.4GHz 2400~2483.5MHz  
WIFI 802.11n HT20 (Band Edge @ 3m)**

WIFI Ant. 1+2	Note	Frequency ( MHz )	Level ( dBμV/m )	Over Limit ( dB )	Limit Line ( dBμV/m )	Read Level ( dBμV )	Antenna Factor ( dB/m )	Cable Loss ( dB )	Preamp Factor ( dB )	Ant Pos ( cm )	Table Pos ( deg )	Peak Avg. ( P/A )	Pol. ( H/V )
802.11n HT20 CH 11 2462MHz	*	2462	104.52	-	-	94.7	27.09	6.38	33.58	375	54	P	H
	*	2462	95.65	-	-	85.83	27.09	6.38	33.58	375	54	A	H
		2484.68	62.31	-11.69	74	52.43	27.14	6.39	33.58	375	54	P	H
		2484.16	49.43	-4.57	54	39.55	27.14	6.39	33.58	375	54	A	H
													H
													H
	*	2462	108.32	-	-	98.5	27.09	6.38	33.58	119	142	P	V
	*	2462	99.73	-	-	89.91	27.09	6.38	33.58	119	142	A	V
		2483.6	64.8	-9.2	74	54.92	27.14	6.39	33.58	119	142	P	V
		2483.52	52.14	-1.86	54	42.26	27.14	6.39	33.58	119	142	A	V
												V	
												V	
<b>Remark</b>	1. No other spurious found. 2. All results are PASS against Peak and Average limit line.												



**2.4GHz 2400~2483.5MHz**  
**WIFI 802.11n HT20 (Harmonic @ 3m)**

WIFI Ant. 1+2	Note	Frequency ( MHz )	Level ( dBμV/m )	Over Limit ( dB )	Limit Line ( dBμV/m )	Read Level ( dBμV )	Antenna Factor ( dB/m )	Cable Loss ( dB )	Preamp Factor ( dB )	Ant Pos ( cm )	Table Pos ( deg )	Peak Avg. ( P/A )	Pol. ( H/V )	
802.11n HT20 CH 11 2462MHz		4924	50.9	-23.1	74	73.5	31.79	9.83	64.66	100	0	P	H	
		7386	47.1	-26.9	74	62.12	37.82	11.64	64.86	100	0	P	H	
													H	
													H	
			4924	47.29	-26.71	74	69.89	31.79	9.83	64.66	100	0	P	V
			7386	46.02	-27.98	74	61.04	37.82	11.64	64.86	100	0	P	V
														V
														V
<b>Remark</b>	1. No other spurious found. 2. All results are PASS against Peak and Average limit line.													



Emission below 1GHz  
2.4GHz WIFI 802.11b (LF)

WIFI	Note	Frequency	Level	Over	Limit	Read	Antenna	Cable	Preamp	Ant	Table	Peak	Pol.	
Ant.				Limit	Line	Level	Factor	Loss	Factor	Pos	Pos	Avg.		
1+2		( MHz )	( dBμV/m )	( dB )	( dBμV/m )	( dBμV )	( dB/m )	( dB )	( dB )	( cm )	( deg )	( P/A )	( H/V )	
2.4GHz 802.11b LF		67.8	26.48	-13.52	40	45.77	12.12	1.06	32.49	100	0	P	H	
		200.37	28.42	-15.08	43.5	44.08	14.95	1.72	32.39			P	H	
		265.44	27.1	-18.9	46	37.87	19.49	2.04	32.38			P	H	
		362.3	26.68	-19.32	46	35.9	20.69	2.39	32.35			P	H	
		456.8	29.56	-16.44	46	35.8	23.33	2.75	32.36			P	H	
		960.1	34.17	-19.83	54	30.01	31.22	3.87	31.11			P	H	
														H
														H
														H
														H
														H
														H
			34.59	25.65	-14.35	40	35.68	21.78	0.68	32.49			P	V
			102.09	28.73	-14.77	43.5	43.66	16.26	1.27	32.48			P	V
			189.57	22.71	-20.79	43.5	38.57	14.74	1.72	32.4			P	V
			456.8	28.32	-17.68	46	34.56	23.33	2.75	32.36			P	V
			776	30.62	-15.38	46	30.9	28.32	3.5	32.25			P	V
			945.4	33.52	-12.48	46	30.17	30.61	3.82	31.25	100	0	P	V
														V
														V
													V	
													V	
													V	
													V	
<b>Remark</b>	1. No other spurious found. 2. All results are PASS against limit line.													



**Note symbol**

*	<b>Fundamental Frequency</b> which can be ignored. However, the level of any unwanted emissions shall not exceed the level of the fundamental frequency.
!	Test result is <b>over limit</b> line.
P/A	<b>Peak</b> or <b>Average</b>
H/V	<b>Horizontal</b> or <b>Vertical</b>



A calculation example for radiated spurious emission is shown as below:

WIFI	Note	Frequency	Level	Over	Limit	Read	Antenna	Cable	Preamp	Ant	Table	Peak	Pol.
Ant.				Limit	Line	Level	Factor	Loss	Factor	Pos	Pos	Avg.	
1+2		( MHz )	( dBμV/m )	( dB )	( dBμV/m )	( dBμV )	( dB/m )	( dB )	( dB )	( cm )	( deg )	( P/A )	( H/V )
802.11b		2390	55.45	-18.55	74	54.51	32.22	4.58	35.86	103	308	P	H
CH 01													
2412MHz		2390	43.54	-10.46	54	42.6	32.22	4.58	35.86	103	308	A	H

- Level(dBμV/m) =  
Antenna Factor(dB/m) + Cable Loss(dB) + Read Level(dBμV) - Preamp Factor(dB)
- Over Limit(dB) = Level(dBμV/m) – Limit Line(dBμV/m)

**For Peak Limit @ 2390MHz:**

- Level(dBμV/m)  
= Antenna Factor(dB/m) + Cable Loss(dB) + Read Level(dBμV) - Preamp Factor(dB)  
= 32.22(dB/m) + 4.58(dB) + 54.51(dBμV) – 35.86 (dB)  
= 55.45 (dBμV/m)
- Over Limit(dB)  
= Level(dBμV/m) – Limit Line(dBμV/m)  
= 55.45(dBμV/m) – 74(dBμV/m)  
= -18.55(dB)

**For Average Limit @ 2390MHz:**

- Level(dBμV/m)  
= Antenna Factor(dB/m) + Cable Loss(dB) + Read Level(dBμV) - Preamp Factor(dB)  
= 32.22(dB/m) + 4.58(dB) + 42.6(dBμV) – 35.86 (dB)  
= 43.54 (dBμV/m)
- Over Limit(dB)  
= Level(dBμV/m) – Limit Line(dBμV/m)  
= 43.54(dBμV/m) – 54(dBμV/m)  
= -10.46(dB)

Both peak and average measured complies with the limit line, so test result is “PASS”.



## **Appendix B. Radiated Spurious Emission Plots**

<b>Test Engineer :</b>	J.C. Liang, Jacky Hung, and Kan Wu	<b>Temperature :</b>	18~22°C
		<b>Relative Humidity :</b>	55~58%

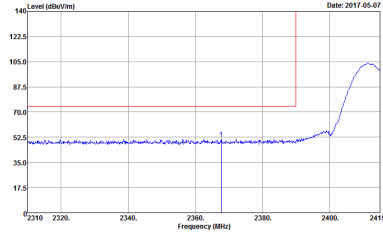
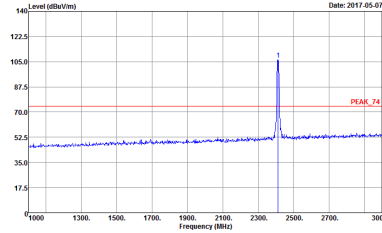
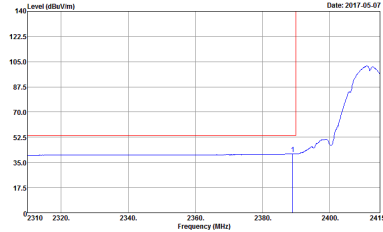
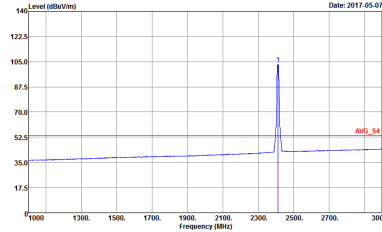

2.4GHz 2400~2483.5MHz  
 WIFI 802.11b (Band Edge @ 3m)

WIFI	2.4GHz 2400~2483.5MHz Band Edge @ 3m	
ANT	802.11b CH01 2412MHz	
1+2	Horizontal	Fundamental
Peak	 <p>Site : 03CH11-HY            Condition : PEAK_BE_74 3m HORN 91200-HF HORIZONTAL            Detector : Peak            Project : 733129-06            Setting : 16</p>	 <p>Site : 03CH11-HY            Condition : PEAK_74 3m HORN 91200-HF HORIZONTAL            Detector : Peak            Project : 733129-06            Setting : 16</p>
Avg.	 <p>Site : 03CH11-HY            Condition : AVG_BE_54 3m HORN 91200-HF HORIZONTAL            Detector : Peak            Project : 733129-06            Setting : 16</p>	 <p>Site : 03CH11-HY            Condition : AVG_54 3m HORN 91200-HF HORIZONTAL            Detector : Peak            Project : 733129-06            Setting : 16</p>

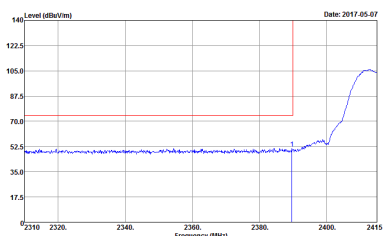
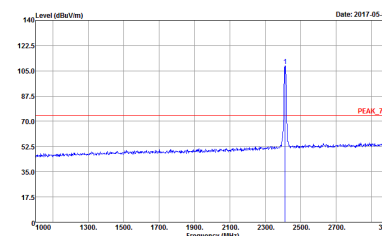
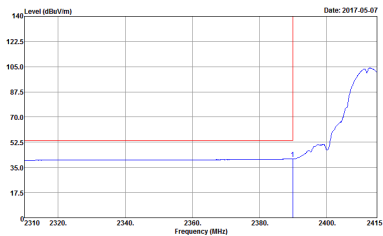
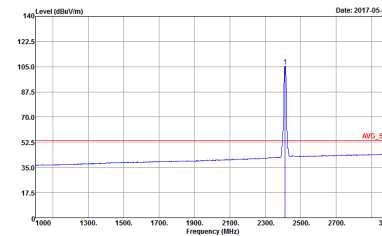

WIFI	2.4GHz 2400~2483.5MHz Band Edge @ 3m	
ANT	802.11b CH01 2412MHz	
1+2	Vertical	Fundamental
Peak	 <p>Site : 03CH11-HY            Condition : PEAK_BE_74 3m HORN 91200-HF VERTICAL            Detector : Peak            Project : 733129-06            Setting : 16</p>	 <p>Site : 03CH11-HY            Condition : PEAK_74 3m HORN 91200-HF VERTICAL            Detector : Peak            Project : 733129-06            Setting : 16</p>
Avg.	 <p>Site : 03CH11-HY            Condition : AVG_BE_54 3m HORN 91200-HF VERTICAL            Detector : Peak            Project : 733129-06            Setting : 16</p>	 <p>Site : 03CH11-HY            Condition : AVG_54 3m HORN 91200-HF VERTICAL            Detector : Peak            Project : 733129-06            Setting : 16</p>





2.4GHz 2400~2483.5MHz  
 WIFI 802.11n HT20 (Band Edge @ 3m)

WIFI	2.4GHz 2400~2483.5MHz Band Edge @ 3m	
ANT	802.11n HT20 CH11 2462MHz	
1+2	Horizontal	Fundamental
Peak	<p>Site : 03CH11-HY            Condition : PEAK_BE_74 3m HORN 9120D-HF HORIZONTAL            Detector : Peak            Project : 733129-06            Setting : 14</p>	<p>Site : 03CH11-HY            Condition : PEAK_74 3m HORN 9120D-HF HORIZONTAL            Detector : Peak            Project : 733129-06            Setting : 14</p>
Avg.	<p>Site : 03CH11-HY            Condition : AVG_BE_54 3m HORN 9120D-HF HORIZONTAL            Detector : Peak            Project : 733129-06            Setting : 14</p>	<p>Site : 03CH11-HY            Condition : AVG_54 3m HORN 9120D-HF HORIZONTAL            Detector : Peak            Project : 733129-06            Setting : 14</p>



WIFI	2.4GHz 2400~2483.5MHz Fundamental @ 3m	
ANT	802.11n HT20 CH11 2462MHz	
1+2	Vertical	Fundamental
<b>Peak</b>	<p>Site : 03CH11-HY            Condition : PEAK_BE_74 3m HORN 91200-HF VERTICAL            Detector : Peak            Project : 733129-06            Setting : 14</p>	<p>Site : 03CH11-HY            Condition : PEAK_74 3m HORN 91200-HF VERTICAL            Detector : Peak            Project : 733129-06            Setting : 14</p>
<b>Avg.</b>	<p>Site : 03CH11-HY            Condition : AVG_BE_54 3m HORN 91200-HF VERTICAL            Detector : Peak            Project : 733129-06            Setting : 14</p>	<p>Site : 03CH11-HY            Condition : AVG_54 3m HORN 91200-HF VERTICAL            Detector : Peak            Project : 733129-06            Setting : 14</p>



2.4GHz 2400~2483.5MHz  
WIFI 802.11b (Harmonic @ 3m)

WIFI	2.4GHz 2400~2483.5MHz Harmonic @ 3m	
ANT	802.11b CH01 2412MHz	
1+2	Horizontal	Vertical
<b>Peak</b> <b>Avg.</b>	<p>Site : 03CH11-4FY Condition : PEAK_74 3m 9170 5HF HORM_150809 HORIZONTAL Detector : Peak Project : 733129-06 Setting : 16</p>	<p>Site : 03CH11-4FY Condition : PEAK_74 3m 9170 5HF HORM_150809 VERTICAL Detector : Peak Project : 733129-06 Setting : 16</p>



2.4GHz 2400~2483.5MHz
WIFI 802.11n HT20 (Harmonic @ 3m)

Table with 2 columns: Horizontal and Vertical. Each column contains a graph of Level (dBuV/m) vs Frequency (MHz) and associated site/condition data. The graphs show two peaks labeled 1 and 2, with a peak level of 74 dBuV/m and an average level of 54 dBuV/m.



Emission below 1GHz  
2.4GHz WIFI 802.11b (LF)

WIFI	2.4GHz 2400~2483.5MHz	
ANT	802.11b LF	
1+2	Horizontal	Vertical
QP / Peak	<p>Site : 03CH11-FF Condition : QP 3m BT-LOG 6111D-LF_ETC HORIZONTAL Detector : Peak Project : 733129-06</p>	<p>Site : 03CH11-FF Condition : QP 3m BT-LOG 6111D-LF_ETC VERTICAL Detector : Peak Project : 733129-06</p>



## Appendix D. Duty Cycle Plots

Antenna	Band	Duty Cycle(%)	T(us)	1/T(kHz)	VBW Setting
1+2	2.4GHz 802.11b for Ant 1	100	-	-	10Hz
1+2	2.4GHz 802.11b for Ant 2	100	-	-	10Hz
1+2	2.4GHz 802.11n HT20 for Ant 1	95.89	2800	0.357	1kHz
1+2	2.4GHz 802.11n HT20 for Ant 2	95.89	2800	0.357	1kHz



<MIMO Ant. 1>

2.4GHz 802.11b

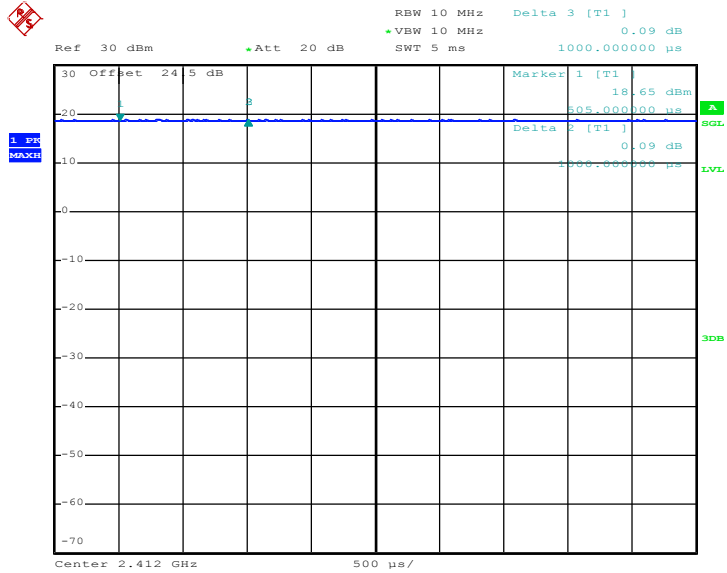

Date: 4.MAY.2017 22:05:56

2.4GHz 802.11n HT20

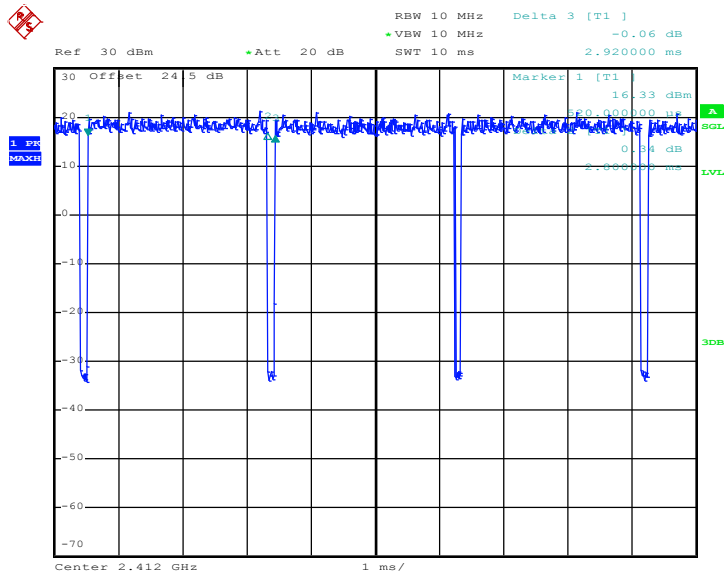

Date: 4.MAY.2017 22:47:52



<MIMO Ant. 2>

2.4GHz 802.11b

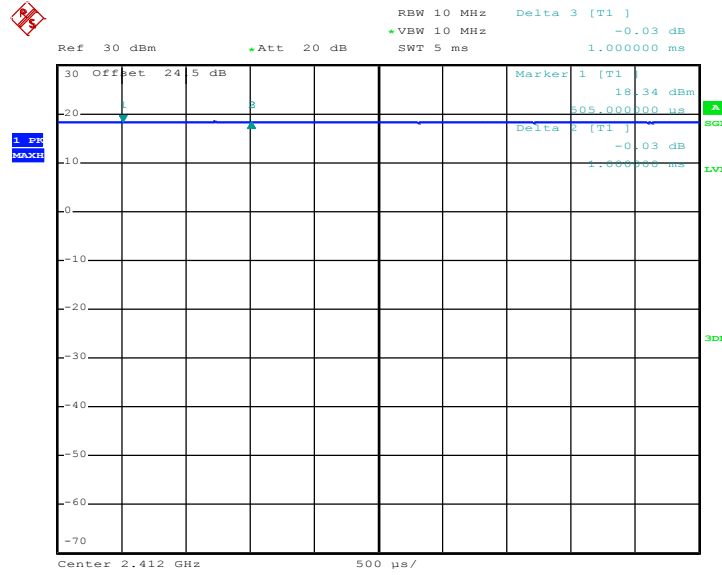

Date: 4.MAY.2017 22:07:33

2.4GHz 802.11n HT20

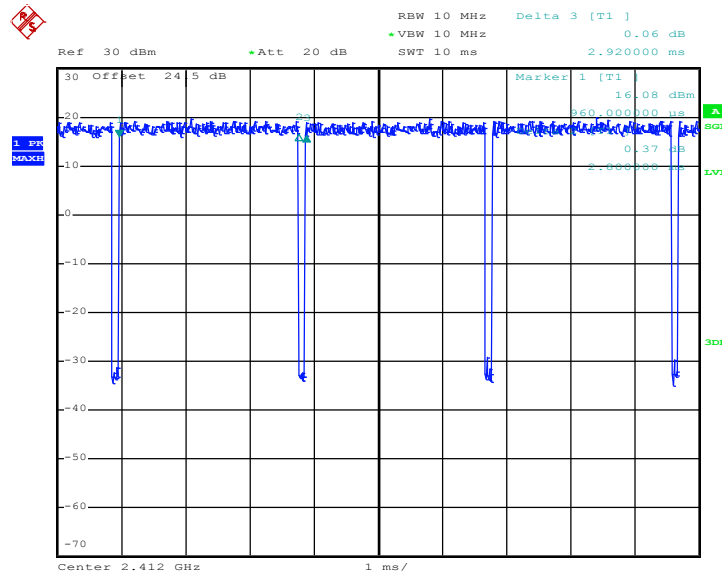

Date: 4.MAY.2017 22:49:30





## **Appendix E. Original Report**

Please refer to Sporton report number FR733129C.