



FCC RF Test Report

APPLICANT : Motorola Mobility, LLC
EQUIPMENT : Mobile Cellular Phone
BRAND NAME : Motorola
MODEL NAME : 10722
FCC ID : IHDT56WB4
STANDARD : FCC Part 15 Subpart E §15.407
CLASSIFICATION : (NII) Unlicensed National Information Infrastructure

The product was received on Feb. 03, 2017 and testing was completed on Apr. 27, 2017. We, SPORTON INTERNATIONAL INC., would like to declare that the tested sample has been evaluated in accordance with the test procedures and has been in compliance with the applicable technical standards.

The test results in this report apply exclusively to the tested model / sample. Without written approval of SPORTON INTERNATIONAL INC., the test report shall not be reproduced except in full.

Reviewed by: Joseph Lin / Supervisor

Approved by: Jones Tsai / Manager



SPORTON INTERNATIONAL INC.

No. 52, Hwa Ya 1st Rd., Hwa Ya Technology Park, Kwei-Shan District, Tao Yuan City, Taiwan, R.O.C.

SPORTON INTERNATIONAL INC.

TEL : 886-3-327-3456

FAX : 886-3-328-4978

FCC ID : IHDT56WB4

Page Number : 1 of 35

Report Issued Date : May 04, 2017

Report Version : Rev. 01

Report Template No.: BU5-FR15EWLB4 AC MA Version 1.5



TABLE OF CONTENTS

REVISION HISTORY 3

SUMMARY OF TEST RESULT 4

1 GENERAL DESCRIPTION 5

 1.1 Applicant 5

 1.2 Manufacturer 5

 1.3 Product Feature of Equipment Under Test 5

 1.4 Product Specification of Equipment Under Test 7

 1.5 Modification of EUT 8

 1.6 Testing Location 8

 1.7 Applicable Standards 9

2 TEST CONFIGURATION OF EQUIPMENT UNDER TEST 10

 2.1 Carrier Frequency and Channel 10

 2.2 Test Mode 11

 2.3 Connection Diagram of Test System 12

 2.4 Support Unit used in test configuration and system 13

 2.5 EUT Operation Test Setup 13

 2.6 Measurement Results Explanation Example 13

3 TEST RESULT 14

 3.1 6dB and 26dB and 99% Occupied Bandwidth Measurement 14

 3.2 Maximum Conducted Output Power Measurement 17

 3.3 Power Spectral Density Measurement 18

 3.4 Unwanted Emissions Measurement 21

 3.5 AC Conducted Emission Measurement 27

 3.6 Frequency Stability Measurement 31

 3.7 Automatically Discontinue Transmission 32

 3.8 Antenna Requirements 33

4 LIST OF MEASURING EQUIPMENT 34

5 UNCERTAINTY OF EVALUATION 35

APPENDIX A. CONDUCTED TEST RESULTS

APPENDIX B. RADIATED SPURIOUS EMISSION

APPENDIX C. RADIATED SPURIOUS EMISSION PLOTS

APPENDIX D. DUTY CYCLE PLOTS



SUMMARY OF TEST RESULT

Report Section	FCC Rule	Description	Limit	Result	Remark
3.1	15.403(i)	6dB, 26dB and 99% Occupied Bandwidth	> 500kHz	Pass	-
3.2	15.407(a)	Maximum Conducted Output Power	≤ 30 dBm	Pass	-
3.3	15.407(a)	Power Spectral Density	≤ 30 dBm/500kHz	Pass	-
3.4	15.407(b)	Unwanted Emissions	15.407(b)(4)(i) & 15.209(a)	Pass	Under limit 6.17 dB at 43.500 MHz
3.5	15.207	AC Conducted Emission	15.207(a)	Pass	Under limit 14.00 dB at 0.398 MHz
0	15.407(g)	Frequency Stability	Within Operation Band	Pass	-
3.7	15.407(c)	Automatically Discontinue Transmission	Discontinue Transmission	Pass	-
3.8	15.203 & 15.407(a)	Antenna Requirement	N/A	Pass	-



1 General Description

1.1 Applicant

Motorola Mobility, LLC

222 W Merchandise Mart Plaza, Suite 1800, Chicago, IL 60654, United States

1.2 Manufacturer

Motorola Mobility, LLC

222 W Merchandise Mart Plaza, Suite 1800, Chicago, IL 60654, United States

1.3 Product Feature of Equipment Under Test

Product Feature	
Equipment	Mobile Cellular Phone
Brand Name	Motorola
Model Name	10722
FCC ID	IHDT56WB4
IMEI Code	353311080000163 (for Radiation) 353311080000643 (for Conduction)
EUT supports Radios application	GSM/EGPRS/WCDMA/HSPA/LTE/NFC WLAN 11b/g/n HT20 WLAN 11a/n HT20/HT40 WLAN 11ac VHT20/VHT40/VHT80 Bluetooth BR/EDR/LE
HW Version	DVT2
EUT Stage	Identical Prototype

Remark: The above EUT's information was declared by manufacturer. Please refer to the specifications or user's manual for more detailed description.



Accessory List		
AC Adapter 1	Brand Name :	Motorola
	Model Name :	SPN5970A
AC Adapter 2	Brand Name :	Motorola
	Model Name :	SPN5993A
AC Adapter 3	Brand Name :	Motorola
	Model Name :	SPN5978A
Battery 1	Brand Name :	Motorola
	Model Name :	SNN5986A
Battery 2	Brand Name :	Motorola
	Model Name :	SNN5897A
Earphone	Brand Name :	Motorola
	Model Name :	SH38C16618
USB Cable	Brand Name :	Motorola
	Model Name :	SKN6473A
USB-C Data Cable	Brand Name :	Motorola
	Model Name :	SKN6474A



1.4 Product Specification of Equipment Under Test

Standards-related Product Specification										
Tx/Rx Channel Frequency Range	5745 MHz ~ 5825 MHz									
Maximum Output Power	<p><Ant. 1> 802.11a : 18.11 dBm / 0.0647 W 802.11n HT20 : 18.13 dBm / 0.0650 W 802.11n HT40 : 17.48 dBm / 0.0560 W 802.11ac VHT20 : 18.14 dBm / 0.0652 W 802.11ac VHT40 : 17.49 dBm / 0.0561 W 802.11ac VHT80 : 18.18 dBm / 0.0658 W</p> <p><Ant. 2> 802.11a : 18.13 dBm / 0.0650 W 802.11n HT20 : 18.21 dBm / 0.0662 W 802.11n HT40 : 17.55 dBm / 0.0569 W 802.11ac VHT20 : 18.23 dBm / 0.0665 W 802.11ac VHT40 : 17.64 dBm / 0.0581 W 802.11ac VHT80 : 18.30 dBm / 0.0676 W</p> <p>MIMO <Ant. 1 + 2> 802.11a : 21.07 dBm / 0.1279 W 802.11n HT20 : 21.06 dBm / 0.1276 W 802.11n HT40 : 20.50 dBm / 0.1122 W 802.11ac VHT20 : 21.20 dBm / 0.1318 W 802.11ac VHT40 : 20.52 dBm / 0.1127 W 802.11ac VHT80 : 21.21 dBm / 0.1321 W</p>									
99% Occupied Bandwidth	<p>MIMO <Ant. 1> 802.11a : 18.05 MHz 802.11n HT20 : 19.50 MHz 802.11n HT40 : 37.40 MHz 802.11ac VHT20 : 19.40 MHz 802.11ac VHT40 : 37.10 MHz 802.11ac VHT80 : 76.20 MHz</p> <p>MIMO <Ant. 2> 802.11a : 17.85 MHz 802.11n HT20 : 19.05 MHz 802.11n HT40 : 37.30 MHz 802.11ac VHT20 : 19.00 MHz 802.11ac VHT40 : 37.30 MHz 802.11ac VHT80 : 76.20 MHz</p>									
Antenna Type / Gain	<p><Ant. 1> Fixed Internal Antenna type with gain -2.40 dBi</p> <p><Ant. 2> Fixed Internal Antenna type with gain -3.50 dBi</p>									
Type of Modulation	802.11a/n : OFDM (BPSK / QPSK / 16QAM / 64QAM) 802.11ac : OFDM (BPSK / QPSK / 16QAM / 64QAM / 256QAM)									
Antenna Function Description	<table border="1"> <thead> <tr> <th></th> <th>Ant. 1</th> <th>Ant. 2</th> </tr> </thead> <tbody> <tr> <td>802.11 a/n/ac</td> <td>V</td> <td>V</td> </tr> <tr> <td>802.11 a/n/ac MIMO</td> <td>V</td> <td>V</td> </tr> </tbody> </table>		Ant. 1	Ant. 2	802.11 a/n/ac	V	V	802.11 a/n/ac MIMO	V	V
	Ant. 1	Ant. 2								
802.11 a/n/ac	V	V								
802.11 a/n/ac MIMO	V	V								

Note: MIMO Ant. 1+2 is a calculated result from sum of the power MIMO Ant. 1 and MIMO Ant. 2.



1.5 Modification of EUT

No modifications are made to the EUT during all test items.

1.6 Testing Location

Sporton Lab is accredited to ISO 17025 by Taiwan Accreditation Foundation (TAF code : 1190) and the FCC designation No. TW0007 under the FCC 2.948(e) by Mutual Recognition Agreement (MRA) in FCC Test.

Test Site	SPORTON INTERNATIONAL INC.	
Test Site Location	No. 52, Hwa Ya 1 st Rd., Hwa Ya Technology Park, Kwei-Shan District, Tao Yuan City, Taiwan, R.O.C. TEL: +886-3-327-3456 FAX: +886-3-328-4978	
Test Site No.	Sporton Site No.	
	TH05-HY	CO05-HY

Note: The test site complies with ANSI C63.4 2014 requirement.

Test Site	SPORTON INTERNATIONAL INC.	
Test Site Location	No.58, Aly. 75, Ln. 564, Wenhua 3rd Rd. Guishan Dist, Taoyuan City, Taiwan (R.O.C.) TEL: +886-3-327-0868 FAX: +886-3-327-0855	
Test Site No.	Sporton Site No.	
	03CH11-HY	

Note: The test site complies with ANSI C63.4 2014 requirement.



1.7 Applicable Standards

According to the specifications of the manufacturer, the EUT must comply with the requirements of the following standards:

- ♦ FCC Part 15 Subpart E
- ♦ FCC KDB 789033 D02 General UNII Test Procedures New Rules v01r04
- ♦ FCC KDB 662911 D01 Multiple Transmitter Output v02r01.
- ♦ FCC KDB 644545 D03 Guidance for IEEE 802.11ac New Rules v01
- ♦ ANSI C63.10-2013

Remark:

1. All test items were verified and recorded according to the standards and without any deviation during the test.
2. This EUT has also been tested and complied with the requirements of FCC Part 15, Subpart B, recorded in a separate test report.



2 Test Configuration of Equipment Under Test

The EUT has been associated with peripherals and configuration operated in a manner tended to maximize its emission characteristics in a typical application. Frequency range investigated: conducted emission (150 kHz to 30 MHz) and radiated emission (9 kHz to the 10th harmonic of the highest fundamental frequency or to 40 GHz, whichever is lower). For radiated measurement, pre-scanned in three orthogonal panels, X, Y, Z. The worst cases (X plane) were recorded in this report.

2.1 Carrier Frequency and Channel

Frequency Band	Channel	Freq. (MHz)	Channel	Freq. (MHz)
5725-5850 MHz Band 4 (U-NII-3)	149	5745	157	5785
	151*	5755	159*	5795
	153	5765	161	5805
	155#	5775	165	5825

Note:

1. The above Frequency and Channel in "*" were 802.11n HT40 and 802.11ac VHT40.
2. The above Frequency and Channel in "#n" were 802.11ac VHT80.



2.2 Test Mode

Final test mode of conducted test items and radiated spurious emissions are considering the modulation and worse data rates as below table.

Single Antenna

Modulation	Data Rate
802.11a	6 Mbps
802.11n HT20	MCS0
802.11n HT40	MCS0
802.11ac VHT20	MCS0
802.11ac VHT40	MCS0
802.11ac VHT80	MCS0

MIMO Antenna

Modulation	Data Rate
802.11a	6 Mbps
802.11n HT20	MCS0
802.11n HT40	MCS0
802.11ac VHT20	MCS0
802.11ac VHT40	MCS0
802.11ac VHT80	MCS0

AC Conducted Emission	Mode 1 GSM850 Idle + Bluetooth Link + WLAN (5GHz) Link + MP3 + Battery 2 + USB Cable (Charging from Adapter 3)
------------------------------	--

Remark: All the radiated test cases were performance with Adapter 1 and Battery 2.

Ch. #		Band IV : 5725-5850 MHz		
		802.11a	802.11n HT20	802.11n HT40
L	Low	149	149	151
M	Middle	157	157	-
H	High	165	165	159

Ch. #		Band IV : 5725-5850 MHz		
		802.11ac VHT20	802.11ac VHT40	802.11ac VHT80
L	Low	149	151	-
M	Middle	157	-	155
H	High	165	159	-

2.3 Connection Diagram of Test System

<WLAN Tx Mode>

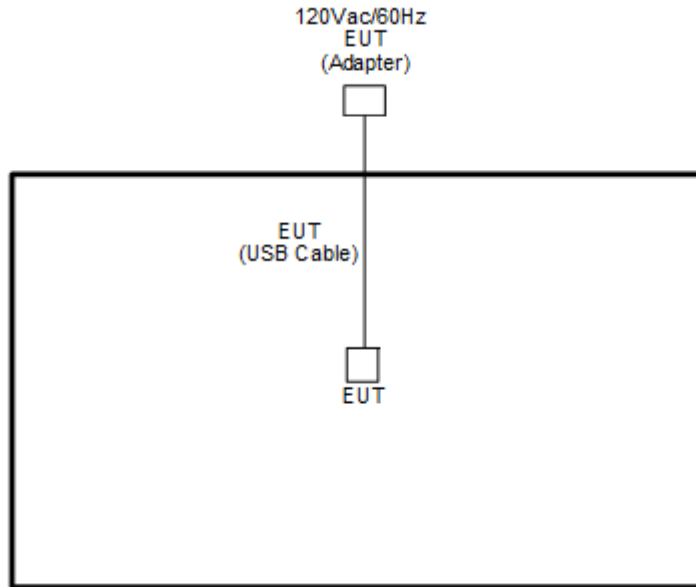

<AC Conducted Emission Mode>

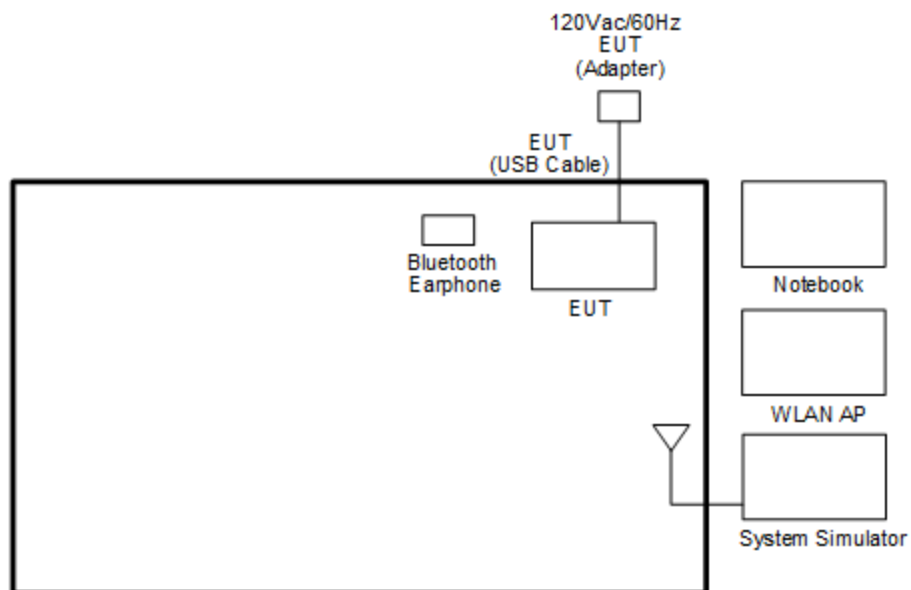



2.4 Support Unit used in test configuration and system

Item	Equipment	Trade Name	Model Name	FCC ID	Data Cable	Power Cord
1.	System Simulator	R&S	CMU 200	N/A	N/A	Unshielded, 1.8 m
2.	WLAN AP	ASUS	RT-AC66U	MSQ-RTAC66U	N/A	Unshielded, 1.8 m
3.	Bluetooth Earphone	Sony Ericsson	MW600	PY7DDA-2029	N/A	N/A
4.	Notebook	DELL	Latitude E6320	FCC DoC/ Contains FCC ID: QDS-BRCM1054	N/A	AC I/P: Unshielded, 1.2 m DC O/P: Shielded, 1.8 m
5.	SD Card	SanDisk	MicroSD HC	FCC DoC	N/A	N/A

2.5 EUT Operation Test Setup

The RF test items, programmed RF utility, “QRCT” installed in the notebook make the EUT provide functions like channel selection and power level for continuous transmitting and receiving signals.

2.6 Measurement Results Explanation Example

For all conducted test items:

The offset level is set in the spectrum analyzer to compensate the RF cable loss and attenuator factor between EUT conducted output port and spectrum analyzer. With the offset compensation, the spectrum analyzer reading level is exactly the EUT RF output level.

Example :

The spectrum analyzer offset is derived from RF cable loss and attenuator factor.

Offset = RF cable loss + attenuator factor.

Following shows an offset computation example with cable loss 4.2 dB and 10dB attenuator.

$$\begin{aligned}
 \text{Offset(dB)} &= \text{RF cable loss(dB)} + \text{attenuator factor(dB)}. \\
 &= 4.2 + 10 = 14.2 \text{ (dB)}
 \end{aligned}$$

3 Test Result

3.1 6dB and 26dB and 99% Occupied Bandwidth Measurement

3.1.1 Description of 6dB and 26dB and 99% Occupied Bandwidth

The minimum 6 dB bandwidth shall be at least 500 kHz.

26dB and 99% Occupied bandwidth are reporting only.

3.1.2 Measuring Instruments

The measuring equipment is listed in the section 4 of this test report.

3.1.3 Test Procedures

1. The testing follows FCC KDB 789033 D02 General UNII Test Procedures New Rules v01r04.
Section C) Emission bandwidth for the band 5.725-5.85GHz
2. Set RBW = 100kHz.
3. Set the VBW $\geq 3 \times$ RBW.
4. Detector = Peak.
5. Trace mode = max hold
6. Measure the maximum width of the emission that is 6 dB down from the peak of the emission.
7. Measure and record the results in the test report.

3.1.4 Test Setup

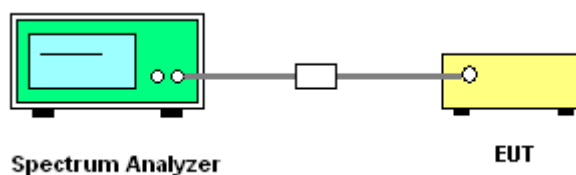



3.1.5 Test Result of 6dB Bandwidth

Please refer to Appendix A.

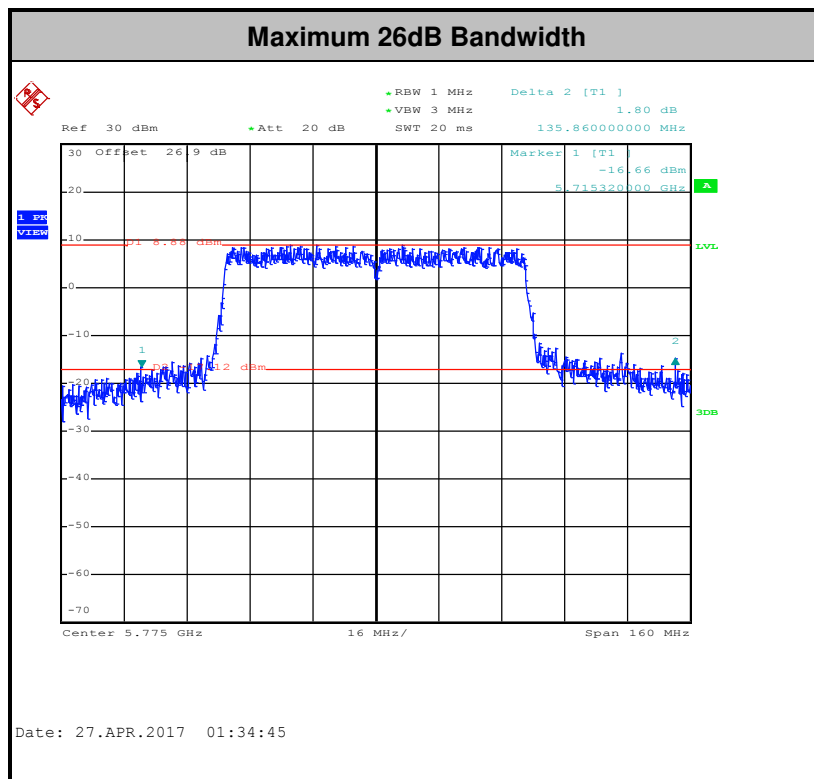
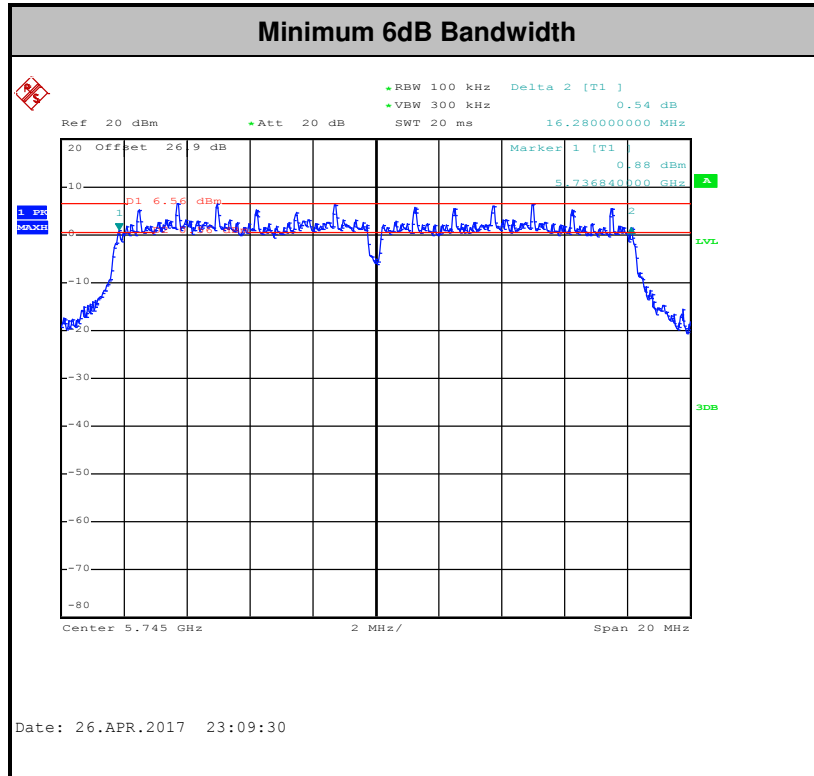

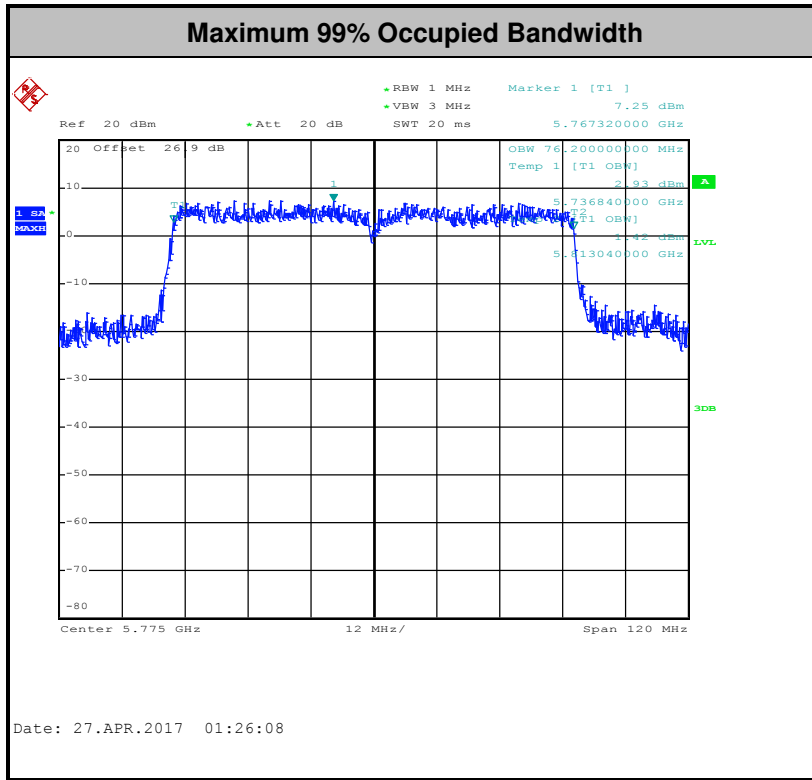

Note: The occupied channel bandwidth is maintained within the band of operation for all of the modulations.

3.2 Maximum Conducted Output Power Measurement

3.2.1 Limit of Maximum Conducted Output Power

For the band 5.725–5.85 GHz, the maximum conducted output power over the frequency band of operation shall not exceed 1 W.

If transmitting antennas of directional gain greater than 6 dBi are used, the peak output power shall be reduced by the amount in dB that the directional gain of the antenna exceeds 6 dBi.

3.2.2 Measuring Instruments

The measuring equipment is listed in the section 4 of this test report.

3.2.3 Test Procedures

The testing follows Method PM of FCC KDB 789033 D02 General UNII Test Procedures New Rules v01r04.

Method PM (Measurement using an RF average power meter):

1. Measurement is performed using a wideband RF power meter.
2. The EUT is configured to transmit continuously with a consistent duty cycle at its maximum power control level.
3. Measure the average power of the transmitter, and the average power is corrected with duty factor, $10 \log(1/x)$, where x is the duty cycle.

3.2.4 Test Setup

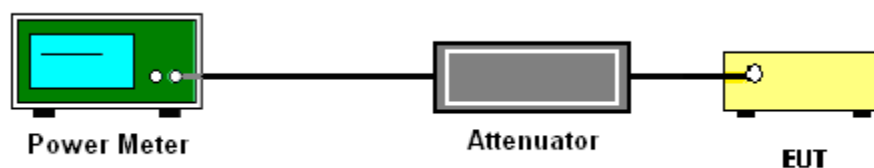

3.2.5 Test Result of Maximum Conducted Output Power

Please refer to Appendix A.



3.3 Power Spectral Density Measurement

3.3.1 Limit of Power Spectral Density

For the band 5.725–5.85 GHz, the maximum power spectral density shall not exceed 30 dBm in any 500-kHz band.

If transmitting antennas of directional gain greater than 6 dBi are used, the peak output power shall be reduced by the amount in dB that the directional gain of the antenna exceeds 6 dBi.

3.3.2 Measuring Instruments

The measuring equipment is listed in the section 4 of this test report.

3.3.3 Test Procedures

The testing follows FCC KDB 789033 D02 General UNII Test Procedures New Rules v01r04. Section F) Maximum power spectral density.

Method SA-2

(trace averaging across on and off times of the EUT transmissions, followed by duty cycle correction).

1. The testing follows Method SA-2 of FCC KDB 789033 D02 General UNII Test Procedures New Rules v01r04.
 - Measure the duty cycle.
 - Set span to encompass the entire emission bandwidth (EBW) of the signal.
 - Set RBW = 300 kHz.
 - Set VBW \geq 1 MHz.
 - Number of points in sweep \geq 2 Span / RBW.
 - Sweep time = auto.
 - Detector = RMS
 - Trace average at least 100 traces in power averaging mode.
 - Add $10 \log(500\text{kHz}/\text{RBW})$ to the test result.
 - Add $10 \log(1/x)$, where x is the duty cycle, to the measured power in order to compute the average power during the actual transmission times. For example, add $10 \log(1/0.25) = 6$ dB if the duty cycle is 25 percent.

2. The RF output of EUT was connected to the spectrum analyzer by a low loss cable.
3. Each plot has already offset with cable loss, and attenuator loss. Measure the PPSD and record it.
4. For MIMO mode, calculation method follows FCC KDB 662911 D01 Multiple Transmitter Output v02r01.

Method (c): Measure and add $10 \log(N_{\text{ANT}})$ dB.

With this technique, spectrum measurements are performed at each output of the device, but rather than summing the spectra or the spectral peaks across the outputs, the quantity $10 \log(N_{\text{ANT}})$ dB is added to each spectrum value before comparing to the emission limit. The addition of $10 \log(N_{\text{ANT}})$ dB serves to apportion the emission limit among the N_{ANT} outputs so that each output is permitted to contribute no more than $1/N_{\text{ANT}}^{\text{th}}$ of the PSD limit.

3.3.4 Test Setup

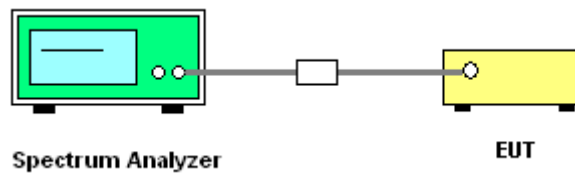

3.3.5 Test Result of Power Spectral Density

Please refer to Appendix A.



Worst Case Power Density (dBm/300kHz) for MIMO Ant. 1

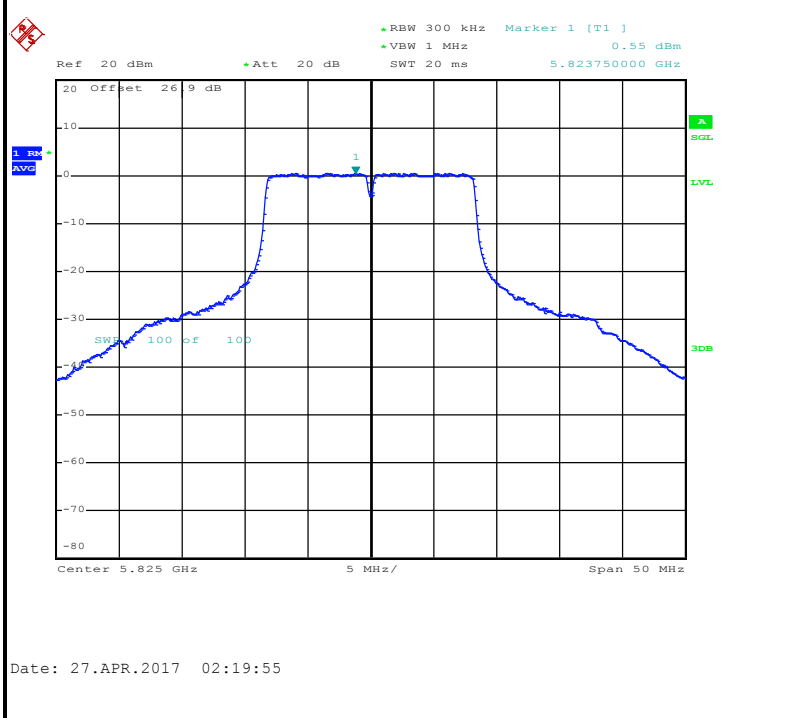

Worst Case Power Density (dBm/300kHz) for MIMO Ant. 2

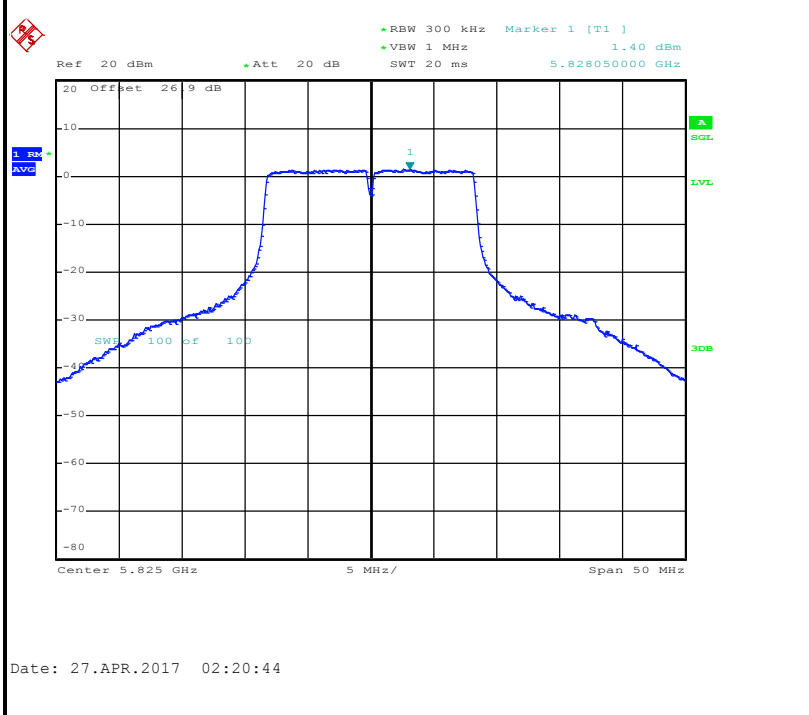



3.4 Unwanted Emissions Measurement

This section is to measure unwanted emissions through radiated measurement for band edge spurious emissions and out of band emissions measurement.

3.4.1 Limit of Unwanted Emissions

- (1) For transmitters operating in the 5.725-5.85 GHz band:
15.407(b)(4)(i) All emissions shall be limited to a level of -27 dBm/MHz at 75 MHz or more above or below the band edge increasing linearly to 10 dBm/MHz at 25 MHz above or below the band edge, and from 25 MHz above or below the band edge increasing linearly to a level of 15.6 dBm/MHz at 5 MHz above or below the band edge, and from 5 MHz above or below the band edge increasing linearly to a level of 27 dBm/MHz at the band edge.
- (2) Unwanted spurious emissions fallen in restricted bands shall comply with the general field strength limits set forth as below table,

Frequency (MHz)	Field Strength (microvolts/meter)	Measurement Distance (meters)
0.009 – 0.490	2400/F(kHz)	300
0.490 – 1.705	24000/F(kHz)	30
1.705 – 30.0	30	30
30 – 88	100	3
88 – 216	150	3
216 - 960	200	3
Above 960	500	3

Note: The following formula is used to convert the EIRP to field strength.

$$E = \frac{1000000\sqrt{30P}}{3} \mu\text{V/m, where P is the eirp (Watts)}$$



EIRP (dBm)	Field Strength at 3m (dBμV/m)
-17	78.3
- 27	68.3

(3) KDB789033 D02 v01r04 G)2)c)

- (i) Sections 15.407(b)(1) to (b)(3) specify the unwanted emission limits for the U-NII-1 and U-NII-2 bands. As specified, emissions above 1000 MHz that are outside of the restricted bands are subject to a peak emission limit of -27 dBm/MHz.³
- (ii) Section 15.407(b)(4) specifies the unwanted emission limit for the U-NII-3 band. A band emissions mask is specified in Section 15.407(b)(4)(i). The emission limits are in terms of a Peak detector. An alternative to the band emissions mask is specified in Section 15.407(b)(4)(ii). The alternative limits are based on the highest antenna gain specified in the filing. There are also marketing and importation restrictions for the devices using the alternative limit.⁴

Note 3: An out-of-band emission that complies with both the average and peak limits of Section 15.209 is not required to satisfy the -27 dBm/MHz peak emission limit.

Note 4: Only devices with antenna gains of 10 dBi or less may be approved using the emission limits specified in Section 15.247(d) till March 2, 2018; all other devices operating in this band must use the mask specified in Section 15.407(b)(4)(i).

3.4.2 Measuring Instruments

The measuring equipment is listed in the section 4 of this test report.



3.4.3 Test Procedures

1. The testing follows FCC KDB 789033 D02 General UNII Test Procedures New Rules v01r04. Section G) Unwanted emissions measurement.

(1) Procedure for Unwanted Emissions Measurements Below 1000MHz

- RBW = 120 kHz
- VBW = 300 kHz
- Detector = Peak
- Trace mode = max hold

(2) Procedure for Peak Unwanted Emissions Measurements Above 1000 MHz

- RBW = 1 MHz
- VBW \geq 3 MHz
- Detector = Peak
- Sweep time = auto
- Trace mode = max hold

(3) Procedures for Average Unwanted Emissions Measurements Above 1000MHz

- RBW = 1 MHz
- VBW = 10 Hz, when duty cycle is no less than 98 percent.
- VBW \geq 1/T, when duty cycle is less than 98 percent where T is the minimum transmission duration over which the transmitter is on and is transmitting at its maximum power control level for the tested mode of operation.

2. The EUT was placed on a turntable with 0.8 meter for frequency below 1GHz and 1.5 meter for frequency above 1GHz respectively above ground.
3. The EUT was set 3 meters from the interference receiving antenna which was mounted on the top of a variable height antenna tower.
4. The antenna is a broadband antenna and its height is adjusted between one meter and four meters above ground to find the maximum value of the field strength for both horizontal polarization and vertical polarization of the antenna.
5. For each suspected emission, the EUT was arranged to its worst case and then adjust the antenna tower (from 1 m to 4 m) and turntable (from 0 degree to 360 degrees) to find the maximum reading.
6. For testing below 1GHz, if the emission level of the EUT in peak mode was 3 dB lower than the limit specified, then peak values of EUT will be reported, otherwise, the emissions will be repeated one by one using the CISPR quasi-peak method and reported.
7. For testing above 1GHz, the emission level of the EUT in peak mode was 20dB lower than average limit (that means the emission level in average mode also complies with the limit in average mode), then peak values of EUT will be reported, otherwise, the emissions will be measured in average mode again and reported.

3.4.4 Test Setup

For radiated emissions below 30MHz

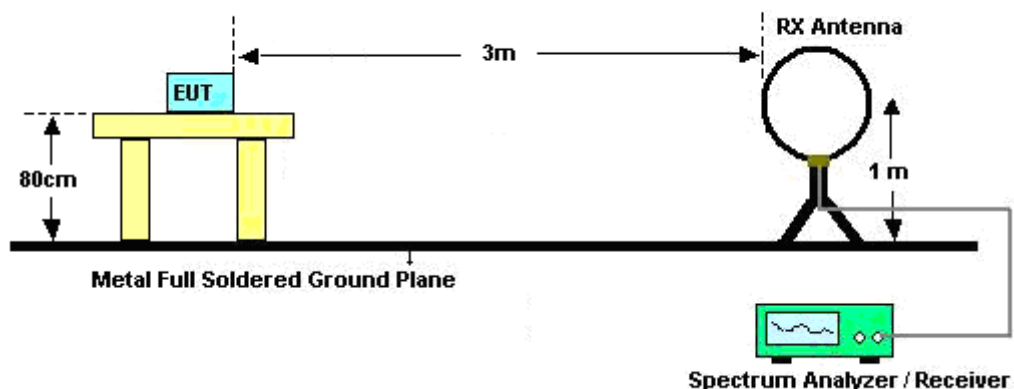

For radiated emissions from 30MHz to 1GHz

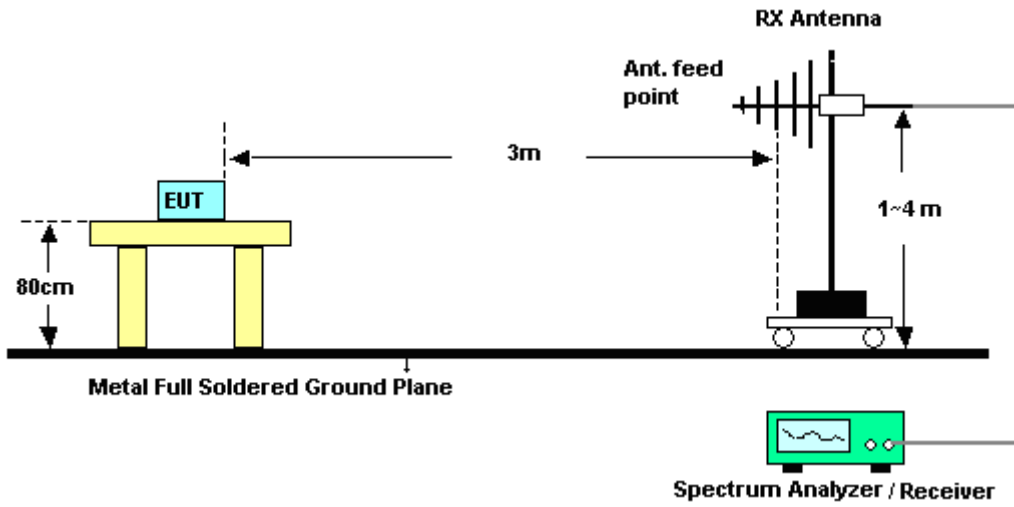

For radiated emissions above 1GHz

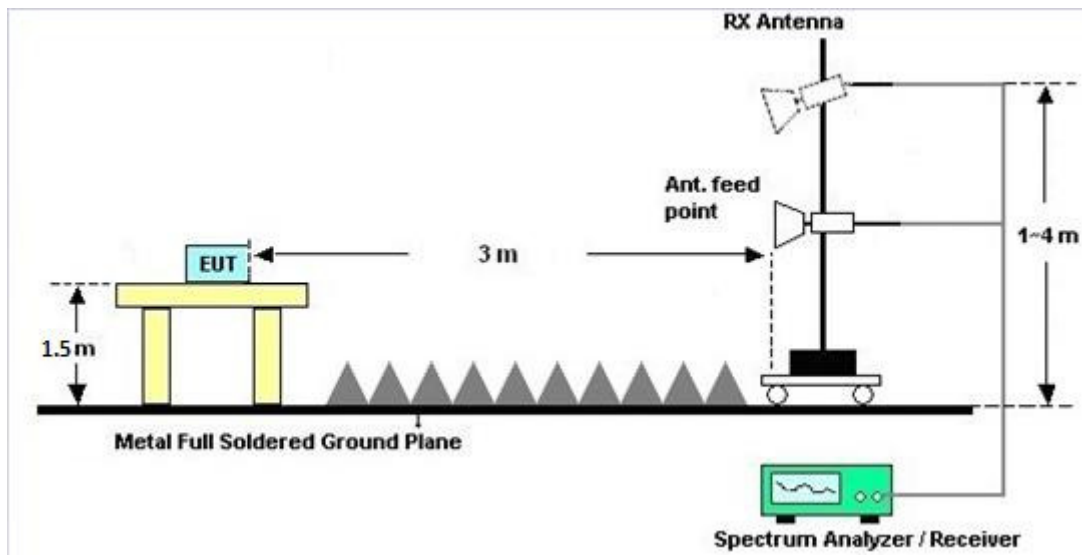



3.4.5 Test Results of Radiated Spurious Emissions (9 kHz ~ 30 MHz)

The low frequency, which started from 9 kHz to 30MHz, was pre-scanned and the result which was 20dB lower than the limit line was not reported.

3.4.6 Test Result of Radiated Spurious at Band Edges

Please refer to Appendix B and C.

3.4.7 Duty Cycle

Please refer to Appendix D.

3.4.8 Test Result of Radiated Spurious Emissions (30MHz ~ 10th Harmonic)

Please refer to Appendix B and C.



3.5 AC Conducted Emission Measurement

3.5.1 Limit of AC Conducted Emission

For equipment that is designed to be connected to the public utility (AC) power line, the radio frequency voltage that is conducted back onto the AC power line on any frequency or frequencies within the band 150 kHz to 30 MHz shall not exceed the limits in the following table.

Frequency of emission (MHz)	Conducted limit (dBµV)	
	Quasi-peak	Average
0.15-0.5	66 to 56*	56 to 46*
0.5-5	56	46
5-30	60	50

*Decreases with the logarithm of the frequency.

3.5.2 Measuring Instruments

The measuring equipment is listed in the section 4 of this test report.

3.5.3 Test Procedures

1. The EUT was placed 0.4 meter from the conducting wall of the shielding room was kept at least 80 centimeters from any other grounded conducting surface.
2. Connect EUT to the power mains through a line impedance stabilization network (LISN).
3. All the support units are connecting to the other LISN.
4. The LISN provides 50 ohm coupling impedance for the measuring instrument.
5. The FCC states that a 50 ohm, 50 microhenry LISN should be used.
6. Both sides of AC line were checked for maximum conducted interference.
7. The frequency range from 150 kHz to 30 MHz was searched.
8. Set the test-receiver system to Peak Detect Function and specified bandwidth with Maximum Hold Mode.

3.5.4 Test Setup

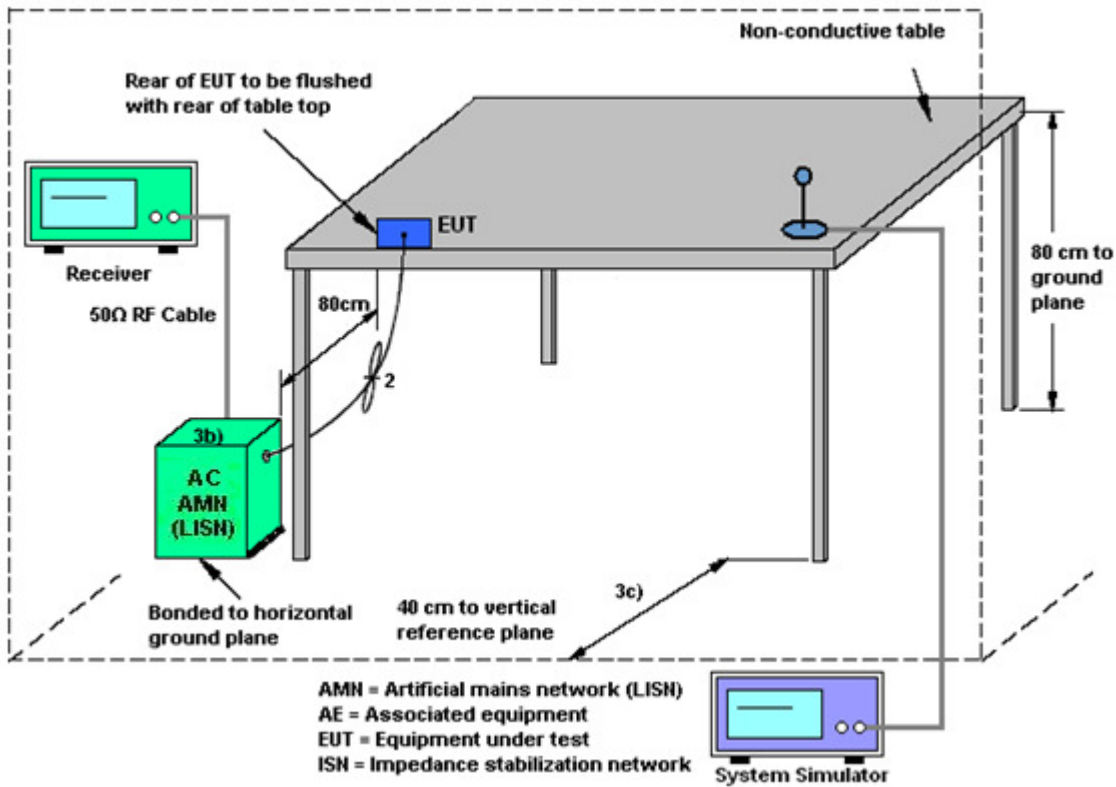

3.5.5 Test Result of AC Conducted Emission

Test Mode :	Mode 1	Temperature :	21~23°C
Test Engineer :	Eric Jeng	Relative Humidity :	52~55%
Test Voltage :	120Vac / 60Hz	Phase :	Line
Function Type :	GSM850 Idle + Bluetooth Link + WLAN (5GHz) Link + MP3 + Battery 2 + USB Cable (Charging from Adapter 3)		

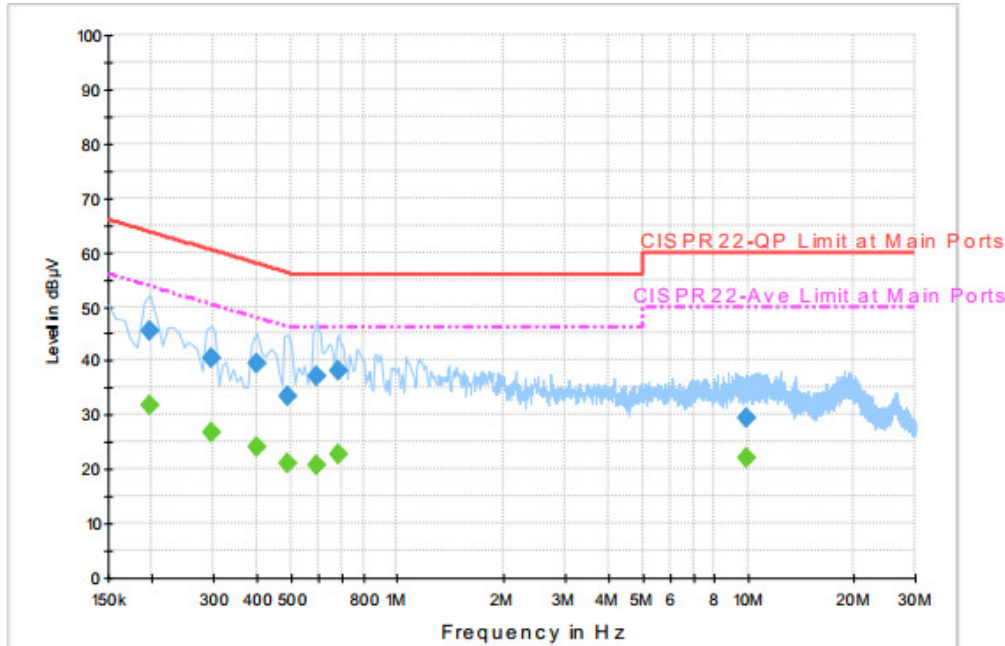

Final Result : QuasiPeak

Frequency (MHz)	QuasiPeak (dBµV)	Filter	Line	Corr. (dB)	Margin (dB)	Limit (dBµV)
0.198000	45.5	Off	L1	19.6	18.2	63.7
0.294000	40.4	Off	L1	19.6	20.0	60.4
0.398000	39.6	Off	L1	19.6	18.3	57.9
0.486000	33.5	Off	L1	19.6	22.7	56.2
0.590000	37.2	Off	L1	19.6	18.8	56.0
0.678000	38.1	Off	L1	19.6	17.9	56.0
9.902000	29.3	Off	L1	20.0	30.7	60.0

Final Result : Average

Frequency (MHz)	Average (dBµV)	Filter	Line	Corr. (dB)	Margin (dB)	Limit (dBµV)
0.198000	31.7	Off	L1	19.6	22.0	53.7
0.294000	26.7	Off	L1	19.6	23.7	50.4
0.398000	24.1	Off	L1	19.6	23.8	47.9
0.486000	20.9	Off	L1	19.6	25.3	46.2
0.590000	20.8	Off	L1	19.6	25.2	46.0
0.678000	22.6	Off	L1	19.6	23.4	46.0
9.902000	22.0	Off	L1	20.0	28.0	50.0



Test Mode :	Mode 1	Temperature :	21~23°C
Test Engineer :	Eric Jeng	Relative Humidity :	52~55%
Test Voltage :	120Vac / 60Hz	Phase :	Neutral
Function Type :	GSM850 Idle + Bluetooth Link + WLAN (5GHz) Link + MP3 + Battery 2 + USB Cable (Charging from Adapter 3)		

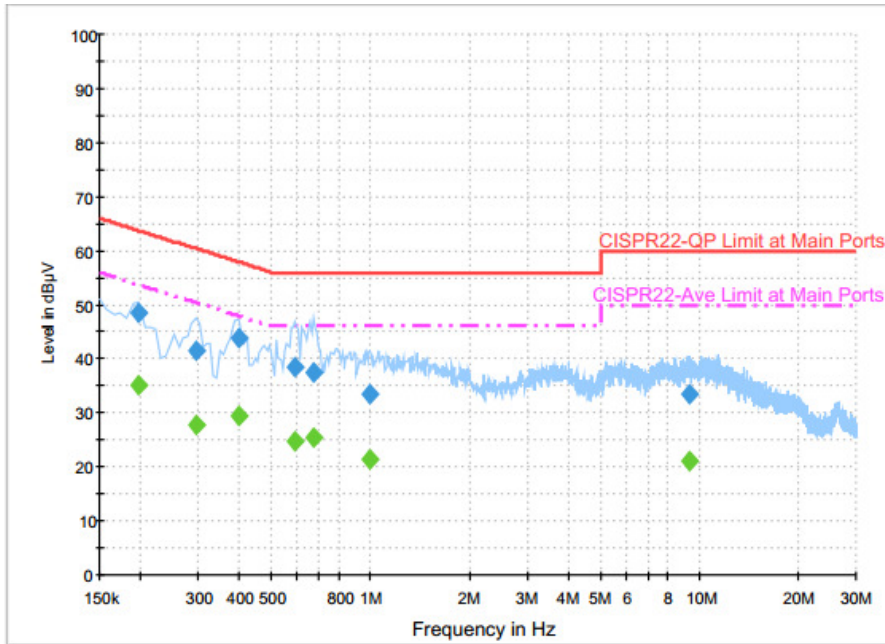

Final Result : QuasiPeak

Frequency (MHz)	QuasiPeak (dBµV)	Filter	Line	Corr. (dB)	Margin (dB)	Limit (dBµV)
0.198000	48.4	Off	N	19.5	15.3	63.7
0.294000	41.4	Off	N	19.5	19.0	60.4
0.398000	43.9	Off	N	19.5	14.0	57.9
0.590000	38.5	Off	N	19.5	17.5	56.0
0.670000	37.6	Off	N	19.5	18.4	56.0
0.998000	33.6	Off	N	19.6	22.4	56.0
9.342000	33.3	Off	N	20.0	26.7	60.0

Final Result : Average

Frequency (MHz)	Average (dBµV)	Filter	Line	Corr. (dB)	Margin (dB)	Limit (dBµV)
0.198000	35.1	Off	N	19.5	18.6	53.7
0.294000	27.8	Off	N	19.5	22.6	50.4
0.398000	29.6	Off	N	19.5	18.3	47.9
0.590000	24.7	Off	N	19.5	21.3	46.0
0.670000	25.4	Off	N	19.5	20.6	46.0
0.998000	21.4	Off	N	19.6	24.6	46.0
9.342000	21.2	Off	N	20.0	28.8	50.0

3.6 Frequency Stability Measurement

3.6.1 Limit of Frequency Stability

Manufacturers of U-NII devices are responsible for ensuring frequency stability such that an emission is maintained within the band of operation under all conditions of normal operation as specified in the user's manual.

3.6.2 Measuring Instruments

The measuring equipment is listed in the section 4 of this test report.

3.6.3 Test Procedures

1. To ensure emission at the band edge is maintained within the authorized band, those values shall be measured by radiation emissions at upper and lower frequency points, and finally compensated by frequency deviation as procedures below.
2. The EUT was operated at the maximum output power, and connected to the spectrum analyzer, which is set to maximum hold function and peak detector. The peak value of the power envelope was measured and noted. The upper and lower frequency points were respectively measured relatively 10dB lower than the measured peak value.
3. The frequency deviation was calculated by adding the upper frequency point and the lower frequency point divided by two. Those detailed values of frequency deviation are provided in table below.

3.6.4 Test Setup



3.6.5 Test Result of Frequency Stability

Please refer to Appendix A.



3.7 Automatically Discontinue Transmission

3.7.1 Limit of Automatically Discontinue Transmission

The device shall automatically discontinue transmission in case of either absence of information to transmit or operational failure. These provisions are not intended to preclude the transmission of control or signaling information or the use of repetitive codes used by certain digital technologies to complete frame or burst intervals. Applicants shall include in their application for equipment authorization to describe how this requirement is met.

3.7.2 Measuring Instruments

The measuring equipment is listed in the section 4 of this test report.

3.7.3 Test Result of Automatically Discontinue Transmission

While the EUT is not transmitting any information, the EUT can automatically discontinue transmission and become standby mode for power saving. The EUT can detect the controlling signal of ACK message transmitting from remote device and verify whether it shall resend or discontinue transmission.



3.8 Antenna Requirements

3.8.1 Standard Applicable

If transmitting antenna directional gain is greater than 6 dBi, both the peak transmit power and the peak power spectral density shall be reduced by the amount in dB that the directional gain of the antenna exceeds 6 dBi.

3.8.2 Antenna Anti-Replacement Construction

An embedded-in antenna design is used.

3.8.3 Antenna Gain

FCC KDB 662911 D01 Multiple Transmitter Output v02r01

For CDD transmissions, directional gain is calculated as

Directional gain = $G_{ANT} + \text{Array Gain}$, where Array Gain is as follows.

For power spectral density (PSD) measurements on all devices,

Array Gain = $10 \log(N_{ANT}/N_{SS}=1)$ dB.

For power measurements on IEEE 802.11 devices,

Array Gain = 0 dB (i.e., no array gain) for $N_{ANT} \leq 4$.

Directional gain may be calculated by using the formulas applicable to equal gain antennas with G_{ANT} set equal to the gain of the antenna having the highest gain;

The EUT supports CDD mode.

For power, the directional gain G_{ANT} is set equal to the antenna having the highest gain, i.e., F)2)f)i).

For PSD, the directional gain calculation is following F)2)f)ii) of KDB 662911 D01 v02r01.

The power and PSD limit should be modified if the directional gain of EUT is over 6 dBi,

The directional gain "DG" is calculated as following table.

			DG for Power (dBi)	DG for PSD (dBi)	Power Limit Reduction (dB)	PSD Limit Reduction (dB)
	Ant 1 (dBi)	Ant 2 (dBi)				
Band IV	-2.40	-3.50	-2.40	0.08	0.00	0.00

Power limit reduction = Composite gain – 6dBi, (min = 0)

PSD limit reduction = Composite gain + PSD Array gain – 6dBi, (min = 0)



4 List of Measuring Equipment

Instrument	Manufacturer	Model No.	Serial No.	Characteristics	Calibration Date	Test Date	Due Date	Remark
Power Meter	Anritsu	ML2495A	0932001	300MHz~40GHz	Sep. 29, 2016	Apr. 03, 2017~ Apr. 27, 2017	Sep. 28, 2017	Conducted (TH05-HY)
Power Sensor	Anritsu	MA2411B	0846202	300MHz~40GHz	Sep. 29, 2016	Apr. 03, 2017~ Apr. 27, 2017	Sep. 28, 2017	Conducted (TH05-HY)
Spectrum Analyzer	Rohde & Schwarz	FSP40	100055	9kHz-40GHz	Jul. 17, 2016	Apr. 03, 2017~ Apr. 27, 2017	Jul. 16, 2017	Conducted (TH05-HY)
Temperature Chamber	ESPEC	SH-641	92013720	-40°C ~90°C	Sep. 01, 2016	Apr. 03, 2017~ Apr. 27, 2017	Aug. 31, 2017	Conducted (TH05-HY)
Programmable Power Supply	GW Instek	PSS-2005	EL890094	1V~20V 0.5A~5A	Oct. 11, 2016	Apr. 03, 2017~ Apr. 27, 2017	Oct. 10, 2017	Conducted (TH05-HY)
AC Power Source	ChainTek	APC-1000W	N/A	N/A	N/A	Apr. 05, 2017	N/A	Conduction (CO05-HY)
EMI Test Receiver	Rohde & Schwarz	ESCI 7	100724	9kHz~7GHz	Aug. 30, 2016	Apr. 05, 2017	Aug. 29, 2017	Conduction (CO05-HY)
LISN	Rohde & Schwarz	ENV216	100080	9kHz~30MHz	Nov. 29, 2016	Apr. 05, 2017	Nov. 28, 2017	Conduction (CO05-HY)
Amplifier	SONOMA	310N	187312	9kHz~1GHz	Nov. 10, 2016	Apr. 08, 2017~ Apr. 14, 2017	Nov. 09, 2017	Radiation (03CH11-HY)
Loop Antenna	Rohde & Schwarz	HFH2-Z2	100315	9 kHz~30 MHz	Sep. 02, 2015	Apr. 08, 2017~ Apr. 14, 2017	Sep. 01, 2017	Radiation (03CH11-HY)
Bilog Antenna	TESEQ	CBL 6111D	35414	30MHz~1GHz	Oct. 15, 2016	Apr. 08, 2017~ Apr. 14, 2017	Oct. 14, 2017	Radiation (03CH11-HY)
Horn Antenna	SCHWARZBECK	BBHA 9120 D	9120D-1326	1GHz ~ 18GHz	Oct. 07, 2016	Apr. 08, 2017 ~ Apr. 14, 2017	Oct. 06, 2017	Radiation (03CH11-HY)
Preamplifier	Keysight	83017A	MY53270080	1GHz~26.5GHz	Nov. 10, 2016	Apr. 08, 2017~ Apr. 14, 2017	Nov. 09, 2017	Radiation (03CH11-HY)
Spectrum Analyzer	Keysight	N9010A	MY54200486	10Hz ~ 44GHz	Oct. 12, 2016	Apr. 08, 2017 ~ Apr. 14, 2017	Oct. 11, 2017	Radiation (03CH11-HY)
Antenna Mast	EMEC	AM-BS-4500-B	N/A	1~4m	N/A	Apr. 08, 2017~ Apr. 14, 2017	N/A	Radiation (03CH11-HY)
Turn Table	EMEC	TT 2000	N/A	0~360 Degree	N/A	Apr. 08, 2017~ Apr. 14, 2017	N/A	Radiation (03CH11-HY)
Preamplifier	MITEQ	AMF-7D-0010 1800-30-10P	1815698	1GHz~18GHz	Dec. 01, 2016	Apr. 08, 2017~ Apr. 14, 2017	Nov. 30, 2017	Radiation (03CH11-HY)
SHF-EHF Horn Antenna	SCHWARZBECK	BBHA 9170	BBHA917058 4	18GHz- 40GHz	Nov. 08, 2016	Apr. 08, 2017~ Apr. 14, 2017	Nov. 07, 2017	Radiation (03CH11-HY)
Preamplifier	MITEQ	TTA0204	1872107	2GHz~40GHz	Feb. 15, 2017	Apr. 08, 2017~ Apr. 14, 2017	Feb. 14, 2018	Radiation (03CH11-HY)



5 Uncertainty of Evaluation

Uncertainty of Conducted Emission Measurement (150kHz ~ 30MHz)

Measuring Uncertainty for a Level of Confidence of 95% ($U = 2Uc(y)$)	2.7
---	-----

Uncertainty of Radiated Emission Measurement (30 MHz ~ 1000 MHz)

Measuring Uncertainty for a Level of Confidence of 95% ($U = 2Uc(y)$)	5.2
---	-----

Uncertainty of Radiated Emission Measurement (1000 MHz ~ 18000 MHz)

Measuring Uncertainty for a Level of Confidence of 95% ($U = 2Uc(y)$)	5.5
---	-----

Uncertainty of Radiated Emission Measurement (18000 MHz ~ 40000 MHz)

Measuring Uncertainty for a Level of Confidence of 95% ($U = 2Uc(y)$)	5.2
---	-----

Appendix A. Test Result of Conducted Test Items

Test Engineer:	Shiming Liu	Temperature:	21~25	°C
Test Date:	2017/4/3~2017/4/27	Relative Humidity:	51~54	%

TEST RESULTS DATA
6dB and 26dB EBW and 99% OBW

Band IV													
Mod.	Data Rate	NTX	CH.	Freq. (MHz)	99% Bandwidth (MHz)		26dB Bandwidth (MHz)		6 dB Bandwidth (MHz)		6 dB Bandwidth Min. Limit (MHz)		Pass/Fail
					Ant 1	Ant 2	Ant 1	Ant 2	Ant 1	Ant 2	Ant 1	Ant 2	
11a	6Mbps	2	149	5745	17.85	17.85	36.15	32.90	16.28	16.36	0.5	0.5	Pass
11a	6Mbps	2	157	5785	18.05	17.85	36.90	35.15	16.32	16.30	0.5	0.5	Pass
11a	6Mbps	2	165	5825	18.05	17.85	37.00	33.25	16.32	16.28	0.5	0.5	Pass
HT20	MCS0	2	149	5745	18.95	19.00	40.55	38.65	17.16	17.56	0.5	0.5	Pass
HT20	MCS0	2	157	5785	19.25	19.05	42.95	41.70	17.56	17.52	0.5	0.5	Pass
HT20	MCS0	2	165	5825	19.50	18.90	42.70	40.65	17.56	17.52	0.5	0.5	Pass
HT40	MCS0	2	151	5755	37.40	37.20	75.96	74.15	36.36	36.32	0.5	0.5	Pass
HT40	MCS0	2	159	5795	37.00	37.30	60.42	56.02	36.08	36.32	0.5	0.5	Pass
VHT20	MCS0	2	149	5745	19.15	18.85	39.15	38.50	17.26	17.30	0.5	0.5	Pass
VHT20	MCS0	2	157	5785	19.35	19.00	41.96	38.45	17.56	17.50	0.5	0.5	Pass
VHT20	MCS0	2	165	5825	19.40	19.00	40.90	40.60	17.56	17.54	0.5	0.5	Pass
VHT40	MCS0	2	151	5755	36.90	37.10	56.44	65.52	36.07	36.28	0.5	0.5	Pass
VHT40	MCS0	2	159	5795	37.10	37.30	72.45	57.30	36.32	36.26	0.5	0.5	Pass
VHT80	MCS0	2	155	5775	76.20	76.20	132.38	135.86	75.72	75.36	0.5	0.5	Pass

TEST RESULTS DATA
Average Power Table

Band IV														
Mod.	Data Rate	NTX	CH.	Freq. (MHz)	Duty Factor (dB)		Average Conducted Power (dBm)			FCC Conducted Power Limit (dBm)		DG (dBi)		Pass/Fail
					Ant 1	Ant 2	Ant 1	Ant 2	SUM	Ant 1	Ant 2	Ant 1	Ant 2	
11a	6Mbps	1	149	5745	0.26	0.23	18.11	18.13		30.00	30.00	-2.40	-3.50	Pass
11a	6Mbps	1	157	5785	0.26	0.23	18.07	18.11		30.00	30.00	-2.40	-3.50	Pass
11a	6Mbps	1	165	5825	0.26	0.23	18.03	18.08		30.00	30.00	-2.40	-3.50	Pass
HT20	MCS0	1	149	5745	0.28	0.25	18.13	18.21		30.00	30.00	-2.40	-3.50	Pass
HT20	MCS0	1	157	5785	0.28	0.25	18.03	18.09		30.00	30.00	-2.40	-3.50	Pass
HT20	MCS0	1	165	5825	0.28	0.25	18.00	18.08		30.00	30.00	-2.40	-3.50	Pass
HT40	MCS0	1	151	5755	0.48	0.43	17.42	17.43		30.00	30.00	-2.40	-3.50	Pass
HT40	MCS0	1	159	5795	0.48	0.43	17.48	17.55		30.00	30.00	-2.40	-3.50	Pass
VHT20	MCS0	1	149	5745	0.24	0.28	18.14	18.23		30.00	30.00	-2.40	-3.50	Pass
VHT20	MCS0	1	157	5785	0.24	0.28	18.04	18.19		30.00	30.00	-2.40	-3.50	Pass
VHT20	MCS0	1	165	5825	0.24	0.28	18.02	18.18		30.00	30.00	-2.40	-3.50	Pass
VHT40	MCS0	1	151	5755	0.43	0.48	17.43	17.49		30.00	30.00	-2.40	-3.50	Pass
VHT40	MCS0	1	159	5795	0.43	0.48	17.49	17.64		30.00	30.00	-2.40	-3.50	Pass
VHT80	MCS0	1	155	5775	0.63	0.67	18.18	18.30		30.00	30.00	-2.40	-3.50	Pass
11a	6Mbps	2	149	5745	0.23	0.23	17.99	18.13	21.07	30.00		-2.40		Pass
11a	6Mbps	2	157	5785	0.23	0.23	17.96	18.12	21.05	30.00		-2.40		Pass
11a	6Mbps	2	165	5825	0.23	0.23	17.94	18.08	21.02	30.00		-2.40		Pass
HT20	MCS0	2	149	5745	0.24	0.25	17.89	18.21	21.06	30.00		-2.40		Pass
HT20	MCS0	2	157	5785	0.24	0.25	17.85	18.18	21.03	30.00		-2.40		Pass
HT20	MCS0	2	165	5825	0.24	0.25	17.84	18.15	21.01	30.00		-2.40		Pass
HT40	MCS0	2	151	5755	0.48	0.48	17.22	17.46	20.35	30.00		-2.40		Pass
HT40	MCS0	2	159	5795	0.48	0.48	17.35	17.62	20.50	30.00		-2.40		Pass
VHT20	MCS0	2	149	5745	0.24	0.24	18.13	18.24	21.20	30.00		-2.40		Pass
VHT20	MCS0	2	157	5785	0.24	0.24	18.09	18.19	21.15	30.00		-2.40		Pass
VHT20	MCS0	2	165	5825	0.24	0.24	18.06	18.18	21.13	30.00		-2.40		Pass
VHT40	MCS0	2	151	5755	0.47	0.43	17.27	17.47	20.38	30.00		-2.40		Pass
VHT40	MCS0	2	159	5795	0.47	0.43	17.39	17.63	20.52	30.00		-2.40		Pass
VHT80	MCS0	2	155	5775	0.67	0.63	18.12	18.27	21.21	30.00		-2.40		Pass

TEST RESULTS DATA
Power Spectral Density

Band IV																
Mod.	Data Rate	NTX	CH.	Freq. (MHz)	Duty Factor (dB)		10log (500kHz /RBW) Factor (dB)		Average Power Density (dBm/500kHz)			Average PSD Limit (dBm/500kHz)		DG (dBi)		Pass /Fail
					Ant 1	Ant 2	Ant 1	Ant 2	Ant 1	Ant 2	SUM	Ant 1	Ant 2	Ant 1	Ant 2	
11a	6Mbps	2	149	5745	0.23	0.23	2.22					6.40	30.00	0.08		Pass
11a	6Mbps	2	157	5785	0.23	0.23	2.22					6.30	30.00	0.08		Pass
11a	6Mbps	2	165	5825	0.23	0.23	2.22					6.86	30.00	0.08		Pass
HT20	MCS0	2	149	5745	0.24	0.25	2.22					6.34	30.00	0.08		Pass
HT20	MCS0	2	157	5785	0.24	0.25	2.22					6.24	30.00	0.08		Pass
HT20	MCS0	2	165	5825	0.24	0.25	2.22					6.65	30.00	0.08		Pass
HT40	MCS0	2	151	5755	0.48	0.48	2.22					2.75	30.00	0.08		Pass
HT40	MCS0	2	159	5795	0.48	0.48	2.22					2.89	30.00	0.08		Pass
VHT20	MCS0	2	149	5745	0.24	0.24	2.22					6.23	30.00	0.08		Pass
VHT20	MCS0	2	157	5785	0.24	0.24	2.22					6.17	30.00	0.08		Pass
VHT20	MCS0	2	165	5825	0.24	0.24	2.22					6.66	30.00	0.08		Pass
VHT40	MCS0	2	151	5755	0.47	0.43	2.22					2.71	30.00	0.08		Pass
VHT40	MCS0	2	159	5795	0.47	0.43	2.22					2.80	30.00	0.08		Pass
VHT80	MCS0	2	155	5775	0.67	0.63	2.22					0.56	30.00	0.08		Pass

TEST RESULTS DATA
Frequency Stability

Band IV										
Mod.	Data Rate	NTX	CH.	Freq. (MHz)	Center Frequency (MHz)	Frequency Deviation (MHz)	Frequency Stability (ppm)	Temperature (°C)	Voltage (V)	Note
11a	6Mbps	1	149	5745	5745.000	0.000	0.00	50	3.7	
11a	6Mbps	1	149	5745	5745.025	0.025	4.35	-30	3.7	
11a	6Mbps	1	149	5745	5744.975	-0.025	-4.35	20	4.2	
11a	6Mbps	1	149	5745	5745.000	0.000	0.00	20	3.2	
11a	6Mbps	1	149	5745	5744.950	-0.050	-8.70	20	3.7	



Appendix B. Radiated Spurious Emission

Test Engineer :	J.C. Liang, Jacky Hung, and Kan Wu	Temperature :	18~22°C
		Relative Humidity :	55~58%

Band 4 - 5725~5850MHz

WIFI 802.11a (Band Edge @ 3m)

WIFI Ant.	Note	Frequency (MHz)	Level (dBμV/m)	Over Limit (dB)	Limit Line (dBμV/m)	Read Level (dBμV)	Antenna Factor (dB/m)	Cable Loss (dB)	Preamp Factor (dB)	Ant Pos (cm)	Table Pos (deg)	Peak Avg. (P/A)	Pol. (H/V)	
802.11a CH 149 5745MHz		5620.6	49.86	-18.34	68.2	40.72	32.69	9.53	33.08	102	239	P	H	
		5696.2	52.28	-50.12	102.4	42.82	32.86	9.72	33.12	102	239	P	H	
		5716.8	62.26	-47.65	109.91	52.72	32.9	9.77	33.13	102	239	P	H	
		5724.8	72.09	-49.65	121.74	62.46	32.94	9.82	33.13	102	239	P	H	
	*	5745	110.06	-	-	100.36	32.98	9.87	33.15	102	239	P	H	
	*	5745	102.32	-	-	92.62	32.98	9.87	33.15	102	239	A	H	
														H
														H
			5617.6	50.22	-17.98	68.2	41.08	32.69	9.53	33.08	315	88	P	V
			5697.8	52.07	-51.51	103.58	42.61	32.86	9.72	33.12	315	88	P	V
			5719.6	63.55	-47.14	110.69	53.92	32.94	9.82	33.13	315	88	P	V
			5724	76.6	-43.32	119.92	66.97	32.94	9.82	33.13	315	88	P	V
	*	5745	110.59	-	-	100.89	32.98	9.87	33.15	315	88	P	V	
	*	5745	103.43	-	-	93.73	32.98	9.87	33.15	315	88	A	V	
														V
														V



WIFI Ant. 1+2	Note	Frequency (MHz)	Level (dBμV/m)	Over Limit (dB)	Limit Line (dBμV/m)	Read Level (dBμV)	Antenna Factor (dB/m)	Cable Loss (dB)	Preamp Factor (dB)	Ant Pos (cm)	Table Pos (deg)	Peak Avg. (P/A)	Pol. (H/V)	
802.11a CH 157 5785MHz		5629.4	51.16	-17.04	68.2	41.99	32.69	9.58	33.1	100	235	P	H	
		5673.6	50.47	-35.23	85.7	41.1	32.81	9.67	33.11	100	235	P	H	
		5719.8	50.81	-59.93	110.74	41.18	32.94	9.82	33.13	100	235	P	H	
		5720.2	50.12	-61.14	111.26	40.49	32.94	9.82	33.13	100	235	P	H	
	*	5785	109.53	-	-	99.67	33.06	9.97	33.17	100	235	P	H	
	*	5785	102.33	-	-	92.47	33.06	9.97	33.17	100	235	A	H	
		5854	51.35	-61.73	113.08	41.25	33.27	10.02	33.19	100	235	P	H	
		5858.2	51.29	-58.61	109.9	41.21	33.27	10.02	33.21	100	235	P	H	
		5898.8	50.77	-36.78	87.55	40.62	33.35	10.02	33.22	100	235	P	H	
		5942	49.93	-18.27	68.2	39.67	33.48	10.02	33.24	100	235	P	H	
														H
														H
			5610.4	49.81	-18.39	68.2	40.71	32.65	9.53	33.08	309	80	P	V
			5663.4	50.52	-27.63	78.15	41.24	32.77	9.62	33.11	309	80	P	V
			5715	50.35	-59.05	109.4	40.81	32.9	9.77	33.13	309	80	P	V
			5725	52.31	-69.89	122.2	42.68	32.94	9.82	33.13	309	80	P	V
	*		5785	111.17	-	-	101.31	33.06	9.97	33.17	309	80	P	V
	*		5785	103.4	-	-	93.54	33.06	9.97	33.17	309	80	A	V
			5850.6	50.71	-70.12	120.83	40.65	33.23	10.02	33.19	309	80	P	V
			5856.6	50.84	-59.51	110.35	40.74	33.27	10.02	33.19	309	80	P	V
		5896	51.32	-38.3	89.62	41.17	33.35	10.02	33.22	309	80	P	V	
		5944.4	49.86	-18.34	68.2	39.6	33.48	10.02	33.24	309	80	P	V	
													V	
													V	



WiFi Ant. 1+2	Note	Frequency (MHz)	Level (dBμV/m)	Over Limit (dB)	Limit Line (dBμV/m)	Read Level (dBμV)	Antenna Factor (dB/m)	Cable Loss (dB)	Preamp Factor (dB)	Ant Pos (cm)	Table Pos (deg)	Peak Avg. (P/A)	Pol. (H/V)	
802.11a CH 165 5825MHz	*	5825	109.38	-	-	99.35	33.19	10.02	33.18	105	238	P	H	
	*	5825	102.18	-	-	92.15	33.19	10.02	33.18	105	238	A	H	
		5853	61.22	-54.14	115.36	51.16	33.23	10.02	33.19	105	238	P	H	
		5857.2	61.33	-48.85	110.18	51.23	33.27	10.02	33.19	105	238	P	H	
		5887.2	52	-44.14	96.14	41.89	33.31	10.02	33.22	105	238	P	H	
		5936.6	50.05	-18.15	68.2	39.84	33.43	10.02	33.24	105	238	P	H	
														H
														H
	*	5825	109.73	-	-	99.7	33.19	10.02	33.18	323	88	P	V	
	*	5825	102.63	-	-	92.6	33.19	10.02	33.18	323	88	A	V	
		5853.6	62.07	-51.92	113.99	51.97	33.27	10.02	33.19	323	88	P	V	
		5855.4	57.32	-53.37	110.69	47.22	33.27	10.02	33.19	323	88	P	V	
		5878.6	52.63	-49.9	102.53	42.51	33.31	10.02	33.21	323	88	P	V	
		5929.4	50.2	-18	68.2	39.98	33.43	10.02	33.23	323	88	P	V	
														V
														V
														V
	Remark	1. No other spurious found. 2. All results are PASS against Peak and Average limit line.												



Band 4 5725~5850MHz
WIFI 802.11a (Harmonic @ 3m)

WIFI Ant. 1+2	Note	Frequency (MHz)	Level (dBμV/m)	Over Limit (dB)	Limit Line (dBμV/m)	Read Level (dBμV)	Antenna Factor (dB/m)	Cable Loss (dB)	Preamp Factor (dB)	Ant Pos (cm)	Table Pos (deg)	Peak Avg. (P/A)	Pol. (H/V)
802.11a CH 149 5745MHz		11490	48.22	-25.78	74	59	38.52	15.81	65.39	100	0	P	H
		17235	47.8	-20.4	68.2	51.09	40.76	19.86	64.27	100	0	P	H
													H
													H
		11490	53.98	-20.02	74	64.76	38.52	15.81	65.39	100	241	P	V
		11490	43.36	-10.64	54	54.14	38.52	15.81	65.39	100	241	A	V
		17235	49.16	-19.04	68.2	52.45	40.76	19.86	64.27	100	0	P	V
802.11a CH 157 5785MHz		11570	48.35	-25.65	74	59	38.56	15.88	65.37	200	0	P	H
		17355	47.76	-20.44	68.2	50.9	40.69	19.91	64.11	100	0	P	H
													H
													H
		11570	56.09	-17.91	74	66.74	38.56	15.88	65.37	100	248	P	V
		11570	44.94	-9.06	54	55.59	38.56	15.88	65.37	100	248	A	V
		17355	49.26	-18.94	68.2	52.4	40.69	19.91	64.11	100	0	P	V
802.11a CH 165 5825MHz		11650	48.42	-25.58	74	58.91	38.61	15.96	65.34	100	0	P	H
		17475	48.12	-20.08	68.2	51.12	40.62	19.95	63.95	100	0	P	H
													H
													H
		11650	55.59	-18.41	74	66.08	38.61	15.96	65.34	100	243	P	V
		11650	44.62	-9.38	54	55.11	38.61	15.96	65.34	100	243	A	V
		17475	48.79	-19.41	68.2	51.79	40.62	19.95	63.95	100	0	P	V
Remark	1. No other spurious found. 2. All results are PASS against Peak and Average limit line.												



Band 4 5725~5850MHz
WIFI 802.11n HT20 (Band Edge @ 3m)

WIFI Ant. 1+2	Note	Frequency (MHz)	Level (dBμV/m)	Over Limit (dB)	Limit Line (dBμV/m)	Read Level (dBμV)	Antenna Factor (dB/m)	Cable Loss (dB)	Preamp Factor (dB)	Ant Pos (cm)	Table Pos (deg)	Peak Avg. (P/A)	Pol. (H/V)	
802.11n HT20 CH 149 5745MHz		5646.4	49.59	-18.61	68.2	40.34	32.73	9.62	33.1	100	236	P	H	
		5699.6	55.21	-49.7	104.91	45.7	32.86	9.77	33.12	100	236	P	H	
		5720	64.35	-46.45	110.8	54.72	32.94	9.82	33.13	100	236	P	H	
		5724.8	78.88	-42.86	121.74	69.25	32.94	9.82	33.13	100	236	P	H	
	*	5745	110.54	-	-	100.84	32.98	9.87	33.15	100	236	P	H	
	*	5745	103.01	-	-	93.31	32.98	9.87	33.15	100	236	A	H	
														H
														H
			5650	50.58	-17.62	68.2	41.29	32.77	9.62	33.1	315	85	P	V
			5688	52.04	-44.31	96.35	42.58	32.86	9.72	33.12	315	85	P	V
			5715.6	65.34	-44.23	109.57	55.8	32.9	9.77	33.13	315	85	P	V
			5723	69.44	-48.2	117.64	59.81	32.94	9.82	33.13	315	85	P	V
	*		5745	110.83	-	-	101.13	32.98	9.87	33.15	315	85	P	V
	*		5745	103.6	-	-	93.9	32.98	9.87	33.15	315	85	A	V
														V
													V	



WIFI Ant. 1+2	Note	Frequency (MHz)	Level (dBμV/m)	Over Limit (dB)	Limit Line (dBμV/m)	Read Level (dBμV)	Antenna Factor (dB/m)	Cable Loss (dB)	Preamp Factor (dB)	Ant Pos (cm)	Table Pos (deg)	Peak Avg. (P/A)	Pol. (H/V)	
802.11n HT20 CH 157 5785MHz		5646.6	49.86	-18.34	68.2	40.61	32.73	9.62	33.1	105	222	P	H	
		5654	49.63	-21.54	71.17	40.35	32.77	9.62	33.11	105	222	P	H	
		5703.4	51.02	-55.13	106.15	41.47	32.9	9.77	33.12	105	222	P	H	
		5721.8	49.69	-65.21	114.9	40.06	32.94	9.82	33.13	105	222	P	H	
	*	5785	109.52	-	-	99.66	33.06	9.97	33.17	105	222	P	H	
	*	5785	102.36	-	-	92.5	33.06	9.97	33.17	105	222	A	H	
		5854.6	50.7	-61.01	111.71	40.6	33.27	10.02	33.19	105	222	P	H	
		5869.8	51.25	-55.4	106.65	41.17	33.27	10.02	33.21	105	222	P	H	
		5919.8	51.04	-20.99	72.03	40.86	33.39	10.02	33.23	105	222	P	H	
		5946.6	50.18	-18.02	68.2	39.92	33.48	10.02	33.24	105	222	P	H	
														H
														H
			5640.6	49.62	-18.58	68.2	40.41	32.73	9.58	33.1	341	85	P	V
			5670.6	50.97	-32.51	83.48	41.6	32.81	9.67	33.11	341	85	P	V
			5701.8	50.34	-55.36	105.7	40.79	32.9	9.77	33.12	341	85	P	V
			5724.8	49.4	-72.34	121.74	39.77	32.94	9.82	33.13	341	85	P	V
	*		5785	110.98	-	-	101.12	33.06	9.97	33.17	341	85	P	V
	*		5785	103.49	-	-	93.63	33.06	9.97	33.17	341	85	A	V
			5853.8	50.9	-62.64	113.54	40.8	33.27	10.02	33.19	341	85	P	V
			5860.6	51.08	-58.15	109.23	41	33.27	10.02	33.21	341	85	P	V
		5877.4	50.69	-52.73	103.42	40.57	33.31	10.02	33.21	341	85	P	V	
		5931	50.49	-17.71	68.2	40.27	33.43	10.02	33.23	341	85	P	V	
													V	
													V	



WiFi Ant. 1+2	Note	Frequency (MHz)	Level (dBμV/m)	Over Limit (dB)	Limit Line (dBμV/m)	Read Level (dBμV)	Antenna Factor (dB/m)	Cable Loss (dB)	Preamp Factor (dB)	Ant Pos (cm)	Table Pos (deg)	Peak Avg. (P/A)	Pol. (H/V)	
802.11n HT20 CH 165 5825MHz	*	5825	108.92	-	-	98.89	33.19	10.02	33.18	102	218	P	H	
	*	5825	101.73	-	-	91.7	33.19	10.02	33.18	102	218	A	H	
		5851	64.57	-55.35	119.92	54.51	33.23	10.02	33.19	102	218	P	H	
		5855	58.46	-52.34	110.8	48.36	33.27	10.02	33.19	102	218	P	H	
		5891	53.32	-40.01	93.33	43.17	33.35	10.02	33.22	102	218	P	H	
		5948.4	50.06	-18.14	68.2	39.8	33.48	10.02	33.24	102	218	P	H	
														H
														H
	*	5825	109.97	-	-	99.94	33.19	10.02	33.18	338	83	P	V	
	*	5825	102.57	-	-	92.54	33.19	10.02	33.18	338	83	A	V	
		5850	59.08	-63.12	122.2	49.02	33.23	10.02	33.19	338	83	P	V	
		5860	60.1	-49.3	109.4	50.02	33.27	10.02	33.21	338	83	P	V	
		5875.2	51.16	-53.89	105.05	41.04	33.31	10.02	33.21	338	83	P	V	
		5939.6	50.04	-18.16	68.2	39.78	33.48	10.02	33.24	338	83	P	V	
														V
													V	
Remark	1. No other spurious found. 2. All results are PASS against Peak and Average limit line.													



Band 4 5725~5850MHz
WIFI 802.11n HT20 (Harmonic @ 3m)

WIFI Ant. 1+2	Note	Frequency (MHz)	Level (dBμV/m)	Over Limit (dB)	Limit Line (dBμV/m)	Read Level (dBμV)	Antenna Factor (dB/m)	Cable Loss (dB)	Preamp Factor (dB)	Ant Pos (cm)	Table Pos (deg)	Peak Avg. (P/A)	Pol. (H/V)
802.11n HT20 CH 149 5745MHz		11490	51.48	-22.52	74	62.26	38.52	15.81	65.39	100	319	P	H
		11490	40.21	-13.79	54	50.99	38.52	15.81	65.39	100	319	A	H
		17235	48.58	-19.62	68.2	51.87	40.76	19.86	64.27	100	0	P	H
													H
		11490	53.41	-20.59	74	64.19	38.52	15.81	65.39	100	250	P	V
		11490	42.55	-11.45	54	53.33	38.52	15.81	65.39	100	250	A	V
		17235	50.53	-17.67	68.2	53.82	40.76	19.86	64.27	100	0	P	V
													V
802.11n HT20 CH 157 5785MHz		11570	48.95	-25.05	74	59.6	38.56	15.88	65.37	100	0	P	H
		17355	47.77	-20.43	68.2	50.91	40.69	19.91	64.11	100	0	P	H
													H
													H
		11570	54.68	-19.32	74	65.33	38.56	15.88	65.37	100	249	P	V
		11570	44.11	-9.89	54	54.76	38.56	15.88	65.37	100	249	A	V
		17355	48.48	-19.72	68.2	51.62	40.69	19.91	64.11	100	0	P	V
													V
802.11n HT20 CH 165 5825MHz		11650	50.49	-23.51	74	60.98	38.61	15.96	65.34	200	0	P	H
		17475	49.05	-19.15	68.2	52.05	40.62	19.95	63.95	100	0	P	H
													H
													H
		11650	55.3	-18.7	74	65.79	38.61	15.96	65.34	100	0	P	V
		11650	44.28	-9.72	54	54.77	38.61	15.96	65.34	100	0	A	V
		17475	48.66	-19.54	68.2	51.66	40.62	19.95	63.95	100	0	P	V
													V
Remark	1. No other spurious found. 2. All results are PASS against Peak and Average limit line.												



Band 4 5725~5850MHz
WIFI 802.11n HT40 (Band Edge @ 3m)

WIFI Ant. 1+2	Note	Frequency (MHz)	Level (dBμV/m)	Over Limit (dB)	Limit Line (dBμV/m)	Read Level (dBμV)	Antenna Factor (dB/m)	Cable Loss (dB)	Preamp Factor (dB)	Ant Pos (cm)	Table Pos (deg)	Peak Avg. (P/A)	Pol. (H/V)
		5649.8	49.96	-18.24	68.2	40.67	32.77	9.62	33.1	105	239	P	H
		5695	57.67	-43.84	101.51	48.21	32.86	9.72	33.12	105	239	P	H
		5713.8	70.83	-38.24	109.07	61.29	32.9	9.77	33.13	105	239	P	H
		5724.2	76.11	-44.27	120.38	66.48	32.94	9.82	33.13	105	239	P	H
	*	5755	106.35	-	-	96.56	33.02	9.92	33.15	105	239	P	H
	*	5755	99.09	-	-	89.3	33.02	9.92	33.15	105	239	A	H
		5851.2	51.06	-68.4	119.46	41	33.23	10.02	33.19	105	239	P	H
		5868.4	49.78	-57.27	107.05	39.7	33.27	10.02	33.21	105	239	P	H
		5921.8	51.07	-19.49	70.56	40.85	33.43	10.02	33.23	105	239	P	H
		5925.2	49.57	-18.63	68.2	39.35	33.43	10.02	33.23	105	239	P	H
802.11n													H
HT40													H
CH 151		5630.4	50.22	-17.98	68.2	41.05	32.69	9.58	33.1	349	85	P	V
5755MHz		5689.8	56.22	-41.46	97.68	46.76	32.86	9.72	33.12	349	85	P	V
		5712.2	66.08	-42.54	108.62	56.54	32.9	9.77	33.13	349	85	P	V
		5724.6	67.14	-54.15	121.29	57.51	32.94	9.82	33.13	349	85	P	V
	*	5755	107.42	-	-	97.63	33.02	9.92	33.15	349	85	P	V
	*	5755	99.93	-	-	90.14	33.02	9.92	33.15	349	85	A	V
		5854	51.2	-61.88	113.08	41.1	33.27	10.02	33.19	349	85	P	V
		5856	50.9	-59.62	110.52	40.8	33.27	10.02	33.19	349	85	P	V
		5899.8	50.95	-35.86	86.81	40.8	33.35	10.02	33.22	349	85	P	V
		5942.4	50.22	-17.98	68.2	39.96	33.48	10.02	33.24	349	85	P	V
													V
													V



WIFI Ant. 1+2	Note	Frequency (MHz)	Level (dBμV/m)	Over Limit (dB)	Limit Line (dBμV/m)	Read Level (dBμV)	Antenna Factor (dB/m)	Cable Loss (dB)	Preamp Factor (dB)	Ant Pos (cm)	Table Pos (deg)	Peak Avg. (P/A)	Pol. (H/V)
		5610	49.17	-19.03	68.2	40.07	32.65	9.53	33.08	100	237	P	H
		5699.2	50.59	-54.02	104.61	41.13	32.86	9.72	33.12	100	237	P	H
		5708.4	51.35	-56.2	107.55	41.81	32.9	9.77	33.13	100	237	P	H
		5720.6	53.71	-58.46	112.17	44.08	32.94	9.82	33.13	100	237	P	H
	*	5795	106.35	-	-	96.41	33.1	10.01	33.17	100	237	P	H
	*	5795	99	-	-	89.06	33.1	10.01	33.17	100	237	A	H
		5850	53.6	-68.6	122.2	43.54	33.23	10.02	33.19	100	237	P	H
		5865.6	56.7	-51.13	107.83	46.62	33.27	10.02	33.21	100	237	P	H
		5877.4	52.04	-51.38	103.42	41.92	33.31	10.02	33.21	100	237	P	H
		5928.4	50.3	-17.9	68.2	40.08	33.43	10.02	33.23	100	237	P	H
802.11n													H
HT40													H
CH 159		5633	49.74	-18.46	68.2	40.53	32.73	9.58	33.1	364	86	P	V
5795MHz		5651.8	51.27	-18.27	69.54	41.98	32.77	9.62	33.1	364	86	P	V
		5710.6	51.79	-56.38	108.17	42.25	32.9	9.77	33.13	364	86	P	V
		5724.2	52.67	-67.71	120.38	43.04	32.94	9.82	33.13	364	86	P	V
	*	5795	107.45	-	-	97.51	33.1	10.01	33.17	364	86	P	V
	*	5795	99.85	-	-	89.91	33.1	10.01	33.17	364	86	A	V
		5851.6	57.53	-61.02	118.55	47.47	33.23	10.02	33.19	364	86	P	V
		5858.6	56.03	-53.76	109.79	45.95	33.27	10.02	33.21	364	86	P	V
		5893.2	51.78	-39.92	91.7	41.63	33.35	10.02	33.22	364	86	P	V
		5935	50.64	-17.56	68.2	40.43	33.43	10.02	33.24	364	86	P	V
													V
													V
Remark	<ol style="list-style-type: none"> No other spurious found. All results are PASS against Peak and Average limit line. 												



Band 4 5725~5850MHz
WIFI 802.11n HT40 (Harmonic @ 3m)

WIFI Ant. 1+2	Note	Frequency (MHz)	Level (dBμV/m)	Over Limit (dB)	Limit Line (dBμV/m)	Read Level (dBμV)	Antenna Factor (dB/m)	Cable Loss (dB)	Preamp Factor (dB)	Ant Pos (cm)	Table Pos (deg)	Peak Avg. (P/A)	Pol. (H/V)
802.11n HT40 CH 151 5755MHz		11510	46.96	-27.04	74	57.75	38.5	15.83	65.4	100	0	P	H
		17265	49.76	-18.44	68.2	53.01	40.74	19.88	64.23	100	0	P	H
													H
													H
		11510	45.94	-28.06	74	57.01	38.5	15.83	65.4	100	0	P	V
		17265	49.57	-18.63	68.2	52.82	40.74	19.88	64.23	100	0	P	V
													V
													V
802.11n HT40 CH 159 5795MHz		11590	47.28	-26.72	74	57.91	38.57	15.89	65.37	100	0	P	H
		17385	49.05	-19.15	68.2	52.15	40.67	19.92	64.06	100	0	P	H
													H
													H
		11590	47.97	-26.03	74	58.88	38.57	15.89	65.37	100	0	P	V
		17385	49.16	-19.04	68.2	52.26	40.67	19.92	64.06	100	0	P	V
													V
													V
Remark	1. No other spurious found. 2. All results are PASS against Peak and Average limit line.												



Band 4 5725~5850MHz
WIFI 802.11ac VHT20 (Band Edge @ 3m)

WIFI Ant. 1+2	Note	Frequency (MHz)	Level (dBμV/m)	Over Limit (dB)	Limit Line (dBμV/m)	Read Level (dBμV)	Antenna Factor (dB/m)	Cable Loss (dB)	Preamp Factor (dB)	Ant Pos (cm)	Table Pos (deg)	Peak Avg. (P/A)	Pol. (H/V)	
802.11ac VHT20 CH 149 5745MHz		5623.2	49.77	-18.43	68.2	40.63	32.69	9.53	33.08	103	239	P	H	
		5699.8	52.37	-52.68	105.05	42.86	32.86	9.77	33.12	103	239	P	H	
		5719.6	61.79	-48.9	110.69	52.16	32.94	9.82	33.13	103	239	P	H	
		5722.4	77.03	-39.24	116.27	67.4	32.94	9.82	33.13	103	239	P	H	
	*	5745	109.36	-	-	99.66	32.98	9.87	33.15	103	239	P	H	
	*	5745	102.06	-	-	92.36	32.98	9.87	33.15	103	239	A	H	
														H
														H
			5625.8	50.76	-17.44	68.2	41.62	32.69	9.53	33.08	298	83	P	V
			5699.2	52.76	-51.85	104.61	43.3	32.86	9.72	33.12	298	83	P	V
			5715.6	65.96	-43.61	109.57	56.42	32.9	9.77	33.13	298	83	P	V
			5724.8	71.46	-50.28	121.74	61.83	32.94	9.82	33.13	298	83	P	V
	*		5745	110.35	-	-	100.65	32.98	9.87	33.15	298	83	P	V
	*		5745	103.06	-	-	93.36	32.98	9.87	33.15	298	83	A	V
													V	
													V	



WIFI Ant. 1+2	Note	Frequency (MHz)	Level (dBµV/m)	Over Limit (dB)	Limit Line (dBµV/m)	Read Level (dBµV)	Antenna Factor (dB/m)	Cable Loss (dB)	Preamp Factor (dB)	Ant Pos (cm)	Table Pos (deg)	Peak Avg. (P/A)	Pol. (H/V)
		5613.6	50.02	-18.18	68.2	40.92	32.65	9.53	33.08	100	218	P	H
		5685.2	50.42	-43.86	94.28	40.96	32.86	9.72	33.12	100	218	P	H
		5719.4	50.98	-59.65	110.63	41.35	32.94	9.82	33.13	100	218	P	H
		5721.8	50.72	-64.18	114.9	41.09	32.94	9.82	33.13	100	218	P	H
	*	5785	109.72	-	-	99.86	33.06	9.97	33.17	100	218	P	H
	*	5785	101.8	-	-	91.94	33.06	9.97	33.17	100	218	A	H
		5853.6	51.87	-62.12	113.99	41.77	33.27	10.02	33.19	100	218	P	H
		5866.6	51.01	-56.54	107.55	40.93	33.27	10.02	33.21	100	218	P	H
		5915.6	51.02	-24.11	75.13	40.84	33.39	10.02	33.23	100	218	P	H
		5947.2	49.7	-18.5	68.2	39.44	33.48	10.02	33.24	100	218	P	H
													H
													H
802.11ac													
VHT20													
CH 157		5638	49.93	-18.27	68.2	40.72	32.73	9.58	33.1	295	85	P	V
5785MHz		5694	51.69	-49.09	100.78	42.23	32.86	9.72	33.12	295	85	P	V
		5710.6	52.36	-55.81	108.17	42.82	32.9	9.77	33.13	295	85	P	V
		5720.8	51.15	-61.47	112.62	41.52	32.94	9.82	33.13	295	85	P	V
	*	5785	109.45	-	-	99.59	33.06	9.97	33.17	295	85	P	V
	*	5785	101.09	-	-	91.23	33.06	9.97	33.17	295	85	A	V
		5852.2	51.09	-66.09	117.18	41.03	33.23	10.02	33.19	295	85	P	V
		5858.4	51.21	-58.64	109.85	41.13	33.27	10.02	33.21	295	85	P	V
		5895.6	50.49	-39.43	89.92	40.34	33.35	10.02	33.22	295	85	P	V
		5936	50.08	-18.12	68.2	39.87	33.43	10.02	33.24	295	85	P	V
													V
													V
													V



WiFi Ant. 1+2	Note	Frequency (MHz)	Level (dBμV/m)	Over Limit (dB)	Limit Line (dBμV/m)	Read Level (dBμV)	Antenna Factor (dB/m)	Cable Loss (dB)	Preamp Factor (dB)	Ant Pos (cm)	Table Pos (deg)	Peak Avg. (P/A)	Pol. (H/V)	
802.11ac VHT20 CH 165 5825MHz	*	5825	110.14	-	-	100.11	33.19	10.02	33.18	100	212	P	H	
	*	5825	102.36	-	-	92.33	33.19	10.02	33.18	100	212	A	H	
		5854.6	59.35	-52.36	111.71	49.25	33.27	10.02	33.19	100	212	P	H	
		5862.6	60.79	-47.88	108.67	50.71	33.27	10.02	33.21	100	212	P	H	
		5875.4	51.76	-53.14	104.9	41.64	33.31	10.02	33.21	100	212	P	H	
		5939.6	49.88	-18.32	68.2	39.62	33.48	10.02	33.24	100	212	P	H	
														H
														H
	*	5825	109.04	-	-	99.01	33.19	10.02	33.18	281	88	P	V	
	*	5825	101.86	-	-	91.83	33.19	10.02	33.18	281	88	A	V	
		5850	63.82	-58.38	122.2	53.76	33.23	10.02	33.19	281	88	P	V	
		5855.2	60.8	-49.94	110.74	50.7	33.27	10.02	33.19	281	88	P	V	
		5882.4	53.03	-46.67	99.7	42.91	33.31	10.02	33.21	281	88	P	V	
		5946	50.29	-17.91	68.2	40.03	33.48	10.02	33.24	281	88	P	V	
														V
													V	
Remark	1. No other spurious found. 2. All results are PASS against Peak and Average limit line.													



Band 4 5725~5850MHz
WIFI 802.11ac VHT20 (Harmonic @ 3m)

WIFI Ant. 1+2	Note	Frequency (MHz)	Level (dBμV/m)	Over Limit (dB)	Limit Line (dBμV/m)	Read Level (dBμV)	Antenna Factor (dB/m)	Cable Loss (dB)	Preamp Factor (dB)	Ant Pos (cm)	Table Pos (deg)	Peak Avg. (P/A)	Pol. (H/V)	
802.11ac VHT20 CH 149 5745MHz		11490	48.58	-25.42	74	59.36	38.52	15.81	65.39	100	0	P	H	
		17235	49.27	-18.93	68.2	52.56	40.76	19.86	64.27	100	0	P	H	
													H	
													H	
			11490	57.11	-16.89	74	68.17	38.52	15.81	65.39	100	248	P	V
			11490	41.81	-12.19	54	52.87	38.52	15.81	65.39	100	248	A	V
			17235	49.92	-18.28	68.2	53.21	40.76	19.86	64.27	100	0	P	V
													V	
802.11ac VHT20 CH 157 5785MHz		11570	53.3	-20.7	74	63.95	38.56	15.88	65.37	100	325	P	H	
		11570	40.47	-13.53	54	51.12	38.56	15.88	65.37	100	325	A	H	
		17355	47.78	-20.42	68.2	50.92	40.69	19.91	64.11	100	0	P	H	
													H	
			11570	59.94	-14.06	74	70.59	38.56	15.88	65.37	100	246	P	V
			11570	44.08	-9.92	54	54.73	38.56	15.88	65.37	100	246	A	V
			17355	50.16	-18.04	68.2	53.3	40.69	19.91	64.11	100	0	P	V
													V	
802.11ac VHT20 CH 165 5825MHz		11650	50.76	-23.24	74	61.25	38.61	15.96	65.34	100	0	P	H	
		17475	47.84	-20.36	68.2	50.84	40.62	19.95	63.95	100	0	P	H	
													H	
													H	
			11650	56.45	-17.55	74	66.94	38.61	15.96	65.34	100	244	P	V
			11650	43.6	-10.4	54	54.09	38.61	15.96	65.34	100	244	A	V
			17475	47.6	-20.6	68.2	50.6	40.62	19.95	63.95	100	0	P	V
													V	
Remark	1. No other spurious found. 2. All results are PASS against Peak and Average limit line.													



Band 4 5725~5850MHz
WIFI 802.11ac VHT40 (Band Edge @ 3m)

WIFI Ant. 1+2	Note	Frequency (MHz)	Level (dBμV/m)	Over Limit (dB)	Limit Line (dBμV/m)	Read Level (dBμV)	Antenna Factor (dB/m)	Cable Loss (dB)	Preamp Factor (dB)	Ant Pos (cm)	Table Pos (deg)	Peak Avg. (P/A)	Pol. (H/V)	
		5614.4	50.7	-17.5	68.2	41.6	32.65	9.53	33.08	104	238	P	H	
		5698.6	56.77	-47.4	104.17	47.31	32.86	9.72	33.12	104	238	P	H	
		5719.6	70.22	-40.47	110.69	60.59	32.94	9.82	33.13	104	238	P	H	
		5721.4	75.89	-38.1	113.99	66.26	32.94	9.82	33.13	104	238	P	H	
	*	5755	106.42	-	-	96.63	33.02	9.92	33.15	104	238	P	H	
	*	5755	99.05	-	-	89.26	33.02	9.92	33.15	104	238	A	H	
		5850.4	50.81	-70.48	121.29	40.75	33.23	10.02	33.19	104	238	P	H	
		5867	51.99	-55.45	107.44	41.91	33.27	10.02	33.21	104	238	P	H	
		5875.6	50.61	-54.14	104.75	40.49	33.31	10.02	33.21	104	238	P	H	
		5930.2	49.92	-18.28	68.2	39.7	33.43	10.02	33.23	104	238	P	H	
802.11ac VHT40 CH 151 5755MHz													H	
													H	
			5618.6	49.61	-18.59	68.2	40.47	32.69	9.53	33.08	351	85	P	V
			5690.8	56.39	-42.03	98.42	46.93	32.86	9.72	33.12	351	85	P	V
			5715.4	69.36	-40.15	109.51	59.82	32.9	9.77	33.13	351	85	P	V
			5725	69.44	-52.76	122.2	59.81	32.94	9.82	33.13	351	85	P	V
		*	5755	107.3	-	-	97.51	33.02	9.92	33.15	351	85	P	V
		*	5755	99.91	-	-	90.12	33.02	9.92	33.15	351	85	A	V
			5854.2	49.95	-62.67	112.62	39.85	33.27	10.02	33.19	351	85	P	V
			5869	50.05	-56.83	106.88	39.97	33.27	10.02	33.21	351	85	P	V
			5891.8	51.17	-41.56	92.73	41.02	33.35	10.02	33.22	351	85	P	V
			5942	51.77	-16.43	68.2	41.51	33.48	10.02	33.24	351	85	P	V
														V
														V



WIFI Ant. 1+2	Note	Frequency (MHz)	Level (dBμV/m)	Over Limit (dB)	Limit Line (dBμV/m)	Read Level (dBμV)	Antenna Factor (dB/m)	Cable Loss (dB)	Preamp Factor (dB)	Ant Pos (cm)	Table Pos (deg)	Peak Avg. (P/A)	Pol. (H/V)
		5608.4	51.1	-17.1	68.2	42.05	32.65	9.48	33.08	106	224	P	H
		5698	49.89	-53.84	103.73	40.43	32.86	9.72	33.12	106	224	P	H
		5717.2	51.57	-58.45	110.02	42.03	32.9	9.77	33.13	106	224	P	H
		5722.6	53.96	-62.77	116.73	44.33	32.94	9.82	33.13	106	224	P	H
	*	5795	105.94	-	-	96	33.1	10.01	33.17	106	224	P	H
	*	5795	98.68	-	-	88.74	33.1	10.01	33.17	106	224	A	H
		5854.8	53.44	-57.82	111.26	43.34	33.27	10.02	33.19	106	224	P	H
		5862.8	56.35	-52.26	108.61	46.27	33.27	10.02	33.21	106	224	P	H
		5877.2	51.4	-52.17	103.57	41.28	33.31	10.02	33.21	106	224	P	H
		5930	50.58	-17.62	68.2	40.36	33.43	10.02	33.23	106	224	P	H
802.11ac													H
VHT40													H
CH 159		5650	49.74	-18.46	68.2	40.45	32.77	9.62	33.1	346	85	P	V
5795MHz		5650.2	50.52	-17.83	68.35	41.23	32.77	9.62	33.1	346	85	P	V
		5715.4	52.03	-57.48	109.51	42.49	32.9	9.77	33.13	346	85	P	V
		5721.6	50.94	-63.51	114.45	41.31	32.94	9.82	33.13	346	85	P	V
	*	5795	106.78	-	-	96.84	33.1	10.01	33.17	346	85	P	V
	*	5795	99.43	-	-	89.49	33.1	10.01	33.17	346	85	A	V
		5851.2	55.25	-64.21	119.46	45.19	33.23	10.02	33.19	346	85	P	V
		5856.6	53.41	-56.94	110.35	43.31	33.27	10.02	33.19	346	85	P	V
		5878	51.55	-51.42	102.97	41.43	33.31	10.02	33.21	346	85	P	V
		5944.6	49.6	-18.6	68.2	39.34	33.48	10.02	33.24	346	85	P	V
													V
													V
Remark	1. No other spurious found. 2. All results are PASS against Peak and Average limit line.												



Band 4 5725~5850MHz
WIFI 802.11ac VHT40 (Harmonic @ 3m)

WIFI Ant. 1+2	Note	Frequency (MHz)	Level (dBμV/m)	Over Limit (dB)	Limit Line (dBμV/m)	Read Level (dBμV)	Antenna Factor (dB/m)	Cable Loss (dB)	Preamp Factor (dB)	Ant Pos (cm)	Table Pos (deg)	Peak Avg. (P/A)	Pol. (H/V)	
802.11ac VHT40 CH 151 5755MHz		11510	46.98	-27.02	74	57.77	38.5	15.83	65.4	100	0	P	H	
		17265	48.83	-19.37	68.2	52.08	40.74	19.88	64.23	100	0	P	H	
													H	
													H	
			11510	46.85	-27.15	74	57.92	38.5	15.83	65.4	100	0	P	V
			17265	50.4	-17.8	68.2	53.65	40.74	19.88	64.23	100	0	P	V
														V
802.11ac VHT40 CH 159 5795MHz		11590	46.96	-27.04	74	57.59	38.57	15.89	65.37	100	0	P	H	
		17385	48.17	-20.03	68.2	51.27	40.67	19.92	64.06	100	0	P	H	
													H	
													H	
			11590	47.34	-26.66	74	58.25	38.57	15.89	65.37	100	0	P	V
			17385	48.1	-20.1	68.2	51.2	40.67	19.92	64.06	100	0	P	V
														V
Remark	1. No other spurious found.													
	2. All results are PASS against Peak and Average limit line.													



Band 4 5725~5850MHz
WIFI 802.11ac VHT80 (Band Edge @ 3m)

WIFI Ant. 1+2	Note	Frequency (MHz)	Level (dBμV/m)	Over Limit (dB)	Limit Line (dBμV/m)	Read Level (dBμV)	Antenna Factor (dB/m)	Cable Loss (dB)	Preamp Factor (dB)	Ant Pos (cm)	Table Pos (deg)	Peak Avg. (P/A)	Pol. (H/V)	
		5647.2	54.43	-13.77	68.2	45.18	32.73	9.62	33.1	100	237	P	H	
		5699.6	65.53	-39.38	104.91	56.02	32.86	9.77	33.12	100	237	P	H	
		5718.2	67.75	-42.55	110.3	58.12	32.94	9.82	33.13	100	237	P	H	
		5723.4	69.74	-48.81	118.55	60.11	32.94	9.82	33.13	100	237	P	H	
	*	5775	103.15	-	-	93.28	33.06	9.97	33.16	100	237	P	H	
	*	5775	95.55	-	-	85.68	33.06	9.97	33.16	100	237	A	H	
		5852.4	65.41	-51.32	116.73	55.35	33.23	10.02	33.19	100	237	P	H	
		5860	65.52	-43.88	109.4	55.44	33.27	10.02	33.21	100	237	P	H	
		5881	59.77	-40.97	100.74	49.65	33.31	10.02	33.21	100	237	P	H	
		5935.4	50.48	-17.72	68.2	40.27	33.43	10.02	33.24	100	237	P	H	
802.11ac VHT80 CH 155 5775MHz													H	
													H	
			5634	51.97	-16.23	68.2	42.76	32.73	9.58	33.1	350	85	P	V
			5691	61	-37.56	98.56	51.54	32.86	9.72	33.12	350	85	P	V
			5718.2	67.7	-42.6	110.3	58.07	32.94	9.82	33.13	350	85	P	V
			5723	64.8	-52.84	117.64	55.17	32.94	9.82	33.13	350	85	P	V
		*	5775	103.27	-	-	93.4	33.06	9.97	33.16	350	85	P	V
		*	5775	95.66	-	-	85.79	33.06	9.97	33.16	350	85	A	V
			5852.4	67.05	-49.68	116.73	56.99	33.23	10.02	33.19	350	85	P	V
			5855.2	64.76	-45.98	110.74	54.66	33.27	10.02	33.19	350	85	P	V
			5876.6	57.29	-46.72	104.01	47.17	33.31	10.02	33.21	350	85	P	V
			5936.8	50.19	-18.01	68.2	39.98	33.43	10.02	33.24	350	85	P	V
														V
														V
	Remark	1. No other spurious found.												
		2. All results are PASS against Peak and Average limit line.												



Band 4 5725~5850MHz

WIFI 802.11ac VHT80 (Harmonic @ 3m)

WIFI Ant. 1+2	Note	Frequency (MHz)	Level (dBμV/m)	Over Limit (dB)	Limit Line (dBμV/m)	Read Level (dBμV)	Antenna Factor (dB/m)	Cable Loss (dB)	Preamp Factor (dB)	Ant Pos (cm)	Table Pos (deg)	Peak Avg. (P/A)	Pol. (H/V)	
802.11ac VHT80 CH 155 5775MHz		11550	45.96	-28.04	74	56.66	38.54	15.86	65.38	100	0	P	H	
		17325	48.48	-19.72	68.2	51.67	40.71	19.89	64.16	100	0	P	H	
													H	
													H	
			11550	48.05	-25.95	74	59.03	38.54	15.86	65.38	100	0	P	V
			17325	49.33	-18.87	68.2	52.52	40.71	19.89	64.16	100	0	P	V
														V
														V
Remark	1. No other spurious found. 2. All results are PASS against Peak and Average limit line.													



Emission below 1GHz

5GHz WIFI 802.11ac VHT80 (LF @ 3m)

WIFI	Note	Frequency	Level	Over	Limit	Read	Antenna	Cable	Preamp	Ant	Table	Peak	Pol.	
Ant.				Limit	Line	Level	Factor	Loss	Factor	Pos	Pos	Avg.		
1+2		(MHz)	(dBμV/m)	(dB)	(dBμV/m)	(dBμV)	(dB/m)	(dB)	(dB)	(cm)	(deg)	(P/A)	(H/V)	
5GHz 802.11ac VHT80 LF		174.18	28.11	-15.39	43.5	43.56	15.18	1.69	32.41			P	H	
		224.4	30.74	-15.26	46	45.59	15.6	1.88	32.39			P	H	
		263.01	28.42	-17.58	46	39.03	19.65	2.04	32.38			P	H	
		461.7	32.94	-13.06	46	39.09	23.42	2.75	32.36			P	H	
		558.3	29.91	-16.09	46	33.09	26.18	2.98	32.43			P	H	
		909.7	33.25	-12.75	46	31.51	29.35	3.8	31.57	152	251	P	H	
													H	
													H	
													H	
													H	
													H	
													H	
													H	
													H	
													H	
													H	
													H	
			43.5	33.83	-6.17	40	48.19	17.19	0.94	32.49	199	311	P	V
			127.2	25.72	-17.78	43.5	39.18	17.56	1.39	32.46			P	V
		189.3	27.73	-15.77	43.5	43.58	14.75	1.72	32.4			P	V	
		461.7	30.32	-15.68	46	36.47	23.42	2.75	32.36			P	V	
		636	30.69	-15.31	46	33.42	26.47	3.16	32.46			P	V	
		853.7	35.26	-10.74	46	34.08	29.26	3.67	31.9			P	V	
													V	
													V	
													V	
													V	
													V	
													V	
													V	
Remark	1. No other spurious found. 2. All results are PASS against limit line.													



Note symbol

*	Fundamental Frequency which can be ignored. However, the level of any unwanted emissions shall not exceed the level of the fundamental frequency.
!	Test result is over limit line.
P/A	Peak or Average
H/V	Horizontal or Vertical



A calculation example for radiated spurious emission is shown as below:

WIFI	Note	Frequency	Level	Over	Limit	Read	Antenna	Cable	Preamp	Ant	Table	Peak	Pol.
Ant.				Limit	Line	Level	Factor	Loss	Factor	Pos	Pos	Avg.	
1+2		(MHz)	(dBμV/m)	(dB)	(dBμV/m)	(dBμV)	(dB/m)	(dB)	(dB)	(cm)	(deg)	(P/A)	(H/V)
802.11b		2390	55.45	-18.55	74	54.51	32.22	4.58	35.86	103	308	P	H
CH 01													
2412MHz		2390	43.54	-10.46	54	42.6	32.22	4.58	35.86	103	308	A	H

- Level(dBμV/m) =
Antenna Factor(dB/m) + Cable Loss(dB) + Read Level(dBμV) - Preamp Factor(dB)
- Over Limit(dB) = Level(dBμV/m) – Limit Line(dBμV/m)

For Peak Limit @ 2390MHz:

- Level(dBμV/m)
= Antenna Factor(dB/m) + Cable Loss(dB) + Read Level(dBμV) - Preamp Factor(dB)
= 32.22(dB/m) + 4.58(dB) + 54.51(dBμV) – 35.86 (dB)
= 55.45 (dBμV/m)
- Over Limit(dB)
= Level(dBμV/m) – Limit Line(dBμV/m)
= 55.45(dBμV/m) – 74(dBμV/m)
= -18.55(dB)

For Average Limit @ 2390MHz:

- Level(dBμV/m)
= Antenna Factor(dB/m) + Cable Loss(dB) + Read Level(dBμV) - Preamp Factor(dB)
= 32.22(dB/m) + 4.58(dB) + 42.6(dBμV) – 35.86 (dB)
= 43.54 (dBμV/m)
- Over Limit(dB)
= Level(dBμV/m) – Limit Line(dBμV/m)
= 43.54(dBμV/m) – 54(dBμV/m)
= -10.46(dB)

Both peak and average measured complies with the limit line, so test result is “PASS”.



Appendix C. Radiated Spurious Emission Plots

Test Engineer :	J.C. Liang, Jacky Hung, and Kan Wu	Temperature :	18~22°C
		Relative Humidity :	55~58%

Note symbol

-L	Low channel location
-R	High channel location

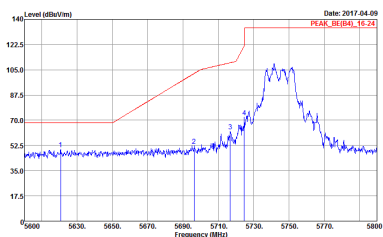
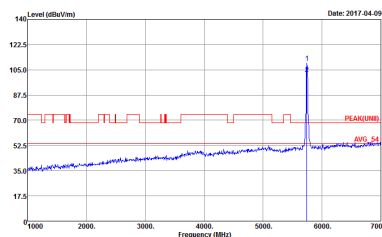

Band 4 - 5725~5850MHz
WIFI 802.11a (Band Edge @ 3m)

WIFI	Band 4 5725~5850MHz Band Edge @ 3m	
ANT	802.11a CH149 5745MHz	
1+2	Horizontal	Fundamental
<p>Peak</p>	 <p>Site : 03CH11-4Y Condition : PEAK_BE(B4)_16-24 3m HORN 9120D-HF HORIZONTAL : RBW:1000.000KHz VBW:3000.000KHz SWT:Auto</p>	 <p>Site : 03CH11-4Y Condition : PEAK(UWB) 3m HORN 9120D-HF HORIZONTAL : RBW:1000.000KHz VBW:3000.000KHz SWT:Auto</p>



WIFI	Band 4 5725~5850MHz Band Edge @ 3m	
ANT	802.11a CH149 5745MHz	
1+2	Vertical	Fundamental
Peak	<p>Site : 03CH11-HY Condition : PEAK_BE(B4)_16-24 3m HORN 9120D-HF VERTICAL : RBW:1000.000KHz VBW:3000.000KHz SWT:Auto</p>	<p>Site : 03CH11-HY Condition : PEAK(UNIT) 3m HORN 9120D-HF VERTICAL : RBW:1000.000KHz VBW:3000.000KHz SWT:Auto</p>



WIFI	Band 4 5725~5850MHz Band Edge @ 3m	
ANT	802.11a CH157 5785MHz	
1+2	Horizontal	Fundamental
Peak	<p>Site : 03CH11-HY Condition : PEAK_BE(B4)_16-24 3m HORN 9120D-HF HORIZONTAL : RBW:1000.000KHz VBW:3000.000KHz SWT:Auto</p>	<p>Site : 03CH11-HY Condition : PEAK(UNIT) 3m HORN 9120D-HF HORIZONTAL : RBW:1000.000KHz VBW:3000.000KHz SWT:Auto</p>
Peak	<p>Site : 03CH11-HY Condition : PEAK_BE(B4)_16-24 3m HORN 9120D-HF HORIZONTAL : RBW:1000.000KHz VBW:3000.000KHz SWT:Auto</p>	Left blank



WIFI	Band 4 5725~5850MHz Band Edge @ 3m	
ANT	802.11a CH157 5785MHz	
1+2	Vertical	Fundamental
Peak	<p>Site : 03CH11-HY Condition : PEAK_BE(B4)_16-24 3m HORN 9120D-HF VERTICAL : RBW:1000.000KHz VBW:3000.000KHz SWT:Auto</p>	<p>Site : 03CH11-HY Condition : PEAK(UNIT) 3m HORN 9120D-HF VERTICAL : RBW:1000.000KHz VBW:3000.000KHz SWT:Auto</p>
Peak	<p>Site : 03CH11-HY Condition : PEAK_BE(B4)_16-24 3m HORN 9120D-HF VERTICAL : RBW:1000.000KHz VBW:3000.000KHz SWT:Auto</p>	Left blank

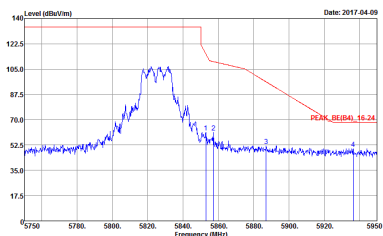
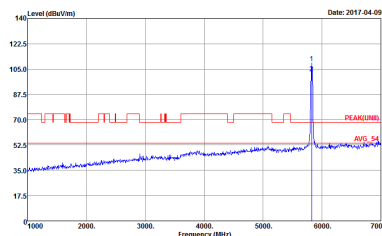

WIFI	Band 4 5725~5850MHz Band Edge @ 3m	
ANT	802.11a CH165 5825MHz	
1+2	Horizontal	Fundamental
Peak	 <p>Site : 03CH11-HY Condition : PEAK_BE(B4)_16-24 3m HORN 9120D-HF HORIZONTAL : RBW:1000.000KHz VBW:3000.000KHz SWT:Auto</p>	 <p>Site : 03CH11-HY Condition : PEAK(UNIT) 3m HORN 9120D-HF HORIZONTAL : RBW:1000.000KHz VBW:3000.000KHz SWT:Auto</p>



WIFI	Band 4 5725~5850MHz Band Edge @ 3m	
ANT	802.11a CH165 5825MHz	
1+2	Vertical	Fundamental
Peak	<p>Site : 03CH11-HY Condition : PEAK_BE(B4)_16-24 3m HORN 9120D-HF VERTICAL : RBW:1000.000KHz VBW:3000.000KHz SWT:Auto</p>	<p>Site : 03CH11-HY Condition : PEAK(UNIT) 3m HORN 9120D-HF VERTICAL : RBW:1000.000KHz VBW:3000.000KHz SWT:Auto</p>



**Band 4 5725~5850MHz
WIFI 802.11n HT20 (Band Edge @ 3m)**

WIFI	Band 4 5725~5850MHz Band Edge @ 3m	
ANT	802.11n HT20 CH149 5745MHz	
1+2	Horizontal	Fundamental
Peak	<p>Site : 03CH11-14Y Condition : PEAK_REF [64]_16-24 3m HORN 9120D-HF HORIZONTAL RBW:1000.000KHz VBW:3000.000KHz SWF:Auto</p>	<p>Site : 03CH11-14Y Condition : PEAK [UMI] 3m HORN 9120D-HF HORIZONTAL RBW:1000.000KHz VBW:3000.000KHz SWF:Auto</p>



WIFI	Band 4 5725~5850MHz Band Edge @ 3m	
ANT	802.11n HT20 CH149 5745MHz	
1+2	Vertical	Fundamental
Peak	<p>Site : 03CH11-HY Condition : PEAK_BE(B4)_16-24 3m HORN 9120D-HF VERTICAL : RBW:1000.000KHz VBW:3000.000KHz SWT:Auto</p>	<p>Site : 03CH11-HY Condition : PEAK(UNIT) 3m HORN 9120D-HF VERTICAL : RBW:1000.000KHz VBW:3000.000KHz SWT:Auto</p>

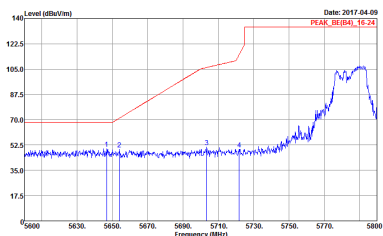
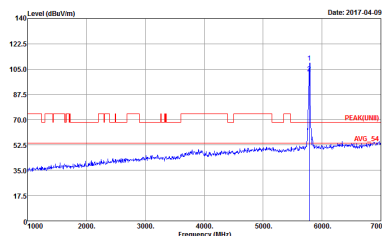
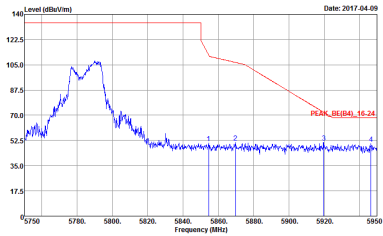

WIFI	Band 4 5725~5850MHz Band Edge @ 3m	
ANT	802.11n HT20 CH157 5785MHz	
1+2	Horizontal	Fundamental
<p>Peak</p>		
<p>Peak</p>		<p>Left blank</p>



WIFI	Band 4 5725~5850MHz Band Edge @ 3m	
ANT	802.11n HT20 CH157 5785MHz	
1+2	Vertical	Fundamental
Peak	<p>Site : 03CH11-HY Condition : PEAK_BE(B4)_16-24 3m HORN 9120D-HF VERTICAL : RBW:1000.000KHz VBW:3000.000KHz SWT:Auto</p>	<p>Site : 03CH11-HY Condition : PEAK(UNIT) 3m HORN 9120D-HF VERTICAL : RBW:1000.000KHz VBW:3000.000KHz SWT:Auto</p>
Peak	<p>Site : 03CH11-HY Condition : PEAK_BE(B4)_16-24 3m HORN 9120D-HF VERTICAL : RBW:1000.000KHz VBW:3000.000KHz SWT:Auto</p>	Left blank



WIFI	Band 4 5725~5850MHz Band Edge @ 3m	
ANT	802.11n HT20 CH165 5825MHz	
1+2	Horizontal	Fundamental
Peak	<p>Site : 03CH11-HY Condition : PEAK_BE(B4)_16-24 3m HORN 9120D-HF HORIZONTAL : RBW:1000.000KHz VBW:3000.000KHz SWT:Auto</p>	<p>Site : 03CH11-HY Condition : PEAK(UNIT) 3m HORN 9120D-HF HORIZONTAL : RBW:1000.000KHz VBW:3000.000KHz SWT:Auto</p>



WIFI	Band 4 5725~5850MHz Band Edge @ 3m	
ANT	802.11n HT20 CH165 5825MHz	
1+2	Vertical	Fundamental
Peak	<p>Site : 03CH11-HY Condition : PEAK_BE(B4)_16-24 3m HORN 9120D-HF VERTICAL : RBW:1000.000KHz VBW:3000.000KHz SWT:Auto</p>	<p>Site : 03CH11-HY Condition : PEAK(UNIT) 3m HORN 9120D-HF VERTICAL : RBW:1000.000KHz VBW:3000.000KHz SWT:Auto</p>



**Band 4 5725~5850MHz
WIFI 802.11n HT40 (Band Edge @ 3m)**

WIFI	Band 4 5725~5850MHz Band Edge @ 3m	
ANT	802.11n HT40 CH151 5755MHz	
1+2	Horizontal	Fundamental
Peak	<p>Site : 03CH11-HY Condition : PEAK_BE(B4)_16-24 3m HORN 9120D-HF HORIZONTAL : RBW:1000.000KHz VBW:3000.000KHz SWT:Auto</p>	<p>Site : 03CH11-HY Condition : PEAK(LINB) 3m HORN 9120D-HF HORIZONTAL : RBW:1000.000KHz VBW:3000.000KHz SWT:Auto</p>
Peak	<p>Site : 03CH11-HY Condition : PEAK_BE(B4)_16-24 3m HORN 9120D-HF HORIZONTAL : RBW:1000.000KHz VBW:3000.000KHz SWT:Auto</p>	Left blank

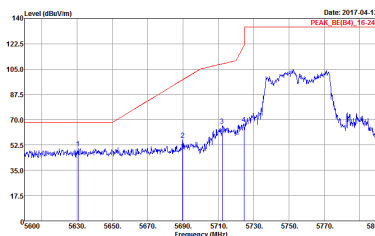
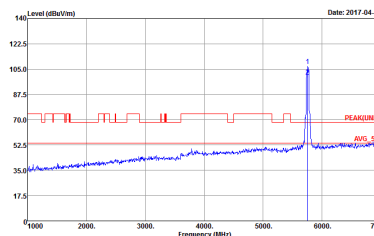
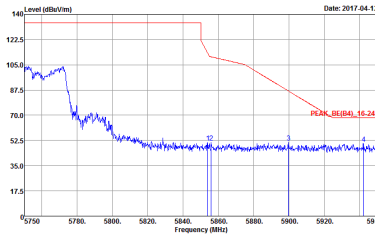

WIFI	Band 4 5725~5850MHz Band Edge @ 3m	
ANT	802.11n HT40 CH151 5755MHz	
1+2	Vertical	Fundamental
Peak	 <p>Site : 03CH11-HY Condition : PEAK_BE(B4)_16-24 3m HORN 9120D-HF VERTICAL : RBW:1000.000KHz VBW:3000.000KHz SWT:Auto</p>	 <p>Site : 03CH11-HY Condition : PEAK(UNIT) 3m HORN 9120D-HF VERTICAL : RBW:1000.000KHz VBW:3000.000KHz SWT:Auto</p>
Peak	 <p>Site : 03CH11-HY Condition : PEAK_BE(B4)_16-24 3m HORN 9120D-HF VERTICAL : RBW:1000.000KHz VBW:3000.000KHz SWT:Auto</p>	Left blank



WIFI	Band 4 5725~5850MHz Band Edge @ 3m	
ANT	802.11n HT40 CH159 5795MHz	
1+2	Horizontal	Fundamental
<p>Peak</p>		
<p>Peak</p>		<p>Left blank</p>



WIFI	Band 4 5725~5850MHz Band Edge @ 3m	
ANT	802.11n HT40 CH159 5795MHz	
1+2	Vertical	Fundamental
Peak	<p>Site : 03CH11-HY Condition : PEAK_BE(B4)_16-24 3m HORN 9120D-HF VERTICAL : RBW:1000.000KHz VBW:3000.000KHz SWT:Auto</p>	<p>Site : 03CH11-HY Condition : PEAK(UNIT) 3m HORN 9120D-HF VERTICAL : RBW:1000.000KHz VBW:3000.000KHz SWT:Auto</p>
Peak	<p>Site : 03CH11-HY Condition : PEAK_BE(B4)_16-24 3m HORN 9120D-HF VERTICAL : RBW:1000.000KHz VBW:3000.000KHz SWT:Auto</p>	Left blank



Band 4 5725~5850MHz
WIFI 802.11ac VHT20 (Band Edge @ 3m)

Table with 2 columns: Horizontal and Fundamental. It contains two spectral plots showing Level (dBm/Vm) vs Frequency (MHz) for a Peak measurement. The left plot is for the Horizontal polarization and the right plot is for the Fundamental polarization. Both plots show a peak at approximately 5745 MHz.



WIFI	Band 4 5725~5850MHz Band Edge @ 3m	
ANT	802.11ac VHT20 CH149 5745MHz	
1+2	Vertical	Fundamental
Peak Avg.	<p>Site : 03CH11-HY Condition : PEAK_BE(B4)_16-24 3m HORN 9120D-HF VERTICAL : RBW:1000.000KHz VBW:3000.000KHz SWT:Auto</p>	<p>Site : 03CH11-HY Condition : PEAK(UNIT) 3m HORN 9120D-HF VERTICAL : RBW:1000.000KHz VBW:3000.000KHz SWT:Auto</p>



WIFI	Band 4 5725~5850MHz Band Edge @ 3m	
ANT	802.11ac VHT20 CH157 5785MHz	
1+2	Horizontal	Fundamental
Peak	<p>Site : 03CH11-HY Condition : PEAK_BE(B4)_16-24 3m HORN 9120D-HF HORIZONTAL : RBW:1000.000KHz VBW:3000.000KHz SWT:Auto</p>	<p>Site : 03CH11-HY Condition : PEAK(UNIT) 3m HORN 9120D-HF HORIZONTAL : RBW:1000.000KHz VBW:3000.000KHz SWT:Auto</p>
Peak	<p>Site : 03CH11-HY Condition : PEAK_BE(B4)_16-24 3m HORN 9120D-HF HORIZONTAL : RBW:1000.000KHz VBW:3000.000KHz SWT:Auto</p>	Left blank



WIFI	Band 4 5725~5850MHz Band Edge @ 3m	
ANT	802.11ac VHT20 CH157 5785MHz	
1+2	Vertical	Fundamental
Peak		
Peak		Left blank



WIFI	Band 4 5725~5850MHz Band Edge @ 3m	
ANT	802.11ac VHT20 CH165 5825MHz	
1+2	Horizontal	Fundamental
Peak	<p>Site : 03CH11-HY Condition : PEAK_BE(B4)_16-24 3m HORN 9120D-HF HORIZONTAL : RBW:1000.000KHz VBW:3000.000KHz SWT:Auto</p>	<p>Site : 03CH11-HY Condition : PEAK(UNIT) 3m HORN 9120D-HF HORIZONTAL : RBW:1000.000KHz VBW:3000.000KHz SWT:Auto</p>



WIFI	Band 4 5725~5850MHz Band Edge @ 3m	
ANT	802.11ac VHT20 CH165 5825MHz	
1+2	Vertical	Fundamental
Peak Avg.	<p>Site : 03CH11-HY Condition : PEAK_BE(B4)_16-24 3m HORN 9120D-HF VERTICAL : RBW:1000.000KHz VBW:3000.000KHz SWT:Auto</p>	<p>Site : 03CH11-HY Condition : PEAK(UNIT) 3m HORN 9120D-HF VERTICAL : RBW:1000.000KHz VBW:3000.000KHz SWT:Auto</p>



Band 4 5725~5850MHz
WIFI 802.11ac VHT40 (Band Edge @ 3m)

WIFI	Band 4 5725~5850MHz Band Edge @ 3m	
ANT	802.11ac VHT40 CH151 5755MHz	
1+2	Horizontal	Fundamental
Peak	<p>Site : 03CH11-HY Condition : PEAK_BE(B4)_16-24 3m HORN 9120D-HF HORIZONTAL : RBW:1000.000KHz VBW:3000.000KHz SWT:Auto</p>	<p>Site : 03CH11-HY Condition : PEAK(LINB) 3m HORN 9120D-HF HORIZONTAL : RBW:1000.000KHz VBW:3000.000KHz SWT:Auto</p>
Peak	<p>Site : 03CH11-HY Condition : PEAK_BE(B4)_16-24 3m HORN 9120D-HF HORIZONTAL : RBW:1000.000KHz VBW:3000.000KHz SWT:Auto</p>	Left blank



WIFI	Band 4 5725~5850MHz Band Edge @ 3m	
ANT	802.11ac VHT40 CH151 5755MHz	
1+2	Vertical	Fundamental
<p>Peak</p>		
<p>Peak</p>		<p>Left blank</p>



WIFI	Band 4 5725~5850MHz Band Edge @ 3m	
ANT	802.11ac VHT40 CH159 5795MHz	
1+2	Horizontal	Fundamental
Peak	<p>Site : 03CH11-HY Condition : PEAK_BE(B4)_16-24 3m HORN 9120D-HF HORIZONTAL : RBW:1000.000KHz VBW:3000.000KHz SWT:Auto</p>	<p>Site : 03CH11-HY Condition : PEAK(UNB) 3m HORN 9120D-HF HORIZONTAL : RBW:1000.000KHz VBW:3000.000KHz SWT:Auto</p>
Peak	<p>Site : 03CH11-HY Condition : PEAK_BE(B4)_16-24 3m HORN 9120D-HF HORIZONTAL : RBW:1000.000KHz VBW:3000.000KHz SWT:Auto</p>	Left blank

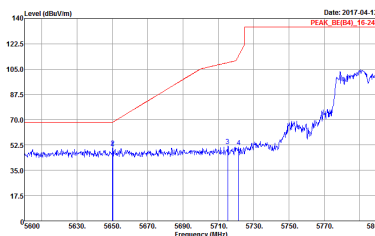
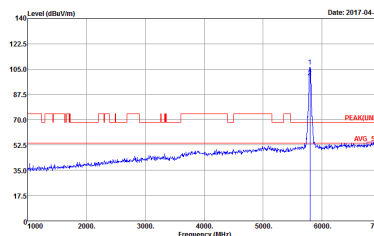
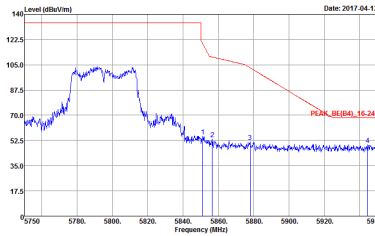

WIFI	Band 4 5725~5850MHz Band Edge @ 3m	
ANT	802.11ac VHT40 CH159 5795MHz	
1+2	Vertical	Fundamental
<p>Peak</p>	 <p>Site : 03CH11-HY Condition : PEAK_BE(B4)_16-24 3m HORN 9120D-HF VERTICAL : RBW:1000.000KHz VBW:3000.000KHz SWT:Auto</p>	 <p>Site : 03CH11-HY Condition : PEAK(UNIT) 3m HORN 9120D-HF VERTICAL : RBW:1000.000KHz VBW:3000.000KHz SWT:Auto</p>
<p>Peak</p>	 <p>Site : 03CH11-HY Condition : PEAK_BE(B4)_16-24 3m HORN 9120D-HF VERTICAL : RBW:1000.000KHz VBW:3000.000KHz SWT:Auto</p>	<p>Left blank</p>



**Band 4 5725~5850MHz
WIFI 802.11ac VHT80 (Band Edge @ 3m)**

WIFI	Band 4 5725~5850MHz Band Edge @ 3m	
ANT	802.11ac VHT80 CH155 5775MHz	
1+2	Horizontal	Fundamental
Peak	<p>Site : 03CH11-HY Condition : PEAK_BE(B4)_16-24 3m HORN 9120D-HF HORIZONTAL : RBW:1000.000KHz VBW:3000.000KHz SWT:Auto</p>	<p>Site : 03CH11-HY Condition : PEAK(LINE) 3m HORN 9120D-HF HORIZONTAL : RBW:1000.000KHz VBW:3000.000KHz SWT:Auto</p>
Peak	<p>Site : 03CH11-HY Condition : PEAK_BE(B4)_16-24 3m HORN 9120D-HF HORIZONTAL : RBW:1000.000KHz VBW:3000.000KHz SWT:Auto</p>	Left blank



WIFI	Band 4 5725~5850MHz Band Edge @ 3m	
ANT	802.11ac VHT80 CH155 5775MHz	
1+2	Vertical	Fundamental
<p>Peak</p>		
<p>Peak</p>		<p>Left blank</p>



Band 4 - 5725~5850MHz
WIFI 802.11a (Harmonic @ 3m)

WIFI	Band 4 5725~5850MHz Harmonic @ 3m	
ANT	802.11a CH149 5745MHz	
1+2	Horizontal	Vertical
Peak Avg.	<p>Site : 03CH11-4Y Condition : PEAK(LINII) 3m 9170 SHF HORM_150809 HORIZONTAL Detector : Peak</p>	<p>Site : 03CH11-4Y Condition : PEAK(LINII) 3m 9170 SHF HORM_150809 VERTICAL Detector : Peak</p>



WIFI	Band 4 5725~5850MHz Harmonic @ 3m	
ANT	802.11a CH157 5785MHz	
1+2	Horizontal	Vertical
Peak Avg.	<p>Site : 03CH11-HY Condition : PEAK(LINEI) 3m 9170 SHF HORM_150809 HORIZONTAL Detector : Peak</p>	<p>Site : 03CH11-HY Condition : PEAK(LINEI) 3m 9170 SHF HORM_150809 VERTICAL Detector : Peak</p>



WIFI	Band 4 5725~5850MHz Harmonic @ 3m	
ANT	802.11a CH165 5825MHz	
1+2	Horizontal	Vertical
Peak Avg.	<p>Site : 03CH11-HY Condition : PEAK(LINII) 3m 9170 SHF HORM_150809 HORIZONTAL Detector : Peak</p>	<p>Site : 03CH11-HY Condition : PEAK(LINII) 3m 9170 SHF HORM_150809 VERTICAL Detector : Peak</p>



Band 4 5725~5850MHz
WIFI 802.11n HT20 (Harmonic @ 3m)

WIFI	Band 4 5725~5850MHz Harmonic @ 3m	
ANT	802.11n HT20 CH149 5745MHz	
1+2	Horizontal	Vertical
Peak Avg.	<p>Site : 03CH11-HY Condition : PEAK(LINE1) 3m 9170 SHF HORM_150809 HORIZONTAL Detector : Peak</p>	<p>Site : 03CH11-HY Condition : PEAK(LINE1) 3m 9170 SHF HORM_150809 VERTICAL Detector : Peak</p>



WIFI	Band 4 5725~5850MHz Harmonic @ 3m	
ANT	802.11n HT20 CH157 5785MHz	
1+2	Horizontal	Vertical
Peak Avg.	<p>Site : 03CHI1-HY Condition : PEAK(LINEI) 3m 9170 SHF HORM_150809 HORIZONTAL Detector : Peak</p>	<p>Site : 03CHI1-HY Condition : PEAK(LINEI) 3m 9170 SHF HORM_150809 VERTICAL Detector : Peak</p>



WIFI	Band 4 5725~5850MHz Harmonic @ 3m	
ANT	802.11n HT20 CH165 5825MHz	
1+2	Horizontal	Vertical
Peak Avg.	<p>Site : 03CH11-HY Condition : PEAK(LINEI) 3m 9170 SHF HORM_150809 HORIZONTAL Detector : Peak</p>	<p>Site : 03CH11-HY Condition : PEAK(LINEI) 3m 9170 SHF HORM_150809 VERTICAL Detector : Peak</p>



**Band 4 5725~5850MHz
WIFI 802.11n HT40 (Harmonic @ 3m)**

WIFI	Band 4 5725~5850MHz Harmonic @ 3m	
ANT	802.11n HT40 CH151 5755MHz	
1+2	Horizontal	Vertical
Peak Avg.	<p>Site : 03CH11-HY Condition : PEAK(LINE1) 3m 9170 SHF HORM_150809 HORIZONTAL Detector : Peak</p>	<p>Site : 03CH11-HY Condition : PEAK(LINE1) 3m 9170 SHF HORM_150809 VERTICAL Detector : Peak</p>



WIFI	Band 4 5725~5850MHz Harmonic @ 3m	
ANT	802.11n HT40 CH159 5795MHz	
1+2	Horizontal	Vertical
Peak Avg.	<p>Site : 03CH11-HY Condition : PEAK(LINII) 3m 9170 SHF HORM_150809 HORIZONTAL Detector : Peak</p>	<p>Site : 03CH11-HY Condition : PEAK(LINII) 3m 9170 SHF HORM_150809 VERTICAL Detector : Peak</p>



Band 4 5725~5850MHz
WIFI 802.11ac VHT20 (Harmonic @ 3m)

WIFI	Band 4 5725~5850MHz Harmonic @ 3m	
ANT	802.11ac VHT20 CH149 5745MHz	
1+2	Horizontal	Vertical
Peak Avg.	<p>Site : 03CH11-HY Condition : PEAK(LINE1) 3m 9170 SHF HORM_150809 HORIZONTAL Detector : Peak</p>	<p>Site : 03CH11-HY Condition : PEAK(LINE1) 3m 9170 SHF HORM_150809 VERTICAL Detector : Peak</p>



WIFI	Band 4 5725~5850MHz Harmonic @ 3m	
ANT	802.11ac VHT20 CH157 5785MHz	
1+2	Horizontal	Vertical
Peak Avg.	<p>Site : 03CH11-HY Condition : PEAK(LINEI) 3m 9170 SHF HORM_150809 HORIZONTAL Detector : Peak</p>	<p>Site : 03CH11-HY Condition : PEAK(LINEI) 3m 9170 SHF HORM_150809 VERTICAL Detector : Peak</p>



WIFI	Band 4 5725~5850MHz Harmonic @ 3m	
ANT	802.11ac VHT20 CH165 5825MHz	
1+2	Horizontal	Vertical
Peak Avg.	<p>Site : 03CH11-HY Condition : PEAK(LINEI) 3m 9170 SHF HORM_150809 HORIZONTAL Detector : Peak</p>	<p>Site : 03CH11-HY Condition : PEAK(LINEI) 3m 9170 SHF HORM_150809 VERTICAL Detector : Peak</p>



**Band 4 5725~5850MHz
WIFI 802.11ac VHT40 (Harmonic @ 3m)**

WIFI	Band 4 5725~5850MHz Harmonic @ 3m	
ANT	802.11ac VHT40 CH151 5755MHz	
1+2	Horizontal	Vertical
Peak Avg.	<p>Site : 03CH11-HY Condition : PEAK(LINE1) 3m 9170 SHF HORM_150809 HORIZONTAL Detector : Peak</p>	<p>Site : 03CH11-HY Condition : PEAK(LINE1) 3m 9170 SHF HORM_150809 VERTICAL Detector : Peak</p>



WIFI	Band 4 5725~5850MHz Harmonic @ 3m	
ANT	802.11ac VHT40 CH159 5795MHz	
1+2	Horizontal	Vertical
Peak Avg.	<p>Site : 03CH11-HY Condition : PEAK(LINEI) 3m 9170 SHF HORM_150809 HORIZONTAL Detector : Peak</p>	<p>Site : 03CH11-HY Condition : PEAK(LINEI) 3m 9170 SHF HORM_150809 VERTICAL Detector : Peak</p>

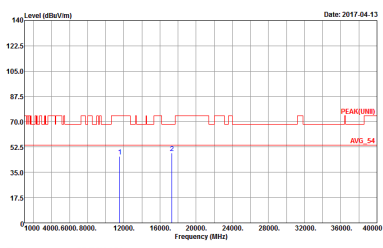
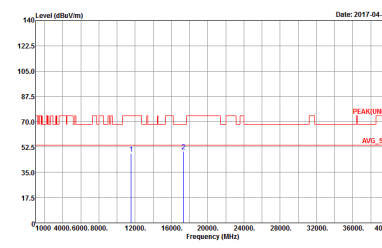

Band 4 5725~5850MHz
WIFI 802.11ac VHT80 (Harmonic @ 3m)

WIFI	Band 4 5725~5850MHz Harmonic @ 3m	
ANT	802.11ac VHT80 CH155 5775MHz	
1+2	Horizontal	Vertical
Peak Avg.	<div style="display: flex; justify-content: space-around;"> <div style="width: 45%;">  <p>Site : 03CH11-HY Condition : PEAK(LINE1) 3m 9170 SHF HORM_150809 HORIZONTAL Detector : Peak</p> </div> <div style="width: 45%;">  <p>Site : 03CH11-HY Condition : PEAK(LINE1) 3m 9170 SHF HORM_150809 VERTICAL Detector : Peak</p> </div> </div>	



Emission below 1GHz
5GHz WIFI 802.11ac VHT80 (LF)

Table with 2 columns: Horizontal and Vertical. It contains two spectral plots showing Level (dBuV/m) vs Frequency (MHz) for 5GHz WIFI 802.11ac VHT80 (LF). The plots include a red QP line and a blue signal line. Metadata for both plots includes Site: 03CH11-HY, Condition: QP 3m BE-LOG 6111D-LF_ETC, and Project: 733129.



Appendix D. Duty Cycle Plots

Antenna	Band	Duty Cycle(%)	T(us)	1/T(kHz)	VBW Setting
1+2	5GHz 802.11a for Ant 1	94.853	2064	0.484	1kHz
1+2	5GHz 802.11a for Ant 2	94.853	2064	0.484	1kHz
1+2	5GHz 802.11n HT20 for Ant 1	94.531	1936	0.517	1kHz
1+2	5GHz 802.11n HT20 for Ant 2	94.488	1920	0.521	1kHz
1+2	5GHz 802.11n HT40 for Ant 1	89.623	950	1.053	3kHz
1+2	5GHz 802.11n HT40 for Ant 2	89.524	940	1.064	3kHz
1+2	5GHz 802.11ac VHT20 for Ant 1	94.531	1936	0.517	1kHz
1+2	5GHz 802.11ac VHT20 for Ant 2	94.531	1936	0.517	1kHz
1+2	5GHz 802.11ac VHT40 for Ant 1	89.720	960	1.042	3kHz
1+2	5GHz 802.11ac VHT40 for Ant 2	90.476	950	1.053	3kHz
1+2	5GHz 802.11ac VHT80 for Ant 1	85.714	648	1.543	3kHz
1+2	5GHz 802.11ac VHT80 for Ant 2	86.400	648	1.543	3kHz



<MIMO Ant. 1>

802.11a

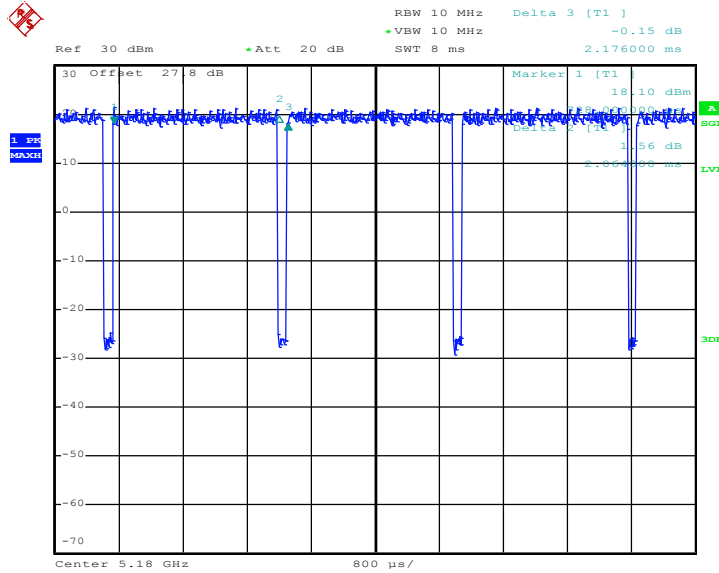

Date: 1.APR.2017 19:33:45

802.11n HT20

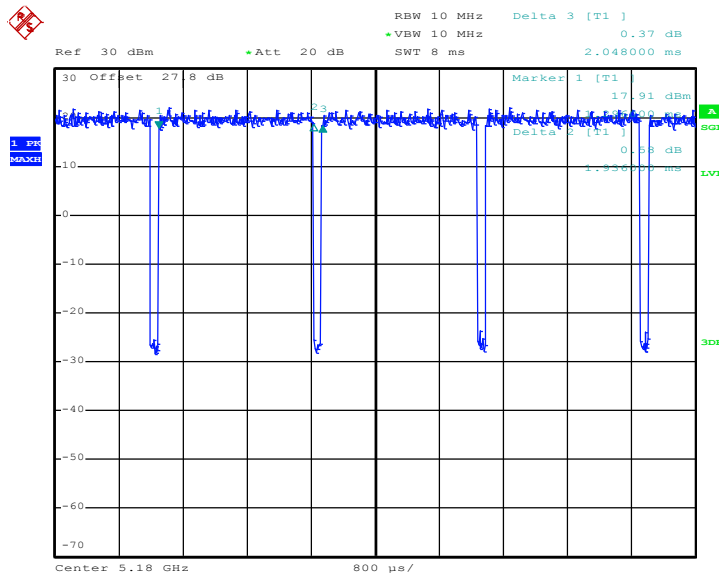

Date: 1.APR.2017 20:13:22



802.11n HT40

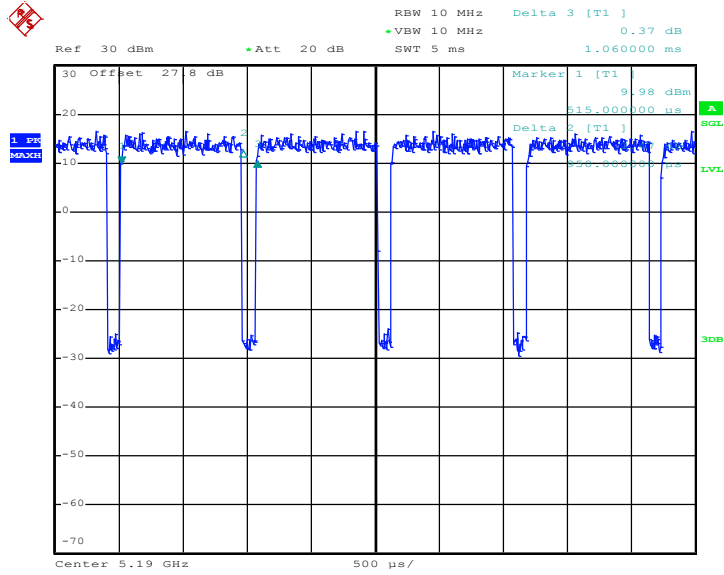

Date: 1.APR.2017 20:44:09

802.11ac VHT20

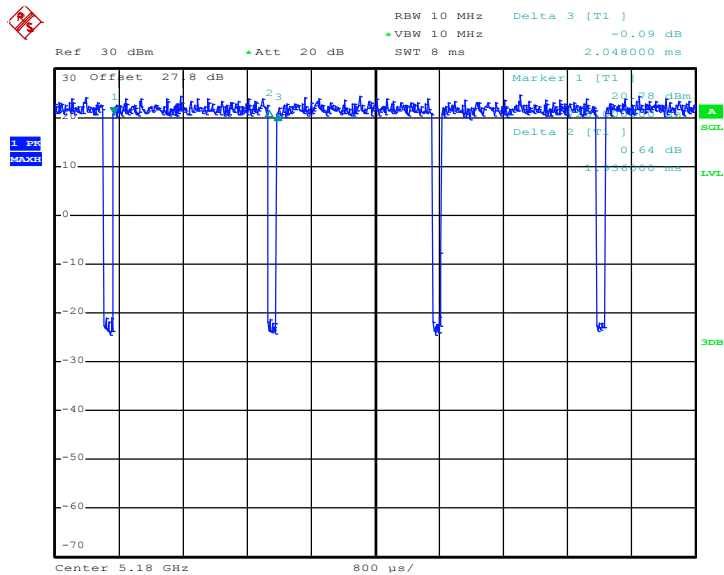

Date: 3.APR.2017 09:32:12



802.11ac VHT40

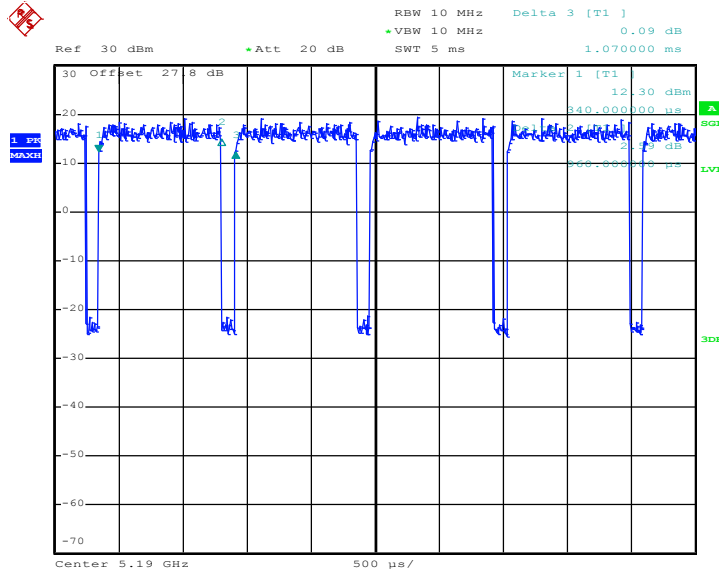

Date: 3.APR.2017 10:29:13

802.11ac VHT80

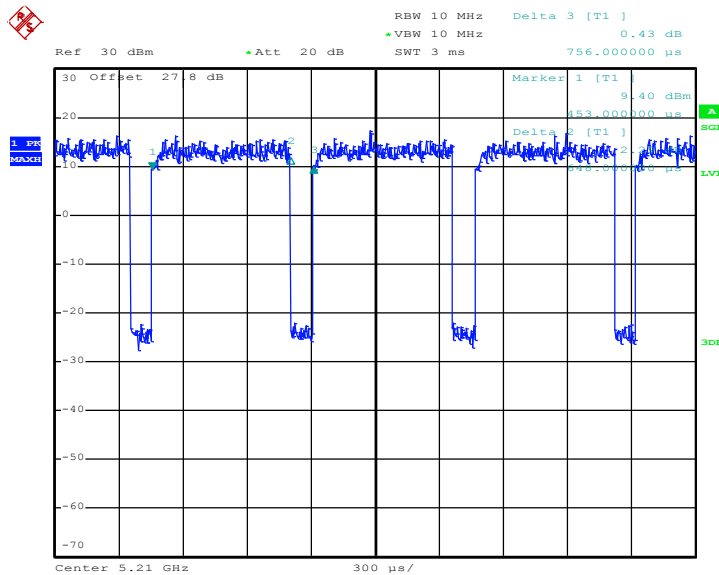

Date: 3.APR.2017 11:15:33



<MIMO Ant. 2>

802.11a

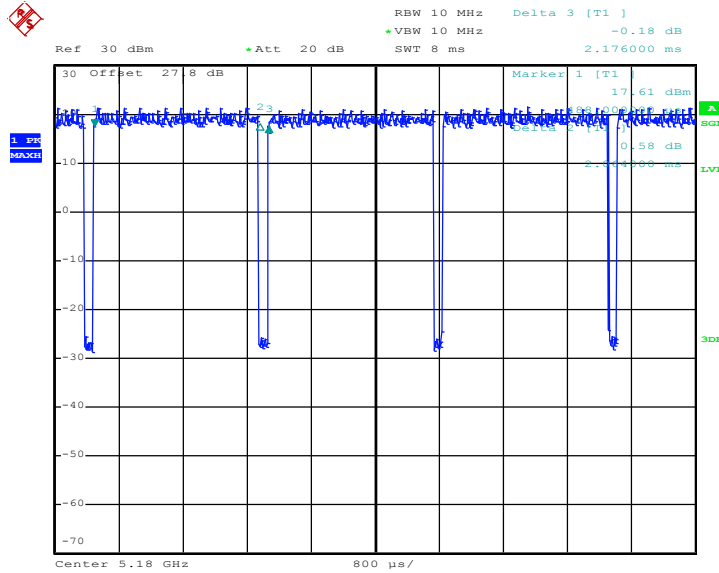

Date: 1.APR.2017 19:34:32

802.11n HT20

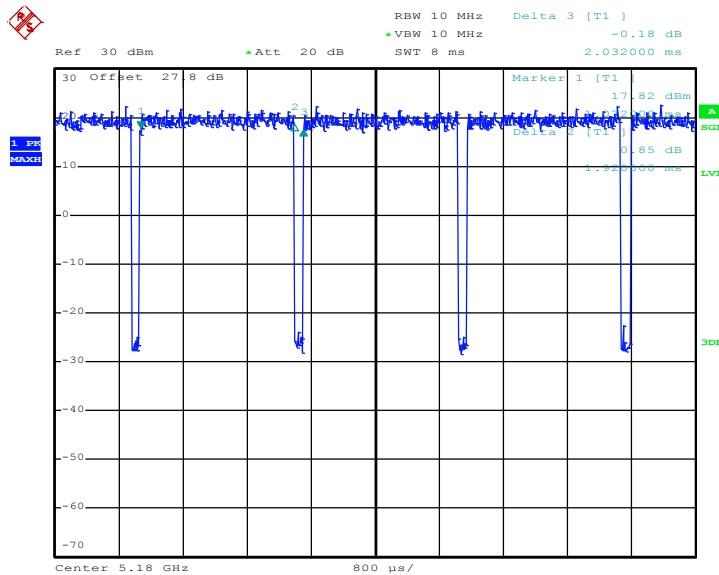

Date: 1.APR.2017 20:14:13



802.11n HT40

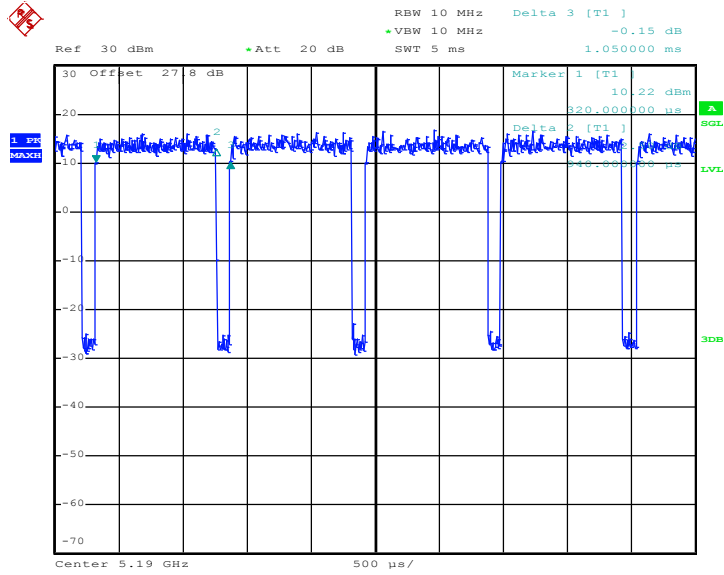

Date: 1.APR.2017 20:45:05

802.11ac VHT20

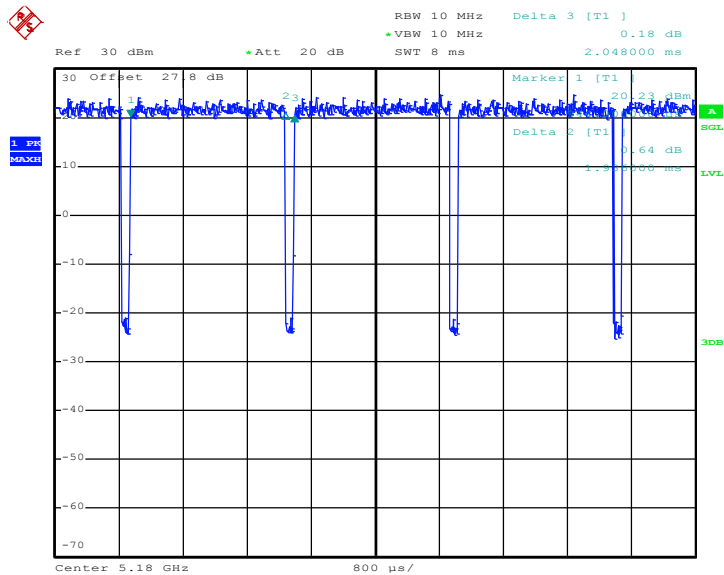

Date: 3.APR.2017 09:32:52



802.11ac VHT40

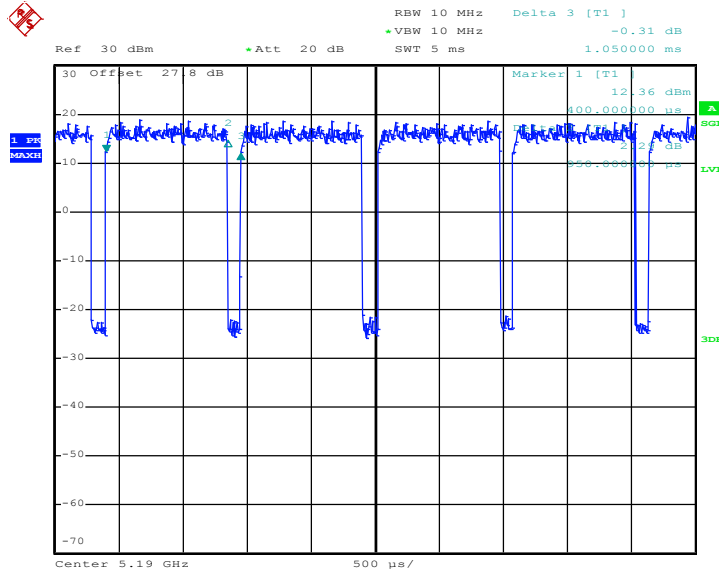

Date: 3.APR.2017 10:29:59

802.11ac VHT80

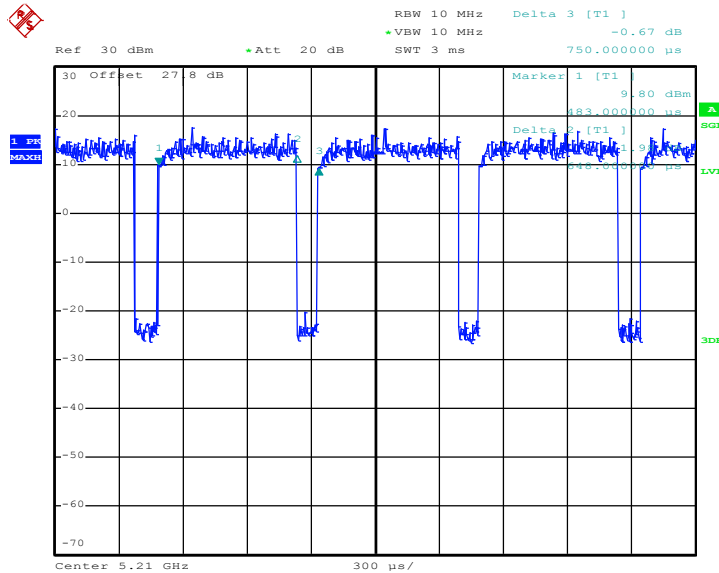

Date: 3.APR.2017 11:17:11