



FCC RF Test Report

APPLICANT : Motorola Mobility, LLC
EQUIPMENT : Mobile Cellular Phone
BRAND NAME : Motorola
MODEL NAME : 10721, 12822
FCC ID : IHDT56WB3
STANDARD : FCC Part 15 Subpart E §15.407
CLASSIFICATION : (NII) Unlicensed National Information Infrastructure

This is a variant report which is only valid together with the original test report. The product was received on Mar. 31, 2017 and testing was completed on May 07, 2017. We, SPORTON INTERNATIONAL INC., would like to declare that the tested sample has been evaluated in accordance with the test procedures and has been in compliance with the applicable technical standards.

The test results in this report apply exclusively to the tested model / sample. Without written approval of SPORTON INTERNATIONAL INC., the test report shall not be reproduced except in full.

Reviewed by: Joseph Lin / Supervisor

Approved by: Jones Tsai / Manager



SPORTON INTERNATIONAL INC.

No. 52, Hwa Ya 1st Rd., Hwa Ya Technology Park, Kwei-Shan District, Tao Yuan City, Taiwan, R.O.C.

SPORTON INTERNATIONAL INC.

TEL : 886-3-327-3456

FAX : 886-3-328-4978

FCC ID : IHDT56WB3

Page Number : 1 of 26

Report Issued Date : May 26, 2017

Report Version : Rev. 01

Report Template No.: BU5-FR15EWL Version 1.4



TABLE OF CONTENTS

REVISION HISTORY.....3

SUMMARY OF TEST RESULT4

1 GENERAL DESCRIPTION.....5

 1.1 Applicant.....5

 1.2 Manufacturer.....5

 1.3 Product Feature of Equipment Under Test.....5

 1.4 Product Specification of Equipment Under Test.....7

 1.5 Modification of EUT9

 1.6 Testing Location10

 1.7 Applicable Standards.....11

2 TEST CONFIGURATION OF EQUIPMENT UNDER TEST.....12

 2.1 Carrier Frequency Channel12

 2.2 Test Mode.....13

 2.3 Connection Diagram of Test System.....14

 2.4 EUT Operation Test Setup14

3 TEST RESULT.....15

 3.1 Maximum Conducted Output Power Measurement15

 3.2 Unwanted Radiated Emission Measurement17

 3.3 Automatically Discontinue Transmission23

 3.4 Antenna Requirements.....24

4 LIST OF MEASURING EQUIPMENTS.....25

5 UNCERTAINTY OF EVALUATION.....26

APPENDIX A. CONDUCTED TEST RESULTS

APPENDIX B. RADIATED SPURIOUS EMISSION

APPENDIX C. RADIATED SPURIOUS EMISSION PLOTS

APPENDIX D. DUTY CYCLE PLOTS

APPENDIX E. ORIGINAL REPORT



REVISION HISTORY

REPORT NO.	VERSION	DESCRIPTION	ISSUED DATE
FR733129-06E	Rev. 01	Initial issue of report	May 26, 2017



SUMMARY OF TEST RESULT

Report Section	FCC Rule	Description	Limit	Result	Remark
3.1	15.407(a)	Maximum Conducted Output Power	≤ 24 dBm (depend on band)	Pass	-
3.2	15.407(b)	Unwanted Emissions	$\leq -17, -27$ dBm (depend on band)&15.209(a)	Pass	Under limit 0.13 dB at 5146.640 MHz and 5350.080 MHz
3.3	15.407(c)	Automatically Discontinue Transmission	Discontinue Transmission	Pass	-
3.4	15.203 & 15.407(a)	Antenna Requirement	N/A	Pass	-



1 General Description

1.1 Applicant

Motorola Mobility, LLC

222 W Merchandise Mart Plaza, Suite 1800, Chicago, IL 60654, United States

1.2 Manufacturer

Motorola Mobility, LLC

222 W Merchandise Mart Plaza, Suite 1800, Chicago, IL 60654, United States

1.3 Product Feature of Equipment Under Test

Product Feature	
Equipment	Mobile Cellular Phone
Brand Name	Motorola
Model Name	10721, 12822
FCC ID	IHDT56WB3
IMEI Code	353312080019096
EUT supports Radios application	CDMA/EV-DO/GSM/EGPRS/WCDMA/HSPA/LTE/NFC WLAN 11b/g/n HT20 WLAN 11a/n HT20/HT40 WLAN 11ac VHT20/VHT40/VHT80 Bluetooth BR/EDR/LE
HW Version	DVT2
EUT Stage	Identical Prototype

Remark:

1. The above EUT's information was declared by manufacturer. Please refer to the specifications or user's manual for more detailed description.
2. This is a variant report. All the test cases were performed on original report which can be referred to Sporton Report Number FR733129E.



Accessory List	
AC Adapter 1	Brand Name : Motorola
	Model Name : SPN5970A
AC Adapter 2	Brand Name : Motorola
	Model Name : SPN5993A
AC Adapter 3	Brand Name : Motorola
	Model Name : SPN5978A
Battery 1	Brand Name : Motorola
	Model Name : SNN5986A
Battery 2	Brand Name : Motorola
	Model Name : SNN5897A
Earphone	Brand Name : Motorola
	Model Name : SH38C16618
USB Cable	Brand Name : Motorola
	Model Name : SKN6473A
USB-C Data Cable	Brand Name : Motorola
	Model Name : SKN6474A



1.4 Product Specification of Equipment Under Test

Standards-related Product Specification	
Tx/Rx Frequency Range	5180 MHz ~ 5240 MHz 5260 MHz ~ 5320 MHz 5500 MHz ~ 5720 MHz
Maximum Output Power to Antenna	<p><Ant. 1> <5180 MHz ~ 5240 MHz> 802.11a : 17.73 dBm / 0.0593 W 802.11n HT20 : 17.66 dBm / 0.0583 W 802.11n HT40 : 17.05 dBm / 0.0507 W 802.11ac VHT20 : 17.79 dBm / 0.0601 W 802.11ac VHT40 : 17.40 dBm / 0.0550 W 802.11ac VHT80 : 15.12 dBm / 0.0325 W <5260 MHz ~ 5320 MHz> 802.11a : 17.77 dBm / 0.0598 W 802.11n HT20 : 17.85 dBm / 0.0610 W 802.11n HT40 : 16.84 dBm / 0.0483 W 802.11ac VHT20 : 17.80 dBm / 0.0603 W 802.11ac VHT40 : 17.19 dBm / 0.0524 W 802.11ac VHT80 : 13.78 dBm / 0.0239 W <5500 MHz ~ 5700 MHz > 802.11a : 17.81 dBm / 0.0604 W 802.11n HT20 : 17.90 dBm / 0.0617 W 802.11n HT40 : 17.42 dBm / 0.0552 W 802.11ac VHT20 : 17.88 dBm / 0.0614 W 802.11ac VHT40 : 17.53 dBm / 0.0566 W 802.11ac VHT80 : 17.83 dBm / 0.0607 W <Ant. 2> <5180 MHz ~ 5240 MHz> 802.11a : 17.67 dBm / 0.0585 W 802.11n HT20 : 17.52 dBm / 0.0565 W 802.11n HT40 : 16.70 dBm / 0.0468 W 802.11ac VHT20 : 17.60 dBm / 0.0575 W 802.11ac VHT40 : 17.30 dBm / 0.0537 W 802.11ac VHT80 : 15.18 dBm / 0.0330 W <5260 MHz ~ 5320 MHz> 802.11a : 17.73 dBm / 0.0593 W 802.11n HT20 : 17.63 dBm / 0.0579 W 802.11n HT40 : 16.59 dBm / 0.0456 W 802.11ac VHT20 : 17.68 dBm / 0.0586 W 802.11ac VHT40 : 17.01 dBm / 0.0502 W 802.11ac VHT80 : 13.73 dBm / 0.0236 W <5500 MHz ~ 5700 MHz > 802.11a : 17.77 dBm / 0.0598 W 802.11n HT20 : 17.67 dBm / 0.0585 W 802.11n HT40 : 17.19 dBm / 0.0524 W 802.11ac VHT20 : 17.80 dBm / 0.0603 W 802.11ac VHT40 : 17.35 dBm / 0.0543 W 802.11ac VHT80 : 17.53 dBm / 0.0566 W</p>



Standards-related Product Specification	
<p>Maximum Output Power to Antenna</p>	<p>MIMO <Ant. 1 + 2> <5180 MHz ~ 5240 MHz> 802.11a : 20.74 dBm / 0.1186 W 802.11n HT20 : 20.62 dBm / 0.1153 W 802.11n HT40 : 19.93 dBm / 0.0984 W 802.11ac VHT20 : 20.72 dBm / 0.1180 W 802.11ac VHT40 : 20.43 dBm / 0.1104 W 802.11ac VHT80 : 18.33 dBm / 0.0681 W <5260 MHz ~ 5320 MHz> 802.11a : 20.78 dBm / 0.1197 W 802.11n HT20 : 20.76 dBm / 0.1191 W 802.11n HT40 : 19.78 dBm / 0.0951 W 802.11ac VHT20 : 20.76 dBm / 0.1191 W 802.11ac VHT40 : 20.16 dBm / 0.1038 W 802.11ac VHT80 : 16.73 dBm / 0.0471 W <5500 MHz ~ 5700 MHz > 802.11a : 20.84 dBm / 0.1213 W 802.11n HT20 : 20.81 dBm / 0.1205 W 802.11n HT40 : 20.48 dBm / 0.1117 W 802.11ac VHT20 : 20.91 dBm / 0.1233 W 802.11ac VHT40 : 20.55 dBm / 0.1135 W 802.11ac VHT80 : 20.73 dBm / 0.1183 W</p>
<p>Maximum Output Power to Antenna for Straddle Channel</p>	<p><Ant. 1> 802.11a : 17.77 dBm / 0.0598 W 802.11n HT20 : 17.90 dBm / 0.0617 W 802.11n HT40 : 17.10 dBm / 0.0513 W 802.11ac VHT20 : 17.78 dBm / 0.0600 W 802.11ac VHT40 : 17.16 dBm / 0.0520 W 802.11ac VHT80 : 17.90 dBm / 0.0617 W <Ant. 2> 802.11a : 17.67 dBm / 0.0585 W 802.11n HT20 : 17.68 dBm / 0.0586 W 802.11n HT40 : 16.80 dBm / 0.0479 W 802.11ac VHT20 : 17.72 dBm / 0.0592 W 802.11ac VHT40 : 16.60 dBm / 0.0457 W 802.11ac VHT80 : 17.65 dBm / 0.0582 W MIMO <Ant. 1 + 2> 802.11a : 20.74 dBm / 0.1186 W 802.11n HT20 : 20.68 dBm / 0.1169 W 802.11n HT40 : 19.94 dBm / 0.0986 W 802.11ac VHT20 : 20.61 dBm / 0.1151 W 802.11ac VHT40 : 19.86 dBm / 0.0968 W 802.11ac VHT80 : 20.91 dBm / 0.1233 W</p>



Standards-related Product Specification											
Antenna Gain / Gain	<p><Ant. 1> <5150 MHz ~ 5250 MHz> Fixed Internal Antenna type with gain -3.70 dBi <5250 MHz ~ 5350 MHz> Fixed Internal Antenna type with gain -2.40 dBi <5470 MHz ~ 5725 MHz> Fixed Internal Antenna type with gain -2.40 dBi <Ant. 2> <5150 MHz ~ 5250 MHz> Fixed Internal Antenna type with gain -3.30 dBi <5250 MHz ~ 5350 MHz> Fixed Internal Antenna type with gain -3.10 dBi <5470 MHz ~ 5725 MHz> Fixed Internal Antenna type with gain -3.50 dBi</p>										
Type of Modulation	802.11a/n : OFDM (BPSK / QPSK / 16QAM / 64QAM) 802.11ac : OFDM (BPSK / QPSK / 16QAM / 64QAM / 256QAM)										
Antenna Function Description	<table border="1"> <thead> <tr> <th></th> <th>Ant. 1</th> <th>Ant. 2</th> </tr> </thead> <tbody> <tr> <td>802.11 a/n/ac</td> <td>V</td> <td>V</td> </tr> <tr> <td>802.11 a/n/ac MIMO</td> <td>V</td> <td>V</td> </tr> </tbody> </table>			Ant. 1	Ant. 2	802.11 a/n/ac	V	V	802.11 a/n/ac MIMO	V	V
	Ant. 1	Ant. 2									
802.11 a/n/ac	V	V									
802.11 a/n/ac MIMO	V	V									

Note: MIMO Ant. 1+2 is a calculated result from sum of the power MIMO Ant. 1 and MIMO Ant. 2.

1.5 Modification of EUT

No modifications are made to the EUT during all test items.



1.6 Testing Location

Sporton Lab is accredited to ISO 17025 by Taiwan Accreditation Foundation (TAF code : 1190) and the FCC designation No. TW0007 under the FCC 2.948(e) by Mutual Recognition Agreement (MRA) in FCC Test.

Test Site	SPORTON INTERNATIONAL INC.
Test Site Location	No. 52, Hwa Ya 1 st Rd., Hwa Ya Technology Park, Kwei-Shan District, Tao Yuan City, Taiwan, R.O.C. TEL: +886-3-327-3456 FAX: +886-3-328-4978
Test Site No.	Sporton Site No. TH05-HY

Note: The test site complies with ANSI C63.4 2014 requirement.

Test Site	SPORTON INTERNATIONAL INC.
Test Site Location	No.58, Aly. 75, Ln. 564, Wenhua 3rd Rd. Guishan Dist, Taoyuan City, Taiwan (R.O.C.) TEL: +886-3-327-0868 FAX: +886-3-327-0855
Test Site No.	Sporton Site No. 03CH11-HY

Note: The test site complies with ANSI C63.4 2014 requirement.



1.7 Applicable Standards

According to the specifications of the manufacturer, the EUT must comply with the requirements of the following standards:

- ♦ FCC Part 15 Subpart E
- ♦ FCC KDB 789033 D02 General UNII Test Procedures New Rules v01r04.
- ♦ FCC KDB 662911 D01 Multiple Transmitter Output v02r01.
- ♦ FCC KDB 644545 D03 Guidance for IEEE 802.11ac New Rules v01
- ♦ ANSI C63.10-2013

Remark:

1. All test items were verified and recorded according to the standards and without any deviation during the test.
2. This EUT has also been tested and complied with the requirements of FCC Part 15, Subpart B, recorded in a separate test report.



2 Test Configuration of Equipment Under Test

The EUT has been associated with peripherals and configuration operated in a manner tended to maximize its emission characteristics in a typical application. Frequency range investigated: radiated emission (9 kHz to the 10th harmonic of the highest fundamental frequency or to 40 GHz, whichever is lower). For radiated measurement, pre-scanned in three orthogonal panels, X, Y, Z. The worst cases (X plane) were recorded in this report.

2.1 Carrier Frequency Channel

Frequency Band	Channel	Freq. (MHz)	Channel	Freq. (MHz)
5150-5250 MHz Band 1 (U-NII-1)	36	5180	44	5220
	38*	5190	46*	5230
	40	5200	48	5240
	42 [#]	5210		

Frequency Band	Channel	Freq. (MHz)	Channel	Freq. (MHz)
5250-5350 MHz Band 2 (U-NII-2A)	52	5260	60	5300
	54*	5270	62*	5310
	56	5280	64	5320
	58 [#]	5290		

Frequency Band	Channel	Freq. (MHz)	Channel	Freq. (MHz)
5470-5725 MHz Band 3 (U-NII-2C)	100	5500	112	5560
	102*	5510	116	5580
	104	5520	132	5660
	106 [#]	5530	134*	5670
	108	5540	136	5680
	110*	5550	140	5720



Frequency Band	Channel	Freq. (MHz)	Channel	Freq. (MHz)
TDWR Channel	118*	5590	124	5620
	120	5600	126*	5630
	122 [#]	5610	128	5640

Frequency Band	Channel	Freq. (MHz)	Channel	Freq. (MHz)
Straddle Channel	138 [#]	5690	144	5720
	142*	5710		

Note:

1. The above Frequency and Channel in "*" were 802.11n HT40 and 802.11ac VHT40.
2. The above Frequency and Channel in "[#]" were 802.11ac VHT80.

2.2 Test Mode

Final test mode of conducted test items and radiated spurious emissions are considering the modulation and worse data rates as below table.

MIMO Antenna

Modulation	Data Rate
802.11n HT40	MCS0
802.11ac VHT80	MCS0

Remark: All the radiated test cases were performance with Adapter 1 and Battery 2.

Ch. #	Band I : 5150-5250 MHz		Band II : 5250-5350 MHz		Band III : 5470-5725MHz	
	802.11n HT40		802.11n HT40		802.11ac VHT80	
L	Low	38	-	-	-	-
M	Middle	-	-	-	106	-
H	High	-	62	-	-	-
Straddle		-	-	-	-	-

2.3 Connection Diagram of Test System

<WLAN Tx Mode>

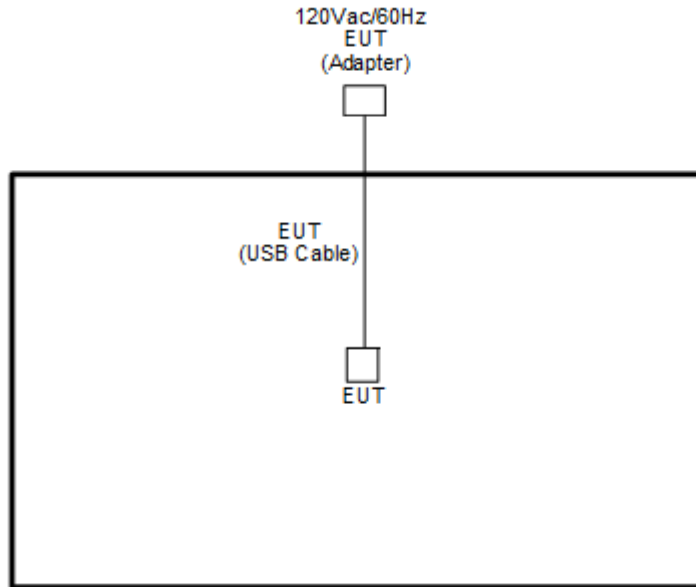

2.4 EUT Operation Test Setup

The RF test items, programmed RF utility, "QRCT" installed in the notebook make the EUT provide functions like channel selection and power level for continuous transmitting and receiving signals.



3 Test Result

3.1 Maximum Conducted Output Power Measurement

3.1.1 Limit of Maximum Conducted Output Power

<FCC 14-30 CFR 15.407>

For mobile and portable client devices in the 5.15–5.25 GHz band, the maximum conducted output power over the frequency band of operation shall not exceed 250 mW.

For the 5.25–5.725 GHz bands, the maximum conducted output power over the frequency bands of operation shall not exceed the lesser of 250 mW or 11 dBm 10 log B, where B is the 26 dB emission bandwidth in megahertz.

For Straddle Channel, U-NII procedures and limits were applied for operations in the frequency band in accordance with FCC KDB 644545 D03.

If transmitting antennas of directional gain greater than 6 dBi are used, the peak output power shall be reduced by the amount in dB that the directional gain of the antenna exceeds 6 dBi.

Note that U-NII-2 band, devices with a maximum e.i.r.p. greater than 500 mW shall implement TPC in order to have the capability to operate at least 6 dB below the maximum permitted e.i.r.p. of 1 W.

3.1.2 Measuring Instruments

The measuring equipment is listed in the section 4 of this test report.

3.1.3 Test Procedures

The testing follows Method PM of FCC KDB 789033 D02 General UNII Test Procedures New Rules v01r04.

Method PM (Measurement using an RF average power meter):

1. Measurement is performed using a wideband RF power meter.
2. The EUT is configured to transmit continuously with a consistent duty cycle at its maximum power control level.
3. Measure the average power of the transmitter, and the average power is corrected with duty factor, $10 \log(1/x)$, where x is the duty cycle.

For straddle channel, the testing follows Method SA-3 (RMS detection with max hold) of FCC KDB 789033 D02 General UNII Test Procedures New Rules v01r04.

Compute power by integrating the spectrum across the 99% occupied bandwidth of the signal using the instrument's band power measurement function.

3.1.4 Test Setup

For normal channel:

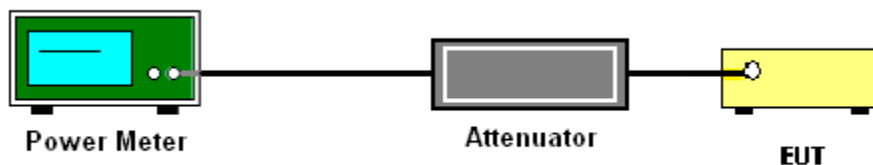

For straddle channel:

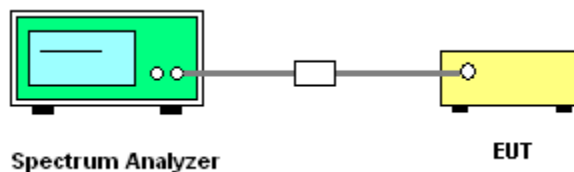

3.1.5 Test Result of Maximum Conducted Output Power

Please refer to Appendix A.



3.2 Unwanted Radiated Emission Measurement

This section is to measure unwanted emissions through radiated measurement for band edge spurious emissions and out of band emissions measurement.

3.2.1 Limit of Unwanted Emissions

- (1) For transmitters operating in the 5150-5250 MHz band: all emissions outside of the 5150-5350 MHz band shall not exceed an EIRP of -27dBm/MHz.

For transmitters operating in the 5250-5350 MHz band: all emissions outside of the 5150-5350 MHz band shall not exceed an EIRP of -27 dBm/MHz. Devices operating in the 5250-5350 MHz band that generate emissions in the 5150-5250 MHz band must meet all applicable technical requirements for operation in the 5150-5250 MHz band (including indoor use) or alternatively meet an out-of-band emission EIRP limit of -27 dBm/MHz in the 5150-5250 MHz band.

For transmitters operating in the 5470-5725MHz band: all emissions outside of the 5470-5725MHz band shall not exceed an EIRP of -27 dBm/MHz.

- (2) Unwanted spurious emissions fallen in restricted bands shall comply with the general field strength limits set forth as below table,

Frequency (MHz)	Field Strength (microvolts/meter)	Measurement Distance (meters)
0.009 – 0.490	2400/F(kHz)	300
0.490 – 1.705	24000/F(kHz)	30
1.705 – 30.0	30	30
30 – 88	100	3
88 – 216	150	3
216 - 960	200	3
Above 960	500	3

Note: The following formula is used to convert the EIRP to field strength.

$$E = \frac{1000000\sqrt{30P}}{3} \mu\text{V/m, where P is the eirp (Watts)}$$



EIRP (dBm)	Field Strength at 3m (dBμV/m)
- 27	68.3

(3) KDB789033 D02 v01r04 G)2)c)

- (i) Sections 15.407(b)(1) to (b)(3) specify the unwanted emission limits for the U-NII-1 and U-NII-2 bands. As specified, emissions above 1000 MHz that are outside of the restricted bands are subject to a peak emission limit of -27 dBm/MHz.³
- (ii) Section 15.407(b)(4) specifies the unwanted emission limit for the U-NII-3 band. A band emissions mask is specified in Section 15.407(b)(4)(i). The emission limits are in terms of a Peak detector. An alternative to the band emissions mask is specified in Section 15.407(b)(4)(ii). The alternative limits are based on the highest antenna gain specified in the filing. There are also marketing and importation restrictions for the devices using the alternative limit.⁴

Note 3: An out-of-band emission that complies with both the average and peak limits of Section 15.209 is not required to satisfy the -27 dBm/MHz peak emission limit.

Note 4: Only devices with antenna gains of 10 dBi or less may be approved using the emission limits specified in Section 15.247(d) till March 2, 2018; all other devices operating in this band must use the mask specified in Section 15.407(b)(4)(i).

3.2.2 Measuring Instruments

The measuring equipment is listed in the section 4 of this test report.



3.2.3 Test Procedures

1. The testing follows FCC KDB 789033 D02 General UNII Test Procedures New Rules v01r04. Section G) Unwanted emissions measurement.

(1) Procedure for Unwanted Emissions Measurements Below 1000MHz

- RBW = 120 kHz
- VBW = 300 kHz
- Detector = Peak
- Trace mode = max hold

(2) Procedure for Peak Unwanted Emissions Measurements Above 1000 MHz

- RBW = 1 MHz
- VBW \geq 3 MHz
- Detector = Peak
- Sweep time = auto
- Trace mode = max hold

(3) Procedures for Average Unwanted Emissions Measurements Above 1000MHz

- RBW = 1 MHz
- VBW = 10 Hz, when duty cycle is no less than 98 percent.
- VBW \geq 1/T, when duty cycle is less than 98 percent where T is the minimum transmission duration over which the transmitter is on and is transmitting at its maximum power control level for the tested mode of operation.

2. The EUT was placed on a turntable with 0.8 meter for frequency below 1GHz and 1.5 meter for frequency above 1GHz respectively above ground.
3. The EUT was set 3 meters from the interference receiving antenna which was mounted on the top of a variable height antenna tower.
4. The antenna is a broadband antenna and its height is adjusted between one meter and four meters above ground to find the maximum value of the field strength for both horizontal polarization and vertical polarization of the antenna.
5. For each suspected emission, the EUT was arranged to its worst case and then adjust the antenna tower (from 1 m to 4 m) and turntable (from 0 degree to 360 degrees) to find the maximum reading.
6. For testing below 1GHz, if the emission level of the EUT in peak mode was 3 dB lower than the limit specified, then peak values of EUT will be reported, otherwise, the emissions will be repeated one by one using the CISPR quasi-peak method and reported.
7. For testing above 1GHz, the emission level of the EUT in peak mode was 20dB lower than average limit (that means the emission level in average mode also complies with the limit in average mode), then peak values of EUT will be reported, otherwise, the emissions will be measured in average mode again and reported.

3.2.4 Test Setup

For radiated emissions below 30MHz

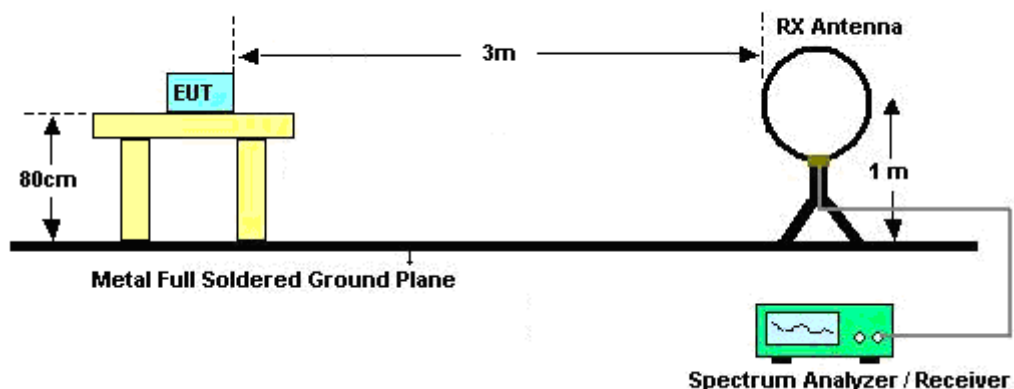

For radiated emissions from 30MHz to 1GHz

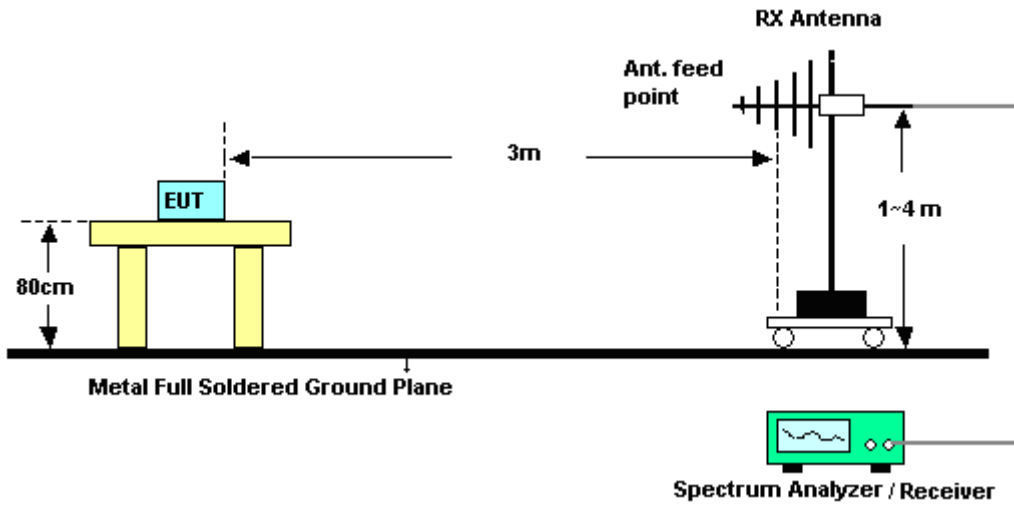

For radiated emissions above 1GHz

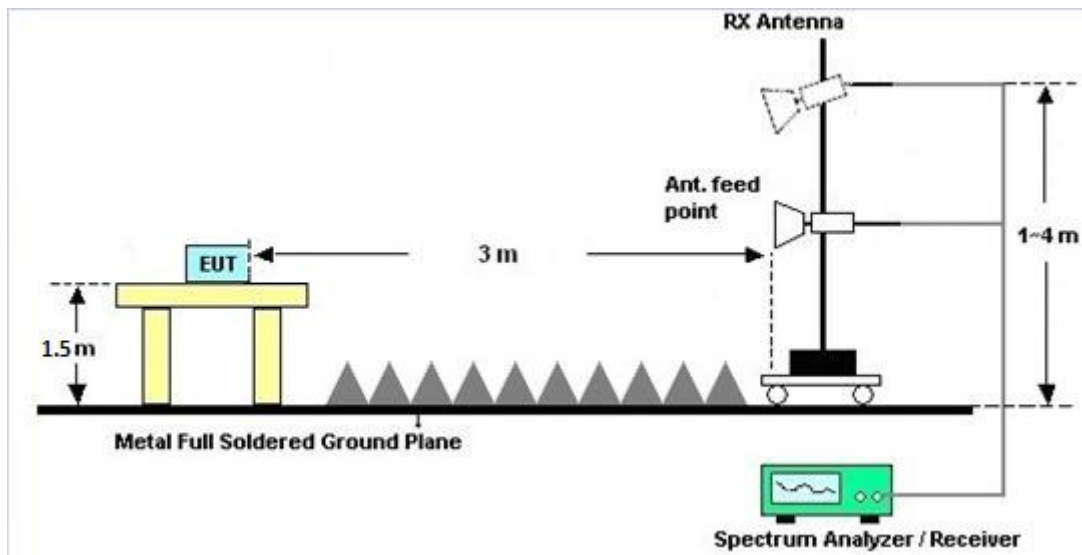



3.2.5 Test Results of Radiated Spurious Emissions (9 kHz ~ 30 MHz)

The low frequency, which started from 9 kHz to 30MHz, was pre-scanned and the result which was 20dB lower than the limit line was not reported.

3.2.6 Test Result of Radiated Spurious at Band Edges

Please refer to Appendix B and C.

3.2.7 Duty Cycle

Please refer to Appendix D.

3.2.8 Test Result of Radiated Spurious Emissions (30MHz ~ 10th Harmonic)

Please refer to Appendix B and C.



3.3 Automatically Discontinue Transmission

3.3.1 Limit of Automatically Discontinue Transmission

The device shall automatically discontinue transmission in case of either absence of information to transmit or operational failure. These provisions are not intended to preclude the transmission of control or signaling information or the use of repetitive codes used by certain digital technologies to complete frame or burst intervals. Applicants shall include in their application for equipment authorization to describe how this requirement is met.

3.3.2 Measuring Instruments

The measuring equipment is listed in the section 4 of this test report.

3.3.3 Test Result of Automatically Discontinue Transmission

While the EUT is not transmitting any information, the EUT can automatically discontinue transmission and become standby mode for power saving. The EUT can detect the controlling signal of ACK message transmitting from remote device and verify whether it shall resend or discontinue transmission.



3.4 Antenna Requirements

3.4.1 Standard Applicable

If transmitting antenna directional gain is greater than 6 dBi, both the peak transmit power and the peak power spectral density shall be reduced by the amount in dB that the directional gain of the antenna exceeds 6 dBi.

3.4.2 Antenna Anti-Replacement Construction

An embedded-in antenna design is used.

3.4.3 Antenna Gain

FCC KDB 662911 D01 Multiple Transmitter Output v02r01

For CDD transmissions, directional gain is calculated as

Directional gain = G_{ANT} + Array Gain, where Array Gain is as follows.

For power spectral density (PSD) measurements on all devices,

Array Gain = $10 \log(N_{ANT}/N_{SS}=1)$ dB.

For power measurements on IEEE 802.11 devices,

Array Gain = 0 dB (i.e., no array gain) for $N_{ANT} \leq 4$.

Directional gain may be calculated by using the formulas applicable to equal gain antennas with G_{ANT} set equal to the gain of the antenna having the highest gain;

The EUT supports CDD mode.

For power, the directional gain G_{ANT} is set equal to the antenna having the highest gain, i.e., F)2)f)i).

For PSD, the directional gain calculation is following F)2)f)ii) of KDB 662911 D01 v02r01.

The power and PSD limit should be modified if the directional gain of EUT is over 6 dBi,

The directional gain "DG" is calculated as following table.

	Ant 1	Ant 2	DG for Power	DG for PSD	Power Limit Reduction	PSD Limit Reduction
	(dBi)	(dBi)	(dBi)	(dBi)	(dB)	(dB)
Band I	-3.70	-3.30	-3.30	-0.49	0.00	0.00
Band II	-2.40	-3.10	-2.40	0.27	0.00	0.00
Band III	-2.40	-3.50	-2.40	0.08	0.00	0.00

Power limit reduction = Composite gain – 6dBi, (min = 0)

PSD limit reduction = Composite gain + PSD Array gain – 6dBi, (min = 0)



4 List of Measuring Equipments

Instrument	Manufacturer	Model No.	Serial No.	Characteristics	Calibration Date	Test Date	Due Date	Remark
Power Meter	Anritsu	ML2495A	0932001	300MHz~40GHz	Sep. 29, 2016	May 04, 2017~ May 05, 2017	Sep. 28, 2017	Conducted (TH05-HY)
Power Sensor	Anritsu	MA2411B	0846202	300MHz~40GHz	Sep. 29, 2016	May 04, 2017~ May 05, 2017	Sep. 28, 2017	Conducted (TH05-HY)
Amplifier	SONOMA	310N	187312	9kHz~1GHz	Nov. 10, 2016	May 05, 2017~ May 07, 2017	Nov. 09, 2017	Radiation (03CH11-HY)
Loop Antenna	Rohde & Schwarz	HFH2-Z2	100315	9 kHz~30 MHz	Sep. 02, 2015	May 05, 2017~ May 07, 2017	Sep. 01, 2017	Radiation (03CH11-HY)
Bilog Antenna	TESEQ	CBL 6111D	35414	30MHz~1GHz	Oct. 15, 2016	May 05, 2017~ May 07, 2017	Oct. 14, 2017	Radiation (03CH11-HY)
Horn Antenna	SCHWARZBECK	BBHA 9120 D	9120D-1326	1GHz ~ 18GHz	Oct. 07, 2016	May 05, 2017~ May 07, 2017	Oct. 06, 2017	Radiation (03CH11-HY)
Preamplifier	Keysight	83017A	MY53270080	1GHz~26.5GHz	Nov. 10, 2016	May 05, 2017~ May 07, 2017	Nov. 09, 2017	Radiation (03CH11-HY)
Spectrum Analyzer	Keysight	N9010A	MY54200486	10Hz ~ 44GHz	Oct. 12, 2016	May 05, 2017~ May 07, 2017	Oct. 11, 2017	Radiation (03CH11-HY)
Antenna Mast	EMEC	AM-BS-4500-B	N/A	1~4m	N/A	May 05, 2017~ May 07, 2017	N/A	Radiation (03CH11-HY)
Turn Table	EMEC	TT 2000	N/A	0~360 Degree	N/A	May 05, 2017~ May 07, 2017	N/A	Radiation (03CH11-HY)
Preamplifier	MITEQ	AMF-7D-0010 1800-30-10P	1815698	1GHz~18GHz	Dec. 01, 2016	May 05, 2017~ May 07, 2017	Nov. 30, 2017	Radiation (03CH11-HY)
SHF-EHF Horn Antenna	SCHWARZBECK	BBHA 9170	BBHA917058 4	18GHz- 40GHz	Nov. 08, 2016	May 05, 2017~ May 07, 2017	Nov. 07, 2017	Radiation (03CH11-HY)
Preamplifier	MITEQ	TTA0204	1872107	2GHz~40GHz	Feb. 15, 2017	May 05, 2017~ May 07, 2017	Feb. 14, 2018	Radiation (03CH11-HY)



5 Uncertainty of Evaluation

Uncertainty of Radiated Emission Measurement (30 MHz ~ 1000 MHz)

Measuring Uncertainty for a Level of Confidence of 95% ($U = 2Uc(y)$)	5.2
---	-----

Uncertainty of Radiated Emission Measurement (1000 MHz ~ 18000 MHz)

Measuring Uncertainty for a Level of Confidence of 95% ($U = 2Uc(y)$)	5.5
---	-----

Uncertainty of Radiated Emission Measurement (18000 MHz ~ 40000 MHz)

Measuring Uncertainty for a Level of Confidence of 95% ($U = 2Uc(y)$)	5.2
---	-----

Appendix A. Test Result of Conducted Test Items

Test Engineer:	Shiming Liu	Temperature:	21~25	°C
Test Date:	2017/5/4~2017/5/5	Relative Humidity:	51~54	%

TEST RESULTS DATA
Average Power Table

FCC Band I														
Mod.	Data Rate	NTX	CH.	Freq. (MHz)	Duty Factor (dB)		Average Conducted Power (dBm)			FCC Conducted Power Limit (dBm)		DG (dBi)		Pass/Fail
					Ant 1	Ant 2	Ant 1	Ant 2	SUM	Ant 1	Ant 2	Ant 1	Ant 2	
11a	6Mbps	1	36	5180	0.17	0.27	17.73	17.67		21.00	21.00	-3.70	-3.30	Pass
11a	6Mbps	1	44	5220	0.17	0.27	17.71	17.65		21.00	21.00	-3.70	-3.30	Pass
11a	6Mbps	1	48	5240	0.17	0.27	17.69	17.60		21.00	21.00	-3.70	-3.30	Pass
HT20	MCS0	1	36	5180	0.20	0.18	17.66	17.52		21.00	21.00	-3.70	-3.30	Pass
HT20	MCS0	1	44	5220	0.20	0.18	17.63	17.51		21.00	21.00	-3.70	-3.30	Pass
HT20	MCS0	1	48	5240	0.20	0.18	17.61	17.50		21.00	21.00	-3.70	-3.30	Pass
HT40	MCS0	1	38	5190	0.37	0.29	17.03	16.66		21.00	21.00	-3.70	-3.30	Pass
HT40	MCS0	1	46	5230	0.37	0.29	17.05	16.70		21.00	21.00	-3.70	-3.30	Pass
VHT20	MCS0	1	36	5180	0.18	0.18	17.79	17.60		21.00	21.00	-3.70	-3.30	Pass
VHT20	MCS0	1	44	5220	0.18	0.18	17.74	17.58		21.00	21.00	-3.70	-3.30	Pass
VHT20	MCS0	1	48	5240	0.18	0.18	17.61	17.53		21.00	21.00	-3.70	-3.30	Pass
VHT40	MCS0	1	38	5190	0.33	0.37	17.35	17.02		21.00	21.00	-3.70	-3.30	Pass
VHT40	MCS0	1	46	5230	0.33	0.37	17.40	17.30		21.00	21.00	-3.70	-3.30	Pass
VHT80	MCS0	1	42	5210	0.63	0.63	15.12	15.18		21.00	21.00	-3.70	-3.30	Pass
11a	6Mbps	2	36	5180	0.17	0.17	17.77	17.68	20.74	21.00		-3.30		Pass
11a	6Mbps	2	44	5220	0.17	0.17	17.72	17.67	20.71	21.00		-3.30		Pass
11a	6Mbps	2	48	5240	0.17	0.17	17.70	17.62	20.67	21.00		-3.30		Pass
HT20	MCS0	2	36	5180	0.18	0.18	17.68	17.54	20.62	21.00		-3.30		Pass
HT20	MCS0	2	44	5220	0.18	0.18	17.65	17.52	20.60	21.00		-3.30		Pass
HT20	MCS0	2	48	5240	0.18	0.18	17.63	17.51	20.58	21.00		-3.30		Pass
HT40	MCS0	2	38	5190	0.37	0.33	17.04	16.67	19.87	21.00		-3.30		Pass
HT40	MCS0	2	46	5230	0.37	0.33	17.10	16.74	19.93	21.00		-3.30		Pass
VHT20	MCS0	2	36	5180	0.18	0.18	17.80	17.61	20.72	21.00		-3.30		Pass
VHT20	MCS0	2	44	5220	0.18	0.18	17.76	17.59	20.69	21.00		-3.30		Pass
VHT20	MCS0	2	48	5240	0.18	0.18	17.67	17.54	20.62	21.00		-3.30		Pass
VHT40	MCS0	2	38	5190	0.33	0.29	17.43	16.84	20.15	21.00		-3.30		Pass
VHT40	MCS0	2	46	5230	0.33	0.29	17.49	17.34	20.43	21.00		-3.30		Pass
VHT80	MCS0	2	42	5210	0.70	0.63	15.40	15.23	18.33	21.00		-3.30		Pass

TEST RESULTS DATA
Average Power Table

FCC Band II															
Mod.	Data Rate	NTX	CH.	Freq. (MHz)	Duty Factor (dB)		Average Conducted Power (dBm)			FCC Conducted Power Limit (dBm)		DG (dBi)		EIRP Power Limit (dBm)	Pass/Fail
					Ant 1	Ant 2	Ant 1	Ant 2	SUM	Ant 1	Ant 2	Ant 1	Ant 2		
11a	6Mbps	1	52	5260	0.17	0.27	17.67	17.57				-2.40	-3.10	30	Pass
11a	6Mbps	1	60	5300	0.17	0.27	17.70	17.68				-2.40	-3.10	30	Pass
11a	6Mbps	1	64	5320	0.17	0.27	17.77	17.73				-2.40	-3.10	30	Pass
HT20	MCS0	1	52	5260	0.20	0.18	17.60	17.58				-2.40	-3.10	30	Pass
HT20	MCS0	1	60	5300	0.20	0.18	17.64	17.61				-2.40	-3.10	30	Pass
HT20	MCS0	1	64	5320	0.20	0.18	17.85	17.63				-2.40	-3.10	30	Pass
HT40	MCS0	1	54	5270	0.37	0.29	16.84	16.59				-2.40	-3.10	30	Pass
HT40	MCS0	1	62	5310	0.37	0.29	15.22	15.13				-2.40	-3.10	30	Pass
VHT20	MCS0	1	52	5260	0.18	0.18	17.65	17.59				-2.40	-3.10	30	Pass
VHT20	MCS0	1	60	5300	0.18	0.18	17.68	17.61				-2.40	-3.10	30	Pass
VHT20	MCS0	1	64	5320	0.18	0.18	17.80	17.68				-2.40	-3.10	30	Pass
VHT40	MCS0	1	54	5270	0.33	0.37	17.19	17.01				-2.40	-3.10	30	Pass
VHT40	MCS0	1	62	5310	0.33	0.37	15.22	15.17				-2.40	-3.10	30	Pass
VHT80	MCS0	1	58	5290	0.63	0.63	13.78	13.73				-2.40	-3.10	30	Pass
11a	6Mbps	2	52	5260	0.17	0.17	17.69	17.58	20.65			-2.40		30	Pass
11a	6Mbps	2	60	5300	0.17	0.17	17.71	17.67	20.70			-2.40		30	Pass
11a	6Mbps	2	64	5320	0.17	0.17	17.79	17.74	20.78			-2.40		30	Pass
HT20	MCS0	2	52	5260	0.18	0.18	17.66	17.59	20.64			-2.40		30	Pass
HT20	MCS0	2	60	5300	0.18	0.18	17.71	17.62	20.68			-2.40		30	Pass
HT20	MCS0	2	64	5320	0.18	0.18	17.86	17.64	20.76			-2.40		30	Pass
HT40	MCS0	2	54	5270	0.37	0.33	16.93	16.60	19.78			-2.40		30	Pass
HT40	MCS0	2	62	5310	0.37	0.33	15.27	15.14	18.22			-2.40		30	Pass
VHT20	MCS0	2	52	5260	0.18	0.18	17.68	17.60	20.65			-2.40		30	Pass
VHT20	MCS0	2	60	5300	0.18	0.18	17.69	17.63	20.67			-2.40		30	Pass
VHT20	MCS0	2	64	5320	0.18	0.18	17.81	17.69	20.76			-2.40		30	Pass
VHT40	MCS0	2	54	5270	0.33	0.29	17.25	17.04	20.16			-2.40		30	Pass
VHT40	MCS0	2	62	5310	0.33	0.29	15.33	15.19	18.27			-2.40		30	Pass
VHT80	MCS0	2	58	5290	0.70	0.63	13.90	13.53	16.73			-2.40		30	Pass

TEST RESULTS DATA
Average Power Table

FCC Band III															
Mod.	Data Rate	NTX	CH.	Freq. (MHz)	Duty Factor (dB)		Average Conducted Power (dBm)			FCC Conducted Power Limit (dBm)		DG (dBi)		EIRP Power Limit (dBm)	Pass/Fail
					Ant 1	Ant 2	Ant 1	Ant 2	SUM	Ant 1	Ant 2	Ant 1	Ant 2		
11a	6Mbps	1	100	5500	0.17	0.27	17.81	17.77				-2.40	-3.50	30	Pass
11a	6Mbps	1	116	5580	0.17	0.27	17.79	17.66				-2.40	-3.50	30	Pass
11a	6Mbps	1	140	5700	0.17	0.27	17.52	17.24				-2.40	-3.50	30	Pass
HT20	MCS0	1	100	5500	0.20	0.18	17.90	17.67				-2.40	-3.50	30	Pass
HT20	MCS0	1	116	5580	0.20	0.18	17.75	17.62				-2.40	-3.50	30	Pass
HT20	MCS0	1	140	5700	0.20	0.18	16.90	16.73				-2.40	-3.50	30	Pass
HT40	MCS0	1	102	5510	0.37	0.29	17.42	17.19				-2.40	-3.50	30	Pass
HT40	MCS0	1	110	5550	0.37	0.29	17.37	17.14				-2.40	-3.50	30	Pass
HT40	MCS0	1	134	5670	0.37	0.29	17.11	17.00				-2.40	-3.50	30	Pass
VHT20	MCS0	1	100	5500	0.18	0.18	17.88	17.80				-2.40	-3.50	30	Pass
VHT20	MCS0	1	116	5580	0.18	0.18	17.78	17.73				-2.40	-3.50	30	Pass
VHT20	MCS0	1	140	5700	0.18	0.18	16.40	16.36				-2.40	-3.50	30	Pass
VHT40	MCS0	1	102	5510	0.33	0.37	17.53	17.35				-2.40	-3.50	30	Pass
VHT40	MCS0	1	110	5550	0.33	0.37	17.45	17.23				-2.40	-3.50	30	Pass
VHT40	MCS0	1	134	5670	0.33	0.37	17.16	17.13				-2.40	-3.50	30	Pass
VHT80	MCS0	1	106	5530	0.63	0.63	15.13	15.06				-2.40	-3.50	30	Pass
VHT80	MCS0	1	122	5610	0.63	0.63	17.83	17.53				-2.40	-3.50	30	Pass
11a	6Mbps	2	100	5500	0.17	0.17	17.87	17.78	20.84			-2.40		30	Pass
11a	6Mbps	2	116	5580	0.17	0.17	17.80	17.72	20.77			-2.40		30	Pass
11a	6Mbps	2	140	5700	0.17	0.17	17.53	17.26	20.41			-2.40		30	Pass
HT20	MCS0	2	100	5500	0.18	0.18	17.91	17.68	20.81			-2.40		30	Pass
HT20	MCS0	2	116	5580	0.18	0.18	17.78	17.71	20.76			-2.40		30	Pass
HT20	MCS0	2	140	5700	0.18	0.18	17.03	16.75	19.91			-2.40		30	Pass
HT40	MCS0	2	102	5510	0.37	0.33	17.57	17.36	20.48			-2.40		30	Pass
HT40	MCS0	2	110	5550	0.37	0.33	17.55	17.15	20.37			-2.40		30	Pass
HT40	MCS0	2	134	5670	0.37	0.33	17.39	17.13	20.27			-2.40		30	Pass
VHT20	MCS0	2	100	5500	0.18	0.18	17.98	17.81	20.91			-2.40		30	Pass
VHT20	MCS0	2	116	5580	0.18	0.18	17.83	17.74	20.80			-2.40		30	Pass
VHT20	MCS0	2	140	5700	0.18	0.18	16.68	16.36	19.54			-2.40		30	Pass
VHT40	MCS0	2	102	5510	0.33	0.29	17.71	17.37	20.55			-2.40		30	Pass
VHT40	MCS0	2	110	5550	0.33	0.29	17.53	17.24	20.40			-2.40		30	Pass
VHT40	MCS0	2	134	5670	0.33	0.29	17.28	17.14	20.22			-2.40		30	Pass
VHT80	MCS0	2	106	5530	0.70	0.63	15.45	15.17	18.32			-2.40		30	Pass
VHT80	MCS0	2	122	5610	0.70	0.63	17.85	17.58	20.73			-2.40		30	Pass

TEST RESULTS DATA
Average Power Table

FCC Straddle Channel														
Mod.	Data Rate	NTX	CH.	Freq. (MHz)	Duty Factor (dB)		Average Conducted Power (dBm)			FCC Conducted Power Limit (dBm)		DG (dBi)		Pass/Fail
					Ant 1	Ant 2	Ant 1	Ant 2	SUM	Ant 1	Ant 2	Ant 1	Ant 2	
11a	6Mbps	1	144	5720	0.17	0.27	17.77	17.67		-	-	-2.40	-3.50	-
HT20	MCS0	1	144	5720	0.20	0.18	17.90	17.68		-	-	-2.40	-3.50	-
HT40	MCS0	1	142	5710	0.37	0.29	17.10	16.80		-	-	-2.40	-3.50	-
VHT20	MCS0	1	144	5720	0.18	0.18	17.78	17.72		-	-	-2.40	-3.50	-
VHT40	MCS0	1	142	5710	0.33	0.37	17.16	16.60		-	-	-2.40	-3.50	-
VHT80	MCS0	1	138	5690	0.63	0.63	17.90	17.65		-	-	-2.40	-3.50	-
11a	6Mbps	2	144	5720	0.17	0.17	17.78	17.68	20.74	-	-	-2.40	-	-
HT20	MCS0	2	144	5720	0.18	0.18	17.68	17.65	20.68	-	-	-2.40	-	-
HT40	MCS0	2	142	5710	0.37	0.33	17.06	16.80	19.94	-	-	-2.40	-	-
VHT20	MCS0	2	144	5720	0.18	0.18	17.69	17.50	20.61	-	-	-2.40	-	-
VHT40	MCS0	2	142	5710	0.33	0.29	17.00	16.70	19.86	-	-	-2.40	-	-
VHT80	MCS0	2	138	5690	0.70	0.63	18.00	17.80	20.91	-	-	-2.40	-	-



Appendix B. Radiated Spurious Emission

Test Engineer :	J.C. Liang, Jacky Hung, and Kan Wu	Temperature :	18~22°C
		Relative Humidity :	55~58%

Band 1 - 5150~5250MHz

WIFI 802.11n HT40 (Band Edge @ 3m)

WIFI Ant. 1+2	Note	Frequency (MHz)	Level (dBμV/m)	Over Limit (dB)	Limit Line (dBμV/m)	Read Level (dBμV)	Antenna Factor (dB/m)	Cable Loss (dB)	Preamp Factor (dB)	Ant Pos (cm)	Table Pos (deg)	Peak Avg. (P/A)	Pol. (H/V)
802.11n HT40 CH 38 5190MHz		5144.04	62.8	-11.2	74	54.73	32.05	9.05	33.03	100	122	P	H
		5146.64	53.87	-0.13	54	45.8	32.05	9.05	33.03	100	122	P	H
	*	5190	104.41	-	-	96.28	32.08	9.08	33.03	100	122	P	H
	*	5190	96.09	-	-	87.96	32.08	9.08	33.03	100	122	A	H
		5438.64	49.52	-24.48	74	40.94	32.33	9.27	33.02	100	122	P	H
		5459.76	41.25	-12.75	54	32.63	32.35	9.29	33.02	100	122	A	H
		5146.38	61.3	-12.7	74	53.23	32.05	9.05	33.03	309	65	P	V
		5149.5	50.07	-3.93	54	42	32.05	9.05	33.03	309	65	A	V
	*	5190	102.43	-	-	94.3	32.08	9.08	33.03	309	65	P	V
	*	5190	94.45	-	-	86.32	32.08	9.08	33.03	309	65	A	V
		5395.04	49.22	-24.78	74	40.72	32.3	9.22	33.02	309	65	P	V
	5453	40.81	-13.19	54	32.19	32.35	9.29	33.02	309	65	A	V	
Remark	<ol style="list-style-type: none"> No other spurious found. All results are PASS against Peak and Average limit line. 												



Band 1 5150~5250MHz
WIFI 802.11n HT40 (Harmonic @ 3m)

WIFI Ant. 1+2	Note	Frequency (MHz)	Level (dBμV/m)	Over Limit (dB)	Limit Line (dBμV/m)	Read Level (dBμV)	Antenna Factor (dB/m)	Cable Loss (dB)	Preamp Factor (dB)	Ant Pos (cm)	Table Pos (deg)	Peak Avg. (P/A)	Pol. (H/V)
802.11n HT40 CH 38		10380	47.5	-26.5	74	58.98	38.44	14.97	65.2	100	0	P	H
		15570	47.7	-26.3	74	55.21	37.45	18.71	64.05	100	0	P	H
													H
													H
5190MHz		10380	48.55	-25.45	74	60.03	38.44	14.97	65.2	100	0	P	V
		15570	55.03	-18.97	74	62.54	37.45	18.71	64.05	100	287	P	V
		15570	45.06	-8.94	54	52.57	37.45	18.71	64.05	100	287	A	V
													V
Remark	1. No other spurious found. 2. All results are PASS against Peak and Average limit line.												



Band 2 - 5250~5350MHz

WIFI 802.11n HT40 (Band Edge @ 3m)

WIFI	Note	Frequency	Level	Over	Limit	Read	Antenna	Cable	Preamp	Ant	Table	Peak	Pol.
Ant.				Limit	Line	Level	Factor	Loss	Factor	Pos	Pos	Avg.	
1+2		(MHz)	(dBμV/m)	(dB)	(dBμV/m)	(dBμV)	(dB/m)	(dB)	(dB)	(cm)	(deg)	(P/A)	(H/V)
802.11n HT40 CH 62 5310MHz		5075.14	49.23	-24.77	74	41.3	31.98	8.99	33.04	107	121	P	H
		5122.06	41.79	-12.21	54	33.78	32.02	9.02	33.03	107	121	A	H
	*	5310	104.28	-	-	95.93	32.22	9.16	33.03	107	121	P	H
	*	5310	95.35	-	-	87	32.22	9.16	33.03	107	121	A	H
		5351.28	63.15	-10.85	74	54.74	32.25	9.19	33.03	107	121	P	H
		5350.08	53.87	-0.13	54	45.46	32.25	9.19	33.03	107	121	A	H
		5075.14	50.03	-23.97	74	42.1	31.98	8.99	33.04	312	92	P	V
		5074.46	41.67	-12.33	54	33.74	31.98	8.99	33.04	312	92	A	V
	*	5310	102.72	-	-	94.37	32.22	9.16	33.03	312	92	P	V
	*	5310	95.02	-	-	86.67	32.22	9.16	33.03	312	92	A	V
		5360.64	60.51	-13.49	74	52.07	32.27	9.2	33.03	312	92	P	V
		5352.48	52.15	-1.85	54	43.74	32.25	9.19	33.03	312	92	A	V
Remark	1. No other spurious found. 2. All results are PASS against Peak and Average limit line.												



Band 2 5250~5350MHz
WIFI 802.11n HT40 (Harmonic @ 3m)

Table with 14 columns: WIFI Ant. 1+2, Note, Frequency (MHz), Level (dBµV/m), Over Limit (dB), Limit Line (dBµV/m), Read Level (dBµV), Antenna Factor (dB/m), Cable Loss (dB), Preamp Factor (dB), Ant Pos (cm), Table Pos (deg), Peak Avg. (P/A), Pol. (H/V). Rows include data for 802.11n HT40 CH 62 at 5310MHz and a Remark section.



Band 3 - 5470~5725MHz

WIFI 802.11ac VHT80 (Band Edge @ 3m)

WIFI	Note	Frequency	Level	Over	Limit	Read	Antenna	Cable	Preamp	Ant	Table	Peak	Pol.
Ant.				Limit	Line	Level	Factor	Loss	Factor	Pos	Pos	Avg.	
1+2		(MHz)	(dBμV/m)	(dB)	(dBμV/m)	(dBμV)	(dB/m)	(dB)	(dB)	(cm)	(deg)	(P/A)	(H/V)
802.11ac VHT80 CH 106 5530MHz		5454.88	62.09	-11.91	74	53.47	32.35	9.29	33.02	101	214	P	H
		5467.84	65.05	-3.15	68.2	56.39	32.37	9.31	33.02	101	214	P	H
		5448.4	53.36	-0.64	54	44.74	32.35	9.29	33.02	101	214	A	H
	*	5530	101.83	-	-	93.05	32.44	9.39	33.05	101	214	P	H
	*	5530	92.79	-	-	84.01	32.44	9.39	33.05	101	214	A	H
		5741.375	50.79	-17.41	68.2	41.09	32.98	9.87	33.15	101	214	P	H
		5452.96	61.13	-12.87	74	52.51	32.35	9.29	33.02	323	84	P	V
		5469.52	61.46	-6.74	68.2	52.8	32.37	9.31	33.02	323	84	P	V
		5452.24	51.6	-2.4	54	42.98	32.35	9.29	33.02	323	84	A	V
	*	5530	100.23	-	-	91.45	32.44	9.39	33.05	323	84	P	V
	*	5530	91.73	-	-	82.95	32.44	9.39	33.05	323	84	A	V
		5756.95	51.69	-16.51	68.2	41.91	33.02	9.92	33.16	323	84	P	V
Remark	1. No other spurious found. 2. All results are PASS against Peak and Average limit line.												



Band 3 5470~5725MHz
WIFI 802.11ac VHT80 (Harmonic @ 3m)

WIFI Ant. 1+2	Note	Frequency (MHz)	Level (dBμV/m)	Over Limit (dB)	Limit Line (dBμV/m)	Read Level (dBμV)	Antenna Factor (dB/m)	Cable Loss (dB)	Preamp Factor (dB)	Ant Pos (cm)	Table Pos (deg)	Peak Avg. (P/A)	Pol. (H/V)	
802.11ac VHT80 CH 106 5530MHz		11060	45.81	-28.19	74	56.11	39.11	15.44	65.14	100	0	P	H	
		16590	46.08	-22.12	68.2	53.51	37.76	19.52	65.01	100	0	P	H	
													H	
													H	
			11060	47.55	-26.45	74	58.14	39.11	15.44	65.14	100	0	P	V
			16590	45.19	-23.01	68.2	52.62	37.76	19.52	65.01	100	0	P	V
														V
														V
Remark	1. No other spurious found. 2. All results are PASS against Peak and Average limit line.													



Emission below 1GHz
WIFI 802.11n HT40 (LF @ 3m)

WIFI	Note	Frequency	Level	Over	Limit	Read	Antenna	Cable	Preamp	Ant	Table	Peak	Pol.	
Ant.				Limit	Line	Level	Factor	Loss	Factor	Pos	Pos	Avg.		
1+2		(MHz)	(dBμV/m)	(dB)	(dBμV/m)	(dBμV)	(dB/m)	(dB)	(dB)	(cm)	(deg)	(P/A)	(H/V)	
802.11n HT40 LF		67.8	30.59	-9.41	40	49.88	12.12	1.06	32.49	100	0	P	H	
		194.7	23.92	-19.58	43.5	39.68	14.84	1.72	32.39			P	H	
		264.9	25.69	-20.31	46	36.41	19.54	2.04	32.38			P	H	
		783.7	31.08	-14.92	46	31.33	28.33	3.5	32.23			P	H	
		879.6	31.8	-14.2	46	30.45	29.22	3.73	31.76			P	H	
		947.5	32.9	-13.1	46	29.45	30.69	3.82	31.23			P	H	
													H	
													H	
													H	
													H	
													H	
													H	
			30	35.16	-4.84	40	42.59	24.36	0.68	32.5	100	0	P	V
			45.93	30.16	-9.84	40	45.48	16.23	0.94	32.49			P	V
			165.27	20.31	-23.19	43.5	34.97	15.97	1.69	32.42			P	V
			556.9	27.27	-18.73	46	30.64	25.99	2.98	32.43			P	V
			789.3	30.96	-15.04	46	31.21	28.31	3.5	32.21			P	V
			927.2	32.55	-13.45	46	30.12	29.86	3.81	31.41			P	V
														V
														V
													V	
													V	
													V	
													V	
Remark	1. No other spurious found. 2. All results are PASS against limit line.													



Note symbol

*	Fundamental Frequency which can be ignored. However, the level of any unwanted emissions shall not exceed the level of the fundamental frequency.
!	Test result is over limit line.
P/A	Peak or Average
H/V	Horizontal or Vertical



A calculation example for radiated spurious emission is shown as below:

WIFI	Note	Frequency	Level	Over	Limit	Read	Antenna	Cable	Preamp	Ant	Table	Peak	Pol.
Ant.				Limit	Line	Level	Factor	Loss	Factor	Pos	Pos	Avg.	
1+2		(MHz)	(dBμV/m)	(dB)	(dBμV/m)	(dBμV)	(dB/m)	(dB)	(dB)	(cm)	(deg)	(P/A)	(H/V)
802.11b		2390	55.45	-18.55	74	54.51	32.22	4.58	35.86	103	308	P	H
CH 01													
2412MHz		2390	43.54	-10.46	54	42.6	32.22	4.58	35.86	103	308	A	H

- Level(dBμV/m) =
Antenna Factor(dB/m) + Cable Loss(dB) + Read Level(dBμV) - Preamp Factor(dB)
- Over Limit(dB) = Level(dBμV/m) – Limit Line(dBμV/m)

For Peak Limit @ 2390MHz:

- Level(dBμV/m)
= Antenna Factor(dB/m) + Cable Loss(dB) + Read Level(dBμV) - Preamp Factor(dB)
= 32.22(dB/m) + 4.58(dB) + 54.51(dBμV) – 35.86 (dB)
= 55.45 (dBμV/m)
- Over Limit(dB)
= Level(dBμV/m) – Limit Line(dBμV/m)
= 55.45(dBμV/m) – 74(dBμV/m)
= -18.55(dB)

For Average Limit @ 2390MHz:

- Level(dBμV/m)
= Antenna Factor(dB/m) + Cable Loss(dB) + Read Level(dBμV) - Preamp Factor(dB)
= 32.22(dB/m) + 4.58(dB) + 42.6(dBμV) – 35.86 (dB)
= 43.54 (dBμV/m)
- Over Limit(dB)
= Level(dBμV/m) – Limit Line(dBμV/m)
= 43.54(dBμV/m) – 54(dBμV/m)
= -10.46(dB)

Both peak and average measured complies with the limit line, so test result is “PASS”.



Appendix C. Radiated Spurious Emission

Test Engineer :	J.C. Liang, Jacky Hung, and Kan Wu	Temperature :	18~22°C
		Relative Humidity :	55~58%

Note symbol

-L	Low channel location
-R	High channel location

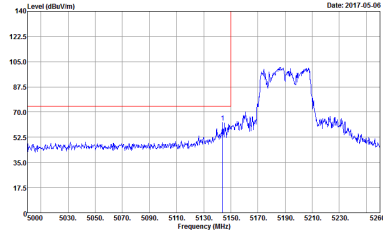
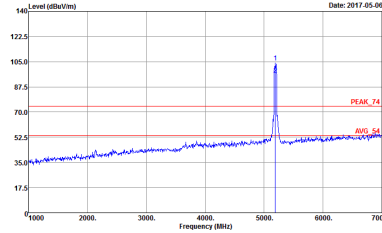
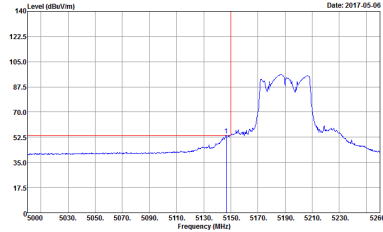

Band 1 - 5150~5250MHz
WIFI 802.11n HT40 (Band Edge @ 3m)

WIFI	Band 1 5150~5250MHz Band Edge @ 3m	
ANT	802.11n HT40 CH38 5190MHz - L	
1+2	Horizontal	Fundamental
<p align="center">Peak</p>	 <p>Site : 03CH11-HY Condition : PEAK_BE_74 3m HORN 9120D-HF HORIZONTAL Detector : Peak Project : 733129-06 Setting : 16</p>	 <p>Site : 03CH11-HY Condition : PEAK_74 3m HORN 9120D-HF HORIZONTAL Detector : Peak Project : 733129-06 Setting : 16</p>
<p align="center">Avg.</p>	 <p>Site : 03CH11-HY Condition : AVG_BE_54 3m HORN 9120D-HF HORIZONTAL Detector : Peak Project : 733129-06 Setting : 16</p>	<p align="center">Left blank</p>



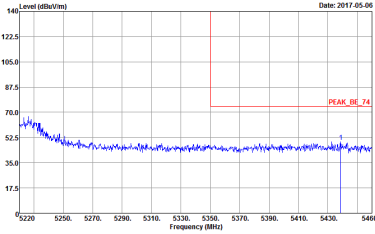
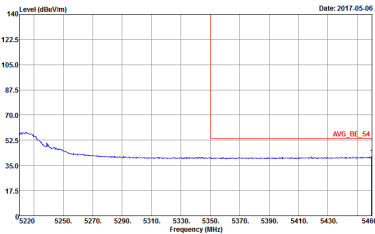

WIFI	Band 1 5150~5250MHz Band Edge @ 3m	
ANT	802.11n HT40 CH38 5190MHz - R	
1+2	Horizontal	Fundamental
<p>Peak</p>	 <p>Site : 03CH11-HY Condition : PEAK_BE_74 3m HORN 91200-HF HORIZONTAL RBW:1000.000kHz VBW:3000.000kHz SWF:Auto Detector : Peak Project : 733129-06 Setting : 16</p>	<p>Left blank</p>
<p>Avg.</p>	 <p>Site : 03CH11-HY Condition : AVG_BE_54 3m HORN 91200-HF HORIZONTAL RBW:1000.000kHz VBW:3.000kHz SWF:Auto Detector : Peak Project : 733129-06 Setting : 16</p>	<p>Left blank</p>



WIFI	Band 1 5150~5250MHz Band Edge @ 3m	
ANT	802.11n HT40 CH38 5190MHz - L	
1+2	Vertical	Fundamental
Peak	<p> Site : 03CH11-HY Condition : PEAK_BE_74 3m HORN 91200-HF VERTICAL RBW:1000.000kHz VBW:3000.000kHz SWT:Auto Detector : Peak Project : 733129-06 Setting : 16 </p>	<p> Site : 03CH11-HY Condition : PEAK_74 3m HORN 91200-HF VERTICAL RBW:1000.000kHz VBW:3000.000kHz SWT:Auto Detector : Peak Project : 733129-06 Setting : 16 </p>
Avg.	<p> Site : 03CH11-HY Condition : AVG_BE_54 3m HORN 91200-HF VERTICAL RBW:1000.000kHz VBW:3.000kHz SWT:Auto Detector : Peak Project : 733129-06 Setting : 16 </p>	Left blank

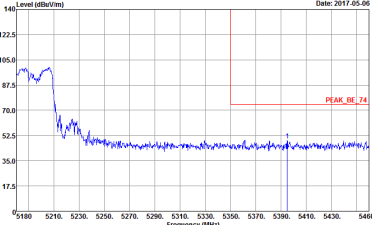

WIFI	Band 1 5150~5250MHz Band Edge @ 3m	
ANT	802.11n HT40 CH38 5190MHz - R	
1+2	Vertical	Fundamental
<p>Peak</p>	 <p>Site : 03CH11-HY Condition : PEAK_BE_74 3m HORN 91200-HF VERTICAL RBW:1000.000kHz VBW:3000.000kHz SWF:Auto Detector : Peak Project : 733129-06 Setting : 16</p>	<p>Left blank</p>
<p>Avg.</p>	 <p>Site : 03CH11-HY Condition : AVG_BE_54 3m HORN 91200-HF VERTICAL RBW:1000.000kHz VBW:3.000kHz SWF:Auto Detector : Peak Project : 733129-06 Setting : 16</p>	<p>Left blank</p>



Band 1 - 5150~5250MHz
WIFI 802.11n HT40 (Harmonic @ 3m)

Table with 2 columns: Horizontal and Vertical. Each column contains a graph of Level (dBuV/m) vs Frequency (MHz) and associated test parameters like Site, Condition, Detector, Project, and Setting.

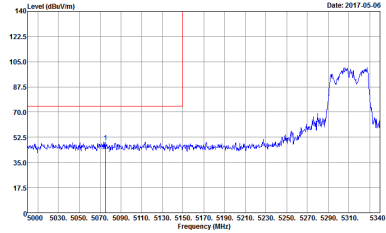
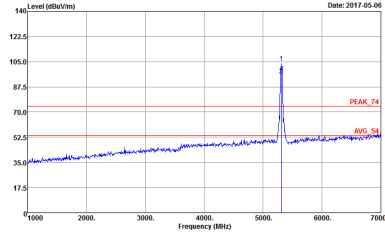
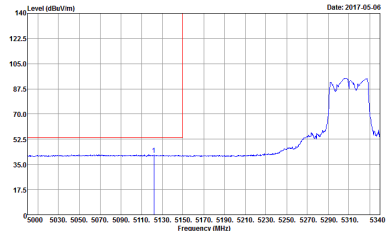

Band 2 - 5250~5350MHz
WIFI 802.11n HT40 (Band Edge @ 3m)

WIFI	Band 2 5250~5350MHz Band Edge @ 3m	
ANT	802.11n HT40 CH62 5310 - L	
1+2	Horizontal	Fundamental
<p align="center">Peak</p>	 <p>Site : 03CH11-HY Condition : PEAK_BE_74 3m HORN 9120D-HF HORIZONTAL RBW:1000.000KHz VBW:3000.000KHz SWT:Auto Detector : Peak Project : 733129-06 Setting : 16.5</p>	 <p>Site : 03CH11-HY Condition : PEAK_74 3m HORN 9120D-HF HORIZONTAL RBW:1000.000KHz VBW:3000.000KHz SWT:Auto Detector : Peak Project : 733129-06 Setting : 16.5</p>
<p align="center">Avg.</p>	 <p>Site : 03CH11-HY Condition : AVG_BE_54 3m HORN 9120D-HF HORIZONTAL RBW:1000.000KHz VBW:3000KHz SWT:Auto Detector : Peak Project : 733129-06 Setting : 16.5</p>	<p align="center">Left blank</p>

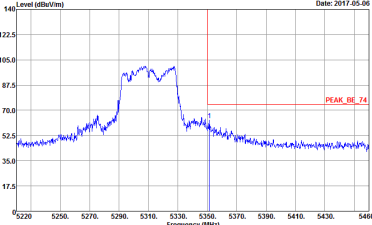
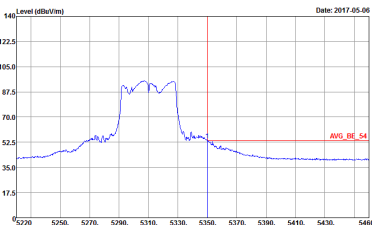

WIFI	Band 2 5250~5350MHz Band Edge @ 3m	
ANT	802.11n HT40 CH62 5310 - R	
1+2	Horizontal	Fundamental
<p>Peak</p>	 <p>Site : 03CH11-HY Condition : PEAK_BE_74 3m HORN 91200-HF HORIZONTAL RBW:1000.000kHz VBW:3000.000kHz SWF:Auto Detector : Peak Project : 733129-06 Setting : 16.5</p>	<p>Left blank</p>
<p>Avg.</p>	 <p>Site : 03CH11-HY Condition : AVG_BE_54 3m HORN 91200-HF HORIZONTAL RBW:1000.000kHz VBW:3.000kHz SWF:Auto Detector : Peak Project : 733129-06 Setting : 16.5</p>	<p>Left blank</p>



WIFI	Band 2 5250~5350MHz Band Edge @ 3m	
ANT	802.11n HT40 CH62 5310 - L	
1+2	Vertical	Fundamental
Peak	<p> Site : 03CH11-HY Condition : PEAK_BE_74 3m HORN 91200-HF VERTICAL RBW:1000.000kHz VBW:3000.000kHz SWT:Auto Detector : Peak Project : 733129-06 Setting : 16.5 </p>	<p> Site : 03CH11-HY Condition : PEAK_74 3m HORN 91200-HF VERTICAL RBW:1000.000kHz VBW:3000.000kHz SWT:Auto Detector : Peak Project : 733129-06 Setting : 16.5 </p>
Avg.	<p> Site : 03CH11-HY Condition : AVG_BE_54 3m HORN 91200-HF VERTICAL RBW:1000.000kHz VBW:3.000kHz SWT:Auto Detector : Peak Project : 733129-06 Setting : 16.5 </p>	Left blank

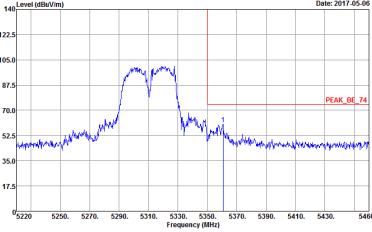
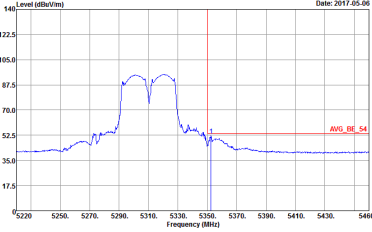

WIFI	Band 2 5250~5350MHz Band Edge @ 3m	
ANT	802.11n HT40 CH62 5310 - R	
1+2	Vertical	Fundamental
<p>Peak</p>	 <p>Site : 03CH11-HY Condition : PEAK_BE_74 3m HORN 91200-HF VERTICAL RBW:1000.000kHz VBW:3000.000kHz SWF:Auto Detector : Peak Project : 733129-06 Setting : 16.5</p>	<p>Left blank</p>
<p>Avg.</p>	 <p>Site : 03CH11-HY Condition : AVG_BE_54 3m HORN 91200-HF VERTICAL RBW:1000.000kHz VBW:3.000kHz SWF:Auto Detector : Peak Project : 733129-06 Setting : 16.5</p>	<p>Left blank</p>



Band 2 - 5250~5350MHz
WIFI 802.11n HT40 (Harmonic @ 3m)

WIFI	Band 2 5250~5350MHz Harmonic @ 3m	
ANT	802.11n HT40 CH62 5310	
1+2	Horizontal	Vertical
Peak Avg.	<p>Site : 03CH11-1FY Condition : PEAK_74 3m 9170 5HF HORM_150809 HORIZONTAL Detector : Peak Project : 733129-06 Setting : 16.5</p>	<p>Site : 03CH11-1FY Condition : PEAK_74 3m 9170 5HF HORM_150809 VERTICAL Detector : Peak Project : 733129-06 Setting : 16.5</p>

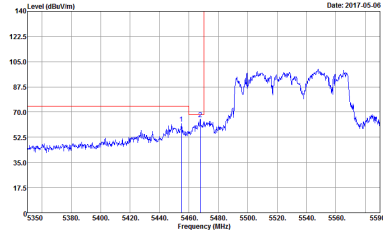
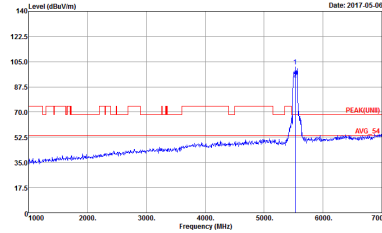
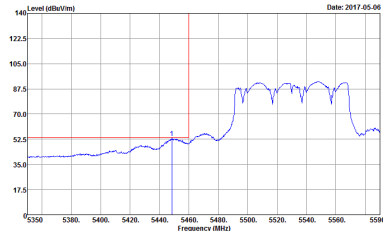

Band 3 - 5470~5725MHz
WIFI 802.11ac VHT80 (Band Edge @ 3m)

WIFI	Band 3 5470~5725MHz Band Edge @ 3m	
ANT	802.11ac VHT80 CH106 5530MHz - L	
1+2	Horizontal	Fundamental
<p align="center">Peak</p>	 <p>Site : 03CH11-HY Condition : PEAK_BE(UNIT)_B3 3m HORN 9120D-HF HORIZONTAL Detector : Peak Project : 733129-06 Setting : 16 : 68.2</p>	 <p>Site : 03CH11-HY Condition : PEAK(UNIT) 3m HORN 9120D-HF HORIZONTAL Detector : Peak Project : 733129-06 Setting : 16 : 68.2</p>
<p align="center">Avg.</p>	 <p>Site : 03CH11-HY Condition : AVG_BE(UNIT)_B3 3m HORN 9120D-HF HORIZONTAL Detector : Peak Project : 733129-06 Setting : 16 : 68.2</p>	<p align="center">Left blank</p>



WIFI	Band 3 5470~5725MHz Band Edge @ 3m	
ANT	802.11ac VHT80 CH106 5530MHz - R	
1+2	Horizontal	Fundamental
Peak	<p>Site : 03CH11-HY Condition : PEAK_BE(UNIT)_B3 3m HORN 91200-HF HORIZONTAL RBW:1000.000KHz VBW:3000.000KHz SWF:Auto Detector : Peak Project : 733129-06 Setting : 16 : 68.2</p>	Left blank
Avg.	Left blank	Left blank



WIFI	Band 3 5470~5725MHz Band Edge @ 3m	
ANT	802.11ac VHT80 CH106 5530MHz - L	
1+2	Vertical	Fundamental
Peak	<p>Site : 03CH11-HY Condition : PEAK_BE[UNII]_B3 3m HORN 9120D-HF VERTICAL RBW:1000.000KHz VBW:3000.000KHz SWT:Auto Detector : Peak Project : 733129-06 Setting : 16 : 68.2</p>	<p>Site : 03CH11-HY Condition : PEAK[UNII] 3m HORN 9120D-HF VERTICAL RBW:1000.000KHz VBW:3000.000KHz SWT:Auto Detector : Peak Project : 733129-06 Setting : 16 : 68.2</p>
Avg.	<p>Site : 03CH11-HY Condition : AVG_BE[UNII]_B3 3m HORN 9120D-HF VERTICAL RBW:1000.000KHz VBW:3.000KHz SWT:Auto Detector : Peak Project : 733129-06 Setting : 16 : 68.2</p>	



WIFI	Band 3 5470~5725MHz Band Edge @ 3m	
ANT	802.11ac VHT80 CH106 5530MHz - R	
1+2	Vertical	Fundamental
Peak	<p>Site : 03CH11-HY Condition : PEAK_BE(UNIT)_B3 3m HORN 91200-HF VERTICAL RBW:1000.000KHz VBW:3000.000KHz SWF:Auto Detector : Peak Project : 733129-06 Setting : 16 : 68.2</p>	Left blank
Avg.	Left blank	Left blank



Band 3 - 5470~5725MHz
WIFI 802.11ac VHT80 (Harmonic @ 3m)

WIFI	Band 3 5470~5725MHz Harmonic @ 3m	
ANT	802.11ac VHT80 CH106 5530MHz	
1+2	Horizontal	Vertical
Peak Avg.	<p>Site : 03CH11-4FY Condition : PEAK(LINE1) 3m 9170 SH-F HORM_150809 HORIZONTAL Detector : Peak Project : 733129-06 Setting : 16 : 68.2</p>	<p>Site : 03CH11-4FY Condition : PEAK(LINE1) 3m 9170 SH-F HORM_150809 VERTICAL Detector : Peak Project : 733129-06 Setting : 16 : 68.2</p>



Emission below 1GHz
5GHz WIFI 802.11n HT40 (LF)

WIFI	5GHz WIFI	
ANT	802.11n HT40 LF	
1+2	Horizontal	Vertical
QP / Peak	<p>Site : 03CH11-4FY Condition : QP_3m BT-LOG 6111D-LF_ETC HORIZONTAL Detector : Peak Project : 733129-06</p>	<p>Site : 03CH11-4FY Condition : QP_3m BT-LOG 6111D-LF_ETC VERTICAL Detector : Peak Project : 733129-06</p>



Appendix D. Duty Cycle Plots

Antenna	Band	Duty Cycle(%)	T(us)	1/T(kHz)	VBW Setting
1+2	5GHz 802.11n HT40 for Ant 1	91.87	1356	0.737	1kHz
1+2	5GHz 802.11n HT40 for Ant 2	92.68	1356	0.737	1kHz
1+2	5GHz 802.11ac VHT80 for Ant 1	85.04	648	1.543	3kHz
1+2	5GHz 802.11ac VHT80 for Ant 2	86.49	653	1.531	3kHz



<MIMO Ant. 1>

5GHz 802.11n HT40

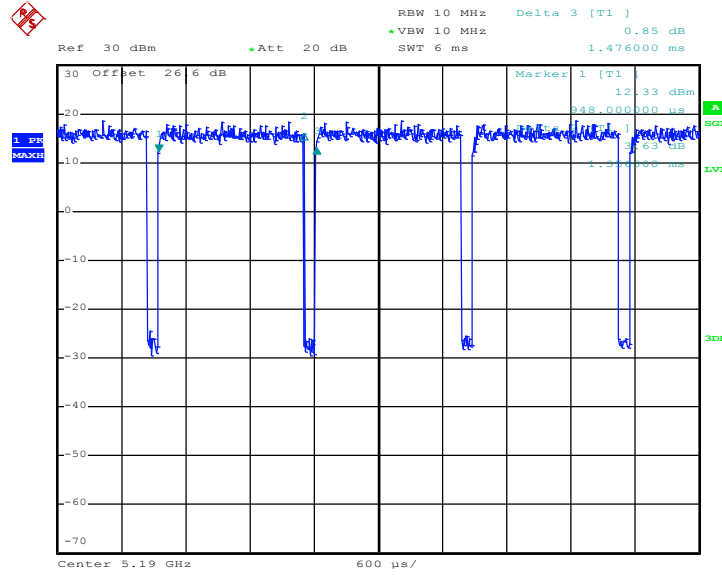

Date: 5.MAY.2017 20:04:13

5GHz 802.11ac VHT80

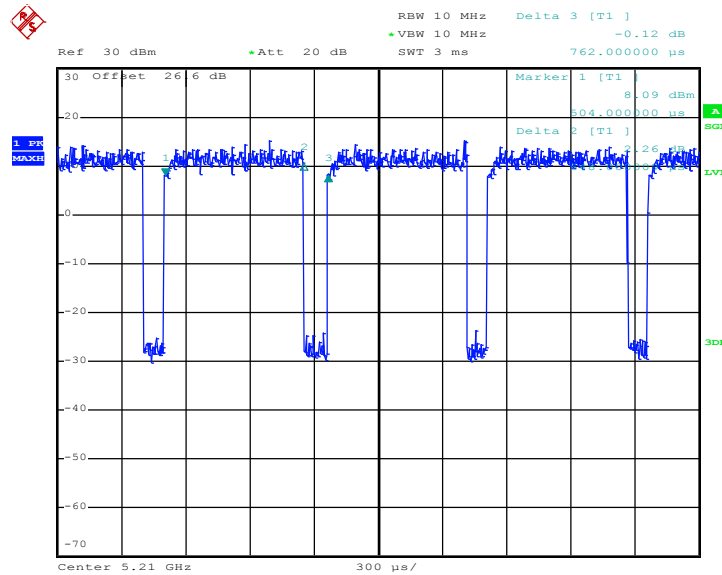

Date: 5.MAY.2017 22:15:08



<MIMO Ant. 2>

5GHz 802.11n HT40

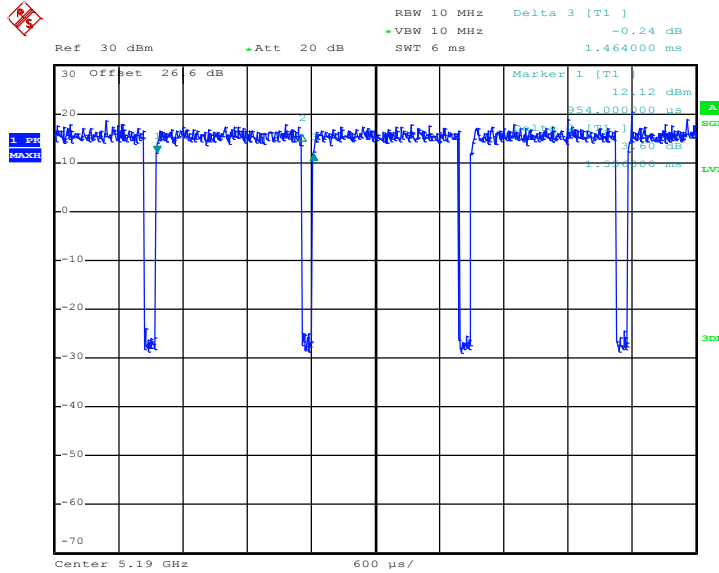

Date: 5.MAY.2017 20:05:10

5GHz 802.11ac VHT80

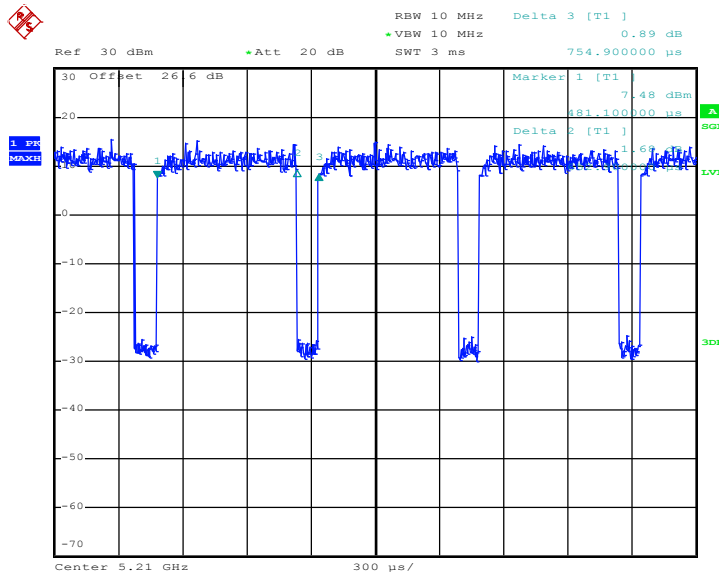

Date: 5.MAY.2017 22:16:43



Appendix E. Original Report

Please refer to Sporton report number FR733129E