



FCC RF Test Report

APPLICANT : Motorola Mobility, LLC
EQUIPMENT : Mobile Cellular Phone
BRAND NAME : Motorola
MODEL NAME : 10722
FCC ID : IHDT56WB4
STANDARD : 47 CFR Part 2, 22(H), 24(E), 27
CLASSIFICATION : PCS Licensed Transmitter Held to Ear (PCE)

The product was received on Mar. 31, 2017 and completely tested on Apr. 28, 2017. We, SPORTON INTERNATIONAL INC., would like to declare that the tested sample has been evaluated in accordance with the test procedures given in ANSI / TIA / EIA-603-D-2010 and the testing has shown the tested sample to be in compliance with the applicable technical standards.

The test results in this report apply exclusively to the tested model / sample. Without written approval of SPORTON INTERNATIONAL INC., the test report shall not be reproduced except in full.

Reviewed by: Joseph Lin / Supervisor

Approved by: Jones Tsai / Manager



SPORTON INTERNATIONAL INC.

No. 52, Hwa Ya 1st Rd., Hwa Ya Technology Park, Kwei-Shan District, Tao Yuan City, Taiwan, R.O.C.

SPORTON INTERNATIONAL INC.

TEL : 886-3-327-3456

FAX : 886-3-328-4978

FCC ID : IHDT56WB4

Page Number : 1 of 33

Report Issued Date : May 10, 2017

Report Version : Rev. 02

Report Template No.: BU5-FGLTE Version 1.6



TABLE OF CONTENTS

REVISION HISTORY.....3
SUMMARY OF TEST RESULT4
1 GENERAL DESCRIPTION5
1.1 Applicant5
1.2 Manufacturer5
1.3 Product Feature of Equipment Under Test.....5
1.4 Product Specification of Equipment Under Test.....6
1.5 Modification of EUT7
1.6 Emission Designator8
1.7 Testing Location11
1.8 Applicable Standards..... 11
2 TEST CONFIGURATION OF EQUIPMENT UNDER TEST12
2.1 Test Mode 12
2.2 Connection Diagram of Test System 16
2.3 Support Unit used in test configuration and system 17
2.4 Measurement Results Explanation Example 17
2.5 Frequency List of Low/Middle/High Channels 18
3 CONDUCTED TEST ITEMS22
3.1 Measuring Instruments 22
3.2 Test Setup 22
3.3 Test Result of Conducted Test 22
3.4 Conducted Output Power and ERP/EIRP 23
3.5 Peak-to-Average Ratio 24
3.6 Occupied Bandwidth 25
3.7 Conducted Band Edge 26
3.8 Conducted Spurious Emission 28
3.9 Frequency Stability 29
4 RADIATED TEST ITEMS30
4.1 Measuring Instruments 30
4.2 Test Setup 30
4.3 Test Result of Radiated Test 30
4.4 Radiated Spurious Emission 31
5 LIST OF MEASURING EQUIPMENT32
6 UNCERTAINTY OF EVALUATION33
APPENDIX A. TEST RESULTS OF CONDUCTED TEST
APPENDIX B. TEST RESULTS OF ERP/EIRP AND RADIATED TEST



SUMMARY OF TEST RESULT

Report Section	FCC Rule	Description	Limit	Result	Remark
3.4	§2.1046	Conducted Output Power	Reporting Only	PASS	-
	§22.913(a)(2)	Effective Radiated Power (Band 5) (Band 26)	ERP < 7 Watt		
	§27.50(c)(10)	Effective Radiated Power (Band 12) (Band 17)	ERP < 3 Watt		
	§24.232(c) §27.50(h)(2)	Equivalent Isotropic Radiated Power (Band 2)(Band 25) (Band 7) (Band 38) (Band 41)	EIRP < 2Watt		
	§27.50(d)(4)	Equivalent Isotropic Radiated Power (Band 4) (Band 66)	EIRP < 1Watt		
3.5	§24.232(d)	Peak-to-Average Ratio	<13 dB	PASS	-
3.6	§2.1049	Occupied Bandwidth	Reporting Only	PASS	-
3.7	§2.1051 §22.917(a) §24.238(a) §27.53(g) §27.53(h)	Conducted Band Edge Measurement (Band 2) (Band 4) (Band 5) (Band 12) (Band 17) (Band 25) (Band 26) (Band 66)	< 43+10log ₁₀ (P[Watts])	PASS	-
	§27.53(m)(4)	Conducted Band Edge Measurement (Band 7) (Band 38) (Band 41)	§27.53(m)(4)		
3.8	§2.1051 §22.917(a) §24.238(a) §27.53(g) §27.53(h)	Conducted Spurious Emission (Band 2) (Band 4) (Band 5) (Band 12) (Band 17) (Band 25) (Band 26) (Band 66)	< 43+10log ₁₀ (P[Watts])	PASS	-
	§2.1051 §27.53(m)(4)	Conducted Spurious Emission (Band 7) (Band 38) (Band 41)	< 55+10log ₁₀ (P[Watts])		
3.9	§2.1055 §22.355	Frequency Stability Temperature & Voltage	< 2.5 ppm for Part 22	PASS	-
	§2.1055 §24.235 §27.54		Within Authorized Band		
4.4	§2.1053 §22.917(a) §24.238(a) §27.53(g) §27.53(h)	Radiated Spurious Emission (Band 2) (Band 4) (Band 5) (Band 12) (Band 13) (Band 17) (Band 25) (Band 26) (Band 66)	< 43+10log ₁₀ (P[Watts])	PASS	Under limit 7.19 dB at 15201.000 MHz
	§2.1053 §27.53(m)(4)	Radiated Spurious Emission (Band 7) (Band 38) (Band 41)	< 55+10log ₁₀ (P[Watts])		



1 General Description

1.1 Applicant

Motorola Mobility, LLC

222 W Merchandise Mart Plaza, Suite 1800, Chicago, IL 60654, United States

1.2 Manufacturer

Motorola Mobility, LLC

222 W Merchandise Mart Plaza, Suite 1800, Chicago, IL 60654, United States

1.3 Product Feature of Equipment Under Test

Product Feature	
Equipment	Mobile Cellular Phone
Brand Name	Motorola
Model Name	10722
FCC ID	IHDT56WB4
IMEI Code	353311080000221 (for Radiation) 353311080000700 (for Conducted)
EUT supports Radios application	GSM/EGPRS/WCDMA/HSPA/LTE/NFC WLAN 11b/g/n HT20 WLAN 11a/n HT20/HT40 WLAN 11ac VHT20/VHT40/VHT80 Bluetooth BR/EDR/LE
HW Version	DVT2
EUT Stage	Identical Prototype

Accessory List	
AC Adapter 1	Brand Name : Motorola
	Model Name : SPN5970A
AC Adapter 2	Brand Name : Motorola
	Model Name : SPN5993A
AC Adapter 3	Brand Name : Motorola
	Model Name : SPN5978A
Battery 1	Brand Name : Motorola
	Model Name : SNN5986A
Battery 2	Brand Name : Motorola
	Model Name : SNN5897A
Earphone	Brand Name : Motorola
	Model Name : SH38C16618
USB Cable	Brand Name : Motorola
	Model Name : SKN6473A
USB-C Data Cable	Brand Name : Motorola
	Model Name : SKN6474A



1.4 Product Specification of Equipment Under Test

Standards-related Product Specification	
Tx Frequency	LTE Band 2 : 1850.7 MHz ~ 1909.3 MHz LTE Band 4 : 1710.7 MHz ~ 1754.3 MHz LTE Band 5 : 824.7 MHz ~ 848.3 MHz LTE Band 7 : 2502.5 MHz ~ 2567.5 MHz LTE Band 12 : 699.7 MHz ~ 715.3 MHz LTE Band 17 : 706.5 MHz ~ 713.5 MHz LTE Band 25 : 1850.7MHz ~ 1914.3 MHz LTE Band 26 : 824.7MHz ~ 848.3 MHz LTE Band 38 : 2572.5MHz ~ 2617.5MHz LTE Band 41 : 2547.5 MHz ~ 2652.5 MHz LTE Band 66 : 1710.7 MHz ~ 1779.3 MHz
Rx Frequency	LTE Band 2 : 1930.7 MHz ~ 1989.3 MHz LTE Band 4 : 2110.7 MHz ~ 2154.3 MHz LTE Band 5 : 869.7 MHz ~ 893.3 MHz LTE Band 7 : 2622.5MHz ~ 2687.5 MHz LTE Band 12 : 729.7 MHz ~ 745.3 MHz LTE Band 17 : 736.5 MHz ~ 743.5 MHz LTE Band 25 : 1930.7MHz ~ 1994.3 MHz LTE Band 26 : 869.7MHz ~ 893.3MHz LTE Band 38 : 2572.5MHz ~ 2617.5MHz LTE Band 41 : 2547.5 MHz ~ 2652.5 MHz LTE Band 66 : 2110.7 MHz ~ 2199.3 MHz
Bandwidth	LTE Band 2 : 1.4MHz / 3MHz / 5MHz / 10MHz / 15MHz / 20MHz LTE Band 4 : 1.4MHz / 3MHz / 5MHz / 10MHz / 15MHz / 20MHz LTE Band 5 : 1.4MHz / 3MHz / 5MHz / 10MHz LTE Band 7 : 5MHz / 10MHz / 15MHz / 20MHz LTE Band 12 : 1.4MHz / 3MHz / 5MHz / 10MHz LTE Band 17 : 5MHz / 10MHz LTE Band 25 : 1.4MHz / 3MHz / 5MHz / 10MHz / 15MHz / 20MHz LTE Band 26 : 1.4MHz / 3MHz / 5MHz / 10MHz / 15MHz LTE Band 38 : 5MHz / 10MHz / 15MHz / 20MHz LTE Band 41 : 5MHz / 10MHz / 15MHz / 20MHz LTE Band 66 : 1.4MHz / 3MHz / 5MHz / 10MHz / 15MHz / 20MHz



Standards-related Product Specification	
Maximum Output Power to Antenna	LTE Band 2 : 23.06 dBm
	LTE Band 4 : 22.92 dBm
	LTE Band 5 : 23.66 dBm
	LTE Band 7 : 22.51 dBm
	LTE Band 12 : 23.44 dBm
	LTE Band 17 : 23.43 dBm
	LTE Band 25 : 22.92 dBm
	LTE Band 26 : 23.75 dBm
	LTE Band 38 : 22.33 dBm
	LTE Band 41 : 22.50 dBm
LTE Band 66 : 22.76 dBm	
Type of Modulation	QPSK / 16QAM / 64QAM
Remark : LTE TDD B41 in this device is not a 3GPP compliant band. Regarding LTE TDD B41, the device capability is limited in a narrower frequency range (2545MHz~2655MHz) than is specified in 3GPP 34.121. The detailed implementation is illustrated in the operational description.	

1.5 Modification of EUT

No modifications are made to the EUT during all test items.



1.6 Emission Designator

LTE Band 2		QPSK			16QAM			64QAM		
BW (MHz)	Frequency Range (MHz)	Emission Designator (99%OBW)	Frequency Tolerance (ppm)	Maximum EIRP(W)	Emission Designator (99%OBW)	Frequency Tolerance (ppm)	Maximum EIRP(W)	Emission Designator (99%OBW)	Frequency Tolerance (ppm)	Maximum EIRP(W)
1.4	1850.7 ~ 1909.3	1M10G7D	-	0.1945	1M10W7D	-	0.1538	1M10W7D	-	0.1528
3	1851.5 ~ 1908.5	2M74G7D	-	0.1919	2M73W7D	-	0.1600	2M72W7D	-	0.1535
5	1852.5 ~ 1907.5	4M50G7D	-	0.2163	4M49W7D	-	0.1811	4M51W7D	-	0.1517
10	1855.0 ~ 1905.0	9M09G7D	0.0086	0.2163	9M05W7D	-	0.1799	9M09W7D	-	0.1563
15	1857.5 ~ 1902.5	13M5G7D	-	0.2153	13M5W7D	-	0.1816	13M5W7D	-	0.1592
20	1860.0 ~ 1900.0	18M6G7D	-	0.2168	18M4W7D	-	0.1778	18M4W7D	-	0.1626
LTE Band 25		QPSK			16QAM			64QAM		
BW (MHz)	Frequency Range (MHz)	Emission Designator (99%OBW)	Frequency Tolerance (ppm)	Maximum EIRP(W)	Emission Designator (99%OBW)	Frequency Tolerance (ppm)	Maximum EIRP(W)	Emission Designator (99%OBW)	Frequency Tolerance (ppm)	Maximum EIRP(W)
1.4	1850.7 ~ 1914.3	1M09G7D	-	0.1476	1M09W7D	-	0.1199	1M09W7D	-	0.0973
3	1851.5 ~ 1913.5	2M72G7D	-	0.1483	2M72W7D	-	0.1208	2M72W7D	-	0.0938
5	1852.5 ~ 1912.5	4M47G7D	-	0.1626	4M48W7D	-	0.1352	4M47W7D	-	0.0942
10	1855.0 ~ 1910.0	8M93G7D	0.0087	0.1660	9M03W7D	-	0.1406	8M95W7D	-	0.0959
15	1857.5 ~ 1907.5	13M4G7D	-	0.1637	13M4W7D	-	0.1393	13M3W7D	-	0.1021
20	1860.0 ~ 1905.0	18M2G7D	-	0.1667	18M3W7D	-	0.1426	18M2W7D	-	0.1030
LTE Band 4		QPSK			16QAM			64QAM		
BW (MHz)	Frequency Range (MHz)	Emission Designator (99%OBW)	Frequency Tolerance (ppm)	Maximum EIRP(W)	Emission Designator (99%OBW)	Frequency Tolerance (ppm)	Maximum EIRP(W)	Emission Designator (99%OBW)	Frequency Tolerance (ppm)	Maximum EIRP(W)
1.4	1710.7 ~ 1754.3	1M10G7D	-	0.1905	1M10W7D	-	0.1603	1M09W7D	-	0.1585
3	1711.5 ~ 1753.5	2M72G7D	-	0.1919	2M71W7D	-	0.1607	2M72W7D	-	0.1567
5	1712.5 ~ 1752.5	4M49G7D	-	0.2018	4M49W7D	-	0.1730	4M49W7D	-	0.1585
10	1715.0 ~ 1750.0	9M07G7D	0.0094	0.2051	9M07W7D	-	0.1726	9M07W7D	-	0.1592
15	1717.5 ~ 1747.5	13M5G7D	-	0.2094	13M4W7D	-	0.1778	13M6W7D	-	0.1578
20	1720.0 ~ 1745.0	18M3G7D	-	0.2099	18M4W7D	-	0.1782	18M4W7D	-	0.1652
LTE Band 5		QPSK			16QAM			64QAM		
BW (MHz)	Frequency Range (MHz)	Emission Designator (99%OBW)	Frequency Tolerance (ppm)	Maximum ERP(W)	Emission Designator (99%OBW)	Frequency Tolerance (ppm)	Maximum ERP(W)	Emission Designator (99%OBW)	Frequency Tolerance (ppm)	Maximum EIRP(W)
1.4	824.7 ~ 848.3	1M09G7D	-	0.1247	1M10W7D	-	0.1028	1M10W7D	-	0.0748
3	825.5 ~ 847.5	2M73G7D	-	0.1259	2M72W7D	-	0.1047	2M72W7D	-	0.0746
5	826.5 ~ 846.5	4M49G7D	-	0.1259	4M49W7D	-	0.1038	4M52W7D	-	0.0755
10	829.0 ~ 844.0	9M07G7D	0.0116	0.1262	9M05W7D	-	0.1030	9M03W7D	-	0.0755



LTE Band 7		QPSK			16QAM			64QAM		
BW (MHz)	Frequency Range (MHz)	Emission Designator (99%OBW)	Frequency Tolerance (ppm)	Maximum EIRP(W)	Emission Designator (99%OBW)	Frequency Tolerance (ppm)	Maximum EIRP(W)	Emission Designator (99%OBW)	Frequency Tolerance (ppm)	Maximum EIRP(W)
5	2502.5 ~ 2567.5	4M51G7D	-	0.1435	4M51W7D	-	0.1211	4M51W7D	-	0.1094
10	2505.0 ~ 2565.0	9M07G7D	0.0123	0.1442	9M01W7D	-	0.1213	9M03W7D	-	0.1069
15	2507.5 ~ 2562.5	13M5G7D	-	0.1442	13M5W7D	-	0.1225	13M4W7D	-	0.0951
20	2510.0 ~ 2560.0	18M4G7D	-	0.1449	18M5W7D	-	0.1222	18M3W7D	-	0.0991
LTE Band 12		QPSK			16QAM			64QAM		
BW (MHz)	Frequency Range (MHz)	Emission Designator (99%OBW)	Frequency Tolerance (ppm)	Maximum ERP(W)	Emission Designator (99%OBW)	Frequency Tolerance (ppm)	Maximum ERP(W)	Emission Designator (99%OBW)	Frequency Tolerance (ppm)	Maximum EIRP(W)
1.4	699.7 ~ 715.3	1M09G7D	-	0.1189	1M09W7D	-	0.0989	1M09W7D	-	0.0729
3	700.5 ~ 714.5	2M72G7D	-	0.1191	2M73W7D	-	0.1002	2M73W7D	-	0.0724
5	701.5 ~ 713.5	4M49G7D	-	0.1194	4M49W7D	-	0.1021	4M49W7D	-	0.0714
10	704.0 ~ 711.0	9M09G7D	0.0122	0.1199	9M03W7D	-	0.0995	9M07W7D	-	0.0731
LTE Band 17		QPSK			16QAM			64QAM		
BW (MHz)	Frequency Range (MHz)	Emission Designator (99%OBW)	Frequency Tolerance (ppm)	Maximum ERP(W)	Emission Designator (99%OBW)	Frequency Tolerance (ppm)	Maximum ERP(W)	Emission Designator (99%OBW)	Frequency Tolerance (ppm)	Maximum EIRP(W)
5	706.5 ~ 713.5	4M52G7D	-	0.1194	4M51W7D	-	0.1000	4M50W7D	-	0.0729
10	709.0 ~ 711.0	9M13G7D	0.0131	0.1197	9M03W7D	-	0.0998	9M05W7D	-	0.0728
LTE Band 26		QPSK			16QAM			64QAM		
BW (MHz)	Frequency Range (MHz)	Emission Designator (99%OBW)	Frequency Tolerance (ppm)	Maximum EIRP(W)	Emission Designator (99%OBW)	Frequency Tolerance (ppm)	Maximum EIRP(W)	Emission Designator (99%OBW)	Frequency Tolerance (ppm)	Maximum EIRP(W)
1.4	824.7 ~ 848.3	1M09G7D	-	0.1278	1M10W7D	-	0.1063	1M10W7D	-	0.0776
3	825.5 ~ 847.5	2M72G7D	-	0.1284	2M75W7D	-	0.1071	2M72W7D	-	0.0781
5	826.5 ~ 846.5	4M49G7D	-	0.1278	4M51W7D	-	0.1078	4M51W7D	-	0.0794
10	829.0 ~ 844.0	9M03G7D	0.0136	0.1272	9M05W7D	-	0.1073	8M99W7D	-	0.0792
15	831.5 ~ 841.5	13M5G7D	-	0.1287	13M4W7D	-	0.1103	13M5W7D	-	0.0779



LTE Band 38		QPSK			16QAM			64QAM		
BW (MHz)	Frequency Range (MHz)	Emission Designator (99%OBW)	Frequency Tolerance (ppm)	Maximum EIRP(W)	Emission Designator (99%OBW)	Frequency Tolerance (ppm)	Maximum EIRP(W)	Emission Designator (99%OBW)	Frequency Tolerance (ppm)	Maximum EIRP(W)
5	2572.5 ~ 2617.5	4M50G7D	-	0.1352	4M50W7D	-	0.1099	4M49W7D	-	0.1245
10	2575.0 ~ 2615.0	9M05G7D	0.0114	0.1355	9M03W7D	-	0.1107	9M05W7D	-	0.1253
15	2577.5 ~ 2612.5	13M5G7D	-	0.1368	13M5W7D	-	0.1112	13M5W7D	-	0.1274
20	2580.0 ~ 2610.0	18M5G7D	-	0.1390	18M5W7D	-	0.1122	18M3W7D	-	0.1274
LTE Band 41		QPSK			16QAM			64QAM		
BW (MHz)	Frequency Range (MHz)	Emission Designator (99%OBW)	Frequency Tolerance (ppm)	Maximum EIRP(W)	Emission Designator (99%OBW)	Frequency Tolerance (ppm)	Maximum EIRP(W)	Emission Designator (99%OBW)	Frequency Tolerance (ppm)	Maximum EIRP(W)
5	2547.5 ~ 2652.5	4M50G7D	-	0.1419	4M50W7D	-	0.1132	4M52W7D	-	0.0916
10	2550.0 ~ 2650.0	9M05G7D	0.0115	0.1393	9M03W7D	-	0.1191	9M07W7D	-	0.0912
15	2552.5 ~ 2647.5	13M5G7D	-	0.1435	13M5W7D	-	0.1189	13M5W7D	-	0.0916
20	2555.0 ~ 2645.0	18M4G7D	-	0.1445	18M4W7D	-	0.1175	18M6W7D	-	0.0944
LTE Band 66		QPSK			16QAM			64QAM		
BW (MHz)	Frequency Range (MHz)	Emission Designator (99%OBW)	Frequency Tolerance (ppm)	Maximum EIRP(W)	Emission Designator (99%OBW)	Frequency Tolerance (ppm)	Maximum EIRP(W)	Emission Designator (99%OBW)	Frequency Tolerance (ppm)	Maximum EIRP(W)
1.4	1710.7 ~ 1779.3	1M09G7D	-	0.1963	1M09W7D	-	0.1589	1M09W7D	-	0.1400
3	1711.5 ~ 1778.5	2M73G7D	-	0.1932	2M72W7D	-	0.1622	2M73W7D	-	0.1374
5	1712.5 ~ 1777.5	4M51G7D	-	0.1945	4M51W7D	-	0.1618	4M49W7D	-	0.1393
10	1715.0 ~ 1775.0	9M03G7D	0.0108	0.1972	9M09W7D	-	0.1626	9M05W7D	-	0.1396
15	1717.5 ~ 1772.5	13M5G7D	-	0.1991	13M5W7D	-	0.1652	13M5W7D	-	0.1472
20	1720.0 ~ 1770.0	18M5G7D	-	0.2023	18M4W7D	-	0.1679	18M4W7D	-	0.1483



1.7 Testing Location

Sporton Lab is accredited to ISO 17025 by Taiwan Accreditation Foundation (TAF code : 1190) and the FCC designation No. TW0007 under the FCC 2.948(e) by Mutual Recognition Agreement (MRA) in FCC Test.

Test Site	SPORTON INTERNATIONAL INC.
Test Site Location	No. 52, Hwa Ya 1 st Rd., Hwa Ya Technology Park, Kwei-Shan District, Tao Yuan City, Taiwan, R.O.C. TEL: +886-3-327-3456 FAX: +886-3-328-4978
Test Site No.	Sporton Site No.
	TH05-HY

Test Site	SPORTON INTERNATIONAL INC.
Test Site Location	No.58, Aly. 75, Ln. 564, Wenhua 3rd Rd. Guishan Dist, Taoyuan City, Taiwan (R.O.C.) TEL: +886-3-327-0868 FAX: +886-3-327-0855
Test Site No.	Sporton Site No.
	03CH12-HY

1.8 Applicable Standards

According to the specifications of the manufacturer, the EUT must comply with the requirements of the following standards:

- ♦ 47 CFR Part 2, 22(H), 24(E), 27
- ♦ ANSI / TIA / EIA-603-D-2010
- ♦ FCC KDB 971168 D01 Power Meas. License Digital Systems v02r02
- ♦ FCC KDB 412172 D01 Determining ERP and EIRP v01r01

Remark:

1. All test items were verified and recorded according to the standards and without any deviation during the test.
2. This EUT has also been tested and complied with the requirements of FCC Part 15, Subpart B, recorded in a separate test report.



2 Test Configuration of Equipment Under Test

2.1 Test Mode

Antenna port conducted and radiated test items listed below are performed according to KDB 971168 D01 Power Meas. License Digital Systems v02r02 with maximum output power.

Radiated measurements are performed by rotating the EUT in three different orthogonal test planes to find the maximum emission.

Test Items	Band	Bandwidth (MHz)						Modulation			RB #			Test Channel		
		1.4	3	5	10	15	20	QPSK	16QAM	64QAM	1	Half	Full	L	M	H
Max. Output Power	2	✓	✓	✓	✓	✓	✓	✓	✓	✓	✓	✓	✓	✓	✓	✓
	4	✓	✓	✓	✓	✓	✓	✓	✓	✓	✓	✓	✓	✓	✓	✓
	5	✓	✓	✓	✓	-	-	✓	✓	✓	✓	✓	✓	✓	✓	✓
	7	-	-	✓	✓	✓	✓	✓	✓	✓	✓	✓	✓	✓	✓	✓
	12	✓	✓	✓	✓	-	-	✓	✓	✓	✓	✓	✓	✓	✓	✓
	17	-	-	✓	✓	-	-	✓	✓	✓	✓	✓	✓	✓	✓	✓
	25	✓	✓	✓	✓	✓	✓	✓	✓	✓	✓	✓	✓	✓	✓	✓
	26	✓	✓	✓	✓	✓	-	✓	✓	✓	✓	✓	✓	✓	✓	✓
	38	-	-	✓	✓	✓	✓	✓	✓	✓	✓	✓	✓	✓	✓	✓
	41	-	-	✓	✓	✓	✓	✓	✓	✓	✓	✓	✓	✓	✓	✓
66	✓	✓	✓	✓	✓	✓	✓	✓	✓	✓	✓	✓	✓	✓	✓	
Peak-to-Average Ratio	2						✓	✓	✓	✓	✓		✓	✓	✓	✓
	4						✓	✓	✓	✓	✓		✓	✓	✓	✓
	5				✓	-	-	✓	✓	✓	✓		✓	✓	✓	✓
	7	-	-				✓	✓	✓	✓	✓		✓	✓	✓	✓
	12				✓	-	-	✓	✓	✓	✓		✓	✓	✓	✓
	17	-	-		✓	-	-	✓	✓	✓	✓		✓	✓	✓	✓
	25						✓	✓	✓	✓	✓		✓	✓	✓	✓
	26				✓		-	✓	✓	✓	✓		✓	✓	✓	✓
	38	-	-				✓	✓	✓	✓	✓		✓	✓	✓	✓
	41	-	-				✓	✓	✓	✓	✓		✓	✓	✓	✓
66						✓	✓	✓	✓	✓		✓	✓	✓	✓	



Test Items	Band	Bandwidth (MHz)						Modulation			RB #			Test Channel		
		1.4	3	5	10	15	20	QPSK	16QAM	64QAM	1	Half	Full	L	M	H
26dB and 99% Bandwidth	2	Y	Y	Y	Y	Y	Y	Y	Y	Y			Y	Y	Y	Y
	4	Y	Y	Y	Y	Y	Y	Y	Y	Y			Y	Y	Y	Y
	5	Y	Y	Y	Y	-	-	Y	Y	Y			Y	Y	Y	Y
	7	-	-	Y	Y	Y	Y	Y	Y	Y			Y	Y	Y	Y
	12	Y	Y	Y	Y	-	-	Y	Y	Y			Y	Y	Y	Y
	17	-	-	Y	Y	-	-	Y	Y	Y			Y	Y	Y	Y
	25	Y	Y	Y	Y	Y	Y	Y	Y	Y			Y	Y	Y	Y
	26	Y	Y	Y	Y	Y	-	Y	Y	Y			Y	Y	Y	Y
	38	-	-	Y	Y	Y	Y	Y	Y	Y			Y	Y	Y	Y
	41	-	-	Y	Y	Y	Y	Y	Y	Y			Y	Y	Y	Y
66	Y	Y	Y	Y	Y	Y	Y	Y	Y			Y	Y	Y	Y	
Conducted Band Edge	2	Y	Y	Y	Y	Y	Y	Y	Y	Y	Y		Y	Y		Y
	4	Y	Y	Y	Y	Y	Y	Y	Y	Y	Y		Y	Y		Y
	5	Y	Y	Y	Y	-	-	Y	Y	Y	Y		Y	Y		Y
	7	-	-	Y	Y	Y	Y	Y	Y	Y	Y		Y	Y		Y
	12	Y	Y	Y	Y	-	-	Y	Y	Y	Y		Y	Y		Y
	17	-	-	Y	Y	-	-	Y	Y	Y	Y		Y	Y		Y
	25	Y	Y	Y	Y	Y	Y	Y	Y	Y	Y		Y	Y		Y
	26	Y	Y	Y	Y	Y	-	Y	Y	Y	Y		Y	Y		Y
	38	-	-	Y	Y	Y	Y	Y	Y	Y	Y		Y	Y		Y
	41	-	-	Y	Y	Y	Y	Y	Y	Y	Y		Y	Y		Y
66	Y	Y	Y	Y	Y	Y	Y	Y	Y	Y		Y	Y		Y	



Test Items	Band	Bandwidth (MHz)						Modulation			RB #			Test Channel		
		1.4	3	5	10	15	20	QPSK	16QAM	64QAM	1	Half	Full	L	M	H
Conducted Spurious Emission	2	✓	✓	✓	✓	✓	✓	✓	✓	✓	✓			✓	✓	✓
	4	✓	✓	✓	✓	✓	✓	✓	✓	✓	✓			✓	✓	✓
	5	✓	✓	✓	✓	-	-	✓	✓	✓	✓			✓	✓	✓
	7	-	-	✓	✓	✓	✓	✓	✓	✓	✓			✓	✓	✓
	12	✓	✓	✓	✓	-	-	✓	✓	✓	✓			✓	✓	✓
	17	-	-	✓	✓	-	-	✓	✓	✓	✓			✓	✓	✓
	25	✓	✓	✓	✓	✓	✓	✓	✓	✓	✓			✓	✓	✓
	26	✓	✓	✓	✓	✓	-	✓	✓	✓	✓			✓	✓	✓
	38	-	-	✓	✓	✓	✓	✓	✓	✓	✓			✓	✓	✓
	41	-	-	✓	✓	✓	✓	✓	✓	✓	✓			✓	✓	✓
66	✓	✓	✓	✓	✓	✓	✓	✓	✓	✓			✓	✓	✓	
Frequency Stability	2				✓			✓					✓		✓	
	4				✓			✓					✓		✓	
	5				✓	-	-	✓					✓		✓	
	7	-	-		✓			✓					✓		✓	
	12				✓	-	-	✓					✓		✓	
	17	-	-		✓	-	-	✓					✓		✓	
	25				✓			✓					✓		✓	
	26				✓		-	✓					✓		✓	
	38	-	-		✓			✓					✓		✓	
	41	-	-		✓			✓					✓		✓	
66				✓			✓					✓		✓		



Test Items	Band	Bandwidth (MHz)						Modulation			RB #			Test Channel		
		1.4	3	5	10	15	20	QPSK	16QAM	64QAM	1	Half	Full	L	M	H
E.R.P./ E.I.R.P.	2	v	v	v	v	v	v	v	v	v	v			v	v	v
	4	v	v	v	v	v	v	v	v	v	v			v	v	v
	5	v	v	v	v	-	-	v	v	v	v			v	v	v
	7	-	-	v	v	v	v	v	v	v	v			v	v	v
	12	v	v	v	v	v	v	v	v	v	v			v	v	v
	17	-	-	v	v	-	-	v	v	v	v			v	v	v
	25	v	v	v	v	v	v	v	v	v	v			v	v	v
	26	v	v	v	v	v	-	v	v	v	v			v	v	v
	38	-	-	v	v	v	v	v	v	v	v			v	v	v
	41	-	-	v	v	v	v	v	v	v	v			v	v	v
66	v	v	v	v	v	v	v	v	v	v			v	v	v	
Radiated Spurious Emission	2	v	v	v	v	v	v	v			v			v	v	v
	4	v	v	v	v	v	v	v			v			v	v	v
	5	v	v	v	v	-	-	v			v			v	v	v
	7	-	-	v	v	v	v	v			v			v	v	v
	12	v	v	v	v	-	-	v			v			v	v	v
	13	-	-	v	v	-	-	v			v			v	v	v
	17	-	-	v	v	-	-	v			v			v	v	v
	25	v	v	v	v	v	v	v			v			v	v	v
	26	v	v	v	v	v	-	v			v			v	v	v
	38	-	-	v	v	v	v	v			v			v	v	v
41	-	-	v	v	v	v	v			v			v	v	v	
66	v	v	v	v	v	v	v			v			v	v	v	
Note	<p>1. The mark "v" means that this configuration is chosen for testing</p> <p>2. The mark "-" means that this bandwidth is not supported.</p> <p>3. The device is investigated from 30MHz to 10 times of fundamental signal for radiated spurious emission test under different RB size/offset and modulations in exploratory test. Subsequently, only the worst case emissions are reported.</p> <p>4. All the radiated test cases were performance with Adapter 1 and Battery 2.</p>															

2.2 Connection Diagram of Test System

<EUT with Adapter Mode>

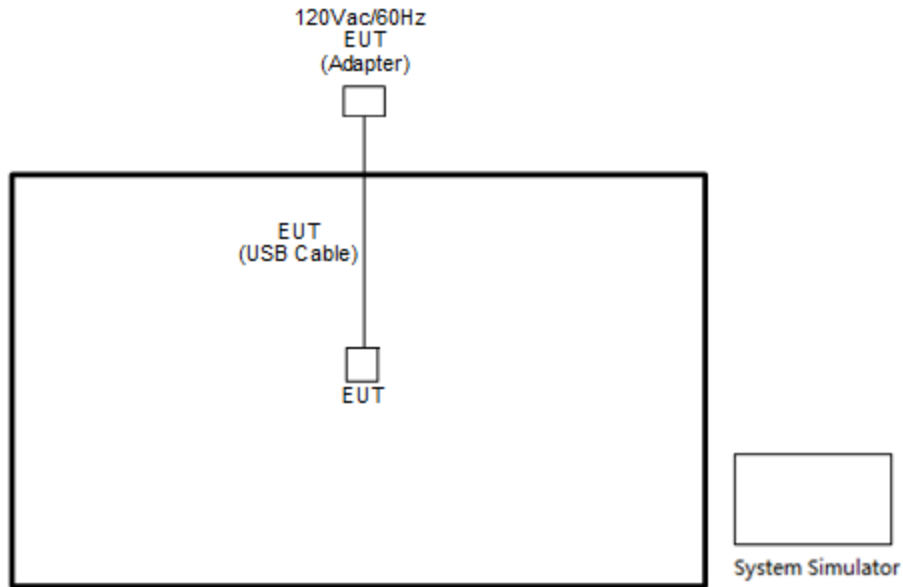

<EUT with Earphone Mode>

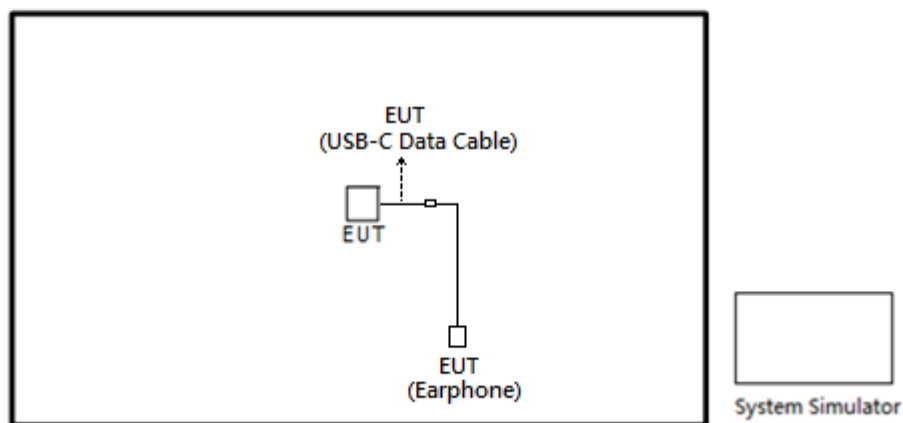

<EUT without Accessor Mode>

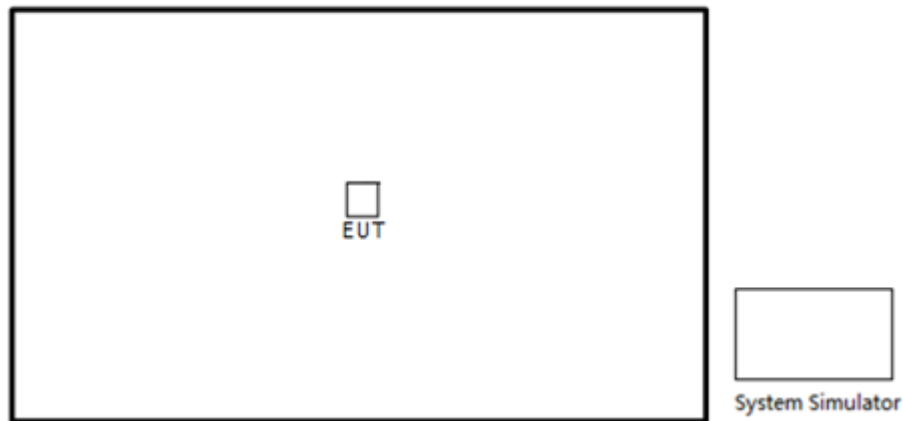

2.3 Support Unit used in test configuration and system

Item	Equipment	Trade Name	Model No.	FCC ID	Data Cable	Power Cord
1.	LTE Base Station	Anritsu	MT8820C	N/A	N/A	Unshielded, 1.8 m

2.4 Measurement Results Explanation Example

For all conducted test items:

The offset level is set in the spectrum analyzer to compensate the RF cable loss and attenuator factor between EUT conducted output port and spectrum analyzer. With the offset compensation, the spectrum analyzer reading level is exactly the EUT RF output level.

The spectrum analyzer offset is derived from RF cable loss and attenuator factor.

Offset = RF cable loss + attenuator factor.

Following shows an offset computation example with cable loss 4.2 dB and 10dB attenuator.

Example :

$$\begin{aligned}
 \text{Offset(dB)} &= \text{RF cable loss(dB)} + \text{attenuator factor(dB)}. \\
 &= 4.2 + 10 = 14.2 \text{ (dB)}
 \end{aligned}$$



2.5 Frequency List of Low/Middle/High Channels

LTE Band 2 Channel and Frequency List				
BW [MHz]	Channel/Frequency(MHz)	Lowest	Middle	Highest
20	Channel	18700	18900	19100
	Frequency	1860	1880	1900
15	Channel	18675	18900	19125
	Frequency	1857.5	1880	1902.5
10	Channel	18650	18900	19150
	Frequency	1855	1880	1905
5	Channel	18625	18900	19175
	Frequency	1852.5	1880	1907.5
3	Channel	18615	18900	19185
	Frequency	1851.5	1880	1908.5
1.4	Channel	18607	18900	19193
	Frequency	1850.7	1880	1909.3

LTE Band 4 Channel and Frequency List				
BW [MHz]	Channel/Frequency(MHz)	Lowest	Middle	Highest
20	Channel	20050	20175	20300
	Frequency	1720	1732.5	1745
15	Channel	20025	20175	20325
	Frequency	1717.5	1732.5	1747.5
10	Channel	20000	20175	20350
	Frequency	1715	1732.5	1750
5	Channel	19975	20175	20375
	Frequency	1712.5	1732.5	1752.5
3	Channel	19965	20175	20385
	Frequency	1711.5	1732.5	1753.5
1.4	Channel	19957	20175	20393
	Frequency	1710.7	1732.5	1754.3



LTE Band 5 Channel and Frequency List				
BW [MHz]	Channel/Frequency(MHz)	Lowest	Middle	Highest
10	Channel	20450	20525	20600
	Frequency	829	836.5	844
5	Channel	20425	20525	20625
	Frequency	826.5	836.5	846.5
3	Channel	20415	20525	20635
	Frequency	825.5	836.5	847.5
1.4	Channel	20407	20525	20643
	Frequency	824.7	836.5	848.3

LTE Band 7 Channel and Frequency List				
BW [MHz]	Channel/Frequency(MHz)	Lowest	Middle	Highest
20	Channel	20850	21100	21350
	Frequency	2510	2535	2560
15	Channel	20825	21100	21375
	Frequency	2507.5	2535	2562.5
10	Channel	20800	21100	21400
	Frequency	2505	2535	2565
5	Channel	20775	21100	21425
	Frequency	2502.5	2535	2567.5

LTE Band 12 Channel and Frequency List				
BW [MHz]	Channel/Frequency(MHz)	Lowest	Middle	Highest
10	Channel	23060	23095	23130
	Frequency	704	707.5	711
5	Channel	23035	23095	23155
	Frequency	701.5	707.5	713.5
3	Channel	23025	23095	23165
	Frequency	700.5	707.5	714.5
1.4	Channel	23017	23095	23173
	Frequency	699.7	707.5	715.3



LTE Band 17 Channel and Frequency List				
BW [MHz]	Channel/Frequency(MHz)	Lowest	Middle	Highest
10	Channel	23780	23790	23800
	Frequency	709	710	711
5	Channel	23755	23790	23825
	Frequency	706.5	710	713.5

LTE Band 25 Channel and Frequency List				
BW [MHz]	Channel/Frequency(MHz)	Lowest	Middle	Highest
20	Channel	26140	26340	26590
	Frequency	1860	1880	1905
15	Channel	26115	26340	26615
	Frequency	1857.5	1880	1907.5
10	Channel	26090	26340	26640
	Frequency	1855	1880	1910
5	Channel	26065	26340	26665
	Frequency	1852.5	1880	1912.5
3	Channel	26055	26340	26675
	Frequency	1851.5	1880	1913.5
1.4	Channel	26047	26340	26683
	Frequency	1850.7	1880	1914.3

LTE Band 26 Channel and Frequency List				
BW [MHz]	Channel/Frequency(MHz)	Lowest	Middle	Highest
15	Channel	26865	26915	26965
	Frequency	831.5	836.5	841.5
10	Channel	26840	26915	26990
	Frequency	829	836.5	844
5	Channel	26815	26915	27015
	Frequency	826.5	836.5	846.5
3	Channel	26805	26915	27025
	Frequency	825.5	836.5	847.5
1.4	Channel	26797	26915	27033
	Frequency	824.7	836.5	848.3



LTE Band 38 Channel and Frequency List				
BW [MHz]	Channel/Frequency(MHz)	Lowest	Middle	Highest
20	Channel	37850	38000	38150
	Frequency	2580	2595	2610
15	Channel	37825	38000	38175
	Frequency	2577.5	2595	2612.5
10	Channel	37800	38000	38200
	Frequency	2575	2595	2615
5	Channel	37775	38000	38225
	Frequency	2572.5	2595	2617.5

LTE Band 41 Channel and Frequency List				
BW [MHz]	Channel/Frequency(MHz)	Lowest	Middle	Highest
20	Channel	39750	40620	41490
	Frequency	2506	2593	2680
15	Channel	39725	40620	41515
	Frequency	2503.5	2593	2682.5
10	Channel	39700	40620	41540
	Frequency	2501	2593	2685
5	Channel	39675	40620	41565
	Frequency	2498.5	2593	2687.5

LTE Band 66 Channel and Frequency List				
BW [MHz]	Channel/Frequency(MHz)	Lowest	Middle	Highest
20	Channel	132072	132322	132572
	Frequency	1720	1745	1770
15	Channel	132047	132322	132597
	Frequency	1717.5	1745	1772.5
10	Channel	132022	132322	132622
	Frequency	1715	1745	1775
5	Channel	131997	132322	132647
	Frequency	1712.5	1745	1777.5
3	Channel	131987	132322	132657
	Frequency	1711.5	1745	1778.5
1.4	Channel	131979	132322	132665
	Frequency	1710.7	1745	1779.3

3 Conducted Test Items

3.1 Measuring Instruments

See list of measuring instruments of this test report.

3.2 Test Setup

3.2.1 Conducted Output Power

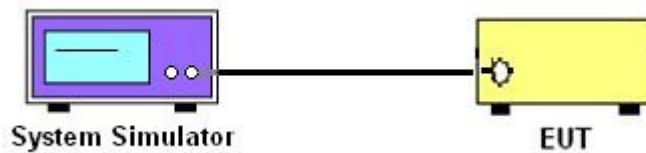

3.2.2 Peak-to-Average Ratio, Occupied Bandwidth ,Conducted Band-Edge and Conducted Spurious Emission

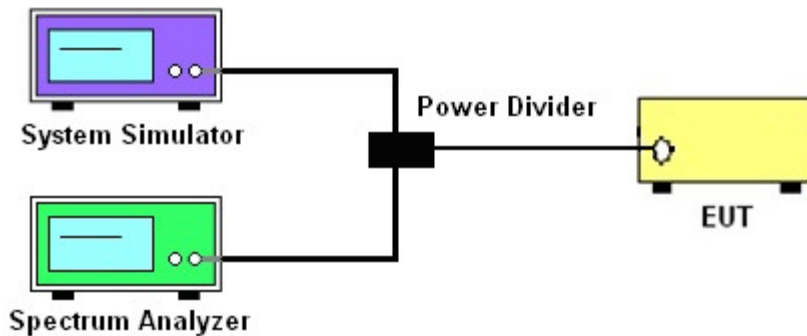

3.2.3 Frequency Stability

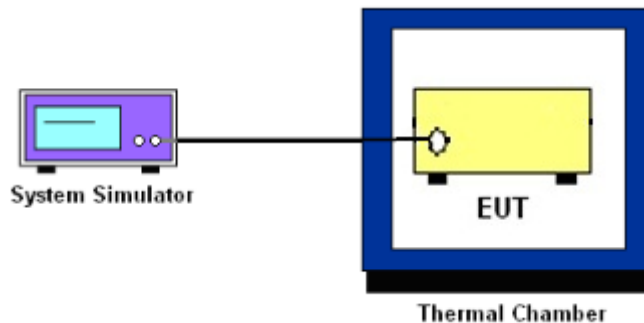

3.3 Test Result of Conducted Test

Please refer to Appendix A.



3.4 Conducted Output Power and ERP/EIRP

3.4.1 Description of the Conducted Output Power Measurement and ERP/EIRP Measurement

A system simulator was used to establish communication with the EUT. Its parameters were set to force the EUT transmitting at maximum output power. The measured power in the radio frequency on the transmitter output terminals shall be reported.

The ERP of mobile transmitters must not exceed 7 Watts for LTE Band 5 and Band 26.

The ERP of mobile transmitters must not exceed 3 Watts for LTE Band 12 and Band 17.

The EIRP of mobile transmitters must not exceed 2 Watts for LTE Band 2, Band 25, Band 7, Band 38, and Band 41.

The EIRP of mobile transmitters must not exceed 1 Watts for LTE Band 4 and Band 66.

According to KDB 412172 D01 Power Approach,

$EIRP = P_T + G_T - L_C$, $ERP = EIRP - 2.15$, where

P_T = transmitter output power in dBm

G_T = gain of the transmitting antenna in dBi

L_C = signal attenuation in the connecting cable between the transmitter and antenna in dB

3.4.2 Test Procedures

1. The transmitter output port was connected to the system simulator.
2. Set EUT at maximum power through the system simulator.
3. Select lowest, middle, and highest channels for each band and different modulation.
4. Measure and record the power level from the system simulator.



3.5 Peak-to-Average Ratio

3.5.1 Description of the PAR Measurement

Power Complementary Cumulative Distribution Function (CCDF) curves provide a means for characterizing the power peaks of a digitally modulated signal on a statistical basis. A CCDF curve depicts the probability of the peak signal amplitude exceeding the average power level. Most contemporary measurement instrumentation include the capability to produce CCDF curves for an input signal provided that the instrument's resolution bandwidth can be set wide enough to accommodate the entire input signal bandwidth. In measuring transmissions in this band using an average power technique, the peak-to-average ratio (PAR) of the transmission may not exceed 13 dB.

3.5.2 Test Procedures

1. The testing follows FCC KDB 971168 v02r02 Section 5.7.1.
2. The EUT was connected to spectrum and system simulator via a power divider.
3. Set the CCDF (Complementary Cumulative Distribution Function) option in spectrum analyzer.
4. The highest RF powers were measured and recorded the maximum PAPR level associated with a probability of 0.1 %.
5. Record the deviation as Peak to Average Ratio.



3.6 Occupied Bandwidth

3.6.1 Description of Occupied Bandwidth Measurement

The occupied bandwidth is the width of a frequency band such that, below the lower and above the upper frequency limits, the mean powers emitted are each equal to a specified percentage 0.5% of the total mean transmitted power.

The 26 dB emission bandwidth is defined as the frequency range between two points, one above and one below the carrier frequency, at which the spectral density of the emission is attenuated 26 dB below the maximum in-band spectral density of the modulated signal. Spectral density (power per unit bandwidth) is to be measured with a detector of resolution bandwidth equal to approximately 1.0% of the emission bandwidth.

3.6.2 Test Procedures

1. The testing follows FCC KDB 971168 v02r02 Section 4.2.
2. The EUT was connected to spectrum analyzer and system simulator via a power divider.
3. The spectrum analyzer center frequency is set to the nominal EUT channel center frequency. The span range for the spectrum analyzer shall be between two and five times the anticipated OBW.
4. The nominal resolution bandwidth (RBW) shall be in the range of 1 to 5 % of the anticipated OBW, and the VBW shall be at least 3 times the RBW.
5. Set the detection mode to peak, and the trace mode to max hold.
6. Determine the reference value: Set the EUT to transmit a modulated signal. Allow the trace to stabilize. Set the spectrum analyzer marker to the highest level of the displayed trace.
(this is the reference value)
7. Determine the “-26 dB down amplitude” as equal to (Reference Value – X).
8. Place two markers, one at the lowest and the other at the highest frequency of the envelope of the spectral display such that each marker is at or slightly below the “-X dB down amplitude” determined in step 6. If a marker is below this “-X dB down amplitude” value it shall be placed as close as possible to this value. The OBW is the positive frequency difference between the two markers.
9. Use the 99 % power bandwidth function of the spectrum analyzer and report the measured bandwidth.



3.7 Conducted Band Edge

3.7.1 Description of Conducted Band Edge Measurement

22.917(a)

For operations in the 824 – 849 MHz band, the FCC limit is $43 + 10\log_{10}(P[\text{Watts}])$ dB below the transmitter power P(Watts) in a 100kHz bandwidth. However, in the 1MHz bands immediately outside and adjacent to the licensee's frequency block, a resolution bandwidth of at least one percent of the emission bandwidth of the fundamental emission of the transmitter may be employed.

24.238 (a)

For operations in the 1850-1910 and 1930-1990 MHz band, the FCC limit is $43 + 10\log_{10}(P[\text{Watts}])$ dB below the transmitter power P(Watts) in a 1MHz bandwidth. However, in the 1 MHz bands immediately outside and adjacent to the frequency block a resolution bandwidth of at least one percent of the emission bandwidth of the fundamental emission of the transmitter may be employed.

27.53 (g)

For operations in the 698 -746 MHz band, the FCC limit is $43 + 10\log_{10}(P[\text{Watts}])$ dB below the transmitter power P(Watts) in a 100 kHz bandwidth. However, in the 100 kilohertz bands immediately outside and adjacent to a licensee's frequency block, a resolution bandwidth of at least 30 kHz may be employed.

27.53 (h)

For operations in the 1710 – 1755 MHz band, the FCC limit is $43 + 10\log_{10}(P[\text{Watts}])$ dB below the transmitter power P(Watts) in a 1 MHz bandwidth. However, in the 1MHz bands immediately outside and adjacent to the licensee's frequency block, a resolution bandwidth of at least one percent of the emission bandwidth of the fundamental emission of the transmitter may be employed.



27.53(m)(4)

For mobile digital stations, the attenuation factor shall be not less than $40 + 10 \log (P)$ dB on all frequencies between the channel edge and 5 megahertz from the channel edge, $43 + 10 \log (P)$ dB on all frequencies between 5 megahertz and X megahertz from the channel edge, and $55 + 10 \log (P)$ dB on all frequencies more than X megahertz from the channel edge, where X is the greater of 6 megahertz or the actual emission bandwidth as defined in paragraph (m)(6) of this section. In addition, the attenuation factor shall not be less that $43 + 10 \log (P)$ dB on all frequencies between 2490.5 MHz and 2496 MHz and $55 + 10 \log (P)$ dB at or below 2490.5 MHz. Mobile Satellite Service licensees operating on frequencies below 2495 MHz may also submit a documented interference complaint against BRS licensees operating on channel BRS Channel 1 on the same terms and conditions as adjacent channel BRS or EBS licensees.

3.7.2 Test Procedures

1. The testing follows FCC KDB 971168 v02r02 Section 6.0.
2. The EUT was connected to spectrum analyzer and system simulator via a power divider.
3. The band edges of low and high channels for the highest RF powers were measured.
4. Set RBW $\geq 1\%$ EBW in the 1MHz band immediately outside and adjacent to the band edge.
5. Beyond the 1 MHz band from the band edge, RBW=1MHz was used.
6. Set spectrum analyzer with RMS detector.
7. The RF fundamental frequency should be excluded against the limit line in the operating frequency band.
8. Checked that all the results comply with the emission limit line.
The limit line is derived from $43 + 10\log(P)$ dB below the transmitter power P(Watts)
9. For LTE Band 7, 38, 41, the other 40 dB, and 55 dB have additionally applied same calculation above.



3.8 Conducted Spurious Emission

3.8.1 Description of Conducted Spurious Emission Measurement

The power of any emission outside of the authorized operating frequency ranges must be lower than the transmitter power (P) by a factor of at least $43 + 10 \log (P)$ dB.

For Band 7,38,41:

The power of any emission outside of the authorized operating frequency ranges must be lower than the transmitter power (P) by a factor of at least $55 + 10 \log (P)$ dB.

It is measured by means of a calibrated spectrum analyzer and scanned from 30 MHz up to a frequency including its 10th harmonic.

3.8.2 Test Procedures

1. The testing follows FCC KDB 971168 v02r02 Section 6.0.
2. The EUT was connected to spectrum analyzer and system simulator via a power divider.
3. The RF output of EUT was connected to the spectrum analyzer by RF cable and attenuator. The path loss was compensated to the results for each measurement.
4. The middle channel for the highest RF power within the transmitting frequency was measured.
5. The conducted spurious emission for the whole frequency range was taken.
6. Make the measurement with the spectrum analyzer's RBW = 1MHz, VBW = 3MHz.
7. Set spectrum analyzer with RMS detector.
8. Taking the record of maximum spurious emission.
9. The RF fundamental frequency should be excluded against the limit line in the operating frequency band.
10. The limit line is derived from $43 + 10\log(P)$ dB below the transmitter power P(Watts)
11. For Band 7, 38, 41
The limit line is derived from $55 + 10\log(P)$ dB below the transmitter power P(Watts)



3.9 Frequency Stability

3.9.1 Description of Frequency Stability Measurement

The frequency stability shall be measured by variation of ambient temperature and variation of primary supply voltage to ensure that the fundamental emission stays within the authorized frequency block. The frequency stability of the transmitter shall be maintained within $\pm 0.00025\%$ ($\pm 2.5\text{ppm}$) of the center frequency.

3.9.2 Test Procedures for Temperature Variation

1. The testing follows FCC KDB 971168 v02r02 Section 9.0.
2. The EUT was set up in the thermal chamber and connected with the system simulator.
3. With power OFF, the temperature was decreased to -30°C and the EUT was stabilized before testing. Power was applied and the maximum change in frequency was recorded within one minute.
4. With power OFF, the temperature was raised in 10°C step up to 50°C . The EUT was stabilized at each step for at least half an hour. Power was applied and the maximum frequency change was recorded within one minute.

3.9.3 Test Procedures for Voltage Variation

1. The testing follows FCC KDB 971168 v02r02 Section 9.0.
2. The EUT was placed in a temperature chamber at $20\pm 5^{\circ}\text{C}$ and connected with the system simulator.
3. The power supply voltage to the EUT was varied from 85% to 115% of the nominal value measured at the input to the EUT.
4. The variation in frequency was measured for the worst case.

4 Radiated Test Items

4.1 Measuring Instruments

See list of measuring instruments of this test report.

4.2 Test Setup

4.2.1 For radiated test from 30MHz to 1GHz

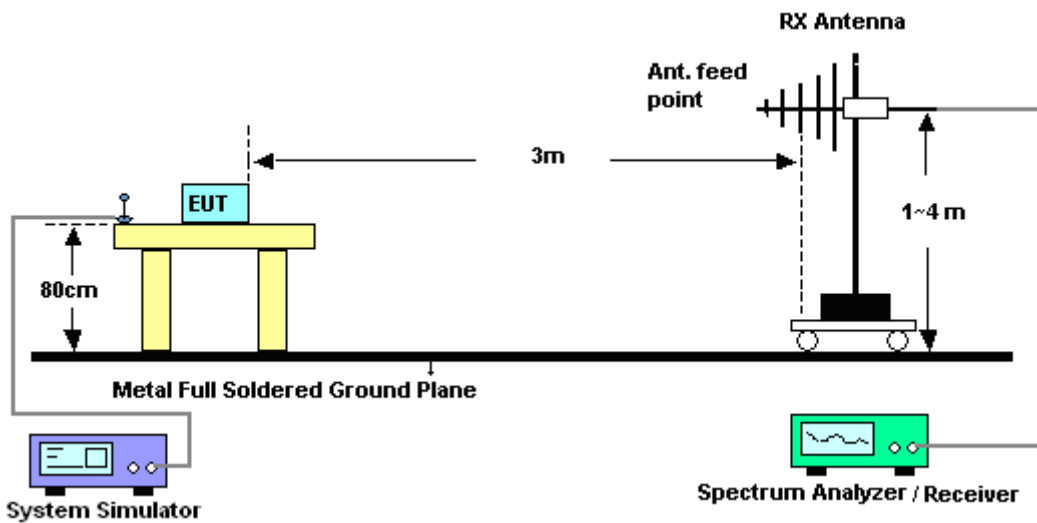

4.2.2 For radiated test above 1GHz

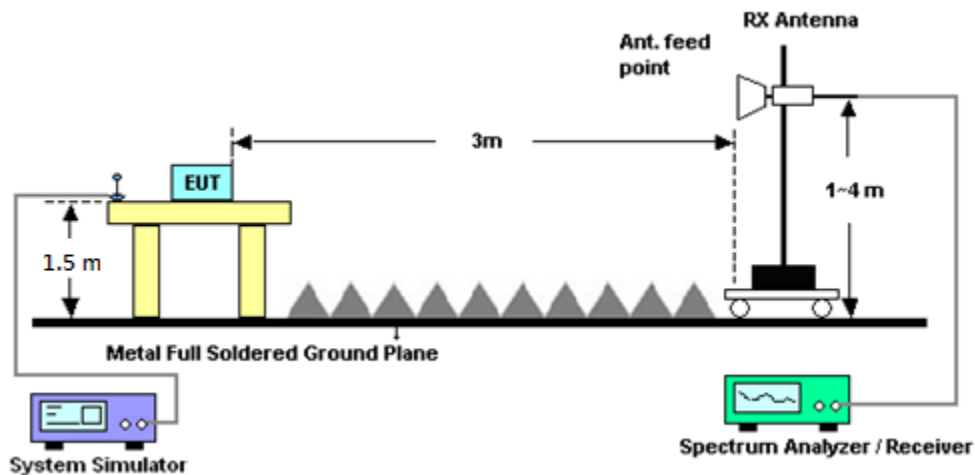

4.3 Test Result of Radiated Test

Please refer to Appendix B.



4.4 Radiated Spurious Emission

4.4.1 Description of Radiated Spurious Emission

The radiated spurious emission was measured by substitution method according to ANSI / TIA / EIA-603-D-2010. The power of any emission outside of the authorized operating frequency ranges must be attenuated below the transmitter power (P) by a factor of at least $43 + 10 \log (P)$ dB.

For Band 7, 38, 41

The power of any emission outside of the authorized operating frequency ranges must be attenuated below the transmitter power (P) by a factor of at least $55 + 10 \log (P)$ dB.

For LTE Band 12, 17

For operations in the 746-758 MHz, 775-788 MHz, and 805-806 MHz bands, emissions in the band 1559-1610 MHz shall be limited to -70 dBW/MHz equivalent isotropically radiated power (EIRP) for wideband signals, and -80 dBW EIRP for discrete emissions of less than 700 Hz bandwidth.

The spectrum is scanned from 30 MHz up to a frequency including its 10th harmonic.

4.4.2 Test Procedures

1. The testing follows FCC KDB 971168 v02r02 Section 5.8 and ANSI / TIA-603-D-2010 Section 2.2.12.
2. The EUT was placed on a turntable with 0.8 meter for frequency below 1GHz and 1.5 meter for frequency above 1GHz respectively above ground.
3. The EUT was set 3 meters from the receiving antenna, which was mounted on the antenna tower.
4. The table was rotated 360 degrees to determine the position of the highest spurious emission.
5. The height of the receiving antenna is varied between one meter and four meters to search the maximum spurious emission for both horizontal and vertical polarizations.
6. Make the measurement with the spectrum analyzer's RBW = 1MHz, VBW = 3MHz, taking the record of maximum spurious emission.
7. A horn antenna was substituted in place of the EUT and was driven by a signal generator.
8. Tune the output power of signal generator to the same emission level with EUT maximum spurious emission.
9. Taking the record of output power at antenna port.
10. Repeat step 7 to step 8 for another polarization.
11. The RF fundamental frequency should be excluded against the limit line in the operating frequency band.
The limit line is derived from $43 + 10\log(P)$ dB below the transmitter power P(Watts)
12. For Band 7, 38, 41:
The limit line is derived from $55 + 10\log(P)$ dB below the transmitter power P(Watts)
 $EIRP \text{ (dBm)} = S.G. \text{ Power} - Tx \text{ Cable Loss} + Tx \text{ Antenna Gain}$
 $ERP \text{ (dBm)} = EIRP - 2.15$



5 List of Measuring Equipment

Instrument	Manufacturer	Model No.	Serial No.	Characteristics	Calibration Date	Test Date	Due Date	Remark
LTE Base Station	Anritsu	MT8820C	6201432821	GSM/GPRS /WCDMA/LTE	Oct. 11, 2016	Apr. 05, 2017~ Apr. 28, 2017	Oct. 10, 2017	Conducted (TH05-HY)
Spectrum Analyzer	Rohde & Schwarz	FSV40	101397	10Hz~40GHz	Nov. 04, 2016	Apr. 05, 2017~ Apr. 28, 2017	Nov. 03, 2017	Conducted (TH05-HY)
Temperature Chamber	ESPEC	SH-641	92013720	-30°C~70°C	Sep. 01, 2016	Apr. 05, 2017~ Apr. 28, 2017	Aug. 31, 2017	Conducted (TH05-HY)
Programmable Power Supply	GW Instek	PSS-2005	EL890001	1V~20V 0.5A~5A	Oct. 03, 2016	Apr. 05, 2017~ Apr. 28, 2017	Oct. 02, 2017	Conducted (TH05-HY)
Bilog Antenna	TESEQ	CBL 6111D&00800	37059&01	30MHz~1GHz	Oct. 15, 2016	Apr. 13, 2017 ~ Apr. 20, 2017	Oct. 14, 2017	Radiation (03CH12-HY)
Horn Antenna	SCHWARZBECK	BBHA 9120D	9120D-1328	1GHz ~ 18GHz	Oct. 25, 2016	Apr. 13, 2017 ~ Apr. 20, 2017	Oct. 24, 2017	Radiation (03CH12-HY)
EMI Test Receiver	Rohde & Schwarz	ESU26	100390	20Hz~26.5GHz	Dec. 23, 2016	Apr. 13, 2017 ~ Apr. 20, 2017	Dec. 22, 2017	Radiation (03CH12-HY)
Loop Antenna	Rohde & Schwarz	HFH2-Z2	100315	9 kHz~30 MHz	Sep. 02, 2015	Apr. 13, 2017 ~ Apr. 20, 2017	Sep. 01, 2017	Radiation (03CH12-HY)
Preamplifier	MITEQ	AMF-7D-0010 1800-30-10P	1815698	1GHz~18GHz	Dec. 01, 2016	Apr. 13, 2017 ~ Apr. 20, 2017	Nov. 30, 2017	Radiation (03CH12-HY)
Amplifier	SONOMA	310N	187312	9kHz~1GHz	Nov. 10, 2016	Apr. 13, 2017 ~ Apr. 20, 2017	Nov. 09, 2017	Radiation (03CH12-HY)
Spectrum Analyzer	Agilent	N9030A	MY52350276	3Hz~44GHz	Mar. 23, 2017	Apr. 13, 2017 ~ Apr. 20, 2017	Mar. 22, 2018	Radiation (03CH12-HY)
Antenna Mast	EMEC	AM-BS-4500-B	N/A	1m~4m	N/A	Apr. 13, 2017 ~ Apr. 20, 2017	N/A	Radiation (03CH12-HY)
Turn Table	EMEC	TT2000	N/A	0~360 Degree	N/A	Apr. 13, 2017 ~ Apr. 20, 2017	N/A	Radiation (03CH12-HY)
Preamplifier	MITEQ	JS44-1800400 0-33-8P	1840917	18GHz ~ 40GHz	Jun. 14, 2016	Apr. 13, 2017 ~ Apr. 20, 2017	Jun. 13, 2017	Radiation (03CH12-HY)
SHF-EHF Horn Antenna	SCHWARZBECK	BBHA 9170	BBHA9170251	18GHz- 40GHz	Nov. 08, 2016	Apr. 13, 2017 ~ Apr. 20, 2017	Nov. 07, 2017	Radiation (03CH12-HY)
Signal Generator	Anritsu	MG3694C	163401	0.1Hz~40GHz	Jan. 04, 2017	Apr. 13, 2017 ~ Apr. 20, 2017	Jan. 03, 2018	Radiation (03CH12-HY)



6 Uncertainty of Evaluation

Uncertainty of Radiated Emission Measurement (30 MHz ~ 1000 MHz)

Measuring Uncertainty for a Level of Confidence of 95% ($U = 2Uc(y)$)	3.36
---	------

Uncertainty of Radiated Emission Measurement (1 GHz ~ 18 GHz)

Measuring Uncertainty for a Level of Confidence of 95% ($U = 2Uc(y)$)	3.70
---	------

Uncertainty of Radiated Emission Measurement (18 GHz ~ 40 GHz)

Measuring Uncertainty for a Level of Confidence of 95% ($U = 2Uc(y)$)	3.98
---	------



Appendix A. Test Results of Conducted Test

Conducted Output Power(Average power)

LTE Band 2 Maximum Average Power [dBm]						
BW [MHz]	RB Size	RB Offset	Mod	Lowest	Middle	Highest
20	1	0	QPSK	22.87	22.82	23.06
20	1	49		22.53	22.46	22.92
20	1	99		22.71	22.67	22.98
20	50	0		21.74	21.62	22.05
20	50	24		21.64	21.58	22.06
20	50	50		21.63	21.58	22.04
20	100	0		21.73	21.62	22.04
20	1	0	16-QAM	22.14	22.09	22.15
20	1	49		21.80	21.73	22.16
20	1	99		21.99	21.90	22.20
20	50	0		20.76	20.64	21.06
20	50	24		20.63	20.61	21.03
20	50	50		20.62	20.61	21.05
20	100	0		20.71	20.58	21.05
20	1	0	64-QAM	21.59	21.53	21.81
20	1	49		21.29	21.38	21.43
20	1	99		21.40	21.44	21.50
20	50	0		20.40	20.29	20.41
20	50	24		20.29	20.33	20.64
20	50	50		20.33	20.12	20.46
20	100	0		20.28	20.48	20.65
15	1	0	QPSK	22.70	22.56	23.03
15	1	37		22.59	22.48	22.94
15	1	74		22.55	22.50	22.99
15	36	0		21.70	21.62	22.05
15	36	20		21.71	21.60	22.07
15	36	39		21.58	21.55	22.04
15	75	0		21.71	21.57	22.07
15	1	0	16-QAM	21.97	21.84	22.29
15	1	37		21.88	21.76	22.23
15	1	74		21.81	21.80	22.24
15	36	0		20.71	20.58	21.09
15	36	20		20.72	20.59	21.05
15	36	39		20.57	20.56	21.07
15	75	0		20.72	20.59	21.07
15	1	0	64-QAM	21.50	21.39	21.72
15	1	37		21.15	21.44	21.40
15	1	74		21.36	21.16	21.43
15	36	0		20.33	20.29	20.57
15	36	20		20.28	20.35	20.53
15	36	39		20.16	20.19	20.43
15	75	0		20.28	20.19	20.66



LTE Band 2 Maximum Average Power [dBm]						
BW [MHz]	RB Size	RB Offset	Mod	Lowest	Middle	Highest
10	1	0	QPSK	22.85	22.73	23.05
10	1	25		22.57	22.50	22.98
10	1	49		22.73	22.73	23.02
10	25	0		21.64	21.56	22.07
10	25	12		21.66	21.56	22.08
10	25	25		21.65	21.55	22.06
10	50	0		21.66	21.58	22.07
10	1	0	16-QAM	22.09	22.01	22.25
10	1	25		21.85	21.74	22.25
10	1	49		21.97	21.97	22.18
10	25	0		20.69	20.62	21.08
10	25	12		20.69	20.60	21.06
10	25	25		20.66	20.60	21.09
10	50	0		20.69	20.60	21.11
10	1	0	64-QAM	21.64	21.49	21.55
10	1	25		21.39	21.24	21.62
10	1	49		21.47	21.63	21.48
10	25	0		20.26	20.26	20.63
10	25	12		20.21	20.34	20.66
10	25	25		20.27	20.30	20.38
10	50	0		20.26	20.43	20.58
5	1	0	QPSK	22.60	22.52	23.03
5	1	12		22.54	22.46	23.00
5	1	24		22.59	22.51	23.05
5	12	0		21.62	21.57	22.07
5	12	7		21.63	21.55	22.09
5	12	13		21.61	21.56	22.06
5	25	0		21.61	21.58	22.07
5	1	0	16-QAM	21.87	21.77	22.28
5	1	12		21.85	21.76	22.24
5	1	24		21.87	21.78	22.17
5	12	0		20.64	20.57	21.09
5	12	7		20.65	20.61	21.10
5	12	13		20.63	20.56	21.07
5	25	0		20.63	20.56	21.09
5	1	0	64-QAM	21.35	21.34	21.49
5	1	12		21.28	21.38	21.51
5	1	24		21.33	21.38	21.38
5	12	0		20.15	20.27	20.68
5	12	7		20.28	20.43	20.39
5	12	13		20.32	20.19	20.53
5	25	0		20.36	20.18	20.59



LTE Band 2 Maximum Average Power [dBm]						
BW [MHz]	RB Size	RB Offset	Mod	Lowest	Middle	Highest
3	1	0	QPSK	22.13	22.23	22.47
3	1	8		22.16	22.21	22.35
3	1	14		22.10	22.25	22.53
3	8	0		21.28	21.21	21.50
3	8	4		21.25	21.31	21.46
3	8	7		21.22	21.29	21.47
3	15	0		21.28	21.33	21.55
3	1	0	16-QAM	21.26	21.41	21.65
3	1	8		21.34	21.42	21.74
3	1	14		21.45	21.33	21.56
3	8	0		20.27	20.23	20.51
3	8	4		20.25	20.23	20.49
3	8	7		20.28	20.37	20.44
3	15	0		20.35	20.27	20.41
3	1	0	64-QAM	21.26	21.41	21.56
3	1	8		21.26	21.28	21.55
3	1	14		21.48	21.16	21.49
3	8	0		20.29	20.10	20.49
3	8	4		20.25	20.14	20.42
3	8	7		20.18	20.17	20.43
3	15	0		20.08	20.20	20.59
1.4	1	0	QPSK	22.09	22.20	22.45
1.4	1	3		22.20	22.12	22.36
1.4	1	5		22.11	22.15	22.33
1.4	3	0		22.15	22.15	22.34
1.4	3	1		22.28	22.17	22.59
1.4	3	3		22.06	22.13	22.40
1.4	6	0		21.20	21.22	21.48
1.4	1	0	16-QAM	21.34	21.23	21.53
1.4	1	3		21.32	21.35	21.57
1.4	1	5		21.31	21.40	21.48
1.4	3	0		21.14	21.07	21.49
1.4	3	1		21.11	21.14	21.47
1.4	3	3		21.21	21.18	21.31
1.4	6	0		20.23	20.19	20.49
1.4	1	0	64-QAM	21.08	21.09	21.53
1.4	1	3		21.41	21.30	21.52
1.4	1	5		21.28	21.18	21.40
1.4	3	0		21.19	21.26	21.54
1.4	3	1		21.30	21.14	21.40
1.4	3	3		21.14	21.23	21.43
1.4	6	0		20.06	20.20	20.41



LTE Band 25 Maximum Average Power [dBm]						
BW [MHz]	RB Size	RB Offset	Mod	Lowest	Middle	Highest
20	1	0	QPSK	22.87	22.92	22.81
20	1	49		22.55	22.52	22.70
20	1	99		22.67	22.72	22.76
20	50	0		21.68	21.65	21.83
20	50	24		21.68	21.63	21.83
20	50	50		21.57	21.60	21.81
20	100	0		21.68	21.63	21.83
20	1	0	16-QAM	22.24	22.16	22.07
20	1	49		21.88	21.82	22.02
20	1	99		21.95	22.01	22.00
20	50	0		20.72	20.67	20.83
20	50	24		20.67	20.65	20.87
20	50	50		20.55	20.61	20.85
20	100	0		20.67	20.64	20.84
20	1	0	64-QAM	20.57	20.83	20.66
20	1	49		20.42	20.46	20.48
20	1	99		20.26	20.43	20.31
20	50	0		19.23	19.64	19.37
20	50	24		19.28	19.39	19.43
20	50	50		19.34	19.22	19.32
20	100	0		19.29	19.66	19.53
15	1	0	QPSK	22.77	22.64	22.84
15	1	37		22.55	22.53	22.72
15	1	74		22.51	22.57	22.77
15	36	0		21.75	21.65	21.83
15	36	20		21.64	21.63	21.84
15	36	39		21.61	21.61	21.85
15	75	0		21.64	21.62	21.87
15	1	0	16-QAM	22.05	21.92	22.14
15	1	37		21.86	21.85	22.03
15	1	74		21.78	21.89	22.03
15	36	0		20.76	20.63	20.85
15	36	20		20.66	20.62	20.85
15	36	39		20.60	20.61	20.82
15	75	0		20.65	20.60	20.85
15	1	0	64-QAM	20.46	20.47	20.79
15	1	37		20.13	20.28	20.21
15	1	74		20.27	20.13	20.47
15	36	0		19.24	19.28	19.66
15	36	20		19.15	19.30	19.48
15	36	39		19.36	19.17	19.36
15	75	0		19.32	19.39	19.38



LTE Band 25 Maximum Average Power [dBm]						
BW [MHz]	RB Size	RB Offset	Mod	Lowest	Middle	Highest
10	1	0	QPSK	22.90	22.78	22.79
10	1	25		22.54	22.53	22.76
10	1	49		22.75	22.77	22.82
10	25	0		21.70	21.60	21.84
10	25	12		21.58	21.61	21.87
10	25	25		21.58	21.61	21.89
10	50	0		21.60	21.62	21.86
10	1	0	16-QAM	22.18	22.08	22.10
10	1	25		21.83	21.83	21.98
10	1	49		22.03	22.06	22.02
10	25	0		20.73	20.63	20.87
10	25	12		20.65	20.65	20.86
10	25	25		20.60	20.60	20.87
10	50	0		20.62	20.63	20.88
10	1	0	64-QAM	20.47	20.52	20.46
10	1	25		20.24	20.37	20.47
10	1	49		20.29	20.46	20.40
10	25	0		19.28	19.23	19.38
10	25	12		19.28	19.35	19.34
10	25	25		19.28	19.46	19.38
10	50	0		19.33	19.31	19.46
5	1	0	QPSK	22.66	22.57	22.80
5	1	12		22.60	22.50	22.79
5	1	24		22.53	22.55	22.81
5	12	0		21.67	21.60	21.84
5	12	7		21.67	21.63	21.87
5	12	13		21.64	21.60	21.84
5	25	0		21.65	21.57	21.86
5	1	0	16-QAM	21.94	21.87	22.00
5	1	12		21.91	21.86	21.99
5	1	24		21.84	21.87	22.01
5	12	0		20.70	20.60	20.83
5	12	7		20.70	20.62	20.85
5	12	13		20.66	20.59	20.82
5	25	0		20.69	20.60	20.84
5	1	0	64-QAM	20.22	20.35	20.44
5	1	12		20.15	20.26	20.37
5	1	24		20.19	20.44	20.32
5	12	0		19.33	19.27	19.41
5	12	7		19.11	19.31	19.29
5	12	13		19.07	19.18	19.39
5	25	0		19.11	19.40	19.42



LTE Band 25 Maximum Average Power [dBm]						
BW [MHz]	RB Size	RB Offset	Mod	Lowest	Middle	Highest
3	1	0	QPSK	22.18	22.21	22.31
3	1	8		22.20	22.12	22.37
3	1	14		22.16	22.10	22.41
3	8	0		21.12	21.37	21.38
3	8	4		21.14	21.24	21.37
3	8	7		21.19	21.18	21.30
3	15	0		21.15	21.25	21.27
3	1	0	16-QAM	21.40	21.52	21.52
3	1	8		21.30	21.51	21.46
3	1	14		21.43	21.47	21.44
3	8	0		20.30	20.40	20.37
3	8	4		20.28	20.27	20.43
3	8	7		20.14	20.28	20.46
3	15	0		20.23	20.32	20.26
3	1	0	64-QAM	20.21	20.31	20.40
3	1	8		20.25	20.33	20.34
3	1	14		20.25	20.30	20.42
3	8	0		19.34	19.36	19.39
3	8	4		19.23	19.25	19.52
3	8	7		19.26	19.30	19.23
3	15	0		19.05	19.22	19.46
1.4	1	0	QPSK	22.07	22.06	22.29
1.4	1	3		22.17	22.22	22.24
1.4	1	5		22.04	22.08	22.20
1.4	3	0		22.13	22.20	22.25
1.4	3	1		22.21	22.26	22.39
1.4	3	3		22.04	22.24	22.27
1.4	6	0		21.02	21.27	21.36
1.4	1	0	16-QAM	21.20	21.42	21.30
1.4	1	3		21.27	21.46	21.49
1.4	1	5		21.20	21.28	21.40
1.4	3	0		21.09	21.13	21.38
1.4	3	1		21.05	21.35	21.34
1.4	3	3		21.18	21.13	21.26
1.4	6	0		20.15	20.37	20.36
1.4	1	0	64-QAM	20.24	20.58	20.29
1.4	1	3		20.07	20.33	20.27
1.4	1	5		20.10	20.22	20.24
1.4	3	0		20.09	20.16	20.25
1.4	3	1		20.19	20.34	20.20
1.4	3	3		20.09	20.33	20.28
1.4	6	0		19.10	19.25	19.35



LTE Band 4 Maximum Average Power [dBm]						
BW [MHz]	RB Size	RB Offset	Mod	Lowest	Middle	Highest
20	1	0	QPSK	22.80	22.84	22.92
20	1	49		22.64	22.69	22.67
20	1	99		22.65	22.70	22.65
20	50	0		21.77	21.84	21.88
20	50	24		21.72	21.78	21.73
20	50	50		21.70	21.73	21.74
20	100	0		21.74	21.77	21.79
20	1	0	16-QAM	22.06	22.08	22.21
20	1	49		21.90	21.94	21.95
20	1	99		21.89	21.97	21.94
20	50	0		20.78	20.83	20.91
20	50	24		20.73	20.78	20.77
20	50	50		20.70	20.74	20.72
20	100	0		20.73	20.76	20.78
20	1	0	64-QAM	21.84	21.88	21.63
20	1	49		21.43	21.45	21.57
20	1	99		21.16	21.48	21.61
20	50	0		20.53	20.46	20.43
20	50	24		20.59	20.48	20.65
20	50	50		20.43	20.34	20.56
20	100	0		20.64	20.54	20.55
15	1	0	QPSK	22.77	22.85	22.91
15	1	37		22.63	22.67	22.68
15	1	74		22.68	22.70	22.72
15	36	0		21.74	21.78	21.82
15	36	20		21.69	21.78	21.74
15	36	39		21.67	21.73	21.70
15	75	0		21.71	21.77	21.75
15	1	0	16-QAM	22.03	22.10	22.20
15	1	37		21.92	21.95	21.99
15	1	74		21.95	21.99	22.01
15	36	0		20.76	20.79	20.80
15	36	20		20.75	20.76	20.78
15	36	39		20.67	20.76	20.74
15	75	0		20.71	20.76	20.77
15	1	0	64-QAM	21.68	21.48	21.64
15	1	37		21.48	21.37	21.62
15	1	74		21.36	21.41	21.37
15	36	0		20.65	20.44	20.57
15	36	20		20.44	20.39	20.51
15	36	39		20.44	20.54	20.53
15	75	0		20.34	20.26	20.56



LTE Band 4 Maximum Average Power [dBm]						
BW [MHz]	RB Size	RB Offset	Mod	Lowest	Middle	Highest
10	1	0	QPSK	22.73	22.80	22.82
10	1	25		22.68	22.73	22.72
10	1	49		22.69	22.73	22.70
10	25	0		21.73	21.77	21.79
10	25	12		21.73	21.75	21.75
10	25	25		21.68	21.76	21.76
10	50	0		21.71	21.75	21.77
10	1	0	16-QAM	21.97	22.02	22.07
10	1	25		21.94	21.94	22.01
10	1	49		21.94	21.98	22.02
10	25	0		20.72	20.77	20.79
10	25	12		20.74	20.75	20.78
10	25	25		20.68	20.73	20.73
10	50	0		20.75	20.76	20.79
10	1	0	64-QAM	21.69	21.62	21.72
10	1	25		21.56	21.40	21.65
10	1	49		21.37	21.50	21.53
10	25	0		20.56	20.46	20.60
10	25	12		20.62	20.52	20.63
10	25	25		20.44	20.29	20.57
10	50	0		20.48	20.41	20.66
5	1	0	QPSK	22.70	22.74	22.75
5	1	12		22.66	22.73	22.71
5	1	24		22.64	22.73	22.71
5	12	0		21.66	21.76	21.77
5	12	7		21.69	21.75	21.79
5	12	13		21.65	21.71	21.70
5	25	0		21.69	21.73	21.75
5	1	0	16-QAM	21.94	21.97	22.08
5	1	12		21.92	21.98	22.05
5	1	24		21.91	21.97	22.01
5	12	0		20.72	20.76	20.78
5	12	7		20.69	20.77	20.77
5	12	13		20.65	20.72	20.78
5	25	0		20.69	20.74	20.77
5	1	0	64-QAM	21.62	21.41	21.53
5	1	12		21.55	21.50	21.68
5	1	24		21.70	21.27	21.65
5	12	0		20.38	20.36	20.66
5	12	7		20.55	20.39	20.56
5	12	13		20.51	20.52	20.40
5	25	0		20.56	20.42	20.51



LTE Band 4 Maximum Average Power [dBm]						
BW [MHz]	RB Size	RB Offset	Mod	Lowest	Middle	Highest
3	1	0	QPSK	22.44	22.32	22.52
3	1	8		22.50	22.41	22.36
3	1	14		22.44	22.23	22.53
3	8	0		21.53	21.28	21.51
3	8	4		21.42	21.43	21.53
3	8	7		21.54	21.38	21.45
3	15	0		21.38	21.27	21.50
3	1	0	16-QAM	21.65	21.49	21.64
3	1	8		21.74	21.59	21.76
3	1	14		21.69	21.52	21.67
3	8	0		20.46	20.49	20.50
3	8	4		20.53	20.47	20.59
3	8	7		20.50	20.38	20.57
3	15	0		20.50	20.39	20.45
3	1	0	64-QAM	21.58	21.44	21.45
3	1	8		21.65	21.37	21.44
3	1	14		21.36	21.36	21.59
3	8	0		20.48	20.31	20.74
3	8	4		20.47	20.40	20.46
3	8	7		20.50	20.37	20.41
3	15	0		20.54	20.18	20.45
1.4	1	0	QPSK	22.26	22.27	22.29
1.4	1	3		22.50	22.26	22.48
1.4	1	5		22.27	22.27	22.40
1.4	3	0		22.47	22.23	22.45
1.4	3	1		22.47	22.43	22.49
1.4	3	3		22.42	22.37	22.40
1.4	6	0		21.39	21.31	21.49
1.4	1	0	16-QAM	21.49	21.49	21.75
1.4	1	3		21.55	21.50	21.67
1.4	1	5		21.53	21.47	21.62
1.4	3	0		21.36	21.18	21.39
1.4	3	1		21.52	21.37	21.44
1.4	3	3		21.42	21.21	21.49
1.4	6	0		20.38	20.46	20.52
1.4	1	0	64-QAM	21.39	21.24	21.44
1.4	1	3		21.34	21.40	21.60
1.4	1	5		21.63	21.37	21.70
1.4	3	0		21.39	21.24	21.57
1.4	3	1		21.45	21.15	21.49
1.4	3	3		21.48	21.24	21.50
1.4	6	0		20.36	20.31	20.41



LTE Band 5 Maximum Average Power [dBm]						
BW [MHz]	RB Size	RB Offset	Mod	Lowest	Middle	Highest
10	1	0	QPSK	23.66	23.57	23.47
10	1	25		23.44	23.45	23.40
10	1	49		23.46	23.38	23.29
10	25	0		22.56	22.56	22.47
10	25	12		22.54	22.52	22.48
10	25	25		22.56	22.48	22.43
10	50	0		22.49	22.53	22.43
10	1	0	16-QAM	22.73	22.78	22.73
10	1	25		22.63	22.73	22.65
10	1	49		22.69	22.64	22.53
10	25	0		21.53	21.57	21.50
10	25	12		21.53	21.56	21.49
10	25	25		21.54	21.50	21.40
10	50	0		21.51	21.52	21.45
10	1	0	64-QAM	21.43	21.20	21.25
10	1	25		21.37	21.26	21.10
10	1	49		21.23	21.06	20.90
10	25	0		20.19	20.21	20.11
10	25	12		20.17	20.06	19.99
10	25	25		20.18	20.09	19.88
10	50	0		20.29	20.18	19.87
5	1	0	QPSK	23.65	23.44	23.62
5	1	12		23.62	23.39	23.62
5	1	24		23.59	23.38	23.59
5	12	0		22.67	22.45	22.67
5	12	7		22.68	22.44	22.68
5	12	13		22.62	22.40	22.62
5	25	0		22.66	22.46	22.66
5	1	0	16-QAM	22.81	22.70	22.81
5	1	12		22.79	22.66	22.79
5	1	24		22.75	22.60	22.75
5	12	0		21.66	21.50	21.66
5	12	7		21.68	21.50	21.68
5	12	13		21.63	21.42	21.63
5	25	0		21.67	21.45	21.67
5	1	0	64-QAM	21.43	21.27	21.34
5	1	12		21.36	21.32	21.11
5	1	24		21.28	21.10	20.93
5	12	0		20.23	20.14	19.99
5	12	7		20.20	20.14	19.91
5	12	13		20.12	20.15	19.80
5	25	0		20.16	20.12	19.98



LTE Band 5 Maximum Average Power [dBm]						
BW [MHz]	RB Size	RB Offset	Mod	Lowest	Middle	Highest
3	1	0	QPSK	23.65	23.54	23.40
3	1	8		23.64	23.49	23.38
3	1	14		23.61	23.48	23.31
3	8	0		22.65	22.53	22.46
3	8	4		22.66	22.54	22.43
3	8	7		22.64	22.53	22.43
3	15	0		22.65	22.51	22.40
3	1	0	16-QAM	22.83	22.77	22.64
3	1	8		22.85	22.76	22.62
3	1	14		22.77	22.74	22.55
3	8	0		21.73	21.60	21.51
3	8	4		21.73	21.63	21.51
3	8	7		21.71	21.58	21.45
3	15	0		21.66	21.57	21.44
3	1	0	64-QAM	21.29	21.22	21.22
3	1	8		21.25	21.33	21.11
3	1	14		21.38	21.19	20.92
3	8	0		20.24	20.04	20.10
3	8	4		20.19	20.11	19.88
3	8	7		20.14	20.03	19.80
3	15	0		20.23	20.13	19.86
1.4	1	0	QPSK	23.52	23.50	23.37
1.4	1	3		23.56	23.44	23.41
1.4	1	5		23.47	23.39	23.32
1.4	3	0		23.55	23.43	23.41
1.4	3	1		23.61	23.48	23.47
1.4	3	3		23.56	23.47	23.41
1.4	6	0		22.57	22.46	22.42
1.4	1	0	16-QAM	22.72	22.68	22.64
1.4	1	3		22.77	22.74	22.66
1.4	1	5		22.72	22.63	22.56
1.4	3	0		22.55	22.44	22.43
1.4	3	1		22.59	22.48	22.46
1.4	3	3		22.55	22.45	22.41
1.4	6	0		21.62	21.52	21.49
1.4	1	0	64-QAM	21.39	21.38	21.26
1.4	1	3		21.26	21.28	20.96
1.4	1	5		21.29	21.14	20.98
1.4	3	0		21.25	21.21	21.07
1.4	3	1		21.26	21.11	21.04
1.4	3	3		21.15	21.15	21.02
1.4	6	0		20.23	20.16	19.96



LTE Band 7 Maximum Average Power [dBm]						
BW [MHz]	RB Size	RB Offset	Mod	Lowest	Middle	Highest
20	1	0	QPSK	22.15	22.51	22.34
20	1	49		22.15	22.46	22.24
20	1	99		22.28	22.38	22.16
20	50	0		21.13	21.58	21.31
20	50	24		21.24	21.55	21.33
20	50	50		21.20	21.53	21.16
20	100	0		21.22	21.57	21.30
20	1	0	16-QAM	21.45	21.74	21.61
20	1	49		21.43	21.77	21.52
20	1	99		21.56	21.65	21.43
20	50	0		20.19	20.58	20.34
20	50	24		20.25	20.56	20.32
20	50	50		20.20	20.54	20.17
20	100	0		20.20	20.55	20.30
20	1	0	64-QAM	20.83	20.81	20.83
20	1	49		20.76	20.81	20.68
20	1	99		20.86	20.53	20.51
20	50	0		19.53	19.79	19.88
20	50	24		19.83	19.68	19.90
20	50	50		19.78	19.79	19.69
20	100	0		19.85	19.65	19.88
15	1	0	QPSK	22.16	22.43	22.33
15	1	37		22.16	22.49	22.14
15	1	74		22.15	22.38	22.16
15	36	0		21.12	21.58	21.30
15	36	20		21.21	21.56	21.22
15	36	39		21.17	21.55	21.18
15	75	0		21.20	21.55	21.19
15	1	0	16-QAM	21.43	21.72	21.60
15	1	37		21.44	21.78	21.44
15	1	74		21.43	21.66	21.44
15	36	0		20.15	20.56	20.32
15	36	20		20.22	20.58	20.21
15	36	39		20.20	20.55	20.14
15	75	0		20.21	20.53	20.20
15	1	0	64-QAM	20.56	20.68	20.66
15	1	37		20.40	20.52	20.62
15	1	74		20.48	20.34	20.67
15	36	0		19.60	19.66	19.89
15	36	20		19.64	19.57	19.66
15	36	39		19.51	19.55	19.60
15	75	0		19.47	19.75	19.78



LTE Band 7 Maximum Average Power [dBm]						
BW [MHz]	RB Size	RB Offset	Mod	Lowest	Middle	Highest
10	1	0	QPSK	22.04	22.49	22.26
10	1	25		22.00	22.47	22.12
10	1	49		22.05	22.45	22.08
10	25	0		21.03	21.49	21.13
10	25	12		21.05	21.50	21.17
10	25	25		21.09	21.45	21.13
10	50	0		21.04	21.49	21.10
10	1	0	16-QAM	21.32	21.74	21.51
10	1	25		21.27	21.73	21.39
10	1	49		21.35	21.70	21.36
10	25	0		20.05	20.48	20.15
10	25	12		20.07	20.50	20.14
10	25	25		20.10	20.46	20.10
10	50	0		20.06	20.51	20.13
10	1	0	64-QAM	20.98	20.66	21.19
10	1	25		20.90	20.82	21.14
10	1	49		20.82	20.52	20.94
10	25	0		19.96	19.72	20.13
10	25	12		20.03	19.62	20.17
10	25	25		19.85	19.76	20.23
10	50	0		19.95	19.86	20.14
5	1	0	QPSK	22.01	22.45	22.12
5	1	12		22.02	22.47	22.14
5	1	24		22.00	22.45	22.13
5	12	0		21.04	21.50	21.18
5	12	7		21.09	21.54	21.17
5	12	13		21.07	21.47	21.13
5	25	0		21.02	21.48	21.13
5	1	0	16-QAM	21.30	21.70	21.41
5	1	12		21.30	21.73	21.44
5	1	24		21.22	21.71	21.38
5	12	0		20.08	20.49	20.18
5	12	7		20.10	20.56	20.18
5	12	13		20.08	20.48	20.15
5	25	0		20.04	20.48	20.14
5	1	0	64-QAM	21.10	20.61	21.08
5	1	12		20.78	20.55	21.29
5	1	24		20.78	20.58	21.18
5	12	0		19.99	19.85	20.15
5	12	7		20.03	19.79	20.19
5	12	13		20.02	19.57	20.15
5	25	0		19.92	19.74	20.27



LTE Band 12 Maximum Average Power [dBm]						
BW [MHz]	RB Size	RB Offset	Mod	Lowest	Middle	Highest
10	1	0	QPSK	23.22	23.31	23.44
10	1	25		23.28	23.36	23.32
10	1	49		23.37	23.30	23.36
10	25	0		22.36	22.31	22.38
10	25	12		22.36	22.42	22.41
10	25	25		22.41	22.42	22.48
10	50	0		22.44	22.42	22.36
10	1	0	16-QAM	22.48	22.57	22.55
10	1	25		22.57	22.56	22.56
10	1	49		22.54	22.58	22.63
10	25	0		21.35	21.35	21.40
10	25	12		21.39	21.45	21.39
10	25	25		21.44	21.40	21.44
10	50	0		21.45	21.44	21.36
10	1	0	64-QAM	21.06	21.01	21.13
10	1	25		21.29	21.26	20.99
10	1	49		21.20	21.16	21.27
10	25	0		19.94	20.12	19.98
10	25	12		20.02	20.05	19.90
10	25	25		20.04	20.04	20.13
10	50	0		20.03	19.94	20.03
5	1	0	QPSK	23.37	23.28	23.32
5	1	12		23.42	23.39	23.39
5	1	24		23.41	23.37	23.38
5	12	0		22.39	22.45	22.48
5	12	7		22.52	22.45	22.45
5	12	13		22.45	22.39	22.44
5	25	0		22.45	22.41	22.43
5	1	0	16-QAM	22.64	22.55	22.57
5	1	12		22.74	22.59	22.68
5	1	24		22.71	22.59	22.61
5	12	0		21.43	21.46	21.45
5	12	7		21.51	21.46	21.48
5	12	13		21.49	21.41	21.48
5	25	0		21.51	21.43	21.45
5	1	0	64-QAM	21.13	21.06	21.14
5	1	12		21.12	21.16	21.08
5	1	24		21.19	21.13	21.17
5	12	0		19.92	20.02	19.97
5	12	7		20.01	20.11	19.91
5	12	13		19.97	19.94	19.94
5	25	0		19.93	19.94	19.94



LTE Band 12 Maximum Average Power [dBm]						
BW [MHz]	RB Size	RB Offset	Mod	Lowest	Middle	Highest
3	1	0	QPSK	23.25	23.39	23.41
3	1	8		23.24	23.38	23.38
3	1	14		23.36	23.37	23.35
3	8	0		22.29	22.43	22.42
3	8	4		22.33	22.45	22.45
3	8	7		22.30	22.42	22.42
3	15	0		22.27	22.38	22.44
3	1	0	16-QAM	22.50	22.59	22.64
3	1	8		22.51	22.55	22.66
3	1	14		22.63	22.51	22.60
3	8	0		21.36	21.48	21.48
3	8	4		21.39	21.52	21.54
3	8	7		21.35	21.48	21.47
3	15	0		21.31	21.42	21.46
3	1	0	64-QAM	21.01	21.07	21.13
3	1	8		21.25	21.09	21.07
3	1	14		21.18	21.05	21.07
3	8	0		19.82	20.02	20.05
3	8	4		20.09	20.12	20.03
3	8	7		19.93	20.08	19.95
3	15	0		20.10	19.99	19.89
1.4	1	0	QPSK	23.15	23.25	23.31
1.4	1	3		23.22	23.30	23.34
1.4	1	5		23.16	23.27	23.26
1.4	3	0		23.22	23.33	23.34
1.4	3	1		23.24	23.40	23.39
1.4	3	3		23.21	23.33	23.32
1.4	6	0		22.22	22.32	22.31
1.4	1	0	16-QAM	22.40	22.48	22.53
1.4	1	3		22.50	22.53	22.60
1.4	1	5		22.42	22.47	22.52
1.4	3	0		22.25	22.33	22.33
1.4	3	1		22.28	22.36	22.38
1.4	3	3		22.25	22.33	22.34
1.4	6	0		21.29	21.39	21.41
1.4	1	0	64-QAM	21.08	21.07	21.14
1.4	1	3		21.28	21.15	20.97
1.4	1	5		21.14	20.97	21.21
1.4	3	0		20.83	20.96	20.96
1.4	3	1		21.10	21.04	21.02
1.4	3	3		21.06	20.93	21.10
1.4	6	0		19.99	19.99	19.93



LTE Band 17 Maximum Average Power [dBm]						
BW [MHz]	RB Size	RB Offset	Mod	Lowest	Middle	Highest
10	1	0	QPSK	23.15	23.43	23.22
10	1	25		23.32	23.29	23.32
10	1	49		23.36	23.34	23.34
10	25	0		22.40	22.40	22.37
10	25	12		22.41	22.41	22.39
10	25	25		22.39	22.45	22.43
10	50	0		22.37	22.35	22.36
10	1	0	16-QAM	22.41	22.46	22.43
10	1	25		22.49	22.51	22.53
10	1	49		22.64	22.61	22.59
10	25	0		21.40	21.39	21.37
10	25	12		21.42	21.42	21.39
10	25	25		21.37	21.42	21.42
10	50	0		21.40	21.36	21.35
10	1	0	64-QAM	21.05	21.13	21.14
10	1	25		21.23	21.10	21.16
10	1	49		21.27	21.15	21.13
10	25	0		19.96	20.02	20.00
10	25	12		20.09	20.09	19.96
10	25	25		19.96	20.06	20.10
10	50	0		19.99	20.13	20.08
5	1	0	QPSK	23.08	23.34	23.31
5	1	12		23.15	23.32	23.38
5	1	24		23.27	23.42	23.36
5	12	0		22.24	22.38	22.43
5	12	7		22.26	22.39	22.46
5	12	13		22.21	22.33	22.40
5	25	0		22.21	22.40	22.44
5	1	0	16-QAM	22.33	22.49	22.53
5	1	12		22.40	22.52	22.63
5	1	24		22.42	22.65	22.56
5	12	0		21.26	21.38	21.46
5	12	7		21.26	21.38	21.44
5	12	13		21.19	21.35	21.41
5	25	0		21.23	21.38	21.41
5	1	0	64-QAM	21.05	21.12	21.15
5	1	12		21.04	21.15	21.12
5	1	24		21.23	21.28	21.09
5	12	0		20.02	20.00	20.07
5	12	7		20.11	20.02	20.06
5	12	13		20.04	20.01	20.01
5	25	0		20.10	19.94	19.94



LTE Band 26 Maximum Average Power [dBm]						
BW [MHz]	RB Size	RB Offset	Mod	Lowest	Middle	Highest
15	1	0	QPSK	23.70	23.75	23.73
15	1	37		23.68	23.65	23.58
15	1	74		23.72	23.47	23.57
15	36	0		22.93	22.91	22.78
15	36	20		22.85	22.78	22.67
15	36	39		22.73	22.66	22.60
15	75	0		22.68	22.73	22.75
15	1	0	16-QAM	22.92	22.99	23.08
15	1	37		23.02	22.90	22.90
15	1	74		22.91	22.91	22.74
15	36	0		21.82	21.80	21.79
15	36	20		21.78	21.75	21.76
15	36	39		21.79	21.77	21.59
15	75	0		21.85	21.76	21.79
15	1	0	64-QAM	21.46	21.51	21.57
15	1	37		21.43	21.52	21.36
15	1	74		21.36	21.46	21.26
15	36	0		20.33	20.35	20.32
15	36	20		20.36	20.42	20.21
15	36	39		20.41	20.32	20.18
15	75	0		20.41	20.30	20.25
10	1	0	QPSK	23.62	23.69	23.66
10	1	25		23.64	23.70	23.57
10	1	49		23.65	23.60	23.46
10	25	0		22.64	22.79	22.66
10	25	12		22.69	22.80	22.67
10	25	25		22.67	22.73	22.60
10	50	0		22.69	22.73	22.63
10	1	0	16-QAM	22.86	22.89	22.91
10	1	25		22.89	22.96	22.83
10	1	49		22.89	22.87	22.71
10	25	0		21.63	21.81	21.69
10	25	12		21.73	21.77	21.66
10	25	25		21.65	21.69	21.58
10	50	0		21.72	21.77	21.64
10	1	0	64-QAM	21.49	21.64	21.57
10	1	25		21.40	21.57	21.34
10	1	49		21.43	21.41	21.17
10	25	0		20.28	20.40	20.33
10	25	12		20.35	20.48	20.32
10	25	25		20.41	20.39	20.11
10	50	0		20.40	20.38	20.20



LTE Band 26 Maximum Average Power [dBm]						
BW [MHz]	RB Size	RB Offset	Mod	Lowest	Middle	Highest
5	1	0	QPSK	23.72	23.72	23.58
5	1	12		23.69	23.71	23.55
5	1	24		23.66	23.67	23.53
5	12	0		22.75	22.75	22.60
5	12	7		22.73	22.75	22.64
5	12	13		22.82	22.71	22.56
5	25	0		22.69	22.72	22.61
5	1	0	16-QAM	22.96	22.94	22.84
5	1	12		22.93	22.92	22.83
5	1	24		22.98	22.91	22.74
5	12	0		21.77	21.80	21.65
5	12	7		21.78	21.79	21.60
5	12	13		21.81	21.74	21.58
5	25	0		21.73	21.77	21.61
5	1	0	64-QAM	21.42	21.63	21.65
5	1	12		21.38	21.48	21.28
5	1	24		21.35	21.36	21.20
5	12	0		20.29	20.51	20.48
5	12	7		20.42	20.54	20.33
5	12	13		20.27	20.42	20.24
5	25	0		20.29	20.46	20.14
3	1	0	QPSK	23.74	23.74	23.58
3	1	8		23.70	23.73	23.54
3	1	14		23.69	23.69	23.54
3	8	0		22.76	22.78	22.60
3	8	4		22.77	22.76	22.65
3	8	7		22.73	22.76	22.57
3	15	0		22.75	22.74	22.60
3	1	0	16-QAM	22.95	22.91	22.80
3	1	8		22.95	22.94	22.79
3	1	14		22.90	22.92	22.68
3	8	0		21.82	21.82	21.68
3	8	4		21.81	21.85	21.66
3	8	7		21.80	21.79	21.65
3	15	0		21.77	21.79	21.60
3	1	0	64-QAM	21.39	21.49	21.47
3	1	8		21.52	21.58	21.26
3	1	14		21.29	21.50	21.20
3	8	0		20.47	20.35	20.32
3	8	4		20.43	20.42	20.30
3	8	7		20.41	20.30	20.26
3	15	0		20.35	20.33	20.16



LTE Band 26 Maximum Average Power [dBm]						
BW [MHz]	RB Size	RB Offset	Mod	Lowest	Middle	Highest
1.4	1	0	QPSK	23.53	23.61	23.46
1.4	1	3		23.58	23.67	23.49
1.4	1	5		23.50	23.60	23.40
1.4	3	0		23.57	23.67	23.49
1.4	3	1		23.63	23.72	23.55
1.4	3	3		23.57	23.68	23.47
1.4	6	0		22.60	22.65	22.48
1.4	1	0	16-QAM	22.75	22.86	22.71
1.4	1	3		22.82	22.92	22.74
1.4	1	5		22.76	22.82	22.66
1.4	3	0		22.58	22.68	22.51
1.4	3	1		22.62	22.71	22.56
1.4	3	3		22.56	22.66	22.47
1.4	6	0		21.61	21.75	21.55
1.4	1	0	64-QAM	21.42	21.51	21.51
1.4	1	3		21.52	21.55	21.28
1.4	1	5		21.36	21.40	21.20
1.4	3	0		20.31	20.33	20.38
1.4	3	1		20.39	20.55	20.37
1.4	3	3		20.39	20.30	20.18
1.4	6	0		20.38	20.47	20.17



LTE Band 38 Maximum Average Power [dBm]						
BW [MHz]	RB Size	RB Offset	Mod	Lowest	Middle	Highest
20	1	0	QPSK	22.19	22.33	22.22
20	1	49		22.11	22.24	22.06
20	1	99		22.23	22.12	22.03
20	50	0		21.16	21.22	21.10
20	50	24		21.16	21.15	21.08
20	50	50		21.21	21.08	21.10
20	100	0		21.14	21.18	21.06
20	1	0	16-QAM	21.29	21.40	21.27
20	1	49		21.14	21.28	21.13
20	1	99		21.31	21.22	21.07
20	50	0		20.22	20.28	20.17
20	50	24		20.15	20.25	20.10
20	50	50		20.22	20.07	20.10
20	100	0		20.11	20.24	20.10
20	1	0	64-QAM	21.91	21.89	21.84
20	1	49		21.82	21.95	21.87
20	1	99		21.65	21.72	21.80
20	50	0		20.70	20.82	20.98
20	50	24		20.85	20.95	20.79
20	50	50		20.61	20.84	20.80
20	100	0		20.65	20.84	20.85
15	1	0	QPSK	22.07	22.26	22.20
15	1	37		22.00	22.21	22.06
15	1	74		22.12	22.18	22.01
15	36	0		22.07	21.13	21.01
15	36	20		21.00	21.21	21.02
15	36	39		22.02	21.02	22.02
15	75	0		21.00	21.16	21.04
15	1	0	16-QAM	21.13	21.36	21.26
15	1	37		21.06	21.25	21.14
15	1	74		21.19	21.20	21.09
15	36	0		20.01	20.17	20.08
15	36	20		20.07	20.20	20.05
15	36	39		20.01	20.06	20.01
15	75	0		20.08	20.14	20.10
15	1	0	64-QAM	21.83	21.77	21.95
15	1	37		21.81	21.74	21.80
15	1	74		21.88	21.80	21.72
15	36	0		20.77	20.88	20.85
15	36	20		20.84	20.76	20.82
15	36	39		20.76	20.50	20.66
15	75	0		20.91	20.69	20.82



LTE Band 38 Maximum Average Power [dBm]						
BW [MHz]	RB Size	RB Offset	Mod	Lowest	Middle	Highest
10	1	0	QPSK	22.09	22.22	22.05
10	1	25		22.08	22.22	22.07
10	1	49		22.09	22.11	22.01
10	25	0		21.07	21.12	21.07
10	25	12		21.06	21.17	21.10
10	25	25		21.10	21.10	21.05
10	50	0		21.03	21.17	21.08
10	1	0	16-QAM	21.24	21.34	21.18
10	1	25		21.18	21.31	21.19
10	1	49		21.13	21.16	21.05
10	25	0		20.05	20.21	20.07
10	25	12		20.15	20.17	20.15
10	25	25		20.08	20.21	20.04
10	50	0		20.11	20.24	20.16
10	1	0	64-QAM	21.80	21.88	21.70
10	1	25		21.74	21.76	21.53
10	1	49		21.63	21.84	21.75
10	25	0		20.82	20.69	20.63
10	25	12		20.76	20.84	20.60
10	25	25		20.72	20.78	20.73
10	50	0		20.76	20.59	20.80
5	1	0	QPSK	22.01	22.20	22.08
5	1	12		22.09	22.21	22.09
5	1	24		22.06	22.18	22.07
5	12	0		21.02	21.19	21.09
5	12	7		21.02	21.20	21.06
5	12	13		21.00	21.14	21.03
5	25	0		21.01	21.13	21.03
5	1	0	16-QAM	21.02	21.25	21.09
5	1	12		21.07	21.31	21.12
5	1	24		21.06	21.27	21.09
5	12	0		20.00	20.17	20.00
5	12	7		20.06	20.16	20.09
5	12	13		20.08	20.17	20.09
5	25	0		20.09	20.19	20.01
5	1	0	64-QAM	21.81	21.72	21.76
5	1	12		21.85	21.80	21.79
5	1	24		21.71	21.69	21.81
5	12	0		20.77	20.65	20.67
5	12	7		20.67	20.80	20.61
5	12	13		20.85	20.55	20.68
5	25	0		20.80	20.79	20.73



LTE Band 41 Maximum Average Power [dBm]						
BW [MHz]	RB Size	RB Offset	Mod	Lowest	Middle	Highest
20	1	0	QPSK	22.50	22.50	22.50
20	1	49		22.43	22.49	22.33
20	1	99		22.43	22.30	22.31
20	50	0		21.48	21.45	21.28
20	50	24		21.47	21.37	21.29
20	50	50		21.47	21.27	21.21
20	100	0		21.46	21.49	21.27
20	1	0	16-QAM	21.58	21.25	21.60
20	1	49		21.49	21.42	21.43
20	1	99		21.51	21.36	21.39
20	50	0		20.49	20.50	20.33
20	50	24		20.50	20.25	20.35
20	50	50		20.45	20.31	20.22
20	100	0		20.43	20.27	20.32
20	1	0	64-QAM	20.65	20.45	20.39
20	1	49		20.52	20.37	20.40
20	1	99		20.56	20.52	20.33
20	50	0		19.47	19.48	19.38
20	50	24		19.48	19.36	19.26
20	50	50		19.38	19.29	19.12
20	100	0		19.48	19.42	19.19
15	1	0	QPSK	22.47	22.47	22.29
15	1	37		22.30	22.25	22.30
15	1	74		22.34	22.35	22.28
15	36	0		21.31	21.42	21.16
15	36	20		21.44	21.16	21.21
15	36	39		21.42	21.40	21.10
15	75	0		21.42	21.19	21.20
15	1	0	16-QAM	21.56	21.65	21.37
15	1	37		21.51	21.02	21.35
15	1	74		21.52	21.58	21.31
15	36	0		20.44	20.34	20.24
15	36	20		20.40	20.14	20.20
15	36	39		20.39	20.45	20.09
15	75	0		20.45	20.39	20.20
15	1	0	64-QAM	20.51	20.34	20.26
15	1	37		20.52	20.23	20.24
15	1	74		20.38	20.52	20.17
15	36	0		19.36	19.48	19.30
15	36	20		19.41	19.22	19.21
15	36	39		19.23	19.29	19.01
15	75	0		19.41	19.42	19.01



LTE Band 41 Maximum Average Power [dBm]						
BW [MHz]	RB Size	RB Offset	Mod	Lowest	Middle	Highest
10	1	0	QPSK	22.34	22.26	22.28
10	1	25		22.32	22.03	22.23
10	1	49		22.31	22.23	22.27
10	25	0		21.25	21.17	21.19
10	25	12		21.29	21.08	21.09
10	25	25		21.22	21.30	21.15
10	50	0		21.38	21.16	21.08
10	1	0	16-QAM	21.50	21.66	21.40
10	1	25		21.49	21.21	21.32
10	1	49		21.36	21.24	21.27
10	25	0		20.30	20.19	20.21
10	25	12		20.40	20.14	20.17
10	25	25		20.38	20.11	20.09
10	50	0		20.43	20.28	20.16
10	1	0	64-QAM	20.50	20.33	20.23
10	1	25		20.46	20.31	20.28
10	1	49		20.49	20.32	20.20
10	25	0		19.47	19.37	19.31
10	25	12		19.34	19.21	19.21
10	25	25		19.23	19.19	19.07
10	50	0		19.46	19.38	19.12
5	1	0	QPSK	22.42	22.02	22.23
5	1	12		22.41	22.08	22.17
5	1	24		22.27	22.09	22.25
5	12	0		21.29	21.06	21.16
5	12	7		21.30	21.06	21.15
5	12	13		21.25	21.04	21.15
5	25	0		21.34	21.06	21.07
5	1	0	16-QAM	21.44	21.24	21.31
5	1	12		21.42	21.34	21.34
5	1	24		21.30	21.11	21.35
5	12	0		20.35	20.07	20.13
5	12	7		20.37	20.06	20.19
5	12	13		20.33	20.09	20.12
5	25	0		20.44	20.02	20.15
5	1	0	64-QAM	20.47	20.42	20.38
5	1	12		20.52	20.19	20.36
5	1	24		20.38	20.43	20.15
5	12	0		19.27	19.44	19.29
5	12	7		19.38	19.21	19.19
5	12	13		19.35	19.17	19.08
5	25	0		19.39	19.34	19.08



LTE Band 66 Maximum Average Power [dBm]						
BW [MHz]	RB Size	RB Offset	Mod	Lowest	Middle	Highest
20	1	0	QPSK	22.50	22.76	22.64
20	1	49		22.33	22.54	22.44
20	1	99		22.31	22.37	22.24
20	50	0		21.45	21.60	21.58
20	50	24		21.40	21.54	21.50
20	50	50		21.37	21.52	21.36
20	100	0		21.41	21.53	21.52
20	1	0	16-QAM	21.79	21.93	21.95
20	1	49		21.64	21.79	21.70
20	1	99		21.59	21.65	21.51
20	50	0		20.50	20.64	20.59
20	50	24		20.42	20.58	20.52
20	50	50		20.39	20.48	20.37
20	100	0		20.41	20.57	20.51
20	1	0	64-QAM	21.41	21.24	21.23
20	1	49		21.16	20.96	20.75
20	1	99		21.14	20.74	20.87
20	50	0		20.34	20.08	20.12
20	50	24		20.34	20.19	19.87
20	50	50		20.21	19.95	19.84
20	100	0		20.30	19.98	19.98
15	1	0	QPSK	22.45	22.69	22.58
15	1	37		22.30	22.54	22.21
15	1	74		22.32	22.44	22.19
15	36	0		21.44	21.69	21.45
15	36	20		21.41	21.66	21.34
15	36	39		21.33	21.45	21.27
15	75	0		21.40	21.54	21.33
15	1	0	16-QAM	21.73	21.88	21.77
15	1	37		21.60	21.76	21.47
15	1	74		21.59	21.64	21.44
15	36	0		20.44	20.59	20.49
15	36	20		20.42	20.53	20.33
15	36	39		20.33	20.50	20.26
15	75	0		20.38	20.52	20.33
15	1	0	64-QAM	21.38	21.10	21.04
15	1	37		21.01	20.77	20.88
15	1	74		20.94	20.98	20.56
15	36	0		20.23	20.10	19.89
15	36	20		20.28	19.94	19.85
15	36	39		19.95	20.06	19.86
15	75	0		20.05	19.93	19.94



LTE Band 66 Maximum Average Power [dBm]						
BW [MHz]	RB Size	RB Offset	Mod	Lowest	Middle	Highest
10	1	0	QPSK	22.41	22.65	22.54
10	1	25		22.31	22.56	22.33
10	1	49		22.27	22.46	22.29
10	25	0		21.37	21.53	21.45
10	25	12		21.34	21.50	21.39
10	25	25		21.34	21.49	21.37
10	50	0		21.34	21.48	21.41
10	1	0	16-QAM	21.66	21.81	21.80
10	1	25		21.60	21.75	21.55
10	1	49		21.58	21.73	21.54
10	25	0		20.38	20.54	20.43
10	25	12		20.38	20.53	20.39
10	25	25		20.35	20.46	20.35
10	50	0		20.37	20.53	20.40
10	1	0	64-QAM	21.15	20.89	21.05
10	1	25		21.13	20.84	21.02
10	1	49		21.10	20.86	21.01
10	25	0		20.19	19.91	20.06
10	25	12		20.16	19.92	20.02
10	25	25		20.20	19.97	19.95
10	50	0		20.14	19.91	20.15
5	1	0	QPSK	22.36	22.59	22.42
5	1	12		22.29	22.44	22.35
5	1	24		22.31	22.44	22.32
5	12	0		21.36	21.51	21.39
5	12	7		21.37	21.49	21.38
5	12	13		21.32	21.46	21.35
5	25	0		21.36	21.51	21.40
5	1	0	16-QAM	21.65	21.79	21.63
5	1	12		21.58	21.75	21.59
5	1	24		21.59	21.77	21.56
5	12	0		20.37	20.51	20.43
5	12	7		20.39	20.56	20.42
5	12	13		20.35	20.47	20.38
5	25	0		20.35	20.50	20.38
5	1	0	64-QAM	21.14	21.10	20.87
5	1	12		21.11	20.86	20.74
5	1	24		21.04	20.82	20.77
5	12	0		20.09	19.83	19.84
5	12	7		20.08	19.81	19.82
5	12	13		20.02	19.93	19.85
5	25	0		20.16	20.06	19.87



LTE Band 66 Maximum Average Power [dBm]						
BW [MHz]	RB Size	RB Offset	Mod	Lowest	Middle	Highest
3	1	0	QPSK	22.31	22.56	22.42
3	1	8		22.28	22.53	22.32
3	1	14		22.26	22.53	22.35
3	8	0		21.29	21.56	21.44
3	8	4		21.33	21.61	21.38
3	8	7		21.30	21.55	21.38
3	15	0		21.30	21.55	21.33
3	1	0	16-QAM	21.59	21.76	21.37
3	1	8		21.58	21.80	21.33
3	1	14		21.55	21.70	21.36
3	8	0		20.38	20.54	20.28
3	8	4		20.39	20.56	20.34
3	8	7		20.35	20.61	20.22
3	15	0		20.31	20.50	20.25
3	1	0	64-QAM	21.04	21.03	20.77
3	1	8		21.05	20.90	20.65
3	1	14		21.08	20.90	20.65
3	8	0		19.98	19.93	19.83
3	8	4		20.02	19.93	19.88
3	8	7		20.02	19.97	19.74
3	15	0		20.18	19.94	19.72
1.4	1	0	QPSK	22.23	22.34	22.27
1.4	1	3		22.24	22.57	22.29
1.4	1	5		22.18	22.48	22.36
1.4	3	0		22.28	22.49	22.26
1.4	3	1		22.33	22.63	22.38
1.4	3	3		22.27	22.48	22.37
1.4	6	0		21.24	21.57	21.38
1.4	1	0	16-QAM	21.31	21.61	21.42
1.4	1	3		21.48	21.71	21.35
1.4	1	5		21.22	21.43	21.25
1.4	3	0		21.17	21.39	21.34
1.4	3	1		21.11	21.43	21.28
1.4	3	3		21.17	21.39	21.38
1.4	6	0		20.27	20.53	20.42
1.4	1	0	64-QAM	20.99	20.79	20.87
1.4	1	3		20.95	21.10	20.69
1.4	1	5		20.92	20.94	20.71
1.4	3	0		21.12	20.92	20.91
1.4	3	1		21.09	20.87	20.89
1.4	3	3		21.16	20.97	20.82
1.4	6	0		20.11	19.89	19.68



LTE Band 2

Peak-to-Average Ratio

Mode	LTE Band 2 / 20MHz				
Mod.	QPSK		16QAM		Limit: 13dB
RB Size	1RB	Full RB	1RB	Full RB	Result
Lowest CH	4.58	4.93	5.19	5.77	PASS
Middle CH	4.58	5.19	5.3	6.14	
Highest CH	4.06	5.04	4.75	5.91	
Mod.	-		64QAM		Limit: 13dB
RB Size	1RB	Full RB	1RB	Full RB	Result
Lowest CH	-	-	5.1	5.91	PASS
Middle CH	-	-	5.25	6.12	
Highest CH	-	-	4.7	6.2	



LTE Band 2 / 20MHz / QPSK

Lowest Channel / 1RB

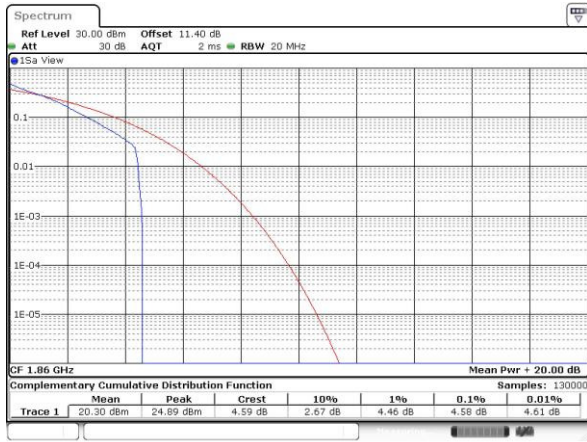

Date: 5 APR 2017 21:17:51

Lowest Channel / Full RB

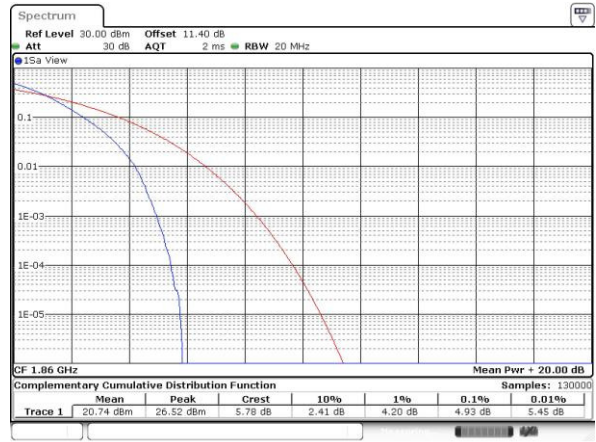

Date: 5 APR 2017 21:18:01

Middle Channel / 1RB

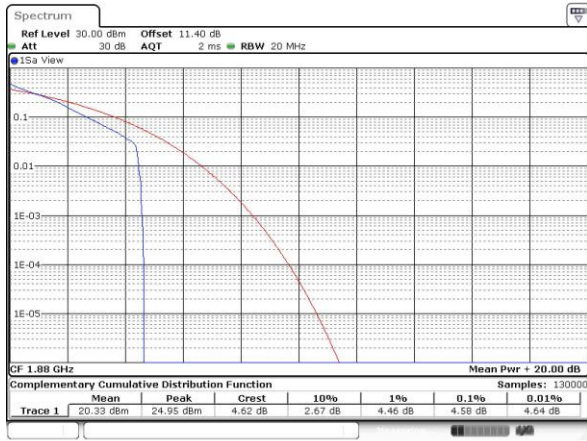

Date: 5 APR 2017 21:19:59

Middle Channel / Full RB

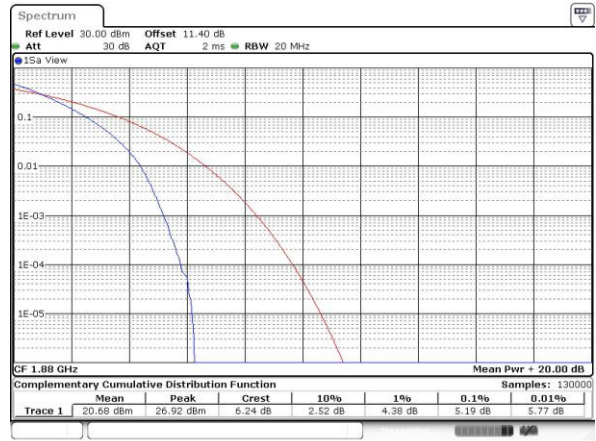

Date: 5 APR 2017 21:20:28

Highest Channel / 1RB



Date: 5 APR 2017 21:22:05

Highest Channel / Full RB



Date: 5 APR 2017 21:22:15



LTE Band 2 / 20MHz / 16QAM

Lowest Channel / 1RB

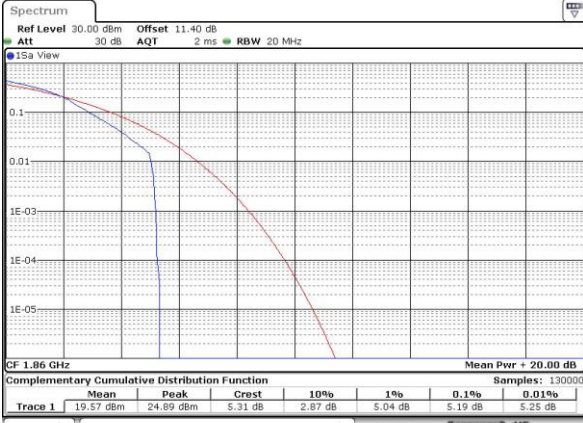

Date: 5 APR 2017 21:16:06

Lowest Channel / Full RB

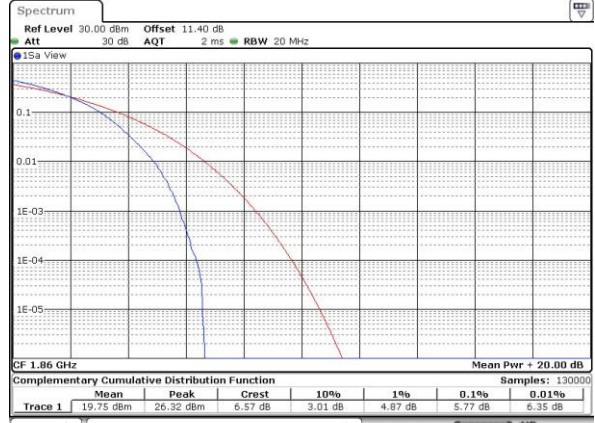

Date: 5 APR 2017 21:16:18

Middle Channel / 1RB



Date: 5 APR 2017 21:16:34

Middle Channel / Full RB

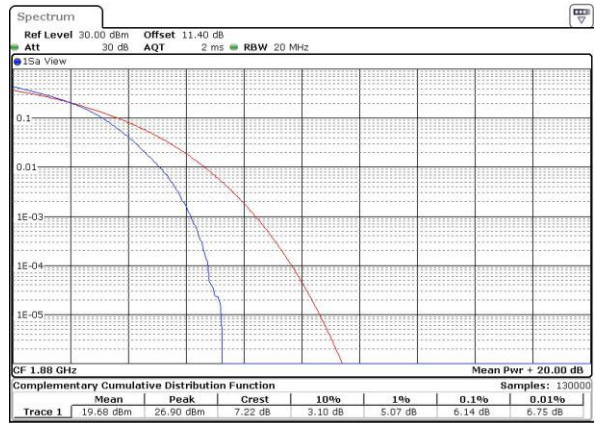

Date: 5 APR 2017 21:16:57

Highest Channel / 1RB



Date: 5 APR 2017 21:17:27

Highest Channel / Full RB

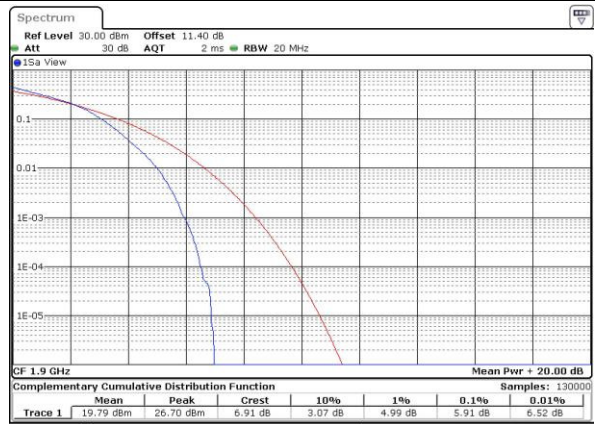

Date: 5 APR 2017 21:17:41



LTE Band 2 / 20MHz / 64QAM

Lowest Channel / 1RB

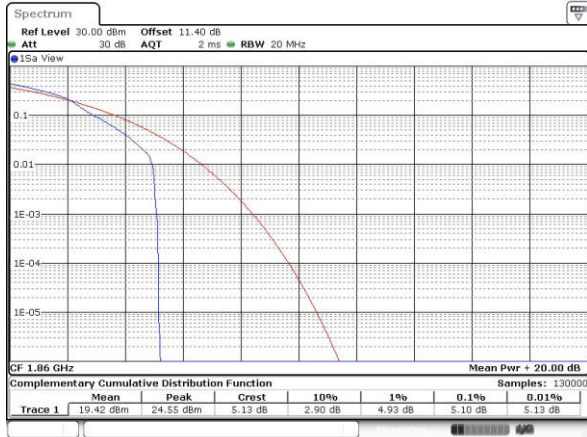

Date: 27 APR 2017 13:44:24

Lowest Channel / Full RB

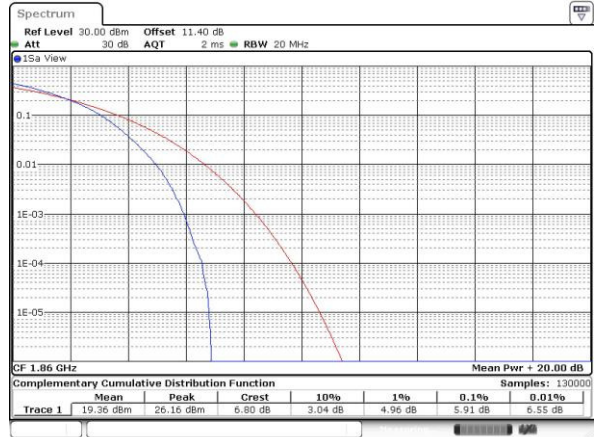

Date: 27 APR 2017 13:44:43

Middle Channel / 1RB

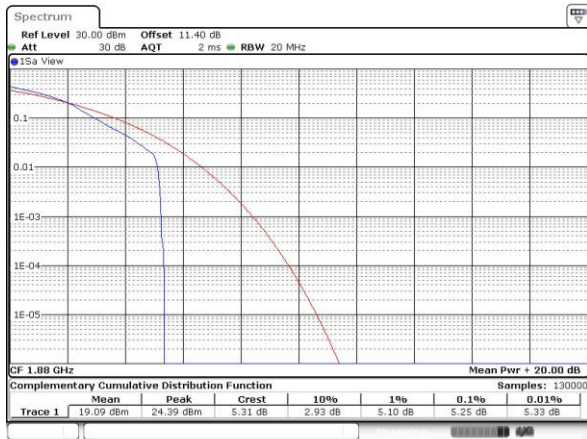

Date: 27 APR 2017 13:45:15

Middle Channel / Full RB

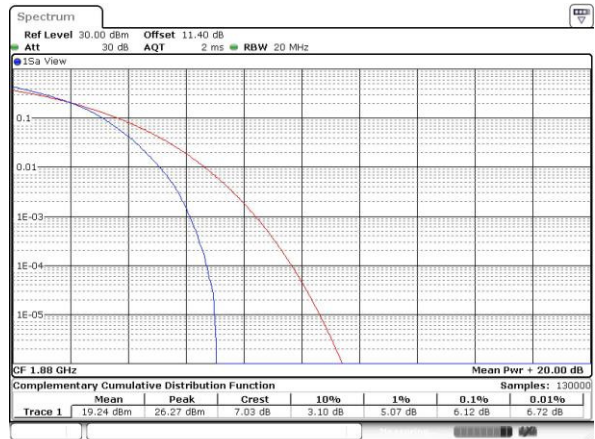

Date: 27 APR 2017 13:45:30

Highest Channel / 1RB



Date: 27 APR 2017 13:45:40

Highest Channel / Full RB



Date: 27 APR 2017 13:45:50



26dB Bandwidth

Mode	LTE Band 2 : 26dB BW(MHz)											
BW	1.4MHz		3MHz		5MHz		10MHz		15MHz		20MHz	
Mod.	QPSK	16QAM	QPSK	16QAM	QPSK	16QAM	QPSK	16QAM	QPSK	16QAM	QPSK	16QAM
Lowest CH	1.24	1.23	3.04	3.04	4.87	4.85	9.77	9.77	14.39	14.42	20.06	20.10
Middle CH	1.23	1.23	3.03	3.05	4.90	4.92	9.73	9.81	14.24	14.21	20.18	20.14
Highest CH	1.24	1.23	3.02	3.05	4.92	4.86	9.71	9.77	14.60	14.60	20.30	20.22
BW	1.4MHz		3MHz		5MHz		10MHz		15MHz		20MHz	
Mod.	-	64QAM	-	64QAM	-	64QAM	-	64QAM	-	64QAM	-	64QAM
Lowest CH	-	1.22	-	3.06	-	4.94	-	9.61	-	14.39	-	20.18
Middle CH	-	1.23	-	2.97	-	4.89	-	9.87	-	14.51	-	20.26
Highest CH	-	1.23	-	3.03	-	4.79	-	9.69	-	14.18	-	20.18



LTE Band 2

Lowest Channel / 1.4MHz / QPSK

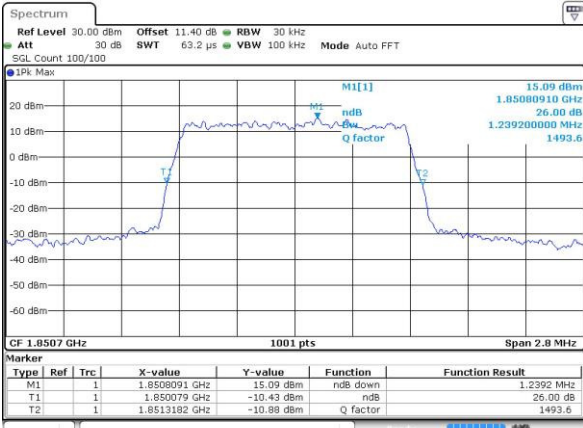

Date: 5 APR 2017 20:58:31

Lowest Channel / 1.4MHz / 16QAM

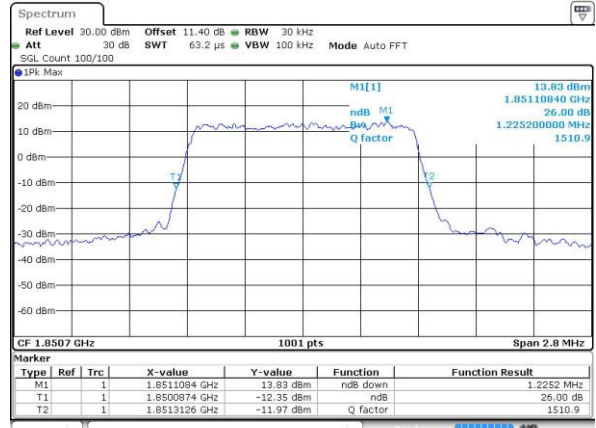

Date: 5 APR 2017 20:58:42

Middle Channel / 1.4MHz / QPSK

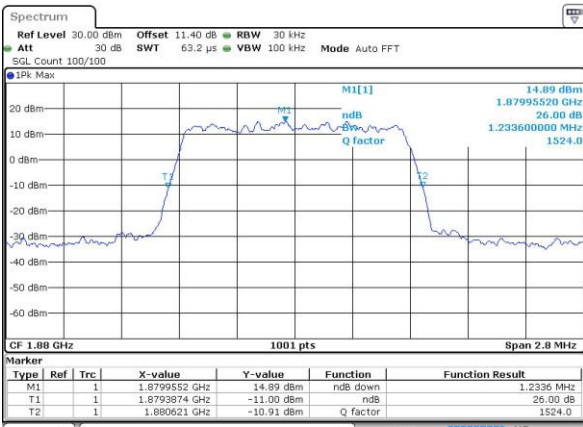

Date: 5 APR 2017 21:05:39

Middle Channel / 1.4MHz / 16QAM

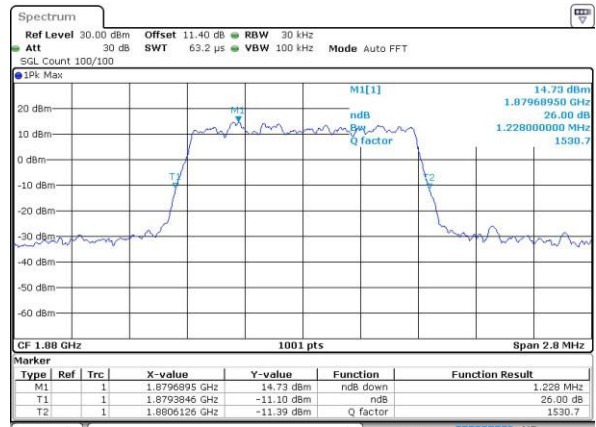

Date: 5 APR 2017 21:05:45

Highest Channel / 1.4MHz / QPSK

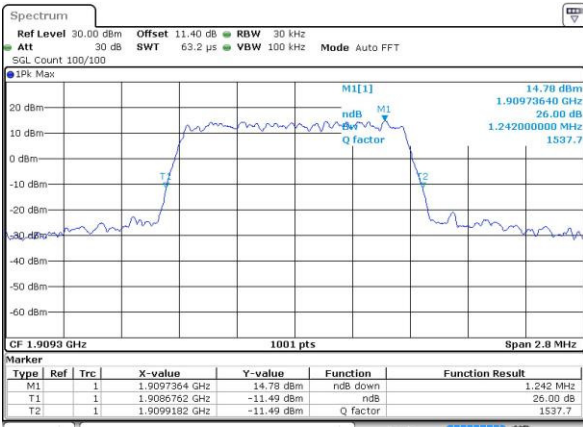

Date: 5 APR 2017 21:08:10

Highest Channel / 1.4MHz / 16QAM

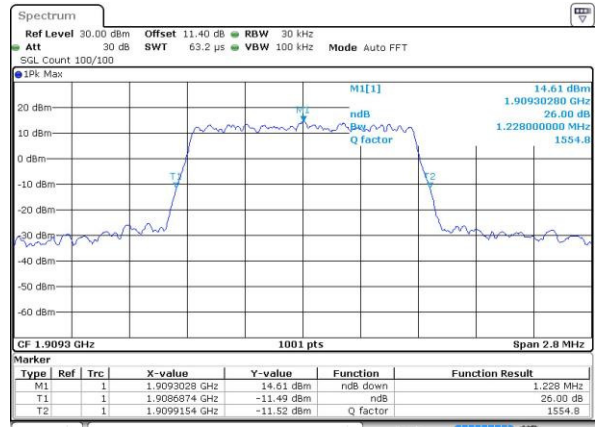

Date: 5 APR 2017 21:08:20



LTE Band 2

Lowest Channel / 3MHz / QPSK

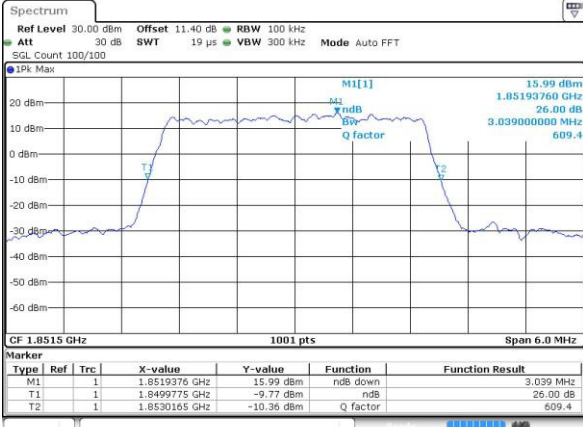

Date: 5 APR 2017 19:10:28

Lowest Channel / 3MHz / 16QAM

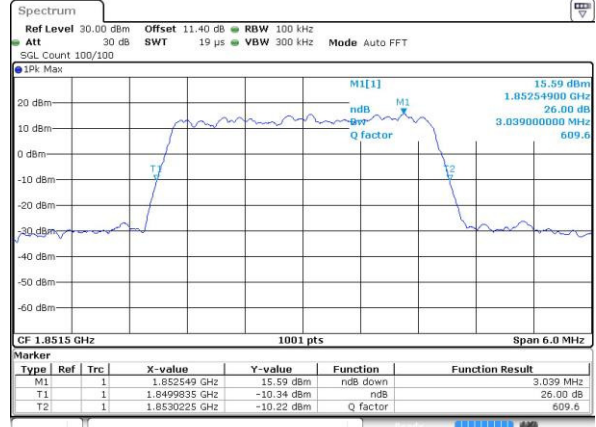

Date: 5 APR 2017 19:10:39

Middle Channel / 3MHz / QPSK



Date: 5 APR 2017 19:17:36

Middle Channel / 3MHz / 16QAM

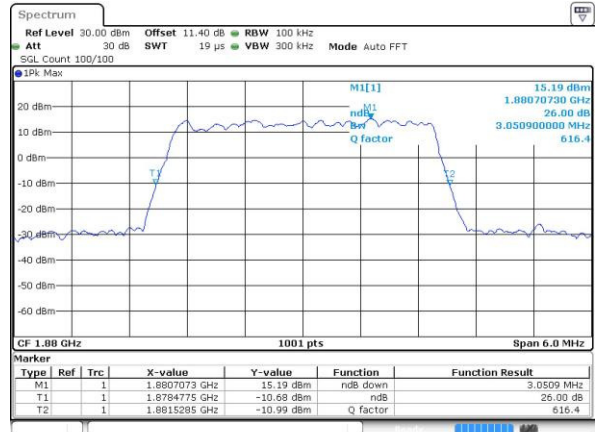

Date: 5 APR 2017 19:17:47

Highest Channel / 3MHz / QPSK

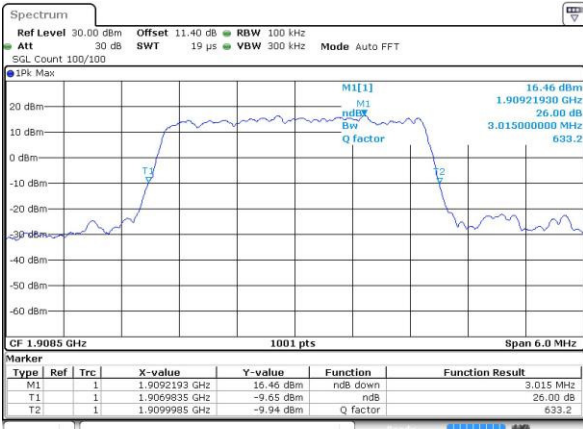

Date: 5 APR 2017 19:20:07

Highest Channel / 3MHz / 16QAM

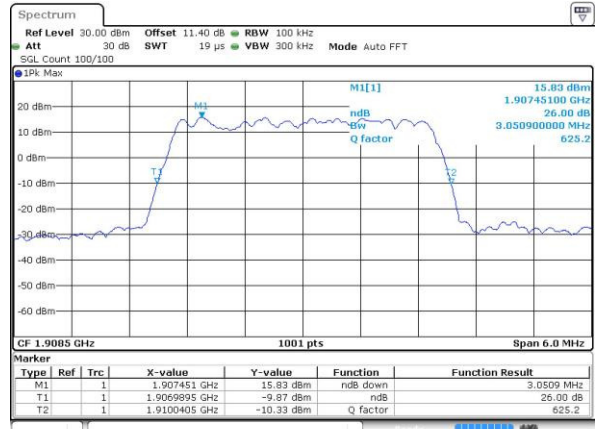

Date: 5 APR 2017 19:20:17



LTE Band 2

Lowest Channel / 5MHz / QPSK

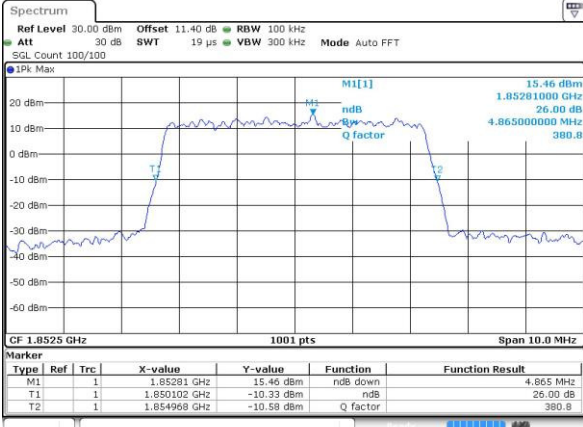

Date: 5 APR 2017 19:27:14

Lowest Channel / 5MHz / 16QAM

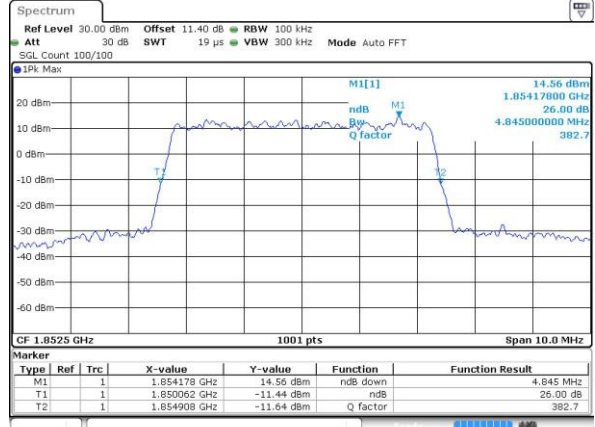

Date: 5 APR 2017 19:27:24

Middle Channel / 5MHz / QPSK

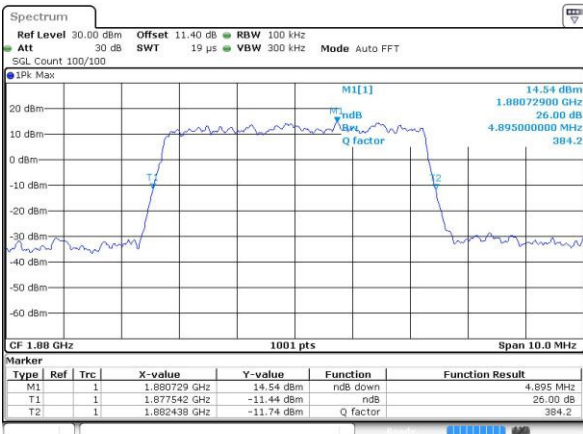

Date: 5 APR 2017 19:34:21

Middle Channel / 5MHz / 16QAM

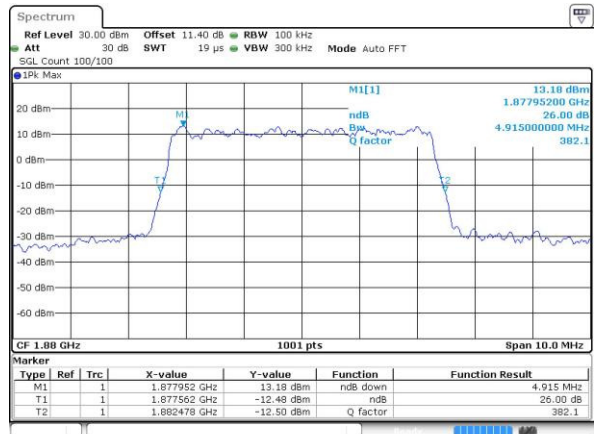

Date: 5 APR 2017 19:34:31

Highest Channel / 5MHz / QPSK

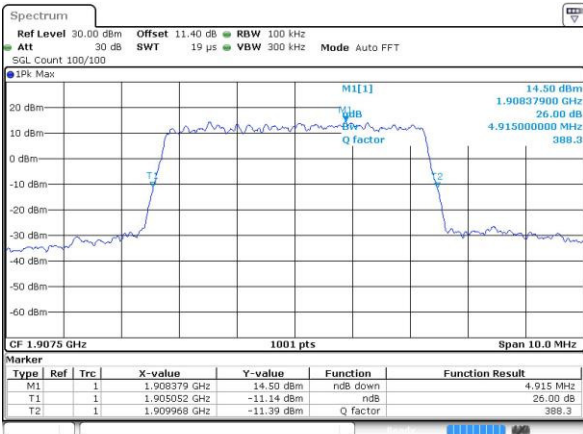

Date: 5 APR 2017 19:36:52

Highest Channel / 5MHz / 16QAM

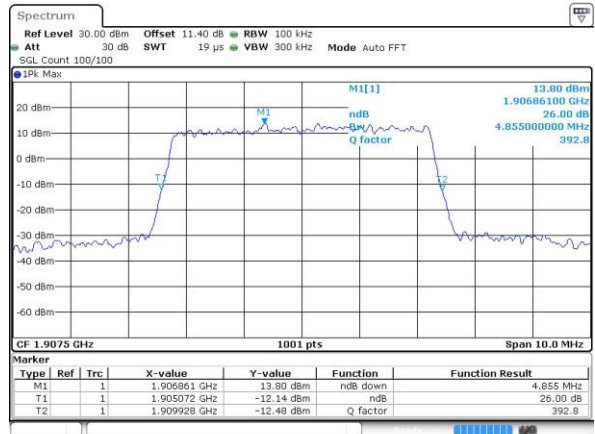

Date: 5 APR 2017 19:37:02



LTE Band 2

Lowest Channel / 10MHz / QPSK

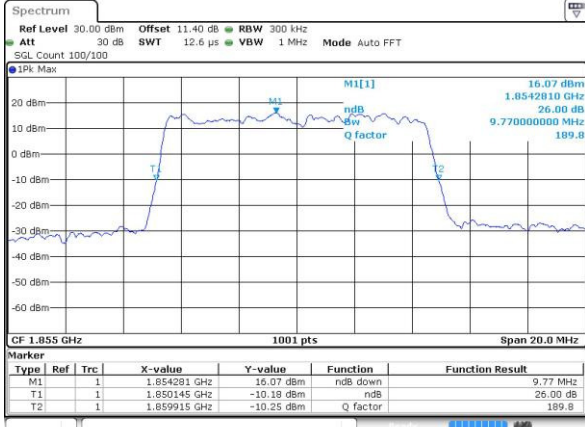

Date: 5 APR 2017 19:43:59

Lowest Channel / 10MHz / 16QAM

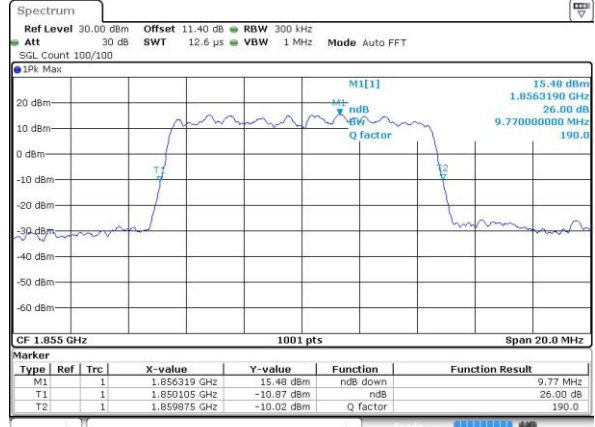

Date: 5 APR 2017 19:44:09

Middle Channel / 10MHz / QPSK

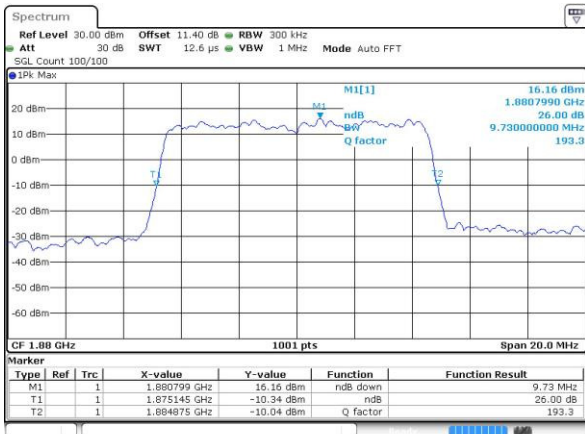

Date: 5 APR 2017 19:51:06

Middle Channel / 10MHz / 16QAM



Date: 5 APR 2017 19:51:16

Highest Channel / 10MHz / QPSK

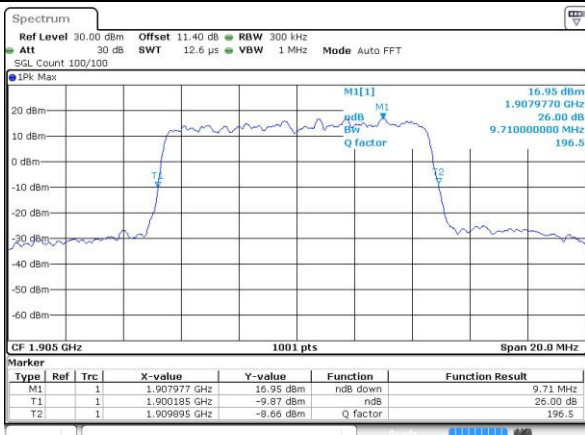

Date: 5 APR 2017 19:53:36

Highest Channel / 10MHz / 16QAM

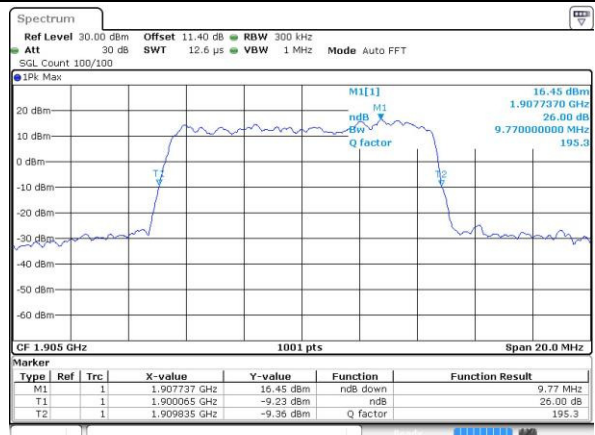

Date: 5 APR 2017 19:53:47



LTE Band 2

Lowest Channel / 15MHz / QPSK

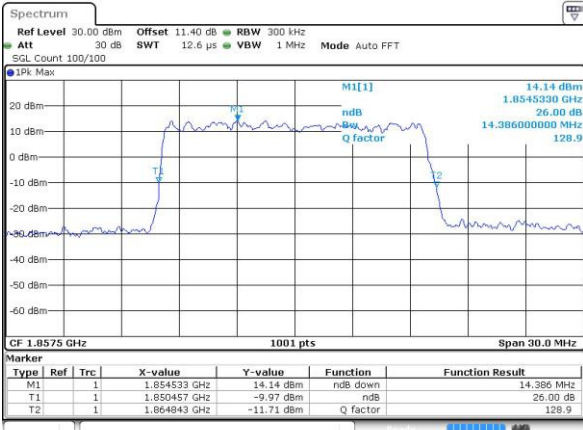

Date: 5 APR 2017 20:00:44

Lowest Channel / 15MHz / 16QAM

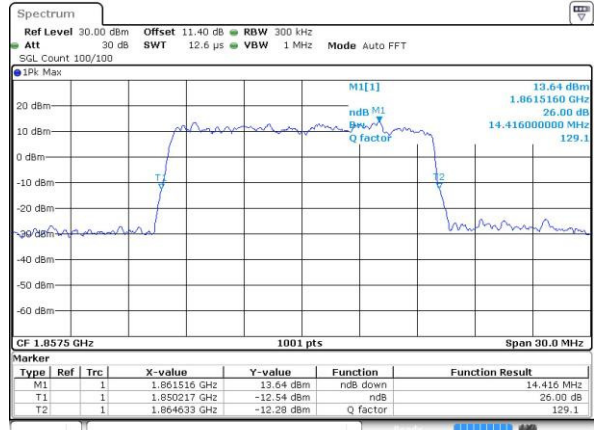

Date: 5 APR 2017 20:00:54

Middle Channel / 15MHz / QPSK

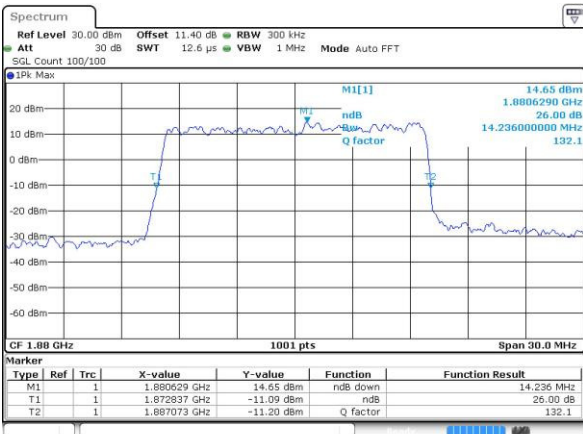

Date: 5 APR 2017 20:07:51

Middle Channel / 15MHz / 16QAM

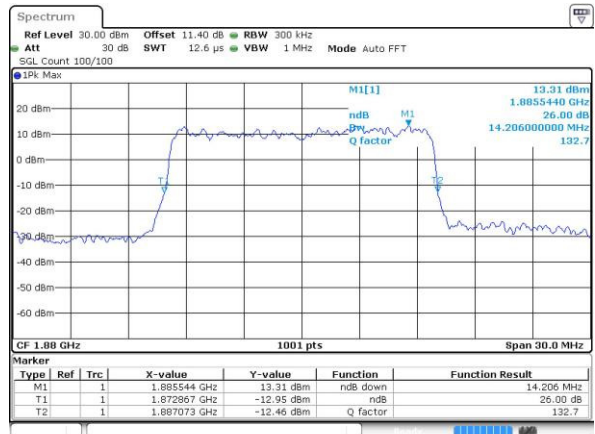

Date: 5 APR 2017 20:08:01

Highest Channel / 15MHz / QPSK

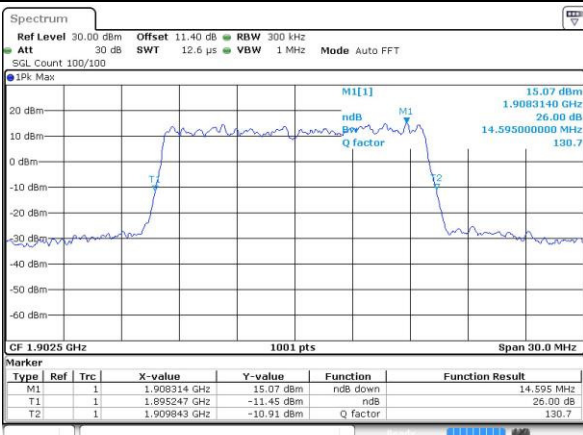

Date: 5 APR 2017 20:10:21

Highest Channel / 15MHz / 16QAM



Date: 5 APR 2017 20:10:31



LTE Band 2

Lowest Channel / 20MHz / QPSK

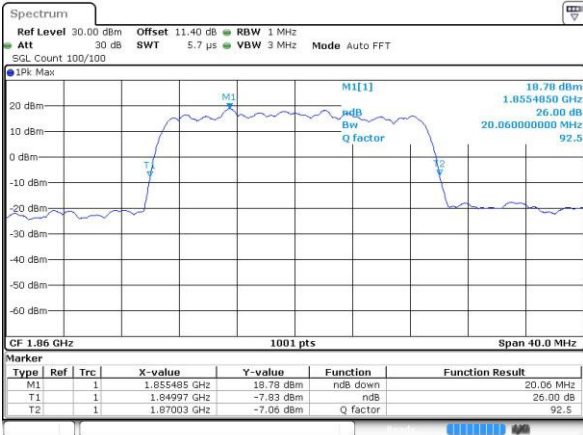

Date: 5 APR 2017 20:40:56

Lowest Channel / 20MHz / 16QAM

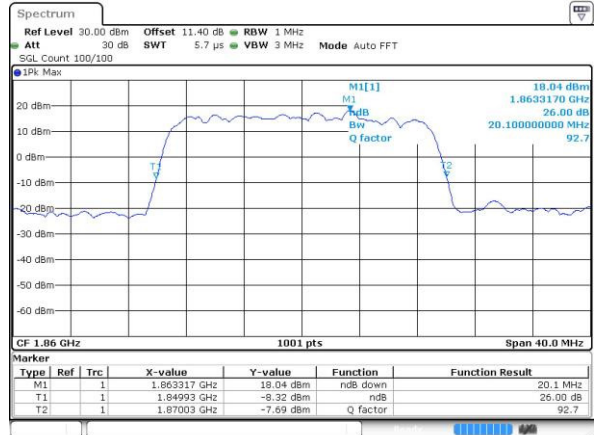

Date: 5 APR 2017 20:41:06

Middle Channel / 20MHz / QPSK

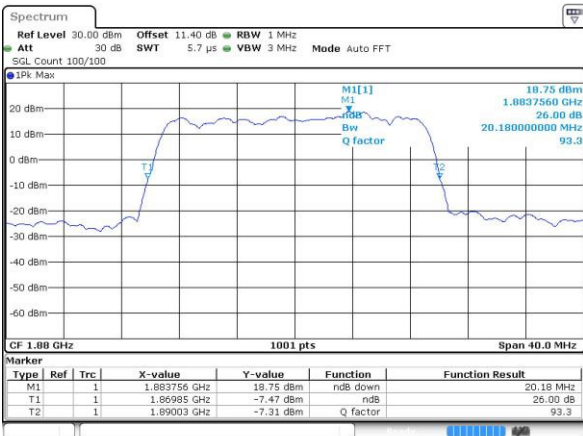

Date: 5 APR 2017 20:48:03

Middle Channel / 20MHz / 16QAM

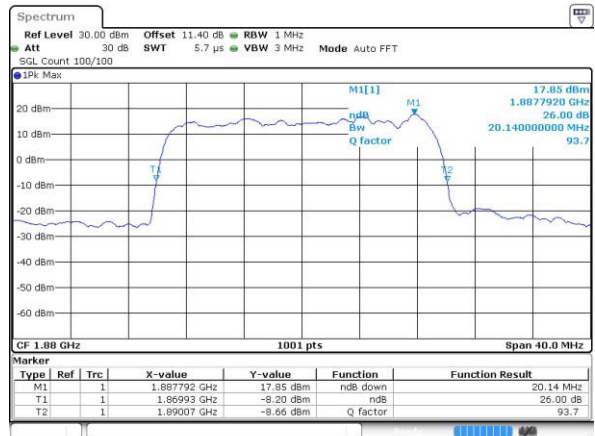

Date: 5 APR 2017 20:48:13

Highest Channel / 20MHz / QPSK

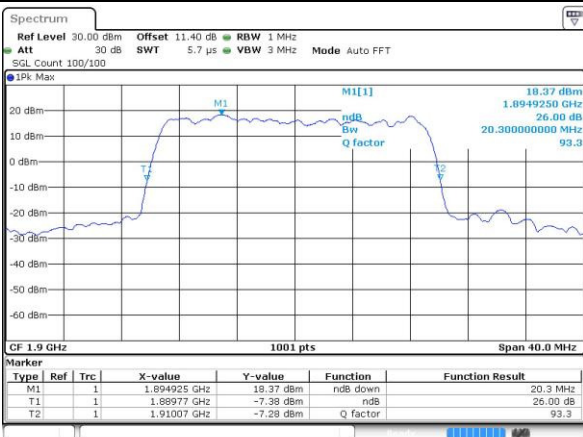

Date: 5 APR 2017 20:50:33

Highest Channel / 20MHz / 16QAM

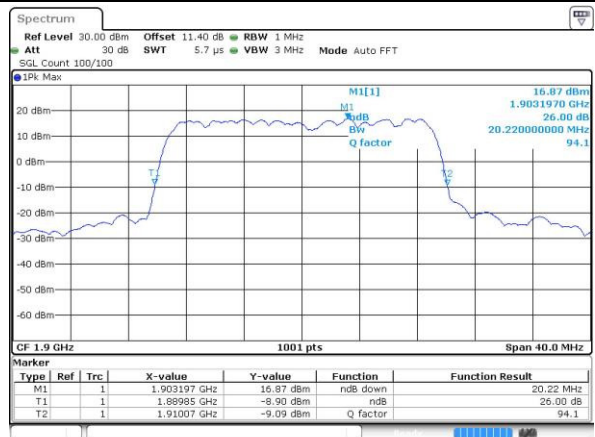

Date: 5 APR 2017 20:50:44



LTE Band 2

Lowest Channel / 1.4MHz / 64QAM

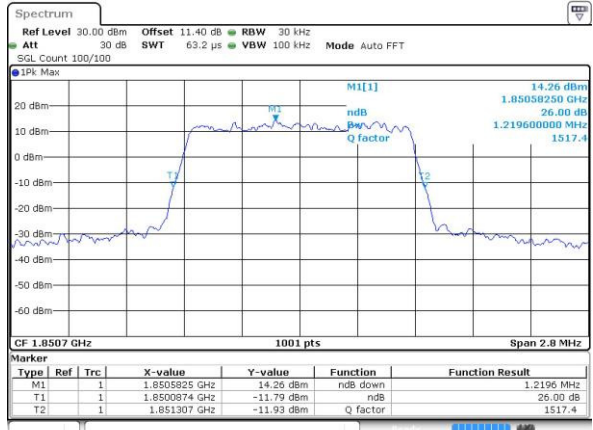

Date: 27 APR 2017 12:01:41

Middle Channel / 1.4MHz / 64QAM

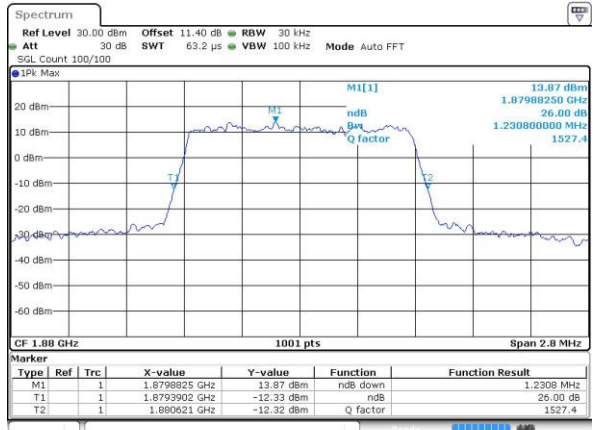

Date: 27 APR 2017 12:05:14

Highest Channel / 1.4MHz / 64QAM

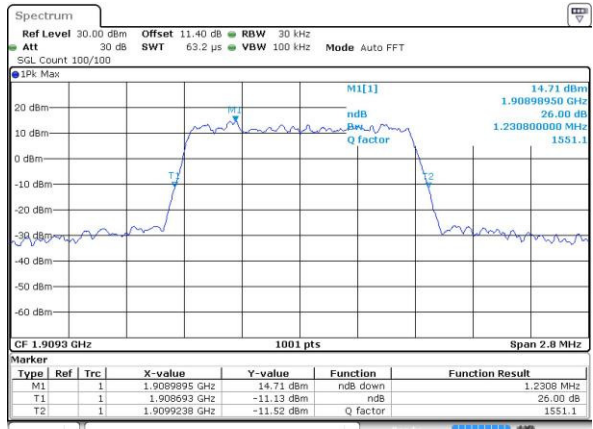

Date: 27 APR 2017 12:06:29



LTE Band 2

Lowest Channel / 3MHz / 64QAM

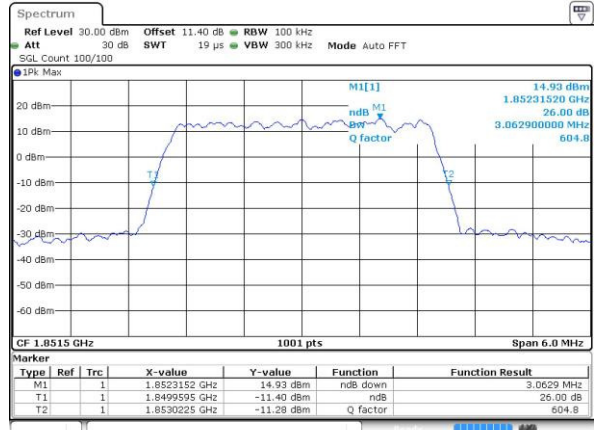

Date: 27 APR 2017 10:02:05

Middle Channel / 3MHz / 64QAM

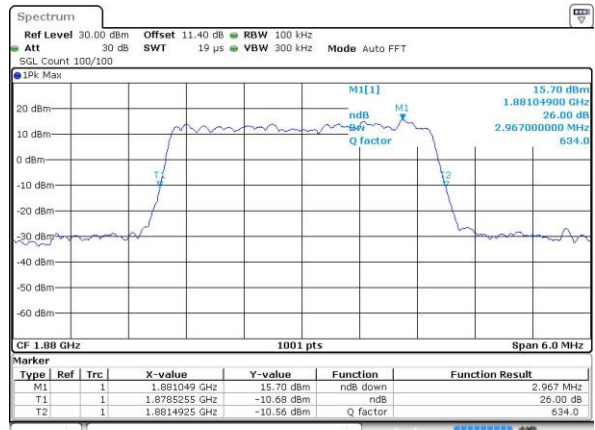

Date: 27 APR 2017 10:05:39

Highest Channel / 3MHz / 64QAM

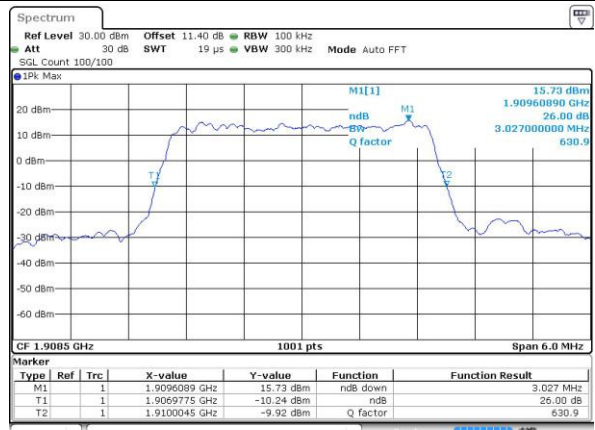

Date: 27 APR 2017 10:06:54



LTE Band 2

Lowest Channel / 5MHz / 64QAM

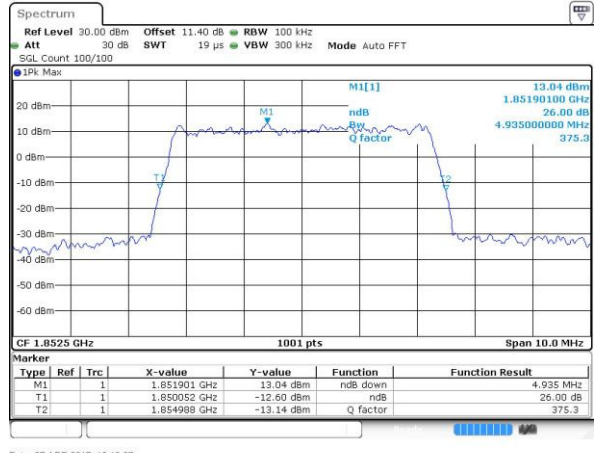

Date: 27 APR 2017 10:10:27

Middle Channel / 5MHz / 64QAM

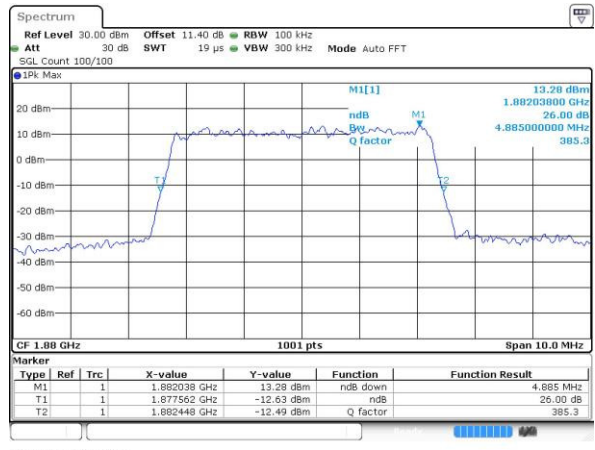

Date: 27 APR 2017 10:14:01

Highest Channel / 5MHz / 64QAM

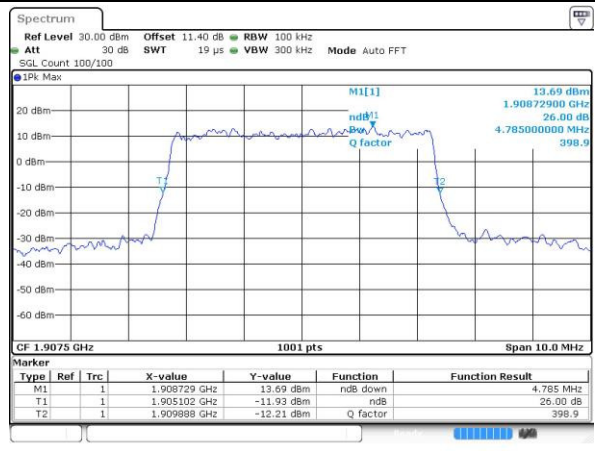

Date: 27 APR 2017 10:15:16



LTE Band 2

Lowest Channel / 10MHz / 64QAM

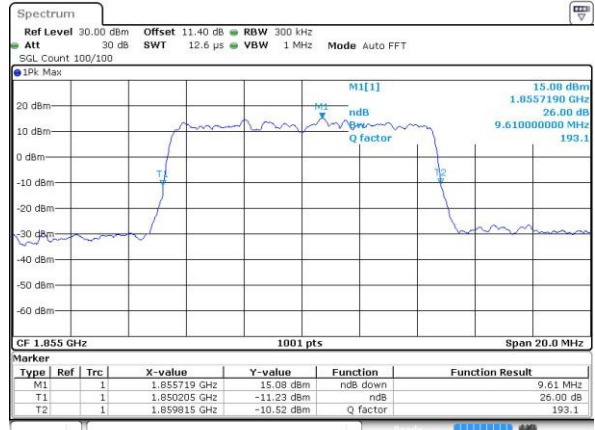

Date: 27 APR 2017 10:18:50

Middle Channel / 10MHz / 64QAM

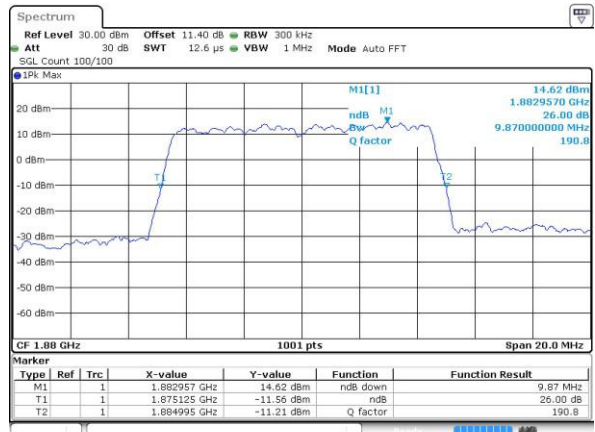

Date: 27 APR 2017 10:22:24

Highest Channel / 10MHz / 64QAM

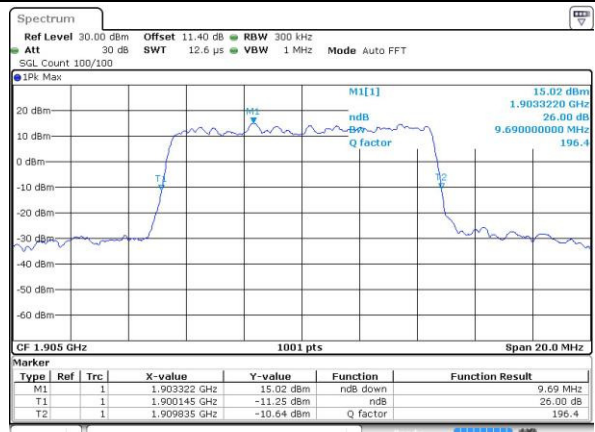

Date: 27 APR 2017 10:23:39



LTE Band 2

Lowest Channel / 15MHz / 64QAM

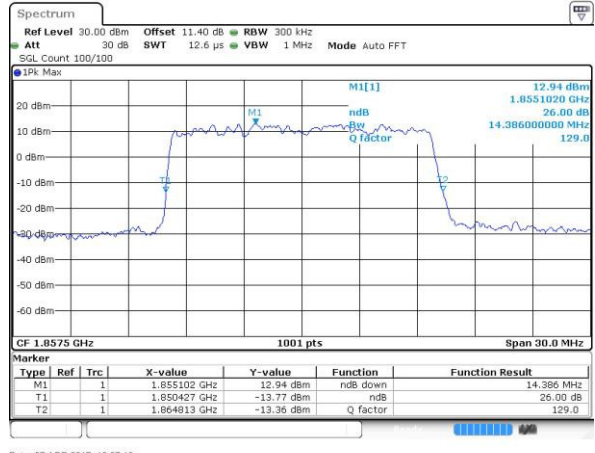

Date: 27 APR 2017 10:27:12

Middle Channel / 15MHz / 64QAM

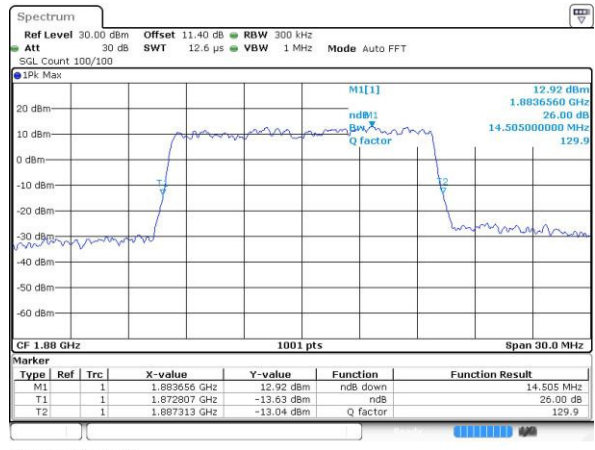

Date: 27 APR 2017 10:30:46

Highest Channel / 15MHz / 64QAM

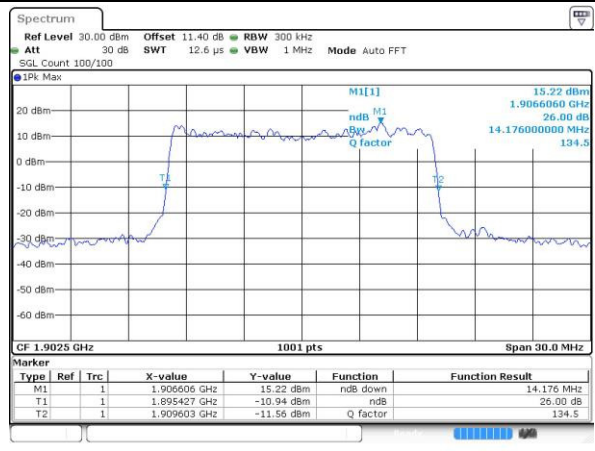

Date: 27 APR 2017 10:32:02



LTE Band 2

Lowest Channel / 20MHz / 64QAM

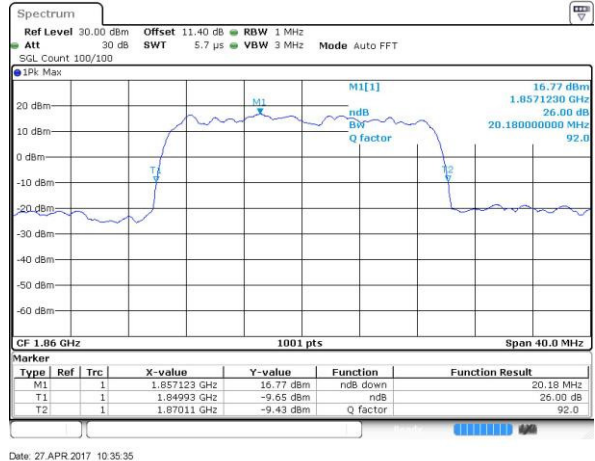

Date: 27 APR 2017 10:35:35

Middle Channel / 20MHz / 64QAM

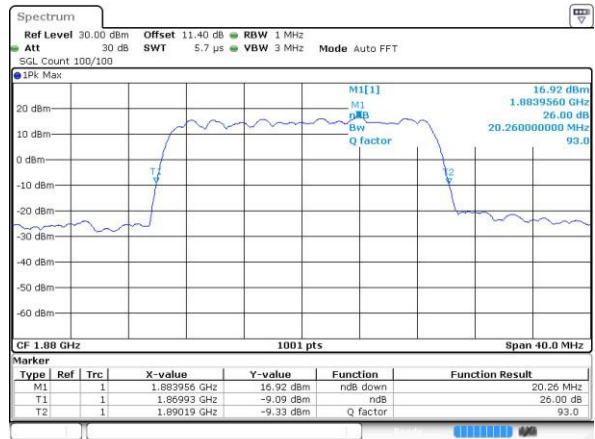

Date: 27 APR 2017 10:39:09

Highest Channel / 20MHz / 64QAM

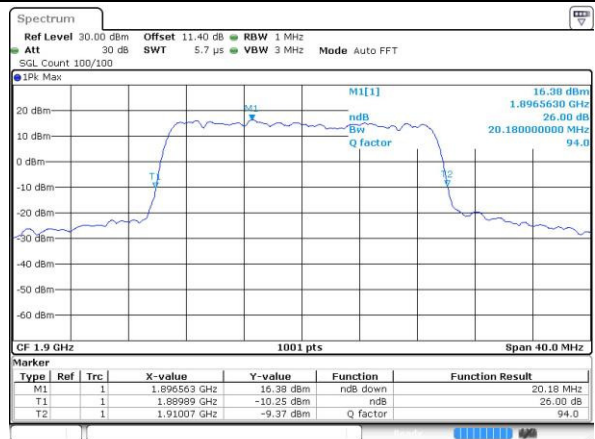

Date: 27 APR 2017 10:40:24



Occupied Bandwidth

Mode	LTE Band 2 : 99%OBW(MHz)											
BW	1.4MHz		3MHz		5MHz		10MHz		15MHz		20MHz	
Mod.	QPSK	16QAM	QPSK	16QAM	QPSK	16QAM	QPSK	16QAM	QPSK	16QAM	QPSK	16QAM
Lowest CH	1.09	1.09	2.71	2.71	4.49	4.49	8.97	9.05	13.46	13.43	18.42	18.3
Middle CH	1.1	1.09	2.74	2.71	4.5	4.49	9.09	9.01	13.46	13.4	18.46	18.42
Highest CH	1.09	1.1	2.7	2.73	4.48	4.49	9.05	9.03	13.49	13.46	18.62	18.34
BW	1.4MHz		3MHz		5MHz		10MHz		15MHz		20MHz	
Mod.	-	64QAM	-	64QAM	-	64QAM	-	64QAM	-	64QAM	-	64QAM
Lowest CH	-	1.09	-	2.72	-	4.48	-	8.99	-	13.4	-	18.26
Middle CH	-	1.1	-	2.7	-	4.51	-	9.01	-	13.4	-	18.3
Highest CH	-	1.09	-	2.71	-	4.5	-	9.09	-	13.49	-	18.42



LTE Band 2

Lowest Channel / 1.4MHz / QPSK

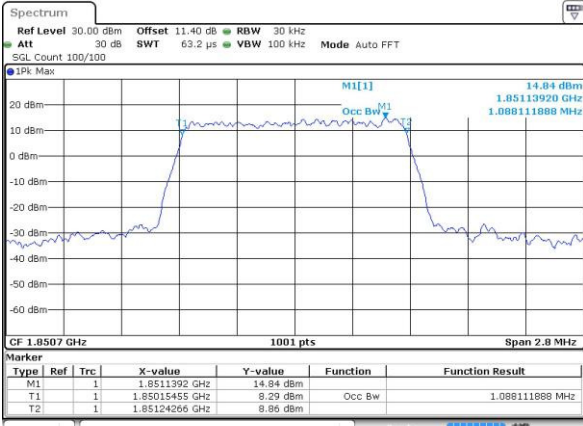

Date: 5 APR 2017 20:58:11

Lowest Channel / 1.4MHz / 16QAM

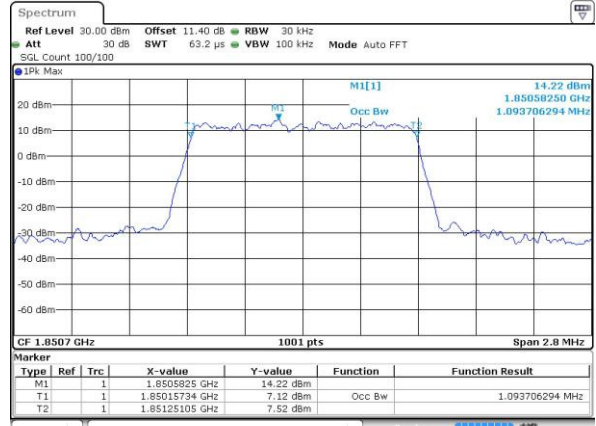

Date: 5 APR 2017 20:58:21

Middle Channel / 1.4MHz / QPSK

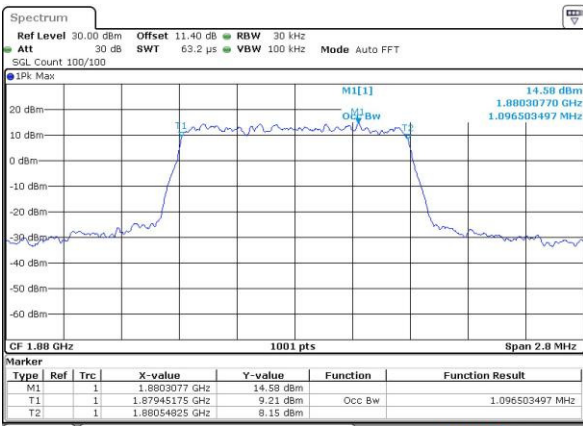

Date: 5 APR 2017 21:05:18

Middle Channel / 1.4MHz / 16QAM

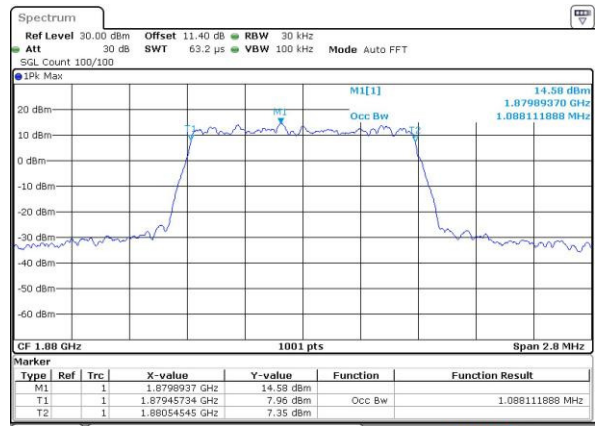

Date: 5 APR 2017 21:05:28

Highest Channel / 1.4MHz / QPSK

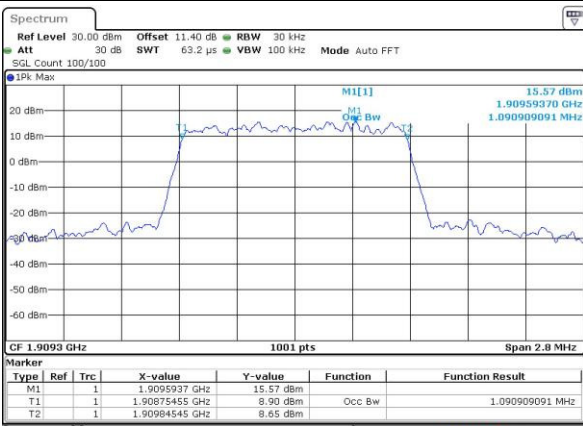

Date: 5 APR 2017 21:07:49

Highest Channel / 1.4MHz / 16QAM

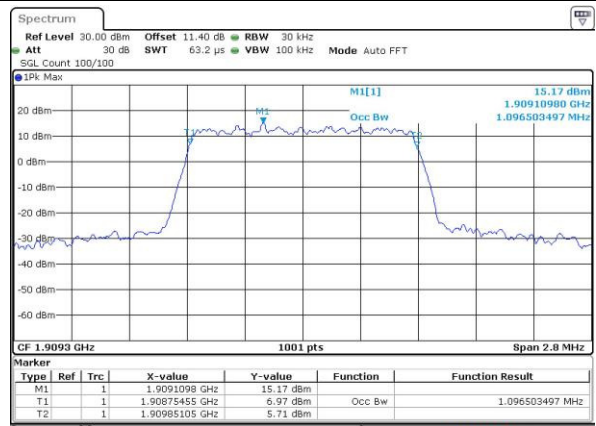

Date: 5 APR 2017 21:08:00