



FCC RF Test Report

APPLICANT : Motorola Mobility, LLC
EQUIPMENT : Mobile Cellular Phone
BRAND NAME : Motorola
MODEL NAME : 10722
FCC ID : IHDT56WB4
STANDARD : FCC Part 15 Subpart E §15.407
CLASSIFICATION : (NII) Unlicensed National Information Infrastructure

The product was received on Feb. 03, 2017 and testing was completed on Apr. 26, 2017. We, SPORTON INTERNATIONAL INC., would like to declare that the tested sample has been evaluated in accordance with the test procedures and has been in compliance with the applicable technical standards.

The test results in this report apply exclusively to the tested model / sample. Without written approval of SPORTON INTERNATIONAL INC., the test report shall not be reproduced except in full.

Reviewed by: Joseph Lin / Supervisor

Approved by: Jones Tsai / Manager



SPORTON INTERNATIONAL INC.

No. 52, Hwa Ya 1st Rd., Hwa Ya Technology Park, Kwei-Shan District, Tao Yuan City, Taiwan, R.O.C.

SPORTON INTERNATIONAL INC.

TEL : 886-3-327-3456

FAX : 886-3-328-4978

FCC ID : IHDT56WB4

Page Number : 1 of 41

Report Issued Date : May 04, 2017

Report Version : Rev. 01

Report Template No.: BU5-FR15EWL Version 1.0



TABLE OF CONTENTS

SUMMARY OF TEST RESULT 4

1 GENERAL DESCRIPTION 5

1.1 Applicant 5

1.2 Manufacturer 5

1.3 Product Feature of Equipment Under Test 5

1.4 Product Specification of Equipment Under Test 7

1.5 Modification of EUT 10

1.6 Testing Location 10

1.7 Applicable Standards 11

2 TEST CONFIGURATION OF EQUIPMENT UNDER TEST 12

2.1 Carrier Frequency Channel 12

2.2 Test Mode 14

2.3 Connection Diagram of Test System 17

2.4 Support Unit used in test configuration and system 18

2.5 EUT Operation Test Setup 18

2.6 Measurement Results Explanation Example 18

3 TEST RESULT 19

3.1 26dB & 99% Occupied Bandwidth Measurement 19

3.2 Maximum Conducted Output Power Measurement 21

3.3 Power Spectral Density Measurement 24

3.4 Unwanted Radiated Emission Measurement 27

3.5 AC Conducted Emission Measurement 33

3.6 Frequency Stability Measurement 37

3.7 Automatically Discontinue Transmission 38

3.8 Antenna Requirements 39

4 LIST OF MEASURING EQUIPMENTS 40

5 UNCERTAINTY OF EVALUATION 41

APPENDIX A. CONDUCTED TEST RESULTS

APPENDIX B. RADIATED SPURIOUS EMISSION

APPENDIX C. RADIATED SPURIOUS EMISSION PLOTS

APPENDIX D. DUTY CYCLE PLOTS



REVISION HISTORY

REPORT NO.	VERSION	DESCRIPTION	ISSUED DATE
FR7733129E	Rev. 01	Initial issue of report	May 04, 2017



SUMMARY OF TEST RESULT

Report Section	FCC Rule	Description	Limit	Result	Remark
3.1	2.1049 15.403(i)	26dB & 99% Bandwidth	-	Pass	-
3.2	15.407(a)	Maximum Conducted Output Power	≤ 24 dBm (depend on band)	Pass	-
3.3	15.407(a)	Power Spectral Density	≤ 11 dBm (depend on band)	Pass	-
3.4	15.407(b)	Unwanted Emissions	≤ -17, -27 dBm (depend on band)&15.209(a)	Pass	Under limit 0.27 dB at 5452.480 MHz
3.5	15.207	AC Conducted Emission	15.207(a)	Pass	Under limit 14.00 dB at 0.398 MHz
3.6	15.407(g)	Frequency Stability	Within Operation Band	Pass	-
3.7	15.407(c)	Automatically Discontinue Transmission	Discontinue Transmission	Pass	-
3.8	15.203 & 15.407(a)	Antenna Requirement	N/A	Pass	-



1 General Description

1.1 Applicant

Motorola Mobility, LLC

222 W Merchandise Mart Plaza, Suite 1800, Chicago, IL 60654, United States

1.2 Manufacturer

Motorola Mobility, LLC

222 W Merchandise Mart Plaza, Suite 1800, Chicago, IL 60654, United States

1.3 Product Feature of Equipment Under Test

Product Feature	
Equipment	Mobile Cellular Phone
Brand Name	Motorola
Model Name	10722
FCC ID	IHDT56WB4
IMEI Code	353311080000163 (for Radiation) 353311080000643 (for Conduction)
EUT supports Radios application	GSM/EGPRS/WCDMA/HSPA/LTE/NFC WLAN 11b/g/n HT20 WLAN 11a/n HT20/HT40 WLAN 11ac VHT20/VHT40/VHT80 Bluetooth BR/EDR/LE
HW Version	DVT2
EUT Stage	Identical Prototype

Remark: The above EUT's information was declared by manufacturer. Please refer to the specifications or user's manual for more detailed description.



Accessory List		
AC Adapter 1	Brand Name :	Motorola
	Model Name :	SPN5970A
AC Adapter 2	Brand Name :	Motorola
	Model Name :	SPN5993A
AC Adapter 3	Brand Name :	Motorola
	Model Name :	SPN5978A
Battery 1	Brand Name :	Motorola
	Model Name :	SNN5986A
Battery 2	Brand Name :	Motorola
	Model Name :	SNN5897A
Earphone	Brand Name :	Motorola
	Model Name :	SH38C16618
USB Cable	Brand Name :	Motorola
	Model Name :	SKN6473A
USB-C Data Cable	Brand Name :	Motorola
	Model Name :	SKN6474A



1.4 Product Specification of Equipment Under Test

Standards-related Product Specification	
Tx/Rx Frequency Range	5180 MHz ~ 5240 MHz 5260 MHz ~ 5320 MHz 5500 MHz ~ 5720 MHz
Maximum Output Power to Antenna	<p><Ant. 1> <5180 MHz ~ 5240 MHz> 802.11a : 18.16 dBm / 0.0655 W 802.11n HT20 : 18.15 dBm / 0.0653 W 802.11n HT40 : 17.40 dBm / 0.0550 W 802.11ac VHT20 : 18.19 dBm / 0.0659 W 802.11ac VHT40 : 17.41 dBm / 0.0551 W 802.11ac VHT80 : 15.13 dBm / 0.0326 W <5260 MHz ~ 5320 MHz> 802.11a : 18.26 dBm / 0.0670 W 802.11n HT20 : 18.24 dBm / 0.0667 W 802.11n HT40 : 17.28 dBm / 0.0535 W 802.11ac VHT20 : 18.25 dBm / 0.0668 W 802.11ac VHT40 : 17.29 dBm / 0.0536 W 802.11ac VHT80 : 13.80 dBm / 0.0240 W <5500 MHz ~ 5700 MHz > 802.11a : 18.29 dBm / 0.0675 W 802.11n HT20 : 18.32 dBm / 0.0679 W 802.11n HT40 : 17.60 dBm / 0.0575 W 802.11ac VHT20 : 18.34 dBm / 0.0682 W 802.11ac VHT40 : 17.61 dBm / 0.0577 W 802.11ac VHT80 : 18.13 dBm / 0.0650 W <Ant. 2> <5180 MHz ~ 5240 MHz> 802.11a : 18.10 dBm / 0.0646 W 802.11n HT20 : 18.02 dBm / 0.0634 W 802.11n HT40 : 17.13 dBm / 0.0516 W 802.11ac VHT20 : 18.04 dBm / 0.0637 W 802.11ac VHT40 : 17.31 dBm / 0.0538 W 802.11ac VHT80 : 15.62 dBm / 0.0365 W <5260 MHz ~ 5320 MHz> 802.11a : 18.13 dBm / 0.0650 W 802.11n HT20 : 18.05 dBm / 0.0638 W 802.11n HT40 : 17.05 dBm / 0.0507 W 802.11ac VHT20 : 18.14 dBm / 0.0652 W 802.11ac VHT40 : 17.13 dBm / 0.0516 W 802.11ac VHT80 : 14.02 dBm / 0.0252 W <5500 MHz ~ 5700 MHz > 802.11a : 18.21 dBm / 0.0662 W 802.11n HT20 : 18.17 dBm / 0.0656 W 802.11n HT40 : 17.47 dBm / 0.0558 W 802.11ac VHT20 : 18.29 dBm / 0.0675 W 802.11ac VHT40 : 17.48 dBm / 0.0560 W 802.11ac VHT80 : 18.00 dBm / 0.0631 W</p>



Standards-related Product Specification	
<p>Maximum Output Power to Antenna</p>	<p>MIMO <Ant. 1 + 2> <5180 MHz ~ 5240 MHz> 802.11a : 20.99 dBm / 0.1256 W 802.11n HT20 : 20.98 dBm / 0.1253 W 802.11n HT40 : 20.42 dBm / 0.1102 W 802.11ac VHT20 : 20.99 dBm / 0.1256 W 802.11ac VHT40 : 20.49 dBm / 0.1119 W 802.11ac VHT80 : 18.40 dBm / 0.0692 W <5260 MHz ~ 5320 MHz> 802.11a : 21.17 dBm / 0.1309 W 802.11n HT20 : 21.19 dBm / 0.1315 W 802.11n HT40 : 20.27 dBm / 0.1064 W 802.11ac VHT20 : 21.22 dBm / 0.1324 W 802.11ac VHT40 : 20.31 dBm / 0.1074 W 802.11ac VHT80 : 16.97 dBm / 0.0498 W <5500 MHz ~ 5700 MHz > 802.11a : 21.34 dBm / 0.1361 W 802.11n HT20 : 21.29 dBm / 0.1346 W 802.11n HT40 : 20.58 dBm / 0.1143 W 802.11ac VHT20 : 21.41 dBm / 0.1384 W 802.11ac VHT40 : 20.60 dBm / 0.1148 W 802.11ac VHT80 : 21.14 dBm / 0.1300 W</p>
<p>Maximum Output Power to Antenna for Straddle Channel</p>	<p><Ant. 1> 802.11a : 18.25 dBm / 0.0668 W 802.11n HT20 : 18.16 dBm / 0.0655 W 802.11n HT40 : 17.15 dBm / 0.0519 W 802.11ac VHT20 : 17.88 dBm / 0.0614 W 802.11ac VHT40 : 17.17 dBm / 0.0521 W 802.11ac VHT80 : 18.25 dBm / 0.0668 W <Ant. 2> 802.11a : 17.74 dBm / 0.0594 W 802.11n HT20 : 17.77 dBm / 0.0598 W 802.11n HT40 : 16.82 dBm / 0.0481 W 802.11ac VHT20 : 17.73 dBm / 0.0593 W 802.11ac VHT40 : 16.75 dBm / 0.0473 W 802.11ac VHT80 : 17.79 dBm / 0.0601 W MIMO <Ant. 1 + 2> 802.11a : 20.89 dBm / 0.1227 W 802.11n HT20 : 20.99 dBm / 0.1256 W 802.11n HT40 : 19.96 dBm / 0.0991 W 802.11ac VHT20 : 20.89 dBm / 0.1227 W 802.11ac VHT40 : 19.93 dBm / 0.0984 W 802.11ac VHT80 : 21.11 dBm / 0.1291 W</p>



Standards-related Product Specification	
99% Occupied Bandwidth	<p>MIMO <Ant. 1> 802.11a : 17.95 MHz 802.11n HT20 : 19.05 MHz 802.11n HT40 : 37.30 MHz 802.11ac VHT20 : 19.00 MHz 802.11ac VHT40 : 37.20 MHz 802.11ac VHT80 : 76.20 MHz</p> <p>MIMO <Ant. 2> 802.11a : 17.95 MHz 802.11n HT20 : 18.95 MHz 802.11n HT40 : 37.00 MHz 802.11ac VHT20 : 19.00 MHz 802.11ac VHT40 : 37.00 MHz 802.11ac VHT80 : 76.08 MHz</p>
99% Occupied Bandwidth for Straddle Channel	<p>MIMO <Ant. 1> 802.11a : 18.15 MHz 802.11n HT20 : 19.30 MHz 802.11n HT40 : 37.10 MHz 802.11ac VHT20 : 19.50 MHz 802.11ac VHT40 : 37.10 MHz 802.11ac VHT80 : 76.56 MHz</p> <p>MIMO <Ant. 2> 802.11a : 18.15 MHz 802.11n HT20 : 19.30 MHz 802.11n HT40 : 37.10 MHz 802.11ac VHT20 : 19.50 MHz 802.11ac VHT40 : 37.10 MHz 802.11ac VHT80 : 76.20 MHz</p>
Antenna Gain / Gain	<p><Ant. 1> <5150 MHz ~ 5250 MHz> Fixed Internal Antenna type with gain -3.70 dBi <5250 MHz ~ 5350 MHz> Fixed Internal Antenna type with gain -2.40 dBi <5470 MHz ~ 5725 MHz> Fixed Internal Antenna type with gain -2.40 dBi</p> <p><Ant. 2> <5150 MHz ~ 5250 MHz> Fixed Internal Antenna type with gain -3.30 dBi <5250 MHz ~ 5350 MHz> Fixed Internal Antenna type with gain -3.10 dBi <5470 MHz ~ 5725 MHz> Fixed Internal Antenna type with gain -3.50 dBi</p>



Standards-related Product Specification			
Type of Modulation	802.11a/n : OFDM (BPSK / QPSK / 16QAM / 64QAM) 802.11ac : OFDM (BPSK / QPSK / 16QAM / 64QAM / 256QAM)		
Antenna Function Description		Ant. 1	Ant. 2
	802.11 a/n/ac	V	V
	802.11 a/n/ac MIMO	V	V

Note: MIMO Ant. 1+2 is a calculated result from sum of the power MIMO Ant. 1 and MIMO Ant. 2.

1.5 Modification of EUT

No modifications are made to the EUT during all test items.

1.6 Testing Location

Sporton Lab is accredited to ISO 17025 by Taiwan Accreditation Foundation (TAF code : 1190) and the FCC designation No. TW0007 under the FCC 2.948(e) by Mutual Recognition Agreement (MRA) in FCC Test.

Test Site	SPORTON INTERNATIONAL INC.	
Test Site Location	No. 52, Hwa Ya 1 st Rd., Hwa Ya Technology Park, Kwei-Shan District, Tao Yuan City, Taiwan, R.O.C. TEL: +886-3-327-3456 FAX: +886-3-328-4978	
Test Site No.	Sporton Site No.	
	TH05-HY	CO05-HY

Note: The test site complies with ANSI C63.4 2014 requirement.

Test Site	SPORTON INTERNATIONAL INC.	
Test Site Location	No.58, Aly. 75, Ln. 564, Wenhua 3rd Rd. Guishan Dist, Taoyuan City, Taiwan (R.O.C.) TEL: +886-3-327-0868 FAX: +886-3-327-0855	
Test Site No.	Sporton Site No.	
	03CH11-HY	

Note: The test site complies with ANSI C63.4 2014 requirement.



1.7 Applicable Standards

According to the specifications of the manufacturer, the EUT must comply with the requirements of the following standards:

- ♦ FCC Part 15 Subpart E
- ♦ FCC KDB 789033 D02 General UNII Test Procedures New Rules v01r04
- ♦ FCC KDB 662911 D01 Multiple Transmitter Output v02r01.
- ♦ FCC KDB 644545 D03 Guidance for IEEE 802 11ac New Rules v01
- ♦ ANSI C63.10-2013

Remark:

1. All test items were verified and recorded according to the standards and without any deviation during the test.
2. This EUT has also been tested and complied with the requirements of FCC Part 15, Subpart B, recorded in a separate test report.



2 Test Configuration of Equipment Under Test

The EUT has been associated with peripherals and configuration operated in a manner tended to maximize its emission characteristics in a typical application. Frequency range investigated: conducted emission (150 kHz to 30 MHz) and radiated emission (9 kHz to the 10th harmonic of the highest fundamental frequency or to 40 GHz, whichever is lower). For radiated measurement, pre-scanned in three orthogonal panels, X, Y, Z. The worst cases (Z plane) were recorded in this report.

2.1 Carrier Frequency Channel

Frequency Band	Channel	Freq. (MHz)	Channel	Freq. (MHz)
5150-5250 MHz Band 1 (U-NII-1)	36	5180	44	5220
	38*	5190	46*	5230
	40	5200	48	5240
	42 [#]	5210		

Frequency Band	Channel	Freq. (MHz)	Channel	Freq. (MHz)
5250-5350 MHz Band 2 (U-NII-2A)	52	5260	60	5300
	54*	5270	62*	5310
	56	5280	64	5320
	58 [#]	5290		

Frequency Band	Channel	Freq. (MHz)	Channel	Freq. (MHz)
5470-5725 MHz Band 3 (U-NII-2C)	100	5500	112	5560
	102*	5510	116	5580
	104	5520	132	5660
	106 [#]	5530	134*	5670
	108	5540	136	5680
	110*	5550	140	5700



Frequency Band	Channel	Freq. (MHz)	Channel	Freq. (MHz)
TDWR Channel	118*	5590	124	5620
	120	5600	126*	5630
	122 [#]	5610	128	5640

Frequency Band	Channel	Freq. (MHz)	Channel	Freq. (MHz)
Straddle Channel	138 [#]	5690	144	5720
	142*	5710		

Note:

1. The above Frequency and Channel in "*" were 802.11n HT40 and 802.11ac VHT40.
2. The above Frequency and Channel in "[#]" were 802.11ac VHT80.



2.2 Test Mode

Final test mode of conducted test items and radiated spurious emissions are considering the modulation and worse data rates as below table.

Single Antenna

Modulation	Data Rate
802.11a	6 Mbps
802.11n HT20	MCS0
802.11n HT40	MCS0
802.11ac VHT20	MCS0
802.11ac VHT40	MCS0
802.11ac VHT80	MCS0

MIMO Antenna

Modulation	Data Rate
802.11a	6 Mbps
802.11n HT20	MCS0
802.11n HT40	MCS0
802.11ac VHT20	MCS0
802.11ac VHT40	MCS0
802.11ac VHT80	MCS0
802.11ac VHT80 + 802.11ac VHT80	MCS0 + MCS0

Co-Location

Modulation	Data Rate
2.4GHz 802.11n HT20 + 5GHz 802.11n HT40	MCS0 + MCS0

AC Conducted Emission	Mode 1 : GSM850 Idle + Bluetooth Link + WLAN (5GHz) Link + MP3 + Battery 2 + USB Cable (Charging from Adapter 3)
Remark: All the radiated test cases were performance with Adapter 1 and Battery 2.	



Ch. #		Band I : 5150-5250 MHz	Band II : 5250-5350 MHz	Band III : 5470-5725MHz
		802.11a	802.11a	802.11a
L	Low	36	52	100
M	Middle	44	60	116
H	High	48	64	140
Straddle		-	-	144

Ch. #		Band I : 5150-5250 MHz	Band II : 5250-5350 MHz	Band III : 5470-5725MHz
		802.11n HT20	802.11n HT20	802.11n HT20
L	Low	36	52	100
M	Middle	44	60	116
H	High	48	64	140
Straddle		-	-	144

Ch. #		Band I : 5150-5250 MHz	Band II : 5250-5350 MHz	Band III : 5470-5725MHz
		802.11n HT40	802.11n HT40	802.11n HT40
L	Low	38	54	102
M	Middle	-	-	110
H	High	46	62	134
Straddle		-	-	142



Ch. #		Band I : 5150-5250 MHz	Band II : 5250-5350 MHz	Band III : 5470-5725MHz
		802.11ac VHT20	802.11ac VHT20	802.11ac VHT20
L	Low	36	52	100
M	Middle	44	60	116
H	High	48	64	140
Straddle				144

Ch. #		Band I : 5150-5250 MHz	Band II : 5250-5350 MHz	Band III : 5470-5725MHz
		802.11ac VHT40	802.11ac VHT40	802.11ac VHT40
L	Low	38	54	102
M	Middle	-	-	110
H	High	46	62	134
Straddle				142

Ch. #		Band I : 5150-5250 MHz	Band II : 5250-5350 MHz	Band III : 5470-5725MHz
		802.11ac VHT80	802.11ac VHT80	802.11ac VHT80
L	Low	-	-	-
M	Middle	42	58	106
H	High	-	-	-
Straddle				138

2.3 Connection Diagram of Test System

<WLAN Tx Mode>

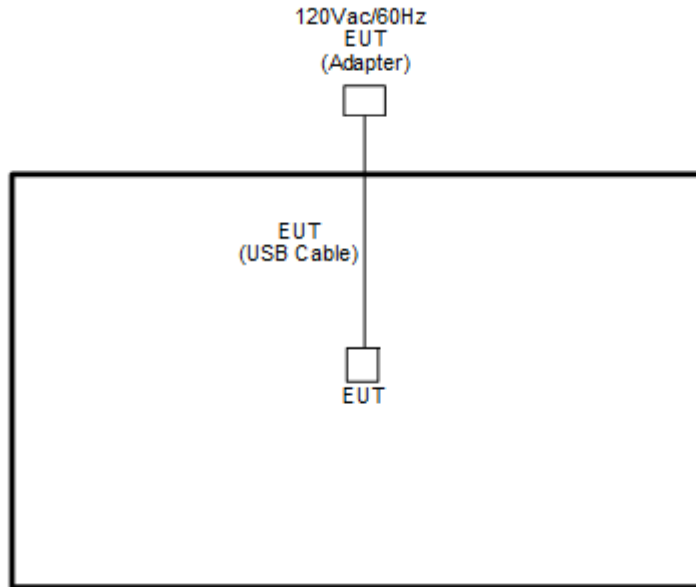

<AC Conducted Emission Mode>

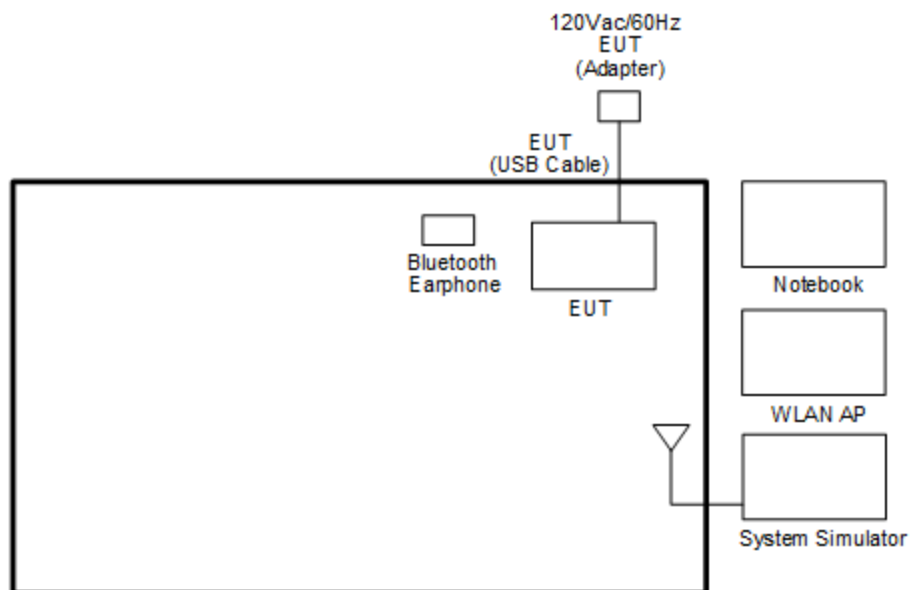



2.4 Support Unit used in test configuration and system

Item	Equipment	Trade Name	Model Name	FCC ID	Data Cable	Power Cord
1.	System Simulator	R&S	CMU 200	N/A	N/A	Unshielded, 1.8 m
2.	WLAN AP	ASUS	RT-AC66U	MSQ-RTAC66U	N/A	Unshielded, 1.8 m
3.	Bluetooth Earphone	Sony Ericsson	MW600	PY7DDA-2029	N/A	N/A
4.	Notebook	DELL	Latitude E6320	FCC DoC/ Contains FCC ID: QDS-BRCM1054	N/A	AC I/P: Unshielded, 1.2 m DC O/P: Shielded, 1.8 m
5.	SD Card	SanDisk	MicroSD HC	FCC DoC	N/A	N/A

2.5 EUT Operation Test Setup

The RF test items, programmed RF utility, “QRCT” installed in the notebook make the EUT provide functions like channel selection and power level for continuous transmitting and receiving signals.

2.6 Measurement Results Explanation Example

For all conducted test items:

The offset level is set in the spectrum analyzer to compensate the RF cable loss and attenuator factor between EUT conducted output port and spectrum analyzer. With the offset compensation, the spectrum analyzer reading level is exactly the EUT RF output level.

Example :

The spectrum analyzer offset is derived from RF cable loss and attenuator factor.

$$\text{Offset} = \text{RF cable loss} + \text{attenuator factor}.$$

Following shows an offset computation example with cable loss 4.2 dB and 10dB attenuator.

$$\begin{aligned} \text{Offset(dB)} &= \text{RF cable loss(dB)} + \text{attenuator factor(dB)}. \\ &= 4.2 + 10 = 14.2 \text{ (dB)} \end{aligned}$$

3 Test Result

3.1 26dB & 99% Occupied Bandwidth Measurement

3.1.1 Description of 26dB & 99% Occupied Bandwidth

This section is for reporting purpose only.

There is no restriction limits for bandwidth.

For Straddle Channel, U-NII procedures and limits were applied for operations in the frequency band in accordance with FCC KDB 644545 D03.

3.1.2 Measuring Instruments

The measuring equipment is listed in the section 4 of this test report.

3.1.3 Test Procedures

1. The testing follows FCC KDB 789033 D02 General UNII Test Procedures New Rules v01r04. Section C) Emission bandwidth
2. Set RBW = approximately 1% of the emission bandwidth.
3. Set the VBW > RBW.
4. Detector = Peak.
5. Trace mode = max hold
6. Measure the maximum width of the emission that is 26 dB down from the peak of the emission. Compare this with the RBW setting of the analyzer. Readjust RBW and repeat measurement as needed until the RBW/EBW ratio is approximately 1%.
7. For 99% Bandwidth Measurement, the spectrum analyzer's resolution bandwidth (RBW) is set 1MHz and set the Video bandwidth (VBW) $\geq 3 * RBW$.
8. Measure and record the results in the test report.

3.1.4 Test Setup

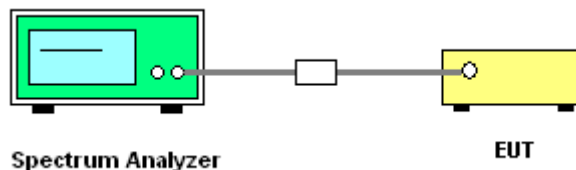



3.1.5 Test Result of 26dB & 99% Occupied Bandwidth Plots

Please refer to Appendix A.

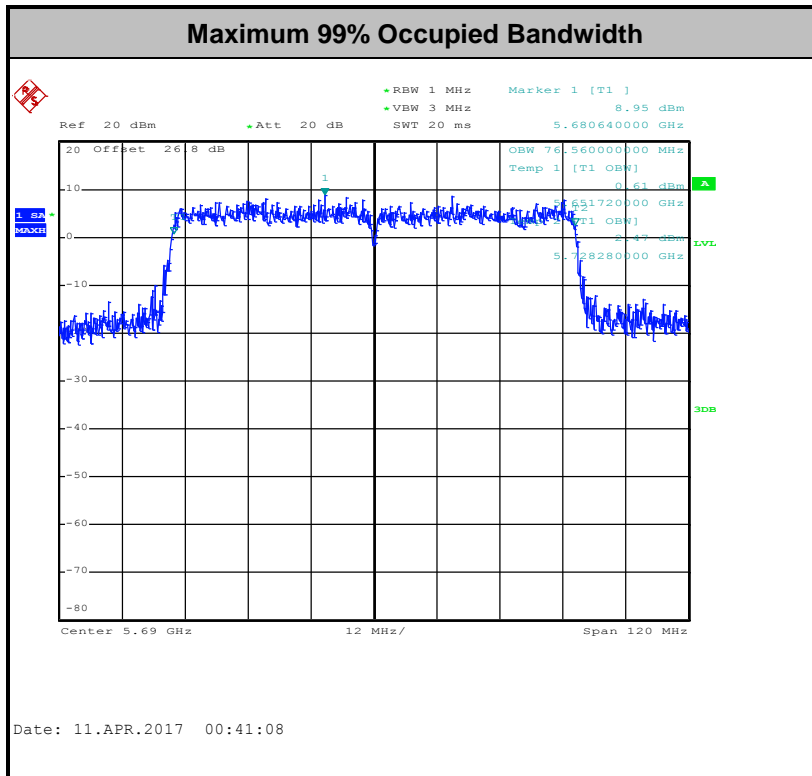
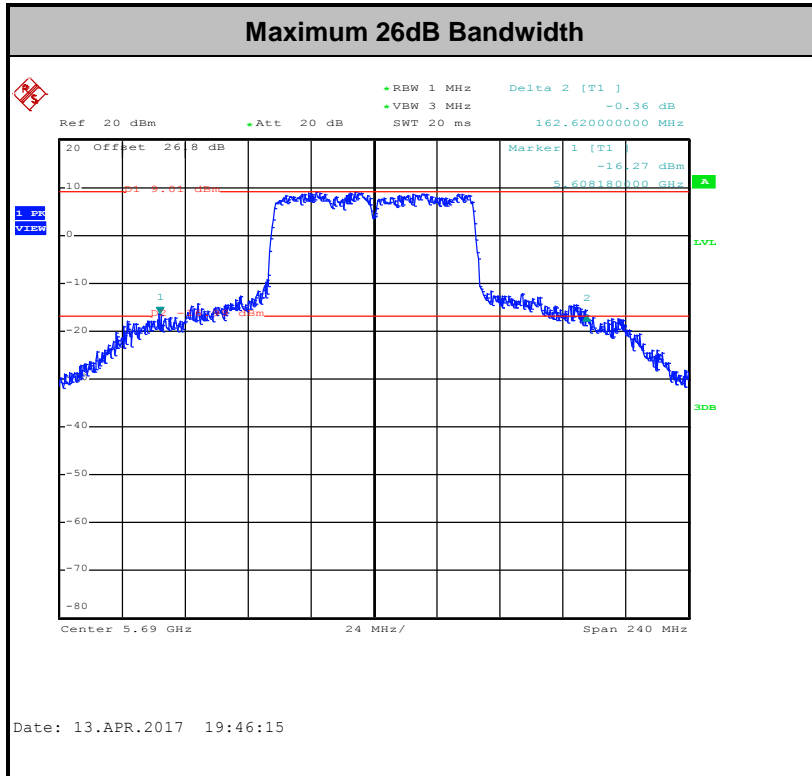



3.2 Maximum Conducted Output Power Measurement

3.2.1 Limit of Maximum Conducted Output Power

<FCC 14-30 CFR 15.407>

For mobile and portable client devices in the 5.15–5.25 GHz band, the maximum conducted output power over the frequency band of operation shall not exceed 250 mW.

For the 5.25–5.725 GHz bands, the maximum conducted output power over the frequency bands of operation shall not exceed the lesser of 250 mW or $11 \text{ dBm} + 10 \log B$, where B is the 26 dB emission bandwidth in megahertz.

For Straddle Channel, U-NII procedures and limits were applied for operations in the frequency band in accordance with FCC KDB 644545 D03.

If transmitting antennas of directional gain greater than 6 dBi are used, the peak output power shall be reduced by the amount in dB that the directional gain of the antenna exceeds 6 dBi.

Note that U-NII-2 band, devices with a maximum e.i.r.p. greater than 500 mW shall implement TPC in order to have the capability to operate at least 6 dB below the maximum permitted e.i.r.p. of 1 W.

3.2.2 Measuring Instruments

The measuring equipment is listed in the section 4 of this test report.

3.2.3 Test Procedures

The testing follows Method PM of FCC KDB 789033 D02 General UNII Test Procedures New Rules v01r04.

Method PM (Measurement using an RF average power meter):

1. Measurement is performed using a wideband RF power meter.
2. The EUT is configured to transmit continuously with a consistent duty cycle at its maximum power control level.
3. Measure the average power of the transmitter, and the average power is corrected with duty factor, $10 \log(1/x)$, where x is the duty cycle.

For straddle channel, the testing follows Method SA-3 (RMS detection with max hold) of FCC KDB 789033 D02 General UNII Test Procedures New Rules v01r04.

Compute power by integrating the spectrum across the 99% occupied bandwidth of the signal using the instrument's band power measurement function.

3.2.4 Test Setup

For normal channel:

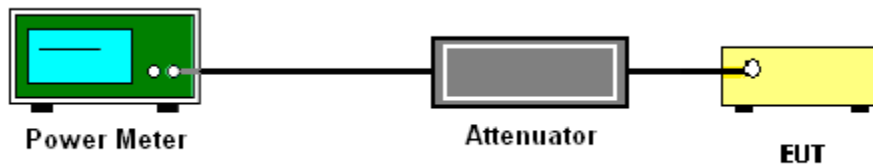

For straddle channel:

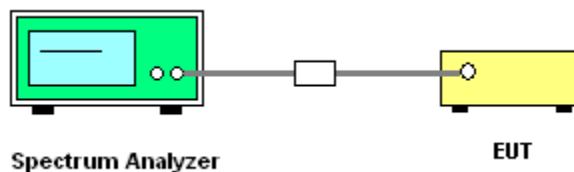



3.2.5 Test Result of Maximum Conducted Output Power

Please refer to Appendix A.

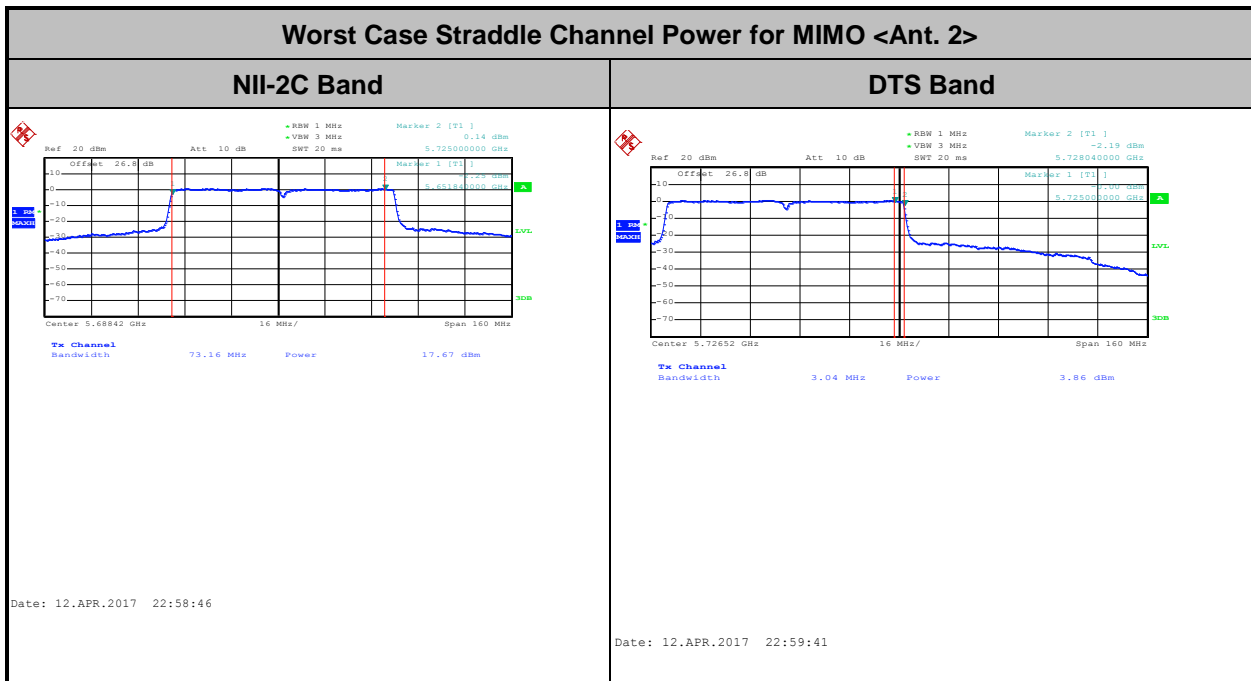
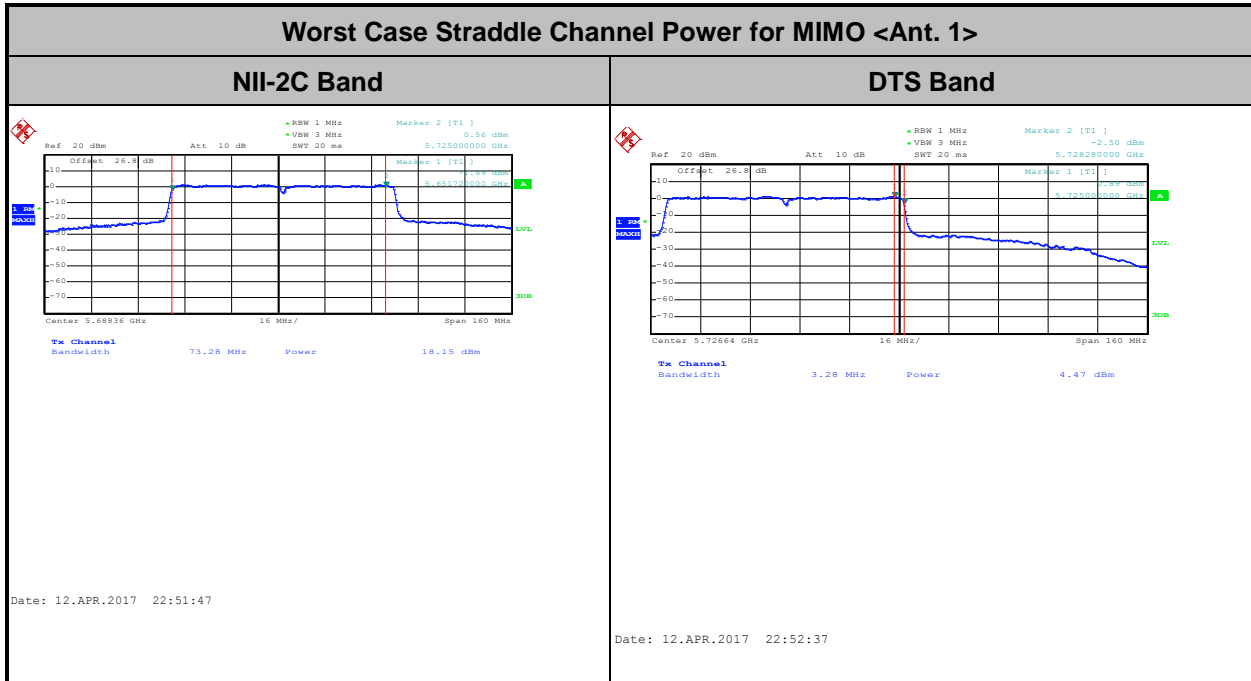



3.3 Power Spectral Density Measurement

3.3.1 Limit of Power Spectral Density

<FCC 14-30 CFR 15.407>

For mobile and portable client devices in the 5.15–5.25 GHz band, the maximum power spectral density shall not exceed 11dBm in any 1 megahertz band.

For the 5.25–5.725 GHz bands, the maximum power spectral density shall not exceed 11 dBm in any 1 megahertz band.

For Straddle Channel, U-NII procedures and limits were applied for operations in the frequency band in accordance with FCC KDB 644545 D03.

If transmitting antennas of directional gain greater than 6 dBi are used, the peak output power shall be reduced by the amount in dB that the directional gain of the antenna exceeds 6 dBi.

3.3.2 Measuring Instruments

The measuring equipment is listed in the section 4 of this test report.



3.3.3 Test Procedures

The testing follows FCC KDB 789033 D02 General UNII Test Procedures New Rules v01r04.
Section F) Maximum power spectral density.

Method SA-2

(trace averaging across on and off times of the EUT transmissions, followed by duty cycle correction).

1. The testing follows Method SA-2 of FCC KDB 789033 D02 General UNII Test Procedures New Rules v01r04.
 - Measure the duty cycle.
 - Set span to encompass the entire emission bandwidth (EBW) of the signal.
 - Set RBW = 1 MHz.
 - Set VBW \geq 3 MHz.
 - Number of points in sweep \geq 2 Span / RBW.
 - Sweep time = auto.
 - Detector = RMS
 - Trace average at least 100 traces in power averaging mode.
 - Add $10 \log(1/x)$, where x is the duty cycle, to the measured power in order to compute the average power during the actual transmission times. For example, add $10 \log(1/0.25) = 6$ dB if the duty cycle is 25 percent.
2. The RF output of EUT was connected to the spectrum analyzer by a low loss cable.
3. Each plot has already offset with cable loss, and attenuator loss. Measure the PPSD and record it.
4. For MIMO mode, calculation method follows FCC KDB 662911 D01 Multiple Transmitter Output v02r01.

Method (a): Measure and sum the spectra across the outputs.

The total final Power Spectral Density is from a device with 2 transmitter outputs. The spectrum measurements of the individual outputs are all performed with the same span and number of points, the spectrum value in the first spectral bin of output 1 is summed with that in the first spectral bin of output 2 to obtain the value for the first frequency bin of the summed spectrum.



3.4 Unwanted Radiated Emission Measurement

This section is to measure unwanted emissions through radiated measurement for band edge spurious emissions and out of band emissions measurement..

3.4.1 Limit of Unwanted Emissions

- (1) For transmitters operating in the 5150-5250 MHz band: all emissions outside of the 5150-5350 MHz band shall not exceed an EIRP of -27dBm/MHz.

For transmitters operating in the 5250-5350 MHz band: all emissions outside of the 5150-5350 MHz band shall not exceed an EIRP of -27 dBm/MHz. Devices operating in the 5250-5350 MHz band that generate emissions in the 5150-5250 MHz band must meet all applicable technical requirements for operation in the 5150-5250 MHz band (including indoor use) or alternatively meet an out-of-band emission EIRP limit of -27 dBm/MHz in the 5150-5250 MHz band.

For transmitters operating in the 5470-5725MHz band: all emissions outside of the 5470-5725MHz band shall not exceed an EIRP of -27 dBm/MHz.

- (2) Unwanted spurious emissions fallen in restricted bands shall comply with the general field strength limits set forth as below table,

Frequency (MHz)	Field Strength (microvolts/meter)	Measurement Distance (meters)
0.009 – 0.490	2400/F(kHz)	300
0.490 – 1.705	24000/F(kHz)	30
1.705 – 30.0	30	30
30 – 88	100	3
88 – 216	150	3
216 - 960	200	3
Above 960	500	3

Note: The following formula is used to convert the EIRP to field strength.

$$E = \frac{1000000\sqrt{30P}}{3} \mu\text{V/m, where P is the eirp (Watts)}$$



EIRP (dBm)	Field Strength at 3m (dBµV/m)
- 27	68.3

(3) KDB789033 D02 v01r04 G)2)c)

- (i) Sections 15.407(b)(1) to (b)(3) specify the unwanted emission limits for the U-NII-1 and U-NII-2 bands. As specified, emissions above 1000 MHz that are outside of the restricted bands are subject to a peak emission limit of -27 dBm/MHz.³
- (ii) Section 15.407(b)(4) specifies the unwanted emission limit for the U-NII-3 band. A band emissions mask is specified in Section 15.407(b)(4)(i). The emission limits are in terms of a Peak detector. An alternative to the band emissions mask is specified in Section 15.407(b)(4)(ii). The alternative limits are based on the highest antenna gain specified in the filing. There are also marketing and importation restrictions for the devices using the alternative limit.⁴

Note 3: An out-of-band emission that complies with both the average and peak limits of Section 15.209 is not required to satisfy the -27 dBm/MHz peak emission limit.

Note 4: Only devices with antenna gains of 10 dBi or less may be approved using the emission limits specified in Section 15.247(d) till March 2, 2018; all other devices operating in this band must use the mask specified in Section 15.407(b)(4)(i).

3.4.2 Measuring Instruments

The measuring equipment is listed in the section 4 of this test report.



3.4.3 Test Procedures

1. The testing follows FCC KDB 789033 D02 General UNII Test Procedures New Rules v01r04. Section G) Unwanted emissions measurement.

(1) Procedure for Unwanted Emissions Measurements Below 1000MHz

- RBW = 120 kHz
- VBW = 300 kHz
- Detector = Peak
- Trace mode = max hold

(2) Procedure for Peak Unwanted Emissions Measurements Above 1000 MHz

- RBW = 1 MHz
- VBW \geq 3 MHz
- Detector = Peak
- Sweep time = auto
- Trace mode = max hold

(3) Procedures for Average Unwanted Emissions Measurements Above 1000MHz

- RBW = 1 MHz
- VBW = 10 Hz, when duty cycle is no less than 98 percent.
- VBW \geq 1/T, when duty cycle is less than 98 percent where T is the minimum transmission duration over which the transmitter is on and is transmitting at its maximum power control level for the tested mode of operation.

2. The EUT was placed on a turntable with 0.8 meter for frequency below 1GHz and 1.5 meter for frequency above 1GHz respectively above ground.
3. The EUT was set 3 meters from the interference receiving antenna which was mounted on the top of a variable height antenna tower.
4. The antenna is a broadband antenna and its height is adjusted between one meter and four meters above ground to find the maximum value of the field strength for both horizontal polarization and vertical polarization of the antenna.
5. For each suspected emission, the EUT was arranged to its worst case and then adjust the antenna tower (from 1 m to 4 m) and turntable (from 0 degree to 360 degrees) to find the maximum reading.
6. For testing below 1GHz, if the emission level of the EUT in peak mode was 3 dB lower than the limit specified, then peak values of EUT will be reported, otherwise, the emissions will be repeated one by one using the CISPR quasi-peak method and reported.
7. For testing above 1GHz, the emission level of the EUT in peak mode was 20dB lower than average limit (that means the emission level in average mode also complies with the limit in average mode), then peak values of EUT will be reported, otherwise, the emissions will be measured in average mode again and reported.

3.4.4 Test Setup

For radiated emissions below 30MHz

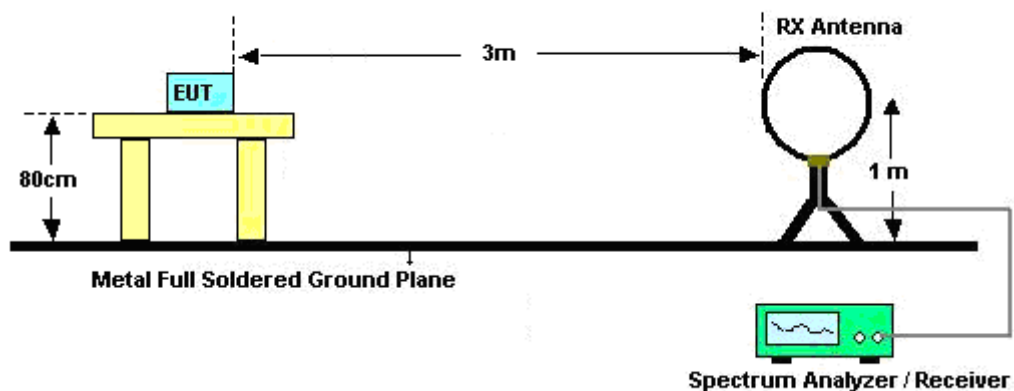

For radiated emissions from 30MHz to 1GHz

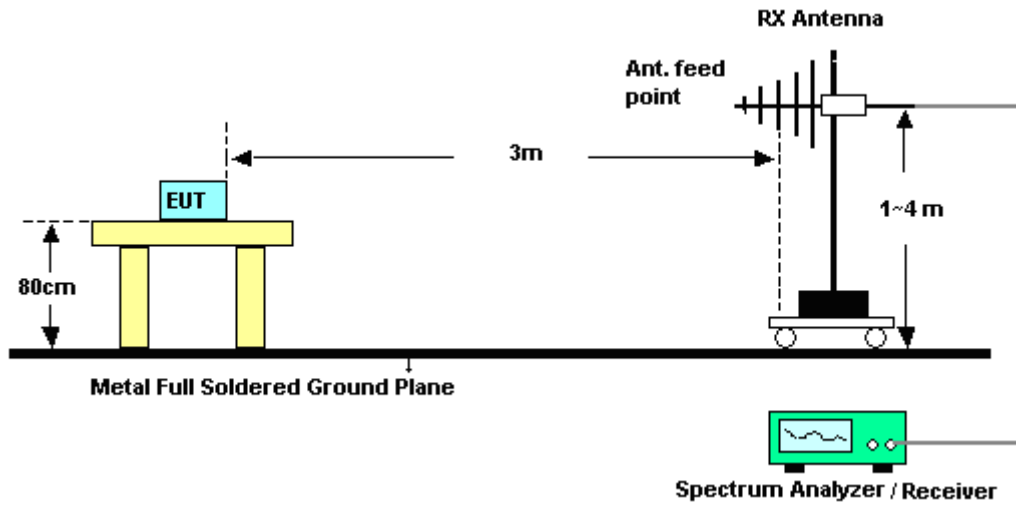

For radiated emissions above 1GHz

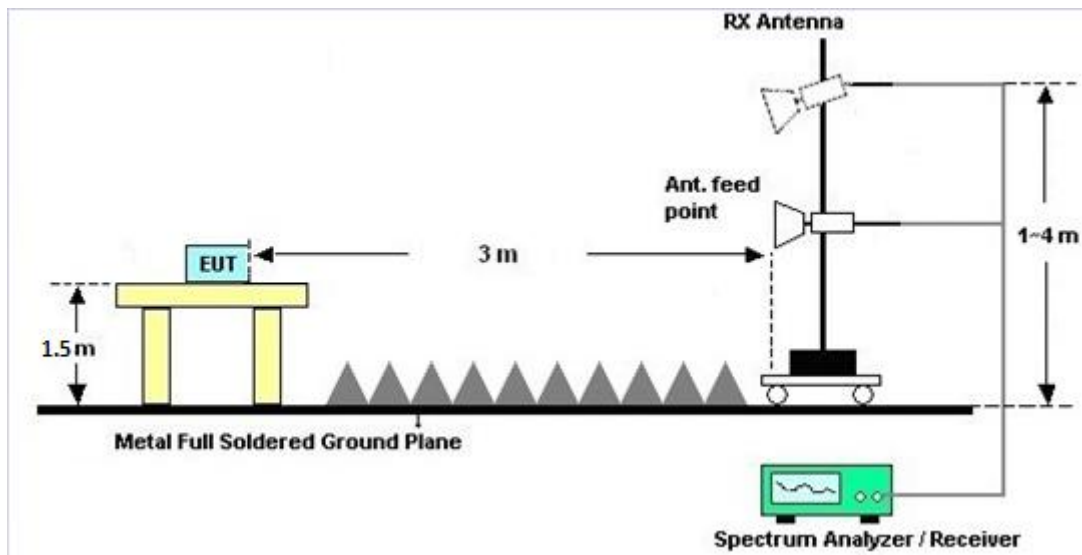



3.4.5 Test Results of Radiated Spurious Emissions (9 kHz ~ 30 MHz)

The low frequency, which started from 9 kHz to 30MHz, was pre-scanned and the result which was 20dB lower than the limit line was not reported.

3.4.6 Test Result of Radiated Spurious at Band Edges

Please refer to Appendix B and C.

3.4.7 Duty Cycle

Please refer to Appendix D.

3.4.8 Test Result of Radiated Spurious Emissions (30MHz ~ 10th Harmonic)

Please refer to Appendix B and C.



3.5 AC Conducted Emission Measurement

3.5.1 Limit of AC Conducted Emission

For equipment that is designed to be connected to the public utility (AC) power line, the radio frequency voltage that is conducted back onto the AC power line on any frequency or frequencies within the band 150 kHz to 30 MHz shall not exceed the limits in the following table.

Frequency of emission (MHz)	Conducted limit (dB μ V)	
	Quasi-peak	Average
0.15-0.5	66 to 56*	56 to 46*
0.5-5	56	46
5-30	60	50

*Decreases with the logarithm of the frequency.

3.5.2 Measuring Instruments

The measuring equipment is listed in the section 4 of this test report.

3.5.3 Test Procedures

1. The EUT was placed 0.4 meter from the conducting wall of the shielding room was kept at least 80 centimeters from any other grounded conducting surface.
2. Connect EUT to the power mains through a line impedance stabilization network (LISN).
3. All the support units are connecting to the other LISN.
4. The LISN provides 50 ohm coupling impedance for the measuring instrument.
5. The FCC states that a 50 ohm, 50 microhenry LISN should be used.
6. Both sides of AC line were checked for maximum conducted interference.
7. The frequency range from 150 kHz to 30 MHz was searched.
8. Set the test-receiver system to Peak Detect Function and specified bandwidth with Maximum Hold Mode.

3.5.4 Test Setup

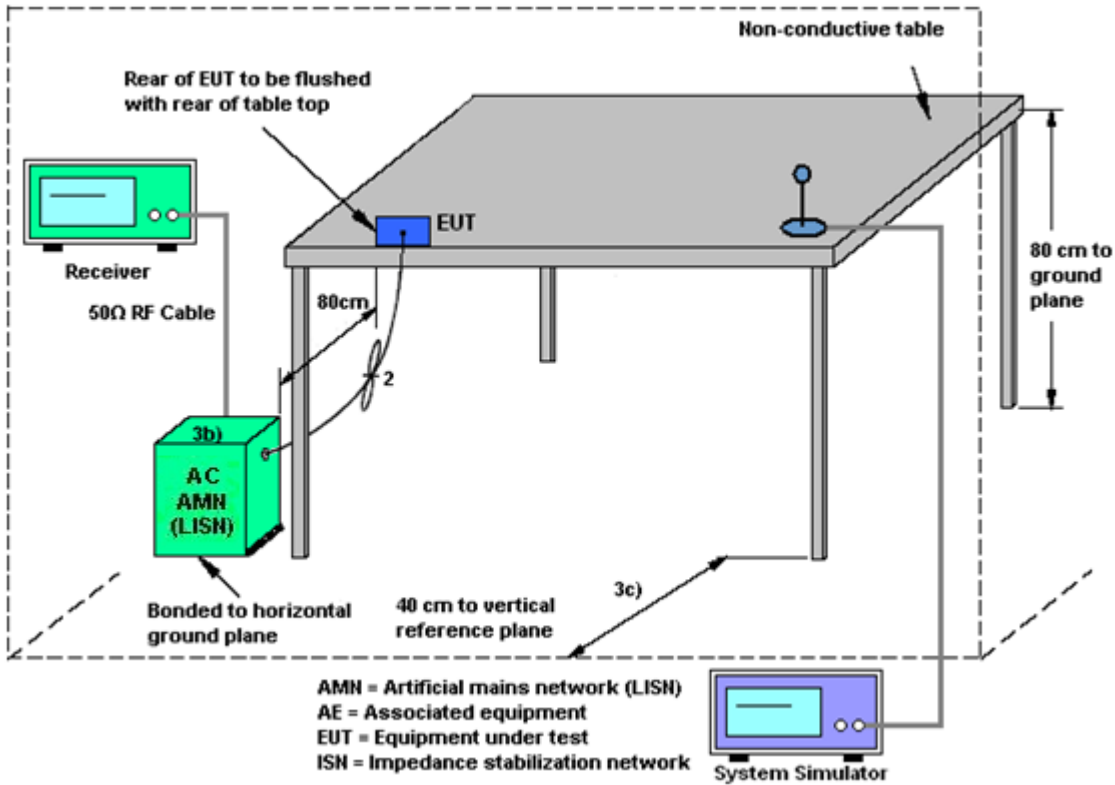



3.5.5 Test Result of AC Conducted Emission

Test Mode :	Mode 1	Temperature :	21~23°C
Test Engineer :	Eric Jeng	Relative Humidity :	52~55%
Test Voltage :	120Vac / 60Hz	Phase :	Line
Function Type :	GSM850 Idle + Bluetooth Link + WLAN (5GHz) Link + MP3 + Battery 2 + USB Cable (Charging from Adapter 3)		

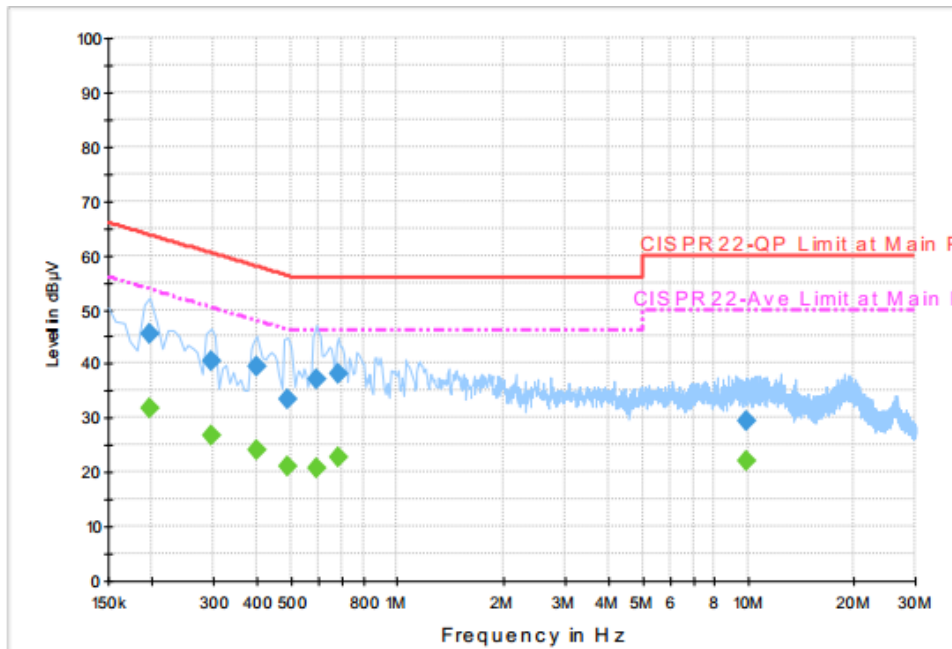

Final Result : QuasiPeak

Frequency (MHz)	QuasiPeak (dBµV)	Filter	Line	Corr. (dB)	Margin (dB)	Limit (dBµV)
0.198000	45.5	Off	L1	19.6	18.2	63.7
0.294000	40.4	Off	L1	19.6	20.0	60.4
0.398000	39.6	Off	L1	19.6	18.3	57.9
0.486000	33.5	Off	L1	19.6	22.7	56.2
0.590000	37.2	Off	L1	19.6	18.8	56.0
0.678000	38.1	Off	L1	19.6	17.9	56.0
9.902000	29.3	Off	L1	20.0	30.7	60.0

Final Result : Average

Frequency (MHz)	Average (dBµV)	Filter	Line	Corr. (dB)	Margin (dB)	Limit (dBµV)
0.198000	31.7	Off	L1	19.6	22.0	53.7
0.294000	26.7	Off	L1	19.6	23.7	50.4
0.398000	24.1	Off	L1	19.6	23.8	47.9
0.486000	20.9	Off	L1	19.6	25.3	46.2
0.590000	20.8	Off	L1	19.6	25.2	46.0
0.678000	22.6	Off	L1	19.6	23.4	46.0
9.902000	22.0	Off	L1	20.0	28.0	50.0



Test Mode :	Mode 1	Temperature :	21~23°C
Test Engineer :	Eric Jeng	Relative Humidity :	52~55%
Test Voltage :	120Vac / 60Hz	Phase :	Neutral
Function Type :	GSM850 Idle + Bluetooth Link + WLAN (5GHz) Link + MP3 + Battery 2 + USB Cable (Charging from Adapter 3)		

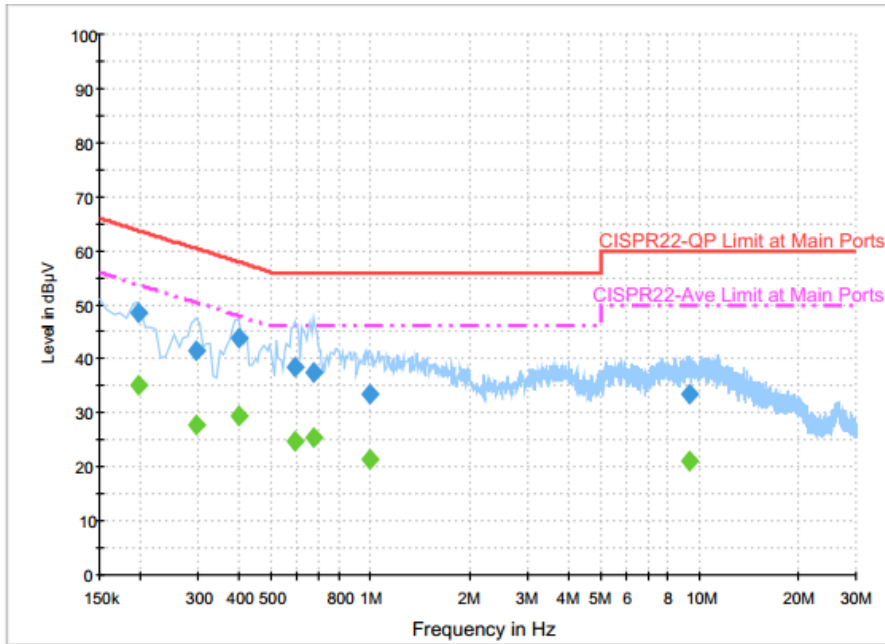

Final Result : QuasiPeak

Frequency (MHz)	QuasiPeak (dBµV)	Filter	Line	Corr. (dB)	Margin (dB)	Limit (dBµV)
0.198000	48.4	Off	N	19.5	15.3	63.7
0.294000	41.4	Off	N	19.5	19.0	60.4
0.398000	43.9	Off	N	19.5	14.0	57.9
0.590000	38.5	Off	N	19.5	17.5	56.0
0.670000	37.6	Off	N	19.5	18.4	56.0
0.998000	33.6	Off	N	19.6	22.4	56.0
9.342000	33.3	Off	N	20.0	26.7	60.0

Final Result : Average

Frequency (MHz)	Average (dBµV)	Filter	Line	Corr. (dB)	Margin (dB)	Limit (dBµV)
0.198000	35.1	Off	N	19.5	18.6	53.7
0.294000	27.8	Off	N	19.5	22.6	50.4
0.398000	29.6	Off	N	19.5	18.3	47.9
0.590000	24.7	Off	N	19.5	21.3	46.0
0.670000	25.4	Off	N	19.5	20.6	46.0
0.998000	21.4	Off	N	19.6	24.6	46.0
9.342000	21.2	Off	N	20.0	28.8	50.0

3.6 Frequency Stability Measurement

3.6.1 Limit of Frequency Stability

Manufacturers of U-NII devices are responsible for ensuring frequency stability such that an emission is maintained within the band of operation under all conditions of normal operation as specified in the user's manual.

3.6.2 Measuring Instruments

The measuring equipment is listed in the section 4 of this test report.

3.6.3 Test Procedures

1. To ensure emission at the band edge is maintained within the authorized band, those values shall be measured by radiation emissions at upper and lower frequency points, and finally compensated by frequency deviation as procedures below.
2. The EUT was operated at the maximum output power, and connected to the spectrum analyzer, which is set to maximum hold function and peak detector. The peak value of the power envelope was measured and noted. The upper and lower frequency points were respectively measured relatively 10dB lower than the measured peak value.
3. The frequency deviation was calculated by adding the upper frequency point and the lower frequency point divided by two. Those detailed values of frequency deviation are provided in table below.

3.6.4 Test Setup

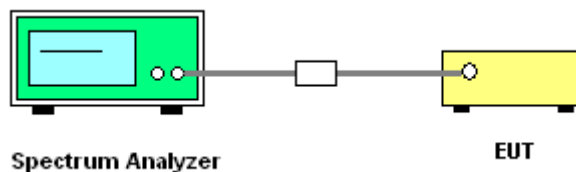

3.6.5 Test Result of Frequency Stability

Please refer to Appendix A.



3.7 Automatically Discontinue Transmission

3.7.1 Limit of Automatically Discontinue Transmission

The device shall automatically discontinue transmission in case of either absence of information to transmit or operational failure. These provisions are not intended to preclude the transmission of control or signaling information or the use of repetitive codes used by certain digital technologies to complete frame or burst intervals. Applicants shall include in their application for equipment authorization to describe how this requirement is met.

3.7.2 Measuring Instruments

The measuring equipment is listed in the section 4 of this test report.

3.7.3 Test Result of Automatically Discontinue Transmission

While the EUT is not transmitting any information, the EUT can automatically discontinue transmission and become standby mode for power saving. The EUT can detect the controlling signal of ACK message transmitting from remote device and verify whether it shall resend or discontinue transmission.



3.8 Antenna Requirements

3.8.1 Standard Applicable

If transmitting antenna directional gain is greater than 6 dBi, both the peak transmit power and the peak power spectral density shall be reduced by the amount in dB that the directional gain of the antenna exceeds 6 dBi.

3.8.2 Antenna Anti-Replacement Construction

An embedded-in antenna design is used.

3.8.3 Antenna Gain

FCC KDB 662911 D01 Multiple Transmitter Output v02r01

For CDD transmissions, directional gain is calculated as

Directional gain = G_{ANT} + Array Gain, where Array Gain is as follows.

For power spectral density (PSD) measurements on all devices,

Array Gain = $10 \log(N_{ANT}/N_{SS}=1)$ dB.

For power measurements on IEEE 802.11 devices,

Array Gain = 0 dB (i.e., no array gain) for $N_{ANT} \leq 4$.

Directional gain may be calculated by using the formulas applicable to equal gain antennas with G_{ANT} set equal to the gain of the antenna having the highest gain;

The EUT supports CDD mode.

For power, the directional gain G_{ANT} is set equal to the antenna having the highest gain, i.e., F)2)f)i).

For PSD, the directional gain calculation is following F)2)f)ii) of KDB 662911 D01 v02r01.

The power and PSD limit should be modified if the directional gain of EUT is over 6 dBi,

The directional gain "DG" is calculated as following table.

	Ant 1	Ant 2	DG for Power	DG for PSD	Power Limit Reduction	PSD Limit Reduction
	(dBi)	(dBi)	(dBi)	(dBi)	(dB)	(dB)
Band I	-3.70	-3.30	-3.30	-0.49	0.00	0.00
Band II	-2.40	-3.10	-2.40	0.27	0.00	0.00
Band III	-2.40	-3.50	-2.40	0.08	0.00	0.00

Power limit reduction = Composite gain – 6dBi, (min = 0)

PSD limit reduction = Composite gain + PSD Array gain – 6dBi, (min = 0)



4 List of Measuring Equipments

Instrument	Manufacturer	Model No.	Serial No.	Characteristics	Calibration Date	Test Date	Due Date	Remark
Power Meter	Anritsu	ML2495A	0932001	300MHz~40GHz	Sep. 29, 2016	Apr. 01, 2017~ Apr. 26, 2017	Sep. 28, 2017	Conducted (TH05-HY)
Power Sensor	Anritsu	MA2411B	0846202	300MHz~40GHz	Sep. 29, 2016	Apr. 01, 2017~ Apr. 26, 2017	Sep. 28, 2017	Conducted (TH05-HY)
Spectrum Analyzer	Rohde & Schwarz	FSP40	100055	9kHz-40GHz	Jul. 17, 2016	Apr. 01, 2017~ Apr. 26, 2017	Jul. 16, 2017	Conducted (TH05-HY)
Temperature Chamber	ESPEC	SH-641	92013720	-40°C ~90°C	Sep. 01, 2016	Apr. 01, 2017~ Apr. 26, 2017	Aug. 31, 2017	Conducted (TH05-HY)
Programmable Power Supply	GW Instek	PSS-2005	EL890094	1V~20V 0.5A~5A	Oct. 11, 2016	Apr. 01, 2017~ Apr. 26, 2017	Oct. 10, 2017	Conducted (TH05-HY)
AC Power Source	ChainTek	APC-1000W	N/A	N/A	N/A	Apr. 05, 2017	N/A	Conduction (CO05-HY)
EMI Test Receiver	Rohde & Schwarz	ESCI 7	100724	9kHz~7GHz	Aug. 30, 2016	Apr. 05, 2017	Aug. 29, 2017	Conduction (CO05-HY)
LISN	Rohde & Schwarz	ENV216	100080	9kHz~30MHz	Nov. 29, 2016	Apr. 05, 2017	Nov. 28, 2017	Conduction (CO05-HY)
Amplifier	SONOMA	310N	187312	9kHz~1GHz	Nov. 10, 2016	Apr. 08, 2017~ Apr. 14, 2017	Nov. 09, 2017	Radiation (03CH11-HY)
Loop Antenna	Rohde & Schwarz	HFH2-Z2	100315	9 kHz~30 MHz	Sep. 02, 2015	Apr. 08, 2017~ Apr. 14, 2017	Sep. 01, 2017	Radiation (03CH11-HY)
Bilog Antenna	TESEQ	CBL 6111D	35414	30MHz~1GHz	Oct. 15, 2016	Apr. 08, 2017~ Apr. 14, 2017	Oct. 14, 2017	Radiation (03CH11-HY)
Horn Antenna	SCHWARZBECK	BBHA 9120 D	9120D-1326	1GHz ~ 18GHz	Oct. 07, 2016	Apr. 08, 2017 ~ Apr. 14, 2017	Oct. 06, 2017	Radiation (03CH11-HY)
Preamplifier	Keysight	83017A	MY53270080	1GHz~26.5GHz	Nov. 10, 2016	Apr. 08, 2017~ Apr. 14, 2017	Nov. 09, 2017	Radiation (03CH11-HY)
Spectrum Analyzer	Keysight	N9010A	MY54200486	10Hz ~ 44GHz	Oct. 12, 2016	Apr. 08, 2017 ~ Apr. 14, 2017	Oct. 11, 2017	Radiation (03CH11-HY)
Antenna Mast	EMEC	AM-BS-4500-B	N/A	1~4m	N/A	Apr. 08, 2017~ Apr. 14, 2017	N/A	Radiation (03CH11-HY)
Turn Table	EMEC	TT 2000	N/A	0~360 Degree	N/A	Apr. 08, 2017~ Apr. 14, 2017	N/A	Radiation (03CH11-HY)
Preamplifier	MITEQ	AMF-7D-0010 1800-30-10P	1815698	1GHz~18GHz	Dec. 01, 2016	Apr. 08, 2017~ Apr. 14, 2017	Nov. 30, 2017	Radiation (03CH11-HY)
SHF-EHF Horn Antenna	SCHWARZBECK	BBHA 9170	BBHA917058 4	18GHz- 40GHz	Nov. 08, 2016	Apr. 08, 2017~ Apr. 14, 2017	Nov. 07, 2017	Radiation (03CH11-HY)
Preamplifier	MITEQ	TTA0204	1872107	2GHz~40GHz	Feb. 15, 2017	Apr. 08, 2017~ Apr. 14, 2017	Feb. 14, 2018	Radiation (03CH11-HY)



5 Uncertainty of Evaluation

Uncertainty of Conducted Emission Measurement (150kHz ~ 30MHz)

Measuring Uncertainty for a Level of Confidence of 95% ($U = 2Uc(y)$)	2.7
---	-----

Uncertainty of Radiated Emission Measurement (30 MHz ~ 1000 MHz)

Measuring Uncertainty for a Level of Confidence of 95% ($U = 2Uc(y)$)	5.2
---	-----

Uncertainty of Radiated Emission Measurement (1000 MHz ~ 18000 MHz)

Measuring Uncertainty for a Level of Confidence of 95% ($U = 2Uc(y)$)	5.5
---	-----

Uncertainty of Radiated Emission Measurement (18000 MHz ~ 40000 MHz)

Measuring Uncertainty for a Level of Confidence of 95% ($U = 2Uc(y)$)	5.2
---	-----

Appendix A. Test Result of Conducted Test Items

Test Engineer:	Shiming Liu	Temperature:	21~25	°C
Test Date:	2017/4/1~2017/4/26	Relative Humidity:	51~54	%

TEST RESULTS DATA
26dB and 99% OBW

Band I													
Mod.	Data Rate	NTX	CH.	Freq. (MHz)	99% Bandwidth (MHz)		26 dB Bandwidth (MHz)		IC 99% Bandwidth Power Limit (dBm)		IC 99% Bandwidth EIRP Limit (dBm)		Note
					Ant 1	Ant 2	Ant 1	Ant 2	Ant 1	Ant 2	Ant 1	Ant 2	
11a	6Mbps	2	36	5180	17.65	17.65	36.10	28.70	-	-	22.47		
11a	6Mbps	2	44	5220	17.85	17.60	32.75	24.65	-	-	22.46		
11a	6Mbps	2	48	5240	17.60	17.75	32.30	24.85	-	-	22.46		
HT20	MCS0	2	36	5180	18.80	18.95	38.55	32.60	-	-	22.74		
HT20	MCS0	2	44	5220	18.80	18.85	30.00	29.45	-	-	22.74		
HT20	MCS0	2	48	5240	18.80	18.90	32.90	28.30	-	-	22.74		
HT40	MCS0	2	38	5190	37.00	37.00	51.30	43.38	-	-	23.01		
HT40	MCS0	2	46	5230	37.00	36.80	44.46	43.20	-	-	23.01		
VHT20	MCS0	2	36	5180	18.85	18.85	33.15	28.80	-	-	22.75		
VHT20	MCS0	2	44	5220	18.80	19.00	34.00	31.25	-	-	22.74		
VHT20	MCS0	2	48	5240	18.80	18.80	34.80	31.35	-	-	22.74		
VHT40	MCS0	2	38	5190	37.10	37.00	55.08	48.24	-	-	23.01		
VHT40	MCS0	2	46	5230	37.10	36.90	56.64	46.26	-	-	23.01		
VHT80	MCS0	2	42	5210	76.08	75.96	85.88	84.66	-	-	23.01		

TEST RESULTS DATA
Average Power Table

FCC Band I														
Mod.	Data Rate	NTX	CH.	Freq. (MHz)	Duty Factor (dB)		Average Conducted Power (dBm)			FCC Conducted Power Limit (dBm)		DG (dBi)		Pass/Fail
					Ant 1	Ant 2	Ant 1	Ant 2	SUM	Ant 1	Ant 2	Ant 1	Ant 2	
11a	6Mbps	1	36	5180	0.26	0.23	18.16	18.10		24.00	24.00	-3.70	-3.30	Pass
11a	6Mbps	1	44	5220	0.26	0.23	18.12	18.07		24.00	24.00	-3.70	-3.30	Pass
11a	6Mbps	1	48	5240	0.26	0.23	18.01	17.96		24.00	24.00	-3.70	-3.30	Pass
HT20	MCS0	1	36	5180	0.28	0.25	18.15	18.02		24.00	24.00	-3.70	-3.30	Pass
HT20	MCS0	1	44	5220	0.28	0.25	18.09	17.97		24.00	24.00	-3.70	-3.30	Pass
HT20	MCS0	1	48	5240	0.28	0.25	18.05	17.90		24.00	24.00	-3.70	-3.30	Pass
HT40	MCS0	1	38	5190	0.48	0.43	17.38	17.09		24.00	24.00	-3.70	-3.30	Pass
HT40	MCS0	1	46	5230	0.48	0.43	17.40	17.13		24.00	24.00	-3.70	-3.30	Pass
VHT20	MCS0	1	36	5180	0.24	0.28	18.19	18.04		24.00	24.00	-3.70	-3.30	Pass
VHT20	MCS0	1	44	5220	0.24	0.28	18.12	18.03		24.00	24.00	-3.70	-3.30	Pass
VHT20	MCS0	1	48	5240	0.24	0.28	18.07	17.98		24.00	24.00	-3.70	-3.30	Pass
VHT40	MCS0	1	38	5190	0.43	0.48	17.39	17.14		24.00	24.00	-3.70	-3.30	Pass
VHT40	MCS0	1	46	5230	0.43	0.48	17.41	17.31		24.00	24.00	-3.70	-3.30	Pass
VHT80	MCS0	1	42	5210	0.63	0.67	15.13	15.48		24.00	24.00	-3.70	-3.30	Pass
11a	6Mbps	2	36	5180	0.23	0.23	18.01	17.96	20.99	24.00		-3.30		Pass
11a	6Mbps	2	44	5220	0.23	0.23	18.00	17.95	20.98	24.00		-3.30		Pass
11a	6Mbps	2	48	5240	0.23	0.23	17.98	17.94	20.97	24.00		-3.30		Pass
HT20	MCS0	2	36	5180	0.24	0.25	17.97	17.97	20.98	24.00		-3.30		Pass
HT20	MCS0	2	44	5220	0.24	0.25	17.96	17.95	20.97	24.00		-3.30		Pass
HT20	MCS0	2	48	5240	0.24	0.25	17.94	17.90	20.93	24.00		-3.30		Pass
HT40	MCS0	2	38	5190	0.48	0.48	17.34	17.12	20.24	24.00		-3.30		Pass
HT40	MCS0	2	46	5230	0.48	0.48	17.43	17.39	20.42	24.00		-3.30		Pass
VHT20	MCS0	2	36	5180	0.24	0.24	17.98	17.97	20.99	24.00		-3.30		Pass
VHT20	MCS0	2	44	5220	0.24	0.24	17.97	17.96	20.98	24.00		-3.30		Pass
VHT20	MCS0	2	48	5240	0.24	0.24	17.95	17.94	20.96	24.00		-3.30		Pass
VHT40	MCS0	2	38	5190	0.47	0.43	17.44	17.13	20.30	24.00		-3.30		Pass
VHT40	MCS0	2	46	5230	0.47	0.43	17.55	17.40	20.49	24.00		-3.30		Pass
VHT80	MCS0	2	42	5210	0.67	0.63	15.14	15.63	18.40	24.00		-3.30		Pass

TEST RESULTS DATA
Power Spectral Density

FCC Band I														
Mod.	Data Rate	NTX	CH.	Freq. (MHz)	Duty Factor (dB)		Average Power Density (dBm/MHz)			Average PSD Limit (dBm/MHz)		DG (dBi)		Pass /Fail
					Ant 1	Ant 2	Ant 1	Ant 2	SUM	Ant 1	Ant 2	Ant 1	Ant 2	
11a	6Mbps	2	36	5180	0.23	0.23			8.94	11.00			-0.49	Pass
11a	6Mbps	2	44	5220	0.23	0.23			9.31	11.00			-0.49	Pass
11a	6Mbps	2	48	5240	0.23	0.23			9.20	11.00			-0.49	Pass
HT20	MCS0	2	36	5180	0.24	0.25			9.19	11.00			-0.49	Pass
HT20	MCS0	2	44	5220	0.24	0.25			8.94	11.00			-0.49	Pass
HT20	MCS0	2	48	5240	0.24	0.25			8.84	11.00			-0.49	Pass
HT40	MCS0	2	38	5190	0.48	0.48			4.76	11.00			-0.49	Pass
HT40	MCS0	2	46	5230	0.48	0.48			5.34	11.00			-0.49	Pass
VHT20	MCS0	2	36	5180	0.24	0.24			8.70	11.00			-0.49	Pass
VHT20	MCS0	2	44	5220	0.24	0.24			8.98	11.00			-0.49	Pass
VHT20	MCS0	2	48	5240	0.24	0.24			9.44	11.00			-0.49	Pass
VHT40	MCS0	2	38	5190	0.47	0.43			5.32	11.00			-0.49	Pass
VHT40	MCS0	2	46	5230	0.47	0.43			5.90	11.00			-0.49	Pass
VHT80	MCS0	2	42	5210	0.67	0.63			0.78	11.00			-0.49	Pass

TEST RESULTS DATA
26dB and 99% OBW

Band II															
Mod.	Data Rate	NTX	CH.	Freq. (MHz)	99% Bandwidth (MHz)		26 dB Bandwidth (MHz)		IC 99% Bandwidth Power Limit (dBm)		IC 99% Bandwidth EIRP Limit (dBm)		FCC 26dB Bandwidth Power Limit (dBm)		Note
					Ant 1	Ant 2	Ant 1	Ant 2	Ant 1	Ant 2	Ant 1	Ant 2	Ant 1	Ant 2	
11a	6Mbps	2	52	5260	17.70	17.70	30.15	24.55	23.48		29.48		23.98		
11a	6Mbps	2	60	5300	17.85	17.80	32.90	24.95	23.50		29.50		23.98		
11a	6Mbps	2	64	5320	17.75	17.90	32.80	26.70	23.49		29.49		23.98		
HT20	MCS0	2	52	5260	19.00	18.75	31.90	28.50	23.73		29.73		23.98		
HT20	MCS0	2	60	5300	18.90	18.75	29.75	28.15	23.73		29.73		23.98		
HT20	MCS0	2	64	5320	18.90	18.85	31.90	25.15	23.75		29.75		23.98		
HT40	MCS0	2	54	5270	37.00	36.80	43.56	43.38	23.98		30.00		23.98		
HT40	MCS0	2	62	5310	37.30	37.00	43.56	43.20	23.98		30.00		23.98		
VHT20	MCS0	2	52	5260	18.95	18.75	36.85	30.90	23.73		29.73		23.98		
VHT20	MCS0	2	60	5300	19.00	19.00	36.15	31.35	23.79		29.79		23.98		
VHT20	MCS0	2	64	5320	18.90	18.80	35.55	30.95	23.74		29.74		23.98		
VHT40	MCS0	2	54	5270	37.10	36.90	61.33	43.56	23.98		30.00		23.98		
VHT40	MCS0	2	62	5310	36.90	36.90	43.38	43.20	23.98		30.00		23.98		
VHT80	MCS0	2	58	5290	76.08	76.08	85.12	84.48	23.98		30.00		23.98		

TEST RESULTS DATA
Average Power Table

FCC Band II															
Mod.	Data Rate	NTX	CH.	Freq. (MHz)	Duty Factor (dB)		Average Conducted Power (dBm)			FCC Conducted Power Limit (dBm)		DG (dBi)		EIRP Power Limit (dBm)	Pass/Fail
					Ant 1	Ant 2	Ant 1	Ant 2	SUM	Ant 1	Ant 2	Ant 1	Ant 2		
11a	6Mbps	1	52	5260	0.26	0.23	18.11	17.92		23.98	23.98	-2.40	-3.10	30	Pass
11a	6Mbps	1	60	5300	0.26	0.23	18.16	18.06		23.98	23.98	-2.40	-3.10	30	Pass
11a	6Mbps	1	64	5320	0.26	0.23	18.26	18.13		23.98	23.98	-2.40	-3.10	30	Pass
HT20	MCS0	1	52	5260	0.28	0.25	18.08	17.95		23.98	23.98	-2.40	-3.10	30	Pass
HT20	MCS0	1	60	5300	0.28	0.25	18.10	18.02		23.98	23.98	-2.40	-3.10	30	Pass
HT20	MCS0	1	64	5320	0.28	0.25	18.24	18.05		23.98	23.98	-2.40	-3.10	30	Pass
HT40	MCS0	1	54	5270	0.48	0.43	17.28	17.05		23.98	23.98	-2.40	-3.10	30	Pass
HT40	MCS0	1	62	5310	0.48	0.43	15.28	15.43		23.98	23.98	-2.40	-3.10	30	Pass
VHT20	MCS0	1	52	5260	0.24	0.28	18.09	18.08		23.98	23.98	-2.40	-3.10	30	Pass
VHT20	MCS0	1	60	5300	0.24	0.28	18.11	18.10		23.98	23.98	-2.40	-3.10	30	Pass
VHT20	MCS0	1	64	5320	0.24	0.28	18.25	18.14		23.98	23.98	-2.40	-3.10	30	Pass
VHT40	MCS0	1	54	5270	0.43	0.48	17.29	17.13		23.98	23.98	-2.40	-3.10	30	Pass
VHT40	MCS0	1	62	5310	0.43	0.48	15.23	15.48		23.98	23.98	-2.40	-3.10	30	Pass
VHT80	MCS0	1	58	5290	0.63	0.67	13.80	14.00		23.98	23.98	-2.40	-3.10	30	Pass
11a	6Mbps	2	52	5260	0.23	0.23	18.09	17.93	21.02	23.98		-2.40		30	Pass
11a	6Mbps	2	60	5300	0.23	0.23	18.12	17.97	21.06	23.98		-2.40		30	Pass
11a	6Mbps	2	64	5320	0.23	0.23	18.24	18.07	21.17	23.98		-2.40		30	Pass
HT20	MCS0	2	52	5260	0.24	0.25	18.09	18.01	21.06	23.98		-2.40		30	Pass
HT20	MCS0	2	60	5300	0.24	0.25	18.12	18.05	21.10	23.98		-2.40		30	Pass
HT20	MCS0	2	64	5320	0.24	0.25	18.28	18.08	21.19	23.98		-2.40		30	Pass
HT40	MCS0	2	54	5270	0.48	0.48	17.33	17.19	20.27	23.98		-2.40		30	Pass
HT40	MCS0	2	62	5310	0.48	0.48	15.19	15.78	18.50	23.98		-2.40		30	Pass
VHT20	MCS0	2	52	5260	0.24	0.24	18.11	18.04	21.09	23.98		-2.40		30	Pass
VHT20	MCS0	2	60	5300	0.24	0.24	18.14	18.06	21.11	23.98		-2.40		30	Pass
VHT20	MCS0	2	64	5320	0.24	0.24	18.31	18.10	21.22	23.98		-2.40		30	Pass
VHT40	MCS0	2	54	5270	0.47	0.43	17.39	17.20	20.31	23.98		-2.40		30	Pass
VHT40	MCS0	2	62	5310	0.47	0.43	15.25	15.60	18.44	23.98		-2.40		30	Pass
VHT80	MCS0	2	58	5290	0.67	0.63	13.82	14.10	16.97	23.98		-2.40		30	Pass

TEST RESULTS DATA
Power Spectral Density

Band II														
Mod.	Data Rate	NTX	CH.	Freq. (MHz)	Duty Factor (dB)		Average Power Density (dBm/MHz)			Average PSD Limit (dBm/MHz)		DG (dBi)		Pass /Fail
					Ant 1	Ant 2	Ant 1	Ant 2	SUM	Ant 1	Ant 2	Ant 1	Ant 2	
11a	6Mbps	2	52	5260	0.23	0.23			9.16	11.00	0.27			Pass
11a	6Mbps	2	60	5300	0.23	0.23			9.51	11.00	0.27			Pass
11a	6Mbps	2	64	5320	0.23	0.23			9.75	11.00	0.27			Pass
HT20	MCS0	2	52	5260	0.24	0.25			8.91	11.00	0.27			Pass
HT20	MCS0	2	60	5300	0.24	0.25			8.86	11.00	0.27			Pass
HT20	MCS0	2	64	5320	0.24	0.25			8.88	11.00	0.27			Pass
HT40	MCS0	2	54	5270	0.48	0.48			5.09	11.00	0.27			Pass
HT40	MCS0	2	62	5310	0.48	0.48			3.73	11.00	0.27			Pass
VHT20	MCS0	2	52	5260	0.24	0.24			9.57	11.00	0.27			Pass
VHT20	MCS0	2	60	5300	0.24	0.24			9.15	11.00	0.27			Pass
VHT20	MCS0	2	64	5320	0.24	0.24			9.47	11.00	0.27			Pass
VHT40	MCS0	2	54	5270	0.47	0.43			5.78	11.00	0.27			Pass
VHT40	MCS0	2	62	5310	0.47	0.43			3.55	11.00	0.27			Pass
VHT80	MCS0	2	58	5290	0.67	0.63			-0.80	11.00	0.27			Pass

TEST RESULTS DATA
26dB and 99% OBW

Band III															
Mod.	Data Rate	NTX	CH.	Freq. (MHz)	99% Bandwidth (MHz)		26 dB Bandwidth (MHz)		IC 99% Bandwidth Power Limit (dBm)		IC 99% Bandwidth EIRP Limit (dBm)		FCC 26dB Bandwidth Power Limit (dBm)		Note
					Ant 1	Ant 2	Ant 1	Ant 2	Ant 1	Ant 2	Ant 1	Ant 2	Ant 1	Ant 2	
11a	6Mbps	2	100	5500	17.90	17.95	33.15	35.20	23.53		29.53		23.98		
11a	6Mbps	2	116	5580	17.90	17.75	32.75	27.00	23.49		29.49		23.98		
11a	6Mbps	2	140	5700	17.95	17.80	35.35	32.80	23.50		29.50		23.98		
HT20	MCS0	2	100	5500	19.05	18.85	32.90	30.15	23.75		29.75		23.98		
HT20	MCS0	2	116	5580	18.90	18.90	36.20	28.35	23.76		29.76		23.98		
HT20	MCS0	2	140	5700	19.05	18.85	30.35	31.50	23.75		29.75		23.98		
HT40	MCS0	2	102	5510	36.80	36.90	55.98	43.38	23.98		30.00		23.98		
HT40	MCS0	2	110	5550	37.00	36.80	48.52	43.69	23.98		30.00		23.98		
HT40	MCS0	2	134	5670	37.10	36.80	51.93	43.84	23.98		30.00		23.98		
VHT20	MCS0	2	100	5500	19.00	18.85	38.70	28.70	23.75		29.75		23.98		
VHT20	MCS0	2	116	5580	19.00	18.90	33.40	28.90	23.76		29.76		23.98		
VHT20	MCS0	2	140	5700	18.80	19.00	31.25	28.45	23.74		29.74		23.98		
VHT40	MCS0	2	102	5510	36.90	36.80	57.17	43.38	23.98		30.00		23.98		
VHT40	MCS0	2	110	5550	37.20	36.90	53.87	51.66	23.98		30.00		23.98		
VHT40	MCS0	2	134	5670	36.90	36.90	59.58	52.48	23.98		30.00		23.98		
VHT80	MCS0	2	106	5530	75.96	75.96	85.12	84.48	23.98		30.00		23.98		
VHT80	MCS0	2	122	5610	76.20	75.96	131.84	109.60	23.98		30.00		23.98		

TEST RESULTS DATA
Average Power Table

FCC Band III															
Mod.	Data Rate	NTX	CH.	Freq. (MHz)	Duty Factor (dB)		Average Conducted Power (dBm)			FCC Conducted Power Limit (dBm)		DG (dBi)		EIRP Power Limit (dBm)	Pass/Fail
					Ant 1	Ant 2	Ant 1	Ant 2	SUM	Ant 1	Ant 2	Ant 1	Ant 2		
11a	6Mbps	1	100	5500	0.26	0.23	18.29	18.21		23.98	23.98	-2.40	-3.50	30	Pass
11a	6Mbps	1	116	5580	0.26	0.23	18.21	18.09		23.98	23.98	-2.40	-3.50	30	Pass
11a	6Mbps	1	140	5700	0.26	0.23	17.84	17.74		23.98	23.98	-2.40	-3.50	30	Pass
HT20	MCS0	1	100	5500	0.28	0.25	18.32	18.17		23.98	23.98	-2.40	-3.50	30	Pass
HT20	MCS0	1	116	5580	0.28	0.25	18.25	18.11		23.98	23.98	-2.40	-3.50	30	Pass
HT20	MCS0	1	140	5700	0.28	0.25	16.98	16.98		23.98	23.98	-2.40	-3.50	30	Pass
HT40	MCS0	1	102	5510	0.48	0.43	17.60	17.47		23.98	23.98	-2.40	-3.50	30	Pass
HT40	MCS0	1	110	5550	0.48	0.43	17.45	17.23		23.98	23.98	-2.40	-3.50	30	Pass
HT40	MCS0	1	134	5670	0.48	0.43	17.26	17.15		23.98	23.98	-2.40	-3.50	30	Pass
VHT20	MCS0	1	100	5500	0.24	0.28	18.34	18.29		23.98	23.98	-2.40	-3.50	30	Pass
VHT20	MCS0	1	116	5580	0.24	0.28	18.26	18.20		23.98	23.98	-2.40	-3.50	30	Pass
VHT20	MCS0	1	140	5700	0.24	0.28	16.41	16.83		23.98	23.98	-2.40	-3.50	30	Pass
VHT40	MCS0	1	102	5510	0.43	0.48	17.61	17.48		23.98	23.98	-2.40	-3.50	30	Pass
VHT40	MCS0	1	110	5550	0.43	0.48	17.48	17.28		23.98	23.98	-2.40	-3.50	30	Pass
VHT40	MCS0	1	134	5670	0.43	0.48	17.28	17.23		23.98	23.98	-2.40	-3.50	30	Pass
VHT80	MCS0	1	106	5530	0.63	0.67	15.16	15.42		23.98	23.98	-2.40	-3.50	30	Pass
VHT80	MCS0	1	122	5610	0.63	0.67	18.13	17.98		23.98	23.98	-2.40	-3.50	30	Pass
11a	6Mbps	2	100	5500	0.23	0.23	18.38	18.28	21.34	23.98		-2.40		30	Pass
11a	6Mbps	2	116	5580	0.23	0.23	18.16	18.19	21.18	23.98		-2.40		30	Pass
11a	6Mbps	2	140	5700	0.23	0.23	17.76	17.73	20.75	23.98		-2.40		30	Pass
HT20	MCS0	2	100	5500	0.24	0.25	18.29	18.27	21.29	23.98		-2.40		30	Pass
HT20	MCS0	2	116	5580	0.24	0.25	18.15	18.26	21.22	23.98		-2.40		30	Pass
HT20	MCS0	2	140	5700	0.24	0.25	16.99	17.16	20.09	23.98		-2.40		30	Pass
HT40	MCS0	2	102	5510	0.48	0.48	17.60	17.55	20.58	23.98		-2.40		30	Pass
HT40	MCS0	2	110	5550	0.48	0.48	17.50	17.39	20.45	23.98		-2.40		30	Pass
HT40	MCS0	2	134	5670	0.48	0.48	17.33	17.30	20.32	23.98		-2.40		30	Pass
VHT20	MCS0	2	100	5500	0.24	0.24	18.41	18.39	21.41	23.98		-2.40		30	Pass
VHT20	MCS0	2	116	5580	0.24	0.24	18.21	18.29	21.26	23.98		-2.40		30	Pass
VHT20	MCS0	2	140	5700	0.24	0.24	16.42	16.84	19.65	23.98		-2.40		30	Pass
VHT40	MCS0	2	102	5510	0.47	0.43	17.62	17.56	20.60	23.98		-2.40		30	Pass
VHT40	MCS0	2	110	5550	0.47	0.43	17.54	17.40	20.48	23.98		-2.40		30	Pass
VHT40	MCS0	2	134	5670	0.47	0.43	17.37	17.31	20.35	23.98		-2.40		30	Pass
VHT80	MCS0	2	106	5530	0.67	0.63	15.17	15.56	18.38	23.98		-2.40		30	Pass
VHT80	MCS0	2	122	5610	0.67	0.63	18.22	18.04	21.14	23.98		-2.40		30	Pass

TEST RESULTS DATA
Power Spectral Density

Band III														
Mod.	Data Rate	NTX	CH.	Freq. (MHz)	Duty Factor (dB)		Average Power Density (dBm/MHz)			Average PSD Limit (dBm/MHz)		DG (dBi)		Pass /Fail
					Ant 1	Ant 2	Ant 1	Ant 2	SUM	Ant 1	Ant 2	Ant 1	Ant 2	
11a	6Mbps	2	100	5500	0.23	0.23			10.46	11.00		0.08		Pass
11a	6Mbps	2	116	5580	0.23	0.23			10.55	11.00		0.08		Pass
11a	6Mbps	2	140	5700	0.23	0.23			8.87	11.00		0.08		Pass
HT20	MCS0	2	100	5500	0.24	0.25			10.00	11.00		0.08		Pass
HT20	MCS0	2	116	5580	0.24	0.25			10.14	11.00		0.08		Pass
HT20	MCS0	2	140	5700	0.24	0.25			7.92	11.00		0.08		Pass
HT40	MCS0	2	102	5510	0.48	0.48			6.42	11.00		0.08		Pass
HT40	MCS0	2	110	5550	0.48	0.48			6.60	11.00		0.08		Pass
HT40	MCS0	2	134	5670	0.48	0.48			5.15	11.00		0.08		Pass
VHT20	MCS0	2	100	5500	0.24	0.24			9.99	11.00		0.08		Pass
VHT20	MCS0	2	116	5580	0.24	0.24			10.17	11.00		0.08		Pass
VHT20	MCS0	2	140	5700	0.24	0.24			7.50	11.00		0.08		Pass
VHT40	MCS0	2	102	5510	0.47	0.43			6.44	11.00		0.08		Pass
VHT40	MCS0	2	110	5550	0.47	0.43			6.51	11.00		0.08		Pass
VHT40	MCS0	2	134	5670	0.47	0.43			5.67	11.00		0.08		Pass
VHT80	MCS0	2	106	5530	0.67	0.63			1.71	11.00		0.08		Pass
VHT80	MCS0	2	122	5610	0.67	0.63			4.64	11.00		0.08		Pass

TEST RESULTS DATA
26dB and 99% OBW

Straddle Channel																
Mod.	Data Rate	NTX	CH.	Freq. (MHz)	99% Bandwidth (MHz)		26dB Emission Bandwidth (MHz)		6 dB Emission Bandwidth (MHz)		IC 99% Bandwidth Power Limit (dBm)		IC 99% Bandwidth EIRP Limit (dBm)		FCC 26dB Bandwidth Power Limit (dBm)	
					Ant 1	Ant 2	Ant 1	Ant 2	Ant 1	Ant 2	Ant 1	Ant 2	Ant 1	Ant 2	Ant 1	Ant 2
11a	6Mbps	2	144	5720	18.15	18.15	37.75	25.16	16.30	16.30	-	-	-	-	-	-
				NII-2C	14.1	14.1	23.85	22	13.14	13.14	22.49	28.49	23.98	-	-	
				NII-3	4.05	4.05	13.9	3.16	3.16	3.16	30.00	-	-	-	-	
HT20	MCS0	2	144	5720	19.30	19.30	43.00	26.87	17.28	17.56	-	-	-	-	-	-
				NII-2C	14.7	14.7	26.95	23.35	13.76	13.80	22.67	28.67	23.98	-	-	
				NII-3	4.6	4.6	16.05	3.52	3.52	3.76	30.00	-	-	-	-	
HT40	MCS0	2	142	5710	37.10	37.10	71.78	47.38	36.28	36.28	-	-	-	-	-	-
				NII-2C	33.5	33.5	50.78	44.22	33.12	33.12	23.98	30.00	23.98	-	-	
				NII-3	3.6	3.6	21	3.16	3.16	3.16	30.00	-	-	-	-	
VHT20	MCS0	2	144	5720	19.50	19.50	43.15	26.33	17.16	17.56	-	-	-	-	-	-
				NII-2C	14.8	14.8	27	22.95	13.78	13.80	22.70	28.70	23.98	-	-	
				NII-3	4.7	4.7	16.15	3.38	3.38	3.76	30.00	-	-	-	-	
VHT40	MCS0	2	142	5710	37.10	37.10	66.42	46.87	36.32	36.28	-	-	-	-	-	-
				NII-2C	33.5	33.5	44.88	43.71	33.16	33.12	23.98	30.00	23.98	-	-	
				NII-3	3.6	3.6	21.54	3.16	3.16	3.16	30.00	-	-	-	-	
VHT80	MCS0	2	138	5690	76.56	76.20	162.62	91.04	75.28	76.00	-	-	-	-	-	-
				NII-2C	73.28	73.16	116.82	88.28	72.52	73.06	23.98	30.00	23.98	-	-	
				NII-3	3.28	3.04	45.8	2.76	2.76	2.94	30.00	-	-	-	-	

TEST RESULTS DATA
Average Power Table

FCC Straddle Channel														
Mod.	Data Rate	NTX	CH.	Freq. (MHz)	Duty Factor (dB)		Average Conducted Power (dBm)			FCC Conducted Power Limit (dBm)		DG (dBi)		Pass/Fail
					Ant 1	Ant 2	Ant 1	Ant 2	SUM	Ant 1	Ant 2	Ant 1	Ant 2	
11a	6Mbps	1	144	5720	0.26	0.23	18.25	17.74		-	-	-2.40	-3.50	-
				NII-2C	0.26	0.23	17.30	16.76		23.98	23.98	-2.40	-3.50	Pass
				NII-3	0.26	0.23	11.18	10.81		30.00	30.00	-2.40	-3.50	Pass
HT20	MCS0	1	144	5720	0.28	0.25	18.16	17.77		-	-	-2.40	-3.50	-
				NII-2C	0.28	0.25	17.10	16.72		23.98	23.98	-2.40	-3.50	Pass
				NII-3	0.28	0.25	11.50	11.09		30.00	30.00	-2.40	-3.50	Pass
HT40	MCS0	1	142	5710	0.48	0.43	17.15	16.82		-	-	-2.40	-3.50	-
				NII-2C	0.48	0.43	16.73	16.39		23.98	23.98	-2.40	-3.50	Pass
				NII-3	0.48	0.43	6.80	6.56		30.00	30.00	-2.40	-3.50	Pass
VHT20	MCS0	1	144	5720	0.24	0.28	17.88	17.73		-	-	-2.40	-3.50	-
				NII-2C	0.24	0.28	16.81	16.66		23.98	23.98	-2.40	-3.50	Pass
				NII-3	0.24	0.28	11.27	11.13		30.00	30.00	-2.40	-3.50	Pass
VHT40	MCS0	1	142	5710	0.43	0.48	17.17	16.75		-	-	-2.40	-3.50	-
				NII-2C	0.43	0.48	16.76	16.33		23.98	23.98	-2.40	-3.50	Pass
				NII-3	0.43	0.48	6.75	6.40		30.00	30.00	-2.40	-3.50	Pass
VHT80	MCS0	1	138	5690	0.63	0.67	18.25	18.00		-	-	-2.40	-3.50	-
				NII-2C	0.63	0.67	18.07	17.83		23.98	23.98	-2.40	-3.50	Pass
				NII-3	0.63	0.67	4.23	3.77		30.00	30.00	-2.40	-3.50	Pass
11a	6Mbps	2	144	5720	0.23	0.23	17.91	17.85	20.89	-	-	-2.40	-	-
				NII-2C	0.23	0.23	17.01	16.89	19.96	23.98	-	-2.40	-	Pass
				NII-3	0.23	0.23	10.64	10.83	13.75	30.00	-	-2.40	-	Pass
HT20	MCS0	2	144	5720	0.24	0.25	18.10	17.85	20.99	-	-	-2.40	-	-
				NII-2C	0.24	0.25	17.17	16.80	20.00	23.98	-	-2.40	-	Pass
				NII-3	0.24	0.25	10.95	11.18	14.08	30.00	-	-2.40	-	Pass
HT40	MCS0	2	142	5710	0.48	0.48	17.07	16.82	19.96	-	-	-2.40	-	-
				NII-2C	0.48	0.48	16.67	16.40	19.55	23.98	-	-2.40	-	Pass
				NII-3	0.48	0.48	6.48	6.50	9.50	30.00	-	-2.40	-	Pass
VHT20	MCS0	2	144	5720	0.24	0.24	18.06	17.69	20.89	-	-	-2.40	-	-
				NII-2C	0.24	0.24	17.14	16.63	19.90	23.98	-	-2.40	-	Pass
				NII-3	0.24	0.24	10.86	11.03	13.96	30.00	-	-2.40	-	Pass
VHT40	MCS0	2	142	5710	0.47	0.43	17.09	16.74	19.93	-	-	-2.40	-	-
				NII-2C	0.47	0.43	16.64	16.32	19.49	23.98	-	-2.40	-	Pass
				NII-3	0.47	0.43	7.07	6.38	9.75	30.00	-	-2.40	-	Pass
VHT80	MCS0	2	138	5690	0.67	0.63	18.33	17.85	21.11	-	-	-2.40	-	-
				NII-2C	0.67	0.63	18.15	17.67	20.93	23.98	-	-2.40	-	Pass
				NII-3	0.67	0.63	4.47	3.86	7.19	30.00	-	-2.40	-	Pass

TEST RESULTS DATA
Power Spectral Density

Straddle Channel														
Mod.	Data Rate	NTX	CH.	Freq. (MHz)	Duty Factor (dB)		Average Power Density (dBm/MHz)			Average PSD Limit (dBm/MHz)		DG (dBi)		Pass /Fail
					Ant 1	Ant 2	Ant 1	Ant 2	SUM	Ant 1	Ant 2	Ant 1	Ant 2	
11a	6Mbps	2	144	NII-2C	0.23	0.23				9.19	11.00	0.08		Pass
				NII-3	0.23	0.23				9.19	30.00	0.08		Pass
HT20	MCS0	2	144	NII-2C	0.24	0.25				8.92	11.00	0.08		Pass
				NII-3	0.24	0.25				8.92	30.00	0.08		Pass
HT40	MCS0	2	142	NII-2C	0.48	0.48				5.47	11.00	0.08		Pass
				NII-3	0.48	0.48				5.47	30.00	0.08		Pass
VHT20	MCS0	2	144	NII-2C	0.24	0.24				8.97	11.00	0.08		Pass
				NII-3	0.24	0.24				8.97	30.00	0.08		Pass
VHT40	MCS0	2	142	NII-2C	0.47	0.43				5.46	11.00	0.08		Pass
				NII-3	0.47	0.43				5.46	30.00	0.08		Pass
VHT80	MCS0	2	138	NII-2C	0.67	0.63				3.29	11.00	0.08		Pass
				NII-3	0.67	0.63				3.29	30.00	0.08		Pass

TEST RESULTS DATA
Frequency Stability

Band I										
Mod.	Data Rate	NTX	CH.	Freq. (MHz)	Center Frequency (MHz)	Frequency Deviation (MHz)	Frequency Stability (ppm)	Temperature (°C)	Voltage (V)	Note
11a	6Mbps	1	36	5180	5179.950	-0.050	-9.65	50	3.8	
11a	6Mbps	1	36	5180	5180.000	0.000	0.00	-30	3.8	
11a	6Mbps	1	36	5180	5180.000	0.000	0.00	20	4.35	
11a	6Mbps	1	36	5180	5180.000	0.000	0.00	20	3.4	
11a	6Mbps	1	36	5180	5179.975	-0.025	-4.83	20	3.8	

Band II										
Mod.	Data Rate	NTX	CH.	Freq. (MHz)	Center Frequency (MHz)	Frequency Deviation (MHz)	Frequency Stability (ppm)	Temperature (°C)	Voltage (V)	Note
11a	6Mbps	1	64	5320	5319.950	-0.050	-9.40	50	3.8	
11a	6Mbps	1	64	5320	5320.000	0.000	0.00	-30	3.8	
11a	6Mbps	1	64	5320	5320.000	0.000	0.00	20	4.35	
11a	6Mbps	1	64	5320	5319.950	-0.050	-9.40	20	3.4	
11a	6Mbps	1	64	5320	5320.000	0.000	0.00	20	3.8	

Band III										
Mod.	Data Rate	NTX	CH.	Freq. (MHz)	Center Frequency (MHz)	Frequency Deviation (MHz)	Frequency Stability (ppm)	Temperature (°C)	Voltage (V)	Note
11a	6Mbps	1	100	5500	5499.950	-0.050	-9.09	50	3.8	
11a	6Mbps	1	100	5500	5500.000	0.000	0.00	-30	3.8	
11a	6Mbps	1	100	5500	5500.000	0.000	0.00	20	4.35	
11a	6Mbps	1	100	5500	5500.025	0.025	4.55	20	3.4	
11a	6Mbps	1	100	5500	5500.000	0.000	0.00	20	3.8	



Appendix B. Radiated Spurious Emission

Test Engineer :	J.C. Liang, Jacky Hung, and Kan Wu	Temperature :	18~22°C
		Relative Humidity :	55~58%

Band 1 - 5150~5250MHz

WIFI 802.11a (Band Edge @ 3m)

WIFI	Note	Frequency	Level	Over	Limit	Read	Antenna	Cable	Preamp	Ant	Table	Peak	Pol.	
Ant.				Limit	Line	Level	Factor	Loss	Factor	Pos	Pos	Avg.		
1+2		(MHz)	(dBμV/m)	(dB)	(dBμV/m)	(dBμV)	(dB/m)	(dB)	(dB)	(cm)	(deg)	(P/A)	(H/V)	
802.11a CH 36 5180MHz		5148.98	54.27	-19.73	74	46.2	32.05	9.05	33.03	227	116	P	H	
		5150	49.36	-4.64	54	41.29	32.05	9.05	33.03	227	116	A	H	
	*	5180	109.45	-	-	101.32	32.08	9.08	33.03	227	116	P	H	
	*	5180	99.38	-	-	91.25	32.08	9.08	33.03	227	116	A	H	
													H	
														H
			5147.16	57.13	-16.87	74	49.06	32.05	9.05	33.03	100	117	P	V
			5147.42	46.55	-7.45	54	38.48	32.05	9.05	33.03	100	117	A	V
	*		5180	108.17	-	-	100.04	32.08	9.08	33.03	100	117	P	V
	*		5180	98.63	-	-	90.5	32.08	9.08	33.03	100	117	A	V
														V
														V
802.11a CH 44 5220MHz		5130.78	50.56	-23.44	74	42.53	32.03	9.03	33.03	223	116	P	H	
		5148.72	41.3	-12.7	54	33.23	32.05	9.05	33.03	223	116	A	H	
	*	5220	109.47	-	-	101.28	32.12	9.1	33.03	223	116	P	H	
	*	5220	100.28	-	-	92.09	32.12	9.1	33.03	223	116	A	H	
			5416.88	49.59	-24.41	74	41.05	32.32	9.24	33.02	223	116	P	H
			5452.72	41.24	-12.76	54	32.62	32.35	9.29	33.02	223	116	A	H
			5063.96	49.8	-24.2	74	41.9	31.97	8.97	33.04	115	116	P	V
			5143	40.78	-13.22	54	32.71	32.05	9.05	33.03	115	116	A	V
	*		5220	107.39	-	-	99.2	32.12	9.1	33.03	115	116	P	V
	*		5220	98.42	-	-	90.23	32.12	9.1	33.03	115	116	A	V
			5443.76	49.06	-24.94	74	40.48	32.33	9.27	33.02	115	116	P	V
			5449.08	40.44	-13.56	54	31.82	32.35	9.29	33.02	115	116	A	V



802.11a CH 48 5240MHz		5061.36	49.51	-24.49	74	41.61	31.97	8.97	33.04	223	116	P	H
		5125.58	41.07	-12.93	54	33.04	32.03	9.03	33.03	223	116	A	H
	*	5240	109.03	-	-	100.82	32.13	9.11	33.03	223	116	P	H
	*	5240	99.87	-	-	91.66	32.13	9.11	33.03	223	116	A	H
		5358.92	49.52	-24.48	74	41.1	32.25	9.2	33.03	223	116	P	H
		5452.72	41.13	-12.87	54	32.51	32.35	9.29	33.02	223	116	A	H
		5054.86	49.36	-24.64	74	41.46	31.97	8.97	33.04	100	116	P	V
		5060.84	40.57	-13.43	54	32.67	31.97	8.97	33.04	100	116	A	V
	*	5240	108.4	-	-	100.19	32.13	9.11	33.03	100	116	P	V
	*	5240	98.51	-	-	90.3	32.13	9.11	33.03	100	116	A	V
		5448.8	48.8	-25.2	74	40.18	32.35	9.29	33.02	100	116	P	V
		5451.88	40.44	-13.56	54	31.82	32.35	9.29	33.02	100	116	A	V
Remark	<ol style="list-style-type: none"> 1. No other spurious found. 2. All results are PASS against Peak and Average limit line. 												



Band 1 5150~5250MHz
WIFI 802.11a (Harmonic @ 3m)

WIFI Ant. 1+2	Note	Frequency (MHz)	Level (dBμV/m)	Over Limit (dB)	Limit Line (dBμV/m)	Read Level (dBμV)	Antenna Factor (dB/m)	Cable Loss (dB)	Preamp Factor (dB)	Ant Pos (cm)	Table Pos (deg)	Peak Avg. (P/A)	Pol. (H/V)
802.11a CH 36 5180MHz		10360	49.84	-24.16	74	61.37	38.41	14.95	65.2	100	0	P	H
		15540	60.93	-13.07	74	68.25	37.58	18.69	63.98	265	68	P	H
		15540	50.8	-3.2	54	58.12	37.58	18.69	63.98	265	68	A	H
													H
		10360	47.41	-26.59	74	59.25	38.41	14.95	65.2	100	0	P	V
		15540	57.42	-16.58	74	64.74	37.58	18.69	63.98	187	166	P	V
		15540	46.56	-7.44	54	53.88	37.58	18.69	63.98	187	166	A	V
													V
802.11a CH 44 5220MHz		10440	50.66	-23.34	74	62.04	38.51	15	65.2	100	0	P	H
		15660	59.98	-14.02	74	67.93	37.14	18.8	64.24	264	32	P	H
		15660	48.7	-5.3	54	56.65	37.14	18.8	64.24	264	32	A	H
													H
		10440	47.9	-26.1	74	59.59	38.51	15	65.2	100	0	P	V
		15660	60.36	-13.64	74	68.31	37.14	18.8	64.24	204	216	P	V
		15660	48.91	-5.09	54	56.86	37.14	18.8	64.24	204	216	A	V
													V
802.11a CH 48 5240MHz		10480	50.79	-23.21	74	62.06	38.58	15.04	65.2	100	0	P	H
		15720	61.59	-12.41	74	69.91	36.89	18.85	64.39	255	42	P	H
		15720	50.83	-3.17	54	59.15	36.89	18.85	64.39	255	42	A	H
													H
		10480	47.95	-26.05	74	59.53	38.58	15.04	65.2	100	0	P	V
		15720	60.09	-13.91	74	68.41	36.89	18.85	64.39	199	235	P	V
		15720	50.23	-3.77	54	58.55	36.89	18.85	64.39	199	235	A	V
													V
Remark	1. No other spurious found. 2. All results are PASS against Peak and Average limit line.												



Band 1 5150~5250MHz
WIFI 802.11n HT20 (Band Edge @ 3m)

WIFI Ant. 1+2	Note	Frequency (MHz)	Level (dBμV/m)	Over Limit (dB)	Limit Line (dBμV/m)	Read Level (dBμV)	Antenna Factor (dB/m)	Cable Loss (dB)	Preamp Factor (dB)	Ant Pos (cm)	Table Pos (deg)	Peak Avg. (P/A)	Pol. (H/V)	
802.11n HT20 CH 36 5180MHz		5148.98	60.33	-13.67	74	52.26	32.05	9.05	33.03	227	116	P	H	
		5150	48.4	-5.6	54	40.33	32.05	9.05	33.03	227	116	A	H	
	*	5180	108.87	-	-	100.74	32.08	9.08	33.03	227	116	P	H	
	*	5180	99.33	-	-	91.2	32.08	9.08	33.03	227	116	A	H	
													H	
														H
			5148.72	61.29	-12.71	74	53.22	32.05	9.05	33.03	100	117	P	V
			5150	49.03	-4.97	54	40.96	32.05	9.05	33.03	100	117	A	V
		*	5180	107.04	-	-	98.91	32.08	9.08	33.03	100	117	P	V
		*	5180	98.11	-	-	89.98	32.08	9.08	33.03	100	117	A	V
													V	
													V	
802.11n HT20 CH 44 5220MHz		5020.02	50.3	-23.7	74	42.47	31.92	8.95	33.04	223	117	P	H	
		5149.76	41.5	-12.5	54	33.43	32.05	9.05	33.03	223	117	A	H	
		*	5220	109.82	-	-	101.63	32.12	9.1	33.03	223	117	P	H
		*	5220	100.25	-	-	92.06	32.12	9.1	33.03	223	117	A	H
			5454.12	49.53	-24.47	74	40.91	32.35	9.29	33.02	223	117	P	H
			5452.72	41.16	-12.84	54	32.54	32.35	9.29	33.02	223	117	A	H
			5028.86	49.86	-24.14	74	42.02	31.93	8.95	33.04	115	117	P	V
			5145.08	40.84	-13.16	54	32.77	32.05	9.05	33.03	115	117	A	V
		*	5220	108.12	-	-	99.93	32.12	9.1	33.03	115	117	P	V
		*	5220	98.42	-	-	90.23	32.12	9.1	33.03	115	117	A	V
		5436.48	49.34	-24.66	74	40.76	32.33	9.27	33.02	115	117	P	V	
		5433.4	40.51	-13.49	54	31.93	32.33	9.27	33.02	115	117	A	V	



802.11n HT20 CH 48 5240MHz		5061.36	49.51	-24.49	74	41.61	31.97	8.97	33.04	223	116	P	H
		5125.58	41.07	-12.93	54	33.04	32.03	9.03	33.03	223	116	A	H
	*	5240	109.03	-	-	100.82	32.13	9.11	33.03	223	116	P	H
	*	5240	99.87	-	-	91.66	32.13	9.11	33.03	223	116	A	H
		5358.92	49.52	-24.48	74	41.1	32.25	9.2	33.03	223	116	P	H
		5452.72	41.13	-12.87	54	32.51	32.35	9.29	33.02	223	116	A	H
		5054.86	49.36	-24.64	74	41.46	31.97	8.97	33.04	100	116	P	V
		5060.84	40.57	-13.43	54	32.67	31.97	8.97	33.04	100	116	A	V
	*	5240	108.4	-	-	100.19	32.13	9.11	33.03	100	116	P	V
	*	5240	98.51	-	-	90.3	32.13	9.11	33.03	100	116	A	V
		5448.8	48.8	-25.2	74	40.18	32.35	9.29	33.02	100	116	P	V
		5451.88	40.44	-13.56	54	31.82	32.35	9.29	33.02	100	116	A	V
Remark	<ol style="list-style-type: none"> No other spurious found. All results are PASS against Peak and Average limit line. 												



Band 1 5150~5250MHz
WIFI 802.11n HT20 (Harmonic @ 3m)

WIFI Ant. 1+2	Note	Frequency (MHz)	Level (dBμV/m)	Over Limit (dB)	Limit Line (dBμV/m)	Read Level (dBμV)	Antenna Factor (dB/m)	Cable Loss (dB)	Preamp Factor (dB)	Ant Pos (cm)	Table Pos (deg)	Peak Avg. (P/A)	Pol. (H/V)
802.11n HT20 CH 36 5180MHz		10360	50.95	-23.05	74	62.48	38.41	14.95	65.2	100	0	P	H
		15540	62.85	-11.15	74	70.17	37.58	18.69	63.98	200	123	P	H
		15540	52.35	-1.65	54	59.67	37.58	18.69	63.98	200	123	A	H
													H
		10360	47.3	-26.7	74	58.83	38.41	14.95	65.2	100	0	P	V
		15540	62.41	-11.59	74	69.73	37.58	18.69	63.98	200	223	P	V
		15540	50.63	-3.37	54	57.95	37.58	18.69	63.98	200	223	A	V
													V
802.11n HT20 CH 44 5220MHz		10440	49.13	-24.87	74	60.51	38.51	15	65.2	100	0	P	H
		15660	61.65	-12.35	74	69.6	37.14	18.8	64.24	205	171	P	H
		15660	50.47	-3.53	54	58.42	37.14	18.8	64.24	205	171	A	H
													H
		10440	48.78	-25.22	74	60.16	38.51	15	65.2	100	0	P	V
		15660	59.28	-14.72	74	67.23	37.14	18.8	64.24	200	228	P	V
		15660	49.29	-4.71	54	57.24	37.14	18.8	64.24	200	228	A	V
													V
802.11n HT20 CH 48 5240MHz		10480	50.83	-23.17	74	62.1	38.58	15.04	65.2	100	0	P	H
		15720	59.73	-14.27	74	68.05	36.89	18.85	64.39	200	163	P	H
		15720	48.02	-5.98	54	56.34	36.89	18.85	64.39	200	163	A	H
													H
		10480	47.63	-26.37	74	58.9	38.58	15.04	65.2	100	0	P	V
		15720	59.53	-14.47	74	67.85	36.89	18.85	64.39	200	236	P	V
		15720	47.81	-6.19	54	56.13	36.89	18.85	64.39	200	236	A	V
													V
Remark	1. No other spurious found. 2. All results are PASS against Peak and Average limit line.												



Band 1 5150~5250MHz
WIFI 802.11n HT40 (Band Edge @ 3m)

WIFI Ant. 1+2	Note	Frequency (MHz)	Level (dBμV/m)	Over Limit (dB)	Limit Line (dBμV/m)	Read Level (dBμV)	Antenna Factor (dB/m)	Cable Loss (dB)	Preamp Factor (dB)	Ant Pos (cm)	Table Pos (deg)	Peak Avg. (P/A)	Pol. (H/V)	
802.11n HT40 CH 38 5190MHz		5149.76	62.2	-11.8	74	54.13	32.05	9.05	33.03	213	117	P	H	
		5150	53.31	-0.69	54	45.24	32.05	9.05	33.03	213	117	A	H	
	*	5190	105.38	-	-	97.25	32.08	9.08	33.03	213	117	P	H	
	*	5190	96.81	-	-	88.68	32.08	9.08	33.03	213	117	A	H	
		5384.4	50.11	-23.89	74	41.64	32.28	9.21	33.02	213	117	P	H	
		5407.36	41.52	-12.48	54	33.02	32.3	9.22	33.02	213	117	A	H	
		5150	58.76	-15.24	74	50.69	32.05	9.05	33.03	230	119	P	V	
		5146.12	52.13	-1.87	54	44.06	32.05	9.05	33.03	230	119	A	V	
	*	5190	104.64	-	-	96.51	32.08	9.08	33.03	230	119	P	V	
	*	5190	96.24	-	-	88.11	32.08	9.08	33.03	230	119	A	V	
		5446.56	48.65	-25.35	74	40.05	32.35	9.27	33.02	230	119	P	V	
		5453.56	40.95	-13.05	54	32.33	32.35	9.29	33.02	230	119	A	V	
802.11n HT40 CH 46 5230MHz		5144.56	50.74	-23.26	74	42.67	32.05	9.05	33.03	223	118	P	H	
		5147.68	43.35	-10.65	54	35.28	32.05	9.05	33.03	223	118	A	H	
	*	5230	106.24	-	-	98.04	32.13	9.1	33.03	223	118	P	H	
	*	5230	99.33	-	-	91.13	32.13	9.1	33.03	223	118	A	H	
		5366.48	49.31	-24.69	74	40.87	32.27	9.2	33.03	223	118	P	H	
		5356.12	42.04	-11.96	54	33.63	32.25	9.19	33.03	223	118	A	H	
														H
		5148.46	49.85	-24.15	74	41.78	32.05	9.05	33.03	214	118	P	V	
		5148.2	42.63	-11.37	54	34.56	32.05	9.05	33.03	214	118	A	V	
	*	5230	103.45	-	-	95.25	32.13	9.1	33.03	214	118	P	V	
	*	5230	96.49	-	-	88.29	32.13	9.1	33.03	214	118	A	V	
		5350.24	50.25	-23.75	74	41.84	32.25	9.19	33.03	214	118	P	V	
	5354.44	41.38	-12.62	54	32.97	32.25	9.19	33.03	214	118	A	V		
Remark	1. No other spurious found. 2. All results are PASS against Peak and Average limit line.													



Band 1 5150~5250MHz
WIFI 802.11n HT40 (Harmonic @ 3m)

WIFI Ant. 1+2	Note	Frequency (MHz)	Level (dBμV/m)	Over Limit (dB)	Limit Line (dBμV/m)	Read Level (dBμV)	Antenna Factor (dB/m)	Cable Loss (dB)	Preamp Factor (dB)	Ant Pos (cm)	Table Pos (deg)	Peak Avg. (P/A)	Pol. (H/V)
802.11n HT40 CH 38 5190MHz		10380	49.13	-24.87	74	60.62	38.44	14.96	65.2	100	0	P	H
		15570	56.15	-17.85	74	63.65	37.45	18.72	64.05	199	123	P	H
		15570	47.11	-6.89	54	54.61	37.45	18.72	64.05	199	123	A	H
													H
		10380	46.98	-27.02	74	58.78	38.44	14.96	65.2	100	0	P	V
		15570	54.81	-19.19	74	62.31	37.45	18.72	64.05	195	225	P	V
		15570	44.88	-9.12	54	52.38	37.45	18.72	64.05	195	225	A	V
													V
802.11n HT40 CH 46 5230MHz		10460	49.59	-24.41	74	60.94	38.53	15.01	65.2	100	0	P	H
		15690	55.57	-18.43	74	63.71	37.02	18.82	64.32	211	128	P	H
		15690	45.86	-8.14	54	54	37.02	18.82	64.32	211	128	A	H
													H
		10460	46.89	-27.11	74	58.55	38.53	15.01	65.2	100	0	P	V
		15690	54.6	-19.4	74	62.74	37.02	18.82	64.32	199	248	P	V
		15690	44.42	-9.58	54	52.56	37.02	18.82	64.32	199	248	A	V
													V
Remark	1. No other spurious found. 2. All results are PASS against Peak and Average limit line.												



Band 1 5150~5250MHz
WIFI 802.11ac VHT20 (Band Edge @ 3m)

WIFI Ant. 1+2	Note	Frequency (MHz)	Level (dBμV/m)	Over Limit (dB)	Limit Line (dBμV/m)	Read Level (dBμV)	Antenna Factor (dB/m)	Cable Loss (dB)	Preamp Factor (dB)	Ant Pos (cm)	Table Pos (deg)	Peak Avg. (P/A)	Pol. (H/V)	
802.11ac VHT20 CH 36 5180MHz		5148.46	59.19	-14.81	74	51.12	32.05	9.05	33.03	100	115	P	H	
		5150	48.6	-5.4	54	40.53	32.05	9.05	33.03	100	115	A	H	
	*	5180	108.95	-	-	100.82	32.08	9.08	33.03	100	115	P	H	
	*	5180	99.17	-	-	91.04	32.08	9.08	33.03	100	115	A	H	
													H	
														H
			5144.04	53.7	-20.3	74	45.63	32.05	9.05	33.03	100	115	P	V
			5145.34	44.88	-9.12	54	36.81	32.05	9.05	33.03	100	115	A	V
		*	5180	107.37	-	-	99.24	32.08	9.08	33.03	100	115	P	V
		*	5180	98.03	-	-	89.9	32.08	9.08	33.03	100	115	A	V
													V	
													V	
802.11ac VHT20 CH 44 5220MHz		5137.02	50.22	-23.78	74	42.19	32.03	9.03	33.03	224	115	P	H	
		5148.46	41.17	-12.83	54	33.1	32.05	9.05	33.03	224	115	A	H	
	*	5220	110.31	-	-	102.12	32.12	9.1	33.03	224	115	P	H	
	*	5220	100.22	-	-	92.03	32.12	9.1	33.03	224	115	A	H	
			5408.76	49.14	-24.86	74	40.64	32.3	9.22	33.02	224	115	P	H
			5452.72	40.9	-13.1	54	32.28	32.35	9.29	33.02	224	115	A	H
			5119.34	50.05	-23.95	74	42.04	32.02	9.02	33.03	100	115	P	V
			5149.24	41.12	-12.88	54	33.05	32.05	9.05	33.03	100	115	A	V
		*	5220	107.45	-	-	99.26	32.12	9.1	33.03	100	115	P	V
		*	5220	97.74	-	-	89.55	32.12	9.1	33.03	100	115	A	V
		5388.6	49.02	-24.98	74	40.55	32.28	9.21	33.02	100	115	P	V	
		5452.72	40.52	-13.48	54	31.9	32.35	9.29	33.02	100	115	A	V	



802.11ac VHT20 CH 48 5240MHz		5038.74	49.75	-24.25	74	41.88	31.95	8.96	33.04	224	115	P	H
		5054.6	40.78	-13.22	54	32.88	31.97	8.97	33.04	224	115	A	H
	*	5240	109.43	-	-	101.22	32.13	9.11	33.03	224	115	P	H
	*	5240	99.92	-	-	91.71	32.13	9.11	33.03	224	115	A	H
		5376	49.19	-24.81	74	40.74	32.27	9.2	33.02	224	115	P	H
		5452.72	41	-13	54	32.38	32.35	9.29	33.02	224	115	A	H
		5113.1	49.68	-24.32	74	41.68	32.02	9.02	33.04	100	115	P	V
		5060.58	40.67	-13.33	54	32.77	31.97	8.97	33.04	100	115	A	V
	*	5240	108.43	-	-	100.22	32.13	9.11	33.03	100	115	P	V
	*	5240	98.27	-	-	90.06	32.13	9.11	33.03	100	115	A	V
		5449.08	50.2	-23.8	74	41.58	32.35	9.29	33.02	100	115	P	V
		5434.24	40.6	-13.4	54	32.02	32.33	9.27	33.02	100	115	A	V
Remark	1. No other spurious found. 2. All results are PASS against Peak and Average limit line.												



Band 1 5150~5250MHz
WIFI 802.11ac VHT20 (Harmonic @ 3m)

WIFI Ant. 1+2	Note	Frequency (MHz)	Level (dBμV/m)	Over Limit (dB)	Limit Line (dBμV/m)	Read Level (dBμV)	Antenna Factor (dB/m)	Cable Loss (dB)	Preamp Factor (dB)	Ant Pos (cm)	Table Pos (deg)	Peak Avg. (P/A)	Pol. (H/V)	
802.11ac VHT20 CH 36 5180MHz		10360	52.28	-21.72	74	63.81	38.41	14.95	65.2	100	0	P	H	
		15540	60.93	-13.07	74	68.25	37.58	18.69	63.98	231	219	P	H	
		15540	48.65	-5.35	54	55.97	37.58	18.69	63.98	231	219	A	H	
													H	
			10360	49.34	-24.66	74	61.18	38.41	14.95	65.2	100	0	P	V
			15540	58.47	-15.53	74	65.79	37.58	18.69	63.98	106	14	P	V
			15540	47.01	-6.99	54	54.33	37.58	18.69	63.98	106	14	A	V
													V	
802.11ac VHT20 CH 44 5220MHz		10440	50.88	-23.12	74	62.26	38.51	15	65.2	100	0	P	H	
		15660	61.16	-12.84	74	69.11	37.14	18.8	64.24	221	187	P	H	
		15660	49.18	-4.82	54	57.13	37.14	18.8	64.24	221	187	A	H	
													H	
			10440	47.65	-26.35	74	59.34	38.51	15	65.2	100	0	P	V
			15660	60.19	-13.81	74	68.14	37.14	18.8	64.24	100	28	P	V
			15660	47.29	-6.71	54	55.24	37.14	18.8	64.24	100	28	A	V
													V	
802.11ac VHT20 CH 48 5240MHz		10480	57.09	-16.91	74	68.36	38.58	15.04	65.2	251	177	P	H	
		10480	45.9	-8.1	54	57.17	38.58	15.04	65.2	251	177	A	H	
		15720	60.69	-13.31	74	69.01	36.89	18.85	64.39	244	170	P	H	
		15720	47.89	-6.11	54	56.21	36.89	18.85	64.39	244	170	A	H	
			10480	48.68	-25.32	74	60.26	38.58	15.04	65.2	100	0	P	V
			15720	60.59	-13.41	74	68.91	36.89	18.85	64.39	199	237	P	V
			15720	48.4	-5.6	54	56.72	36.89	18.85	64.39	199	237	A	V
													V	
Remark	1. No other spurious found. 2. All results are PASS against Peak and Average limit line.													



Band 1 5150~5250MHz
WIFI 802.11ac VHT40 (Band Edge @ 3m)

WIFI Ant. 1+2	Note	Frequency (MHz)	Level (dBμV/m)	Over Limit (dB)	Limit Line (dBμV/m)	Read Level (dBμV)	Antenna Factor (dB/m)	Cable Loss (dB)	Preamp Factor (dB)	Ant Pos (cm)	Table Pos (deg)	Peak Avg. (P/A)	Pol. (H/V)
802.11ac VHT40 CH 38 5190MHz		5149.24	59.78	-14.22	74	51.71	32.05	9.05	33.03	213	117	P	H
		5149.5	53.12	-0.88	54	45.05	32.05	9.05	33.03	213	117	A	H
	*	5190	104.97	-	-	96.84	32.08	9.08	33.03	213	117	P	H
	*	5190	97.86	-	-	89.73	32.08	9.08	33.03	213	117	A	H
		5356.12	50.01	-23.99	74	41.6	32.25	9.19	33.03	213	117	P	H
		5452.72	41.59	-12.41	54	32.97	32.35	9.29	33.02	213	117	A	H
		5135.2	57.2	-16.8	74	49.17	32.03	9.03	33.03	231	118	P	V
		5149.76	50.62	-3.38	54	42.55	32.05	9.05	33.03	231	118	A	V
	*	5190	104.32	-	-	96.19	32.08	9.08	33.03	231	118	P	V
	*	5190	97.28	-	-	89.15	32.08	9.08	33.03	231	118	A	V
		5397.84	48.48	-25.52	74	39.98	32.3	9.22	33.02	231	118	P	V
		5413.8	41.92	-12.08	54	33.38	32.32	9.24	33.02	231	118	A	V
802.11ac VHT40 CH 46 5230MHz		5088.92	51.01	-22.99	74	43.05	32	9	33.04	216	117	P	H
		5147.94	43.12	-10.88	54	35.05	32.05	9.05	33.03	216	117	A	H
	*	5230	106.78	-	-	98.58	32.13	9.1	33.03	216	117	P	H
	*	5230	99.59	-	-	91.39	32.13	9.1	33.03	216	117	A	H
		5410.44	50.32	-23.68	74	41.82	32.3	9.22	33.02	216	117	P	H
		5355.84	42.19	-11.81	54	33.78	32.25	9.19	33.03	216	117	A	H
		5095.42	50.78	-23.22	74	42.82	32	9	33.04	215	118	P	V
		5138.06	42.25	-11.75	54	34.22	32.03	9.03	33.03	215	118	A	V
	*	5230	104.64	-	-	96.44	32.13	9.1	33.03	215	118	P	V
	*	5230	97.75	-	-	89.55	32.13	9.1	33.03	215	118	A	V
	5444.6	49.53	-24.47	74	40.95	32.33	9.27	33.02	215	118	P	V	
	5351.64	41.22	-12.78	54	32.81	32.25	9.19	33.03	215	118	A	V	
Remark	1. No other spurious found. 2. All results are PASS against Peak and Average limit line.												



Band 1 5150~5250MHz
WIFI 802.11ac VHT40 (Harmonic @ 3m)

WIFI Ant. 1+2	Note	Frequency (MHz)	Level (dBμV/m)	Over Limit (dB)	Limit Line (dBμV/m)	Read Level (dBμV)	Antenna Factor (dB/m)	Cable Loss (dB)	Preamp Factor (dB)	Ant Pos (cm)	Table Pos (deg)	Peak Avg. (P/A)	Pol. (H/V)	
802.11ac VHT40 CH 38 5190MHz		10380	50.52	-23.48	74	62.01	38.44	14.96	65.2	100	0	P	H	
		15570	59.69	-14.31	74	67.19	37.45	18.72	64.05	201	123	P	H	
		15570	48.03	-5.97	54	55.53	37.45	18.72	64.05	201	123	A	H	
													H	
			10380	47.17	-26.83	74	58.97	38.44	14.96	65.2	100	0	P	V
			15570	56.61	-17.39	74	64.11	37.45	18.72	64.05	203	226	P	V
			15570	45.68	-8.32	54	53.18	37.45	18.72	64.05	203	226	A	V
													V	
802.11ac VHT40 CH 46 5230MHz		10460	48.99	-25.01	74	60.34	38.53	15.01	65.2	100	0	P	H	
		15690	57.53	-16.47	74	65.67	37.02	18.82	64.32	197	121	P	H	
		15690	47.41	-6.59	54	55.55	37.02	18.82	64.32	197	121	A	H	
													H	
			10460	47.35	-26.65	74	59.01	38.53	15.01	65.2	100	0	P	V
			15690	57.53	-16.47	74	65.67	37.02	18.82	64.32	203	224	P	V
			15690	46.87	-7.13	54	55.01	37.02	18.82	64.32	203	224	A	V
													V	
Remark	1. No other spurious found. 2. All results are PASS against Peak and Average limit line.													



Band 1 5150~5250MHz
WIFI 802.11ac VHT80 (Band Edge @ 3m)

WIFI Ant. 1+2	Note	Frequency (MHz)	Level (dBμV/m)	Over Limit (dB)	Limit Line (dBμV/m)	Read Level (dBμV)	Antenna Factor (dB/m)	Cable Loss (dB)	Preamp Factor (dB)	Ant Pos (cm)	Table Pos (deg)	Peak Avg. (P/A)	Pol. (H/V)
802.11ac VHT80 CH 42 5210MHz		5145.34	59.65	-14.35	74	51.58	32.05	9.05	33.03	217	118	P	H
		5145.34	53.15	-0.85	54	45.08	32.05	9.05	33.03	217	118	A	H
	*	5210	102.32	-	-	94.14	32.12	9.09	33.03	217	118	P	H
	*	5210	94.63	-	-	86.45	32.12	9.09	33.03	217	118	A	H
		5351.08	49.28	-24.72	74	40.87	32.25	9.19	33.03	217	118	P	H
		5368.44	42.05	-11.95	54	33.61	32.27	9.2	33.03	217	118	A	H
		5142.22	59.01	-14.99	74	50.96	32.05	9.03	33.03	225	117	P	V
		5150	53.23	-0.77	54	45.16	32.05	9.05	33.03	225	117	A	V
	*	5210	99.49	-	-	91.31	32.12	9.09	33.03	225	117	P	V
	*	5210	92.44	-	-	84.26	32.12	9.09	33.03	225	117	A	V
		5407.92	49.39	-24.61	74	40.89	32.3	9.22	33.02	225	117	P	V
	5452.72	41.29	-12.71	54	32.67	32.35	9.29	33.02	225	117	A	V	
Remark	1. No other spurious found. 2. All results are PASS against Peak and Average limit line.												



Band 1 5150~5250MHz

WIFI 802.11ac VHT80 (Harmonic @ 3m)

WIFI Ant. 1+2	Note	Frequency (MHz)	Level (dBμV/m)	Over Limit (dB)	Limit Line (dBμV/m)	Read Level (dBμV)	Antenna Factor (dB/m)	Cable Loss (dB)	Preamp Factor (dB)	Ant Pos (cm)	Table Pos (deg)	Peak Avg. (P/A)	Pol. (H/V)	
802.11ac VHT80 CH 42 5210MHz		10420	47.68	-26.32	74	59.1	38.48	14.99	65.2	100	0	P	H	
		15630	54.66	-19.34	74	62.53	37.2	18.77	64.2	200	124	P	H	
		15630	44.09	-9.91	54	51.96	37.2	18.77	64.2	200	124	A	H	
													H	
			10420	46.23	-27.77	74	57.65	38.48	14.99	65.2	200	0	P	V
			15630	52.91	-21.09	74	60.78	37.2	18.77	64.2	200	226	P	V
			15630	42.53	-11.47	54	50.4	37.2	18.77	64.2	200	226	A	V
													V	
Remark	1. No other spurious found. 2. All results are PASS against Peak and Average limit line.													



Band 2 - 5250~5350MHz
WIFI 802.11a (Band Edge @ 3m)

WIFI	Note	Frequency	Level	Over	Limit	Read	Antenna	Cable	Preamp	Ant	Table	Peak	Pol.
Ant.				Limit	Line	Level	Factor	Loss	Factor	Pos	Pos	Avg.	
1+2		(MHz)	(dBμV/m)	(dB)	(dBμV/m)	(dBμV)	(dB/m)	(dB)	(dB)	(cm)	(deg)	(P/A)	(H/V)
802.11a CH 52 5260MHz		5077.7	50.44	-23.56	74	42.51	31.98	8.99	33.04	219	114	P	H
		5145.6	40.57	-13.43	54	32.5	32.05	9.05	33.03	219	114	A	H
	*	5260	109.43	-	-	101.16	32.17	9.13	33.03	219	114	P	H
	*	5260	99.59	-	-	91.32	32.17	9.13	33.03	219	114	A	H
		5359.44	50.19	-23.81	74	41.77	32.25	9.2	33.03	219	114	P	H
		5350.8	41.38	-12.62	54	32.97	32.25	9.19	33.03	219	114	A	H
		5010.85	50.45	-23.55	74	42.64	31.92	8.93	33.04	100	116	P	V
		5070.7	40.5	-13.5	54	32.58	31.97	8.99	33.04	100	116	A	V
	*	5260	108.42	-	-	100.15	32.17	9.13	33.03	100	116	P	V
	*	5260	98.45	-	-	90.18	32.17	9.13	33.03	100	116	A	V
		5434.32	50.61	-23.39	74	42.03	32.33	9.27	33.02	100	116	P	V
		5350.8	40.9	-13.1	54	32.49	32.25	9.19	33.03	100	116	A	V
802.11a CH 60 5300MHz		5098	49.59	-24.41	74	41.63	32	9	33.04	225	118	P	H
		5032.9	40.67	-13.33	54	32.83	31.93	8.95	33.04	225	118	A	H
	*	5300	110.7	-	-	102.38	32.2	9.15	33.03	225	118	P	H
	*	5300	100.52	-	-	92.2	32.2	9.15	33.03	225	118	A	H
		5350.8	51.13	-22.87	74	42.72	32.25	9.19	33.03	225	118	P	H
		5350.8	43.1	-10.9	54	34.69	32.25	9.19	33.03	225	118	A	H
		5078.4	49.23	-24.77	74	41.3	31.98	8.99	33.04	100	116	P	V
		5064.05	40.59	-13.41	54	32.69	31.97	8.97	33.04	100	116	A	V
	*	5300	108.88	-	-	100.56	32.2	9.15	33.03	100	116	P	V
	*	5300	99.09	-	-	90.77	32.2	9.15	33.03	100	116	A	V
		5350.56	49.77	-24.23	74	41.36	32.25	9.19	33.03	100	116	P	V
		5352.96	42.27	-11.73	54	33.86	32.25	9.19	33.03	100	116	A	V



802.11a CH 64 5320MHz	*	5320	109.57	-	-	101.22	32.22	9.16	33.03	100	116	P	H
	*	5320	99.65	-	-	91.3	32.22	9.16	33.03	100	116	A	H
		5350.24	61.63	-12.37	74	53.22	32.25	9.19	33.03	100	116	P	H
		5350.4	50.91	-3.09	54	42.5	32.25	9.19	33.03	100	116	A	H
													H
													H
	*	5320	108.99	-	-	100.64	32.22	9.16	33.03	102	116	P	V
	*	5320	99.2	-	-	90.85	32.22	9.16	33.03	102	116	A	V
		5352.48	58.22	-15.78	74	49.81	32.25	9.19	33.03	102	116	P	V
		5352.48	48.51	-5.49	54	40.1	32.25	9.19	33.03	102	116	A	V
													V
													V
Remark	1. No other spurious found. 2. All results are PASS against Peak and Average limit line.												



Band 2 5250~5350MHz
WIFI 802.11a (Harmonic @ 3m)

WIFI Ant. 1+2	Note	Frequency (MHz)	Level (dBμV/m)	Over Limit (dB)	Limit Line (dBμV/m)	Read Level (dBμV)	Antenna Factor (dB/m)	Cable Loss (dB)	Preamp Factor (dB)	Ant Pos (cm)	Table Pos (deg)	Peak Avg. (P/A)	Pol. (H/V)
802.11a CH 52 5260MHz		10520	49.39	-24.61	74	60.6	38.62	15.06	65.2	100	0	P	H
		15780	60.6	-13.4	74	69.19	36.71	18.9	64.51	256	42	P	H
		15780	49.95	-4.05	54	58.54	36.71	18.9	64.51	256	42	A	H
													H
		10520	46.14	-27.86	74	57.66	38.62	15.06	65.2	100	0	P	V
		15780	59.21	-14.79	74	67.8	36.71	18.9	64.51	203	222	P	V
		15780	48.87	-5.13	54	57.46	36.71	18.9	64.51	203	222	A	V
802.11a CH 60 5300MHz		10600	50.79	-23.21	74	61.83	38.72	15.11	65.18	100	0	P	H
		15900	58.72	-15.28	74	67.93	36.27	19.01	64.77	252	42	P	H
		15900	46.78	-7.22	54	55.99	36.27	19.01	64.77	252	42	A	H
													H
		10600	45.64	-28.36	74	56.99	38.72	15.11	65.18	100	0	P	V
		15900	56.96	-17.04	74	66.17	36.27	19.01	64.77	199	223	P	V
		15900	45.73	-8.27	54	54.94	36.27	19.01	64.77	199	223	A	V
802.11a CH 64 5320MHz		10640	50.76	-23.24	74	61.73	38.77	15.13	65.17	100	0	P	H
		15960	54.88	-19.12	74	64.46	36.02	19.06	64.92	244	216	P	H
		15960	44.49	-9.51	54	54.07	36.02	19.06	64.92	244	216	A	H
													H
		10640	46.07	-27.93	74	57.34	38.77	15.13	65.17	100	0	P	V
		15960	52.57	-21.43	74	62.15	36.02	19.06	64.92	300	165	P	V
		15960	40.54	-13.46	54	50.12	36.02	19.06	64.92	300	165	A	V
Remark	1. No other spurious found. 2. All results are PASS against Peak and Average limit line.												



Band 2 5250~5350MHz
WIFI 802.11n HT20 (Band Edge @ 3m)

WIFI Ant. 1+2	Note	Frequency (MHz)	Level (dBμV/m)	Over Limit (dB)	Limit Line (dBμV/m)	Read Level (dBμV)	Antenna Factor (dB/m)	Cable Loss (dB)	Preamp Factor (dB)	Ant Pos (cm)	Table Pos (deg)	Peak Avg. (P/A)	Pol. (H/V)
802.11n HT20 CH 52 5260MHz		5034.3	49.8	-24.2	74	41.96	31.93	8.95	33.04	219	116	P	H
		5091.35	40.63	-13.37	54	32.67	32	9	33.04	219	116	A	H
	*	5260	109.76	-	-	101.49	32.17	9.13	33.03	219	116	P	H
	*	5260	99.91	-	-	91.64	32.17	9.13	33.03	219	116	A	H
		5410.56	49.31	-24.69	74	40.81	32.3	9.22	33.02	219	116	P	H
		5351.04	41.52	-12.48	54	33.11	32.25	9.19	33.03	219	116	A	H
		5080.85	49.41	-24.59	74	41.48	31.98	8.99	33.04	100	116	P	V
		5102.55	40.61	-13.39	54	32.65	32	9	33.04	100	116	A	V
	*	5260	107.81	-	-	99.54	32.17	9.13	33.03	100	116	P	V
	*	5260	97.79	-	-	89.52	32.17	9.13	33.03	100	116	A	V
		5423.28	48.78	-25.22	74	40.24	32.32	9.24	33.02	100	116	P	V
		5358.24	40.82	-13.18	54	32.4	32.25	9.2	33.03	100	116	A	V
802.11n HT20 CH 60 5300MHz		5045.85	49.63	-24.37	74	41.76	31.95	8.96	33.04	225	118	P	H
		5145.6	40.67	-13.33	54	32.6	32.05	9.05	33.03	225	118	A	H
	*	5300	109.98	-	-	101.66	32.2	9.15	33.03	225	118	P	H
	*	5300	100.1	-	-	91.78	32.2	9.15	33.03	225	118	A	H
		5420.4	49.73	-24.27	74	41.19	32.32	9.24	33.02	225	118	P	H
		5350.56	43.16	-10.84	54	34.75	32.25	9.19	33.03	225	118	A	H
		5084.35	49.36	-24.64	74	41.43	31.98	8.99	33.04	100	116	P	V
		5091.35	40.6	-13.4	54	32.64	32	9	33.04	100	116	A	V
	*	5300	109.09	-	-	100.77	32.2	9.15	33.03	100	116	P	V
	*	5300	99.42	-	-	91.1	32.2	9.15	33.03	100	116	A	V
	5350.08	50.55	-23.45	74	42.14	32.25	9.19	33.03	100	116	P	V	
	5355.12	42.39	-11.61	54	33.98	32.25	9.19	33.03	100	116	A	V	



802.11n HT20 CH 64 5320MHz	*	5320	109.59	-	-	101.24	32.22	9.16	33.03	100	116	P	H
	*	5320	99.68	-	-	91.33	32.22	9.16	33.03	100	116	A	H
		5350.72	61.33	-12.67	74	52.92	32.25	9.19	33.03	100	116	P	H
		5350.4	52.16	-1.84	54	43.75	32.25	9.19	33.03	100	116	A	H
													H
													H
	*	5320	109.3	-	-	100.95	32.22	9.16	33.03	102	116	P	V
	*	5320	99.1	-	-	90.75	32.22	9.16	33.03	102	116	A	V
		5356	58.34	-15.66	74	49.93	32.25	9.19	33.03	102	116	P	V
		5353.92	46.33	-7.67	54	37.92	32.25	9.19	33.03	102	116	A	V
													V
													V
Remark	1. No other spurious found. 2. All results are PASS against Peak and Average limit line.												



Band 2 5250~5350MHz
WIFI 802.11n HT20 (Harmonic @ 3m)

WIFI Ant. 1+2	Note	Frequency (MHz)	Level (dBμV/m)	Over Limit (dB)	Limit Line (dBμV/m)	Read Level (dBμV)	Antenna Factor (dB/m)	Cable Loss (dB)	Preamp Factor (dB)	Ant Pos (cm)	Table Pos (deg)	Peak Avg. (P/A)	Pol. (H/V)	
802.11n HT20 CH 52 5260MHz		10520	50.89	-23.11	74	62.1	38.62	15.06	65.2	200	0	P	H	
		15780	60.58	-13.42	74	69.17	36.71	18.9	64.51	200	172	P	H	
		15780	49.68	-4.32	54	58.27	36.71	18.9	64.51	200	172	A	H	
													H	
			10520	48.21	-25.79	74	59.42	38.62	15.06	65.2	100	0	P	V
			15780	59.24	-14.76	74	67.83	36.71	18.9	64.51	200	235	P	V
			15780	48.39	-5.61	54	56.98	36.71	18.9	64.51	200	235	A	V
													V	
802.11n HT20 CH 60 5300MHz		10600	49.46	-24.54	74	60.5	38.72	15.11	65.18	100	0	P	H	
		15900	58.45	-15.55	74	67.66	36.27	19.01	64.77	200	130	P	H	
		15900	47.63	-6.37	54	56.84	36.27	19.01	64.77	200	130	A	H	
													H	
			10600	48.12	-25.88	74	59.16	38.72	15.11	65.18	100	0	P	V
			15900	56.49	-17.51	74	65.7	36.27	19.01	64.77	200	233	P	V
			15900	45.84	-8.16	54	55.05	36.27	19.01	64.77	200	233	A	V
													V	
802.11n HT20 CH 64 5320MHz		10640	48.46	-25.54	74	59.43	38.77	15.13	65.17	100	0	P	H	
		15960	55.54	-18.46	74	65.12	36.02	19.06	64.92	240	221	P	H	
		15960	44.67	-9.33	54	54.25	36.02	19.06	64.92	240	221	A	H	
													H	
			10640	47.25	-26.75	74	58.22	38.77	15.13	65.17	100	0	P	V
			15960	52.9	-21.1	74	62.48	36.02	19.06	64.92	300	170	P	V
			15960	41.88	-12.12	54	51.46	36.02	19.06	64.92	300	170	A	V
													V	
Remark	1. No other spurious found. 2. All results are PASS against Peak and Average limit line.													



Band 2 5250~5350MHz
WIFI 802.11n HT40 (Band Edge @ 3m)

WIFI Ant. 1+2	Note	Frequency (MHz)	Level (dBμV/m)	Over Limit (dB)	Limit Line (dBμV/m)	Read Level (dBμV)	Antenna Factor (dB/m)	Cable Loss (dB)	Preamp Factor (dB)	Ant Pos (cm)	Table Pos (deg)	Peak Avg. (P/A)	Pol. (H/V)
802.11n HT40 CH 54 5270MHz		5102.68	49.33	-24.67	74	41.37	32	9	33.04	221	117	P	H
		5091.8	41.81	-12.19	54	33.85	32	9	33.04	221	117	A	H
	*	5270	106.17	-	-	97.89	32.17	9.14	33.03	221	117	P	H
	*	5270	98.18	-	-	89.9	32.17	9.14	33.03	221	117	A	H
		5355.56	51.11	-22.89	74	42.7	32.25	9.19	33.03	221	117	P	H
		5357.24	43.43	-10.57	54	35.02	32.25	9.19	33.03	221	117	A	H
		5058.82	49.51	-24.49	74	41.61	31.97	8.97	33.04	224	118	P	V
		5148.24	41.87	-12.13	54	33.8	32.05	9.05	33.03	224	118	A	V
	*	5270	103.66	-	-	95.38	32.17	9.14	33.03	224	118	P	V
	*	5270	96.22	-	-	87.94	32.17	9.14	33.03	224	118	A	V
		5354.44	49.62	-24.38	74	41.21	32.25	9.19	33.03	224	118	P	V
		5350.24	42.22	-11.78	54	33.81	32.25	9.19	33.03	224	118	A	V
802.11n HT40 CH 62 5310MHz		5119	50.1	-23.9	74	42.09	32.02	9.02	33.03	221	117	P	H
		5058.82	41.7	-12.3	54	33.8	31.97	8.97	33.04	221	117	A	H
	*	5310	104.49	-	-	96.14	32.22	9.16	33.03	221	117	P	H
	*	5310	96.54	-	-	88.19	32.22	9.16	33.03	221	117	A	H
		5351.04	63.89	-10.11	74	55.48	32.25	9.19	33.03	221	117	P	H
		5350.56	53.02	-0.98	54	44.61	32.25	9.19	33.03	221	117	A	H
		5141.78	49.19	-24.81	74	41.14	32.05	9.03	33.03	225	117	P	V
		5119.68	41.61	-12.39	54	33.6	32.02	9.02	33.03	225	117	A	V
	*	5310	102.61	-	-	94.26	32.22	9.16	33.03	225	117	P	V
	*	5310	94.3	-	-	85.95	32.22	9.16	33.03	225	117	A	V
	5355.12	58.36	-15.64	74	49.95	32.25	9.19	33.03	225	117	P	V	
	5351.76	50.74	-3.26	54	42.33	32.25	9.19	33.03	225	117	A	V	
Remark	1. No other spurious found. 2. All results are PASS against Peak and Average limit line.												



Band 2 5250~5350MHz
WIFI 802.11n HT40 (Harmonic @ 3m)

WIFI Ant. 1+2	Note	Frequency (MHz)	Level (dBμV/m)	Over Limit (dB)	Limit Line (dBμV/m)	Read Level (dBμV)	Antenna Factor (dB/m)	Cable Loss (dB)	Preamp Factor (dB)	Ant Pos (cm)	Table Pos (deg)	Peak Avg. (P/A)	Pol. (H/V)
802.11n HT40 CH 54		10540	48.13	-25.87	74	59.3	38.64	15.07	65.19	100	0	P	H
		15810	50.24	-23.76	74	59	36.58	18.93	64.58	100	0	P	H
													H
													H
5270MHz		10540	45.86	-28.14	74	57.34	38.64	15.07	65.19	100	0	P	V
		15810	55.2	-18.8	74	63.96	36.58	18.93	64.58	201	221	P	V
		15810	45.07	-8.93	54	53.83	36.58	18.93	64.58	201	221	A	V
													V
802.11n HT40 CH 62		10620	47.19	-26.81	74	58.21	38.74	15.12	65.18	100	0	P	H
		15930	46.75	-27.25	74	56.13	36.15	19.05	64.85	100	0	P	H
													H
													H
5310MHz		10620	45.17	-28.83	74	56.49	38.74	15.12	65.18	100	0	P	V
		15930	46.53	-27.47	74	55.91	36.15	19.05	64.85	100	0	P	V
													V
													V
Remark	1. No other spurious found. 2. All results are PASS against Peak and Average limit line.												



Band 2 5250~5350MHz
WIFI 802.11ac VHT20 (Band Edge @ 3m)

WIFI Ant. 1+2	Note	Frequency (MHz)	Level (dBμV/m)	Over Limit (dB)	Limit Line (dBμV/m)	Read Level (dBμV)	Antenna Factor (dB/m)	Cable Loss (dB)	Preamp Factor (dB)	Ant Pos (cm)	Table Pos (deg)	Peak Avg. (P/A)	Pol. (H/V)
802.11ac VHT20 CH 52 5260MHz		5130.55	50.18	-23.82	74	42.15	32.03	9.03	33.03	221	115	P	H
		5046.2	40.67	-13.33	54	32.8	31.95	8.96	33.04	221	115	A	H
	*	5260	110.13	-	-	101.86	32.17	9.13	33.03	221	115	P	H
	*	5260	100.33	-	-	92.06	32.17	9.13	33.03	221	115	A	H
		5412	49.26	-24.74	74	40.74	32.32	9.22	33.02	221	115	P	H
		5352.24	41.57	-12.43	54	33.16	32.25	9.19	33.03	221	115	A	H
		5091.35	48.61	-25.39	74	40.65	32	9	33.04	100	115	P	V
		5075.95	40.63	-13.37	54	32.7	31.98	8.99	33.04	100	115	A	V
	*	5260	108.35	-	-	100.08	32.17	9.13	33.03	100	115	P	V
	*	5260	98.46	-	-	90.19	32.17	9.13	33.03	100	115	A	V
		5451.36	49.13	-24.87	74	40.51	32.35	9.29	33.02	100	115	P	V
		5351.04	41.01	-12.99	54	32.6	32.25	9.19	33.03	100	115	A	V
802.11ac VHT20 CH 60 5300MHz		5123.55	49.1	-24.9	74	41.08	32.03	9.02	33.03	216	115	P	H
		5028.7	40.84	-13.16	54	33	31.93	8.95	33.04	216	115	A	H
	*	5300	109.63	-	-	101.31	32.2	9.15	33.03	216	115	P	H
	*	5300	102.24	-	-	93.92	32.2	9.15	33.03	216	115	A	H
		5364.96	52.09	-21.91	74	43.65	32.27	9.2	33.03	216	115	P	H
		5351.04	42.63	-11.37	54	34.22	32.25	9.19	33.03	216	115	A	H
		5150	49.57	-24.43	74	41.5	32.05	9.05	33.03	102	115	P	V
		5057.4	40.87	-13.13	54	32.97	31.97	8.97	33.04	102	115	A	V
	*	5300	108.72	-	-	100.4	32.2	9.15	33.03	102	115	P	V
	*	5300	101.77	-	-	93.45	32.2	9.15	33.03	102	115	A	V
		5351.52	51.95	-22.05	74	43.54	32.25	9.19	33.03	102	115	P	V
		5357.76	42.22	-11.78	54	33.81	32.25	9.19	33.03	102	115	A	V



802.11ac VHT20 CH 64 5320MHz	*	5320	110.01	-	-	101.66	32.22	9.16	33.03	217	115	P	H
	*	5320	102.93	-	-	94.58	32.22	9.16	33.03	217	115	A	H
		5350.72	61.52	-12.48	74	53.11	32.25	9.19	33.03	217	115	P	H
		5350.08	51.25	-2.75	54	42.84	32.25	9.19	33.03	217	115	A	H
													H
													H
	*	5320	109.9	-	-	101.55	32.22	9.16	33.03	100	115	P	V
	*	5320	102.95	-	-	94.6	32.22	9.16	33.03	100	115	A	V
		5354.56	60.27	-13.73	74	51.86	32.25	9.19	33.03	100	115	P	V
		5353.6	46.18	-7.82	54	37.77	32.25	9.19	33.03	100	115	A	V
													V
													V
Remark	1. No other spurious found. 2. All results are PASS against Peak and Average limit line.												



Band 2 5250~5350MHz
WIFI 802.11ac VHT20 (Harmonic @ 3m)

WIFI Ant. 1+2	Note	Frequency (MHz)	Level (dBμV/m)	Over Limit (dB)	Limit Line (dBμV/m)	Read Level (dBμV)	Antenna Factor (dB/m)	Cable Loss (dB)	Preamp Factor (dB)	Ant Pos (cm)	Table Pos (deg)	Peak Avg. (P/A)	Pol. (H/V)
802.11ac VHT20 CH 52 5260MHz		10520	55.39	-18.61	74	66.6	38.62	15.06	65.2	238	202	P	H
		10520	45.22	-8.78	54	56.43	38.62	15.06	65.2	238	202	A	H
		15780	60.56	-13.44	74	69.15	36.71	18.9	64.51	245	183	P	H
		15780	48.11	-5.89	54	56.7	36.71	18.9	64.51	245	183	A	H
		10520	46.23	-27.77	74	57.44	38.62	15.06	65.2	100	0	P	V
		15780	59.96	-14.04	74	68.55	36.71	18.9	64.51	197	254	P	V
		15780	47.56	-6.44	54	56.15	36.71	18.9	64.51	197	254	A	V
													V
802.11ac VHT20 CH 60 5300MHz		10600	55.79	-18.21	74	66.83	38.72	15.11	65.18	237	195	P	H
		10600	43.84	-10.16	54	54.88	38.72	15.11	65.18	237	195	A	H
		15900	57.91	-16.09	74	67.12	36.27	19.01	64.77	241	158	P	H
		15900	44.77	-9.23	54	53.98	36.27	19.01	64.77	241	158	A	H
		10600	47.59	-26.41	74	58.94	38.72	15.11	65.18	100	0	P	V
		15900	58.91	-15.09	74	68.12	36.27	19.01	64.77	198	254	P	V
		15900	45.91	-8.09	54	55.12	36.27	19.01	64.77	198	254	A	V
													V
802.11ac VHT20 CH 64 5320MHz		10640	56.88	-17.12	74	67.85	38.77	15.13	65.17	248	201	P	H
		10640	44.94	-9.06	54	55.91	38.77	15.13	65.17	248	201	A	H
		15960	57.74	-16.26	74	67.32	36.02	19.06	64.92	243	167	P	H
		15960	44.58	-9.42	54	54.16	36.02	19.06	64.92	243	167	A	H
		10640	47.23	-26.77	74	58.5	38.77	15.13	65.17	100	0	P	V
		15960	58.94	-15.06	74	68.52	36.02	19.06	64.92	202	224	P	V
		15960	45.93	-8.07	54	55.51	36.02	19.06	64.92	202	224	A	V
													V
Remark	1. No other spurious found. 2. All results are PASS against Peak and Average limit line.												



Band 2 5250~5350MHz
WIFI 802.11ac VHT40 (Band Edge @ 3m)

WIFI Ant. 1+2	Note	Frequency (MHz)	Level (dBμV/m)	Over Limit (dB)	Limit Line (dBμV/m)	Read Level (dBμV)	Antenna Factor (dB/m)	Cable Loss (dB)	Preamp Factor (dB)	Ant Pos (cm)	Table Pos (deg)	Peak Avg. (P/A)	Pol. (H/V)
802.11ac VHT40 CH 54 5270MHz		5000.52	49.52	-24.48	74	41.73	31.9	8.93	33.04	221	117	P	H
		5114.92	41.88	-12.12	54	33.88	32.02	9.02	33.04	221	117	A	H
	*	5270	107.67	-	-	99.39	32.17	9.14	33.03	221	117	P	H
	*	5270	99.8	-	-	91.52	32.17	9.14	33.03	221	117	A	H
		5359.2	51.17	-22.83	74	42.75	32.25	9.2	33.03	221	117	P	H
		5356.08	43.86	-10.14	54	35.45	32.25	9.19	33.03	221	117	A	H
		5049.66	51.22	-22.78	74	43.35	31.95	8.96	33.04	225	117	P	V
		5055.12	41.74	-12.26	54	33.84	31.97	8.97	33.04	225	117	A	V
	*	5270	104.44	-	-	96.16	32.17	9.14	33.03	225	117	P	V
	*	5270	97.55	-	-	89.27	32.17	9.14	33.03	225	117	A	V
		5458.32	49.42	-24.58	74	40.8	32.35	9.29	33.02	225	117	P	V
		5351.52	42.34	-11.66	54	33.93	32.25	9.19	33.03	225	117	A	V
802.11ac VHT40 CH 62 5310MHz		5068.34	49.93	-24.07	74	42.03	31.97	8.97	33.04	228	116	P	H
		5143.14	41.71	-12.29	54	33.64	32.05	9.05	33.03	228	116	A	H
	*	5310	104.87	-	-	96.52	32.22	9.16	33.03	228	116	P	H
	*	5310	97.95	-	-	89.6	32.22	9.16	33.03	228	116	A	H
		5352.72	60.75	-13.25	74	52.34	32.25	9.19	33.03	228	116	P	H
		5350.56	52.58	-1.42	54	44.17	32.25	9.19	33.03	228	116	A	H
		5075.48	49.59	-24.41	74	41.66	31.98	8.99	33.04	224	115	P	V
		5098.94	41.73	-12.27	54	33.77	32	9	33.04	224	115	A	V
	*	5310	102.57	-	-	94.22	32.22	9.16	33.03	224	115	P	V
	*	5310	95.46	-	-	87.11	32.22	9.16	33.03	224	115	A	V
	5354.88	58.25	-15.75	74	49.84	32.25	9.19	33.03	224	115	P	V	
	5351.28	49.45	-4.55	54	41.04	32.25	9.19	33.03	224	115	A	V	
Remark	1. No other spurious found. 2. All results are PASS against Peak and Average limit line.												



Band 2 5250~5350MHz
WIFI 802.11ac VHT40 (Harmonic @ 3m)

WIFI Ant. 1+2	Note	Frequency (MHz)	Level (dBμV/m)	Over Limit (dB)	Limit Line (dBμV/m)	Read Level (dBμV)	Antenna Factor (dB/m)	Cable Loss (dB)	Preamp Factor (dB)	Ant Pos (cm)	Table Pos (deg)	Peak Avg. (P/A)	Pol. (H/V)	
802.11ac VHT40 CH 54 5270MHz		10540	49.63	-24.37	74	60.8	38.64	15.07	65.19	100	0	P	H	
		15810	54.95	-19.05	74	63.71	36.58	18.93	64.58	200	138	P	H	
		15810	43.42	-10.58	54	52.18	36.58	18.93	64.58	200	138	A	H	
													H	
			10540	45.17	-28.83	74	56.65	38.64	15.07	65.19	100	0	P	V
			15810	55.11	-18.89	74	63.87	36.58	18.93	64.58	205	225	P	V
			15810	45.1	-8.9	54	53.86	36.58	18.93	64.58	205	225	A	V
													V	
802.11ac VHT40 CH 62 5310MHz		10620	48.57	-25.43	74	59.59	38.74	15.12	65.18	100	0	P	H	
		15930	47.2	-26.8	74	56.58	36.15	19.05	64.85	100	0	P	H	
													H	
													H	
			10620	46.17	-27.83	74	57.49	38.74	15.12	65.18	100	0	P	V
			15930	47.18	-26.82	74	56.56	36.15	19.05	64.85	100	0	P	V
														V
													V	
Remark	1. No other spurious found. 2. All results are PASS against Peak and Average limit line.													



Band 2 5250~5350MHz
WIFI 802.11ac VHT80 (Band Edge @ 3m)

WIFI Ant. 1+2	Note	Frequency (MHz)	Level (dBμV/m)	Over Limit (dB)	Limit Line (dBμV/m)	Read Level (dBμV)	Antenna Factor (dB/m)	Cable Loss (dB)	Preamp Factor (dB)	Ant Pos (cm)	Table Pos (deg)	Peak Avg. (P/A)	Pol. (H/V)
802.11ac VHT80 CH 58 5290MHz		5093.34	49.06	-24.94	74	41.1	32	9	33.04	221	119	P	H
		5148.98	41.79	-12.21	54	33.72	32.05	9.05	33.03	221	119	A	H
	*	5290	101.53	-	-	93.23	32.18	9.15	33.03	221	119	P	H
	*	5290	94.13	-	-	85.83	32.18	9.15	33.03	221	119	A	H
		5361.84	60.11	-13.89	74	51.67	32.27	9.2	33.03	221	119	P	H
		5361.84	52.13	-1.87	54	43.69	32.27	9.2	33.03	221	119	A	H
		5027.04	50.08	-23.92	74	42.24	31.93	8.95	33.04	226	122	P	V
		5095.94	41.58	-12.42	54	33.62	32	9	33.04	226	122	A	V
	*	5290	97.61	-	-	89.31	32.18	9.15	33.03	226	122	P	V
	*	5290	90.76	-	-	82.46	32.18	9.15	33.03	226	122	A	V
		5362.56	55.78	-18.22	74	47.34	32.27	9.2	33.03	226	122	P	V
	5363.76	48.77	-5.23	54	40.33	32.27	9.2	33.03	226	122	A	V	
Remark	1. No other spurious found. 2. All results are PASS against Peak and Average limit line.												



Band 2 5250~5350MHz

WIFI 802.11ac VHT80 (Harmonic @ 3m)

WIFI Ant. 1+2	Note	Frequency (MHz)	Level (dBμV/m)	Over Limit (dB)	Limit Line (dBμV/m)	Read Level (dBμV)	Antenna Factor (dB/m)	Cable Loss (dB)	Preamp Factor (dB)	Ant Pos (cm)	Table Pos (deg)	Peak Avg. (P/A)	Pol. (H/V)	
802.11ac VHT80 CH 58 5290MHz		10580	48.41	-25.59	74	59.48	38.7	15.1	65.18	100	0	P	H	
		15870	47.18	-26.82	74	56.31	36.33	18.98	64.73	100	0	P	H	
													H	
													H	
			10580	46.92	-27.08	74	57.99	38.7	15.1	65.18	100	0	P	V
			15870	45.73	-28.27	74	54.86	36.33	18.98	64.73	100	0	P	V
														V
Remark	1. No other spurious found.													
	2. All results are PASS against Peak and Average limit line.													



Band 3 - 5470~5725MHz
WIFI 802.11a (Band Edge @ 3m)

WIFI	Note	Frequency	Level	Over	Limit	Read	Antenna	Cable	Preamp	Ant	Table	Peak	Pol.	
Ant.				Limit	Line	Level	Factor	Loss	Factor	Pos	Pos	Avg.		
1+2		(MHz)	(dBμV/m)	(dB)	(dBμV/m)	(dBμV)	(dB/m)	(dB)	(dB)	(cm)	(deg)	(P/A)	(H/V)	
802.11a CH 100 5500MHz		5468.88	62.92	-11.08	74	54.26	32.37	9.31	33.02	212	118	P	H	
		5469.36	50.91	-3.09	54	42.25	32.37	9.31	33.02	212	118	A	H	
	*	5500	110.25	-	-	101.53	32.4	9.34	33.02	212	118	P	H	
	*	5500	101.81	-	-	93.09	32.4	9.34	33.02	212	118	A	H	
													H	
														H
			5466.96	59.82	-14.18	74	51.16	32.37	9.31	33.02	100	117	P	V
			5466.8	48.89	-5.11	54	40.23	32.37	9.31	33.02	100	117	A	V
	*		5500	108.77	-	-	100.05	32.4	9.34	33.02	100	117	P	V
	*		5500	100.29	-	-	91.57	32.4	9.34	33.02	100	117	A	V
														V
														V
802.11a CH 116 5580MHz		5465.68	49.09	-24.91	74	40.45	32.37	9.29	33.02	102	117	P	H	
		5452.72	41.12	-12.88	54	32.5	32.35	9.29	33.02	102	117	A	H	
	*	5580	110.51	-	-	101.55	32.57	9.46	33.07	102	117	P	H	
	*	5580	100.99	-	-	92.03	32.57	9.46	33.07	102	117	A	H	
			5728.775	50.61	-23.39	74	40.98	32.94	9.82	33.13	102	117	P	H
			5758.07	41.57	-12.43	54	31.79	33.02	9.92	33.16	102	117	A	H
			5437.36	48.89	-25.11	74	40.31	32.33	9.27	33.02	100	117	P	V
			5452.48	40.76	-13.24	54	32.14	32.35	9.29	33.02	100	117	A	V
	*		5580	108.69	-	-	99.73	32.57	9.46	33.07	100	117	P	V
	*		5580	99.24	-	-	90.28	32.57	9.46	33.07	100	117	A	V
			5756.81	51.17	-22.83	74	41.39	33.02	9.92	33.16	100	117	P	V
			5742.635	41.54	-12.46	54	31.84	32.98	9.87	33.15	100	117	A	V



802.11a CH 140 5700MHz	*	5700	110.92	-	-	101.41	32.86	9.77	33.12	100	115	P	H
	*	5700	101.32	-	-	91.81	32.86	9.77	33.12	100	115	A	H
		5725.24	66.89	-1.31	68.2	57.26	32.94	9.82	33.13	100	115	P	H
													H
													H
													H
	*	5700	108.13	-	-	98.62	32.86	9.77	33.12	100	117	P	V
	*	5700	98.7	-	-	89.19	32.86	9.77	33.12	100	117	A	V
		5725.24	64.76	-3.44	68.2	55.13	32.94	9.82	33.13	100	117	P	V
													V
													V
													V
Remark	1. No other spurious found. 2. All results are PASS against Peak and Average limit line.												



Band 3 - 5470~5725MHz
WIFI 802.11a (Harmonic @ 3m)

WIFI Ant. 1+2	Note	Frequency (MHz)	Level (dBμV/m)	Over Limit (dB)	Limit Line (dBμV/m)	Read Level (dBμV)	Antenna Factor (dB/m)	Cable Loss (dB)	Preamp Factor (dB)	Ant Pos (cm)	Table Pos (deg)	Peak Avg. (P/A)	Pol. (H/V)	
802.11a CH 100 5500MHz		11000	56.33	-17.67	74	66.56	39.2	15.37	65.1	202	65	P	H	
		11000	45.08	-8.92	54	55.31	39.2	15.37	65.1	202	65	A	H	
		16500	46.58	-27.42	74	54.83	37.1	19.45	65.1	100	0	P	H	
													H	
			11000	49.71	-24.29	74	60.24	39.2	15.37	65.1	100	0	P	V
			16500	45.2	-28.8	74	53.45	37.1	19.45	65.1	100	0	P	V
														V
802.11a CH 116 5580MHz		11160	54.68	-19.32	74	65.11	38.97	15.51	65.2	207	70	P	H	
		11160	42.58	-11.42	54	53.01	38.97	15.51	65.2	207	70	A	H	
		16740	46.22	-27.78	74	52.22	38.93	19.61	64.86	100	0	P	H	
													H	
			11160	52.29	-21.71	74	63.01	38.97	15.51	65.2	200	143	P	V
			11160	40.43	-13.57	54	51.15	38.97	15.51	65.2	200	143	A	V
			16740	45.97	-28.03	74	51.97	38.93	19.61	64.86	100	0	P	V
802.11a CH 140 5700MHz		11400	53.52	-20.48	74	64.2	38.64	15.74	65.34	100	206	P	H	
		11400	41.57	-12.43	54	52.25	38.64	15.74	65.34	100	206	A	H	
		17100	48.71	-19.49	68.2	52.16	40.84	19.82	64.46	100	0	P	H	
													H	
			11400	49.92	-24.08	74	60.88	38.64	15.74	65.34	100	0	P	V
			17100	48.06	-20.14	68.2	51.51	40.84	19.82	64.46	100	0	P	V
														V
Remark	1. No other spurious found.													
	2. All results are PASS against Peak and Average limit line.													



Band 3 - 5470~5725MHz
WIFI 802.11n HT20 (Band Edge @ 3m)

WIFI Ant. 1+2	Note	Frequency (MHz)	Level (dBµV/m)	Over Limit (dB)	Limit Line (dBµV/m)	Read Level (dBµV)	Antenna Factor (dB/m)	Cable Loss (dB)	Preamp Factor (dB)	Ant Pos (cm)	Table Pos (deg)	Peak Avg. (P/A)	Pol. (H/V)	
802.11n HT20 CH 100 5500MHz		5469.52	61.82	-12.18	74	53.16	32.37	9.31	33.02	218	117	P	H	
		5470	52.27	-1.73	54	43.61	32.37	9.31	33.02	218	117	A	H	
	*	5500	110.11	-	-	101.39	32.4	9.34	33.02	218	117	P	H	
	*	5500	100.17	-	-	91.45	32.4	9.34	33.02	218	117	A	H	
													H	
														H
			5462	58.89	-15.11	74	50.27	32.35	9.29	33.02	100	117	P	V
			5470	48.97	-5.03	54	40.31	32.37	9.31	33.02	100	117	A	V
		*	5500	108.56	-	-	99.84	32.4	9.34	33.02	100	117	P	V
		*	5500	98.95	-	-	90.23	32.4	9.34	33.02	100	117	A	V
													V	
													V	
802.11n HT20 CH 116 5580MHz		5465.44	49.6	-24.4	74	40.96	32.37	9.29	33.02	102	117	P	H	
		5452.96	41.14	-12.86	54	32.52	32.35	9.29	33.02	102	117	A	H	
		* 5580	110.61	-	-	101.65	32.57	9.46	33.07	102	117	P	H	
		* 5580	100.87	-	-	91.91	32.57	9.46	33.07	102	117	A	H	
			5762.165	48.83	-25.17	74	39.05	33.02	9.92	33.16	102	117	P	H
			5764.055	41.59	-12.41	54	31.81	33.02	9.92	33.16	102	117	A	H
			5464.72	49.59	-24.41	74	40.95	32.37	9.29	33.02	100	117	P	V
			5464.48	40.76	-13.24	54	32.12	32.37	9.29	33.02	100	117	A	V
		*	5580	108.13	-	-	99.17	32.57	9.46	33.07	100	117	P	V
		*	5580	98.7	-	-	89.74	32.57	9.46	33.07	100	117	A	V
		5760.905	49.49	-24.51	74	39.71	33.02	9.92	33.16	100	117	P	V	
		5748.935	41.45	-12.55	54	31.75	32.98	9.87	33.15	100	117	A	V	



802.11n HT20 CH 140 5700MHz	*	5700	110.35	-	-	100.8	32.9	9.77	33.12	100	117	P	H
	*	5700	100.89	-	-	91.34	32.9	9.77	33.12	100	117	A	H
		5726.52	67.87	-0.33	68.2	58.24	32.94	9.82	33.13	100	117	P	H
													H
													H
													H
	*	5700	108.19	-	-	98.68	32.86	9.77	33.12	100	117	P	V
	*	5700	98.38	-	-	88.87	32.86	9.77	33.12	100	117	A	V
		5730.12	59.65	-8.55	68.2	50.02	32.94	9.82	33.13	100	117	P	V
													V
													V
													V
Remark	1. No other spurious found. 2. All results are PASS against Peak and Average limit line.												



Band 3 - 5470~5725MHz
WIFI 802.11n HT20 (Harmonic @ 3m)

WIFI Ant. 1+2	Note	Frequency (MHz)	Level (dBμV/m)	Over Limit (dB)	Limit Line (dBμV/m)	Read Level (dBμV)	Antenna Factor (dB/m)	Cable Loss (dB)	Preamp Factor (dB)	Ant Pos (cm)	Table Pos (deg)	Peak Avg. (P/A)	Pol. (H/V)	
802.11n HT20 CH 100 5500MHz		11000	58.18	-15.82	74	68.41	39.2	15.37	65.1	215	67	P	H	
		11000	46.8	-7.2	54	57.03	39.2	15.37	65.1	215	67	A	H	
		16500	45.49	-28.51	74	53.74	37.1	19.45	65.1	100	0	P	H	
													H	
			11000	47.18	-26.82	74	57.41	39.2	15.37	65.1	100	0	P	V
			16500	45.29	-28.71	74	53.54	37.1	19.45	65.1	100	0	P	V
														V
802.11n HT20 CH 116 5580MHz		11160	56.55	-17.45	74	66.98	38.97	15.51	65.2	215	70	P	H	
		11160	44.55	-9.45	54	54.98	38.97	15.51	65.2	215	70	A	H	
		16740	45.36	-28.64	74	51.36	38.93	19.61	64.86	100	0	P	H	
													H	
			11160	54.46	-19.54	74	64.89	38.97	15.51	65.2	200	141	P	V
			11160	43.52	-10.48	54	53.95	38.97	15.51	65.2	200	141	A	V
			16740	45.45	-28.55	74	51.45	38.93	19.61	64.86	100	0	P	V
802.11n HT20 CH 140 5700MHz		11400	54.72	-19.28	74	65.4	38.64	15.74	65.34	100	220	P	H	
		11400	43.74	-10.26	54	54.42	38.64	15.74	65.34	100	220	A	H	
		17100	49.1	-19.1	68.2	52.55	40.84	19.82	64.46	100	0	P	H	
													H	
			11400	53.54	-20.46	74	64.5	38.64	15.74	65.34	200	138	P	V
			11400	40.9	-13.1	54	51.86	38.64	15.74	65.34	200	138	A	V
			17100	48.63	-19.57	68.2	52.08	40.84	19.82	64.46	100	0	P	V
													V	
Remark	1. No other spurious found. 2. All results are PASS against Peak and Average limit line.													



Band 3 - 5470~5725MHz
WIFI 802.11n HT40 (Band Edge @ 3m)

WIFI Ant. 1+2	Note	Frequency (MHz)	Level (dBμV/m)	Over Limit (dB)	Limit Line (dBμV/m)	Read Level (dBμV)	Antenna Factor (dB/m)	Cable Loss (dB)	Preamp Factor (dB)	Ant Pos (cm)	Table Pos (deg)	Peak Avg. (P/A)	Pol. (H/V)
802.11n HT40 CH 102 5510MHz		5456.8	60.36	-13.64	74	51.74	32.35	9.29	33.02	222	115	P	H
		5461.84	63.12	-5.08	68.2	54.5	32.35	9.29	33.02	222	115	P	H
		5459.44	53.24	-0.76	54	44.62	32.35	9.29	33.02	222	115	A	H
	*	5510	106.31	-	-	97.58	32.4	9.36	33.03	222	115	P	H
	*	5510	98.37	-	-	89.64	32.4	9.36	33.03	222	115	A	H
		5759.96	49.08	-19.12	68.2	39.3	33.02	9.92	33.16	222	115	P	H
		5459.2	57.63	-16.37	74	49.01	32.35	9.29	33.02	211	119	P	V
		5467.12	61.46	-6.74	68.2	52.8	32.37	9.31	33.02	211	119	P	V
		5459.92	48.18	-5.82	54	39.56	32.35	9.29	33.02	211	119	A	V
	*	5510	102.16	-	-	93.43	32.4	9.36	33.03	211	119	P	V
	*	5510	93.99	-	-	85.26	32.4	9.36	33.03	211	119	A	V
		5736.335	50.3	-17.9	68.2	40.6	32.98	9.87	33.15	211	119	P	V
802.11n HT40 CH 110 5550MHz		5453.92	50.4	-23.6	74	41.78	32.35	9.29	33.02	222	119	P	H
		5467.36	43.31	-10.69	54	34.65	32.37	9.31	33.02	222	119	A	H
	*	5550	106.04	-	-	97.16	32.52	9.41	33.05	222	119	P	H
	*	5550	98.31	-	-	89.43	32.52	9.41	33.05	222	119	A	H
		5741.06	50.91	-23.09	74	41.21	32.98	9.87	33.15	222	119	P	H
		5742.95	42.72	-11.28	54	33.02	32.98	9.87	33.15	222	119	A	H
		5454.16	49.94	-24.06	74	41.32	32.35	9.29	33.02	224	136	P	V
		5469.52	42.23	-11.77	54	33.57	32.37	9.31	33.02	224	136	A	V
	*	5550	102.12	-	-	93.24	32.52	9.41	33.05	224	136	P	V
	*	5550	94.27	-	-	85.39	32.52	9.41	33.05	224	136	A	V
		5742.635	50.1	-23.9	74	40.4	32.98	9.87	33.15	224	136	P	V
		5737.28	42.49	-11.51	54	32.79	32.98	9.87	33.15	224	136	A	V



802.11n HT40 CH 134 5670MHz		5431.55	49.12	-24.88	74	40.54	32.33	9.27	33.02	221	117	P	H
		5460.95	41.52	-12.48	54	32.9	32.35	9.29	33.02	221	117	A	H
	*	5670	107.39	-	-	98.02	32.81	9.67	33.11	221	117	P	H
	*	5670	98.42	-	-	89.05	32.81	9.67	33.11	221	117	A	H
		5725	59.26	-14.74	74	49.63	32.94	9.82	33.13	221	117	P	H
		5726.5	52.44	-1.56	54	42.81	32.94	9.82	33.13	221	117	A	H
		5393.4	49.47	-24.53	74	41	32.28	9.21	33.02	233	136	P	V
		5465.85	41.31	-12.69	54	32.67	32.37	9.29	33.02	233	136	A	V
	*	5670	102.95	-	-	93.58	32.81	9.67	33.11	233	136	P	V
	*	5670	94.36	-	-	84.99	32.81	9.67	33.11	233	136	A	V
		5725.975	54.68	-19.32	74	45.05	32.94	9.82	33.13	233	136	P	V
		5725	48.1	-5.9	54	38.47	32.94	9.82	33.13	233	136	A	V
Remark	1. No other spurious found. 2. All results are PASS against Peak and Average limit line.												



Band 3 - 5470~5725MHz
WIFI 802.11n HT40 (Harmonic @ 3m)

WIFI Ant. 1+2	Note	Frequency (MHz)	Level (dBμV/m)	Over Limit (dB)	Limit Line (dBμV/m)	Read Level (dBμV)	Antenna Factor (dB/m)	Cable Loss (dB)	Preamp Factor (dB)	Ant Pos (cm)	Table Pos (deg)	Peak Avg. (P/A)	Pol. (H/V)
802.11n HT40 CH 102 5510MHz		11020	49.16	-24.84	74	59.4	39.18	15.4	65.11	100	0	P	H
		16530	45.76	-22.44	68.2	53.71	37.36	19.46	65.07	100	0	P	H
													H
													H
		11020	46.24	-27.76	74	56.77	39.18	15.4	65.11	100	0	P	V
		16530	44.74	-23.46	68.2	52.69	37.36	19.46	65.07	100	0	P	V
													V
802.11n HT40 CH 110 5550MHz		11100	49.22	-24.78	74	59.56	39.06	15.47	65.16	100	0	P	H
		16650	45.53	-28.47	74	52.33	38.28	19.55	64.94	100	0	P	H
													H
													H
		11100	45.88	-28.12	74	56.51	39.06	15.47	65.16	100	0	P	V
		16650	45.3	-28.7	74	52.1	38.28	19.55	64.94	100	0	P	V
													V
802.11n HT40 CH 134 5670MHz		11340	48.99	-25.01	74	59.6	38.73	15.67	65.3	100	0	P	H
		17010	50.04	-23.96	74	53.6	40.89	19.79	64.58	100	0	P	H
													H
													H
		11340	47.12	-26.88	74	58.02	38.73	15.67	65.3	100	0	P	V
		17010	49.12	-24.88	74	52.68	40.89	19.79	64.58	100	0	P	V
													V
Remark	1. No other spurious found.												
	2. All results are PASS against Peak and Average limit line.												



Band 3 - 5470~5725MHz
WIFI 802.11ac VHT20 (Band Edge @ 3m)

WIFI Ant. 1+2	Note	Frequency (MHz)	Level (dBμV/m)	Over Limit (dB)	Limit Line (dBμV/m)	Read Level (dBμV)	Antenna Factor (dB/m)	Cable Loss (dB)	Preamp Factor (dB)	Ant Pos (cm)	Table Pos (deg)	Peak Avg. (P/A)	Pol. (H/V)	
802.11ac VHT20 CH 100 5500MHz		5469.2	60.98	-13.02	74	52.32	32.37	9.31	33.02	215	113	P	H	
		5469.84	52.3	-1.7	54	43.64	32.37	9.31	33.02	215	113	A	H	
	*	5500	109.89	-	-	101.17	32.4	9.34	33.02	215	113	P	H	
	*	5500	102.7	-	-	93.98	32.4	9.34	33.02	215	113	A	H	
													H	
													H	
			5468.56	59.71	-14.29	74	51.05	32.37	9.31	33.02	104	116	P	V
			5470	49.96	-4.04	54	41.3	32.37	9.31	33.02	104	116	A	V
	*		5500	109.38	-	-	100.66	32.4	9.34	33.02	104	116	P	V
	*		5500	102.27	-	-	93.55	32.4	9.34	33.02	104	116	A	V
													V	
													V	
802.11ac VHT20 CH 116 5580MHz		5428.72	49.88	-24.12	74	41.33	32.33	9.24	33.02	217	113	P	H	
		5467.6	41.1	-12.9	54	32.44	32.37	9.31	33.02	217	113	A	H	
	*	5580	110.35	-	-	101.39	32.57	9.46	33.07	217	113	P	H	
	*	5580	103.47	-	-	94.51	32.57	9.46	33.07	217	113	A	H	
			5749.565	50.24	-23.76	74	40.54	32.98	9.87	33.15	217	113	P	H
			5736.965	41.85	-12.15	54	32.15	32.98	9.87	33.15	217	113	A	H
			5417.44	48.77	-25.23	74	40.23	32.32	9.24	33.02	105	115	P	V
			5470	41.06	-12.94	54	32.4	32.37	9.31	33.02	105	115	A	V
	*		5580	109.6	-	-	100.64	32.57	9.46	33.07	105	115	P	V
	*		5580	102.31	-	-	93.35	32.57	9.46	33.07	105	115	A	V
		5729.72	50.3	-23.7	74	40.67	32.94	9.82	33.13	105	115	P	V	
		5762.165	41.73	-12.27	54	31.95	33.02	9.92	33.16	105	115	A	V	



802.11ac VHT20 CH 140 5700MHz	*	5700	109.41	-	-	99.9	32.86	9.77	33.12	214	116	P	H
	*	5700	102.36	-	-	92.85	32.86	9.77	33.12	214	116	A	H
		5725.08	66.27	-1.93	68.2	56.64	32.94	9.82	33.13	214	116	P	H
													H
													H
													H
	*	5700	107.81	-	-	98.3	32.86	9.77	33.12	102	111	P	V
	*	5700	100.59	-	-	91.08	32.86	9.77	33.12	102	111	A	V
		5725.72	60.52	-7.68	68.2	50.89	32.94	9.82	33.13	102	111	P	V
													V
													V
													V
Remark	1. No other spurious found. 2. All results are PASS against Peak and Average limit line.												



Band 3 - 5470~5725MHz
WIFI 802.11ac VHT20 (Harmonic @ 3m)

WIFI Ant. 1+2	Note	Frequency (MHz)	Level (dBµV/m)	Over Limit (dB)	Limit Line (dBµV/m)	Read Level (dBµV)	Antenna Factor (dB/m)	Cable Loss (dB)	Preamp Factor (dB)	Ant Pos (cm)	Table Pos (deg)	Peak Avg. (P/A)	Pol. (H/V)	
802.11ac VHT20 CH 100 5500MHz		11000	58.14	-15.86	74	68.37	39.2	15.37	65.1	102	236	P	H	
		11000	44.81	-9.19	54	55.04	39.2	15.37	65.1	102	236	A	H	
		16500	45.75	-28.25	74	54	37.1	19.45	65.1	100	0	P	H	
													H	
			11000	50.29	-23.71	74	60.82	39.2	15.37	65.1	100	0	P	V
			16500	47.58	-26.42	74	55.83	37.1	19.45	65.1	100	0	P	V
														V
802.11ac VHT20 CH 116 5580MHz		11160	58.29	-15.71	74	68.72	38.97	15.51	65.2	104	241	P	H	
		11160	44.69	-9.31	54	55.12	38.97	15.51	65.2	104	241	A	H	
		16740	45.92	-28.08	74	51.92	38.93	19.61	64.86	100	0	P	H	
													H	
			11160	54.42	-19.58	74	65.14	38.97	15.51	65.2	200	241	P	V
			11160	43.15	-10.85	54	53.87	38.97	15.51	65.2	200	241	A	V
			16740	45.37	-28.63	74	51.37	38.93	19.61	64.86	100	0	P	V
802.11ac VHT20 CH 140 5700MHz		11400	57.15	-16.85	74	67.83	38.64	15.74	65.34	100	237	P	H	
		11400	41.06	-12.94	54	51.74	38.64	15.74	65.34	100	237	A	H	
		17100	49.04	-19.16	68.2	52.49	40.84	19.82	64.46	100	0	P	H	
													H	
			11400	48.86	-25.14	74	59.82	38.64	15.74	65.34	100	0	P	V
			17100	48.47	-19.73	68.2	51.92	40.84	19.82	64.46	100	0	P	V
														V
Remark	1. No other spurious found.													
	2. All results are PASS against Peak and Average limit line.													



Band 3 - 5470~5725MHz
WIFI 802.11ac VHT40 (Band Edge @ 3m)

WIFI Ant. 1+2	Note	Frequency (MHz)	Level (dBμV/m)	Over Limit (dB)	Limit Line (dBμV/m)	Read Level (dBμV)	Antenna Factor (dB/m)	Cable Loss (dB)	Preamp Factor (dB)	Ant Pos (cm)	Table Pos (deg)	Peak Avg. (P/A)	Pol. (H/V)
802.11ac VHT40 CH 102 5510MHz		5459.2	62.33	-11.67	74	53.71	32.35	9.29	33.02	222	117	P	H
		5464	63.92	-4.28	68.2	55.28	32.37	9.29	33.02	222	117	P	H
		5459.68	53.14	-0.86	54	44.52	32.35	9.29	33.02	222	117	A	H
	*	5510	106.17	-	-	97.44	32.4	9.36	33.03	222	117	P	H
	*	5510	99.68	-	-	90.95	32.4	9.36	33.03	222	117	A	H
		5764.37	49.78	-18.42	68.2	40	33.02	9.92	33.16	222	117	P	H
		5453.68	56.33	-17.67	74	47.71	32.35	9.29	33.02	208	130	P	V
		5464.48	61.32	-6.88	68.2	52.68	32.37	9.29	33.02	208	130	P	V
		5453.68	48.17	-5.83	54	39.55	32.35	9.29	33.02	208	130	A	V
	*	5510	103.03	-	-	94.3	32.4	9.36	33.03	208	130	P	V
	*	5510	95.67	-	-	86.94	32.4	9.36	33.03	208	130	A	V
	5764.685	50.03	-18.17	68.2	40.25	33.02	9.92	33.16	208	130	P	V	
802.11ac VHT40 CH 110 5550MHz		5461.12	50.07	-23.93	74	41.45	32.35	9.29	33.02	222	118	P	H
		5468.08	43.84	-10.16	54	35.18	32.37	9.31	33.02	222	118	A	H
	*	5550	107.85	-	-	98.97	32.52	9.41	33.05	222	118	P	H
	*	5550	100.23	-	-	91.35	32.52	9.41	33.05	222	118	A	H
		5746.415	50.97	-23.03	74	41.27	32.98	9.87	33.15	222	118	P	H
		5756.495	42.77	-11.23	54	32.99	33.02	9.92	33.16	222	118	A	H
		5462.56	49.3	-24.7	74	40.66	32.37	9.29	33.02	231	116	P	V
		5469.52	42.18	-11.82	54	33.52	32.37	9.31	33.02	231	116	A	V
	*	5550	103.04	-	-	94.16	32.52	9.41	33.05	231	116	P	V
	*	5550	95.41	-	-	86.53	32.52	9.41	33.05	231	116	A	V
		5739.8	50.69	-23.31	74	40.99	32.98	9.87	33.15	231	116	P	V
	5748.935	42.22	-11.78	54	32.52	32.98	9.87	33.15	231	116	A	V	



802.11ac VHT40 CH 134 5670MHz		5445.2	49.89	-24.11	74	41.31	32.33	9.27	33.02	224	116	P	H
		5437.85	41.57	-12.43	54	32.99	32.33	9.27	33.02	224	116	A	H
	*	5670	108.1	-	-	98.73	32.81	9.67	33.11	224	116	P	H
	*	5670	100.3	-	-	90.93	32.81	9.67	33.11	224	116	A	H
		5727.725	58.84	-15.16	74	49.21	32.94	9.82	33.13	224	116	P	H
		5727.375	50.16	-3.84	54	40.53	32.94	9.82	33.13	224	116	A	H
		5432.95	49.02	-24.98	74	40.44	32.33	9.27	33.02	216	128	P	V
		5442.05	41.08	-12.92	54	32.5	32.33	9.27	33.02	216	128	A	V
	*	5670	104.43	-	-	95.06	32.81	9.67	33.11	216	128	P	V
	*	5670	96.42	-	-	87.05	32.81	9.67	33.11	216	128	A	V
		5732.625	55.92	-18.08	74	46.31	32.94	9.82	33.15	216	128	P	V
		5725.45	48.7	-5.3	54	39.07	32.94	9.82	33.13	216	128	A	V
Remark	1. No other spurious found. 2. All results are PASS against Peak and Average limit line.												



Band 3 - 5470~5725MHz
WIFI 802.11ac VHT40 (Harmonic @ 3m)

WIFI Ant. 1+2	Note	Frequency (MHz)	Level (dBμV/m)	Over Limit (dB)	Limit Line (dBμV/m)	Read Level (dBμV)	Antenna Factor (dB/m)	Cable Loss (dB)	Preamp Factor (dB)	Ant Pos (cm)	Table Pos (deg)	Peak Avg. (P/A)	Pol. (H/V)	
802.11ac VHT40 CH 102 5510MHz		11020	50.99	-23.01	74	61.23	39.18	15.4	65.11	100	0	P	H	
		16530	44.51	-23.69	68.2	52.46	37.36	19.46	65.07	100	0	P	H	
													H	
													H	
			11020	46.37	-27.63	74	56.9	39.18	15.4	65.11	100	0	P	V
			16530	45.3	-22.9	68.2	53.25	37.36	19.46	65.07	100	0	P	V
														V
802.11ac VHT40 CH 110 5550MHz		11100	50.31	-23.69	74	60.65	39.06	15.47	65.16	100	0	P	H	
		16650	45.25	-28.75	74	52.05	38.28	19.55	64.94	100	0	P	H	
													H	
													H	
			11100	47.26	-26.74	74	57.89	39.06	15.47	65.16	100	0	P	V
			16650	46	-28	74	52.8	38.28	19.55	64.94	100	0	P	V
														V
802.11ac VHT40 CH 134 5670MHz		11340	50.04	-23.96	74	60.65	38.73	15.67	65.3	100	0	P	H	
		17010	48.13	-25.87	74	51.69	40.89	19.79	64.58	100	0	P	H	
													H	
													H	
			11340	46.78	-27.22	74	57.68	38.73	15.67	65.3	100	0	P	V
			17010	49.28	-24.72	74	52.84	40.89	19.79	64.58	100	0	P	V
														V
Remark	1. No other spurious found.													
	2. All results are PASS against Peak and Average limit line.													



Band 3 5470~5725MHz
WIFI 802.11ac VHT80 (Band Edge @ 3m)

WIFI Ant. 1+2	Note	Frequency (MHz)	Level (dBμV/m)	Over Limit (dB)	Limit Line (dBμV/m)	Read Level (dBμV)	Antenna Factor (dB/m)	Cable Loss (dB)	Preamp Factor (dB)	Ant Pos (cm)	Table Pos (deg)	Peak Avg. (P/A)	Pol. (H/V)
802.11ac VHT80 CH 106 5530MHz		5450.32	63.2	-10.8	74	54.58	32.35	9.29	33.02	224	115	P	H
		5468.56	64.79	-3.41	68.2	56.13	32.37	9.31	33.02	224	115	P	H
		5452.48	53.73	-0.27	54	45.11	32.35	9.29	33.02	224	115	A	H
	*	5530	102.78	-	-	94	32.44	9.39	33.05	224	115	P	H
	*	5530	95.09	-	-	86.31	32.44	9.39	33.05	224	115	A	H
		5756.18	50.6	-17.6	68.2	40.82	33.02	9.92	33.16	224	115	P	H
		5456.32	58.24	-15.76	74	49.62	32.35	9.29	33.02	222	121	P	V
		5460.4	56.91	-11.29	68.2	48.29	32.35	9.29	33.02	222	121	P	V
		5457.76	50.87	-3.13	54	42.25	32.35	9.29	33.02	222	121	A	V
	*	5530	98.11	-	-	89.33	32.44	9.39	33.05	222	121	P	V
	*	5530	90.81	-	-	82.03	32.44	9.39	33.05	222	121	A	V
		5764.685	49.89	-18.31	68.2	40.11	33.02	9.92	33.16	222	121	P	V
802.11ac VHT80 CH 122 5610MHz		5464.8	54.54	-19.46	74	45.9	32.37	9.29	33.02	216	118	P	H
		5460.6	46.02	-7.98	54	37.4	32.35	9.29	33.02	216	118	A	H
	*	5610	106.37	-	-	97.27	32.65	9.53	33.08	216	118	P	H
	*	5610	98.26	-	-	89.16	32.65	9.53	33.08	216	118	A	H
		5733.815	58.4	-15.6	74	48.79	32.94	9.82	33.15	216	118	P	H
		5734.445	50.37	-3.63	54	40.76	32.94	9.82	33.15	216	118	A	H
		5470	50.97	-23.03	74	42.31	32.37	9.31	33.02	219	136	P	V
		5467.95	44.17	-9.83	54	35.51	32.37	9.31	33.02	219	136	A	V
	*	5610	102.31	-	-	93.21	32.65	9.53	33.08	219	136	P	V
	*	5610	94.29	-	-	85.19	32.65	9.53	33.08	219	136	A	V
	5725.625	52.71	-21.29	74	43.08	32.94	9.82	33.13	219	136	P	V	
	5726.885	47.64	-6.36	54	38.01	32.94	9.82	33.13	219	136	A	V	
Remark	1. No other spurious found. 2. All results are PASS against Peak and Average limit line.												



Band 3 5470~5725MHz
WIFI 802.11ac VHT80 (Harmonic @ 3m)

WIFI Ant. 1+2	Note	Frequency (MHz)	Level (dBμV/m)	Over Limit (dB)	Limit Line (dBμV/m)	Read Level (dBμV)	Antenna Factor (dB/m)	Cable Loss (dB)	Preamp Factor (dB)	Ant Pos (cm)	Table Pos (deg)	Peak Avg. (P/A)	Pol. (H/V)	
802.11ac VHT80 CH 106 5530MHz		11060	49.19	-24.81	74	59.49	39.11	15.44	65.14	100	0	P	H	
		16590	45.37	-22.83	68.2	52.81	37.76	19.51	65.01	100	0	P	H	
													H	
													H	
			11060	46.25	-27.75	74	56.84	39.11	15.44	65.14	100	0	P	V
			16590	45.3	-22.9	68.2	52.74	37.76	19.51	65.01	100	0	P	V
														V
802.11ac VHT80 CH 122 5610MHz		11220	52.82	-21.18	74	63.28	38.9	15.58	65.23	100	237	P	H	
		11220	42.68	-11.32	54	53.14	38.9	15.58	65.23	100	237	A	H	
		16830	47.44	-26.56	74	52.62	39.59	19.67	64.77	100	0	P	H	
													H	
			11220	48.43	-25.57	74	59.18	38.9	15.58	65.23	100	0	P	V
			16830	46.89	-27.11	74	52.07	39.59	19.67	64.77	100	0	P	V
														V
Remark	1. No other spurious found.													
	2. All results are PASS against Peak and Average limit line.													



Band 3 - Straddle Channel
WIFI 802.11a (Band Edge @ 3m)

WIFI	Note	Frequency	Level	Over	Limit	Read	Antenna	Cable	Preamp	Ant	Table	Peak	Pol.	
Ant.				Limit	Line	Level	Factor	Loss	Factor	Pos	Pos	Avg.		
1+2		(MHz)	(dBμV/m)	(dB)	(dBμV/m)	(dBμV)	(dB/m)	(dB)	(dB)	(cm)	(deg)	(P/A)	(H/V)	
802.11a CH 144 5720MHz	*	5720	111.49	-	-	101.86	32.94	9.82	33.13	100	116	P	H	
	*	5720	101.81	-	-	92.18	32.94	9.82	33.13	100	116	A	H	
													H	
													H	
													H	
	*	5720	108.32	-	-	98.69	32.94	9.82	33.13	100	116	P	V	
	*	5720	99.32	-	-	89.69	32.94	9.82	33.13	100	116	A	V	
														V
														V
														V
														V
	Remark	1. No other spurious found. 2. All results are PASS against Peak and Average limit line.												



Band 3 - Straddle Channel
WIFI 802.11a (Harmonic @ 3m)

WIFI Ant. 1+2	Note	Frequency (MHz)	Level (dBμV/m)	Over Limit (dB)	Limit Line (dBμV/m)	Read Level (dBμV)	Antenna Factor (dB/m)	Cable Loss (dB)	Preamp Factor (dB)	Ant Pos (cm)	Table Pos (deg)	Peak Avg. (P/A)	Pol. (H/V)	
802.11a CH 144 5720MHz		11440	53.02	-20.98	74	63.74	38.59	15.77	65.36	100	211	P	H	
		11440	42.03	-11.97	54	52.75	38.59	15.77	65.36	100	211	A	H	
		17160	50.97	-23.03	74	54.35	40.8	19.84	64.37	100	0	P	H	
													H	
			11440	49.21	-24.79	74	59.93	38.59	15.77	65.36	100	0	P	V
			17160	49.82	-24.18	74	53.2	40.8	19.84	64.37	100	0	P	V
														V
Remark	1. No other spurious found.													
	2. All results are PASS against Peak and Average limit line.													



Band 3 - Straddle Channel
WIFI 802.11n HT20 (Band Edge @ 3m)

WIFI Ant. 1+2	Note	Frequency (MHz)	Level (dBμV/m)	Over Limit (dB)	Limit Line (dBμV/m)	Read Level (dBμV)	Antenna Factor (dB/m)	Cable Loss (dB)	Preamp Factor (dB)	Ant Pos (cm)	Table Pos (deg)	Peak Avg. (P/A)	Pol. (H/V)
802.11n HT20 CH 144 5720MHz	*	5720	111.14	-	-	101.51	32.94	9.82	33.13	100	116	P	H
	*	5720	101.92	-	-	92.29	32.94	9.82	33.13	100	116	A	H
													H
													H
													H
													H
	*	5720	108.07	-	-	98.44	32.94	9.82	33.13	100	116	P	V
	*	5720	98.71	-	-	89.08	32.94	9.82	33.13	100	116	A	V
													V
													V
												V	
												V	
Remark	1. No other spurious found. 2. All results are PASS against Peak and Average limit line.												



Band 3 - Straddle Channel
WIFI 802.11n HT20 (Harmonic @ 3m)

Table with 14 columns: WIFI Ant. 1+2, Note, Frequency (MHz), Level (dBµV/m), Over Limit (dB), Limit Line (dBµV/m), Read Level (dBµV), Antenna Factor (dB/m), Cable Loss (dB), Preamp Factor (dB), Ant Pos (cm), Table Pos (deg), Peak Avg. (P/A), Pol. (H/V). Rows include data for 802.11n HT20 CH 144 5720MHz and a Remark section.



**Band 3 - Straddle Channel
WIFI 802.11n HT40 (Band Edge @ 3m)**

WIFI Ant. 1+2	Note	Frequency (MHz)	Level (dBμV/m)	Over Limit (dB)	Limit Line (dBμV/m)	Read Level (dBμV)	Antenna Factor (dB/m)	Cable Loss (dB)	Preamp Factor (dB)	Ant Pos (cm)	Table Pos (deg)	Peak Avg. (P/A)	Pol. (H/V)
802.11n HT40 CH 142 5710MHz	*	5710	107.75	-	-	98.21	32.9	9.77	33.13	100	115	P	H
	*	5710	98.63	-	-	89.09	32.9	9.77	33.13	100	115	A	H
													H
													H
													H
													H
	*	5710	105.22	-	-	95.68	32.9	9.77	33.13	100	115	P	V
	*	5710	96.58	-	-	87.04	32.9	9.77	33.13	100	115	A	V
													V
													V
Remark	1. No other spurious found. 2. All results are PASS against Peak and Average limit line.												



Band 3 - Straddle Channel
WIFI 802.11n HT40 (Harmonic @ 3m)

Table with 14 columns: WIFI Ant. 1+2, Note, Frequency (MHz), Level (dBµV/m), Over Limit (dB), Limit Line (dBµV/m), Read Level (dBµV), Antenna Factor (dB/m), Cable Loss (dB), Preamp Factor (dB), Ant Pos (cm), Table Pos (deg), Peak Avg. (P/A), Pol. (H/V). Rows include data for 802.11n HT40 CH 142 at 5710MHz and a Remark section.



Band 3 - Straddle Channel
WIFI 802.11ac VHT20 (Band Edge @ 3m)

WIFI Ant. 1+2	Note	Frequency (MHz)	Level (dBμV/m)	Over Limit (dB)	Limit Line (dBμV/m)	Read Level (dBμV)	Antenna Factor (dB/m)	Cable Loss (dB)	Preamp Factor (dB)	Ant Pos (cm)	Table Pos (deg)	Peak Avg. (P/A)	Pol. (H/V)
802.11ac VHT20 CH 144 5720MHz	*	5720	111.06	-	-	101.43	32.94	9.82	33.13	100	116	P	H
	*	5720	101.71	-	-	92.08	32.94	9.82	33.13	100	116	A	H
													H
													H
													H
													H
	*	5720	107.68	-	-	98.05	32.94	9.82	33.13	100	116	P	V
	*	5720	99	-	-	89.37	32.94	9.82	33.13	100	116	A	V
													V
													V
												V	
												V	
Remark	1. No other spurious found. 2. All results are PASS against Peak and Average limit line.												



Band 3 - Straddle Channel
WIFI 802.11ac VHT20 (Harmonic @ 3m)

WIFI Ant. 1+2	Note	Frequency (MHz)	Level (dBμV/m)	Over Limit (dB)	Limit Line (dBμV/m)	Read Level (dBμV)	Antenna Factor (dB/m)	Cable Loss (dB)	Preamp Factor (dB)	Ant Pos (cm)	Table Pos (deg)	Peak Avg. (P/A)	Pol. (H/V)	
802.11ac VHT20 CH 144 5720MHz		11440	53.34	-20.66	74	64.06	38.59	15.77	65.36	100	235	P	H	
		11440	42.69	-11.31	54	53.41	38.59	15.77	65.36	100	235	A	H	
		17160	50.76	-23.24	74	54.14	40.8	19.84	64.37	100	0	P	H	
													H	
			11440	49.15	-24.85	74	59.87	38.59	15.77	65.36	100	0	P	V
			17160	48.89	-25.11	74	52.27	40.8	19.84	64.37	100	0	P	V
														V
Remark	1. No other spurious found.													
	2. All results are PASS against Peak and Average limit line.													



Band 3 - Straddle Channel
WIFI 802.11ac VHT40 (Band Edge @ 3m)

WIFI Ant. 1+2	Note	Frequency (MHz)	Level (dBμV/m)	Over Limit (dB)	Limit Line (dBμV/m)	Read Level (dBμV)	Antenna Factor (dB/m)	Cable Loss (dB)	Preamp Factor (dB)	Ant Pos (cm)	Table Pos (deg)	Peak Avg. (P/A)	Pol. (H/V)
802.11ac VHT40 CH 142 5710MHz	*	5710	107.86	-	-	98.32	32.9	9.77	33.13	100	115	P	H
	*	5710	98.89	-	-	89.35	32.9	9.77	33.13	100	115	A	H
													H
													H
													H
													H
	*	5710	105.48	-	-	95.94	32.9	9.77	33.13	100	115	P	V
	*	5710	96.55	-	-	87.01	32.9	9.77	33.13	100	115	A	V
													V
													V
												V	
												V	
Remark	1. No other spurious found. 2. All results are PASS against Peak and Average limit line.												



Band 3 - Straddle Channel
WIFI 802.11ac VHT40 (Harmonic @ 3m)

WIFI Ant. 1+2	Note	Frequency (MHz)	Level (dBµV/m)	Over Limit (dB)	Limit Line (dBµV/m)	Read Level (dBµV)	Antenna Factor (dB/m)	Cable Loss (dB)	Preamp Factor (dB)	Ant Pos (cm)	Table Pos (deg)	Peak Avg. (P/A)	Pol. (H/V)	
802.11ac VHT40 CH 142 5710MHz		11420	53.27	-20.73	74	63.97	38.62	15.75	65.35	100	210	P	H	
		11420	43.07	-10.93	54	53.77	38.62	15.75	65.35	100	210	A	H	
		17130	49.63	-24.37	74	53.04	40.82	19.83	64.41	100	0	P	H	
													H	
			11420	47.7	-26.3	74	58.4	38.62	15.75	65.35	100	0	P	V
			17130	50.57	-23.43	74	53.98	40.82	19.83	64.41	100	0	P	V
														V
Remark	1. No other spurious found.													
	2. All results are PASS against Peak and Average limit line.													



Band 3 - Straddle Channel
WIFI 802.11ac VHT80 (Band Edge @ 3m)

WIFI Ant. 1+2	Note	Frequency (MHz)	Level (dBμV/m)	Over Limit (dB)	Limit Line (dBμV/m)	Read Level (dBμV)	Antenna Factor (dB/m)	Cable Loss (dB)	Preamp Factor (dB)	Ant Pos (cm)	Table Pos (deg)	Peak Avg. (P/A)	Pol. (H/V)
802.11ac VHT80 CH 138 5690MHz	*	5690	105.43	-	-	95.97	32.86	9.72	33.12	100	115	P	H
	*	5690	96.6	-	-	87.14	32.86	9.72	33.12	100	115	A	H
													H
													H
													H
													H
	*	5690	102.93	-	-	93.47	32.86	9.72	33.12	100	115	P	V
	*	5690	94	-	-	84.54	32.86	9.72	33.12	100	115	A	V
													V
													V
												V	
												V	
Remark	1. No other spurious found. 2. All results are PASS against Peak and Average limit line.												



Band 3 - Straddle Channel
WIFI 802.11ac VHT80 (Harmonic @ 3m)

WIFI Ant. 1+2	Note	Frequency (MHz)	Level (dBµV/m)	Over Limit (dB)	Limit Line (dBµV/m)	Read Level (dBµV)	Antenna Factor (dB/m)	Cable Loss (dB)	Preamp Factor (dB)	Ant Pos (cm)	Table Pos (deg)	Peak Avg. (P/A)	Pol. (H/V)	
802.11ac VHT80 CH 138 5690MHz		11380	49.29	-24.71	74	59.95	38.66	15.72	65.33	100	0	P	H	
		17070	49.51	-24.49	74	53	40.86	19.81	64.51	100	0	P	H	
													H	
													H	
			11380	47.31	-26.69	74	57.97	38.66	15.72	65.33	100	0	P	V
			17070	49.34	-24.66	74	52.83	40.86	19.81	64.51	100	0	P	V
														V
Remark	1. No other spurious found.													
	2. All results are PASS against Peak and Average limit line.													



Emission below 1GHz
WIFI 802.11ac VHT80 (LF @ 3m)

WIFI	Note	Frequency	Level	Over	Limit	Read	Antenna	Cable	Preamp	Ant	Table	Peak	Pol.	
Ant.				Limit	Line	Level	Factor	Loss	Factor	Pos	Pos	Avg.		
1+2		(MHz)	(dBμV/m)	(dB)	(dBμV/m)	(dBμV)	(dB/m)	(dB)	(dB)	(cm)	(deg)	(P/A)	(H/V)	
802.11ac VHT80 LF		172.29	26.55	-16.95	43.5	41.87	15.32	1.69	32.42			P	H	
		218.46	28.69	-17.31	46	44.04	15.18	1.8	32.39			P	H	
		267.6	30.21	-15.79	46	41.08	19.39	2.04	32.38			P	H	
		462.4	33.26	-12.74	46	39.4	23.43	2.75	32.36			P	H	
		560.4	31.81	-14.19	46	34.88	26.25	3.02	32.43			P	H	
		957.3	33.41	-12.59	46	29.41	31.1	3.87	31.14	162	245	P	H	
													H	
													H	
													H	
													H	
													H	
													H	
			43.77	34.38	-5.62	40	48.74	17.19	0.94	32.49	187	156	P	V
			81.57	22.25	-17.75	40	40.08	13.42	1.22	32.48			P	V
			193.08	24.84	-18.66	43.5	40.65	14.8	1.72	32.4			P	V
			459.6	33.98	-12.02	46	40.17	23.38	2.75	32.36			P	V
			558.3	29.25	-16.75	46	32.43	26.18	2.98	32.43			P	V
			859.3	32.35	-13.65	46	31	29.4	3.67	31.87			P	V
														V
														V
													V	
													V	
													V	
													V	
Remark	1. No other spurious found. 2. All results are PASS against limit line.													



VHT80 + VHT80 Mode

Ant. 1 802.11ac VHT80 CH106 and Ant. 2 802.11ac VHT80 CH155 (Harmonic @ 3m)

WIFI Ant. 1+2	Note	Frequency (MHz)	Level (dBμV/m)	Over Limit (dB)	Limit Line (dBμV/m)	Read Level (dBμV)	Antenna Factor (dB/m)	Cable Loss (dB)	Preamp Factor (dB)	Ant Pos (cm)	Table Pos (deg)	Peak Avg. (P/A)	Pol. (H/V)
Ant. 1 802.11ac VHT80 CH106 5530MHz		245	18.84	-27.16	46	31.27	17.93	1.95	32.38	100	0	P	H
		11305	46.51	-27.49	74	57.08	38.78	15.64	65.28	100	0	P	H
													H
													H
													H
+ Ant. 2 802.11ac VHT80 CH155 5775MHz		245	17.68	-28.32	46	30.11	17.93	1.95	32.38	100	0	P	V
		11305	45.87	-28.13	74	56.73	38.78	15.64	65.28	100	0	P	V
													V
													V
													V



Emission below 1GHz

Ant. 1 802.11ac VHT80 CH106 and Ant. 2 802.11ac VHT80 CH155 (LF @ 3m)

WIFI Ant. 1+2	Note	Frequency (MHz)	Level (dBμV/m)	Over Limit (dB)	Limit Line (dBμV/m)	Read Level (dBμV)	Antenna Factor (dB/m)	Cable Loss (dB)	Preamp Factor (dB)	Ant Pos (cm)	Table Pos (deg)	Peak Avg. (P/A)	Pol. (H/V)	
Ant. 1 802.11ac VHT80 CH106 5530MHz + Ant. 2 802.11ac VHT80 CH155 5775MHz		67.8	30.59	-9.41	40	49.88	12.12	1.06	32.49	178	225	P	H	
		170.13	23.63	-19.87	43.5	38.73	15.53	1.69	32.42			P	H	
		219.27	24.73	-21.27	46	39.98	15.2	1.88	32.39			P	H	
		245	18.84	-27.16	46	31.27	17.93	1.95	32.38			P	H	
		363.7	24.56	-21.44	46	33.69	20.71	2.45	32.34			P	H	
		458.2	26.56	-19.44	46	32.78	23.35	2.75	32.36			P	H	
		891.5	32.6	-13.4	46	31.18	29.18	3.79	31.71			P	H	
														H
														H
														H
														H
			45.66	30.23	-9.77	40	45.55	16.23	0.94	32.49	152	239	P	V
			81.57	22.58	-17.42	40	40.41	13.42	1.22	32.48			P	V
			220.62	22.14	-23.86	46	37.28	15.31	1.88	32.39			P	V
		245	17.68	-28.32	46	30.11	17.93	1.95	32.38			P	V	
		461	28.99	-17.01	46	35.16	23.4	2.75	32.36			P	V	
		839	31.23	-14.77	46	30.51	28.92	3.63	31.98			P	V	
		884.5	32.19	-13.81	46	30.78	29.2	3.79	31.74			P	V	
													V	
													V	
													V	
													V	
													V	
Remark	1. No other spurious found. 2. All results are PASS against limit line.													



Co-location mode

802.11n HT20 CH11 and 802.11n HT40 CH151 (Harmonic @ 3m)

WIFI	Note	Frequency	Level	Over	Limit	Read	Antenna	Cable	Preamp	Ant	Table	Peak	Pol.	
Ant.				Limit	Line	Level	Factor	Loss	Factor	Pos	Pos	Avg.		
1+2		(MHz)	(dBμV/m)	(dB)	(dBμV/m)	(dBμV)	(dB/m)	(dB)	(dB)	(cm)	(deg)	(P/A)	(H/V)	
802.11n HT20 CH11 2462MHz + 802.11n HT40 CH151 5755MHz		3293	45.34	-28.66	74	42.81	28.72	7.24	33.43	100	0	P	H	
		6586	53.82	-20.18	74	42.36	34.68	10.25	33.47	100	0	P	H	
		8217	57.48	-16.52	74	43.53	36.91	11.31	34.27	100	0	P	H	
		16434	45.6	-28.4	74	54.06	36.94	19.4	65.09	100	0	P	H	
													H	
													H	
			3293	45.87	-28.13	74	43.34	28.72	7.24	33.43	100	0	P	V
			6586	53.9	-20.1	74	42.44	34.68	10.25	33.47	100	0	P	V
			8217	58.09	-15.91	74	44.14	36.91	11.31	34.27	100	0	P	V
			16434	44.22	-29.78	74	52.97	36.94	19.4	65.09	100	0	P	V
													V	
													V	



802.11n HT20 CH11 and 802.11n HT40 CH151 (LF)

WIFI	Note	Frequency	Level	Over	Limit	Read	Antenna	Cable	Preamp	Ant	Table	Peak	Pol.	
Ant.				Limit	Line	Level	Factor	Loss	Factor	Pos	Pos	Avg.		
1+2		(MHz)	(dBμV/m)	(dB)	(dBμV/m)	(dBμV)	(dB/m)	(dB)	(dB)	(cm)	(deg)	(P/A)	(H/V)	
802.11n HT20 CH11 2462MHz + 802.11n HT40 CH151 5755MHz LF		171.75	22.51	-20.99	43.5	37.76	15.39	1.69	32.42			P	H	
		193.89	24.24	-19.26	43.5	40.03	14.82	1.72	32.4			P	H	
		217.65	26	-20	46	41.36	15.17	1.8	32.39			P	H	
		364.4	27.04	-18.96	46	36.15	20.73	2.45	32.34			P	H	
		460.3	30.55	-15.45	46	36.72	23.4	2.75	32.36			P	H	
		876.8	32.13	-13.87	46	30.77	29.25	3.73	31.78	341	206	P	H	
													H	
													H	
													H	
													H	
													H	
													H	
													H	
													H	
			44.85	29.44	-10.56	40	44.34	16.65	0.94	32.49	155	334	P	V
			171.48	25.82	-17.68	43.5	41.07	15.39	1.69	32.42			P	V
		195.78	25.16	-18.34	43.5	40.9	14.86	1.72	32.39			P	V	
		461.7	29.87	-16.13	46	36.02	23.42	2.75	32.36			P	V	
		789.3	30.46	-15.54	46	30.71	28.31	3.5	32.21			P	V	
		902	32.56	-13.44	46	31.05	29.19	3.8	31.64			P	V	
												V		
												V		
												V		
												V		
												V		
												V		
												V		
Remark	1. No other spurious found. 2. All results are PASS against limit line.													



Note symbol

*	Fundamental Frequency which can be ignored. However, the level of any unwanted emissions shall not exceed the level of the fundamental frequency.
!	Test result is over limit line.
P/A	Peak or Average
H/V	Horizontal or Vertical



A calculation example for radiated spurious emission is shown as below:

WIFI	Note	Frequency	Level	Over	Limit	Read	Antenna	Cable	Preamp	Ant	Table	Peak	Pol.
Ant.				Limit	Line	Level	Factor	Loss	Factor	Pos	Pos	Avg.	
1+2		(MHz)	(dBμV/m)	(dB)	(dBμV/m)	(dBμV)	(dB/m)	(dB)	(dB)	(cm)	(deg)	(P/A)	(H/V)
802.11b		2390	55.45	-18.55	74	54.51	32.22	4.58	35.86	103	308	P	H
CH 01													
2412MHz		2390	43.54	-10.46	54	42.6	32.22	4.58	35.86	103	308	A	H

- Level(dBμV/m) =
Antenna Factor(dB/m) + Cable Loss(dB) + Read Level(dBμV) - Preamp Factor(dB)
- Over Limit(dB) = Level(dBμV/m) – Limit Line(dBμV/m)

For Peak Limit @ 2390MHz:

- Level(dBμV/m)
= Antenna Factor(dB/m) + Cable Loss(dB) + Read Level(dBμV) - Preamp Factor(dB)
= 32.22(dB/m) + 4.58(dB) + 54.51(dBμV) – 35.86 (dB)
= 55.45 (dBμV/m)
- Over Limit(dB)
= Level(dBμV/m) – Limit Line(dBμV/m)
= 55.45(dBμV/m) – 74(dBμV/m)
= -18.55(dB)

For Average Limit @ 2390MHz:

- Level(dBμV/m)
= Antenna Factor(dB/m) + Cable Loss(dB) + Read Level(dBμV) - Preamp Factor(dB)
= 32.22(dB/m) + 4.58(dB) + 42.6(dBμV) – 35.86 (dB)
= 43.54 (dBμV/m)
- Over Limit(dB)
= Level(dBμV/m) – Limit Line(dBμV/m)
= 43.54(dBμV/m) – 54(dBμV/m)
= -10.46(dB)

Both peak and average measured complies with the limit line, so test result is “PASS”.



Appendix C. Radiated Spurious Emission

Test Engineer :	J.C. Liang, Jacky Hung, and Kan Wu	Temperature :	18~22°C
		Relative Humidity :	55~58%

Note symbol

-L	Low channel location
-R	High channel location

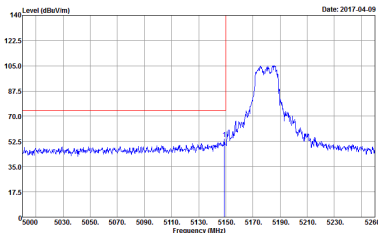
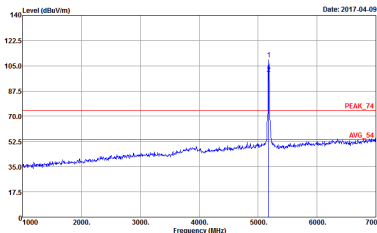
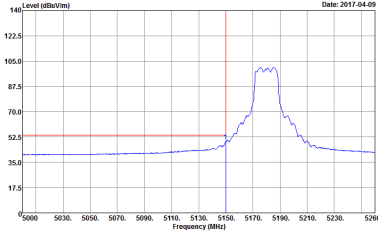

Band 1 - 5150~5250MHz
WIFI 802.11a (Band Edge @ 3m)

WIFI	Band 1 5150~5250MHz Band Edge @ 3m	
ANT	802.11a CH36 5180MHz	
1+2	Horizontal	Fundamental
<p>Peak</p>	 <p>Site : 03CH11-HY Condition : PEAK_BE_74 3m HORN 9120D-HF HORIZONTAL : RBW:1000.000KHz VBW:3000.000KHz SWT:Auto</p>	 <p>Site : 03CH11-HY Condition : PEAK_74 3m HORN 9120D-HF HORIZONTAL : RBW:1000.000KHz VBW:3000.000KHz SWT:Auto</p>
<p>Avg.</p>	 <p>Site : 03CH11-HY Condition : AVG_BE_54 3m HORN 9120D-HF HORIZONTAL : RBW:1000.000KHz VBW:1.000KHz SWT:Auto</p>	<p align="center">Left blank</p>



WIFI	Band 1 5150~5250MHz Band Edge @ 3m	
ANT	802.11a CH36 5180MHz	
1+2	Vertical	Fundamental
Peak	<p>Site : 03CHI1-HY Condition : PEAK_BE_74 3m HORN 9120D-HF VERTICAL : RBW:1000.000KHz VBW:3000.000KHz SWT:Auto</p>	<p>Site : 03CHI1-HY Condition : PEAK_74 3m HORN 9120D-HF VERTICAL : RBW:1000.000KHz VBW:3000.000KHz SWT:Auto</p>
Avg.	<p>Site : 03CHI1-HY Condition : AVG_BE_54 3m HORN 9120D-HF VERTICAL : RBW:1000.000KHz VBW:1.000KHz SWT:Auto</p>	Left blank



WIFI	Band 1 5150~5250MHz Band Edge @ 3m	
ANT	802.11a CH44 5220MHz - L	
1+2	Horizontal	Fundamental
Peak	<p>Site : 03CH11-HY Condition : PEAK_BE_74 3m HORN 9120D-HF HORIZONTAL : RBW:1000.000KHz VBW:3000.000KHz SWT:Auto</p>	<p>Site : 03CH11-HY Condition : PEAK_74 3m HORN 9120D-HF HORIZONTAL : RBW:1000.000KHz VBW:3000.000KHz SWT:Auto</p>
Avg.	<p>Site : 03CH11-HY Condition : AVG_BE_54 3m HORN 9120D-HF HORIZONTAL : RBW:1000.000KHz VBW:1.000KHz SWT:Auto</p>	Left blank



WIFI	Band 1 5150~5250MHz Band Edge @ 3m	
ANT	802.11a CH44 5220MHz - R	
1+2	Horizontal	Fundamental
Peak	<p>Site : 03CH11-HY Condition : PEAK_BE_74 3m HORN 91200-HF HORIZONTAL : RBW:1000.000KHz VBW:3000.000KHz SWT:Auto</p>	Left blank
Avg.	<p>Site : 03CH11-HY Condition : AVG_BE_54 3m HORN 91200-HF HORIZONTAL : RBW:1000.000KHz VBW:1.000KHz SWT:Auto</p>	Left blank



WIFI	Band 1 5150~5250MHz Band Edge @ 3m	
ANT	802.11a CH44 5220MHz - L	
1+2	Vertical	Fundamental
Peak	<p>Site : 03CHI1-HY Condition : PEAK_BE_74 3m HORN 91200-HF VERTICAL : RBW:1000.000KHz VBW:3000.000KHz SWT:Auto</p>	<p>Site : 03CHI1-HY Condition : PEAK_74 3m HORN 91200-HF VERTICAL : RBW:1000.000KHz VBW:3000.000KHz SWT:Auto</p>
Avg.	<p>Site : 03CHI1-HY Condition : AVG_BE_54 3m HORN 91200-HF VERTICAL : RBW:1000.000KHz VBW:1.000KHz SWT:Auto</p>	Left blank

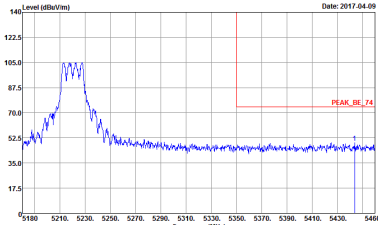
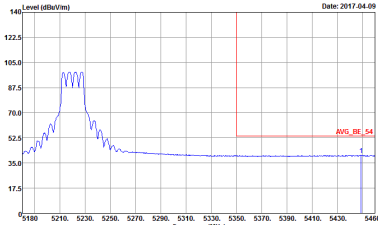

WIFI	Band 1 5150~5250MHz Band Edge @ 3m	
ANT	802.11a CH44 5220MHz - R	
1+2	Vertical	Fundamental
<p>Peak</p>	 <p>Site : 03CH11-HY Condition : PEAK_BE_74 3m HORN 91200-HF VERTICAL : RBW:1000.000KHz VBW:3000.000KHz SWT:Auto</p>	<p>Left blank</p>
<p>Avg.</p>	 <p>Site : 03CH11-HY Condition : AVG_BE_54 3m HORN 91200-HF VERTICAL : RBW:1000.000KHz VBW:1.000KHz SWT:Auto</p>	<p>Left blank</p>

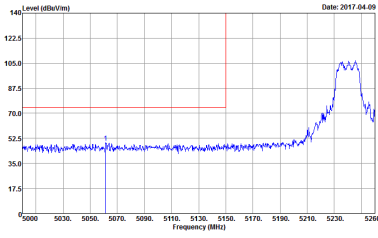
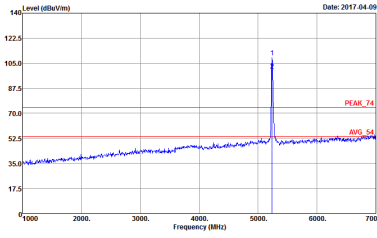
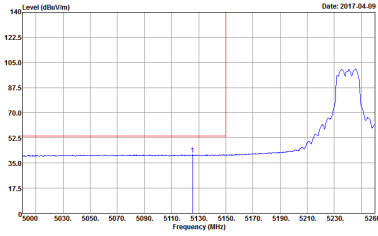

WIFI	Band 1 5150~5250MHz Band Edge @ 3m	
ANT	802.11a CH48 5240MHz - L	
1+2	Horizontal	Fundamental
Peak	 <p>Site : 03CH11-HY Condition : PEAK_BE_74 3m HORN 91200-HF HORIZONTAL : RBW:1000.000KHz VBW:3000.000KHz SWT:Auto</p>	 <p>Site : 03CH11-HY Condition : PEAK_74 3m HORN 91200-HF HORIZONTAL : RBW:1000.000KHz VBW:3000.000KHz SWT:Auto</p>
Avg.	 <p>Site : 03CH11-HY Condition : AVG_BE_54 3m HORN 91200-HF HORIZONTAL : RBW:1000.000KHz VBW:1.000KHz SWT:Auto</p>	Left blank

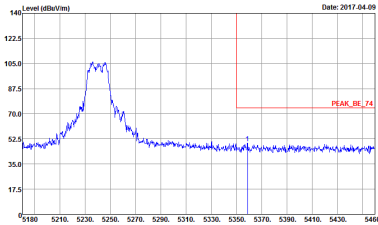
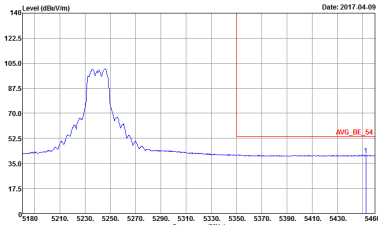

WIFI	Band 1 5150~5250MHz Band Edge @ 3m	
ANT	802.11a CH48 5240MHz - R	
1+2	Horizontal	Fundamental
<p>Peak</p>	 <p>Site : 03CHI1-HY Condition : PEAK_BE_74 3m HORN 91200-HF HORIZONTAL : RBW:1000.000KHz VBW:3000.000KHz SWT:Auto</p>	<p>Left blank</p>
<p>Avg.</p>	 <p>Site : 03CHI1-HY Condition : AVG_BE_54 3m HORN 91200-HF HORIZONTAL : RBW:1000.000KHz VBW:1.000KHz SWT:Auto</p>	<p>Left blank</p>

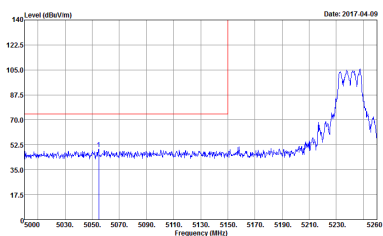
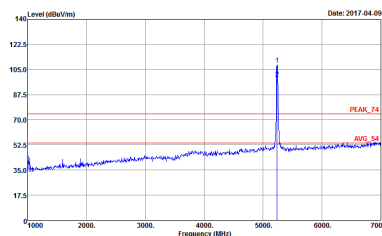
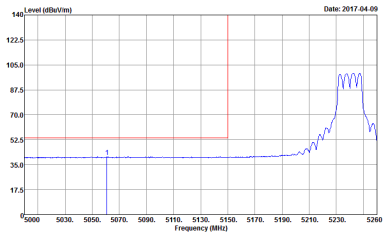

WIFI	Band 1 5150~5250MHz Band Edge @ 3m	
ANT	802.11a CH48 5240MHz - L	
1+2	Vertical	Fundamental
<p>Peak</p>	 <p>Site : 03CH11-HY Condition : PEAK_BE_74 3m HORN 9120D-HF VERTICAL : RBW:1000.000KHz VBW:3000.000KHz SWT:Auto</p>	 <p>Site : 03CH11-HY Condition : PEAK_74 3m HORN 9120D-HF VERTICAL : RBW:1000.000KHz VBW:3000.000KHz SWT:Auto</p>
<p>Avg.</p>	 <p>Site : 03CH11-HY Condition : AVG_BE_54 3m HORN 9120D-HF VERTICAL : RBW:1000.000KHz VBW:1.000KHz SWT:Auto</p>	<p>Left blank</p>

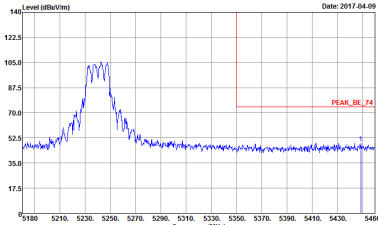
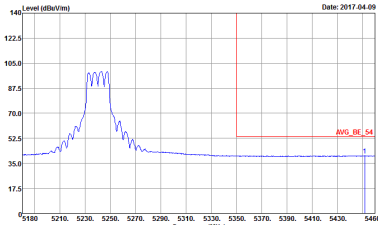

WIFI	Band 1 5150~5250MHz Band Edge @ 3m	
ANT	802.11a CH48 5240MHz - R	
1+2	Vertical	Fundamental
Peak	 <p>Site : 03CH11-HY Condition : PEAK_BE_74 3m HORN 91200-HF VERTICAL : RBW:1000.000KHz VBW:3000.000KHz SWT:Auto</p>	Left blank
Avg.	 <p>Site : 03CH11-HY Condition : AVG_BE_54 3m HORN 91200-HF VERTICAL : RBW:1000.000KHz VBW:1.000KHz SWT:Auto</p>	Left blank



**Band 1 5150~5250MHz
WIFI 802.11n HT20 (Band Edge @ 3m)**

WIFI	Band 1 5150~5250MHz Band Edge @ 3m	
ANT	802.11n HT20 CH36 5180MHz	
1+2	Horizontal	Fundamental
Peak	<p>Site : 03CH11-HY Condition : PEAK_BE_74 3m HORN 9120D-HF HORIZONTAL : RBW:1000.000KHz VBW:3000.000KHz SWT:Auto</p>	<p>Site : 03CH11-HY Condition : PEAK_74 3m HORN 9120D-HF HORIZONTAL : RBW:1000.000KHz VBW:3000.000KHz SWT:Auto</p>
Avg.	<p>Site : 03CH11-HY Condition : AVG_BE_54 3m HORN 9120D-HF HORIZONTAL : RBW:1000.000KHz VBW:1000KHz SWT:Auto</p>	Left blank



WIFI	Band 1 5150~5250MHz Band Edge @ 3m	
ANT	802.11n HT20 CH36 5180MHz	
1+2	Vertical	Fundamental
Peak	<p>Site : 03CH11-HY Condition : PEAK_BE_74 3m HORN 9120D-HF VERTICAL : RBW:1000.000KHz VBW:3000.000KHz SWT:Auto</p>	<p>Site : 03CH11-HY Condition : PEAK_74 3m HORN 9120D-HF VERTICAL : RBW:1000.000KHz VBW:3000.000KHz SWT:Auto</p>
Avg.	<p>Site : 03CH11-HY Condition : AVG_BE_54 3m HORN 9120D-HF VERTICAL : RBW:1000.000KHz VBW:1.000KHz SWT:Auto</p>	Left blank

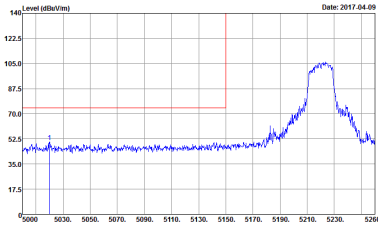
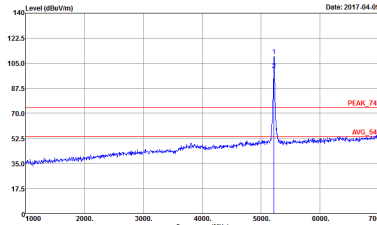
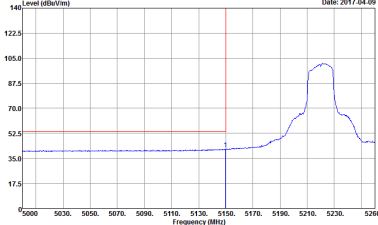

WIFI	Band 1 5150~5250MHz Band Edge @ 3m	
ANT	802.11n HT20 CH44 5220MHz - L	
1+2	Horizontal	Fundamental
<p>Peak</p>	 <p>Site : 03CH11-HY Condition : PEAK_BE_74 3m HORN 91200-HF HORIZONTAL : RBW:1000.000KHz VBW:3000.000KHz SWT:Auto</p>	 <p>Site : 03CH11-HY Condition : PEAK_74 3m HORN 91200-HF HORIZONTAL : RBW:1000.000KHz VBW:3000.000KHz SWT:Auto</p>
<p>Avg.</p>	 <p>Site : 03CH11-HY Condition : AVG_BE_54 3m HORN 91200-HF HORIZONTAL : RBW:1000.000KHz VBW:1.000KHz SWT:Auto</p>	<p>Left blank</p>



WIFI	Band 1 5150~5250MHz Band Edge @ 3m	
ANT	802.11n HT20 CH44 5220MHz - R	
1+2	Horizontal	Fundamental
<p>Peak</p>	<p>Site : 03CHI1-HY Condition : PEAK_BE_74 3m HORN 91200-HF HORIZONTAL : RBW:1000.000KHz VBW:3000.000KHz SWT:Auto</p>	<p>Left blank</p>
<p>Avg.</p>	<p>Site : 03CHI1-HY Condition : AVG_BE_54 3m HORN 91200-HF HORIZONTAL : RBW:1000.000KHz VBW:1.000KHz SWT:Auto</p>	<p>Left blank</p>

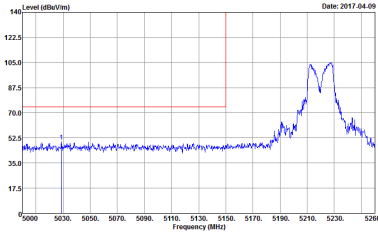
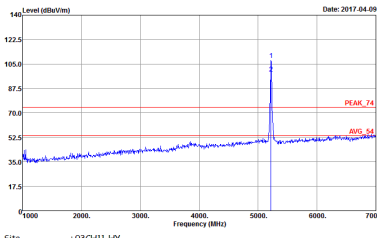
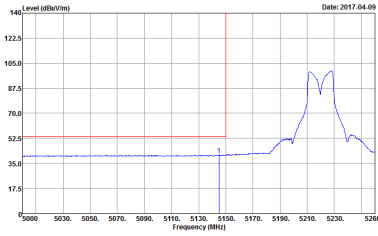

WIFI	Band 1 5150~5250MHz Band Edge @ 3m	
ANT	802.11n HT20 CH44 5220MHz - L	
1+2	Vertical	Fundamental
Peak	 <p>Site : 03CH11-HY Condition : PEAK_BE_74 3m HORN 91200-HF VERTICAL : RBW:1000.000KHz VBW:3000.000KHz SWT:Auto</p>	 <p>Site : 03CH11-HY Condition : PEAK_74 3m HORN 91200-HF VERTICAL : RBW:1000.000KHz VBW:3000.000KHz SWT:Auto</p>
Avg.	 <p>Site : 03CH11-HY Condition : AVG_BE_54 3m HORN 91200-HF VERTICAL : RBW:1000.000KHz VBW:1.000KHz SWT:Auto</p>	Left blank

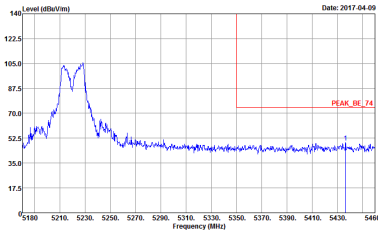
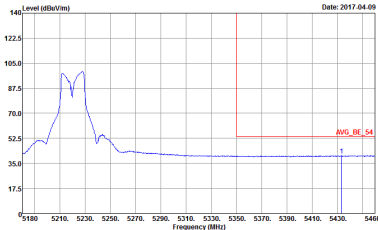

WIFI	Band 1 5150~5250MHz Band Edge @ 3m	
ANT	802.11n HT20 CH44 5220MHz - R	
1+2	Vertical	Fundamental
<p>Peak</p>	 <p>Site : 03CHI1-HY Condition : PEAK_BE_74 3m HORN 91200-HF VERTICAL : RBW:1000.000KHz VBW:3000.000KHz SWT:Auto</p>	<p>Left blank</p>
<p>Avg.</p>	 <p>Site : 03CHI1-HY Condition : AVG_BE_54 3m HORN 91200-HF VERTICAL : RBW:1000.000KHz VBW:1.000KHz SWT:Auto</p>	<p>Left blank</p>



WIFI	Band 1 5150~5250MHz Band Edge @ 3m	
ANT	802.11n HT20 CH48 5240MHz - L	
1+2	Horizontal	Fundamental
Peak	<p>Site : 03CH11-HY Condition : PEAK_BE_74 3m HORN 91200-HF HORIZONTAL : RBW:1000.000KHz VBW:3000.000KHz SWT:Auto</p>	<p>Site : 03CH11-HY Condition : PEAK_74 3m HORN 91200-HF HORIZONTAL : RBW:1000.000KHz VBW:3000.000KHz SWT:Auto</p>
Avg.	<p>Site : 03CH11-HY Condition : AVG_BE_54 3m HORN 91200-HF HORIZONTAL : RBW:1000.000KHz VBW:1.000KHz SWT:Auto</p>	Left blank

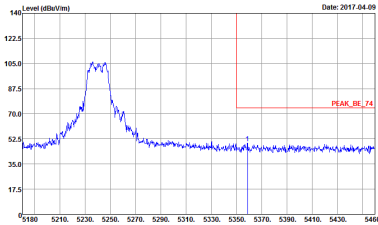
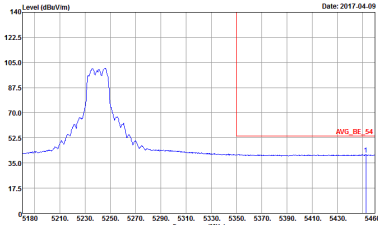

WIFI	Band 1 5150~5250MHz Band Edge @ 3m	
ANT	802.11n HT20 CH48 5240MHz - R	
1+2	Horizontal	Fundamental
<p>Peak</p>	 <p>Site : 03CHI1-HY Condition : PEAK_BE_74 3m HORN 91200-HF HORIZONTAL : RBW:1000.000KHz VBW:3000.000KHz SWT:Auto</p>	<p>Left blank</p>
<p>Avg.</p>	 <p>Site : 03CHI1-HY Condition : AVG_BE_54 3m HORN 91200-HF HORIZONTAL : RBW:1000.000KHz VBW:1.000KHz SWT:Auto</p>	<p>Left blank</p>

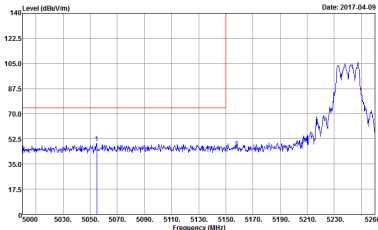
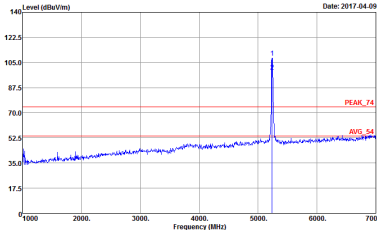
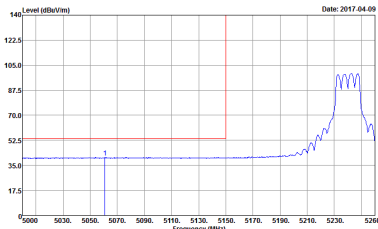

WIFI	Band 1 5150~5250MHz Band Edge @ 3m	
ANT	802.11n HT20 CH48 5240MHz - L	
1+2	Vertical	Fundamental
<p>Peak</p>	 <p>Site : 03CH11-HY Condition : PEAK_BE_74 3m HORN 91200-HF VERTICAL : RBW:1000.000KHz VBW:3000.000KHz SWT:Auto</p>	 <p>Site : 03CH11-HY Condition : PEAK_74 3m HORN 91200-HF VERTICAL : RBW:1000.000KHz VBW:3000.000KHz SWT:Auto</p>
<p>Avg.</p>	 <p>Site : 03CH11-HY Condition : AVG_BE_54 3m HORN 91200-HF VERTICAL : RBW:1000.000KHz VBW:1.000KHz SWT:Auto</p>	<p>Left blank</p>

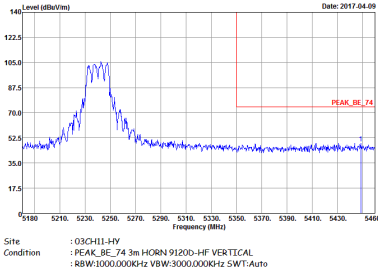
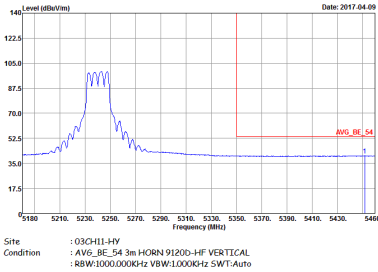

WIFI	Band 1 5150~5250MHz Band Edge @ 3m	
ANT	802.11n HT20 CH48 5240MHz - R	
1+2	Vertical	Fundamental
Peak		Left blank
Avg.		Left blank



**Band 1 5150~5250MHz
WIFI 802.11n HT40 (Band Edge @ 3m)**

WIFI	Band 1 5150~5250MHz Band Edge @ 3m	
ANT	802.11n HT40 CH38 5190MHz - L	
1+2	Horizontal	Fundamental
Peak	<p>Site : 03CH11-HY Condition : PEAK_BE_74 3m HORN 91200-HF HORIZONTAL : RBW:1000.000KHz VBW:3000.000KHz SWT:Auto</p>	<p>Site : 03CH11-HY Condition : PEAK_74 3m HORN 91200-HF HORIZONTAL : RBW:1000.000KHz VBW:3000.000KHz SWT:Auto</p>
Avg.	<p>Site : 03CH11-HY Condition : AVG_BE_54 3m HORN 91200-HF HORIZONTAL : RBW:1000.000KHz VBW:3000.000KHz SWT:Auto</p>	Left blank



WIFI	Band 1 5150~5250MHz Band Edge @ 3m	
ANT	802.11n HT40 CH38 5190MHz - R	
1+2	Horizontal	Fundamental
<p>Peak</p>		<p>Left blank</p>
<p>Avg.</p>		<p>Left blank</p>



WIFI	Band 1 5150~5250MHz Band Edge @ 3m	
ANT	802.11n HT40 CH38 5190MHz - L	
1+2	Vertical	Fundamental
<p>Peak</p>	<p>Site : 03CH11-HY Condition : PEAK_BE_74 3m HORN 9120D-HF VERTICAL : RBW:1000.000KHz VBW:3000.000KHz SWT:Auto</p>	<p>Site : 03CH11-HY Condition : PEAK_74 3m HORN 9120D-HF VERTICAL : RBW:1000.000KHz VBW:3000.000KHz SWT:Auto</p>
<p>Avg.</p>	<p>Site : 03CH11-HY Condition : AVG_BE_54 3m HORN 9120D-HF VERTICAL : RBW:1000.000KHz VBW:3.000KHz SWT:Auto</p>	<p>Left blank</p>

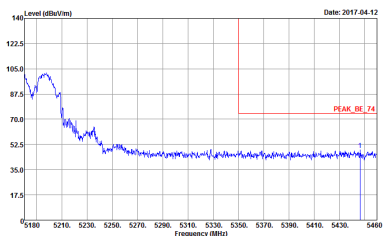
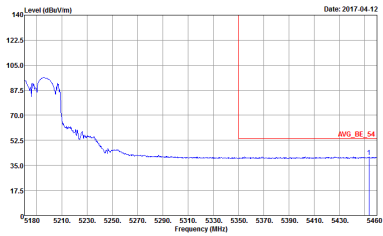

WIFI	Band 1 5150~5250MHz Band Edge @ 3m	
ANT	802.11n HT40 CH38 5190MHz - R	
1+2	Vertical	Fundamental
<p>Peak</p>	 <p>Site : 03CHI1-HY Condition : PEAK_BE_74 3m HORN 91200-HF VERTICAL : RBW:1000.000kHz VBW:3000.000kHz SWT:Auto</p>	<p>Left blank</p>
<p>Avg.</p>	 <p>Site : 03CHI1-HY Condition : AVG_BE_54 3m HORN 91200-HF VERTICAL : RBW:1000.000kHz VBW:3.000kHz SWT:Auto</p>	<p>Left blank</p>

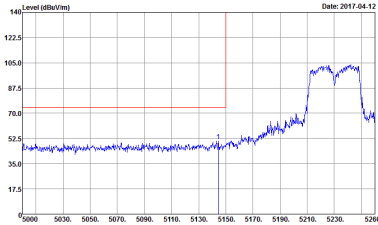
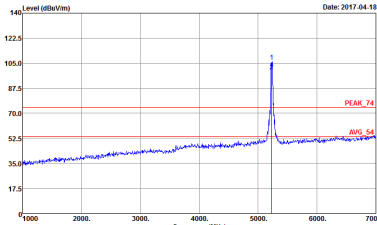
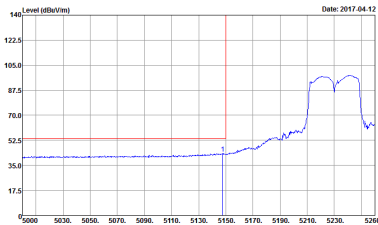

WIFI	Band 1 5150~5250MHz Band Edge @ 3m	
ANT	802.11n HT40 CH46 5230MHz - L	
1+2	Horizontal	Fundamental
<p>Peak</p>	 <p>Site : 03CH11-HY Condition : PEAK_BE_74 3m HORN 91200-HF HORIZONTAL : RBW:1000.000KHz VBW:3000.000KHz SWT:Auto</p>	 <p>Site : 03CH11-HY Condition : PEAK_74 3m HORN 91200-HF HORIZONTAL Detector : Peak</p>
<p>Avg.</p>	 <p>Site : 03CH11-HY Condition : AVG_BE_54 3m HORN 91200-HF HORIZONTAL : RBW:1000.000KHz VBW:3.000KHz SWT:Auto</p>	<p>Left blank</p>





WIFI	Band 1 5150~5250MHz Band Edge @ 3m	
ANT	802.11n HT40 CH46 5230MHz - R	
1+2	Horizontal	Fundamental
Peak	<p>Site : 03CH11-HY Condition : PEAK_BE_74 3m HORN 91200-HF HORIZONTAL : RBW:1000.000KHz VBW:3000.000KHz SWT:Auto</p>	Left blank
Avg.	<p>Site : 03CH11-HY Condition : AVG_BE_54 3m HORN 91200-HF HORIZONTAL : RBW:1000.000KHz VBW:3.000KHz SWT:Auto</p>	Left blank



WIFI	Band 1 5150~5250MHz Band Edge @ 3m	
ANT	802.11n HT40 CH46 5230MHz - L	
1+2	Vertical	Fundamental
Peak	<p>Site : 03CH11-HY Condition : PEAK_BE_74 3m HORN 9120D-HF VERTICAL : RBW:1000.000KHz VBW:3000.000KHz SWT:Auto</p>	<p>Site : 03CH11-HY Condition : PEAK_74 3m HORN 9120D-HF VERTICAL : RBW:1000.000KHz VBW:3000.000KHz SWT:Auto</p>
Avg.	<p>Site : 03CH11-HY Condition : AVG_BE_54 3m HORN 9120D-HF VERTICAL : RBW:1000.000KHz VBW:3.000KHz SWT:Auto</p>	Left blank

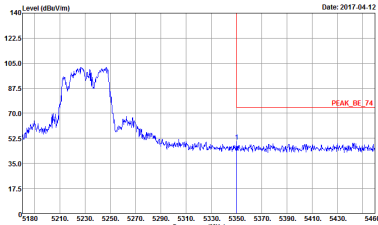

WIFI	Band 1 5150~5250MHz Band Edge @ 3m	
ANT	802.11n HT40 CH46 5230MHz - R	
1+2	Vertical	Fundamental
<p>Peak</p>	 <p>Site : 03CHI1-HY Condition : PEAK_BE_74 3m HORN 91200-HF VERTICAL : RBW:1000.000KHz VBW:3000.000KHz SWT:Auto</p>	<p>Left blank</p>
<p>Avg.</p>	 <p>Site : 03CHI1-HY Condition : AVG_BE_54 3m HORN 91200-HF VERTICAL : RBW:1000.000KHz VBW:3.000KHz SWT:Auto</p>	<p>Left blank</p>



Band 1 5150~5250MHz
WIFI 802.11ac VHT20 (Band Edge @ 3m)

WIFI	Band 1 5150~5250MHz Band Edge @ 3m	
ANT	802.11ac VHT20 CH36 5180MHz	
1+2	Horizontal	Fundamental
Peak	<p>Site : 03CH11-HY Condition : PEAK_BE_74 3m HORN 9120D-HF HORIZONTAL : RBW:1000.000KHz VBW:3000.000KHz SWT:Auto</p>	<p>Site : 03CH11-HY Condition : PEAK_74 3m HORN 9120D-HF HORIZONTAL : RBW:1000.000KHz VBW:3000.000KHz SWT:Auto</p>
Avg.	<p>Site : 03CH11-HY Condition : AVG_BE_54 3m HORN 9120D-HF HORIZONTAL : RBW:1000.000KHz VBW:1.000KHz SWT:Auto</p>	Left blank

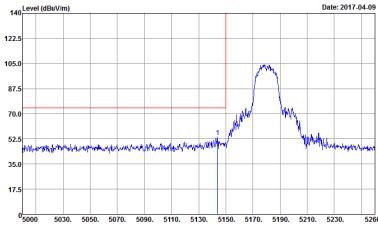
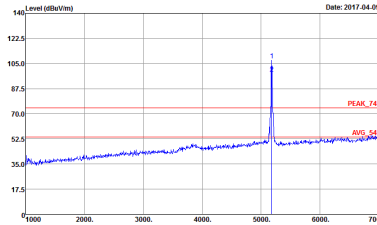
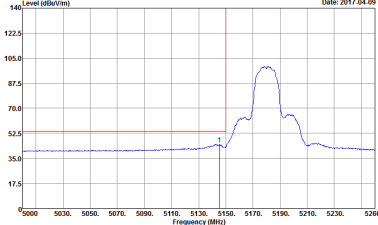

WIFI	Band 1 5150~5250MHz Band Edge @ 3m	
ANT	802.11ac VHT20 CH36 5180MHz	
1+2	Vertical	Fundamental
Peak	 <p>Site : 03CH11-HY Condition : PEAK_BE_74 3m HORN 9120D-HF VERTICAL : RBW:1000.000KHz VBW:3000.000KHz SWT:Auto</p>	 <p>Site : 03CH11-HY Condition : PEAK_74 3m HORN 9120D-HF VERTICAL : RBW:1000.000KHz VBW:3000.000KHz SWT:Auto</p>
Avg.	 <p>Site : 03CH11-HY Condition : AVG_BE_54 3m HORN 9120D-HF VERTICAL : RBW:1000.000KHz VBW:1.000KHz SWT:Auto</p>	Left blank



WIFI	Band 1 5150~5250MHz Band Edge @ 3m	
ANT	802.11ac VHT20 CH44 5220MHz - L	
1+2	Horizontal	Fundamental
Peak	<p>Site : 03CH11-HY Condition : PEAK_BE_74 3m HORN 91200-HF HORIZONTAL : RBW:1000.000KHz VBW:3000.000KHz SWT:Auto</p>	<p>Site : 03CH11-HY Condition : PEAK_74 3m HORN 91200-HF HORIZONTAL : RBW:1000.000KHz VBW:3000.000KHz SWT:Auto</p>
Avg.	<p>Site : 03CH11-HY Condition : AVG_BE_54 3m HORN 91200-HF HORIZONTAL : RBW:1000.000KHz VBW:1.000KHz SWT:Auto</p>	Left blank



WIFI	Band 1 5150~5250MHz Band Edge @ 3m	
ANT	802.11ac VHT20 CH44 5220MHz - R	
1+2	Horizontal	Fundamental
Peak	<p>Site : 03CH11-HY Condition : PEAK_BE_74 3m HORN 91200-HF HORIZONTAL RBW:1000.000KHz VBW:3000.000KHz SWT:Auto</p>	Left blank
Avg.	<p>Site : 03CH11-HY Condition : AVG_BE_54 3m HORN 91200-HF HORIZONTAL RBW:1000.000KHz VBW:1.000KHz SWT:Auto</p>	Left blank

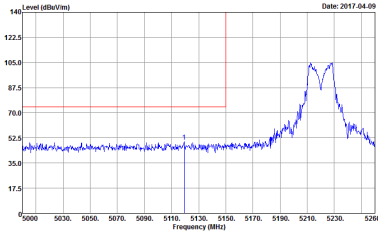
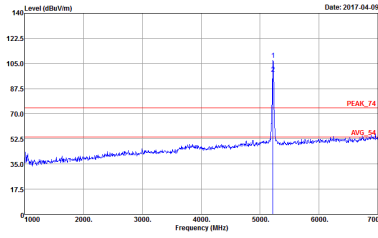
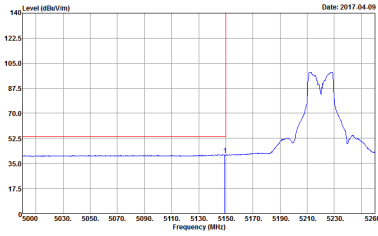

WIFI	Band 1 5150~5250MHz Band Edge @ 3m	
ANT	802.11ac VHT20 CH44 5220MHz - L	
1+2	Vertical	Fundamental
Peak	 <p>Site : 03CH11-HY Condition : PEAK_BE_74 3m HORN 9120D-HF VERTICAL : RBW:1000.000KHz VBW:3000.000KHz SWT:Auto</p>	 <p>Site : 03CH11-HY Condition : PEAK_74 3m HORN 9120D-HF VERTICAL : RBW:1000.000KHz VBW:3000.000KHz SWT:Auto</p>
Avg.	 <p>Site : 03CH11-HY Condition : AVG_BE_54 3m HORN 9120D-HF VERTICAL : RBW:1000.000KHz VBW:1.000KHz SWT:Auto</p>	Left blank



WIFI	Band 1 5150~5250MHz Band Edge @ 3m	
ANT	802.11ac VHT20 CH44 5220MHz - R	
1+2	Vertical	Fundamental
<p>Peak</p>		<p>Left blank</p>
<p>Avg.</p>		<p>Left blank</p>

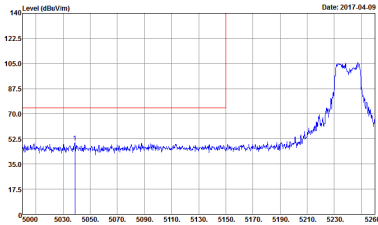
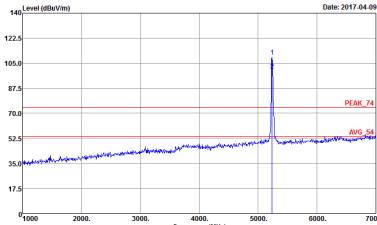
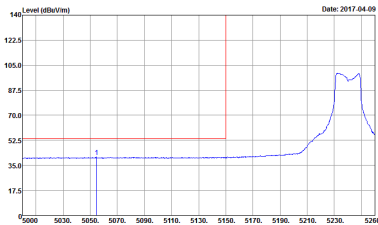

WIFI	Band 1 5150~5250MHz Band Edge @ 3m	
ANT	802.11ac VHT20 CH48 5240MHz - L	
1+2	Horizontal	Fundamental
<p>Peak</p>	 <p>Site : 03CHI1-HY Condition : PEAK_BE_74 3m HORN 91200-HF HORIZONTAL : RBW:1000.000KHz VBW:3000.000KHz SWT:Auto</p>	 <p>Site : 03CHI1-HY Condition : PEAK_74 3m HORN 91200-HF HORIZONTAL : RBW:1000.000KHz VBW:3000.000KHz SWT:Auto</p>
<p>Avg.</p>	 <p>Site : 03CHI1-HY Condition : AVG_BE_54 3m HORN 91200-HF HORIZONTAL : RBW:1000.000KHz VBW:1.000KHz SWT:Auto</p>	<p>Left blank</p>

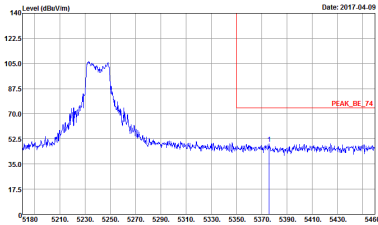
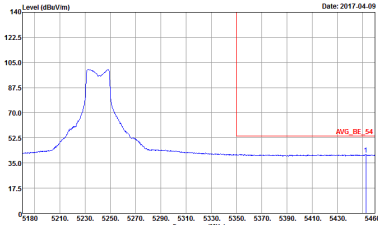

WIFI	Band 1 5150~5250MHz Band Edge @ 3m	
ANT	802.11ac VHT20 CH48 5240MHz - R	
1+2	Horizontal	Fundamental
<p>Peak</p>	 <p>Site : 03CHI1-HY Condition : PEAK_BE_74 3m HORN 91200-HF HORIZONTAL : RBW:1000.000KHz VBW:3000.000KHz SWT:Auto</p>	<p>Left blank</p>
<p>Avg.</p>	 <p>Site : 03CHI1-HY Condition : AVG_BE_54 3m HORN 91200-HF HORIZONTAL : RBW:1000.000KHz VBW:1.000KHz SWT:Auto</p>	<p>Left blank</p>

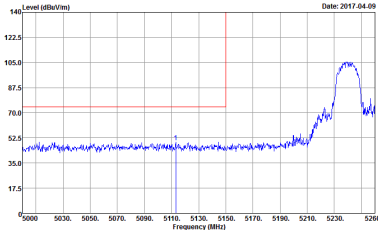
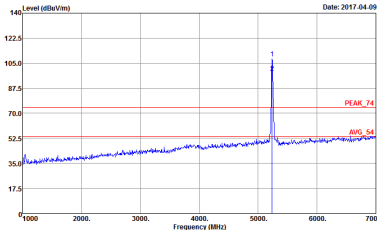
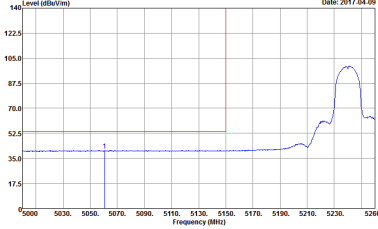

WIFI	Band 1 5150~5250MHz Band Edge @ 3m	
ANT	802.11ac VHT20 CH48 5240MHz - L	
1+2	Vertical	Fundamental
Peak	 <p>Site : 03CHI1-HY Condition : PEAK_BE_74 3m HORN 91200-HF VERTICAL : RBW:1000.000KHz VBW:3000.000KHz SWT:Auto</p>	 <p>Site : 03CHI1-HY Condition : PEAK_74 3m HORN 91200-HF VERTICAL : RBW:1000.000KHz VBW:3000.000KHz SWT:Auto</p>
Avg.	 <p>Site : 03CHI1-HY Condition : AVG_BE_54 3m HORN 91200-HF VERTICAL : RBW:1000.000KHz VBW:1.000KHz SWT:Auto</p>	Left blank



WIFI	Band 1 5150~5250MHz Band Edge @ 3m	
ANT	802.11ac VHT20 CH48 5240MHz - R	
1+2	Vertical	Fundamental
<p>Peak</p>	<p>Site : 03CHI1-HY Condition : PEAK_BE_74 3m HORN 91200-HF VERTICAL : RBW:1000.000KHz VBW:3000.000KHz SWT:Auto</p>	<p>Left blank</p>
<p>Avg.</p>	<p>Site : 03CHI1-HY Condition : AVG_BE_54 3m HORN 91200-HF VERTICAL : RBW:1000.000KHz VBW:1.000KHz SWT:Auto</p>	<p>Left blank</p>



Band 1 5150~5250MHz
WIFI 802.11ac VHT40 (Band Edge @ 3m)

WIFI	Band 1 5150~5250MHz Band Edge @ 3m	
ANT	802.11ac VHT40 CH38 5190MHz - L	
1+2	Horizontal	Fundamental
Peak	<p>Site : 03CH11-HY Condition : PEAK_BE_74 3m HORN 91200-HF HORIZONTAL : RBW:1000.000KHz VBW:3000.000KHz SWT:Auto</p>	<p>Site : 03CH11-HY Condition : PEAK_74 3m HORN 91200-HF HORIZONTAL : RBW:1000.000KHz VBW:3000.000KHz SWT:Auto</p>
Avg.	<p>Site : 03CH11-HY Condition : AVG_BE_54 3m HORN 91200-HF HORIZONTAL : RBW:1000.000KHz VBW:3.000KHz SWT:Auto</p>	Left blank

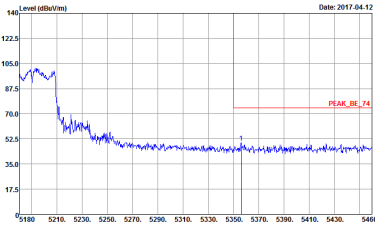
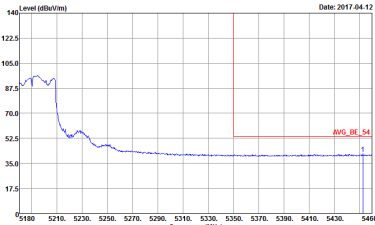

WIFI	Band 1 5150~5250MHz Band Edge @ 3m	
ANT	802.11ac VHT40 CH38 5190MHz - R	
1+2	Horizontal	Fundamental
<p>Peak</p>	 <p>Site : 03CHI1-HY Condition : PEAK_BE_74 3m HORN 91200-HF HORIZONTAL : RBW:1000.000KHz VBW:3000.000KHz SWT:Auto</p>	<p>Left blank</p>
<p>Avg.</p>	 <p>Site : 03CHI1-HY Condition : AVG_BE_54 3m HORN 91200-HF HORIZONTAL : RBW:1000.000KHz VBW:3.000KHz SWT:Auto</p>	<p>Left blank</p>



WIFI	Band 1 5150~5250MHz Band Edge @ 3m	
ANT	802.11ac VHT40 CH38 5190MHz - L	
1+2	Vertical	Fundamental
Peak	<p>Site : 03CH11-HY Condition : PEAK_BE_74 3m HORN 9120D-HF VERTICAL : RBW:1000.000KHz VBW:3000.000KHz SWT:Auto</p>	<p>Site : 03CH11-HY Condition : PEAK_74 3m HORN 9120D-HF VERTICAL : RBW:1000.000KHz VBW:3000.000KHz SWT:Auto</p>
Avg.	<p>Site : 03CH11-HY Condition : AVG_BE_54 3m HORN 9120D-HF VERTICAL : RBW:1000.000KHz VBW:3.000KHz SWT:Auto</p>	Left blank

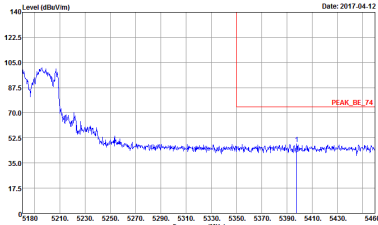
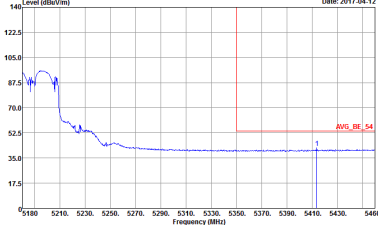

WIFI	Band 1 5150~5250MHz Band Edge @ 3m	
ANT	802.11ac VHT40 CH38 5190MHz - R	
1+2	Vertical	Fundamental
<p>Peak</p>	 <p>Site : 03CHI1-HY Condition : PEAK_BE_74 3m HORN 91200-HF VERTICAL : RBW:1000.000KHz VBW:3000.000KHz SWT:Auto</p>	<p>Left blank</p>
<p>Avg.</p>	 <p>Site : 03CHI1-HY Condition : AVG_BE_54 3m HORN 91200-HF VERTICAL : RBW:1000.000KHz VBW:3.000KHz SWT:Auto</p>	<p>Left blank</p>



WIFI	Band 1 5150~5250MHz Band Edge @ 3m	
ANT	802.11ac VHT40 CH46 5230MHz - L	
1+2	Horizontal	Fundamental
Peak	<p>Site : 03CH11-HY Condition : PEAK_BE_74 3m HORN 9120D-HF HORIZONTAL : RBW:1000.000KHz VBW:3000.000KHz SWT:Auto</p>	<p>Site : 03CH11-HY Condition : PEAK_74 3m HORN 9120D-HF HORIZONTAL : RBW:1000.000KHz VBW:3000.000KHz SWT:Auto</p>
Avg.	<p>Site : 03CH11-HY Condition : AVG_BE_54 3m HORN 9120D-HF HORIZONTAL : RBW:1000.000KHz VBW:3.000KHz SWT:Auto</p>	Left blank

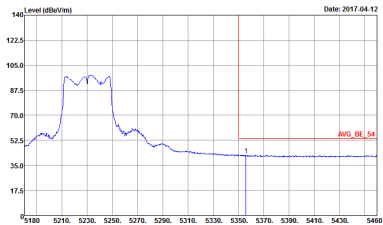

WIFI	Band 1 5150~5250MHz Band Edge @ 3m	
ANT	802.11ac VHT40 CH46 5230MHz - R	
1+2	Horizontal	Fundamental
<p>Peak</p>	 <p>Site : 03CH11-HY Condition : PEAK_BE_74 3m HORN 91200-HF HORIZONTAL : RBW:1000.000KHz VBW:3000.000KHz SWT:Auto</p>	<p>Left blank</p>
<p>Avg.</p>	 <p>Site : 03CH11-HY Condition : AVG_BE_54 3m HORN 91200-HF HORIZONTAL : RBW:1000.000KHz VBW:3.000KHz SWT:Auto</p>	<p>Left blank</p>

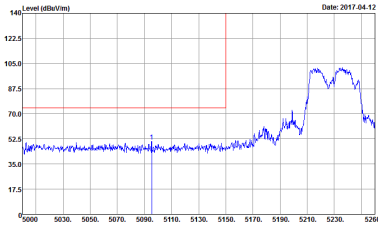
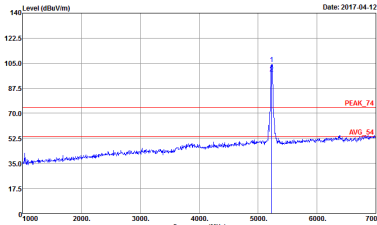
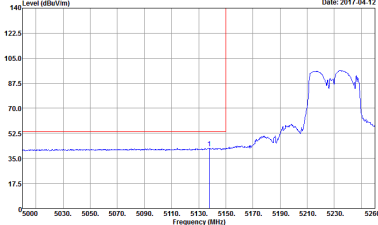

WIFI	Band 1 5150~5250MHz Band Edge @ 3m	
ANT	802.11ac VHT40 CH46 5230MHz - L	
1+2	Vertical	Fundamental
<p>Peak</p>	 <p>Site : 03CHI1-HY Condition : PEAK_BE_74 3m HORN 9120D-HF VERTICAL : RBW:1000.000KHz VBW:3000.000KHz SWT:Auto</p>	 <p>Site : 03CHI1-HY Condition : PEAK_74 3m HORN 9120D-HF VERTICAL : RBW:1000.000KHz VBW:3000.000KHz SWT:Auto</p>
<p>Avg.</p>	 <p>Site : 03CHI1-HY Condition : AVG_BE_54 3m HORN 9120D-HF VERTICAL : RBW:1000.000KHz VBW:3.000KHz SWT:Auto</p>	<p>Left blank</p>

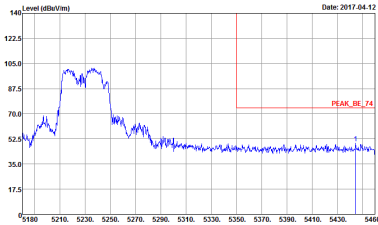
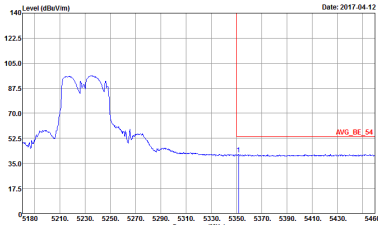

WIFI	Band 1 5150~5250MHz Band Edge @ 3m	
ANT	802.11ac VHT40 CH46 5230MHz - R	
1+2	Vertical	Fundamental
<p>Peak</p>	 <p>Site : 03CHI1-HY Condition : PEAK_BE_74 3m HORN 91200-HF VERTICAL : RBW:1000.000KHz VBW:3000.000KHz SWT:Auto</p>	<p>Left blank</p>
<p>Avg.</p>	 <p>Site : 03CHI1-HY Condition : AVG_BE_54 3m HORN 91200-HF VERTICAL : RBW:1000.000KHz VBW:3.000KHz SWT:Auto</p>	<p>Left blank</p>



Band 1 5150~5250MHz
WIFI 802.11ac VHT80 (Band Edge @ 3m)

WIFI	Band 1 5150~5250MHz Band Edge @ 3m	
ANT	802.11ac VHT80 CH42 5210MHz - L	
1+2	Horizontal	Fundamental
Peak	<p>Site : 03CH11-HY Condition : PEAK_BE_74 3m HORN 91200-HF HORIZONTAL : RBW:1000.000kHz VBW:3000.000kHz SWT:Auto</p>	<p>Site : 03CH11-HY Condition : PEAK_74 3m HORN 91200-HF HORIZONTAL : RBW:1000.000kHz VBW:3000.000kHz SWT:Auto</p>
Avg.	<p>Site : 03CH11-HY Condition : AVG_BE_54 3m HORN 91200-HF HORIZONTAL : RBW:1000.000kHz VBW:3000.000kHz SWT:Auto</p>	Left blank

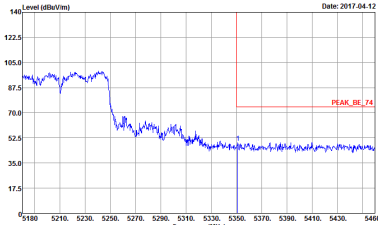
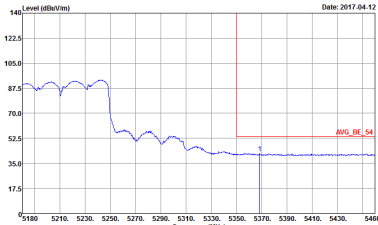

WIFI	Band 1 5150~5250MHz Band Edge @ 3m	
ANT	802.11ac VHT80 CH42 5210MHz - R	
1+2	Horizontal	Fundamental
<p>Peak</p>	 <p>Site : 03CH11-HY Condition : PEAK_BE_74 3m HORN 91200-HF HORIZONTAL : RBW:1000.000KHz VBW:3000.000KHz SWT:Auto</p>	<p>Left blank</p>
<p>Avg.</p>	 <p>Site : 03CH11-HY Condition : AVG_BE_54 3m HORN 91200-HF HORIZONTAL : RBW:1000.000KHz VBW:3.000KHz SWT:Auto</p>	<p>Left blank</p>

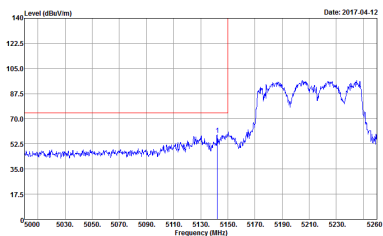
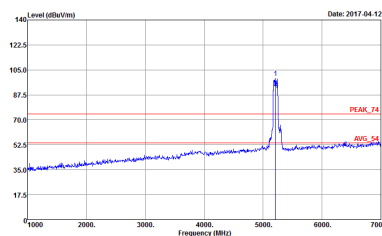
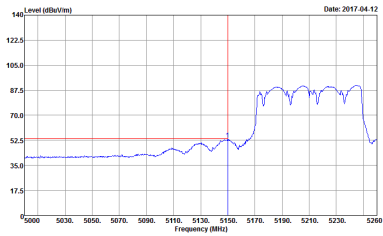

WIFI	Band 1 5150~5250MHz Band Edge @ 3m	
ANT	802.11ac VHT80 CH42 5210MHz - L	
1+2	Vertical	Fundamental
<p>Peak</p>	 <p>Site : 03CH11-HY Condition : PEAK_BE_74 3m HORN 9120D-HF VERTICAL : RBW:1000.000KHz VBW:3000.000KHz SWT:Auto</p>	 <p>Site : 03CH11-HY Condition : PEAK_74 3m HORN 9120D-HF VERTICAL : RBW:1000.000KHz VBW:3000.000KHz SWT:Auto</p>
<p>Avg.</p>	 <p>Site : 03CH11-HY Condition : AVG_BE_54 3m HORN 9120D-HF VERTICAL : RBW:1000.000KHz VBW:3.000KHz SWT:Auto</p>	<p>Left blank</p>



WIFI	Band 1 5150~5250MHz Band Edge @ 3m	
ANT	802.11ac VHT80 CH42 5210MHz - R	
1+2	Vertical	Fundamental
<p>Peak</p>	<p>Site : 03CH11-HY Condition : PEAK_BE_74 3m HORN 91200-HF VERTICAL : RBW:1000.000KHz VBW:3000.000KHz SWT:Auto</p>	<p>Left blank</p>
<p>Avg.</p>	<p>Site : 03CH11-HY Condition : AVG_BE_54 3m HORN 91200-HF VERTICAL : RBW:1000.000KHz VBW:3.000KHz SWT:Auto</p>	<p>Left blank</p>



Band 1 - 5150~5250MHz
WIFI 802.11a (Harmonic @ 3m)

WIFI	Band 1 5150~5250MHz Harmonic @ 3m	
ANT	802.11a CH36 5180MHz	
1+2	Horizontal	Vertical
Peak Avg.	<p>Site : 03CH11-HY Condition : PEAK_74 3m 9170 SHF HORM_150809 HORIZONTAL Detector : Peak</p>	<p>Site : 03CH11-HY Condition : PEAK_74 3m 9170 SHF HORM_150809 VERTICAL Detector : Peak</p>



WIFI	Band 1 5150~5250MHz Harmonic @ 3m	
ANT	802.11a CH44 5220MHz	
1+2	Horizontal	Vertical
Peak Avg.	<p>Site : 03CHI1-HY Condition : PEAK_74 3m 9170 SHF HORM_150809 HORIZONTAL Detector : Peak</p>	<p>Site : 03CHI1-HY Condition : PEAK_74 3m 9170 SHF HORM_150809 VERTICAL Detector : Peak</p>



WIFI	Band 1 5150~5250MHz Harmonic @ 3m	
ANT	802.11a CH48 5240MHz	
1+2	Horizontal	Vertical
Peak Avg.	<p>Site : 03CHI1-HY Condition : PEAK_74 3m 9170 SHF HORM_150809 HORIZONTAL Detector : Peak</p>	<p>Site : 03CHI1-HY Condition : PEAK_74 3m 9170 SHF HORM_150809 VERTICAL Detector : Peak</p>



**Band 1 5150~5250MHz
WIFI 802.11n HT20 (Harmonic @ 3m)**

WIFI	Band 1 5150~5250MHz Harmonic @ 3m	
ANT	802.11n HT20 CH36 5180MHz	
1+2	Horizontal	Vertical
Peak Avg.	<p>Site : 03CH11-4Y Condition : PEAK_74 3m 9170 SHF HORM_150809 HORIZONTAL Detector : Peak</p>	<p>Site : 03CH11-4Y Condition : PEAK_74 3m 9170 SHF HORM_150809 VERTICAL Detector : Peak</p>



WIFI	Band 1 5150~5250MHz Harmonic @ 3m	
ANT	802.11n HT20 CH44 5220MHz	
1+2	Horizontal	Vertical
Peak Avg.	<p>Site : 03CHI1-HY Condition : PEAK_74 3m 9170 SHF HORM_150809 HORIZONTAL Detector : Peak</p>	<p>Site : 03CHI1-HY Condition : PEAK_74 3m 9170 SHF HORM_150809 VERTICAL Detector : Peak</p>



WIFI	Band 1 5150~5250MHz Harmonic @ 3m	
ANT	802.11n HT20 CH48 5240MHz	
1+2	Horizontal	Vertical
Peak Avg.	<p>Site : 03CH11-HY Condition : PEAK_74 3m 9170 SHF HORM_150809 HORIZONTAL Detector : Peak</p>	<p>Site : 03CH11-HY Condition : PEAK_74 3m 9170 SHF HORM_150809 VERTICAL Detector : Peak</p>

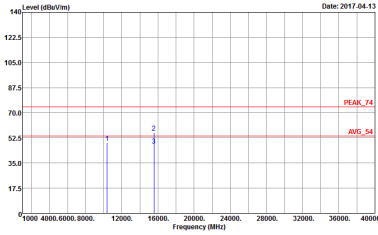
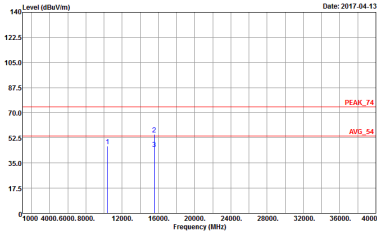

**Band 1 5150~5250MHz
WIFI 802.11n HT40 (Harmonic @ 3m)**

WIFI	Band 1 5150~5250MHz Harmonic @ 3m	
ANT	802.11n HT40 CH38 5190MHz	
1+2	Horizontal	Vertical
<p>Peak Avg.</p>	 <p>Site : 03CH11-14Y Condition : PEAK_74 3m 9170 SHF HORM_150809 HORIZONTAL Detector : Peak</p>	 <p>Site : 03CH11-14Y Condition : PEAK_74 3m 9170 SHF HORM_150809 VERTICAL Detector : Peak</p>



WIFI	Band 1 5150~5250MHz Harmonic @ 3m	
ANT	802.11n HT40 CH46 5230MHz	
1+2	Horizontal	Vertical
Peak Avg.	<p>Site : 03CHI1-HY Condition : PEAK_74 3m 9170 SHF HORM_150809 HORIZONTAL Detector : Peak</p>	<p>Site : 03CHI1-HY Condition : PEAK_74 3m 9170 SHF HORM_150809 VERTICAL Detector : Peak</p>



**Band 1 5150~5250MHz
WIFI 802.11ac VHT20 (Harmonic @ 3m)**

WIFI	Band 1 5150~5250MHz Harmonic @ 3m	
ANT	802.11ac VHT20 CH36 5180MHz	
1+2	Horizontal	Vertical
Peak Avg.	<p>Site : 03CH11-14Y Condition : PEAK_74 3m 9170 SHF HORM_150809 HORIZONTAL Detector : Peak</p>	<p>Site : 03CH11-14Y Condition : PEAK_74 3m 9170 SHF HORM_150809 VERTICAL Detector : Peak</p>



WIFI	Band 1 5150~5250MHz Harmonic @ 3m	
ANT	802.11ac VHT20 CH44 5220MHz	
1+2	Horizontal	Vertical
Peak Avg.	<p>Site : 03CHI1-HY Condition : PEAK_74 3m 9170 SHF HORM_150809 HORIZONTAL Detector : Peak</p>	<p>Site : 03CHI1-HY Condition : PEAK_74 3m 9170 SHF HORM_150809 VERTICAL Detector : Peak</p>



WIFI	Band 1 5150~5250MHz Harmonic @ 3m	
ANT	802.11ac VHT20 CH48 5240MHz	
1+2	Horizontal	Vertical
Peak Avg.	<p>Site : 03CH11-HY Condition : PEAK_74 3m 9170 SHF HORM_150809 HORIZONTAL Detector : Peak</p>	<p>Site : 03CH11-HY Condition : PEAK_74 3m 9170 SHF HORM_150809 VERTICAL Detector : Peak</p>



**Band 1 5150~5250MHz
WIFI 802.11ac VHT40 (Harmonic @ 3m)**

WIFI	Band 1 5150~5250MHz Harmonic @ 3m	
ANT	802.11ac VHT40 CH38 5190MHz	
1+2	Horizontal	Vertical
Peak Avg.	<p>Site : 03CH11-14Y Condition : PEAK_74 3m 9170 SHF HORM_150809 HORIZONTAL Detector : Peak</p>	<p>Site : 03CH11-14Y Condition : PEAK_74 3m 9170 SHF HORM_150809 VERTICAL Detector : Peak</p>

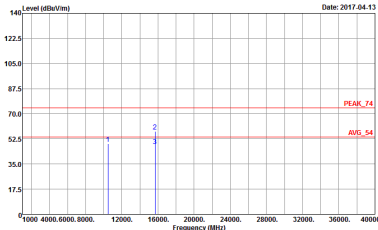
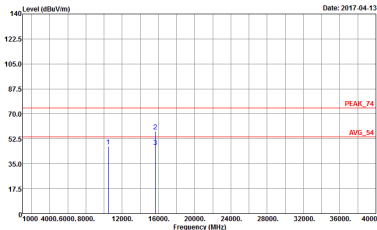

WIFI	Band 1 5150~5250MHz Harmonic @ 3m	
ANT	802.11ac VHT40 CH46 5230MHz	
1+2	Horizontal	Vertical
<p>Peak Avg.</p>	 <p>Site : 03CHI1-HY Condition : PEAK_74 3m 9170 SHF HORM_150809 HORIZONTAL Detector : Peak</p>	 <p>Site : 03CHI1-HY Condition : PEAK_74 3m 9170 SHF HORM_150809 VERTICAL Detector : Peak</p>



**Band 1 5150~5250MHz
WIFI 802.11ac VHT80 (Harmonic @ 3m)**

WIFI	Band 1 5150~5250MHz Harmonic @ 3m	
ANT	802.11ac VHT80 CH42 5210MHz	
1+2	Horizontal	Vertical
Peak Avg.	<p>Site : 03CH11-14Y Condition : PEAK_74 3m 9170 SHF HORM_150809 HORIZONTAL Detector : Peak</p>	<p>Site : 03CH11-14Y Condition : PEAK_74 3m 9170 SHF HORM_150809 VERTICAL Detector : Peak</p>



Band 2 - 5250~5350MHz
WIFI 802.11a (Band Edge @ 3m)

WIFI	Band 2 5250~5350MHz Band Edge @ 3m	
ANT	802.11a CH52 5260MHz - L	
1+2	Horizontal	Fundamental
Peak	<p>Site : 03CH11-HY Condition : PEAK_BE_74 3m HORN 9120D-HF HORIZONTAL : RBW:1000.000KHz VBW:3000.000KHz SWT:Auto</p>	<p>Site : 03CH11-HY Condition : PEAK_74 3m HORN 9120D-HF HORIZONTAL : RBW:1000.000KHz VBW:3000.000KHz SWT:Auto</p>
Avg.	<p>Site : 03CH11-HY Condition : AVG_BE_54 3m HORN 9120D-HF HORIZONTAL : RBW:1000.000KHz VBW:1.000KHz SWT:Auto</p>	Left blank



WIFI	Band 2 5250~5350MHz Band Edge @ 3m	
ANT	802.11a CH52 5260MHz - R	
1+2	Horizontal	Fundamental
<p>Peak</p>	<p>Site : 03CHI1-HY Condition : PEAK_BE_74 3m HORN 91200-HF HORIZONTAL : RBW:1000.000KHz VBW:3000.000KHz SWT:Auto</p>	<p>Left blank</p>
<p>Avg.</p>	<p>Site : 03CHI1-HY Condition : AVG_BE_54 3m HORN 91200-HF HORIZONTAL : RBW:1000.000KHz VBW:1.000KHz SWT:Auto</p>	<p>Left blank</p>



WIFI	Band 2 5250~5350MHz Band Edge @ 3m	
ANT	802.11a CH52 5260MHz - L	
1+2	Vertical	Fundamental
Peak	<p>Site : 03CH11-HY Condition : PEAK_BE_74 3m HORN 91200-HF VERTICAL : RBW:1000.000KHz VBW:3000.000KHz SWT:Auto</p>	<p>Site : 03CH11-HY Condition : PEAK_74 3m HORN 91200-HF VERTICAL : RBW:1000.000KHz VBW:3000.000KHz SWT:Auto</p>
Avg.	<p>Site : 03CH11-HY Condition : AVG_BE_54 3m HORN 91200-HF VERTICAL : RBW:1000.000KHz VBW:1.000KHz SWT:Auto</p>	Left blank



WIFI	Band 2 5250~5350MHz Band Edge @ 3m	
ANT	802.11a CH52 5260MHz - R	
1+2	Vertical	Fundamental
<p>Peak</p>	<p>Site : 03CH11-HY Condition : PEAK_BE_74 3m HORN 91200-HF VERTICAL : RBW:1000.000KHz VBW:3000.000KHz SWT:Auto</p>	<p>Left blank</p>
<p>Avg.</p>	<p>Site : 03CH11-HY Condition : AVG_BE_54 3m HORN 91200-HF VERTICAL : RBW:1000.000KHz VBW:1.000KHz SWT:Auto</p>	<p>Left blank</p>



WIFI	Band 2 5250~5350MHz Band Edge @ 3m	
ANT	802.11a CH60 5300MHz - L	
1+2	Horizontal	Fundamental
Peak	<p>Site : 03CH11-HY Condition : PEAK_BE_74 3m HORN 9120D-HF HORIZONTAL : RBW:1000.000KHz VBW:3000.000KHz SWT:Auto</p>	<p>Site : 03CH11-HY Condition : PEAK_74 3m HORN 9120D-HF HORIZONTAL : RBW:1000.000KHz VBW:3000.000KHz SWT:Auto</p>
Avg.	<p>Site : 03CH11-HY Condition : AVG_BE_54 3m HORN 9120D-HF HORIZONTAL : RBW:1000.000KHz VBW:1.000KHz SWT:Auto</p>	Left blank

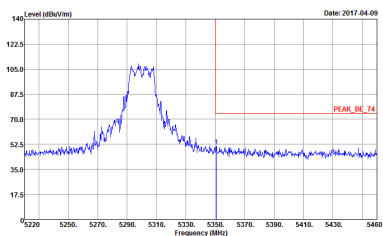
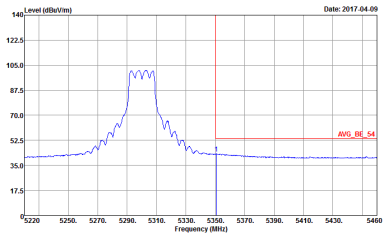

WIFI	Band 2 5250~5350MHz Band Edge @ 3m	
ANT	802.11a CH60 5300MHz - R	
1+2	Horizontal	Fundamental
<p>Peak</p>	 <p>Site : 03CHI1-HY Condition : PEAK_BE_74 3m HORN 91200-HF HORIZONTAL : RBW:1000.000KHz VBW:3000.000KHz SWT:Auto</p>	<p>Left blank</p>
<p>Avg.</p>	 <p>Site : 03CHI1-HY Condition : AVG_BE_54 3m HORN 91200-HF HORIZONTAL : RBW:1000.000KHz VBW:1.000KHz SWT:Auto</p>	<p>Left blank</p>

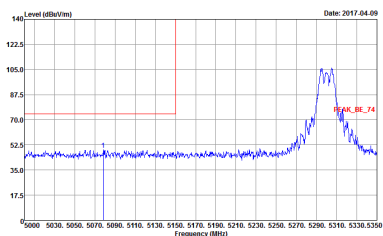
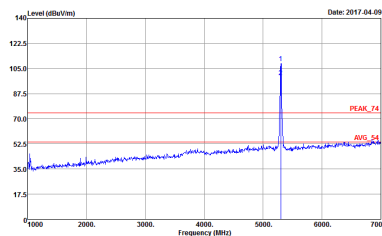
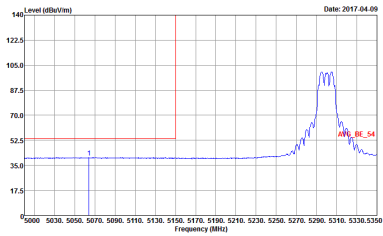

WIFI	Band 2 5250~5350MHz Band Edge @ 3m	
ANT	802.11a CH60 5300MHz - L	
1+2	Vertical	Fundamental
<p>Peak</p>	 <p>Site : 03CHI1-HY Condition : PEAK_BE_74 3m HORN 9120D-HF VERTICAL : RBW:1000.000KHz VBW:3000.000KHz SWT:Auto</p>	 <p>Site : 03CHI1-HY Condition : PEAK_74 3m HORN 9120D-HF VERTICAL : RBW:1000.000KHz VBW:3000.000KHz SWT:Auto</p>
<p>Avg.</p>	 <p>Site : 03CHI1-HY Condition : AVG_BE_54 3m HORN 9120D-HF VERTICAL : RBW:1000.000KHz VBW:1.000KHz SWT:Auto</p>	<p>Left blank</p>

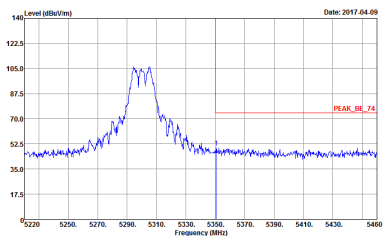
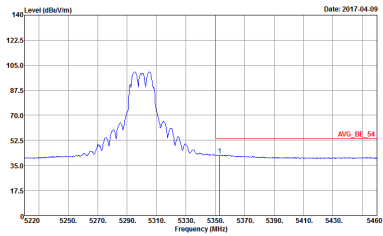

WIFI	Band 2 5250~5350MHz Band Edge @ 3m	
ANT	802.11a CH60 5300MHz - R	
1+2	Vertical	Fundamental
<p>Peak</p>	 <p>Site : 03CH11-HY Condition : PEAK_BE_74 3m HORN 91200-HF VERTICAL : RBW:1000.000KHz VBW:3000.000KHz SWT:Auto</p>	<p>Left blank</p>
<p>Avg.</p>	 <p>Site : 03CH11-HY Condition : AVG_BE_54 3m HORN 91200-HF VERTICAL : RBW:1000.000KHz VBW:1.000KHz SWT:Auto</p>	<p>Left blank</p>



WIFI	Band 2 5250~5350MHz Band Edge @ 3m	
ANT	802.11a CH64 5320MHz	
1+2	Horizontal	Fundamental
Peak	<p>Site : 03CH11-HY Condition : PEAK_BE_74 3m HORN 91200-HF HORIZONTAL : RBW:1000.000KHz VBW:3000.000KHz SWT:Auto</p>	<p>Site : 03CH11-HY Condition : PEAK_74 3m HORN 91200-HF HORIZONTAL : RBW:1000.000KHz VBW:3000.000KHz SWT:Auto</p>
Avg.	<p>Site : 03CH11-HY Condition : AVG_BE_54 3m HORN 91200-HF HORIZONTAL : RBW:1000.000KHz VBW:1.000KHz SWT:Auto</p>	Left blank



WIFI	Band 2 5250~5350MHz Band Edge @ 3m	
ANT	802.11a CH64 5320MHz	
1+2	Vertical	Fundamental
Peak	<p>Site : 03CH11-HY Condition : PEAK_BE_74 3m HORN 91200-HF VERTICAL : RBW:1000.000KHz VBW:3000.000KHz SWT:Auto</p>	<p>Site : 03CH11-HY Condition : PEAK_74 3m HORN 91200-HF VERTICAL : RBW:1000.000KHz VBW:3000.000KHz SWT:Auto</p>
Avg.	<p>Site : 03CH11-HY Condition : AVG_BE_54 3m HORN 91200-HF VERTICAL : RBW:1000.000KHz VBW:1.000KHz SWT:Auto</p>	Left blank



**Band 2 5250~5350MHz
WIFI 802.11n HT20 (Band Edge @ 3m)**

WIFI	Band 2 5250~5350MHz Band Edge @ 3m	
ANT	802.11n HT20 CH52 5260MHz - L	
1+2	Horizontal	Fundamental
<p>Peak</p>	<p>Site : 03CH11-HY Condition : PEAK_BE_74 3m HORN 9120D-HF HORIZONTAL : RBW:1000.000KHz VBW:3000.000KHz SWT:Auto</p>	<p>Site : 03CH11-HY Condition : PEAK_74 3m HORN 9120D-HF HORIZONTAL : RBW:1000.000KHz VBW:3000.000KHz SWT:Auto</p>
<p>Avg.</p>	<p>Site : 03CH11-HY Condition : AVG_BE_54 3m HORN 9120D-HF HORIZONTAL : RBW:1000.000KHz VBW:1.000KHz SWT:Auto</p>	<p>Left blank</p>

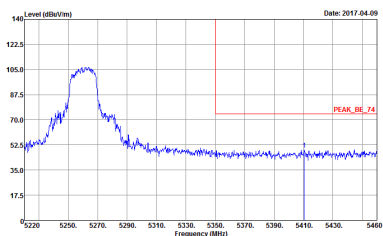
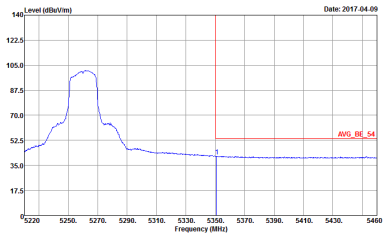

WIFI	Band 2 5250~5350MHz Band Edge @ 3m	
ANT	802.11n HT20 CH52 5260MHz - R	
1+2	Horizontal	Fundamental
<p>Peak</p>	 <p>Site : 03CHI1-HY Condition : PEAK_BE_74 3m HORN 91200-HF HORIZONTAL : RBW:1000.000KHz VBW:3000.000KHz SWT:Auto</p>	<p>Left blank</p>
<p>Avg.</p>	 <p>Site : 03CHI1-HY Condition : AVG_BE_54 3m HORN 91200-HF HORIZONTAL : RBW:1000.000KHz VBW:1.000KHz SWT:Auto</p>	<p>Left blank</p>

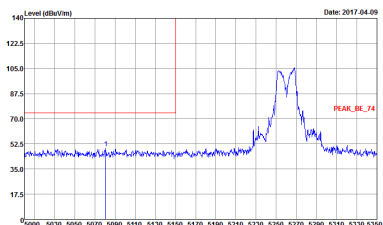
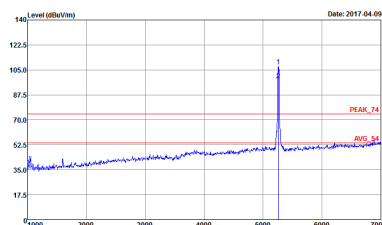
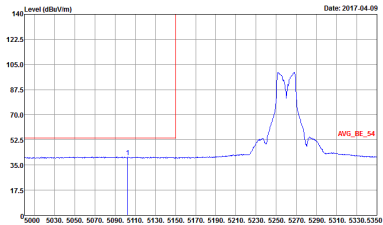

WIFI	Band 2 5250~5350MHz Band Edge @ 3m	
ANT	802.11n HT20 CH52 5260MHz - L	
1+2	Vertical	Fundamental
<p>Peak</p>	 <p>Site : 03CH11-HY Condition : PEAK_BE_74 3m HORN 91200-HF VERTICAL : RBW:1000.000KHz VBW:3000.000KHz SWT:Auto</p>	 <p>Site : 03CH11-HY Condition : PEAK_74 3m HORN 91200-HF VERTICAL : RBW:1000.000KHz VBW:3000.000KHz SWT:Auto</p>
<p>Avg.</p>	 <p>Site : 03CH11-HY Condition : AVG_BE_54 3m HORN 91200-HF VERTICAL : RBW:1000.000KHz VBW:1.000KHz SWT:Auto</p>	<p>Left blank</p>

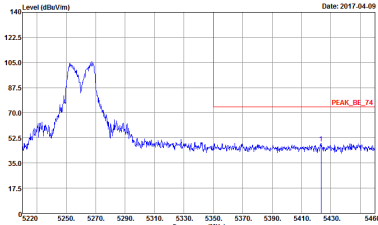
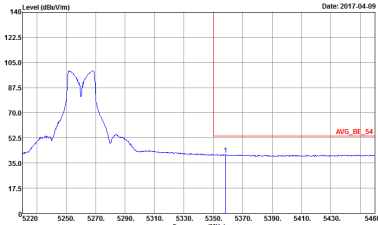

WIFI	Band 2 5250~5350MHz Band Edge @ 3m	
ANT	802.11n HT20 CH52 5260MHz - R	
1+2	Vertical	Fundamental
<p>Peak</p>	 <p>Site : 03CH11-HY Condition : PEAK_BE_74 3m HORN 91200-HF VERTICAL : RBW:1000.000KHz VBW:3000.000KHz SWT:Auto</p>	<p>Left blank</p>
<p>Avg.</p>	 <p>Site : 03CH11-HY Condition : AVG_BE_54 3m HORN 91200-HF VERTICAL : RBW:1000.000KHz VBW:1.000KHz SWT:Auto</p>	<p>Left blank</p>



WIFI	Band 2 5250~5350MHz Band Edge @ 3m	
ANT	802.11n HT20 CH60 5300MHz - L	
1+2	Horizontal	Fundamental
Peak		
Avg.		Left blank

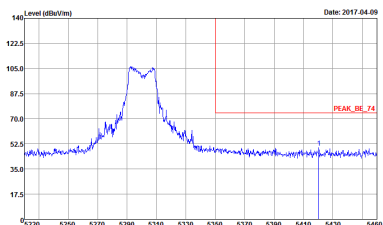
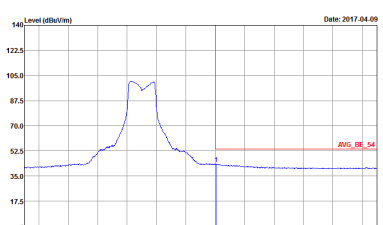

WIFI	Band 2 5250~5350MHz Band Edge @ 3m	
ANT	802.11n HT20 CH60 5300MHz - R	
1+2	Horizontal	Vertical
<p>Peak</p>	 <p>Site : 03CH11-HY Condition : PEAK_BE_74 3m HORN 91200-HF HORIZONTAL : RBW:1000.000KHz VBW:3000.000KHz SWT:Auto</p>	<p>Left blank</p>
<p>Avg.</p>	 <p>Site : 03CH11-HY Condition : AVG_BE_54 3m HORN 91200-HF HORIZONTAL : RBW:1000.000KHz VBW:1.000KHz SWT:Auto</p>	<p>Left blank</p>

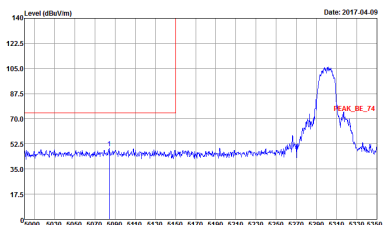
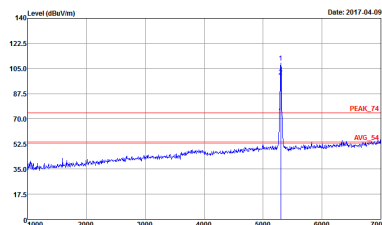
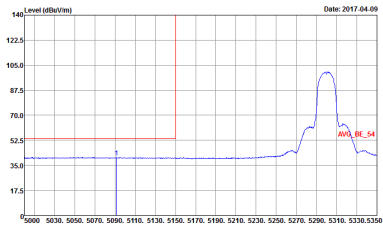

WIFI	Band 2 5250~5350MHz Band Edge @ 3m	
ANT	802.11n HT20 CH60 5300MHz - L	
1+2	Vertical	Fundamental
<p>Peak</p>	 <p>Site : 03CHI1-HY Condition : PEAK_BE_74 3m HORN 91200-HF VERTICAL : RBW:1000.000KHz VBW:3000.000KHz SWT:Auto</p>	 <p>Site : 03CHI1-HY Condition : PEAK_74 3m HORN 91200-HF VERTICAL : RBW:1000.000KHz VBW:3000.000KHz SWT:Auto</p>
<p>Avg.</p>	 <p>Site : 03CHI1-HY Condition : AVG_BE_54 3m HORN 91200-HF VERTICAL : RBW:1000.000KHz VBW:1.000KHz SWT:Auto</p>	<p>Left blank</p>