



FCC RF Test Report

APPLICANT : Motorola Mobility, LLC
EQUIPMENT : Mobile Cellular Phone
BRAND NAME : Motorola
MODEL NAME : 10061 (Single SIM), 10058 (Dual SIM)
FCC ID : IHDT56WA3
STANDARD : FCC Part 15 Subpart C §15.247
CLASSIFICATION : (DSS) Spread Spectrum Transmitter

This is a variant report which is only valid together with the original test report. The product was received on Feb. 03, 2017 and testing was completed on Mar. 09, 2017. We, SPORTON INTERNATIONAL INC., would like to declare that the tested sample has been evaluated in accordance with the test procedures and has been in compliance with the applicable technical standards.

The test results in this report apply exclusively to the tested model / sample. Without written approval of SPORTON INTERNATIONAL INC., the test report shall not be reproduced except in full.

Reviewed by: Joseph Lin / Supervisor

Approved by: Jones Tsai / Manager



SPORTON INTERNATIONAL INC.

No. 52, Hwa Ya 1st Rd., Hwa Ya Technology Park, Kwei-Shan District, Tao Yuan City, Taiwan, R.O.C.

SPORTON INTERNATIONAL INC.

TEL : 886-3-327-3456

FAX : 886-3-328-4978

FCC ID : IHDT56WA3

Page Number : 1 of 19

Report Issued Date : Mar. 20, 2017

Report Version : Rev. 01

Report Template No.: BU5-FR15CBT Version 1.1



TABLE OF CONTENTS

REVISION HISTORY..... 3

SUMMARY OF TEST RESULT 4

1 GENERAL DESCRIPTION..... 5

 1.1 Applicant 5

 1.2 Manufacturer 5

 1.3 Product Feature of Equipment Under Test..... 5

 1.4 Product Specification of Equipment Under Test..... 6

 1.5 Modification of EUT 6

 1.6 Testing Location 7

 1.7 Applicable Standards 7

2 TEST CONFIGURATION OF EQUIPMENT UNDER TEST..... 8

 2.1 Carrier Frequency Channel 8

 2.2 Descriptions of Test Mode 9

 2.3 Test Mode 9

 2.4 Connection Diagram of Test System 10

 2.5 Support Unit used in test configuration and system 10

 2.6 EUT Operation Test Setup 10

3 TEST RESULT 11

 3.1 Radiated Band Edges and Spurious Emission Measurement 11

 3.2 Antenna Requirements 17

4 LIST OF MEASURING EQUIPMENT 18

5 UNCERTAINTY OF EVALUATION..... 19

APPENDIX A. RADIATED SPURIOUS EMISSION

APPENDIX B. RADIATED SPURIOUS EMISSION PLOTS

APPENDIX C. ORIGINAL REPORT



REVISION HISTORY

REPORT NO.	VERSION	DESCRIPTION	ISSUED DATE
FR720310-04A	Rev. 01	Initial issue of report	Mar. 20, 2017



SUMMARY OF TEST RESULT

Report Section	FCC Rule	Description	Limit	Result	Remark
3.1	15.247(d)	Radiated Band Edges and Radiated Spurious Emission	15.209(a) & 15.247(d)	Pass	Under limit 6.79 dB at 32.700 MHz
3.2	15.203 & 15.247(b)	Antenna Requirement	N/A	Pass	-



1 General Description

1.1 Applicant

Motorola Mobility, LLC

222 W Merchandise Mart Plaza, Suite 1800, Chicago, IL 60654, United States

1.2 Manufacturer

Motorola Mobility, LLC

222 W Merchandise Mart Plaza, Suite 1800, Chicago, IL 60654, United States

1.3 Product Feature of Equipment Under Test

Product Feature	
Equipment	Mobile Cellular Phone
Brand Name	Motorola
Model Name	10061 (Single SIM), 10058 (Dual SIM)
FCC ID	IHDT56WA3
IMEI Code	IMEI 1 : 351888080009056 IMEI 2 : 351888080009064
EUT supports Radios application	GSM/EGPRS/WCDMA/HSPA/LTE/NFC/FM WLAN 11b/g/n HT20 WLAN 11a/n HT20/HT40 Bluetooth BR/EDR/LE
HW Version	DVT2
EUT Stage	Identical Prototype

Remark:

1. The above EUT's information was declared by manufacturer. Please refer to the specifications or user's manual for more detailed description.
2. This is a variant report. All the test cases were performed on original report which can be referred to Sporton Report Number FR720310A.



Accessory List	
AC Adapter 1	Brand Name : Motorola
	Model Name : SPN5971A
AC Adapter 2	Brand Name : Motorola
	Model Name : SPN5972A
AC Adapter 3	Brand Name : Motorola
	Model Name : SPN5989A
AC Adapter 4	Brand Name : Motorola
	Model Name : SPN5990A
AC Adapter 5	Brand Name : Motorola
	Model Name : SPN5979A
AC Adapter 6	Brand Name : Motorola
	Model Name : SPN5980A
Battery 1	Brand Name : Motorola
	Model Name : SNN5983A
Battery 2	Brand Name : Motorola
	Model Name : SNN5985A
Earphone	Brand Name : Motorola
	Model Name : SH38C16618
USB Cable	Brand Name : Motorola
	Model Name : SKN6473A

1.4 Product Specification of Equipment Under Test

Standards-related Product Specification	
Tx/Rx Frequency Range	2402 MHz ~ 2480 MHz
Number of Channels	79
Carrier Frequency of Each Channel	2402+n*1 MHz; n=0~78
Maximum Output Power to Antenna	Bluetooth BR(1Mbps) : 12.35 dBm (0.0172 W) Bluetooth EDR (2Mbps) : 12.43 dBm (0.0175 W) Bluetooth EDR (3Mbps) : 12.72 dBm (0.0187 W)
Antenna Type / Gain	Loop Antenna type with gain -0.50 dBi
Type of Modulation	Bluetooth BR (1Mbps) : GFSK Bluetooth EDR (2Mbps) : $\pi/4$ -DQPSK Bluetooth EDR (3Mbps) : 8-DPSK

1.5 Modification of EUT

No modifications are made to the EUT during all test items.



1.6 Testing Location

Sporton Lab is accredited to ISO 17025 by Taiwan Accreditation Foundation (TAF code : 1190) and the FCC designation No. TW0007 under the FCC 2.948(e) by Mutual Recognition Agreement (MRA) in FCC Test.

Test Site	SPORTON INTERNATIONAL INC.
Test Site Location	No. 52, Hwa Ya 1 st Rd., Hwa Ya Technology Park, Kwei-Shan District, Tao Yuan City, Taiwan, R.O.C. TEL: +886-3-327-3456 FAX: +886-3-328-4978
Test Site No.	Sporton Site No.
	TH05-HY

Note: The test site complies with ANSI C63.4 2014 requirement.

Test Site	SPORTON INTERNATIONAL INC.
Test Site Location	No.58, Aly. 75, Ln. 564, Wenhua 3rd Rd. Guishan Dist, Taoyuan City, Taiwan (R.O.C.) TEL: +886-3-327-0868 FAX: +886-3-327-0855
Test Site No.	Sporton Site No.
	03CH11-HY

Note: The test site complies with ANSI C63.4 2014 requirement.

1.7 Applicable Standards

According to the specifications of the manufacturer, the EUT must comply with the requirements of the following standards:

- ♦ FCC Part 15 Subpart C §15.247
- ♦ ANSI C63.10-2013

Remark:

1. All test items were verified and recorded according to the standards and without any deviation during the test.
2. This EUT has also been tested and complied with the requirements of FCC Part 15, Subpart B, recorded in a separate test report.



2 Test Configuration of Equipment Under Test

2.1 Carrier Frequency Channel

Frequency Band	Channel	Freq. (MHz)	Channel	Freq. (MHz)	Channel	Freq. (MHz)
2400-2483.5 MHz	0	2402	27	2429	54	2456
	1	2403	28	2430	55	2457
	2	2404	29	2431	56	2458
	3	2405	30	2432	57	2459
	4	2406	31	2433	58	2460
	5	2407	32	2434	59	2461
	6	2408	33	2435	60	2462
	7	2409	34	2436	61	2463
	8	2410	35	2437	62	2464
	9	2411	36	2438	63	2465
	10	2412	37	2439	64	2466
	11	2413	38	2440	65	2467
	12	2414	39	2441	66	2468
	13	2415	40	2442	67	2469
	14	2416	41	2443	68	2470
	15	2417	42	2444	69	2471
	16	2418	43	2445	70	2472
	17	2419	44	2446	71	2473
	18	2420	45	2447	72	2474
	19	2421	46	2448	73	2475
	20	2422	47	2449	74	2476
	21	2423	48	2450	75	2477
	22	2424	49	2451	76	2478
	23	2425	50	2452	77	2479
	24	2426	51	2453	78	2480
	25	2427	52	2454	-	-
	26	2428	53	2455	-	-

2.2 Descriptions of Test Mode

Preliminary tests were performed in different data rates and recorded the RF output power in the following table:

Channel	Frequency	Bluetooth RF Output Power		
		Data Rate / Modulation		
		GFSK	$\pi/4$ -DQPSK	8-DPSK
		1Mbps	2Mbps	3Mbps
Ch00	2402MHz	11.43 dBm	11.52 dBm	11.82 dBm
Ch39	2441MHz	12.35 dBm	12.43 dBm	12.72 dBm
Ch78	2480MHz	9.14 dBm	9.20 dBm	9.48 dBm

- a. The EUT has been associated with peripherals and configuration operated in a manner tended to maximize its emission characteristics in a typical application. Frequency range investigated: radiation (9 kHz to the 10th harmonic of the highest fundamental frequency or to 40 GHz, whichever is lower). Pre-scanned tests, X, Y, Z in three orthogonal panels, and different data rates were conducted to determine the final configuration (Z plane as worst plane) from all possible combinations, and the worst mode of radiated spurious emissions is Bluetooth 3Mbps mode, and recorded in this report.

2.3 Test Mode

The following summary table is showing all test modes to demonstrate in compliance with the standard.

Summary table of Test Cases	
Test Item	Data Rate / Modulation
	Bluetooth EDR 3Mbps 8-DPSK
Radiated Test Cases	Mode 1: CH78_2480 MHz
Remark: All the radiated test cases were performance with Adapter 1 and Battery 1.	

2.4 Connection Diagram of Test System

<Bluetooth Tx Mode>

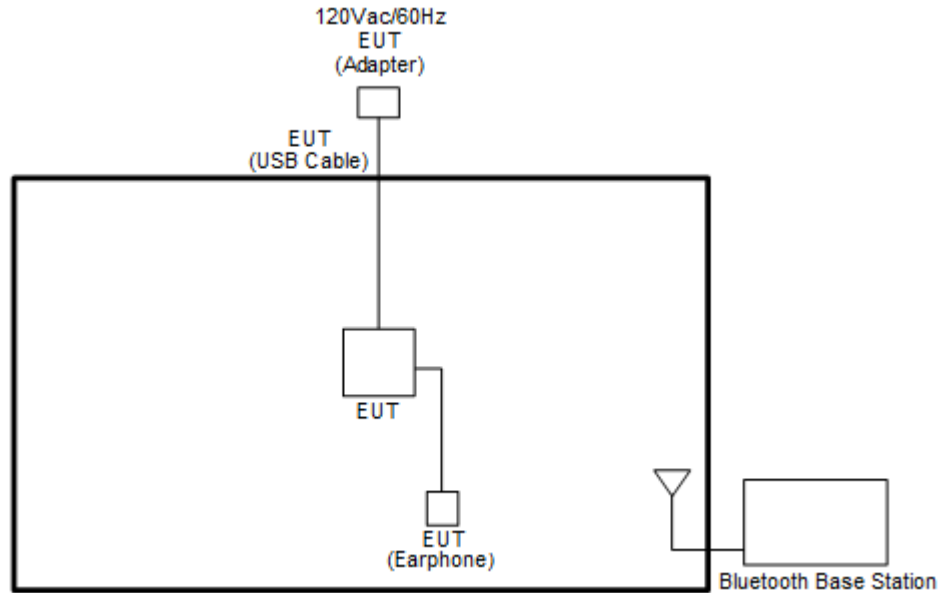

2.5 Support Unit used in test configuration and system

Item	Equipment	Trade Name	Model Name	FCC ID	Data Cable	Power Cord
1.	Bluetooth Base Station	R&S	CBT32	N/A	N/A	Unshielded, 1.8 m

2.6 EUT Operation Test Setup

The RF test items, programmed RF utility, "CMD" installed in the notebook make the EUT get into the engineering modes to contact with Bluetooth base station for continuous transmitting and receiving signals



3 Test Result

3.1 Radiated Band Edges and Spurious Emission Measurement

3.1.1 Limit of Radiated Band Edges and Spurious Emission

In any 100 kHz bandwidth outside the intentional radiator frequency band, all harmonics/spurious must be at least 20 dB below the highest emission level within the authorized band. In addition, radiated emissions which fall in the restricted bands must also comply with the FCC section 15.209 limits as below.

Frequency (MHz)	Field Strength (microvolts/meter)	Measurement Distance (meters)
0.009 – 0.490	2400/F(kHz)	300
0.490 – 1.705	24000/F(kHz)	30
1.705 – 30.0	30	30
30 – 88	100	3
88 – 216	150	3
216 - 960	200	3
Above 960	500	3

3.1.2 Measuring Instruments

The measuring equipment is listed in the section 4 of this test report.



3.1.3 Test Procedures

1. The EUT was placed on a turntable with 0.8 meter for frequency below 1GHz and 1.5 meter for frequency above 1GHz respectively above ground.
1. The EUT was set 3 meters from the interference receiving antenna, which was mounted on the top of a variable height antenna tower.
2. For each suspected emission, the EUT was arranged to its worst case and then tune the Antenna tower (from 1 m to 4 m) and turntable (from 0 degree to 360 degrees) to find the maximum reading. A pre-amp and a high pass filter are used for the test in order to get better signal level to comply with the guidelines.
3. Set to the maximum power setting and enable the EUT transmit continuously.
4. Use the following spectrum analyzer settings:
 - (1) Span shall wide enough to fully capture the emission being measured;
 - (2) Set RBW=100 kHz for $f < 1 \text{ GHz}$, RBW=1MHz for $f > 1\text{GHz}$; VBW \geq RBW; Sweep = auto; Detector function = peak; Trace = max hold for peak
 - (3) For average measurement: use duty cycle correction factor method per 15.35(c).
Duty cycle = On time/100 milliseconds
On time = $N_1 * L_1 + N_2 * L_2 + \dots + N_{n-1} * L_{n-1} + N_n * L_n$
Where N_1 is number of type 1 pulses, L_1 is length of type 1 pulses, etc.
Average Emission Level = Peak Emission Level + $20 * \log(\text{Duty cycle})$
5. Corrected Reading: Antenna Factor + Cable Loss + Read Level - Preamp Factor = Level

Note: The average levels were calculated from the peak level corrected with duty cycle correction factor (24.76dB) derived from $20 \log (\text{dwell time}/100\text{ms})$. This correction is only for signals that hop with the fundamental signal, such as band-edge and harmonic. Other spurious signals that are independent of the hopping signal would not use this correction.

3.1.4 Test Setup

For radiated emissions below 30MHz

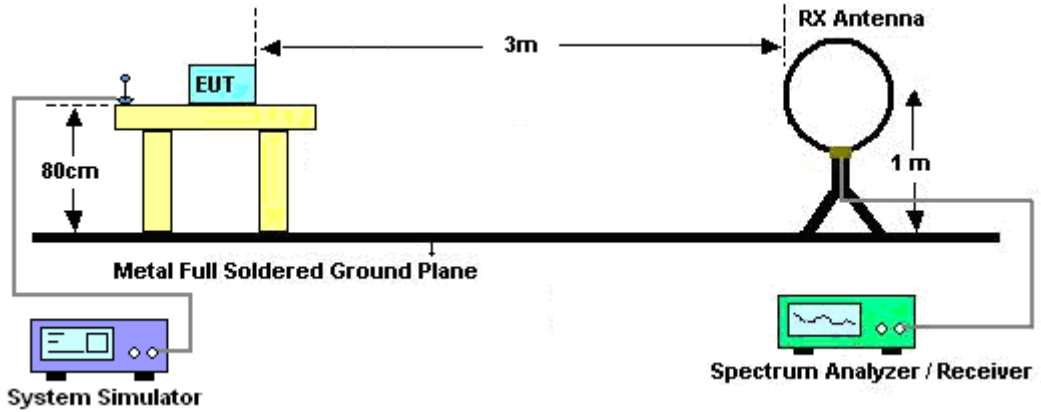

For radiated emissions from 30MHz to 1GHz

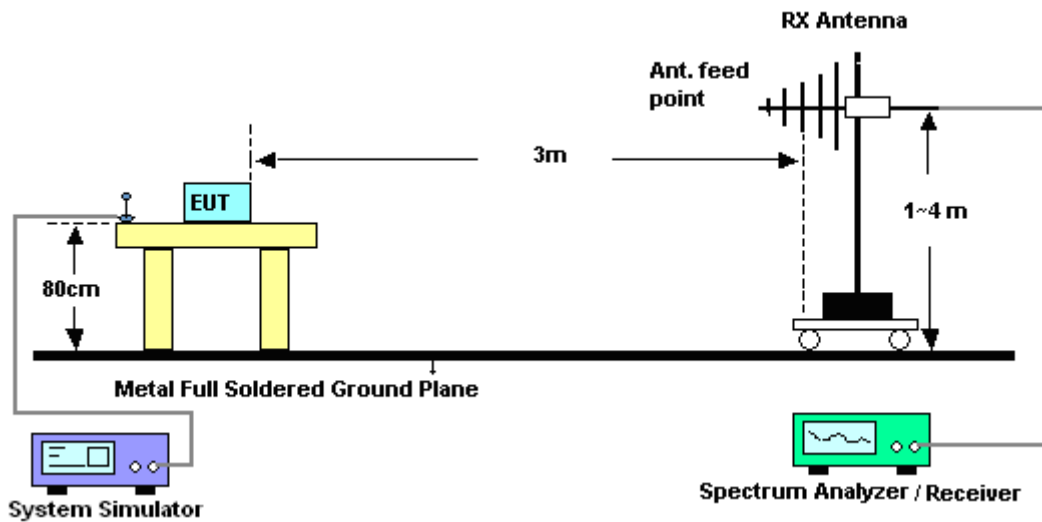

For radiated emissions above 1GHz

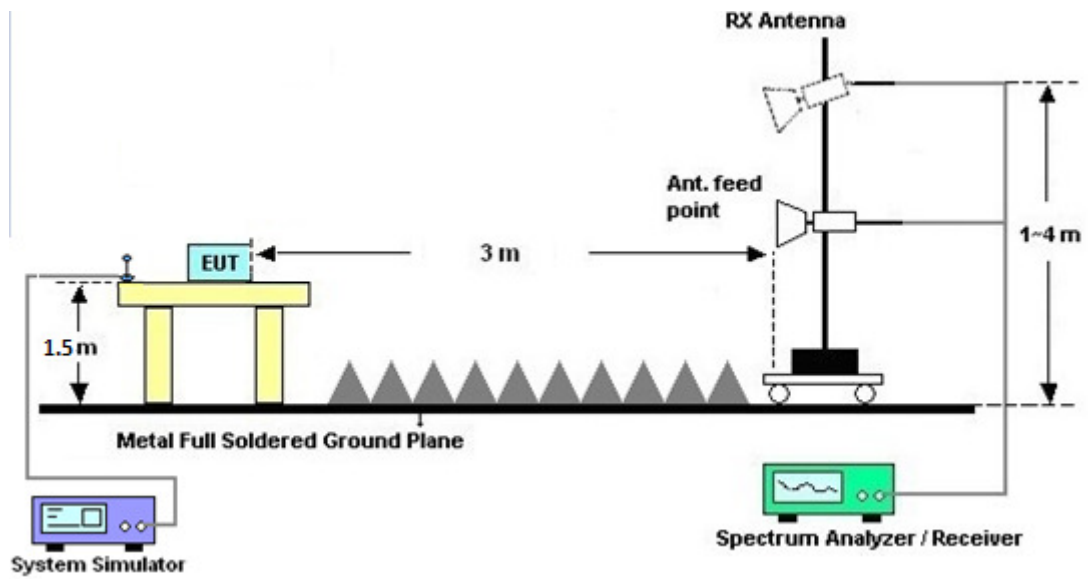

3.1.5 Test Results of Radiated Spurious Emissions (9 kHz ~ 30 MHz)

The low frequency, which started from 9 kHz to 30MHz, was pre-scanned and the result which was 20dB lower than the limit line per 15.31(o) was not reported.



3.1.6 Duty cycle correction factor for average measurement

3DH5 on time (One Pulse) Plot on Channel 39

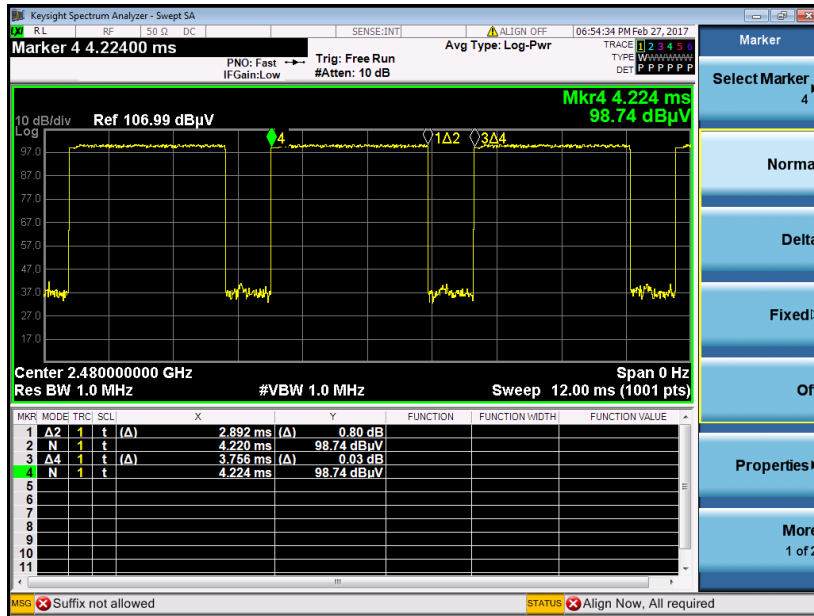

3DH5 on time (Count Pulses) Plot on Channel 39

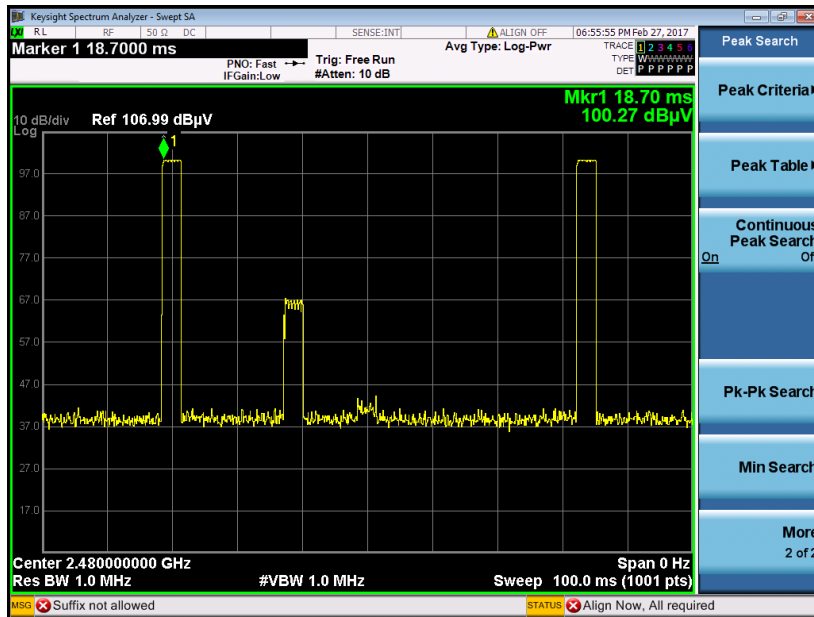

Note:

1. Worst case Duty cycle = on time/100 milliseconds = $2 * 2.89 / 100 = 5.78 \%$
2. Worst case Duty cycle correction factor = $20 * \log(\text{Duty cycle}) = -24.76 \text{ dB}$
3. 3DH5 has the highest duty cycle worst case and is reported.



Duty Cycle Correction Factor Consideration for AFH mode:

Bluetooth normal hopping rate is 1600Hz and reduced to 800Hz in AFH mode; due to the reduced number of hopping frequencies, with the same packet configuration the dwell time in each channel frequency within 100msec period is longer in AFH mode than normal mode.

In AFH mode, the minimum hopping frequencies are 20, to get the longest dwell time DH5 packet is observed; the period to have DH5 packet completing one hopping sequence is

$$2.89 \text{ ms} \times 20 \text{ channels} = 57.8 \text{ ms}$$

There cannot be 2 complete hopping sequences within 100ms period, considering the random hopping behavior, maximum 2 hops can be possibly observed within the period. $[100\text{ms} / 57.6\text{ms}] = 2 \text{ hops}$

Thus, the maximum possible ON time:

$$2.89 \text{ ms} \times 2 = 5.78 \text{ ms}$$

Worst case Duty Cycle Correction factor, which is derived from the maximum possible ON time,

$$20 \times \log(5.78 \text{ ms}/100\text{ms}) = -24.76 \text{ dB}$$

3.1.7 Test Result of Radiated Spurious at Band Edges

Please refer to Appendix A and B.

3.1.8 Test Result of Radiated Spurious Emission (30MHz ~ 10th Harmonic)

Please refer to Appendix A and B.



3.2 Antenna Requirements

3.2.1 Standard Applicable

If directional gain of transmitting antennas is greater than 6dBi, the power shall be reduced by the same level in dB comparing to gain minus 6dBi. The use of a permanently attached antenna or of an antenna that uses a unique coupling to the intentional radiator shall be considered sufficient to comply with the FCC rule.

3.2.2 Antenna Anti-Replacement Construction

An embedded-in antenna design is used.

3.2.3 Antenna Gain

The antenna peak gain of EUT is less than 6 dBi. Therefore, it is not necessary to reduce maximum peak output power limit.



4 List of Measuring Equipment

Instrument	Manufacturer	Model No.	Serial No.	Characteristics	Calibration Date	Test Date	Due Date	Remark
Power Meter	Agilent	E4416A	GB412923 44	300MHz~40GHz	Dec. 26, 2016	Feb.18.2017	Dec. 25, 2017	Conducted (TH05-HY)
Power Sensor	Agilent	E9327A	US404415 48	300MHz~40GHz	Dec. 26, 2016	Feb.18.2017	Dec. 25, 2017	Conducted (TH05-HY)
Amplifier	SONOMA	310N	187312	9kHz~1GHz	Nov. 10, 2016	Feb. 27, 2017 ~ Mar. 09, 2017	Nov. 09, 2017	Radiation (03CH11-HY)
Loop Antenna	Rohde & Schwarz	HFH2-Z2	100315	9 kHz~30 MHz	Sep. 02, 2015	Feb. 27, 2017 ~ Mar. 09, 2017	Sep. 01, 2017	Radiation (03CH11-HY)
Bilog Antenna	TESEQ	CBL 6111D	35414	30MHz~1GHz	Oct. 15, 2016	Feb. 27, 2017 ~ Mar. 09, 2017	Oct. 14, 2017	Radiation (03CH11-HY)
Horn Antenna	SCHWARZBE CK	BBHA 9120 D	9120D-152 2	1GHz ~ 18GHz	Oct. 07, 2016	Feb. 27, 2017 ~ Mar. 09, 2017	Oct. 06, 2017	Radiation (03CH11-HY)
Preamplifier	Keysight	83017A	MY532700 80	1GHz~26.5GHz	Nov. 10, 2016	Feb. 27, 2017 ~ Mar. 09, 2017	Nov. 09, 2017	Radiation (03CH11-HY)
Spectrum Analyzer	Keysight	N9010A	MY523502 76	10Hz ~ 44GHz	Oct. 12, 2016	Feb. 27, 2017 ~ Mar. 09, 2017	Oct. 11, 2017	Radiation (03CH11-HY)
Antenna Mast	EMEC	AM-BS-4500- B	N/A	1~4m	N/A	Feb. 27, 2017 ~ Mar. 09, 2017	N/A	Radiation (03CH11-HY)
Turn Table	EMEC	TT 2000	N/A	0~360 Degree	N/A	Feb. 27, 2017 ~ Mar. 09, 2017	N/A	Radiation (03CH11-HY)
Preamplifier	MITEQ	AMF-7D-0010 1800	2025787	1GHz~18GHz	Feb. 13, 2017	Feb. 27, 2017 ~ Mar. 09, 2017	Feb. 12, 2018	Radiation (03CH11-HY)
SHF-EHF Horn Antenna	SCHWARZBE CK	BBHA 9170	BBHA9170 584	18GHz- 40GHz	Nov. 08, 2016	Feb. 27, 2017 ~ Mar. 09, 2017	Nov. 07, 2017	Radiation (03CH11-HY)
Preamplifier	MITEQ	JS44-180040 00-33-8P	1840917	18GHz ~ 40GHz	Jun. 14, 2016	Feb. 27, 2017 ~ Mar. 09, 2017	Jun. 13, 2017	Radiation (03CH11-HY)



5 Uncertainty of Evaluation

Uncertainty of Radiated Emission Measurement (30 MHz ~ 1000 MHz)

Measuring Uncertainty for a Level of Confidence of 95% ($U = 2Uc(y)$)	5.2
---	-----

Uncertainty of Radiated Emission Measurement (1000 MHz ~ 18000 MHz)

Measuring Uncertainty for a Level of Confidence of 95% ($U = 2Uc(y)$)	5.5
---	-----

Uncertainty of Radiated Emission Measurement (18000 MHz ~ 40000 MHz)

Measuring Uncertainty for a Level of Confidence of 95% ($U = 2Uc(y)$)	5.2
---	-----



Appendix A. Radiated Spurious Emission

Test Engineer :	JC Liao, Jacky Hung, and Ken Wu	Temperature :	20~24°C
		Relative Humidity :	50~54%

2.4GHz 2400~2483.5MHz

BT (Band Edge @ 3m)

BT	Note	Frequency (MHz)	Level (dBμV/m)	Over Limit (dB)	Limit Line (dBμV/m)	Read Level (dBμV)	Antenna Factor (dB/m)	Cable Loss (dB)	Preamp Factor (dB)	Ant Pos (cm)	Table Pos (deg)	Peak Avg. (P/A)	Pol. (H/V)	
BT CH 78 2480MHz	*	2480	101.01	-	-	98.16	27.45	8.98	33.58	362	60	P	H	
	*	2480	76.25	-	-	-	-	-	-	-	-	A	H	
		2496.76	45.23	-28.77	74	42.32	27.5	8.98	33.57	362	60	P	H	
		2496.76	20.47	-33.53	54	-	-	-	-	-	-	A	H	
													H	
														H
	*	2480	103.76	-	-	100.91	27.45	8.98	33.58	183	138	P	V	
	*	2480	79	-	-	-	-	-	-	-	-	-	A	V
		2484	47.29	-26.71	74	44.44	27.45	8.98	33.58	183	138	P	V	
		2484	22.53	-31.47	54	-	-	-	-	-	-	A	V	
														V
														V
Remark	1. No other spurious found. 2. All results are PASS against Peak and Average limit line.													



2.4GHz 2400~2483.5MHz

BT (Harmonic @ 3m)

BT	Note	Frequency (MHz)	Level (dBμV/m)	Over Limit (dB)	Limit Line (dBμV/m)	Read Level (dBμV)	Antenna Factor (dB/m)	Cable Loss (dB)	Preamp Factor (dB)	Ant Pos (cm)	Table Pos (deg)	Peak Avg. (P/A)	Pol. (H/V)
BT CH 78 2480MHz		4960	39.29	-34.71	74	54.37	31.94	11.12	58.14	100	0	P	H
		4960	14.53	-39.47	54	-	-	-	-	-	-	A	H
		7440	40.28	-33.72	74	49.13	37.44	12.88	59.17	100	0	P	H
		7440	15.52	-38.48	54	-	-	-	-	-	-	A	H
		4960	37.37	-36.63	74	52.45	31.94	11.12	58.14	100	0	P	V
		4960	12.61	-41.39	54	-	-	-	-	-	-	A	V
		7440	40.85	-33.15	74	49.7	37.44	12.88	59.17	100	0	P	V
		7440	16.09	-37.91	54	-	-	-	-	-	-	A	V
Remark	1. No other spurious found. 2. All results are PASS against Peak and Average limit line.												



Emission below 1GHz

2.4GHz BT (LF)

BT	Note	Frequency	Level	Over	Limit	Read	Antenna	Cable	Preamp	Ant	Table	Peak	Pol.	
		(MHz)	(dBμV/m)	(dB)	(dBμV/m)	(dBμV)	(dB/m)	(dB)	(dB)	(cm)	(deg)	(P/A)	(H/V)	
2.4GHz BT LF		32.7	24.12	-15.88	40	31.18	24.14	1.29	32.49	-	-	P	H	
		193.08	21.3	-22.2	43.5	36.55	15.51	2.1	32.86	-	-	P	H	
		217.38	21	-25	46	35.5	16.2	2.1	32.8	-	-	P	H	
		869.8	32.54	-13.46	46	30.77	29.02	4.57	31.82	-	-	P	H	
		928.6	33.32	-12.68	46	30.08	30	4.63	31.39	-	-	P	H	
		942.6	33.96	-12.04	46	30.12	30.41	4.69	31.26	310	144	P	H	
													H	
													H	
													H	
													H	
													H	
													H	
													H	
			32.7	33.21	-6.79	40	40.27	24.14	1.29	32.49	198	247	P	V
			48.9	28.51	-11.49	40	43.94	15.77	1.29	32.49	-	-	P	V
			81.84	28.62	-11.38	40	45.77	13.82	1.51	32.48	-	-	P	V
			742.4	30.05	-15.95	46	30.77	27.54	4.09	32.35	-	-	P	V
			778.1	30.53	-15.47	46	30.65	28.03	4.09	32.24	-	-	P	V
			942.6	33.53	-12.47	46	29.69	30.41	4.69	31.26	-	-	P	V
														V
													V	
													V	
													V	
													V	
													V	
Remark	1. No other spurious found. 2. All results are PASS against limit line.													



Note symbol

*	Fundamental Frequency which can be ignored. However, the level of any unwanted emissions shall not exceed the level of the fundamental frequency.
!	Test result is over limit line.
P/A	Peak or Average
H/V	Horizontal or Vertical



A calculation example for radiated spurious emission is shown as below:

WIFI	Note	Frequency	Level	Over	Limit	Read	Antenna	Cable	Preamp	Ant	Table	Peak	Pol.
Ant.				Limit	Line	Level	Factor	Loss	Factor	Pos	Pos	Avg.	
1+2		(MHz)	(dBμV/m)	(dB)	(dBμV/m)	(dBμV)	(dB/m)	(dB)	(dB)	(cm)	(deg)	(P/A)	(H/V)
802.11b		2390	55.45	-18.55	74	54.51	32.22	4.58	35.86	103	308	P	H
CH 01													
2412MHz		2390	43.54	-10.46	54	42.6	32.22	4.58	35.86	103	308	A	H

- Level(dBμV/m) =
Antenna Factor(dB/m) + Cable Loss(dB) + Read Level(dBμV) - Preamp Factor(dB)
- Over Limit(dB) = Level(dBμV/m) – Limit Line(dBμV/m)

For Peak Limit @ 2390MHz:

- Level(dBμV/m)
= Antenna Factor(dB/m) + Cable Loss(dB) + Read Level(dBμV) - Preamp Factor(dB)
= 32.22(dB/m) + 4.58(dB) + 54.51(dBμV) – 35.86 (dB)
= 55.45 (dBμV/m)
- Over Limit(dB)
= Level(dBμV/m) – Limit Line(dBμV/m)
= 55.45(dBμV/m) – 74(dBμV/m)
= -18.55(dB)

For Average Limit @ 2390MHz:

- Level(dBμV/m)
= Antenna Factor(dB/m) + Cable Loss(dB) + Read Level(dBμV) - Preamp Factor(dB)
= 32.22(dB/m) + 4.58(dB) + 42.6(dBμV) – 35.86 (dB)
= 43.54 (dBμV/m)
- Over Limit(dB)
= Level(dBμV/m) – Limit Line(dBμV/m)
= 43.54(dBμV/m) – 54(dBμV/m)
= -10.46(dB)

Both peak and average measured complies with the limit line, so test result is “PASS”.



Appendix B. Radiated Spurious Emission Plots

Test Engineer :	JC Liao, Jacky Hung, and Ken Wu	Temperature :	20~24°C
		Relative Humidity :	50~54%

Note symbol

-L	Low channel location
-R	High channel location



2.4GHz 2400~2483.5MHz

BT (Band Edge @ 3m)

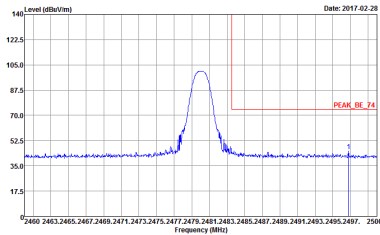
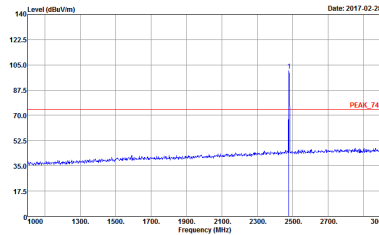
BT	2.4GHz 2400~2483.5MHz Band Edge @ 3m	
ANT	BT CH78 2480MHz	
1	Horizontal	Fundamental
Peak	 <p>Site : 03CH11-HY Condition : PEAK_BE_74 3m HORN 9120D-HF HORIZONTAL</p>	 <p>Site : 03CH11-HY Condition : PEAK_74 3m HORN 9120D-HF HORIZONTAL</p>



BT	2.4GHz 2400~2483.5MHz Band Edge @ 3m	
ANT	BT CH78 2480MHz	
1	Vertical	Fundamental
Peak	<p>Site : 03CHI1-HY Condition : -PEAK_BE_74 3m HORN 9120D-HF VERTICAL</p>	<p>Site : 03CHI1-HY Condition : -PEAK_74 3m HORN 9120D-HF VERTICAL</p>



2.4GHz 2400~2483.5MHz

BT (Harmonic @ 3m)

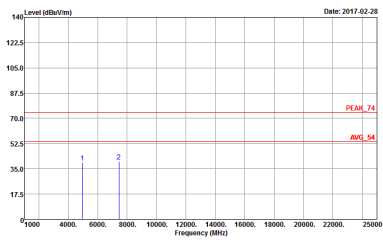
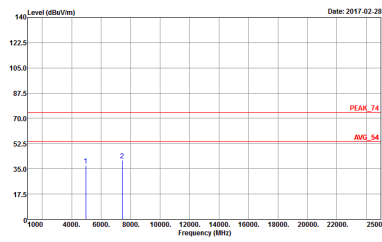
BT	2.4GHz 2400~2483.5MHz Harmonic @ 3m	
ANT	BT CH78 2480MHz	
1	Horizontal	Vertical
<p>Peak</p> <p>Avg.</p>	 <p>Site : 03CH11-HY Condition : -PEAK_74 3m 9170 SHF HORM_150809 HORIZONTAL</p>	 <p>Site : 03CH11-HY Condition : -PEAK_74 3m 9170 SHF HORM_150809 VERTICAL</p>



Emission below 1GHz

2.4GHz BT (LF)

BT	2.4GHz 2400~2483.5MHz	
ANT	BT LF	
1	Horizontal	Vertical
QP / Peak	<p>Site : 03GH11-HY Condition : QP 3m BE-LOG 6111D-LF_ETC HORIZONTAL</p>	<p>Site : 03GH11-HY Condition : QP 3m BE-LOG 6111D-LF_ETC VERTICAL</p>



Appendix C. Original Report

Please refer to Sporton report number FR720310A.