



FCC RF Test Report

APPLICANT : Motorola Mobility, LLC
EQUIPMENT : Mobile Cellular Phone
BRAND NAME : Motorola
MODEL NAME : 10061 (Single SIM), 10058 (Dual SIM)
FCC ID : IHDT56WA3
STANDARD : FCC Part 15 Subpart C §15.247
CLASSIFICATION : (DTS) Digital Transmission System

This is a variant report which is only valid together with the original test report. The product was received on Feb. 03, 2017 and testing was completed on Mar. 09, 2017. We, SPORTON INTERNATIONAL INC., would like to declare that the tested sample has been evaluated in accordance with the test procedures and has been in compliance with the applicable technical standards.

The test results in this report apply exclusively to the tested model / sample. Without written approval of SPORTON INTERNATIONAL INC., the test report shall not be reproduced except in full.

Reviewed by: Joseph Lin / Supervisor

Approved by: Jones Tsai / Manager



SPORTON INTERNATIONAL INC.

No. 52, Hwa Ya 1st Rd., Hwa Ya Technology Park, Kwei-Shan District, Tao Yuan City, Taiwan, R.O.C.



TABLE OF CONTENTS

REVISION HISTORY..... 3

SUMMARY OF TEST RESULT 4

1 GENERAL DESCRIPTION 5

 1.1 Applicant 5

 1.2 Manufacturer 5

 1.3 Product Feature of Equipment Under Test..... 5

 1.4 Product Specification of Equipment Under Test..... 6

 1.5 Modification of EUT 6

 1.6 Testing Location 7

 1.7 Applicable Standards 7

2 TEST CONFIGURATION OF EQUIPMENT UNDER TEST 8

 2.1 Carrier Frequency and Channel 8

 2.2 Test Mode 8

 2.3 Connection Diagram of Test System 9

 2.4 EUT Operation Test Setup 9

3 TEST RESULT 10

 3.1 Output Power Measurement 10

 3.2 Radiated Band Edges and Spurious Emission Measurement 11

 3.3 Antenna Requirements 15

4 LIST OF MEASURING EQUIPMENT 16

5 UNCERTAINTY OF EVALUATION 17

APPENDIX A. CONDUCTED TEST RESULTS

APPENDIX B. RADIATED SPURIOUS EMISSION

APPENDIX C. RADIATED SPURIOUS EMISSION PLOTS

APPENDIX D. DUTY CYCLE PLOTS

APPENDIX E. ORIGINAL REPORT



SUMMARY OF TEST RESULT

Report Section	FCC Rule	Description	Limit	Result	Remark
3.1	15.247(b)	Power Output Measurement	≤ 30dBm	Pass	-
3.2	15.247(d)	Radiated Band Edges and Radiated Spurious Emission	15.209(a) & 15.247(d)	Pass	Under limit 2.00 dB at 2483.840 MHz
3.3	15.203 & 15.247(b)	Antenna Requirement	N/A	Pass	-



1 General Description

1.1 Applicant

Motorola Mobility, LLC

222 W Merchandise Mart Plaza, Suite 1800, Chicago, IL 60654, United States

1.2 Manufacturer

Motorola Mobility, LLC

222 W Merchandise Mart Plaza, Suite 1800, Chicago, IL 60654, United States

1.3 Product Feature of Equipment Under Test

Product Feature	
Equipment	Mobile Cellular Phone
Brand Name	Motorola
Model Name	10061 (Single SIM), 10058 (Dual SIM)
FCC ID	IHDT56WA3
IMEI Code	IMEI 1 : 351888080009239 IMEI 2 : 351888080009247
EUT supports Radios application	GSM/EGPRS/WCDMA/HSPA/LTE/NFC/FM WLAN 11b/g/n HT20 WLAN 11a/n HT20/HT40 Bluetooth BR/EDR/LE
HW Version	DVT2
EUT Stage	Identical Prototype

Remark:

1. The above EUT's information was declared by manufacturer. Please refer to the specifications or user's manual for more detailed description.
2. This is a variant report. All the test cases were performed on original report which can be referred to Sporton Report Number FR720310C.



Accessory List	
AC Adapter 1	Brand Name : Motorola
	Model Name : SPN5971A
AC Adapter 2	Brand Name : Motorola
	Model Name : SPN5972A
AC Adapter 3	Brand Name : Motorola
	Model Name : SPN5989A
AC Adapter 4	Brand Name : Motorola
	Model Name : SPN5990A
AC Adapter 5	Brand Name : Motorola
	Model Name : SPN5979A
AC Adapter 6	Brand Name : Motorola
	Model Name : SPN5980A
Battery 1	Brand Name : Motorola
	Model Name : SNN5983A
Battery 2	Brand Name : Motorola
	Model Name : SNN5985A
Earphone	Brand Name : Motorola
	Model Name : SH38C16618
USB Cable	Brand Name : Motorola
	Model Name : SKN6473A

1.4 Product Specification of Equipment Under Test

Standards-related Product Specification	
Tx/Rx Channel Frequency Range	2412 MHz ~ 2462 MHz
Maximum (Peak) Output Power to antenna	802.11b : 21.06 dBm (0.1276 W)
	802.11g : 23.45 dBm (0.2213 W)
	802.11n HT20 : 23.25 dBm (0.2113 W)
Antenna Type / Gain	Loop Antenna type with gain -0.50 dBi
Type of Modulation	802.11b : DSSS (DBPSK / DQPSK / CCK)
	802.11g/n : OFDM (BPSK / QPSK / 16QAM / 64QAM)

1.5 Modification of EUT

No modifications are made to the EUT during all test items.



1.6 Testing Location

Sporton Lab is accredited to ISO 17025 by Taiwan Accreditation Foundation (TAF code : 1190) and the FCC designation No. TW0007 under the FCC 2.948(e) by Mutual Recognition Agreement (MRA) in FCC Test.

Test Site	SPORTON INTERNATIONAL INC.
Test Site Location	No. 52, Hwa Ya 1 st Rd., Hwa Ya Technology Park, Kwei-Shan District, Tao Yuan City, Taiwan, R.O.C. TEL: +886-3-327-3456 FAX: +886-3-328-4978
Test Site No.	Sporton Site No. TH05-HY

Note: The test site complies with ANSI C63.4 2014 requirement.

Test Site	SPORTON INTERNATIONAL INC.
Test Site Location	No. 52, Hwa Ya 1 st Rd., Hwa Ya Technology Park, Kwei-Shan District, Tao Yuan City, Taiwan, R.O.C. TEL: +886-3-327-3456 FAX: +886-3-328-4978
Test Site No.	Sporton Site No. 03CH11-HY

Note: The test site complies with ANSI C63.4 2014 requirement.

1.7 Applicable Standards

According to the specifications of the manufacturer, the EUT must comply with the requirements of the following standards:

- ♦ FCC Part 15 Subpart C §15.247
- ♦ FCC KDB Publication No. 558074 D01 DTS Meas. Guidance v03r05
- ♦ ANSI C63.10-2013

Remark:

1. All test items were verified and recorded according to the standards and without any deviation during the test.
2. This EUT has also been tested and complied with the requirements of FCC Part 15, Subpart B, recorded in a separate test report.



2 Test Configuration of Equipment Under Test

The EUT has been associated with peripherals and configuration operated in a manner tended to maximize its emission characteristics in a typical application. Frequency range investigated: radiated emission (9 kHz to the 10th harmonic of the highest fundamental frequency or to 40 GHz, whichever is lower). For radiated measurement, pre-scanned in three orthogonal panels, X, Y, Z. The worst cases (X plane) were recorded in this report.

2.1 Carrier Frequency and Channel

Frequency Band	Channel	Freq. (MHz)	Channel	Freq. (MHz)
2400-2483.5 MHz	1	2412	7	2442
	2	2417	8	2447
	3	2422	9	2452
	4	2427	10	2457
	5	2432	11	2462
	6	2437	-	-

2.2 Test Mode

Final test mode of conducted test items and radiated spurious emissions are considering the modulation and worse data rates as below table.

Modulation	Data Rate
802.11b	1 Mbps
802.11n HT20	MCS0

Remark: All the radiated test cases were performance with Adapter 1 and Battery 1.

2.3 Connection Diagram of Test System

<WLAN Tx Mode>

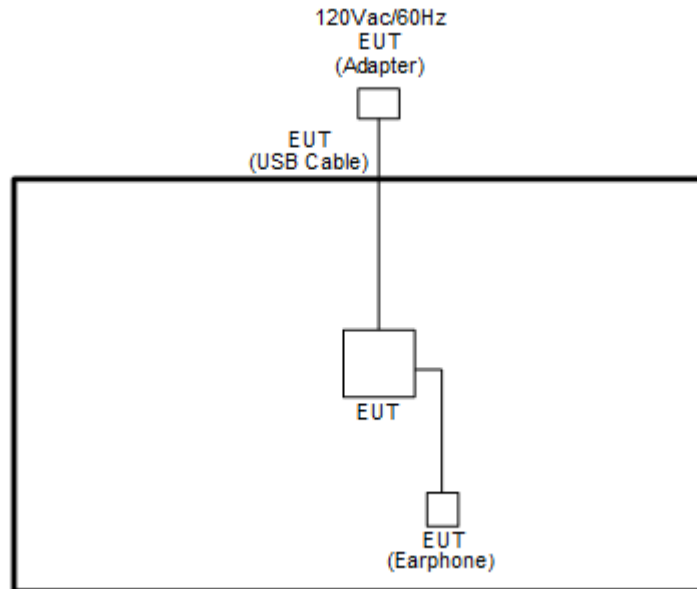

2.4 EUT Operation Test Setup

The RF test items, programmed RF utility, "QRCT.exe" installed in the notebook make the EUT provide functions like channel selection and power level for continuous transmitting and receiving signals.

3 Test Result

3.1 Output Power Measurement

3.1.1 Limit of Output Power

For systems using digital modulation in the 2400-2483.5MHz, the limit for peak output power is 30dBm. If transmitting antenna of directional gain greater than 6dBi are used the peak output power from the intentional radiator shall be reduced below the above stated value by the amount in dB that the directional gain of the antenna exceeds 6 dBi. In case of point-to-point operation, the limit has to be reduced by 1dB for every 3dB that the directional gain of the antenna exceeds 6dBi.

3.1.2 Measuring Instruments

The measuring equipment is listed in the section 4 of this test report.

3.1.3 Test Procedures

1. The testing follows the Measurement Procedure of FCC KDB No. 558074 DTS D01 Meas. Guidance v03r05 section 9.1.2 PKPM1 Peak power meter method.
2. The RF output of EUT was connected to the power meter by RF cable and attenuator. The path loss was compensated to the results for each measurement.
3. Set to the maximum power setting and enable the EUT transmit continuously.
4. Measure the conducted output power and record the results in the test report.

3.1.4 Test Setup

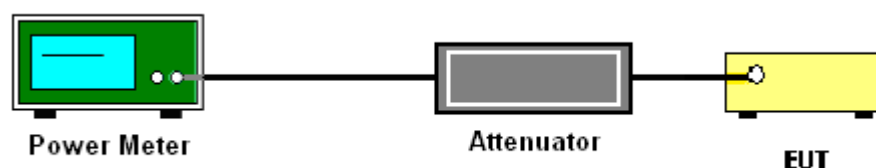

3.1.5 Test Result of Peak Output Power

Please refer to Appendix A.

3.1.6 Test Result of Average output Power (Reporting Only)

Please refer to Appendix A.



3.2 Radiated Band Edges and Spurious Emission Measurement

3.2.1 Limit of Radiated band edge and Spurious Emission Measurement

In any 100 kHz bandwidth outside the intentional radiator frequency band, all harmonics/spurious must be at least 20 dB below the highest emission level within the authorized band. If the output power of this device was measured by spectrum analyzer, the attenuation under this paragraph shall be 30 dB instead of 20 dB. In addition, radiated emissions which fall in the restricted bands must also comply with the FCC section 15.209 limits as below.

Frequency (MHz)	Field Strength (microvolts/meter)	Measurement Distance (meters)
0.009 – 0.490	2400/F(kHz)	300
0.490 – 1.705	24000/F(kHz)	30
1.705 – 30.0	30	30
30 – 88	100	3
88 – 216	150	3
216 - 960	200	3
Above 960	500	3

3.2.2 Measuring Instruments

The measuring equipment is listed in the section 4 of this test report.



3.2.3 Test Procedures

1. The testing follows FCC KDB Publication No. 558074 D01 DTS Meas. Guidance v03r05.
2. The EUT was arranged to its worst case and then tune the antenna tower (from 1 m to 4 m) and turntable (from 0 degree to 360 degrees) to find the maximum reading. A pre-amp and a high pass filter are used for the test in order to get better signal level.
3. The EUT was placed on a turntable with 0.8 meter for frequency below 1GHz and 1.5 meter for frequency above 1GHz respectively above ground.
4. The EUT was set 3 meters from the interference receiving antenna, which was mounted on the top of a variable height antenna tower.
5. Corrected Reading: Antenna Factor + Cable Loss + Read Level - Preamp Factor = Level
6. For measurement below 1GHz, If the emission level of the EUT measured by the peak detector is 3 dB lower than the applicable limit, the peak emission level will be reported. Otherwise, the emission measurement will be repeated using the quasi-peak detector and reported.
7. Use the following spectrum analyzer settings:
 - (1) Span shall wide enough to fully capture the emission being measured;
 - (2) Set RBW=100 kHz for $f < 1$ GHz; VBW \geq RBW; Sweep = auto; Detector function = peak; Trace = max hold;
 - (3) Set RBW = 1 MHz, VBW= 3MHz for $f \geq 1$ GHz for peak measurement.
For average measurement:
 - VBW = 10 Hz, when duty cycle is no less than 98 percent.
 - VBW $\geq 1/T$, when duty cycle is less than 98 percent where T is the minimum transmission duration over which the transmitter is on and is transmitting at its maximum power control level for the tested mode of operation.

3.2.4 Test Setup

For radiated emissions below 30MHz

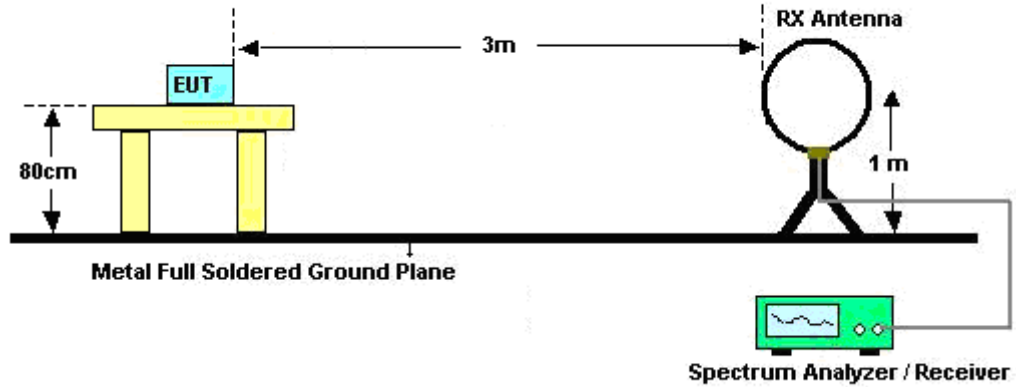

For radiated emissions from 30MHz to 1GHz

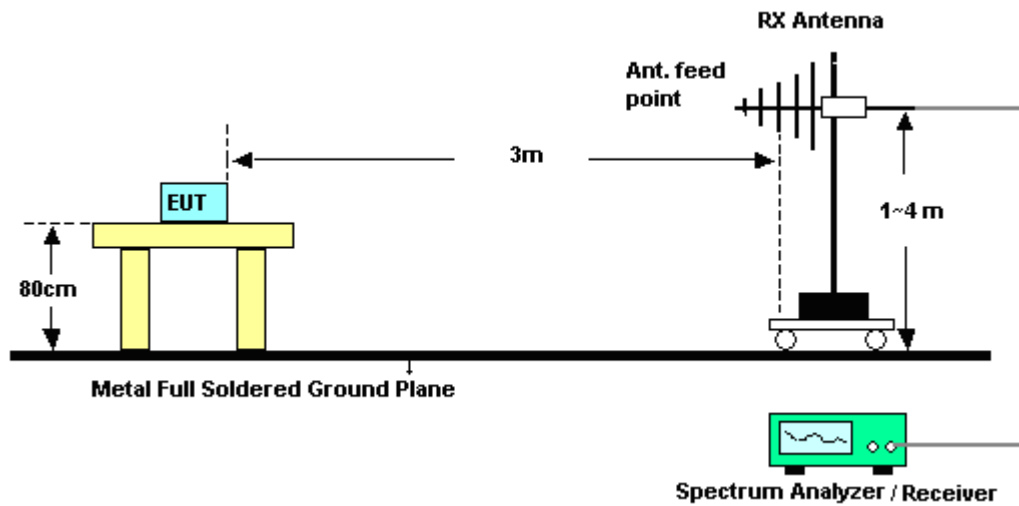

For radiated emissions above 1GHz

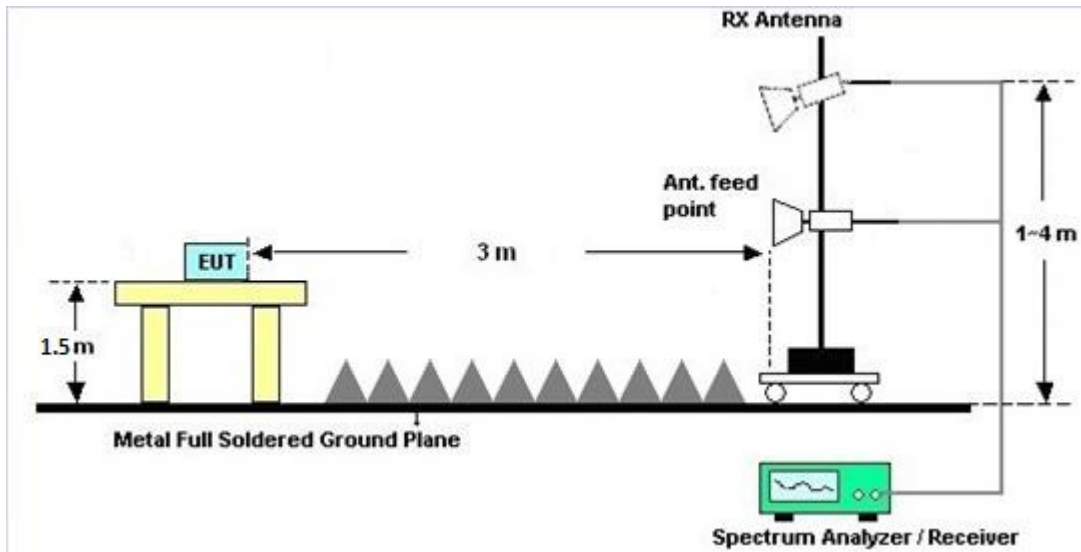

3.2.5 Test Results of Radiated Spurious Emissions (9kHz ~ 30MHz)

The low frequency, which started from 9 kHz to 30MHz, was pre-scanned and the result which was 20dB lower than the limit line per 15.31(o) was not reported.

3.2.6 Test Result of Radiated Spurious at Band Edges

Please refer to Appendix B and C.

3.2.7 Duty Cycle

Please refer to Appendix D.

3.2.8 Test Result of Radiated Spurious Emission (30MHz ~ 10th Harmonic)

Please refer to Appendix B and C.



3.3 Antenna Requirements

3.3.1 Standard Applicable

If directional gain of transmitting antennas is greater than 6dBi, the power shall be reduced by the same level in dB comparing to gain minus 6dBi. For the fixed point-to-point operation, the power shall be reduced by one dB for every 3 dB that the directional gain of the antenna exceeds 6 dBi. The use of a permanently attached antenna or of an antenna that uses a unique coupling to the intentional radiator shall be considered sufficient to comply with the FCC rule.

3.3.2 Antenna Anti-Replacement Construction

An embedded-in antenna design is used.

3.3.3 Antenna Gain

The antenna peak gain of EUT is less than 6 dBi. Therefore, it is not necessary to reduce maximum peak output power limit.



4 List of Measuring Equipment

Instrument	Manufacturer	Model No.	Serial No.	Characteristics	Calibration Date	Test Date	Due Date	Remark
Power Meter	Anritsu	ML2495A	0932001	300MHz~40GHz	Sep. 29, 2016	Feb. 18, 2017	Sep. 28, 2017	Conducted (TH05-HY)
Power Sensor	Anritsu	MA2411B	0846202	300MHz~40GHz	Sep. 29, 2016	Feb. 18, 2017	Sep. 28, 2017	Conducted (TH05-HY)
Amplifier	SONOMA	310N	187312	9kHz~1GHz	Nov. 10, 2016	Feb. 27, 2017 ~ Mar. 09, 2017	Nov. 09, 2017	Radiation (03CH11-HY)
Loop Antenna	Rohde & Schwarz	HFH2-Z2	100315	9 kHz~30 MHz	Sep. 02, 2015	Feb. 27, 2017 ~ Mar. 09, 2017	Sep. 01, 2017	Radiation (03CH11-HY)
Bilog Antenna	TESEQ	CBL 6111D	35414	30MHz~1GHz	Oct. 15, 2016	Feb. 27, 2017 ~ Mar. 09, 2017	Oct. 14, 2017	Radiation (03CH11-HY)
Horn Antenna	SCHWARZBECK	BBHA 9120 D	9120D-1522	1GHz ~ 18GHz	Oct. 07, 2016	Feb. 27, 2017 ~ Mar. 09, 2017	Oct. 06, 2017	Radiation (03CH11-HY)
Preamplifier	Keysight	83017A	MY53270080	1GHz~26.5GHz	Nov. 10, 2016	Feb. 27, 2017 ~ Mar. 09, 2017	Nov. 09, 2017	Radiation (03CH11-HY)
Spectrum Analyzer	Keysight	N9010A	MY52350276	10Hz ~ 44GHz	Oct. 12, 2016	Feb. 27, 2017 ~ Mar. 09, 2017	Oct. 11, 2017	Radiation (03CH11-HY)
Antenna Mast	EMEC	AM-BS-4500-B	N/A	1~4m	N/A	Feb. 27, 2017 ~ Mar. 09, 2017	N/A	Radiation (03CH11-HY)
Turn Table	EMEC	TT 2000	N/A	0~360 Degree	N/A	Feb. 27, 2017 ~ Mar. 09, 2017	N/A	Radiation (03CH11-HY)
Preamplifier	MITEQ	AMF-7D-00101800	2025787	1GHz~18GHz	Feb. 13, 2017	Feb. 27, 2017 ~ Mar. 09, 2017	Feb. 12, 2018	Radiation (03CH11-HY)
SHF-EHF Horn Antenna	SCHWARZBECK	BBHA 9170	BBHA9170584	18GHz- 40GHz	Nov. 08, 2016	Feb. 27, 2017 ~ Mar. 09, 2017	Nov. 07, 2017	Radiation (03CH11-HY)
Preamplifier	MITEQ	JS44-18004000-33-8P	1840917	18GHz ~ 40GHz	Jun. 14, 2016	Feb. 27, 2017 ~ Mar. 09, 2017	Jun. 13, 2017	Radiation (03CH11-HY)



5 Uncertainty of Evaluation

Uncertainty of Radiated Emission Measurement (30 MHz ~ 1000 MHz)

Measuring Uncertainty for a Level of Confidence of 95% ($U = 2Uc(y)$)	5.2
---	-----

Uncertainty of Radiated Emission Measurement (1000 MHz ~ 18000 MHz)

Measuring Uncertainty for a Level of Confidence of 95% ($U = 2Uc(y)$)	5.5
---	-----

Uncertainty of Radiated Emission Measurement (18000 MHz ~ 40000 MHz)

Measuring Uncertainty for a Level of Confidence of 95% ($U = 2Uc(y)$)	5.2
---	-----

Appendix A. Test Result of Conducted Test Items

Test Engineer:	Kai Liao	Temperature:	21~25	°C
Test Date:	2017/2/18	Relative Humidity:	51~54	%

TEST RESULTS DATA
Peak Power Table

2.4GHz Band										
Mod.	Data Rate	N _{TX}	CH.	Freq. (MHz)	Peak Conducted Power (dBm)	Conducted Power Limit (dBm)	DG (dBi)	EIRP Power (dBm)	EIRP Power Limit (dBm)	Pass /Fail
11b	1Mbps	1	1	2412	20.12	30.00	-0.50	19.62	36.00	Pass
11b	1Mbps	1	6	2437	21.06	30.00	-0.50	20.56	36.00	Pass
11b	1Mbps	1	11	2462	19.80	30.00	-0.50	19.30	36.00	Pass
11g	6Mbps	1	1	2412	22.57	30.00	-0.50	22.07	36.00	Pass
11g	6Mbps	1	6	2437	23.45	30.00	-0.50	22.95	36.00	Pass
11g	6Mbps	1	11	2462	21.08	30.00	-0.50	20.58	36.00	Pass
HT20	MCS0	1	1	2412	21.94	30.00	-0.50	21.44	36.00	Pass
HT20	MCS0	1	6	2437	23.25	30.00	-0.50	22.75	36.00	Pass
HT20	MCS0	1	11	2462	20.45	30.00	-0.50	19.95	36.00	Pass

TEST RESULTS DATA
Average Power Table
(Reporting Only)

2.4GHz Band						
Mod.	Data Rate	N _{TX}	CH.	Freq. (MHz)	Duty Factor (dB)	Average Conducted Power (dBm)
11b	1Mbps	1	1	2412	0.10	17.56
11b	1Mbps	1	6	2437	0.10	18.53
11b	1Mbps	1	11	2462	0.10	17.32
11g	6Mbps	1	1	2412	0.60	14.27
11g	6Mbps	1	6	2437	0.60	17.34
11g	6Mbps	1	11	2462	0.60	12.62
HT20	MCS0	1	1	2412	0.63	13.50
HT20	MCS0	1	6	2437	0.63	16.00
HT20	MCS0	1	11	2462	0.63	11.43



Appendix B. Radiated Spurious Emission

Test Engineer :	JC Liao, Jacky Hung, and Ken Wu	Temperature :	20~24°C
		Relative Humidity :	50~54%

2.4GHz 2400~2483.5MHz

WIFI 802.11b (Band Edge @ 3m)

WIFI Ant. 1	Note	Frequency (MHz)	Level (dBμV/m)	Over Limit (dB)	Limit Line (dBμV/m)	Read Level (dBμV)	Antenna Factor (dB/m)	Cable Loss (dB)	Preamp Factor (dB)	Ant Pos (cm)	Table Pos (deg)	Peak Avg. (P/A)	Pol. (H/V)
802.11b CH 11 2462MHz	*	2462	104.42	-	-	101.62	27.4	8.98	33.58	329	51	P	H
	*	2462	100.86	-	-	98.06	27.4	8.98	33.58	329	51	A	H
		2491.68	54.65	-19.35	74	51.75	27.5	8.98	33.58	329	51	P	H
		2486.08	43.99	-10.01	54	41.14	27.45	8.98	33.58	329	51	A	H
													H
													H
	*	2462	109.01	-	-	106.21	27.4	8.98	33.58	156	296	P	V
	*	2462	105.51	-	-	102.71	27.4	8.98	33.58	156	296	A	V
		2494.72	54.3	-19.7	74	51.39	27.5	8.98	33.57	156	296	P	V
		2484	44.41	-9.59	54	41.56	27.45	8.98	33.58	156	296	A	V
													V
													V
Remark	1. No other spurious found. 2. All results are PASS against Peak and Average limit line.												



2.4GHz 2400~2483.5MHz

WIFI 802.11b (Harmonic @ 3m)

WIFI Ant. 1	Note	Frequency (MHz)	Level (dBμV/m)	Over Limit (dB)	Limit Line (dBμV/m)	Read Level (dBμV)	Antenna Factor (dB/m)	Cable Loss (dB)	Preamp Factor (dB)	Ant Pos (cm)	Table Pos (deg)	Peak Avg. (P/A)	Pol. (H/V)	
802.11b CH 11 2462MHz		4924	42.71	-31.29	74	64.49	31.88	11	64.66	100	0	P	H	
		7386	41.41	-32.59	74	56.01	37.38	12.88	64.86	100	0	P	H	
													H	
													H	
			4924	43.29	-30.71	74	65.07	31.88	11	64.66	100	0	P	V
			7386	41.03	-32.97	74	55.63	37.38	12.88	64.86	100	0	P	V
														V
														V
Remark	1. No other spurious found. 2. All results are PASS against Peak and Average limit line.													



2.4GHz 2400~2483.5MHz

WIFI 802.11n HT20 (Band Edge @ 3m)

WIFI Ant. 1	Note	Frequency (MHz)	Level (dBμV/m)	Over Limit (dB)	Limit Line (dBμV/m)	Read Level (dBμV)	Antenna Factor (dB/m)	Cable Loss (dB)	Preamp Factor (dB)	Ant Pos (cm)	Table Pos (deg)	Peak Avg. (P/A)	Pol. (H/V)
802.11n HT20 CH 11 2462MHz	*	2462	100.4	-	-	97.6	27.4	8.98	33.58	328	53	P	H
	*	2462	91.72	-	-	88.92	27.4	8.98	33.58	328	53	A	H
		2484.04	60.39	-13.61	74	57.54	27.45	8.98	33.58	328	53	P	H
		2483.6	48.49	-5.51	54	45.64	27.45	8.98	33.58	328	53	A	H
													H
													H
	*	2462	104	-	-	101.2	27.4	8.98	33.58	135	296	P	V
	*	2462	95.85	-	-	93.05	27.4	8.98	33.58	135	296	A	V
		2483.92	67.23	-6.77	74	64.38	27.45	8.98	33.58	135	296	P	V
		2483.84	52	-2	54	49.15	27.45	8.98	33.58	135	296	A	V
												V	
												V	
Remark	1. No other spurious found. 2. All results are PASS against Peak and Average limit line.												



2.4GHz 2400~2483.5MHz

WIFI 802.11n HT20 (Harmonic @ 3m)

WIFI Ant. 1	Note	Frequency (MHz)	Level (dBμV/m)	Over Limit (dB)	Limit Line (dBμV/m)	Read Level (dBμV)	Antenna Factor (dB/m)	Cable Loss (dB)	Preamp Factor (dB)	Ant Pos (cm)	Table Pos (deg)	Peak Avg. (P/A)	Pol. (H/V)	
802.11n HT20 CH 11 2462MHz		4924	37.79	-36.21	74	59.57	31.88	11	64.66	100	0	P	H	
		7386	41.44	-32.56	74	56.04	37.38	12.88	64.86	100	0	P	H	
													H	
													H	
			4924	39.71	-34.29	74	61.49	31.88	11	64.66	100	0	P	V
			7386	40.84	-33.16	74	55.44	37.38	12.88	64.86	100	0	P	V
														V
													V	
Remark	1. No other spurious found. 2. All results are PASS against Peak and Average limit line.													



2.4GHz 2400~2483.5MHz

Emission below 1GHz

2.4GHz WIFI 802.11b (LF)

WIFI Ant.	Note	Frequency	Level	Over Limit	Limit Line	Read Level	Antenna Factor	Cable Loss	Preamp Factor	Ant Pos	Table Pos	Peak Avg.	Pol.	
1		(MHz)	(dBμV/m)	(dB)	(dBμV/m)	(dBμV)	(dB/m)	(dB)	(dB)	(cm)	(deg)	(P/A)	(H/V)	
2.4GHz 802.11b LF		31.62	25.77	-14.23	40	32.31	24.66	1.29	32.49	-	-	P	H	
		204.15	29.01	-14.49	43.5	43.69	16.09	2.1	32.87	-	-	P	H	
		209.82	31.62	-11.88	43.5	46.18	16.18	2.1	32.84	152	321	P	H	
		490.4	24.87	-21.13	46	30.02	23.95	3.28	32.38	-	-	P	H	
		723.5	29.4	-16.6	46	30.61	27.17	4.02	32.4	-	-	P	H	
		955.2	33.85	-12.15	46	29.72	30.59	4.69	31.15			P	H	
														H
														H
														H
														H
														H
														H
			37.02	30.9	-9.1	40	40.12	21.98	1.29	32.49	200	82	P	V
			54.03	21.03	-18.97	40	38.53	13.7	1.29	32.49	-	-	P	V
			210.36	25.21	-18.29	43.5	39.75	16.2	2.1	32.84	-	-	P	V
			426	23.36	-22.64	46	29.72	22.87	3.11	32.34	-	-	P	V
			689.2	30.15	-15.85	46	32.09	26.59	3.94	32.47	-	-	P	V
			927.9	33.62	-12.38	46	30.39	30	4.63	31.4	-	-	P	V
														V
														V
													V	
													V	
													V	
													V	
Remark	1. No other spurious found. 2. All results are PASS against limit line.													



Note symbol

*	Fundamental Frequency which can be ignored. However, the level of any unwanted emissions shall not exceed the level of the fundamental frequency.
!	Test result is over limit line.
P/A	Peak or Average
H/V	Horizontal or Vertical



A calculation example for radiated spurious emission is shown as below:

WIFI	Note	Frequency	Level	Over	Limit	Read	Antenna	Cable	Preamp	Ant	Table	Peak	Pol.
Ant.				Limit	Line	Level	Factor	Loss	Factor	Pos	Pos	Avg.	
1		(MHz)	(dBμV/m)	(dB)	(dBμV/m)	(dBμV)	(dB/m)	(dB)	(dB)	(cm)	(deg)	(P/A)	(H/V)
802.11b		2390	55.45	-18.55	74	54.51	32.22	4.58	35.86	103	308	P	H
CH 01													
2412MHz		2390	43.54	-10.46	54	42.6	32.22	4.58	35.86	103	308	A	H

- 1. Level(dBμV/m) =
Antenna Factor(dB/m) + Cable Loss(dB) + Read Level(dBμV) - Preamp Factor(dB)
- 2. Over Limit(dB) = Level(dBμV/m) – Limit Line(dBμV/m)

For Peak Limit @ 2390MHz:

- 1. Level(dBμV/m)
= Antenna Factor(dB/m) + Cable Loss(dB) + Read Level(dBμV) - Preamp Factor(dB)
= 32.22(dB/m) + 4.58(dB) + 54.51(dBμV) – 35.86 (dB)
= 55.45 (dBμV/m)
- 2. Over Limit(dB)
= Level(dBμV/m) – Limit Line(dBμV/m)
= 55.45(dBμV/m) – 74(dBμV/m)
= -18.55(dB)

For Average Limit @ 2390MHz:

- 1. Level(dBμV/m)
= Antenna Factor(dB/m) + Cable Loss(dB) + Read Level(dBμV) - Preamp Factor(dB)
= 32.22(dB/m) + 4.58(dB) + 42.6(dBμV) – 35.86 (dB)
= 43.54 (dBμV/m)
- 2. Over Limit(dB)
= Level(dBμV/m) – Limit Line(dBμV/m)
= 43.54(dBμV/m) – 54(dBμV/m)
= -10.46(dB)

Both peak and average measured complies with the limit line, so test result is “PASS”.



Appendix C. Radiated Spurious Emission Plots

Test Engineer :	JC Liao, Jacky Hung, and Ken Wu	Temperature :	20~24°C
		Relative Humidity :	50~54%



2.4GHz 2400~2483.5MHz

WIFI 802.11b (Band Edge @ 3m)

WIFI	2.4GHz 2400~2483.5MHz Band Edge @ 3m	
ANT	802.11b CH11 2462MHz	
1	Horizontal	Fundamental
Peak	<p>Site : 03CH11-HY Condition : PEAK_BE_74 3m HORN 9120D-HF HORIZONTAL</p>	<p>Site : 03CH11-HY Condition : PEAK_74 3m HORN 9120D-HF HORIZONTAL</p>
Avg.	<p>Site : 03CH11-HY Condition : AV6_BE_54 3m HORN 9120D-HF HORIZONTAL</p>	<p>Site : 03CH11-HY Condition : AV6_54 3m HORN 9120D-HF HORIZONTAL</p>



WIFI	2.4GHz 2400~2483.5MHz Band Edge @ 3m	
ANT	802.11b CH11 2462MHz	
1	Vertical	Fundamental
Peak	<p>Site : 03CH11-HY Condition : PEAK_BE_74 3m HORN 9120D-HF VERTICAL</p>	<p>Site : 03CH11-HY Condition : PEAK_74 3m HORN 9120D-HF VERTICAL</p>
Avg.	<p>Site : 03CH11-HY Condition : AVG_BE_54 3m HORN 9120D-HF VERTICAL</p>	<p>Site : 03CH11-HY Condition : AVG_54 3m HORN 9120D-HF VERTICAL</p>



2.4GHz 2400~2483.5MHz

WIFI 802.11n HT20 (Band Edge @ 3m)

WIFI	2.4GHz 2400~2483.5MHz Band Edge @ 3m	
ANT	802.11n HT20 CH11 2462MHz	
1	Horizontal	Fundamental
Peak	<p>Site : 03CH11-HY Condition : PEAK_BE_74 3m HORN 9120D-HF HORIZONTAL</p>	<p>Site : 03CH11-HY Condition : PEAK_74 3m HORN 9120D-HF HORIZONTAL</p>
Avg.	<p>Site : 03CH11-HY Condition : AV6_BE_54 3m HORN 9120D-HF HORIZONTAL</p>	<p>Site : 03CH11-HY Condition : AV6_54 3m HORN 9120D-HF HORIZONTAL</p>



WIFI	2.4GHz 2400~2483.5MHz Fundamental @ 3m	
ANT	802.11n HT20 CH11 2462MHz	
1	Vertical	Fundamental
Peak	<p>Site : 03CH11-HY Condition : PEAK_BE_74 3m HORN 9120D-HF VERTICAL</p>	<p>Site : 03CH11-HY Condition : PEAK_74 3m HORN 9120D-HF VERTICAL</p>
	<p>Site : 03CH11-HY Condition : AVG_BE_54 3m HORN 9120D-HF VERTICAL</p>	<p>Site : 03CH11-HY Condition : AVG_54 3m HORN 9120D-HF VERTICAL</p>



2.4GHz 2400~2483.5MHz

WIFI 802.11b (Harmonic @ 3m)

WIFI	2.4GHz 2400~2483.5MHz Harmonic @ 3m	
ANT	802.11b CH11 2462MHz	
1	Horizontal	Vertical
Peak Avg.	<p>Site : 03CH11-HY Condition : PEAK_74 3m 9170 SHF HORM_150809 HORIZONTAL</p>	<p>Site : 03CH11-HY Condition : PEAK_74 3m 9170 SHF HORM_150809 VERTICAL</p>
	<p>Site : 03CH11-HY Condition : PEAK_74 3m 9170 SHF HORM_150809 HORIZONTAL</p>	<p>Site : 03CH11-HY Condition : PEAK_74 3m 9170 SHF HORM_150809 VERTICAL</p>



2.4GHz 2400~2483.5MHz

WIFI 802.11n HT20 (Harmonic @ 3m)

WIFI	2.4GHz 2400~2483.5MHz Harmonic @ 3m	
ANT	802.11n HT20 CH11 2462MHz	
1	Horizontal	Vertical
Peak Avg.	<p>Site : 03CH11-HY Condition : PEAK_74 3m 9170 SHF HORN_150809 HORIZONTAL</p>	<p>Site : 03CH11-HY Condition : PEAK_74 3m 9170 SHF HORN_150809 VERTICAL</p>

Emission below 1GHz

2.4GHz WIFI 802.11b (LF)

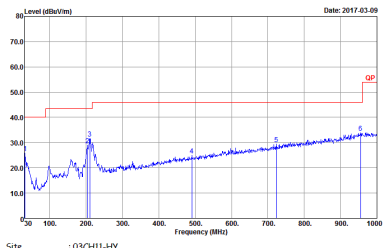
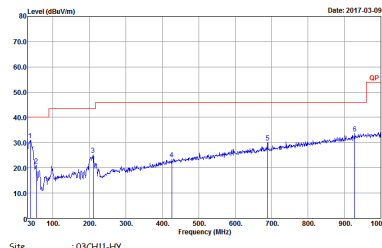
WIFI	2.4GHz 2400~2483.5MHz	
ANT	802.11b LF	
1	Horizontal	Vertical
<p>QP / Peak</p>	 <p>Site : 03CH11-HY Condition : QP 3m BE-LOG 6111D-LF_ETC HORIZONTAL</p>	 <p>Site : 03CH11-HY Condition : QP 3m BE-LOG 6111D-LF_ETC VERTICAL</p>



Emission below 1GHz

2.4GHz WIFI 802.11n HT20 (LF)

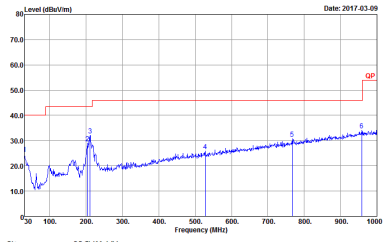
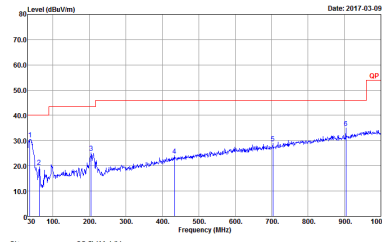
WIFI	2.4GHz 2400~2483.5MHz	
ANT	802.11n HT20 LF	
1	Horizontal	Vertical
QP / Peak	 <p>Site : 03CH11-HY Condition : QP 3m BE-LOG 6111D-LF_ETC HORIZONTAL</p>	 <p>Site : 03CH11-HY Condition : QP 3m BE-LOG 6111D-LF_ETC VERTICAL</p>



Appendix D. Duty Cycle Plots

Band	Duty Cycle(%)	T(us)	1/T(kHz)	VBW Setting
802.11b	97.63	8240	0.12	300Hz
2.4GHz 802.11n HT20	85.811	1270	0.79	1kHz



802.11b

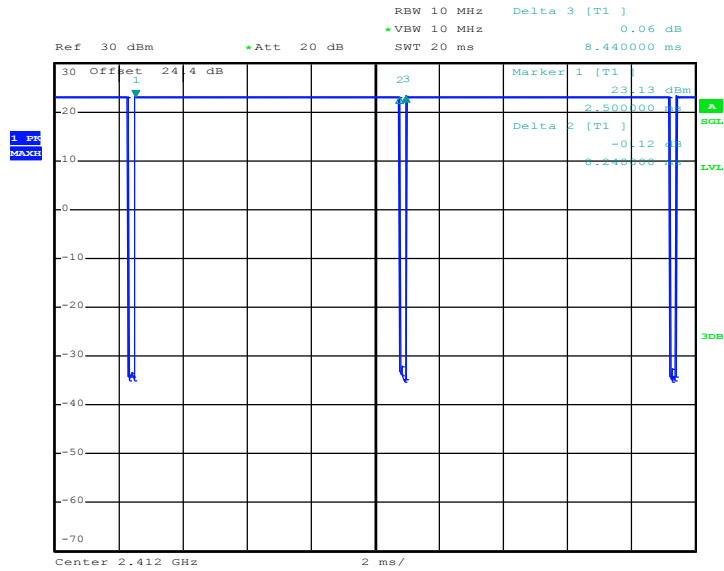

Date: 17.FEB.2017 19:58:22

802.11n HT20

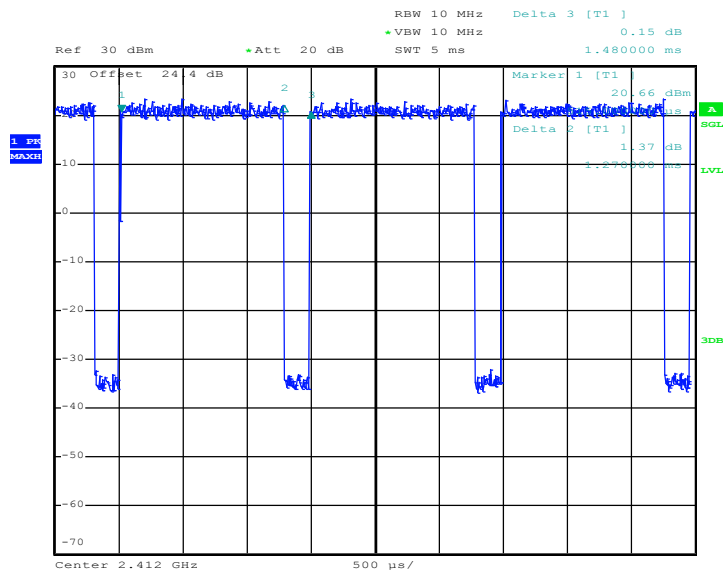

Date: 17.FEB.2017 20:00:11



Appendix E. Original Report

Please refer to Sporton report number FR720310C.