



FCC RF Test Report

APPLICANT : Motorola Mobility, LLC
EQUIPMENT : Mobile Cellular Phone
BRAND NAME : Motorola
MODEL NAME : 4237
FCC ID : IHDT56VB1
STANDARD : FCC Part 15 Subpart C §15.225
CLASSIFICATION : (DXX) Low Power Communication Device Transmitter

The testing was completed on May 11, 2016. We, SPORTON INTERNATIONAL INC., would like to declare that the tested sample has been evaluated in accordance with the test procedures and has been in compliance with the applicable technical standards.

The test results in this report apply exclusively to the tested model / sample. Without written approval of SPORTON INTERNATIONAL INC., the test report shall not be reproduced except in full.

Reviewed by: Joseph Lin / Supervisor

Approved by: Jones Tsai / Manager



SPORTON INTERNATIONAL INC.

No. 52, Hwa Ya 1st Rd., Hwa Ya Technology Park, Kwei-Shan District, Tao Yuan City, Taiwan, R.O.C.



Table of Contents

SUMMARY OF THE TEST RESULT4

1. GENERAL INFORMATION.....5

1.1 Applicant.....5

1.2 Manufacturer.....5

1.3 Feature of Equipment Under Test5

1.4 Product Details6

1.5 Modification of EUT.....6

1.6 Testing Location.....7

1.7 Applicable Standards7

1.8 Test Modes8

1.9 Test Configurations.....9

1.10 Table for Supporting Units10

2. CONDUCTED EMISSION TEST.....11

2.1 Measuring Instruments.....11

2.2 Test setup.....11

2.3 Test Result of Conducted Emission Test.....11

2.4 AC Power Line Conducted Emissions Measurement12

3. CONDUCTED TEST ITEMS13

3.1 Measuring Instruments.....13

3.2 Test Setup13

3.3 Test Result of Conducted Test Items13

3.4 20dB and 99% OBW Spectrum Bandwidth Measurement14

3.5 Frequency Stability Measurement14

4. RADIATED TEST ITEMS.....15

4.1 Measuring Instruments.....15

4.2 Test Setup15

4.3 Test Result of Radiated Test Items15

4.4 Field Strength of Fundamental Emissions and Mask Measurement16

4.5 Radiated Emissions Measurement.....17

5. LIST OF MEASURING EQUIPMENT19

APPENDIX A. TEST RESULTS OF CONDUCTED EMISSION TEST

APPENDIX B. TEST RESULTS OF CONDUCTED TEST ITEMS

B.1.Test Result of 20dB Spectrum Bandwidth

B.2 Test Result of Frequency Stability

APPENDIX C. TEST RESULTS OF RADIATED TEST ITEMS

C.1 Test Result of Field Strength of Fundamental Emissions

C.2 Results of Radiated Emissions (9 kHz~30MHz)

C.3 Results of Radiated Emissions (30MHz~1GHz)



SUMMARY OF THE TEST RESULT

Applied Standard: 47 CFR FCC Part 15 Subpart C				
Part	FCC Rule	Description of Test	Result	Under Limit
3.1	15.207	AC Power Line Conducted Emissions	Complies	5.60 dB at 13.558MHz
3.2	15.225(a)(b)(c)	Field Strength of Fundamental Emissions	Complies	56.48 dB at 13.560 MHz
3.3	2.1049	20dB Spectrum Bandwidth	Complies	-
3.3	-	99% OBW Spectrum Bandwidth	Complies	-
3.4	15.225(d) 15.209	Radiated Emissions	Complies	4.32 dB at 44.580 MHz for Quasi-Peak
3.5	15.225(e)	Frequency Stability	Complies	-
3.6	15.203	Antenna Requirements	Complies	-

Test Items	Uncertainty	Remark
AC Power Line Conducted Emissions	±2.26dB	Confidence levels of 95%
Radiated Emissions (30MHz~1000MHz)	±4.80dB	Confidence levels of 95%



1. GENERAL INFORMATION

1.1 Applicant

Motorola Mobility, LLC

222 W Merchandise Mart Plaza, Suite 1800, Chicago, IL 60654, United States

1.2 Manufacturer

Motorola Mobility, LLC

222 W Merchandise Mart Plaza, Suite 1800, Chicago, IL 60654, United States

1.3 Feature of Equipment Under Test

Product Feature	
Equipment	Mobile Cellular Phone
Brand Name	Motorola
FCC Model Name	4237
FCC ID	IHDT56VB1
IMEI Code	354107070048744 354107070048637
EUT supports Radios application	CDMA/EV-DO/GSM/EGPRS/WCDMA/HSPA/LTE/NFC 2.4GHz WLAN 11b/g/n HT20 WLAN 11ac VHT20 5GHz WLAN 11a/n HT20/HT40 WLAN 11ac VHT20/VHT40/VHT80 Bluetooth v3.0 EDR Bluetooth v4.2 - LE
HW Version	DVT2
EUT Stage	Identical Prototype

Accessory List	
AC Adapter	Brand Name : Motorola
	Model Name : SPN5913A



1.4 Product Details

Items	Description
Tx/Rx Frequency Range	13.553 ~ 13.567MHz
Channel Number	1
20dBW	2.64KHz
99%OBW	2.24KHz
Antenna Type	Fixed Internal Antenna
Type of Modulation	ASK

Remark: The above EUT's information was declared by manufacturer. Please refer to the specifications or user's manual for more detailed description.

1.5 Modification of EUT

No modifications are made to the EUT during all test items.



1.6 Testing Location

Sporton Lab is accredited to ISO 17025 by Taiwan Accreditation Foundation (TAF code : 1190) and the FCC designation No. TW1022 under the FCC 2.948(e) by Mutual Recognition Agreement (MRA) in FCC Test.

Test Site	SPORTON INTERNATIONAL INC.	
Test Site Location	No. 52, Hwa Ya 1 st Rd., Hwa Ya Technology Park, Kwei-Shan District, Tao Yuan City, Taiwan, R.O.C. TEL: +886-3-3273456 / FAX: +886-3-3284978	
Test Site No.	Sporton Site No.	
	TH03-HY	CO05-HY
Test Engineer	Tommy Lee	Eric Jeng
Temperature	22~24°C	21~23°C
Relative Humidity	53~55%	52~55%

Note: The test site complies with ANSI C63.4 2014 requirement.

Test Site	SPORTON INTERNATIONAL INC.	
Test Site Location	No. 52, Hwa Ya 1 st Rd., Hwa Ya Technology Park, Kwei-Shan District, Tao Yuan City, Taiwan, R.O.C. TEL: +886-3-3273456 / FAX: +886-3-3284978	
Test Site No.	Sporton Site No.	
	03CH11-HY	
Test Engineer	J.C. Liang and Bill Chang	
Temperature	21~23°C	
Relative Humidity	55~58%	

Note: The test site complies with ANSI C63.4 2014 requirement.

1.7 Applicable Standards

According to the specifications of the manufacturer, the EUT must comply with the requirements of the following standards:

- FCC Part 15 Subpart C §15.225
- ANSI C63.10-2013



1.8 Test Modes

Investigation has been done on all the possible configurations for searching the worst cases. The following table is a list of the test modes shown in this test report.

Test Items	
AC Power Line Conducted Emissions	Field Strength of Fundamental Emissions
20dB Spectrum Bandwidth	Frequency Stability
Radiated Emissions 9kHz~30MHz	Radiated Emissions 30MHz~1GHz
Note: 1. The EUT was programmed to be in continuously transmitting mode. 2. The ancillary equipment, NFC card, is used to make the EUT (NFC) continuously transmit at 13.56MHz and is placed around 3 cm gap to the EUT.	

1.9 Test Configurations

<AC Conducted Emissions>

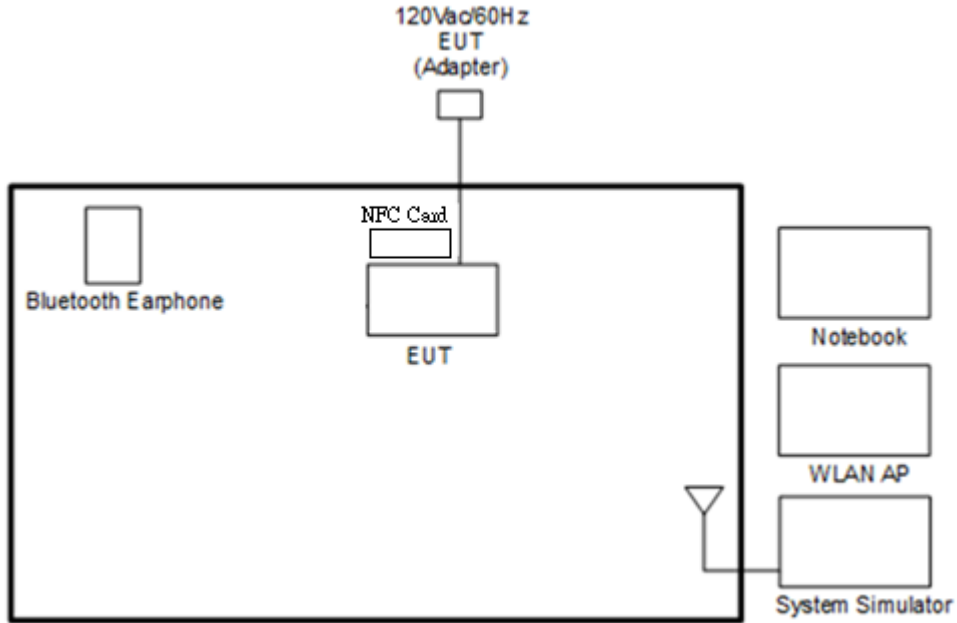

< For Fundamental Emissions and Mask and Radiated Emissions Measurement >

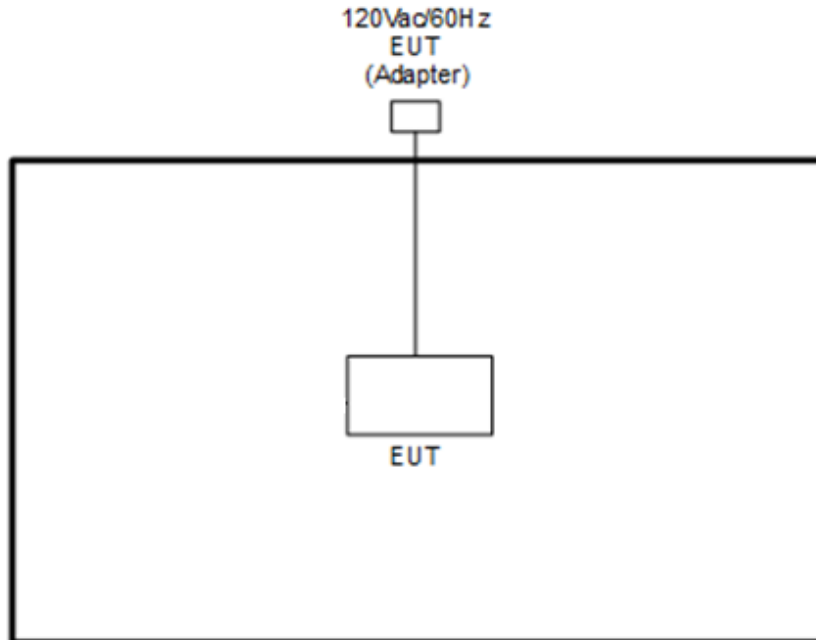



1.10 Table for Supporting Units

Support Unit	Manufacturer	Model	FCC ID
System Simulator	Anritsu	MT8820C	N/A
WLAN AP	D-Link	DIR-865L	KA2IR865LA1
Bluetooth Earphone	Sony Ericsson	MW600	PY70DA2029
Notebook	DELL	Latitude E6320	FCC DoC/ Contains FCC ID: QDS-BRCM1054
SD Card	SanDisk	MicroSD HC	FCC DoC
NFC Card	Metro Taipei	Easy Card	N/A



2.4 AC Power Line Conducted Emissions Measurement

2.4.1 Limit

For equipment that is designed to be connected to the public utility (AC) power line, the radio frequency voltage that is conducted back onto the AC power line on any frequency or frequencies within the band 150 kHz to 30 MHz shall not exceed the limits in the following table.

Frequency of Emission (MHz)	Conducted Limit (dB μ V)	
	Quasi-Peak	Average
0.15-0.5	66 to 56*	56 to 46*
0.5-5	56	46
5-30	60	50

*Decreases with the logarithm of the frequency.

2.4.2 Test Procedures

1. The EUT was placed 0.4 meter from the conducting wall of the shielding room, and it was kept at least 80 centimeters from any other grounded conducting surface.
2. Connect EUT to the power mains through a line impedance stabilization network (LISN).
3. All the support units are connecting to the other LISN.
4. The LISN provides 50 ohm coupling impedance for the measuring instrument.
5. The FCC states that a 50 ohm, 50 microhenry LISN should be used.
6. Both sides of AC line were checked for maximum conducted interference.
7. The frequency range from 150 kHz to 30 MHz was searched.
8. Set the test-receiver system to Peak Detect Function and specified bandwidth (IF Bandwidth = 9kHz) with Maximum Hold Mode. Then measurement is also conducted by Average Detector and Quasi-Peak Detector Function respectively.

3. CONDUCTED TEST ITEMS

3.1 Measuring Instruments

See list of measuring instruments of this test report.

3.2 Test Setup

3.2.1 20dB and 99% OBW Spectrum Bandwidth

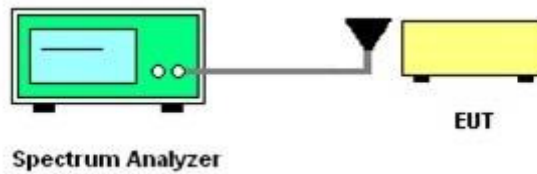

3.2.2 Frequency Stability

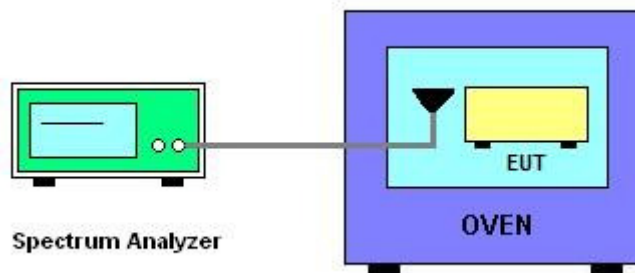

3.3 Test Result of Conducted Test Items

Please refer to Appendix C.



3.4 20dB and 99% OBW Spectrum Bandwidth Measurement

3.4.1 Limit

Intentional radiators must be designed to ensure that the 20dB and 99% emission bandwidth in the specific band 13.553~13.567MHz.

3.4.2 Test Procedures

1. The spectrum analyzer connected via a receive antenna placed near the EUT in peak Max hold mode.
2. The resolution bandwidth of 1 kHz and the video bandwidth of 3 kHz were used.
3. Measured the spectrum width with power higher than 20dB below carrier.
4. Measured the 99% OBW.

3.5 Frequency Stability Measurement

3.5.1 Limit

The frequency tolerance of the carrier signal shall be maintained within +/- 0.01% (100ppm) of the operating frequency over a temperature variation of -20 degrees to +50 degrees C at normal supply voltage, and for a variation in the primary supply voltage from 85% to 115% of the rated supply voltage at a temperature of 20 degrees C. For battery operated equipment, the equipment tests shall be performed using a new battery.

3.5.2 Test Procedures

1. The spectrum analyzer connected via a receive antenna placed near the EUT.
2. EUT have transmitted signal and fixed channelize.
3. Set the spectrum analyzer span to view the entire emissions bandwidth.
4. Set RBW = 1 kHz, VBW = 3 kHz with peak detector and maxhold settings.
5. The f_c is declaring of channel frequency. Then the frequency error formula is $(f_c - f) / f_c \times 10^6$ ppm and the limit is less than ± 100 ppm.
6. Extreme temperature rule is -20°C~50°C.

4. RADIATED TEST ITEMS

4.1 Measuring Instruments

See list of measuring instruments of this test report.

4.2 Test Setup

4.2.1 For radiated emissions below 30MHz

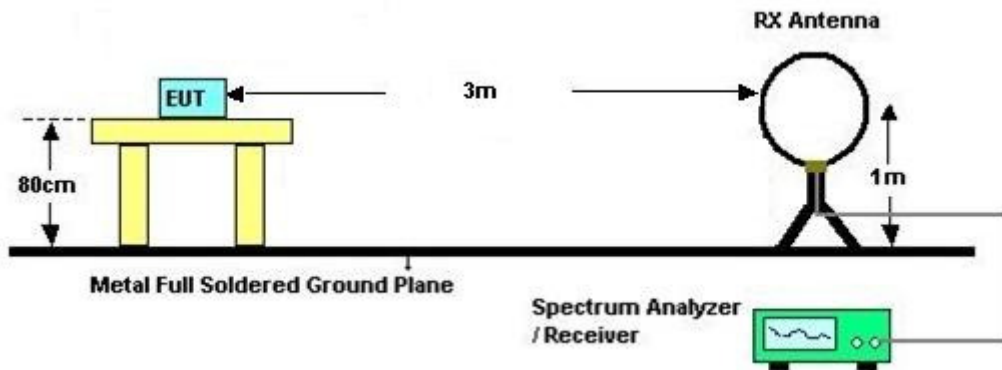

4.2.2 For radiated emissions above 30MHz

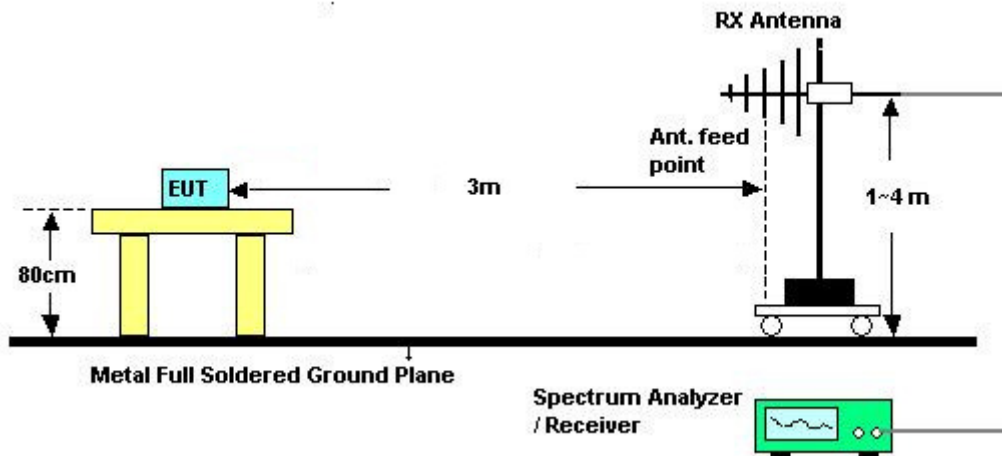

4.3 Test Result of Radiated Test Items

Please refer to Appendix D.



4.4 Field Strength of Fundamental Emissions and Mask Measurement

4.4.1 Limit

Rules and specifications	FCC CFR 47 Part 15 section 15.225 IC RSS-210 A2.6			
	Description			
Description	Compliance with the spectrum mask is tested with RBW set to 9kHz.			
Freq. of Emission (MHz)	Field Strength (µV/m) at 30m	Field Strength (dBµV/m) at 30m	Field Strength (dBµV/m) at 10m	Field Strength (dBµV/m) at 3m
1.705~13.110	30	29.5	48.58	69.5
13.110~13.410	106	40.5	59.58	80.5
13.410~13.553	334	50.5	69.58	90.5
13.553~13.567	15848	84.0	103.08	124.0
13.567~13.710	334	50.5	69.58	90.5
13.710~14.010	106	40.5	59.58	80.5
14.010~30.000	30	29.5	48.58	69.5

4.4.2 Test Procedures

1. Configure the EUT according to ANSI C63.10. The EUT was placed on the top of the turntable 0.8 meter above ground. The phase center of the loop receiving antenna mounted antenna tower was placed 3 meters far away from the turntable.
2. Power on the EUT and all the supporting units. The turntable was rotated by 360 degrees to determine the position of the highest radiation.
3. The height of the receiving antenna was fixed at one meter above ground to find the maximum emissions field strength.
4. For Fundamental emissions, use the receiver to measure QP reading.
5. When the radiated emissions limits are expressed in terms of the average value of the emissions, and pulsed operation is employed, the measurement field strength shall be determined by averaging over one complete pulse train, including blanking intervals, as long as the pulse train does not exceed 0.1 seconds. As an alternative (provided the transmitter operates for longer than 0.1 seconds) or in cases where the pulse train exceeds 0.1 seconds, the measured field strength shall be determined from the average absolute voltage during a 0.1 second interval during which the field strength is at its maximum value.
6. Compliance with the spectrum mask is tested with RBW set to 9kHz.

Note: Emission level (dBµV/m) = 20 log Emission level (µV/m).



4.5 Radiated Emissions Measurement

4.5.1 Limit

The field strength of any emissions which appear outside of 13.110 ~14.010MHz band shall not exceed the general radiated emissions limits.

Frequencies (MHz)	Field Strength (µV/m)	Measurement Distance (meters)
0.009~0.490	2400/F(kHz)	300
0.490~1.705	24000/F(kHz)	30
1.705~30.0	30	30
30~88	100	3
88~216	150	3
216~960	200	3
Above 960	500	3

4.5.2 Measuring Instrument Setting

The following table is the setting of receiver.

Receiver Parameter	Setting
Attenuation	Auto
Frequency Range: 9kHz~150kHz	RBW 200Hz for QP
Frequency Range: 150kHz~30MHz	RBW 9kHz for QP
Frequency Range: 30MHz~1000MHz	RBW 120kHz for Peak

Note: The emission limits shown in the above table are based on measurements employing a CISPR quasi-peak detector except for the frequency bands 9-90 kHz, 110-490 kHz. Radiated emission limits in these two bands are based on measurements employing an average detector.



4.5.3 Test Procedures

1. Configure the EUT according to ANSI C63.10. The EUT was placed on the top of the turntable 0.8 meter above ground. The phase center of the receiving antenna mounted on the top of a height-variable antenna tower was placed 3 meters far away from the turntable.
1. Power on the EUT and all the supporting units. The turntable was rotated by 360 degrees to determine the position of the highest radiation.
2. The height of the broadband receiving antenna was varied between one meter and four meters above ground to find the maximum emissions field strength of both horizontal and vertical polarization.
3. For each suspected emissions, the antenna tower was scan (from 1 M to 4 M) and then the turntable was rotated (from 0 degree to 360 degrees) to find the maximum reading.
4. Set the test-receiver system to Peak or CISPR quasi-peak Detect Function with specified bandwidth under Maximum Hold Mode.
5. When the radiated emissions limits are expressed in terms of the average value of the emissions, and pulsed operation is employed, the measurement field strength shall be determined by averaging over one complete pulse train, including blanking intervals, as long as the pulse train does not exceed 0.1 seconds. As an alternative (provided the transmitter operates for longer than 0.1 seconds) or in cases where the pulse train exceeds 0.1 seconds, the measured field strength shall be determined from the average absolute voltage during a 0.1 second interval during which the field strength is at its maximum value.
6. In case the emission is lower than 30MHz, loop antenna has to be used for measurement and the recorded data should be QP measured by receiver. Antenna Requirements

4.5.4 Limit

Except for special regulations, the Low-power Radio-frequency Devices must not be equipped with any jacket for installing an antenna with extension cable. An intentional radiator shall be designed to ensure that no antenna other than that furnished by the responsible party shall be used with the device. The use of a permanently attached antenna or of an antenna that uses a unique coupling to the intentional radiator shall be considered sufficient to comply with the provisions of this Section. The manufacturer may design the unit so that the user can replace a broken antenna, but the use of a standard antenna jack or electrical connector is prohibited.

4.5.5 Antenna Anti-Replacement Construction

An embedded-in antenna design is used.



5. LIST OF MEASURING EQUIPMENT

Instrument	Manufacturer	Model No.	Serial No.	Characteristics	Calibration Date	Test Date	Due Date	Remark
AC Power Source	AC POWER	AFC-500W	F104070011	50Hz~60Hz	Dec. 02, 2015	May 10, 2016	Dec. 01, 2016	Conducted (TH03-HY)
Spectrum Analyzer	Rohde & Schwarz	FSP30	101329	9kHz~30GHz	Jun. 24, 2015	May 10, 2016	Jun. 23, 2016	Conducted (TH03-HY)
Temperature Chamber	ESPEC	SU-641	92013721	-30°C ~70°C	Nov. 20, 2015	May 10, 2016	Nov. 19, 2016	Conducted (TH03-HY)
AC Power Source	ChainTek	APC-1000W	N/A	N/A	N/A	May 11, 2016	N/A	Conduction (CO05-HY)
EMI Test Receiver	Rohde & Schwarz	ESCI 7	100724	9kHz~7GHz	Aug. 26, 2015	May 11, 2016	Aug. 25, 2016	Conduction (CO05-HY)
LISN	Rohde & Schwarz	ENV216	100080	9kHz~30MHz	Dec. 02, 2015	May 11, 2016	Dec. 01, 2016	Conduction (CO05-HY)
EMI Test Receiver	Keysight	N9038A(MXE)	MY54130085	20Hz ~ 8.4GHz	Nov. 04, 2015	May 10, 2016	Nov. 03, 2016	Radiation (03CH11-HY)
Loop Antenna	Rohde & Schwarz	HFH2-Z2	100315	9 kHz~30 MHz	Sep. 02, 2015	May 10, 2016	Sep. 01, 2016	Radiation (03CH11-HY)
Amplifier	SONOMA	310N	187312	9kHz~1GHz	Nov. 20, 2015	May 10, 2016	Nov. 19, 2016	Radiation (03CH11-HY)
Bilog Antenna	TESEQ	CBL 6111D	35414	30MHz~1GHz	Nov. 17, 2015	May 10, 2016	Nov. 16, 2016	Radiation (03CH11-HY)
Spectrum Analyzer	Keysight	N9010A	MY54200486	10Hz ~ 44GHZ	Sep. 24, 2015	May 10, 2016	Sep. 23, 2016	Radiation (03CH11-HY)
Antenna Mast	EMEC	AM-BS-4500-B	N/A	1~4m	N/A	May 10, 2016	N/A	Radiation (03CH11-HY)
Turn Table	EMEC	TT 2000	N/A	0~360 Degree	N/A	May 10, 2016	N/A	Radiation (03CH11-HY)

Appendix A. Test Results of Conducted Emission Test

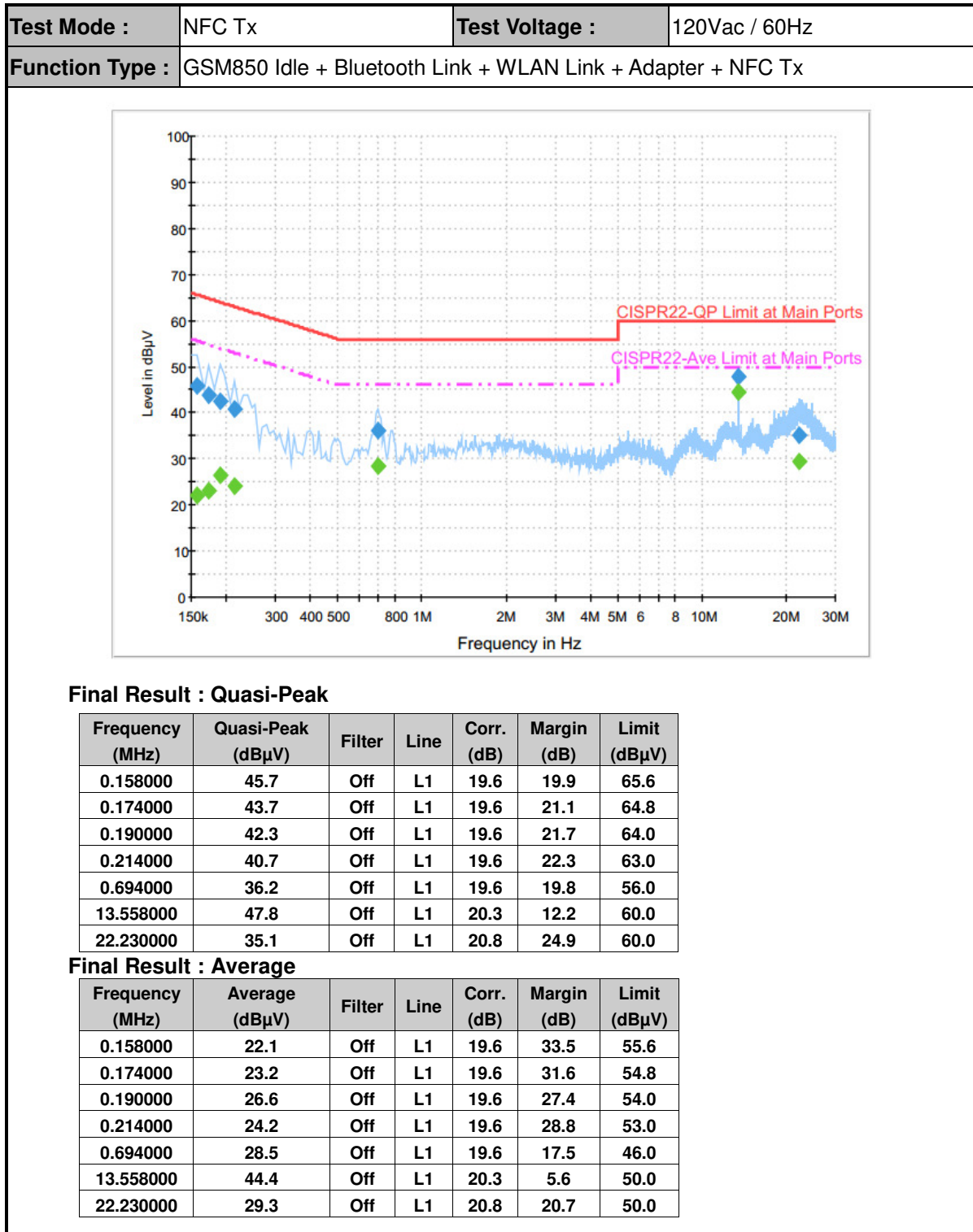



Test Mode :	NFC Tx	Test Voltage :	120Vac / 60Hz
Function Type :	GSM850 Idle + Bluetooth Link + WLAN Link + Adapter + NFC Tx		

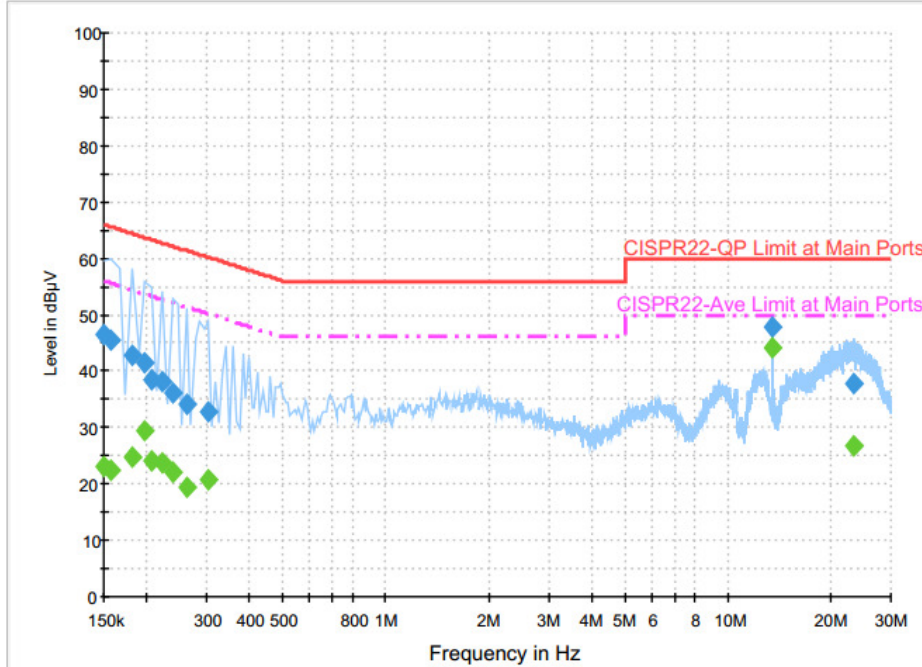

Final Result : Quasi-Peak

Frequency (MHz)	Quasi-Peak (dBµV)	Filter	Line	Corr. (dB)	Margin (dB)	Limit (dBµV)
0.150000	46.4	Off	N	19.6	19.6	66.0
0.158000	45.6	Off	N	19.6	20.0	65.6
0.182000	42.9	Off	N	19.6	21.5	64.4
0.198000	41.5	Off	N	19.6	22.2	63.7
0.206000	38.5	Off	N	19.6	24.9	63.4
0.222000	38.2	Off	N	19.6	24.5	62.7
0.238000	36.3	Off	N	19.6	25.9	62.2
0.262000	34.1	Off	N	19.6	27.3	61.4
0.302000	32.6	Off	N	19.6	27.6	60.2
13.558000	47.8	Off	N	20.3	12.2	60.0
23.286000	37.8	Off	N	20.9	22.2	60.0

Test Mode :	NFC Tx	Test Voltage :	120Vac / 60Hz
Function Type :	GSM850 Idle + Bluetooth Link + WLAN Link + Adapter + NFC Tx		

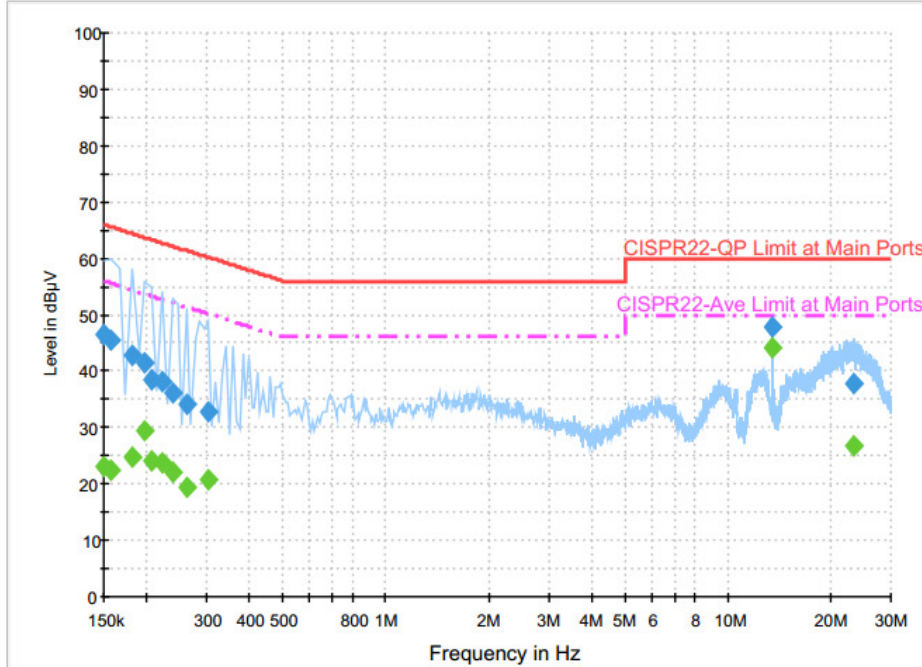

Final Result : Average

Frequency (MHz)	Average (dBµV)	Filter	Line	Corr. (dB)	Margin (dB)	Limit (dBµV)
0.150000	23.1	Off	N	19.6	32.9	56.0
0.158000	22.5	Off	N	19.6	33.1	55.6
0.182000	24.8	Off	N	19.6	29.6	54.4
0.198000	29.5	Off	N	19.6	24.2	53.7
0.206000	24.1	Off	N	19.6	29.3	53.4
0.222000	23.6	Off	N	19.6	29.1	52.7
0.238000	22.0	Off	N	19.6	30.2	52.2
0.262000	19.3	Off	N	19.6	32.1	51.4
0.302000	20.6	Off	N	19.6	29.6	50.2
13.558000	44.2	Off	N	20.3	5.8	50.0
23.286000	26.8	Off	N	20.9	23.2	50.0

(1) with antenna

Remark: 13.558MHz is the NFC RF fundamental signal.

(2) with dummy load

Remark: Only the fundamental NFC signal needs to be retested per C63.4.



Appendix B. Test Results of Conducted Test Items

B.1 Test Result of 20dB Spectrum Bandwidth

Test mode	NFC Tx	Test Frequency (MHz)	13.56
Date: 10.MAY.2016 15:25:39		Date: 10.MAY.2016 15:35:14	
20dB Bandwidth (kHz)	2.64	99% OccupiedBW(kHz)	2.24
Frequency range (MHz)	$f_L > 13.553$	13.55926	Test Result
	$f_H < 13.567$	13.56190	Complies



B.2 Test Result of Frequency Stability

Voltage vs. Frequency Stability		Temperature vs. Frequency Stability		
Voltage (Vac)	Measurement Frequency (MHz)	Temperature (°C)	Time	Measurement Frequency (MHz)
120	13.560560	-20	0	13.560640
102	13.560560		2	13.560620
138	13.560560		5	13.560620
			10	13.560620
		-10	0	13.560650
			2	13.560630
			5	13.560600
			10	13.560600
		0	0	13.560620
			2	13.560610
			5	13.560600
			10	13.560580
		10	0	13.560600
			2	13.560580
			5	13.560580
			10	13.560580
		20	0	13.560600
			2	13.560580
			5	13.560580
			10	13.560580
		30	0	13.560560
			2	13.560580
			5	13.560560
			10	13.560560
		40	0	13.560560
			2	13.560560
			5	13.560560
			10	13.560550



Voltage vs. Frequency Stability		Temperature vs. Frequency Stability		
Voltage (Vac)	Measurement Frequency (MHz)	Temperature (°C)	Time	Measurement Frequency (MHz)
		50	0	13.560540
			2	13.560540
			5	13.560540
			10	13.560540
Max.Deviation (MHz)	0.000560	Max.Deviation (MHz)		0.000650
Max.Deviation (ppm)	41.2979	Max.Deviation (ppm)		47.9351
Limit	FS < ±100 ppm	Limit		FS < ±100 ppm
Test Result	PASS	Test Result		PASS



Appendix C. Test Results of Radiated Test Items

C.1 Test Result of Field Strength of Fundamental Emissions

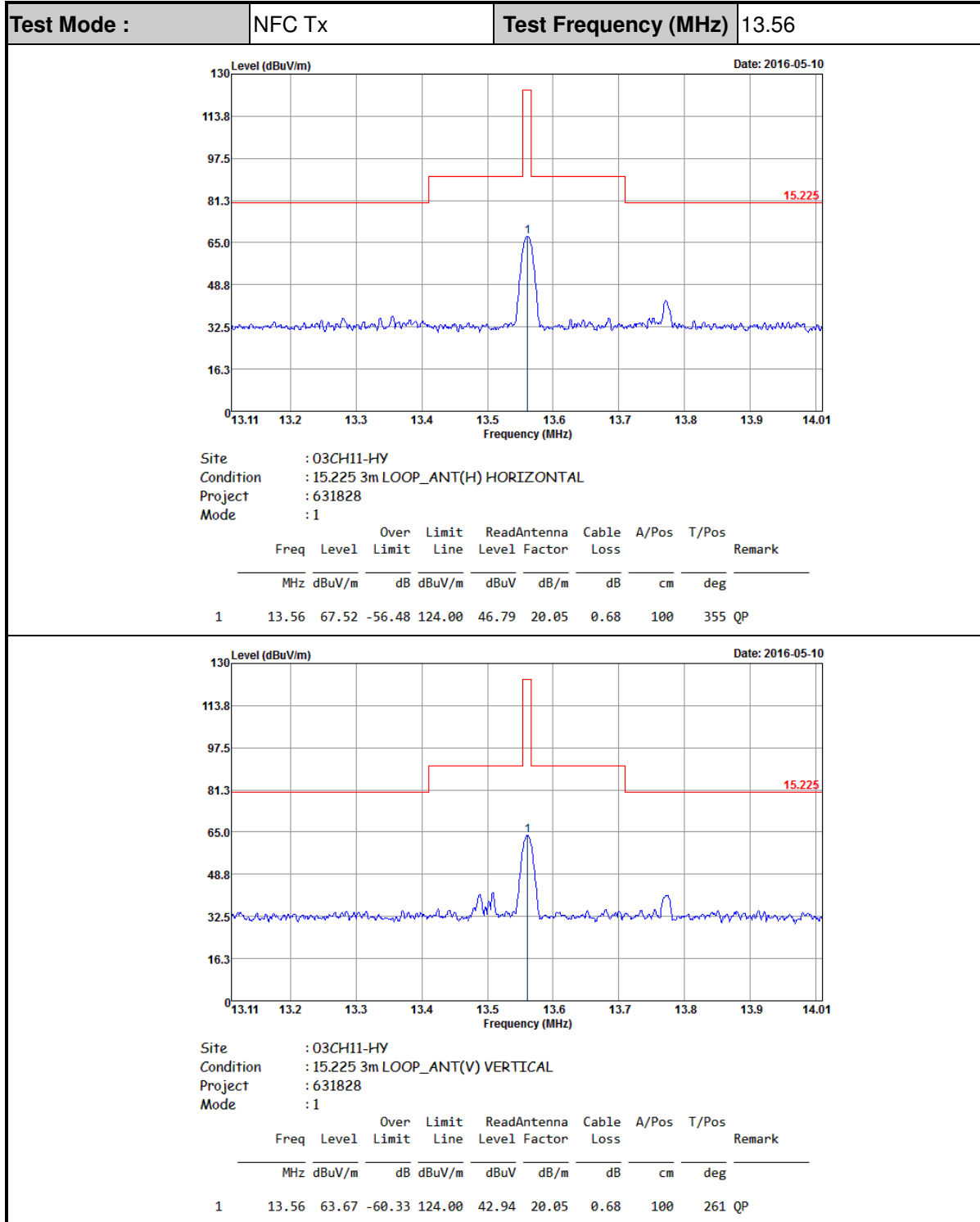

Note: All NFC's spurious emissions are below 20dB of limits.



C.2 Results of Radiated Emissions (9 kHz~30MHz)

Test Mode :	NFC Tx	Polarization :	Horizontal
--------------------	--------	-----------------------	------------

Frequency (MHz)	Level (dBμV/m)	Over Limit (dB)	Limit Line (dBμV/m)	Read Level (dBμV)	Antenna Factor (dB)	Cable Loss (dB)	Ant Pos (cm)	Table Pos (deg)	Remark
0.04791	42.05	-71.95	114	21.28	20.09	0.68	-	-	Average
0.06477	58.79	-52.59	111.38	38.07	20.04	0.68	-	-	Average
0.09788	45.65	-62.14	107.79	24.98	19.99	0.68	-	-	QP
0.12952	51.85	-53.51	105.36	31.2	19.97	0.68	-	-	Average
0.19828	50.34	-51.32	101.66	29.73	19.93	0.68	-	-	Average
0.88052	42.03	-26.68	68.71	21.44	19.91	0.68	100	45	QP
12.632	36.48	-33.02	69.5	15.74	20.06	0.68	-	-	QP
13.56	67.48	-2.02	69.5	46.75	20.05	0.68	-	-	QP
22.372	37.93	-31.57	69.5	16.31	20.55	1.07	-	-	QP
28.105	37.49	-32.01	69.5	15.82	20.6	1.07	-	-	QP

Test Mode :	NFC Tx	Polarization :	Vertical
--------------------	--------	-----------------------	----------

Frequency (MHz)	Level (dBμV/m)	Over Limit (dB)	Limit Line (dBμV/m)	Read Level (dBμV)	Antenna Factor (dB)	Cable Loss (dB)	Ant Pos (cm)	Table Pos (deg)	Remark
0.0521	40.83	-72.44	113.27	20.06	20.09	0.68	-	-	Average
0.06702	48.4	-62.68	111.08	27.68	20.04	0.68	-	-	Average
0.09378	38.95	-69.21	108.16	18.28	19.99	0.68	-	-	QP
0.11192	40.62	-66.01	106.63	19.95	19.99	0.68	-	-	Average
0.15374	47.97	-55.9	103.87	27.34	19.95	0.68	-	-	Average
1.406	38.38	-26.26	64.64	17.78	19.92	0.68	100	174	QP
11.48	36.8	-32.7	69.5	16.07	20.05	0.68	-	-	QP
13.56	63.59	-5.91	69.5	42.86	20.05	0.68	-	-	QP
21.751	37.74	-31.76	69.5	16.13	20.54	1.07	-	-	QP
28.455	38.83	-30.67	69.5	17.2	20.56	1.07	-	-	QP

Note:

- 13.56 MHz is fundamental signal which can be ignored.
- The amplitude of spurious emissions which are attenuated by more than 20dB below the permissible value has no need to be reported.
- Distance extrapolation factor = 40 log (specific distance / test distance) (dB);
- Limit line = specific limits (dBμV) + distance extrapolation factor.



C.3 Results of Radiated Emissions (30MHz~1GHz)

Test Mode :	NFC Tx	Polarization :	Horizontal
-------------	--------	----------------	------------

Frequency (MHz)	Level (dBμV/m)	Over Limit (dB)	Limit Line (dBμV/m)	Read Level (dBμV)	Antenna Factor (dB)	Cable Loss (dB)	Preamp Factor (dB)	Ant Pos (cm)	Table Pos (deg)	Remark
80.49	23.22	-16.78	40	40.14	13.7	1.17	31.79	-	-	Peak
138	37.32	-6.18	43.5	49.7	17.92	1.48	31.78	120	25	Peak
216.03	31.43	-14.57	46	45.27	16.2	1.74	31.78	-	-	Peak
300	29.33	-16.67	46	39.26	19.7	2.13	31.76	-	-	Peak
433	35.62	-10.38	46	40.78	22.99	3.68	31.83	-	-	Peak
941.9	34.45	-11.55	46	31.28	30.38	3.89	31.1	-	-	Peak

Test Mode :	NFC Tx	Polarization :	Vertical
-------------	--------	----------------	----------

Frequency (MHz)	Level (dBμV/m)	Over Limit (dB)	Limit Line (dBμV/m)	Read Level (dBμV)	Antenna Factor (dB)	Cable Loss (dB)	Preamp Factor (dB)	Ant Pos (cm)	Table Pos (deg)	Remark
44.58	35.68	-4.32	40	49.06	17.5	0.93	31.81	100	35	Peak
138.54	31.94	-11.56	43.5	44.33	17.91	1.48	31.78	-	-	Peak
216.3	32.73	-13.27	46	46.57	16.2	1.74	31.78	-	-	Peak
300	25.92	-20.08	46	35.85	19.7	2.13	31.76	-	-	Peak
601	32.94	-13.06	46	36.11	25.71	3.16	32.04	-	-	Peak
938.4	33.12	-12.88	46	30.12	30.27	3.86	31.13	-	-	Peak

Note:

1. The amplitude of spurious emissions which are attenuated by more than 20dB below the permissible value has no need to be reported.
2. Emission level (dBμV/m) = 20 log Emission level (μV/m).
3. Corrected Reading: Antenna Factor + Cable Loss + Read Level - Preamp Factor= Level.