



FCC RF Test Report

APPLICANT : Motorola Mobility, LLC
EQUIPMENT : Mobile Cellular Phone
BRAND NAME : Motorola
MODEL NAME : 4023
FCC ID : IHDT56QB1
STANDARD : FCC Part 15 Subpart C §15.247
CLASSIFICATION : (DTS) Digital Transmission System

The product was received on Apr. 23, 2014 and testing was completed on Jun. 20, 2014. We, SPORTON INTERNATIONAL INC., would like to declare that the tested sample has been evaluated in accordance with the test procedures and has been in compliance with the applicable technical standards.

The test results in this report apply exclusively to the tested model / sample. Without written approval of SPORTON INTERNATIONAL INC., the test report shall not be reproduced except in full.

Reviewed by: Joseph Lin / Supervisor

Approved by: Jones Tsai / Manager



SPORTON INTERNATIONAL INC.

No. 52, Hwa Ya 1st Rd., Hwa Ya Technology Park, Kwei-Shan Hsiang, Tao Yuan Hsien, Taiwan, R.O.C.



TABLE OF CONTENTS

REVISION HISTORY.....3

SUMMARY OF TEST RESULT4

1 GENERAL DESCRIPTION.....5

1.1 Applicant5

1.2 Manufacturer.....5

1.3 Product Feature of Equipment Under Test.....5

1.4 Product Specification subjective to this standard6

1.5 Modification of EUT6

1.6 Testing Location6

1.7 Applicable Standards.....7

2 TEST CONFIGURATION OF EQUIPMENT UNDER TEST.....8

2.1 Descriptions of Test Mode8

2.2 Test Mode.....9

2.3 Connection Diagram of Test System.....10

2.4 Support Unit used in test configuration and system11

2.5 EUT Operation Test Setup11

2.6 Measurement Results Explanation Example.....11

3 TEST RESULT12

3.1 6dB Bandwidth Measurement12

3.2 Peak Output Power Measurement15

3.3 Power Spectral Density Measurement17

3.4 Conducted Band Edges and Spurious Emission Measurement23

3.5 Radiated Band Edges and Spurious Emission Measurement32

3.6 AC Conducted Emission Measurement.....41

3.7 Antenna Requirements.....45

4 LIST OF MEASURING EQUIPMENT.....46

5 UNCERTAINTY OF EVALUATION.....47



SUMMARY OF TEST RESULT

Report Section	FCC Rule	Description	Limit	Result	Remark
3.1	15.247(a)(2)	6dB Bandwidth	$\geq 0.5\text{MHz}$	Pass	-
3.2	15.247(b)(1)	Peak Output Power	$\leq 30\text{dBm}$	Pass	-
3.3	15.247(e)	Power Spectral Density	$\leq 8\text{dBm}$	Pass	-
3.4	15.247(d)	Conducted Band Edges and Spurious Emission	$\leq 20\text{dBc}$	Pass	-
3.5	15.247(d)	Radiated Band Edges and Spurious Emission	15.209(a) & 15.247(d)	Pass	Under limit 2.55 dB at 2483.500 MHz
3.6	15.207	AC Conducted Emission	15.207(a)	Pass	Under limit 19.80 dB at 4.342 MHz
3.7	15.203 & 15.247(b)	Antenna Requirement	N/A	Pass	-



1 General Description

1.1 Applicant

Motorola Mobility, LLC
222 W. Merchandise Mart Plaza, Chicago IL. 60654

1.2 Manufacturer

Motorola Mobility, LLC
222 W. Merchandise Mart Plaza, Chicago IL. 60654

1.3 Product Feature of Equipment Under Test

Product Feature	
Equipment	Mobile Cellular Phone
Brand Name	Motorola
Model Name	4023
FCC ID	IHDT56QB1
IMEI Code	359286050063637
EUT supports Radios application	GSM/EGPRS/WCDMA/HSPA WLAN 11b/g/n HT20 Bluetooth v3.0 EDR Bluetooth v4.0 - LE
HW Version	P2
SW Version	KXB21.32.18
EUT Stage	Identical Prototype

Remark: The above EUT's information was declared by manufacturer. Please refer to the specifications or user's manual for more detailed description.

Accessory List	
AC Adapter	Brand Name : MOTOROLA
	Model Name : MOT-C-0003ADUUS
Earphone	Brand Name : MOTOROLA
	Model Name : SJYN1181B
Battery	Brand Name: MOTOROLA
	Model Name : ED30

1.4 Product Specification subjective to this standard

Product Specification subjective to this standard	
Tx/Rx Frequency Range	2402 MHz ~ 2480 MHz
Number of Channels	40
Carrier Frequency of Each Channel	40 Channel(37 hopping + 3 advertising channel)
Maximum Output Power to Antenna	1.80 dBm (0.0015 W)
Antenna Type	PIFA Antenna type with gain 1.80 dBi
Type of Modulation	Bluetooth LE : GFSK

1.5 Modification of EUT

No modifications are made to the EUT during all test items.

1.6 Testing Location

Sporton Lab is accredited to ISO 17025 by Taiwan Accreditation Foundation (TAF code : 1190) and the FCC designation No. TW1022 under the FCC 2.948(e) by Mutual Recognition Agreement (MRA) in FCC Test.

Test Site	SPORTON INTERNATIONAL INC.		
Test Site Location	No. 52, Hwa Ya 1 st Rd., Hwa Ya Technology Park, Kwei-Shan Hsiang, Tao Yuan Hsien, Taiwan, R.O.C. TEL: +886-3-327-3456 FAX: +886-3-328-4978		
Test Site No.	Sporton Site No.		
	TH02-HY	CO05-HY	03CH06-HY



1.7 Applicable Standards

According to the specifications of the manufacturer, the EUT must comply with the requirements of the following standards:

- ♦ FCC Part 15 Subpart C §15.247
- ♦ FCC KDB Publication No. 558074 D01 DTS Meas. Guidance v03r02
- ♦ ANSI C63.4-2003

Remark:

1. All test items were verified and recorded according to the standards and without any deviation during the test.
2. This EUT has also been tested and complied with the requirements of FCC Part 15, Subpart B, recorded in a separate test report..

2 Test Configuration of Equipment Under Test

2.1 Descriptions of Test Mode

The RF output power was recorded in the following table:

Channel	Frequency	Bluetooth 4.0 – LE RF Output Power	
		Data Rate / Modulation	
		GFSK	
		1Mbps	
Ch00	2402MHz	1.54 dBm	
Ch19	2440MHz	1.80 dBm	
Ch39	2480MHz	1.25 dBm	

Channel	Frequency	Bluetooth 4.0 – Average Power	
		Data Rate / Modulation	
		GFSK	
		1Mbps	
Ch00	2402MHz	0.93 dBm	
Ch19	2440MHz	1.18 dBm	
Ch39	2480MHz	0.59 dBm	

- a. The EUT has been associated with peripherals and configuration operated in a manner tended to maximize its emission characteristics in a typical application. Frequency range investigated: conduction (150 kHz to 30 MHz), radiation (9 kHz to the 10th harmonic of the highest fundamental frequency or to 40 GHz, whichever is lower). Pre-scanned tests, X, Y, Z in three orthogonal panels to determine the final configuration (Y plane as worst plane) from all possible combinations.
- b. AC power line Conducted Emission was tested under maximum output power.



2.2 Test Mode

The following summary table is showing all test modes to demonstrate in compliance with the standard.

Summary table of Test Cases	
Test Item	Data Rate / Modulation
	Bluetooth 4.0 – LE / GFSK
Conducted TCs	Mode 1: Bluetooth Tx CH00_2402 MHz_1Mbps
	Mode 2: Bluetooth Tx CH19_2440 MHz_1Mbps
	Mode 3: Bluetooth Tx CH39_2480 MHz_1Mbps
Radiated TCs	Mode 1: Bluetooth Tx CH00_2402 MHz_1Mbps
	Mode 2: Bluetooth Tx CH19_2440 MHz_1Mbps
	Mode 3: Bluetooth Tx CH39_2480 MHz_1Mbps
AC Conducted Emission	Mode 1: GSM850 Idle + Bluetooth Link + WLAN Link + Adapter + Earphone + MP3

2.3 Connection Diagram of Test System

<Bluetooth 4.0 – LE Tx Mode>

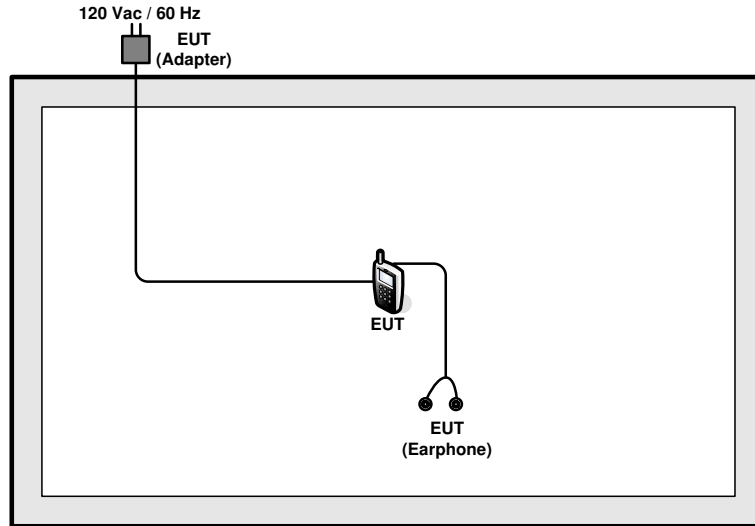

<AC Conducted Emission Mode>

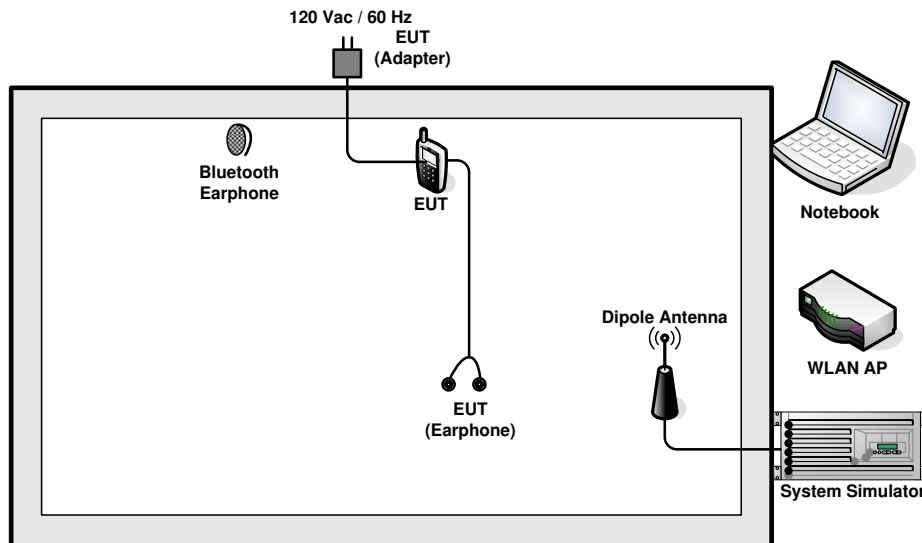

2.4 Support Unit used in test configuration and system

Item	Equipment	Trade Name	Model Name	FCC ID	Data Cable	Power Cord
1.	System Simulator	R&S	CMU 200	N/A	N/A	Unshielded, 1.8 m
2.	Bluetooth Earphone	Sony Ericsson	MW600	PY7DDA-2029	N/A	N/A
3.	WLAN AP	D-Link	DIR-628	KA2DIR628A2	N/A	Unshielded, 1.8 m
4.	Notebook	DELL	Latitude E6320	FCC DoC/ Contains FCC ID: QDS-BRCM1054	N/A	AC I/P: Unshielded, 1.2 m DC O/P: Shielded, 1.8 m
5.	SD Card	SanDisk	MicroSD HC	FCC DoC	N/A	N/A

2.5 EUT Operation Test Setup

For Bluetooth function, programmed RF utility, “ADB” installed in the notebook make the EUT provide functions like channel selection and power level for continuous transmitting and receiving signals.

2.6 Measurement Results Explanation Example

For all conducted test items:

The offset level is set in the spectrum analyzer to compensate the RF cable loss and attenuator factor between EUT conducted output port and spectrum analyzer. With the offset compensation, the spectrum analyzer reading level is exactly the EUT RF output level.

Example :

The spectrum analyzer offset is derived from RF cable loss and attenuator factor.

Offset = RF cable loss + attenuator factor.

Following shows an offset computation example with cable loss 4.2 dB and 10dB attenuator.

$$\begin{aligned}
 \text{Offset(dB)} &= \text{RF cable loss(dB)} + \text{attenuator factor(dB)}. \\
 &= 4.2 + 10 = 14.2 \text{ (dB)}
 \end{aligned}$$

3 Test Result

3.1 6dB Bandwidth Measurement

3.1.1 Limit of 6dB Bandwidth

The minimum 6 dB bandwidth shall be at least 500 kHz.

3.1.2 Measuring Instruments

The section 4.0 of List of Measuring Equipment of this test report is used for test.

3.1.3 Test Procedures

1. The testing follows FCC KDB Publication No. 558074 D01 DTS Meas. Guidance v03r02.
2. The RF output of EUT was connected to the spectrum analyzer by RF cable and attenuator. The path loss was compensated to the results for each measurement.
3. Set to the maximum power setting and enable the EUT transmit continuously.
4. Make the measurement with the spectrum analyzer's resolution bandwidth (RBW) = 100 kHz. Set the Video bandwidth (VBW) = 300 kHz. In order to make an accurate measurement. The 6 dB bandwidth must be greater than 500 kHz.
5. Measure and record the results in the test report.

3.1.4 Test Setup

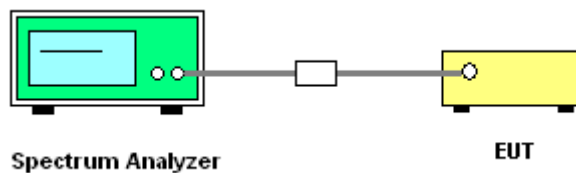



3.1.5 Test Result of 6dB Bandwidth

Test Mode :	Bluetooth 4.0 - LE	Temperature :	22~25°C
Test Engineer :	Bill Kuo	Relative Humidity :	51~55%

Channel	Frequency (MHz)	6dB Bandwidth (MHz)	6dB Bandwidth Min. Limit (MHz)	Pass/Fail
00	2402	0.66	0.5	Pass
19	2440	0.66	0.5	Pass
39	2480	0.66	0.5	Pass

6 dB Bandwidth Plot on Channel 00

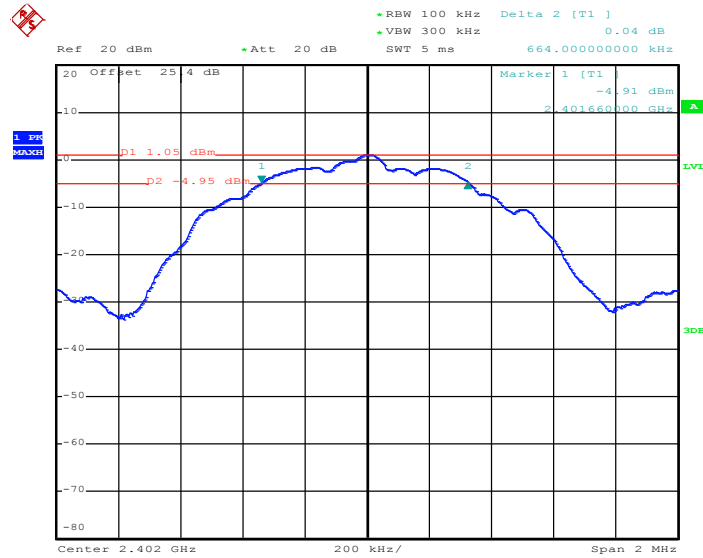

Date: 11.MAY.2014 16:28:56



6 dB Bandwidth Plot on Channel 19

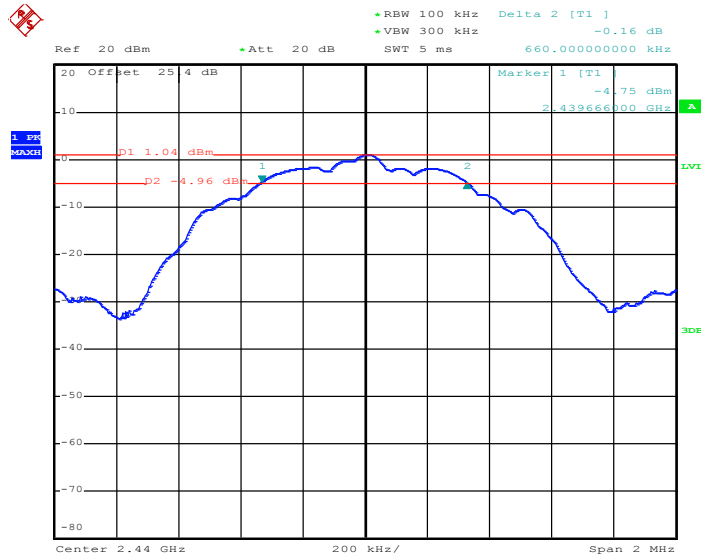

Date: 11.MAY.2014 16:31:50

6 dB Bandwidth Plot on Channel 39

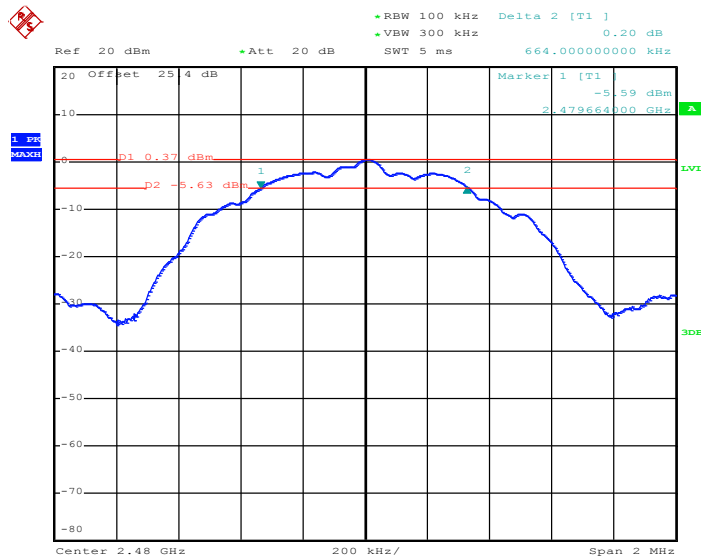

Date: 11.MAY.2014 16:34:22

3.2 Peak Output Power Measurement

3.2.1 Limit of Peak Output Power

For systems using digital modulation in the 2400-2483.5MHz, the limit for peak output power is 30dBm. If transmitting antenna of directional gain greater than 6dBi is used, the peak output power from the intentional radiator shall be reduced below the above stated value by the amount in dB that the directional gain of the antenna exceeds 6 dBi. In case of point-to-point operation, the limit has to be reduced by 1dB for every 3dB that the directional gain of the antenna exceeds 6dBi.

3.2.2 Measuring Instruments

The section 4.0 of List of Measuring Equipment of this test report is used for test.

3.2.3 Test Procedures

1. The testing follows the Measurement Procedure of FCC KDB No. 558074 DTS D01 Meas. Guidance v03r02.
2. The RF output of EUT was connected to the power meter by RF cable and attenuator. The path loss was compensated to the results for each measurement.
3. Set to the maximum power setting and enable the EUT transmit continuously.
4. Measure the conducted output power and record the results in the test report.

3.2.4 Test Setup

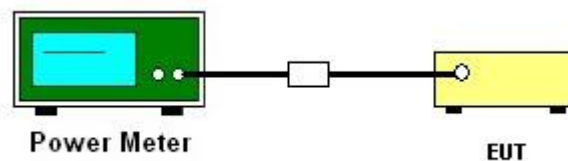



3.2.5 Test Result of Peak Output Power

Test Mode :	Bluetooth 4.0 - LE	Temperature :	22~25°C
Test Engineer :	Bill Kuo	Relative Humidity :	51~55%

Channel	Frequency (MHz)	RF Power (dBm)		
		GFSK	Max. Limits (dBm)	Pass/Fail
		1 Mbps		
00	2402	1.54	30.00	Pass
19	2440	1.80	30.00	Pass
39	2480	1.25	30.00	Pass

3.3 Power Spectral Density Measurement

3.3.1 Limit of Power Spectral Density

The peak power spectral density shall not be greater than 8dBm in any 3kHz band at any time interval of continuous transmission.

3.3.2 Measuring Instruments

The section 4.0 of List of Measuring Equipment of this test report is used for test.

3.3.3 Test Procedures

1. The testing follows Measurement Procedure 10.2 Method PKPSD of FCC KDB Publication No. 558074 D01 DTS Meas. Guidance v03r02
2. The RF output of EUT was connected to the spectrum analyzer by RF cable and attenuator. The path loss was compensated to the results for each measurement.
3. Set to the maximum power setting and enable the EUT transmit continuously.
4. Make the measurement with the spectrum analyzer's resolution bandwidth (RBW) = 3 kHz. Video bandwidth VBW = 10 kHz In order to make an accurate measurement, set the span to 1.5 times DTS Channel Bandwidth. (6dB BW)
5. Detector = peak, Sweep time = auto couple, Trace mode = max hold, Allow trace to fully stabilize. Use the peak marker function to determine the maximum power level.
6. Measure and record the results in the test report.
7. The Measured power density (dBm)/ 100kHz is a reference level and used as 20dBc down limit line for Conducted Band Edges and Conducted Spurious Emission.

3.3.4 Test Setup

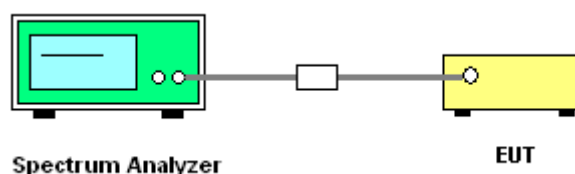



3.3.5 Test Result of Power Spectral Density

Test Mode :	Bluetooth 4.0 - LE	Temperature :	22~25°C
Test Engineer :	Bill Kuo	Relative Humidity :	51~55%

Channel	Frequency (MHz)	Power Density		Max. Limits (dBm/3kHz)	Pass/Fail
		PSD/100kHz (dBm)	PSD/3kHz (dBm)		
00	2402	1.07	-0.25	8	Pass
19	2440	1.04	-0.26	8	Pass
39	2480	0.37	-0.92	8	Pass

Note:

1. Measured power density (dBm) has offset with cable loss.
2. The Measured power density (dBm)/ 100kHz is reference level and used as 20dBc down for Conducted Band Edges and Conducted Spurious Emission limit line.



3.3.6 Test Result of Power Spectral Density Plots (100kHz)

PSD 100kHz Plot on Channel 00

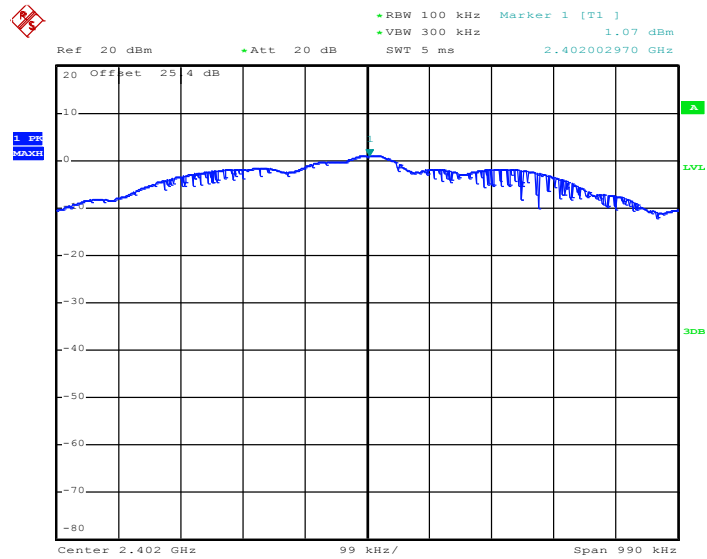

Date: 11.MAY.2014 16:29:24



PSD 100kHz Plot on Channel 19

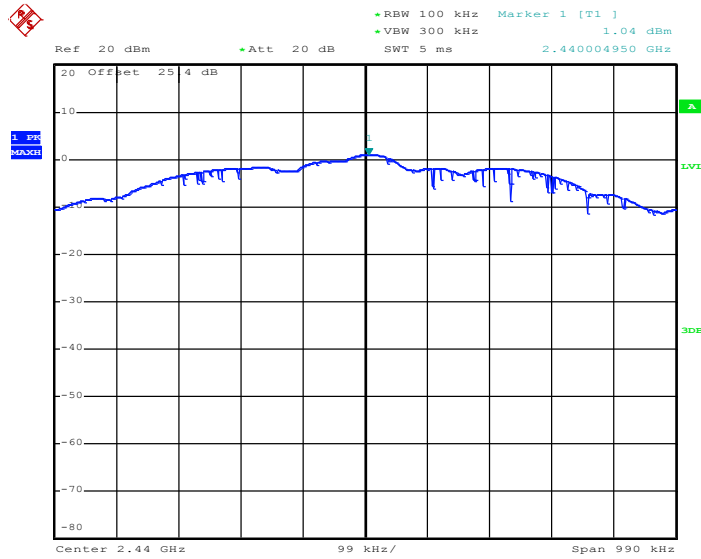

Date: 11.MAY.2014 16:32:18

PSD 100kHz Plot on Channel 39

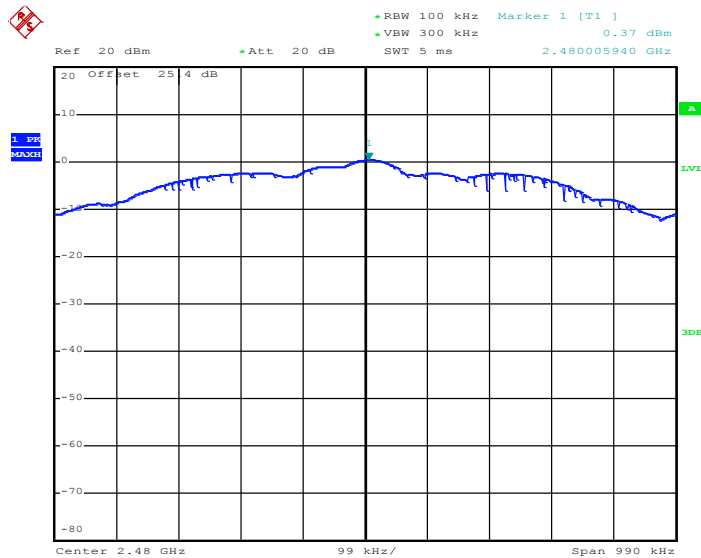

Date: 11.MAY.2014 16:34:55



3.3.7 Test Result of Power Spectral Density Plots (3kHz)

PSD 3kHz Plot on Channel 00

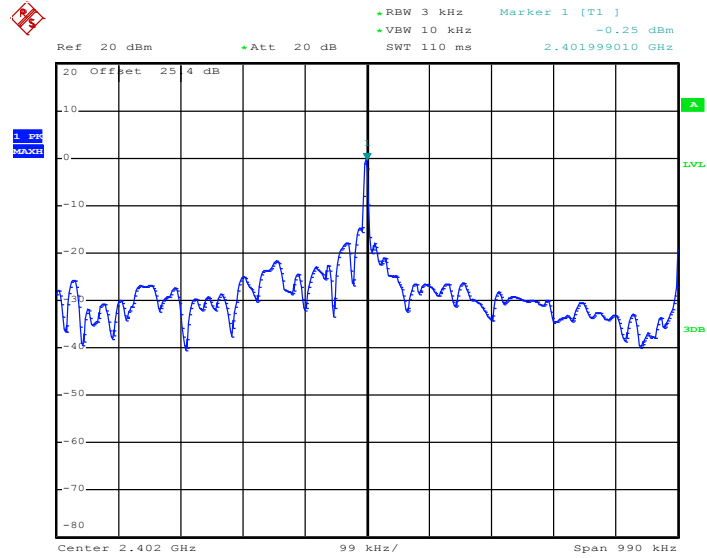

Date: 11.MAY.2014 16:29:16



PSD 3kHz Plot on Channel 19

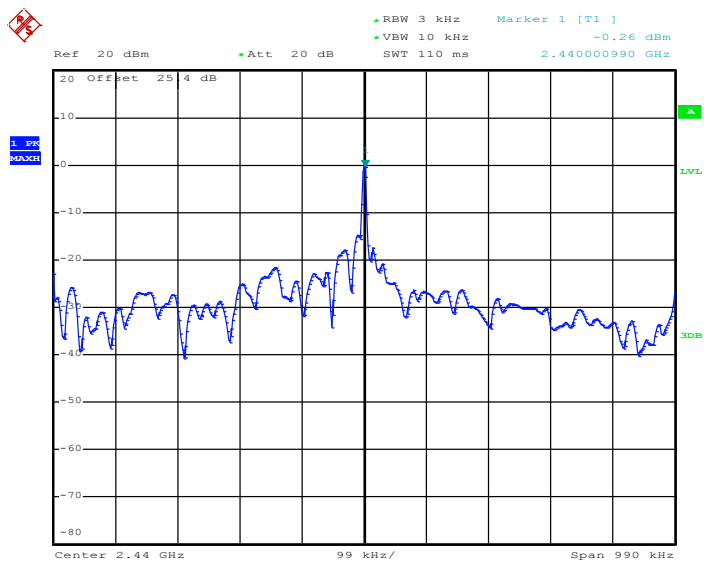

Date: 11.MAY.2014 16:32:09

PSD 3kHz Plot on Channel 39

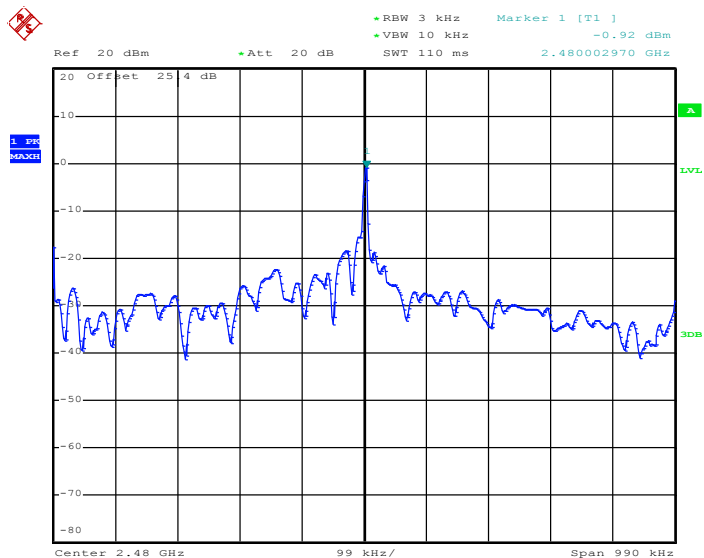

Date: 11.MAY.2014 16:36:30

3.4 Conducted Band Edges and Spurious Emission Measurement

3.4.1 Limit of Conducted Band Edges and Spurious Emission

All harmonics/spurious must be at least 20 dB down from the highest emission level within the authorized band.

3.4.2 Measuring Instruments

The section 4.0 of List of Measuring Equipment of this test report is used for test.

3.4.3 Test Procedure

1. The testing follows FCC KDB Publication No. 558074 D01 DTS Meas. Guidance v03r02.
2. The RF output of EUT was connected to the spectrum analyzer by RF cable and attenuator. The path loss was compensated to the results for each measurement.
3. Set to the maximum power setting and enable the EUT transmit continuously.
4. Set RBW = 100 kHz, VBW=300 kHz, Peak Detector. Unwanted Emissions measured in any 100 kHz bandwidth outside of the authorized frequency band shall be attenuated by at least 20 dB relative to the maximum in-band peak PSD level in 100 kHz when maximum peak conducted output power procedure is used. If the transmitter complies with the conducted power limits based on the use of RMS averaging over a time interval, the attenuation required under this paragraph shall be 30 dB instead of 20 dB per 15.247(d).
5. Measure and record the results in the test report.
6. The RF fundamental frequency should be excluded against the limit line in the operating frequency band.

3.4.4 Test Setup

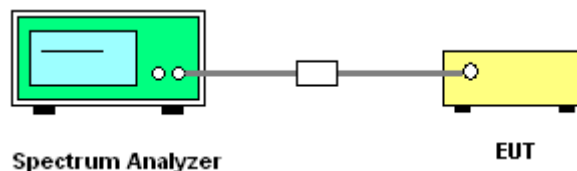



3.4.5 Test Result of Conducted Band Edges

Test Mode :	Bluetooth 4.0 - LE	Temperature :	22~25°C
Test Channel :	00 and 39	Relative Humidity :	51~55%
		Test Engineer :	Bill Kuo

Low Band Edge Plot on Channel 00

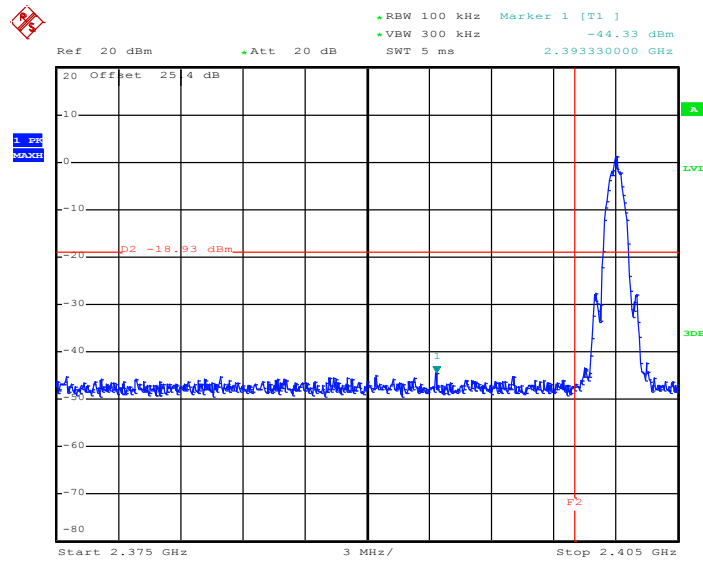

Date: 11.MAY.2014 16:29:38



High Band Edge Plot on Channel 39

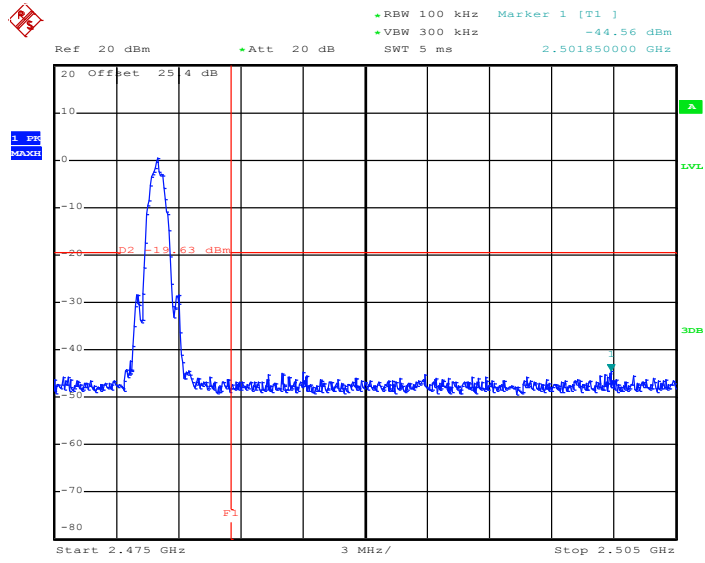

Date: 11.MAY.2014 16:35:08



3.4.6 Test Result of Conducted Spurious Emission

Test Mode :	Bluetooth 4.0 - LE	Temperature :	22~25°C
Test Channel :	00	Relative Humidity :	51~55%
		Test Engineer :	Bill Kuo

Conducted Spurious Emission Plot on Bluetooth LE 1Mbps GFSK Channel 00

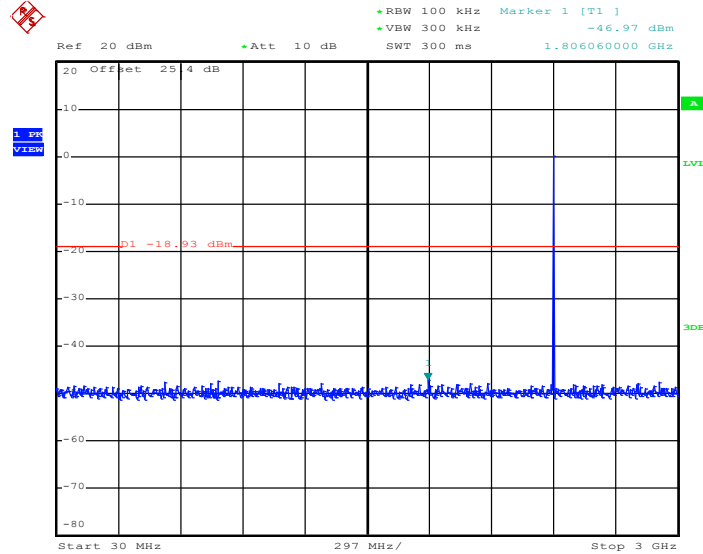

Date: 11.MAY.2014 16:29:57



Conducted Spurious Emission Plot on Bluetooth LE 1Mbps GFSK Channel 00

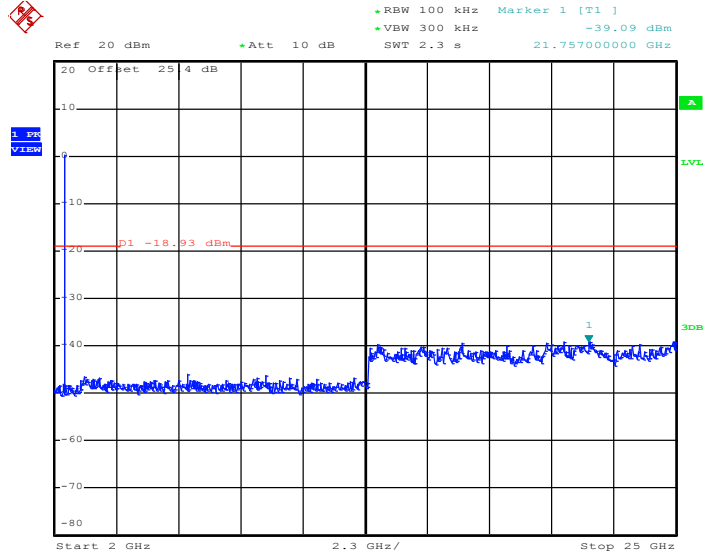

Date: 11.MAY.2014 16:30:16



Test Mode :	Bluetooth 4.0 - LE	Temperature :	22~25°C
Test Channel :	19	Relative Humidity :	51~55%
		Test Engineer :	Bill Kuo

**Conducted Spurious Emission Plot on Bluetooth LE 1Mbps
GFSK Channel 19**

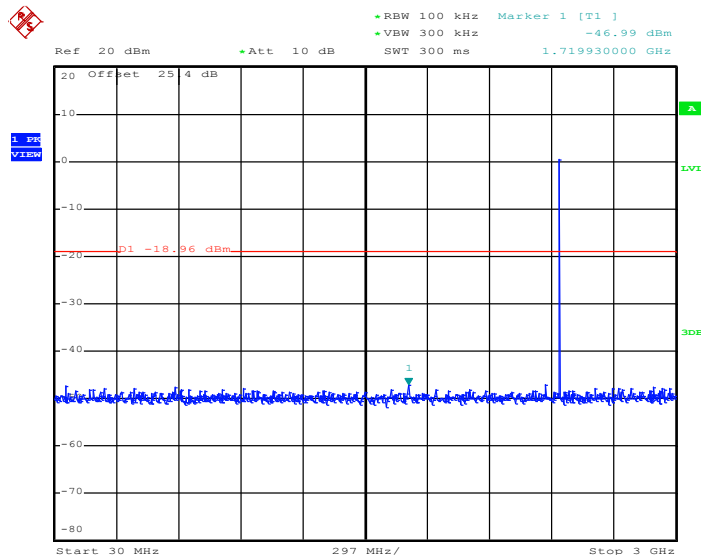

Date: 11.MAY.2014 16:32:38



Conducted Spurious Emission Plot on Bluetooth LE 1Mbps GFSK Channel 19

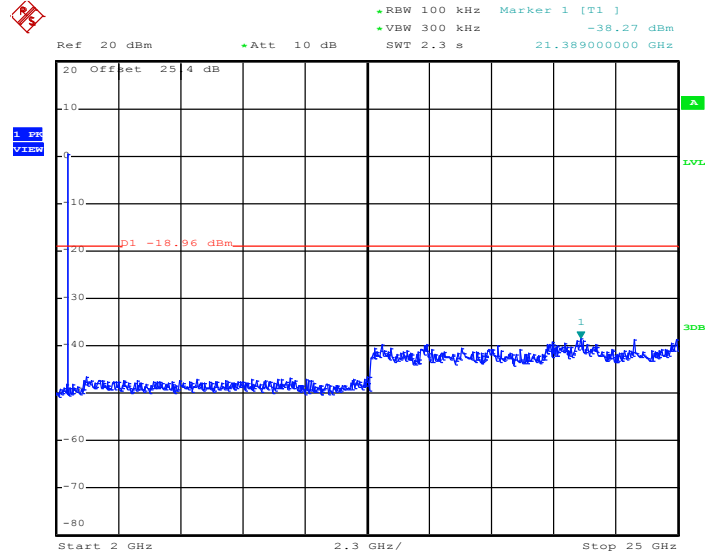

Date: 11.MAY.2014 16:32:56



Test Mode :	Bluetooth 4.0 - LE	Temperature :	22~25°C
Test Channel :	39	Relative Humidity :	51~55%
		Test Engineer :	Bill Kuo

**Conducted Spurious Emission Plot on Bluetooth LE 1Mbps
GFSK Channel 39**

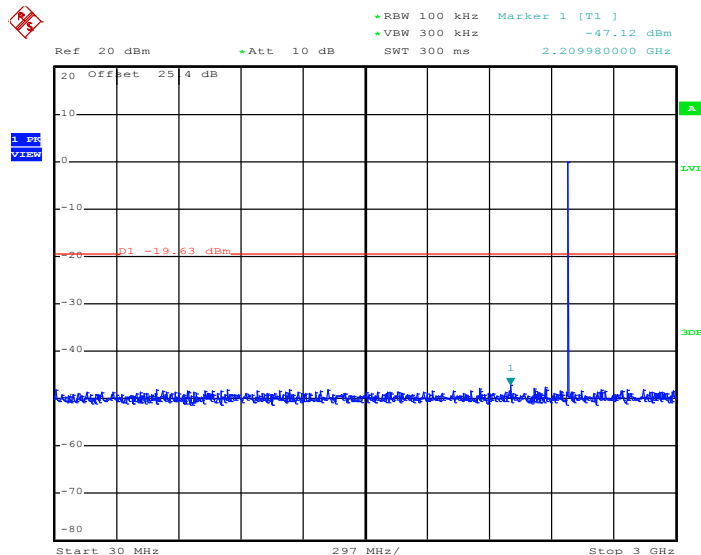

Date: 11.MAY.2014 16:35:28



Conducted Spurious Emission Plot on Bluetooth LE 1Mbps GFSK Channel 39

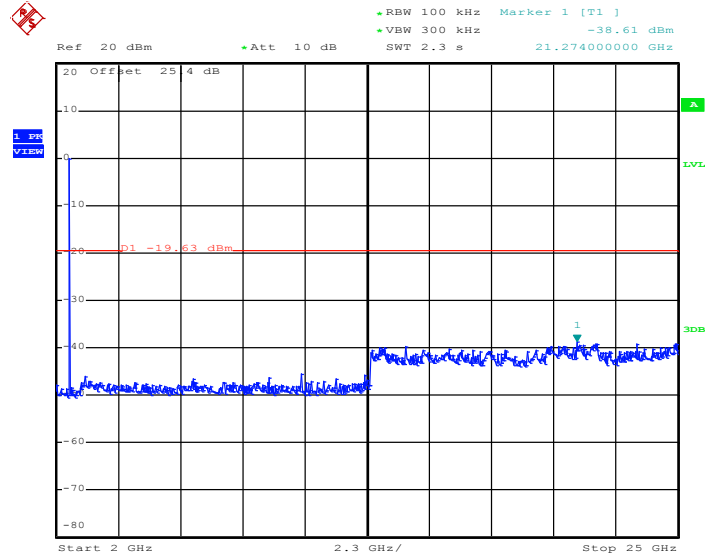

Date: 11.MAY.2014 16:35:46



3.5 Radiated Band Edges and Spurious Emission Measurement

3.5.1 Limit of Radiated Band Edges and Spurious Emission

In any 100 kHz bandwidth outside the intentional radiator frequency band, all harmonics/spurious must be at least 20 dB below the highest emission level within the authorized band. If the output power of this device was measured by spectrum analyzer, the attenuation under this paragraph shall be 30 dB instead of 20 dB. In addition, radiated emissions which fall in the restricted bands must also comply with the FCC section 15.209 limits as below.

Frequency (MHz)	Field Strength (microvolts/meter)	Measurement Distance (meters)
0.009 – 0.490	2400/F(kHz)	300
0.490 – 1.705	24000/F(kHz)	30
1.705 – 30.0	30	30
30 – 88	100	3
88 – 216	150	3
216 - 960	200	3
Above 960	500	3

3.5.2 Measuring Instruments

The section 4.0 of List of Measuring Equipment of this test report is used for test.



3.5.3 Test Procedures

1. The testing follows FCC KDB Publication No. 558074 D01 DTS Meas. Guidance v03r02.
2. The EUT was arranged to its worst case and then tune the antenna tower (from 1 m to 4 m) and turntable (from 0 degree to 360 degrees) to find the maximum reading. A pre-amp and a high pass filter are used for the test in order to get better signal level.
3. The EUT was placed on a turntable with 0.8 meter above ground.
4. The EUT was set 3 meters from the interference receiving antenna, which was mounted on the top of a variable height antenna tower.
5. Corrected Reading: Antenna Factor + Cable Loss + Read Level - Preamp Factor = Level
6. For measurement below 1GHz, If the emission level of the EUT measured by the peak detector is 3 dB lower than the applicable limit, the peak emission level will be reported. Otherwise, the emission measurement will be repeated using the quasi-peak detector and reported.
7. Use the following spectrum analyzer settings:
 - (1) Span shall wide enough to fully capture the emission being measured;
 - (2) Set RBW=100 kHz for $f < 1$ GHz; $VBW \geq RBW$; Sweep = auto; Detector function = peak; Trace = max hold;
 - (3) Set RBW = 1 MHz, VBW= 3MHz for $f \geq 1$ GHz for peak measurement.

For average measurement:

 - $VBW = 10$ Hz, when duty cycle is no less than 98 percent.
 - $VBW \geq 1/T$, when duty cycle is less than 98 percent where T is the minimum transmission duration over which the transmitter is on and is transmitting at its maximum power control level for the tested mode of operation.

Band	Duty Cycle(%)	T(μs)	1/T(kHz)	VBW Setting
Bluetooth 4.0 - LE	62.5	390	2.56	3kHz

3.5.4 Test Setup

For radiated emissions below 30MHz

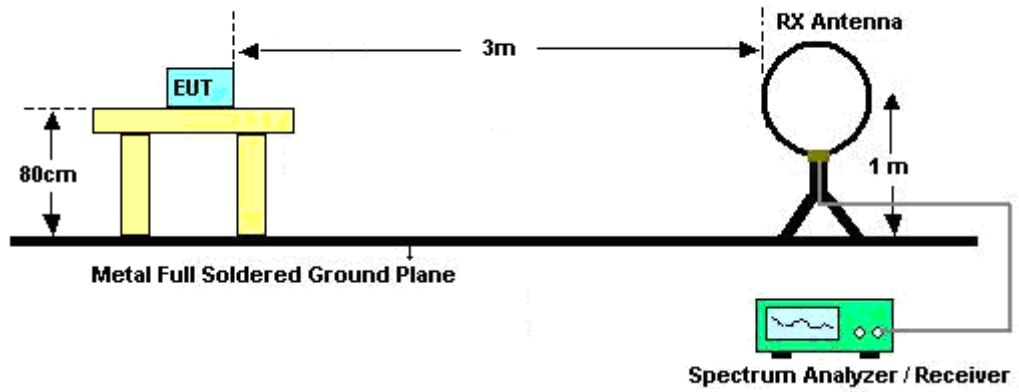

For radiated emissions from 30MHz to 1GHz

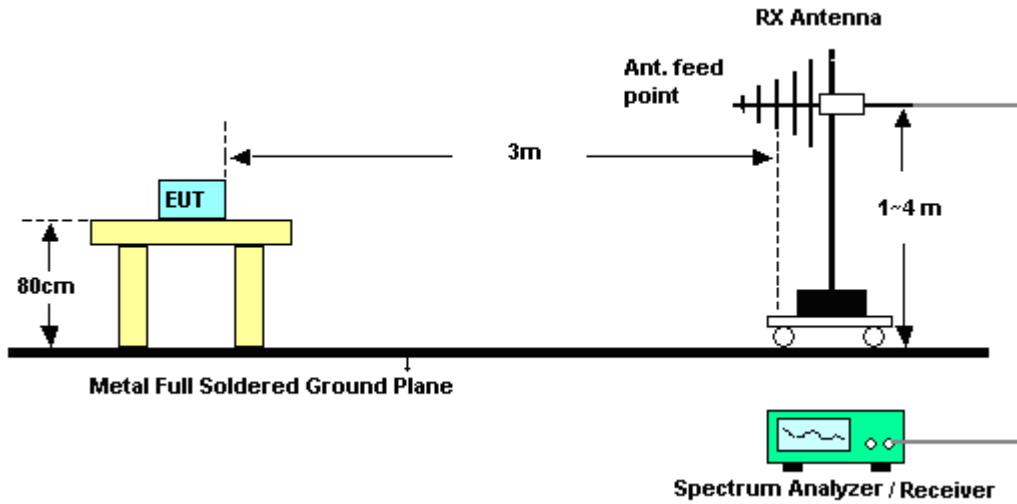

For radiated emissions above 1GHz

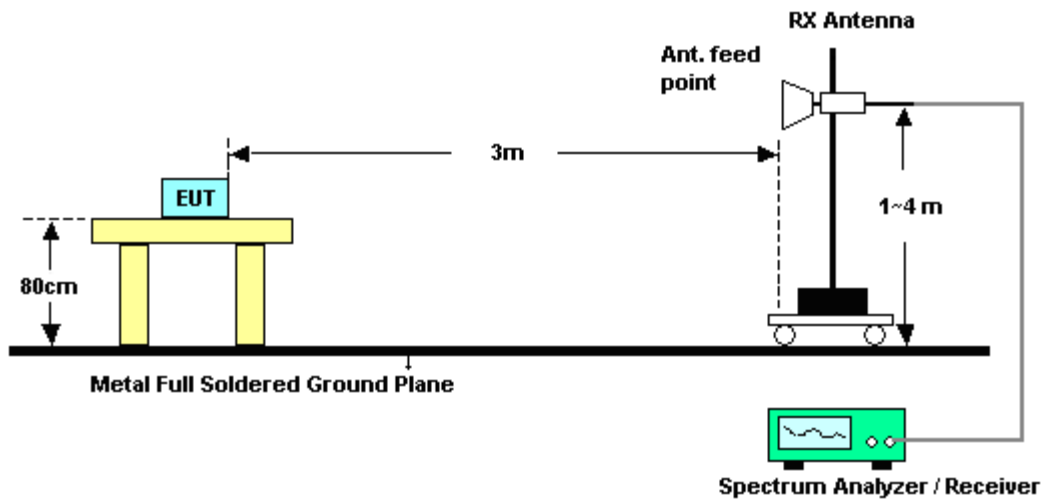

3.5.5 Test Results of Radiated Spurious Emissions (9 kHz ~ 30 MHz)

The low frequency, which started from 9 kHz to 30MHz, was pre-scanned and the result which was 20dB lower than the limit line per 15.31(o) was not reported.



3.5.6 Test Result of Radiated Spurious at Band Edges

Test Mode :	Mode 1	Temperature :	24~25°C
Test Channel :	00	Relative Humidity :	46~47%
		Test Engineer :	Abi Lin

ANTENNA POLARITY : HORIZONTAL										
Frequency (MHz)	Level (dBμV /m)	Over Limit (dB)	Limit Line (dBμV /m)	Read Level (dBμV)	Antenna Factor (dB)	Cable Loss (dB)	Preamp Factor (dB)	Ant Pos (cm)	Table Pos (deg)	Remark
2344.47	48.98	-25.02	74	45.37	31.88	6.38	34.65	105	146	Peak
2389.83	37.93	-16.07	54	34.2	31.92	6.45	34.64	105	146	Average

ANTENNA POLARITY : VERTICAL										
Frequency (MHz)	Level (dBμV /m)	Over Limit (dB)	Limit Line (dBμV /m)	Read Level (dBμV)	Antenna Factor (dB)	Cable Loss (dB)	Preamp Factor (dB)	Ant Pos (cm)	Table Pos (deg)	Remark
2356.08	49.41	-24.59	74	45.75	31.89	6.42	34.65	103	238	Peak
2320.62	37.9	-16.1	54	34.34	31.86	6.35	34.65	103	238	Average

Test Mode :	Mode 3	Temperature :	24~25°C
Test Channel :	39	Relative Humidity :	46~47%
		Test Engineer :	Abi Lin

ANTENNA POLARITY : HORIZONTAL										
Frequency (MHz)	Level (dBμV /m)	Over Limit (dB)	Limit Line (dBμV /m)	Read Level (dBμV)	Antenna Factor (dB)	Cable Loss (dB)	Preamp Factor (dB)	Ant Pos (cm)	Table Pos (deg)	Remark
2483.5	56.31	-17.69	74	52.36	31.99	6.59	34.63	100	54	Peak
2483.5	51.45	-2.55	54	47.5	31.99	6.59	34.63	100	54	Average

ANTENNA POLARITY : VERTICAL										
Frequency (MHz)	Level (dBμV /m)	Over Limit (dB)	Limit Line (dBμV /m)	Read Level (dBμV)	Antenna Factor (dB)	Cable Loss (dB)	Preamp Factor (dB)	Ant Pos (cm)	Table Pos (deg)	Remark
2483.5	53.97	-20.03	74	50.02	31.99	6.59	34.63	100	221	Peak
2483.5	48.18	-5.82	54	44.23	31.99	6.59	34.63	100	221	Average



3.5.7 Test Result of Radiated Spurious Emission (30MHz ~ 10th Harmonic)

Note: Pre-scanned all test modes and only choose the worst case mode recorded in the test report for radiated spurious emission below 1GHz.

Test Mode :	Mode 1	Temperature :	24~25°C
Test Channel :	00	Relative Humidity :	46~47%
Test Engineer :	Abi Lin	Polarization :	Horizontal
Remark :	1. 2402 MHz is fundamental signal which can be ignored. 2. Average measurement was not performed if peak level went lower than the average limit.		

Frequency (MHz)	Level (dBμV/m)	Over Limit (dB)	Limit Line (dBμV/m)	Read Level (dBμV)	Antenna Factor (dB)	Cable Loss (dB)	Preamp Factor (dB)	Ant Pos (cm)	Table Pos (deg)	Remark
2402	96.33	-	-	92.6	31.92	6.45	34.64	105	146	Average
2402	96.68	-	-	92.95	31.92	6.45	34.64	105	146	Peak
4803	40.21	-33.79	74	56.5	34.41	10.16	60.86	100	0	Peak

Note: Other harmonics are lower than background noise.

Test Mode :	Mode 1	Temperature :	24~25°C
Test Channel :	00	Relative Humidity :	46~47%
Test Engineer :	Abi Lin	Polarization :	Vertical
Remark :	1. 2402 MHz is fundamental signal which can be ignored. 2. Average measurement was not performed if peak level went lower than the average limit.		

Frequency (MHz)	Level (dBμV/m)	Over Limit (dB)	Limit Line (dBμV/m)	Read Level (dBμV)	Antenna Factor (dB)	Cable Loss (dB)	Preamp Factor (dB)	Ant Pos (cm)	Table Pos (deg)	Remark
2402	94.18	-	-	90.45	31.92	6.45	34.64	103	238	Average
2402	94.91	-	-	91.18	31.92	6.45	34.64	103	238	Peak
4803	40.78	-33.22	74	57.07	34.41	10.16	60.86	100	0	Peak

Note: Other harmonics are lower than background noise.



Test Mode :	Mode 2	Temperature :	24~25°C
Test Channel :	19	Relative Humidity :	46~47%
Test Engineer :	Abi Lin	Polarization :	Horizontal
Remark :	1. 2440 MHz is fundamental signal which can be ignored. 2. Average measurement was not performed if peak level went lower than the average limit.		

Frequency (MHz)	Level (dBμV/m)	Over Limit (dB)	Limit Line (dBμV/m)	Read Level (dBμV)	Antenna Factor (dB)	Cable Loss (dB)	Preamp Factor (dB)	Ant Pos (cm)	Table Pos (deg)	Remark
2440	98.21	-	-	94.37	31.96	6.52	34.64	100	155	Average
2440	98.44	-	-	94.6	31.96	6.52	34.64	100	155	Peak
4881	41.39	-32.61	74	57.52	34.37	10.19	60.69	100	0	Peak
7320	43.37	-30.63	74	57.36	35.6	10.94	60.53	100	0	Peak

Note: Other harmonics are lower than background noise.

Test Mode :	Mode 2	Temperature :	24~25°C
Test Channel :	19	Relative Humidity :	46~47%
Test Engineer :	Abi Lin	Polarization :	Vertical
Remark :	1. 2440 MHz is fundamental signal which can be ignored. 2. Average measurement was not performed if peak level went lower than the average limit.		

Frequency (MHz)	Level (dBμV/m)	Over Limit (dB)	Limit Line (dBμV/m)	Read Level (dBμV)	Antenna Factor (dB)	Cable Loss (dB)	Preamp Factor (dB)	Ant Pos (cm)	Table Pos (deg)	Remark
2440	96.96	-	-	93.12	31.96	6.52	34.64	100	244	Average
2440	97.28	-	-	93.44	31.96	6.52	34.64	100	244	Peak
4881	41.07	-32.93	74	57.2	34.37	10.19	60.69	100	0	Peak
7320	42.64	-31.36	74	56.63	35.6	10.94	60.53	100	0	Peak

Note: Other harmonics are lower than background noise.



Test Mode :	Mode 3	Temperature :	24~25°C
Test Channel :	39	Relative Humidity :	46~47%
Test Engineer :	Abi Lin	Polarization :	Horizontal
Remark :	1. 2480 MHz is fundamental signal which can be ignored. 2. Average measurement was not performed if peak level went lower than the average limit.		

Frequency (MHz)	Level (dBμV/m)	Over Limit (dB)	Limit Line (dBμV/m)	Read Level (dBμV)	Antenna Factor (dB)	Cable Loss (dB)	Preamp Factor (dB)	Ant Pos (cm)	Table Pos (deg)	Remark
122.34	25.26	-18.24	43.5	43.66	12.12	1.23	31.75	-	-	Peak
206.85	27.57	-15.93	43.5	48.62	9.14	1.56	31.75	-	-	Peak
295.95	28.29	-17.71	46	45	13.12	1.89	31.72	-	-	Peak
326.6	27.86	-18.14	46	43.93	13.7	1.98	31.75	-	-	Peak
755	31.59	-14.41	46	40.32	20.2	3.05	31.98	100	147	Peak
790	30.57	-15.43	46	39.37	20.1	3.06	31.96	-	-	Peak
2480	98.05	-	-	94.1	31.99	6.59	34.63	100	54	Average
2480	98.86	-	-	94.91	31.99	6.59	34.63	100	54	Peak
4959	40.96	-33.04	74	56.91	34.32	10.21	60.48	100	0	Peak
7440	44.08	-29.92	74	58.23	35.53	10.9	60.58	100	0	Peak

Note: Other harmonics are lower than background noise.



Test Mode :	Mode 3	Temperature :	24~25°C
Test Channel :	39	Relative Humidity :	46~47%
Test Engineer :	Abi Lin	Polarization :	Vertical
Remark :	1. 2480 MHz is fundamental signal which can be ignored. 2. Average measurement was not performed if peak level went lower than the average limit.		

Frequency (MHz)	Level (dBμV/m)	Over Limit (dB)	Limit Line (dBμV/m)	Read Level (dBμV)	Antenna Factor (dB)	Cable Loss (dB)	Preamp Factor (dB)	Ant Pos (cm)	Table Pos (deg)	Remark
30	34.72	-5.28	40	47.38	18.5	0.64	31.8	100	156	Peak
121.8	26.59	-16.91	43.5	44.99	12.12	1.23	31.75	-	-	Peak
254.1	30.33	-15.67	46	47.31	13	1.75	31.73	-	-	Peak
338.5	29.84	-16.16	46	45.64	13.95	2.01	31.76	-	-	Peak
765.5	30.72	-15.28	46	39.49	20.15	3.05	31.97	-	-	Peak
900.6	27.88	-18.12	46	34.94	21.09	3.37	31.52	-	-	Peak
2480	94.75	-	-	90.8	31.99	6.59	34.63	100	221	Average
2480	95.59	-	-	91.64	31.99	6.59	34.63	100	221	Peak
4959	41.67	-32.33	74	57.62	34.32	10.21	60.48	100	0	Peak
7440	43.47	-30.53	74	57.62	35.53	10.9	60.58	100	0	Peak

Note: Other harmonics are lower than background noise.



3.6 AC Conducted Emission Measurement

3.6.1 Limit of AC Conducted Emission

For equipment that is designed to be connected to the public utility (AC) power line, the radio frequency voltage that is conducted back onto the AC power line on any frequency or frequencies within the band 150 kHz to 30 MHz shall not exceed the limits in the following table.

Frequency of emission (MHz)	Conducted limit (dB μ V)	
	Quasi-peak	Average
0.15-0.5	66 to 56*	56 to 46*
0.5-5	56	46
5-30	60	50

*Decreases with the logarithm of the frequency.

3.6.2 Measuring Instruments

The section 4.0 of List of Measuring Equipment of this test report is used for test.

3.6.3 Test Procedures

1. The EUT was placed 0.4 meter from the conducting wall of the shielding room was kept at least 80 centimeters from any other grounded conducting surface.
2. Connect EUT to the power mains through a line impedance stabilization network (LISN).
3. All the support units are connecting to the other LISN.
4. The LISN provides 50 ohm coupling impedance for the measuring instrument.
5. The FCC states that a 50 ohm, 50 microhenry LISN should be used.
6. Both sides of AC line were checked for maximum conducted interference.
7. The frequency range from 150 kHz to 30 MHz was searched.
8. Set the test-receiver system to Peak Detect Function and specified bandwidth with Maximum Hold Mode.

3.6.4 Test Setup

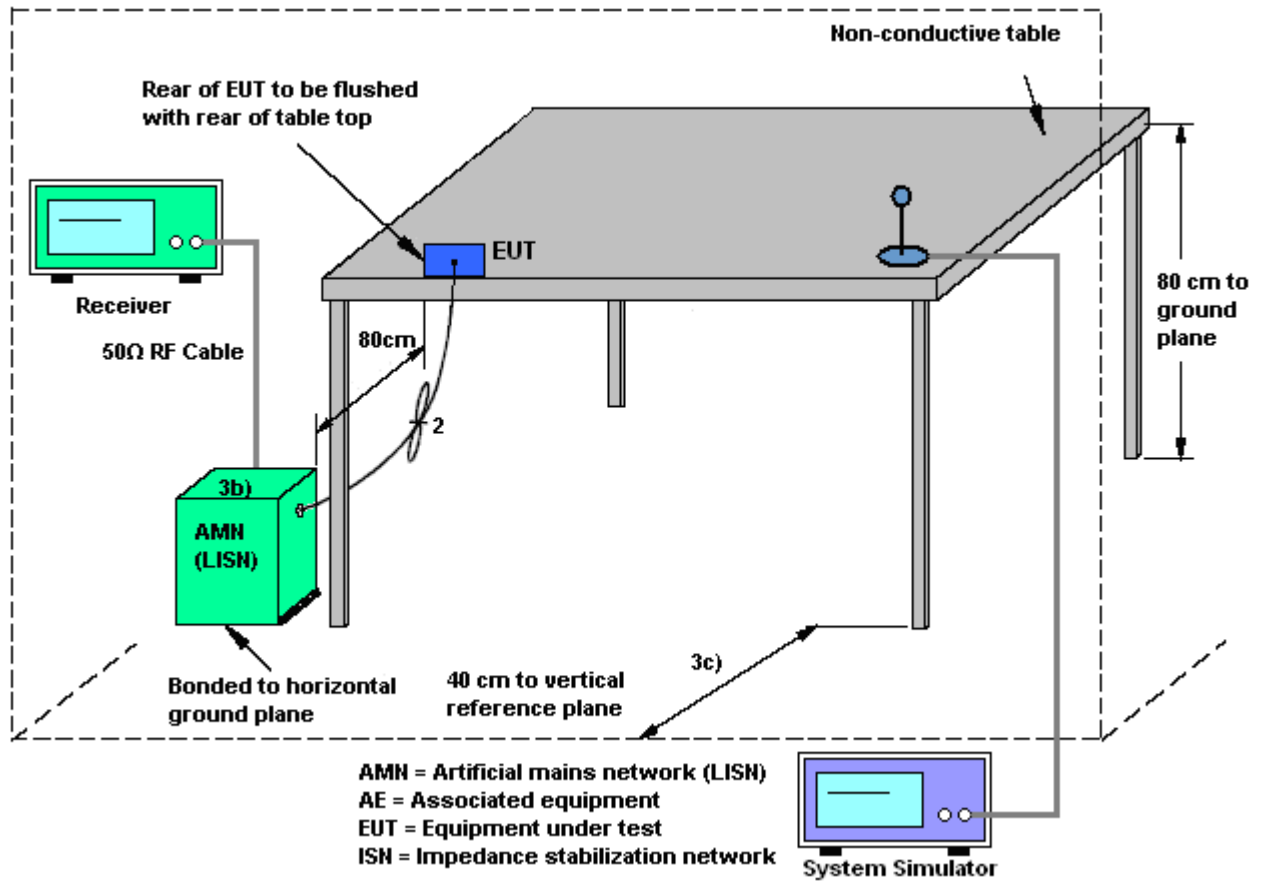

3.6.5 Test Result of AC Conducted Emission

Test Mode :	Mode 1	Temperature :	20~22°C
Test Engineer :	Cosmo Xu	Relative Humidity :	45~47%
Test Voltage :	120Vac / 60Hz	Phase :	Line
Function Type :	GSM850 Idle + Bluetooth Link + WLAN Link + Adapter + Earphone + MP3		

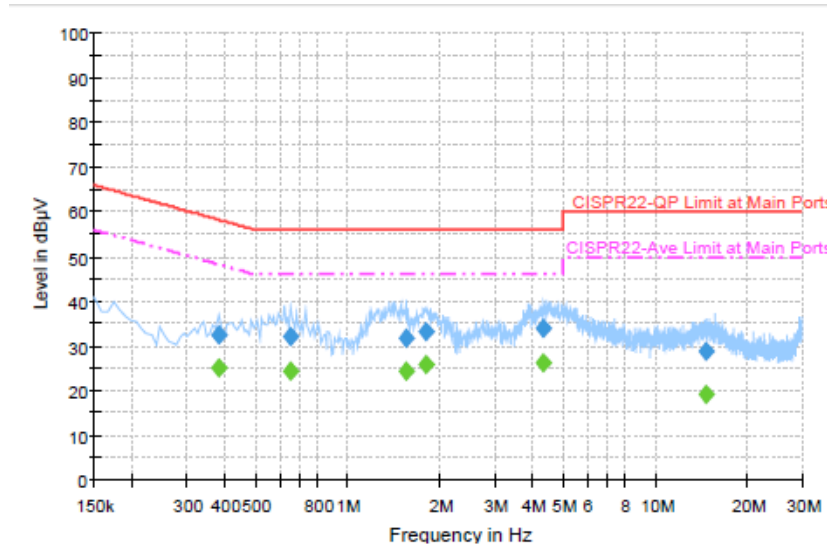

Final Result : Quasi-Peak

Frequency (MHz)	Quasi-Peak (dBµV)	Filter	Line	Corr. (dB)	Margin (dB)	Limit (dBµV)
0.382000	32.4	Off	L1	19.3	25.8	58.2
0.654000	32.2	Off	L1	19.4	23.8	56.0
1.550000	31.6	Off	L1	19.4	24.4	56.0
1.790000	33.2	Off	L1	19.5	22.8	56.0
4.342000	33.8	Off	L1	19.6	22.2	56.0
14.694000	29.0	Off	L1	19.9	31.0	60.0

Final Result : Average

Frequency (MHz)	Average (dBµV)	Filter	Line	Corr. (dB)	Margin (dB)	Limit (dBµV)
0.382000	25.1	Off	L1	19.3	23.1	48.2
0.654000	24.2	Off	L1	19.4	21.8	46.0
1.550000	24.4	Off	L1	19.4	21.6	46.0
1.790000	25.8	Off	L1	19.5	20.2	46.0
4.342000	26.2	Off	L1	19.6	19.8	46.0
14.694000	19.2	Off	L1	19.9	30.8	50.0



Test Mode :	Mode 1	Temperature :	20~22°C
Test Engineer :	Cosmo Xu	Relative Humidity :	45~47%
Test Voltage :	120Vac / 60Hz	Phase :	Neutral
Function Type :	GSM850 Idle + Bluetooth Link + WLAN Link + Adapter + Earphone + MP3		

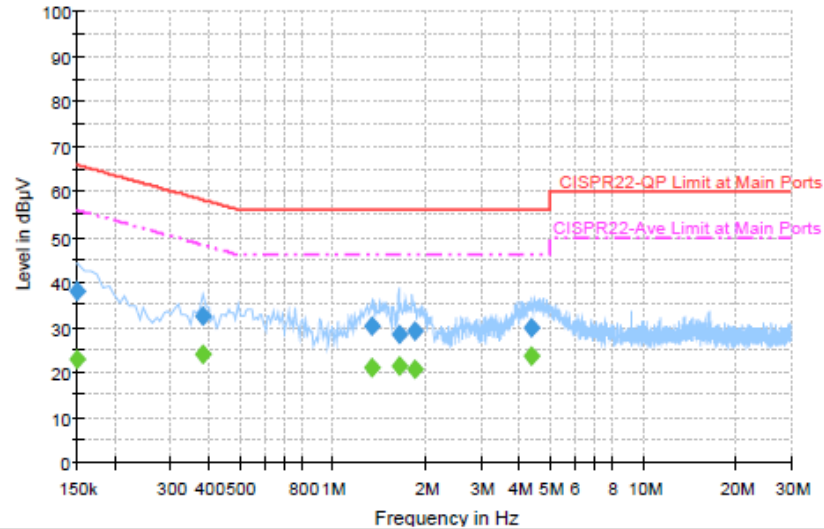

Final Result : Quasi-Peak

Frequency (MHz)	Quasi-Peak (dBµV)	Filter	Line	Corr. (dB)	Margin (dB)	Limit (dBµV)
0.150000	38.0	Off	N	19.4	28.0	66.0
0.382000	32.4	Off	N	19.3	25.8	58.2
1.334000	30.2	Off	N	19.5	25.8	56.0
1.638000	28.3	Off	N	19.5	27.7	56.0
1.830000	29.2	Off	N	19.6	26.8	56.0
4.366000	29.8	Off	N	19.6	26.2	56.0

Final Result : Average

Frequency (MHz)	Average (dBµV)	Filter	Line	Corr. (dB)	Margin (dB)	Limit (dBµV)
0.150000	22.8	Off	N	19.4	33.2	56.0
0.382000	24.0	Off	N	19.3	24.2	48.2
1.334000	21.2	Off	N	19.5	24.8	46.0
1.638000	21.5	Off	N	19.5	24.5	46.0
1.830000	20.6	Off	N	19.6	25.4	46.0
4.366000	23.5	Off	N	19.6	22.5	46.0



3.7 Antenna Requirements

3.7.1 Standard Applicable

If directional gain of transmitting antennas is greater than 6dBi, the power shall be reduced by the same level in dB comparing to gain minus 6dBi. The use of a permanently attached antenna or of an antenna that uses a unique coupling to the intentional radiator shall be considered sufficient to comply with the FCC rule.

3.7.2 Antenna Anti-Replacement Construction

An embedded-in antenna design is used.

3.7.3 Antenna Gain

The antenna peak gain of EUT is less than 6 dBi. Therefore, it is not necessary to reduce maximum peak output power limit.



4 List of Measuring Equipment

Instrument	Manufacturer	Model No.	Serial No.	Characteristics	Calibration Date	Test Date	Due Date	Remark
Spectrum Analyzer	Rohde & Schwarz	FSP40	100055	9kHz~40GHz	Jun. 07, 2013	May 02, 2014~ May 11, 2014	Jun. 06, 2014	Conducted (TH02-HY)
Power Meter	Agilent	E4416A	GB41292344	300MHz~40GHz	Jan. 28, 2014	May 02, 2014~ May 11, 2014	Jan. 27, 2015	Conducted (TH02-HY)
Power Sensor	Agilent	E9327A	US40441548	300MHz~40GHz	Jan. 28, 2014	May 02, 2014~ May 11, 2014	Jan. 27, 2015	Conducted (TH02-HY)
Spectrum Analyzer	R&S	FSP30	101067	9kHz ~ 30GHz	Nov. 20, 2013	Jun. 20, 2014	Nov. 19, 2014	Radiation (03CH06-HY)
Spectrum Analyzer	Agilent	E4408B	MY44211030	9kHz ~ 26.5GHz	Dec. 02, 2013	Jun. 20, 2014	Dec. 01, 2014	Radiation (03CH06-HY)
EMI Test Receiver	R&S	ESVS10	834468/0003	20MHz ~ 1000MHz	May 06, 2014	Jun. 20, 2014	May 05, 2015	Radiation (03CH06-HY)
Loop Antenna	Rohde & Schwarz	HFH2-Z2	860004/0001	9kHz ~ 30MHz	Jul. 03, 2012	Jun. 20, 2014	Jul. 02, 2014	Radiation (03CH06-HY)
Bilog Antenna	Schaffner	CBL6112B	2885	30MHz ~ 2GHz	Oct. 10, 2013	Jun. 20, 2014	Oct. 09, 2014	Radiation (03CH06-HY)
Double Ridge Horn Antenna	EMCO	3117	00066583	1GHz ~ 18GHz	Aug. 02, 2013	Jun. 20, 2014	Aug. 01, 2014	Radiation (03CH06-HY)
Amplifier	SONOMA	310N	186713	9kHz ~ 1GHz	Apr. 16, 2014	Jun. 20, 2014	Apr. 15, 2015	Radiation (03CH06-HY)
Pre Amplifier	EMCI	EMC051845	SN980048	1GHz ~ 18GHz	Jul. 18, 2013	Jun. 20, 2014	Jul. 17, 2014	Radiation (03CH06-HY)
SHF-EHF Horn Antenna	SCHWARZBE CK	BBHA 9170	BBHA9170251	15GHz ~ 40GHz	Oct. 03, 2013	Jun. 20, 2014	Oct. 02, 2014	Radiation (03CH06-HY)
Preamplifier	Agilent	8449B	3008A01917	1GHz ~ 26.5GHz	Apr. 10, 2014	Jun. 20, 2014	Apr. 09, 2015	Radiation (03CH06-HY)
Turn Table	INN-CO	DS2000	420/650/00	0 ~ 360 degree	N/A	Jun. 20, 2014	N/A	Radiation (03CH06-HY)
Antenna Mast	MF	MF-7802	MF780208212	1 m ~ 4 m	N/A	Jun. 20, 2014	N/A	Radiation (03CH06-HY)
EMI Test Receiver	Rohde & Schwarz	ESCS 30	100356	9kHz ~ 2.75GHz	Nov. 15, 2013	May 29, 2014	Nov. 14, 2014	Conduction (CO05-HY)
LISN (for auxiliary equipment)	Rohde & Schwarz	ENV216	100081	9kHz ~ 30MHz	Dec. 12, 2013	May 29, 2014	Dec. 11, 2014	Conduction (CO05-HY)
LISN	Rohde & Schwarz	ENV216	100080	9kHz ~ 30MHz	Dec. 04, 2013	May 29, 2014	Dec. 03, 2014	Conduction (CO05-HY)
AC Power Source	ChainTek	APC-1000W	N/A	N/A	N/A	May 29, 2014	N/A	Conduction (CO05-HY)



5 Uncertainty of Evaluation

Uncertainty of Conducted Emission Measurement (150 kHz ~ 30 MHz)

Measuring Uncertainty for a Level of Confidence of 95% ($U = 2Uc(y)$)	2.26
---	------

Uncertainty of Radiated Emission Measurement (30 MHz ~ 1000 MHz)

Measuring Uncertainty for a Level of Confidence of 95% ($U = 2Uc(y)$)	4.50
---	------