



FCC RF Test Report

APPLICANT : Motorola Mobility LLC
EQUIPMENT : Mobile Cellular Phone
BRAND NAME : Motorola
MODEL NAME : 4023
FCC ID : IHDT56QB1
STANDARD : FCC Part 15 Subpart C §15.247
CLASSIFICATION : (DTS) Digital Transmission System

The product was received on Apr. 23, 2014 and testing was completed on Jun. 20, 2014. We, SPORTON INTERNATIONAL INC., would like to declare that the tested sample has been evaluated in accordance with the test procedures and has been in compliance with the applicable technical standards.

The test results in this report apply exclusively to the tested model / sample. Without written approval of SPORTON INTERNATIONAL INC., the test report shall not be reproduced except in full.

Reviewed by: Joseph Lin / Supervisor

Approved by: Jones Tsai / Manager



SPORTON INTERNATIONAL INC.

No. 52, Hwa Ya 1st Rd., Hwa Ya Technology Park, Kwei-Shan Hsiang, Tao Yuan Hsien, Taiwan, R.O.C.



TABLE OF CONTENTS

REVISION HISTORY..... 3

SUMMARY OF TEST RESULT 4

1 GENERAL DESCRIPTION 5

 1.1 Applicant 5

 1.2 Manufacturer 5

 1.3 Product Feature of Equipment Under Test 5

 1.4 Product Specification subjective to this standard 6

 1.5 Modification of EUT 6

 1.6 Testing Location 7

 1.7 Applicable Standards 7

2 TEST CONFIGURATION OF EQUIPMENT UNDER TEST 8

 2.1 Carrier Frequency Channel 8

 2.2 Pre-Scanned RF Power 9

 2.3 Test Mode 11

 2.4 Connection Diagram of Test System 12

 2.5 Support Unit used in test configuration and system 13

 2.6 EUT Operation Test Setup 13

 2.7 Measurement Results Explanation Example 13

3 TEST RESULT 14

 3.1 6dB Bandwidth Measurement 14

 3.2 Output Power Measurement 16

 3.3 Power Spectral Density Measurement 19

 3.4 Conducted Band Edges and Spurious Emission Measurement 21

 3.5 Radiated Band Edges and Spurious Emission Measurement 31

 3.6 AC Conducted Emission Measurement 50

 3.7 Antenna Requirements 54

4 LIST OF MEASURING EQUIPMENT 55

5 UNCERTAINTY OF EVALUATION 56



SUMMARY OF TEST RESULT

| Report Section | FCC Rule | Description | Limit | Result | Remark |
|----------------|--------------------|--|--------------------------------|--------|-------------------------------------|
| 3.1 | 15.247(a)(2) | 6dB Bandwidth | $\geq 0.5\text{MHz}$ | Pass | - |
| 3.2 | 15.247(b) | Power Output Measurement | $\leq 30\text{dBm}$ | Pass | - |
| 3.3 | 15.247(e) | Power Spectral Density | $\leq 8\text{dBm}/3\text{kHz}$ | Pass | - |
| 3.4 | 15.247(d) | Conducted Band Edges | $\leq 20\text{dBc}$ | Pass | - |
| | | Conducted Spurious Emission | | Pass | - |
| 3.5 | 15.247(d) | Radiated Band Edges and Radiated Spurious Emission | 15.209(a) & 15.247(d) | Pass | Under limit 0.44 dB at 2484.460 MHz |
| 3.6 | 15.207 | AC Conducted Emission | 15.207(a) | Pass | Under limit 19.80 dB at 4.342 MHz |
| 3.7 | 15.203 & 15.247(b) | Antenna Requirement | N/A | Pass | - |



1 General Description

1.1 Applicant

Motorola Mobility LLC
222 W. Merchandise Mart Plaza, Chicago IL. 60654

1.2 Manufacturer

Motorola Mobility LLC
222 W. Merchandise Mart Plaza, Chicago IL. 60654

1.3 Product Feature of Equipment Under Test

| Product Feature | |
|--|--|
| Equipment | Mobile Cellular Phone |
| Brand Name | Motorola |
| Model Name | 4023 |
| FCC ID | IHDT56QB1 |
| IIMEI | 359286050063637 |
| EUT supports Radios application | GSM/EGPRS/WCDMA/HSPA WLAN 11b/g/n HT20 Bluetooth v3.0 EDR Bluetooth v4.0 - LE |
| HW Version | P2 |
| SW Version | KXB21.32.18 |
| EUT Stage | Identical Prototype |

Remark: The above EUT's information was declared by manufacturer. Please refer to the specifications or user's manual for more detailed description.



1.4 Product Specification subjective to this standard

| Product Specification subjective to this standard | |
|---|---|
| Tx/Rx Channel Frequency Range | 802.11b/g/n : 2412 MHz ~ 2462 MHz |
| Maximum (Peak) Output Power to Antenna | 802.11b : 20.65 dBm (0.1161 W) 802.11g : 23.02 dBm (0.2004 W) 802.11n HT20 : 23.02 dBm (0.2004 W) |
| Antenna Type | 802.11b/g/n : PIFA Antenna type with gain 1.80 dBi |
| Type of Modulation | 802.11b : DSSS (DBPSK / DQPSK / CCK) 802.11g/n : OFDM (BPSK / QPSK / 16QAM / 64QAM) |

1.5 Modification of EUT

No modifications are made to the EUT during all test items.



1.6 Testing Location

Sporton Lab is accredited to ISO 17025 by Taiwan Accreditation Foundation (TAF code : 1190) and the FCC designation No. TW1022 under the FCC 2.948(e) by Mutual Recognition Agreement (MRA) in FCC Test.

| | | | | |
|---------------------------|--|---------|-----------|----------------------------|
| Test Site | SPORTON INTERNATIONAL INC. | | | |
| Test Site Location | No. 52, Hwa Ya 1 st Rd., Hwa Ya Technology Park, Kwei-Shan Hsiang, Tao Yuan Hsien, Taiwan, R.O.C. TEL: +886-3-3273456 / FAX: +886-3-3284978 | | | |
| Test Site No. | Sporton Site No. | | | IC Registration No. |
| | TH02-HY | CO05-HY | 03CH06-HY | 4086B-1 |

1.7 Applicable Standards

According to the specifications of the manufacturer, the EUT must comply with the requirements of the following standards:

- ♦ FCC Part 15 Subpart C §15.247
- ♦ FCC KDB Publication No. 558074 D01 DTS Meas. Guidance v03r02
- ♦ ANSI C63.4-2003

Remark:

1. All test items were verified and recorded according to the standards and without any deviation during the test.
2. This EUT has also been tested and complied with the requirements of FCC Part 15, Subpart B, recorded in a separate test report.



2 Test Configuration of Equipment Under Test

The EUT has been associated with peripherals and configuration operated in a manner tended to maximize its emission characteristics in a typical application. Frequency range investigated: conducted emission (150 kHz to 30 MHz) and radiated emission (9 kHz to the 10th harmonic of the highest fundamental frequency or to 40 GHz, whichever is lower). For radiated measurement, pre-scanned in three orthogonal panels, X, Y, Z. The worst cases (Z plane) were recorded in this report.

The final configuration from all the combinations and the worst-case data rates were investigated by measuring the maximum power across all the data rates and modulation modes under section 2.2.

Based on the worst configuration found above, the RF power setting is set individually to meet FCC compliance limit for the final conducted and radiated tests shown in section 2.3.

2.1 Carrier Frequency Channel

| Frequency Band | Channel | Freq. (MHz) | Channel | Freq. (MHz) |
|-----------------|---------|-------------|---------|-------------|
| 2400-2483.5 MHz | 1 | 2412 | 7 | 2442 |
| | 2 | 2417 | 8 | 2447 |
| | 3 | 2422 | 9 | 2452 |
| | 4 | 2427 | 10 | 2457 |
| | 5 | 2432 | 11 | 2462 |
| | 6 | 2437 | - | - |



2.2 Pre-Scanned RF Power

Preliminary tests were performed in different data rate and data rate associated with the highest power were chosen for full test shown in the following tables.

| Channel | Frequency | 2.4GHz 802.11b RF Power (dBm) (800ns) | | | |
|---------|-----------|---------------------------------------|--------|----------|---------|
| | | DSSS Data Rate | | | |
| | | 1 Mbps | 2 Mbps | 5.5 Mbps | 11 Mbps |
| CH 01 | 2412MHz | 20.47 | 20.45 | 20.41 | 20.40 |
| CH 06 | 2437MHz | 20.65 | 20.62 | 20.64 | 20.62 |
| CH 11 | 2462MHz | 20.62 | 20.60 | 20.49 | 20.48 |

| Channel | Frequency | 2.4GHz 802.11b Average Power (dBm) (800ns) | | | |
|---------|-----------|--|--------|----------|---------|
| | | DSSS Data Rate | | | |
| | | 1 Mbps | 2 Mbps | 5.5 Mbps | 11 Mbps |
| CH 01 | 2412MHz | 17.86 | 17.83 | 17.80 | 17.85 |
| CH 06 | 2437MHz | 17.96 | 17.94 | 17.94 | 17.93 |
| CH 11 | 2462MHz | 18.00 | 17.99 | 17.96 | 17.98 |

| Channel | Frequency | 2.4GHz 802.11g RF Power (dBm) (800ns) | | | | | | | |
|---------|-----------|---------------------------------------|--------|---------|---------|---------|---------|---------|---------|
| | | OFDM Data Rate | | | | | | | |
| | | 6 Mbps | 9 Mbps | 12 Mbps | 18 Mbps | 24 Mbps | 36 Mbps | 48 Mbps | 54 Mbps |
| CH 01 | 2412MHz | 21.08 | 20.87 | 20.92 | 21.04 | 20.96 | 20.76 | 20.84 | 20.63 |
| CH 06 | 2437MHz | 23.02 | 22.97 | 22.85 | 22.75 | 22.98 | 22.61 | 22.69 | 21.23 |
| CH 11 | 2462MHz | 20.15 | 20.04 | 20.03 | 20.02 | 20.01 | 19.82 | 19.95 | 20.02 |

| Channel | Frequency | 2.4GHz 802.11g Average Power (dBm) (800ns) | | | | | | | |
|---------|-----------|--|--------|---------|---------|---------|---------|---------|---------|
| | | OFDM Data Rate | | | | | | | |
| | | 6 Mbps | 9 Mbps | 12 Mbps | 18 Mbps | 24 Mbps | 36 Mbps | 48 Mbps | 54 Mbps |
| CH 01 | 2412MHz | 11.93 | 11.91 | 11.90 | 11.88 | 11.55 | 11.79 | 11.68 | 11.72 |
| CH 06 | 2437MHz | 15.95 | 15.91 | 15.90 | 15.38 | 14.77 | 14.48 | 14.48 | 12.44 |
| CH 11 | 2462MHz | 11.05 | 11.01 | 10.98 | 11.00 | 10.60 | 10.92 | 10.80 | 10.92 |



| Channel | Frequency | 2.4GHz 802.11n HT20 RF Power (dBm) (800ns) | | | | | | | |
|---------|-----------|--|-------|-------|-------|-------|-------|-------|-------|
| | | OFDM Data Rate | | | | | | | |
| | | MCS0 | MCS1 | MCS2 | MCS3 | MCS4 | MCS5 | MCS6 | MCS7 |
| CH 01 | 2412MHz | 20.31 | 20.02 | 20.21 | 19.97 | 19.94 | 20.10 | 20.20 | 19.19 |
| CH 06 | 2437MHz | 23.02 | 22.96 | 22.93 | 22.62 | 22.42 | 22.16 | 21.72 | 19.40 |
| CH 11 | 2462MHz | 20.01 | 19.99 | 19.92 | 19.97 | 19.71 | 19.61 | 19.73 | 19.15 |

| Channel | Frequency | 2.4GHz 802.11n HT20 Average Power (dBm) (800ns) | | | | | | | |
|---------|-----------|---|-------|-------|-------|-------|-------|-------|------|
| | | OFDM Data Rate | | | | | | | |
| | | MCS0 | MCS1 | MCS2 | MCS3 | MCS4 | MCS5 | MCS6 | MCS7 |
| CH 01 | 2412MHz | 10.83 | 10.76 | 10.82 | 10.60 | 10.66 | 10.67 | 10.65 | 9.74 |
| CH 06 | 2437MHz | 15.94 | 15.90 | 15.89 | 14.86 | 13.89 | 12.92 | 12.42 | 9.98 |
| CH 11 | 2462MHz | 10.57 | 10.48 | 10.55 | 10.28 | 10.34 | 10.37 | 10.17 | 9.84 |



2.3 Test Mode

Final results of test modes, data rates and test channels are shown as following table.

| Test Cases | | | | |
|--------------------------------|--|--------------|-----------|--------------|
| | Test Items | Mode | Data Rate | Test Channel |
| Conducted TCs | 6dB BW Power Spectral Density | 802.11b | 1 Mbps | 1/6/11 |
| | | 802.11g | 6 Mbps | 1/6/11 |
| | | 802.11n HT20 | MCS0 | 1/6/11 |
| | Output Power | 802.11b | 1 Mbps | 1/6/11 |
| | | 802.11g | 6 Mbps | 1/6/11 |
| | | 802.11n HT20 | MCS0 | 1/6/11 |
| | Conducted Band Edge | 802.11b | 1 Mbps | 1/11 |
| | | 802.11g | 6 Mbps | 1/11 |
| | | 802.11n HT20 | MCS0 | 1/11 |
| Conducted Spurious Emission | 802.11b | 1 Mbps | 1/6/11 | |
| | 802.11g | 6 Mbps | 1/6/11 | |
| | 802.11n HT20 | MCS0 | 1/6/11 | |
| Radiated TCs | Radiated Band Edge | 802.11b | 1 Mbps | 1/11 |
| | | 802.11g | 6 Mbps | 1/11 |
| | | 802.11n HT20 | MCS0 | 1/11 |
| | Radiated Spurious Emission | 802.11b | 1 Mbps | 1/6/11 |
| | | 802.11g | 6 Mbps | 1/6/11 |
| | | 802.11n HT20 | MCS0 | 1/6/11 |
| AC Conducted Emission | Mode 1 : GSM850 Idle + Bluetooth Link + WLAN Link + USB Cable (Charging from Adapter) + Earphone + MP3 | | | |

2.4 Connection Diagram of Test System

<WLAN Tx Mode>

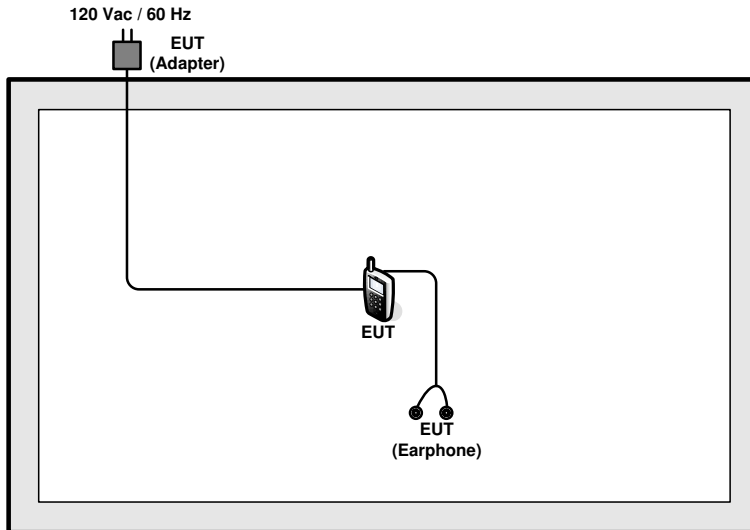

<AC Conducted Emission Mode>

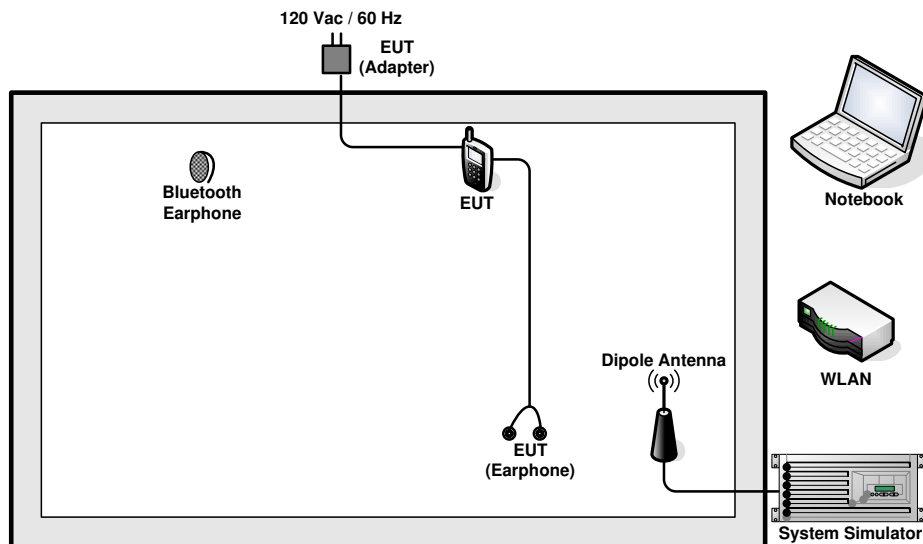



2.5 Support Unit used in test configuration and system

| Item | Equipment | Trade Name | Model Name | FCC ID | Data Cable | Power Cord |
|------|--------------------|---------------|----------------|--|------------|--|
| 1. | System Simulator | R&S | CMU 200 | N/A | N/A | Unshielded, 1.8 m |
| 2. | WLAN AP | D-Link | DIR-628 | KA2DIR628A2 | N/A | Unshielded, 1.8 m |
| 3. | Notebook | DELL | Latitude E6320 | FCC DoC/ Contains FCC ID: QDS-BRCM1054 | N/A | AC I/P: Unshielded, 1.2 m DC O/P: Shielded, 1.8 m |
| 4. | Bluetooth Earphone | Sony Ericsson | MW600 | PY7DDA-2029 | N/A | N/A |
| 5. | SD Card | SanDisk | MicroSD HC | FCC DoC | N/A | N/A |

2.6 EUT Operation Test Setup

For WLAN RF test items, an engineering test program was provided and enabled to make EUT continuous transmit/receive.

2.7 Measurement Results Explanation Example

For all conducted test items:

The offset level is set in the spectrum analyzer to compensate the RF cable loss and attenuator factor between EUT conducted output port and spectrum analyzer. With the offset compensation, the spectrum analyzer reading level is exactly the EUT RF output level.

Example :

The spectrum analyzer offset is derived from RF cable loss and attenuator factor.

Offset = RF cable loss + attenuator factor.

Following shows an offset computation example with cable loss 4.2 dB and 10dB attenuator.

$$\begin{aligned} \text{Offset(dB)} &= \text{RF cable loss(dB)} + \text{attenuator factor(dB)}. \\ &= 4.2 + 10 = 14.2 \text{ (dB)} \end{aligned}$$

3 Test Result

3.1 6dB Bandwidth Measurement

3.1.1 Limit of 6dB Bandwidth

The minimum 6 dB bandwidth shall be at least 500 kHz.

3.1.2 Measuring Instruments

The measuring equipment is listed in the section 4 of this test report.

3.1.3 Test Procedures

1. The testing follows FCC KDB Publication No. 558074 DTS D01 Meas. Guidance v03r02.
2. The RF output of EUT was connected to the spectrum analyzer by RF cable and attenuator. The path loss was compensated to the results for each measurement.
3. Set to the maximum power setting and enable the EUT transmit continuously.
4. Make the measurement with the spectrum analyzer's resolution bandwidth (RBW) = 100 kHz. Set the Video bandwidth (VBW) = 300 kHz. In order to make an accurate measurement. The 6 dB bandwidth must be greater than 500 kHz.
5. Measure and record the results in the test report.

3.1.4 Test Setup

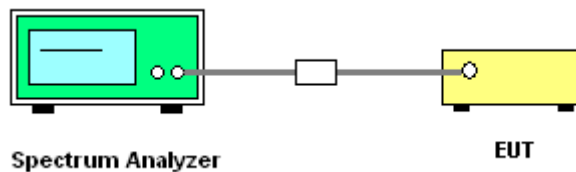



3.1.5 Test Result of 6dB Bandwidth

| | | | |
|-----------------|----------|---------------------|---------|
| Test Band : | 2.4GHz | Temperature : | 24~26°C |
| Test Engineer : | Alex Lee | Relative Humidity : | 45~49% |

| Mod. | Data Rate | N _{TX} | Channel | Freq. (MHz) | 6dB Bandwidth (MHz) | 6dB Bandwidth Min. Limit (MHz) | Pass/Fail |
|------|-----------|-----------------|---------|-------------|---------------------|--------------------------------|-----------|
| 11b | 1Mbps | 1 | 1 | 2412 | 7.08 | 0.5 | Pass |
| 11b | 1Mbps | 1 | 6 | 2437 | 7.12 | 0.5 | Pass |
| 11b | 1Mbps | 1 | 11 | 2462 | 7.04 | 0.5 | Pass |
| 11g | 6Mbps | 1 | 1 | 2412 | 16.32 | 0.5 | Pass |
| 11g | 6Mbps | 1 | 6 | 2437 | 16.36 | 0.5 | Pass |
| 11g | 6Mbps | 1 | 11 | 2462 | 16.32 | 0.5 | Pass |
| HT20 | MCS0 | 1 | 1 | 2412 | 17.58 | 0.5 | Pass |
| HT20 | MCS0 | 1 | 6 | 2437 | 17.58 | 0.5 | Pass |
| HT20 | MCS0 | 1 | 11 | 2462 | 17.56 | 0.5 | Pass |

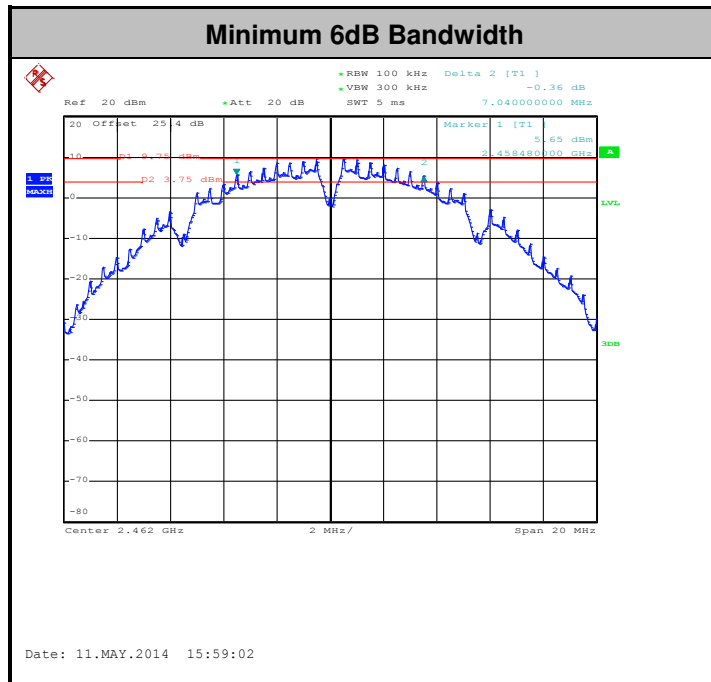

Note: The occupied channel bandwidth is maintained within the band of operation for all of the modulations.

3.2 Output Power Measurement

3.2.1 Limit of Output Power

For systems using digital modulation in the 2400-2483.5MHz, the limit for peak output power is 30dBm. If transmitting Antenna of directional gain greater than 6dBi are used the peak output power from the intentional radiator shall be reduced below the above stated value by the amount in dB that the directional gain of the Antenna exceeds 6 dBi. In case of point-to-point operation, the limit has to be reduced by 1dB for every 3dB that the directional gain of the Antenna exceeds 6dBi.

3.2.2 Measuring Instruments

The measuring equipment is listed in the section 4 of this test report.

3.2.3 Test Procedures

1. The testing follows the Measurement Procedure of FCC KDB No. 558074 DTS D01 Meas. Guidance v03r02.
2. The RF output of EUT was connected to the power meter by RF cable and attenuator. The path loss was compensated to the results for each measurement.
3. Set to the maximum power setting and enable the EUT transmit continuously.
4. Measure the conducted output power and record the results in the test report.

3.2.4 Test Setup

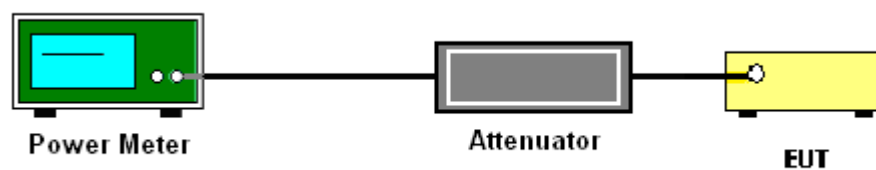



3.2.5 Test Result of Peak Output Power

| | | | |
|-----------------|----------|---------------------|---------|
| Test Mode : | 2.4GHz | Temperature : | 24~26°C |
| Test Engineer : | Alex Lee | Relative Humidity : | 45~49% |

| Mod. | Data Rate | N _{TX} | Channel | Freq. (MHz) | RF Output Power (dBm) | Power Limit (dBm) | DG (dBi) | Pass/Fail |
|------|-----------|-----------------|---------|-------------|-----------------------|-------------------|----------|-----------|
| 11b | 1Mbps | 1 | 1 | 2412 | 20.47 | 30 | 1.80 | Pass |
| 11b | 1Mbps | 1 | 6 | 2437 | 20.65 | 30 | 1.80 | Pass |
| 11b | 1Mbps | 1 | 11 | 2462 | 20.62 | 30 | 1.80 | Pass |
| 11g | 6Mbps | 1 | 1 | 2412 | 21.08 | 30 | 1.80 | Pass |
| 11g | 6Mbps | 1 | 6 | 2437 | 23.02 | 30 | 1.80 | Pass |
| 11g | 6Mbps | 1 | 11 | 2462 | 20.15 | 30 | 1.80 | Pass |
| HT20 | MCS0 | 1 | 1 | 2412 | 20.31 | 30 | 1.80 | Pass |
| HT20 | MCS0 | 1 | 6 | 2437 | 23.02 | 30 | 1.80 | Pass |
| HT20 | MCS0 | 1 | 11 | 2462 | 20.01 | 30 | 1.80 | Pass |

Note: Measured power (dBm) has offset with cable loss.



3.2.6 Test Result of Average output Power (Reporting Only)

| | | | |
|-----------------|----------|---------------------|---------|
| Test Mode : | 2.4GHz | Temperature : | 24~26°C |
| Test Engineer : | Alex Lee | Relative Humidity : | 45~49% |

| Mod. | Data Rate | N _{TX} | Channel | Freq. (MHz) | Duty Factor (dB) | Average Output Power (dBm) | Power Limit (dBm) | DG (dBi) | Pass/Fail |
|------|-----------|-----------------|---------|-------------|------------------|----------------------------|-------------------|----------|-----------|
| 11b | 1Mbps | 1 | 1 | 2412 | 0.10 | 17.86 | 30 | 1.80 | Pass |
| 11b | 1Mbps | 1 | 6 | 2437 | 0.10 | 17.96 | 30 | 1.80 | Pass |
| 11b | 1Mbps | 1 | 11 | 2462 | 0.10 | 18.00 | 30 | 1.80 | Pass |
| 11g | 6Mbps | 1 | 1 | 2412 | 0.59 | 11.93 | 30 | 1.80 | Pass |
| 11g | 6Mbps | 1 | 6 | 2437 | 0.59 | 15.95 | 30 | 1.80 | Pass |
| 11g | 6Mbps | 1 | 11 | 2462 | 0.59 | 11.05 | 30 | 1.80 | Pass |
| HT20 | MCS0 | 1 | 1 | 2412 | 0.63 | 10.83 | 30 | 1.80 | Pass |
| HT20 | MCS0 | 1 | 6 | 2437 | 0.63 | 15.94 | 30 | 1.80 | Pass |
| HT20 | MCS0 | 1 | 11 | 2462 | 0.63 | 10.57 | 30 | 1.80 | Pass |

Note: Measured power (dBm) has offset with cable loss and duty factor.

3.3 Power Spectral Density Measurement

3.3.1 Limit of Power Spectral Density

The peak power spectral density shall not be greater than 8dBm in any 3kHz band at any time interval of continuous transmission.

3.3.2 Measuring Instruments

The measuring equipment is listed in the section 4 of this test report.

3.3.3 Test Procedures

1. The testing follows Measurement Procedure 10.2 Method PKPSD of FCC KDB Publication No. 558074 D01 DTS Meas. Guidance v03r02
2. The RF output of EUT was connected to the spectrum analyzer by RF cable and attenuator. The path loss was compensated to the results for each measurement.
3. Set to the maximum power setting and enable the EUT transmit continuously.
4. Make the measurement with the spectrum analyzer's resolution bandwidth (RBW) = 3 kHz. Video bandwidth VBW = 10 kHz In order to make an accurate measurement, set the span to 1.5 times DTS Channel Bandwidth. (6dB BW)
5. Detector = peak, Sweep time = auto couple, Trace mode = max hold, Allow trace to fully stabilize. Use the peak marker function to determine the maximum power level.
6. Measure and record the results in the test report.

3.3.4 Test Setup

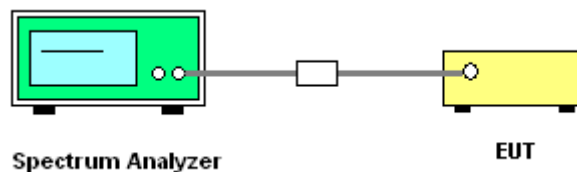



3.3.5 Test Result of Power Spectral Density

| | | | |
|-----------------|----------|---------------------|---------|
| Test Mode : | 2.4GHz | Temperature : | 24~26°C |
| Test Engineer : | Alex Lee | Relative Humidity : | 45~49% |

| Mod. | Data Rate | N _{TX} | Channel | Freq. (MHz) | Peak Power Density (dBm/3kHz) | Max. Limits (dBm/3kHz) | DG (dBi) | Pass/Fail |
|------|-----------|-----------------|---------|-------------|-------------------------------|------------------------|----------|-----------|
| 11b | 1Mbps | 1 | 1 | 2412 | -3.18 | 8 | 1.80 | Pass |
| 11b | 1Mbps | 1 | 6 | 2437 | -4.91 | 8 | 1.80 | Pass |
| 11b | 1Mbps | 1 | 11 | 2462 | -4.56 | 8 | 1.80 | Pass |
| 11g | 6Mbps | 1 | 1 | 2412 | -13.34 | 8 | 1.80 | Pass |
| 11g | 6Mbps | 1 | 6 | 2437 | -10.24 | 8 | 1.80 | Pass |
| 11g | 6Mbps | 1 | 11 | 2462 | -14.14 | 8 | 1.80 | Pass |
| HT20 | MCS0 | 1 | 1 | 2412 | -14.13 | 8 | 1.80 | Pass |
| HT20 | MCS0 | 1 | 6 | 2437 | -9.27 | 8 | 1.80 | Pass |
| HT20 | MCS0 | 1 | 11 | 2462 | -15.00 | 8 | 1.80 | Pass |

Note: Measured power density (dBm) has offset with cable loss.

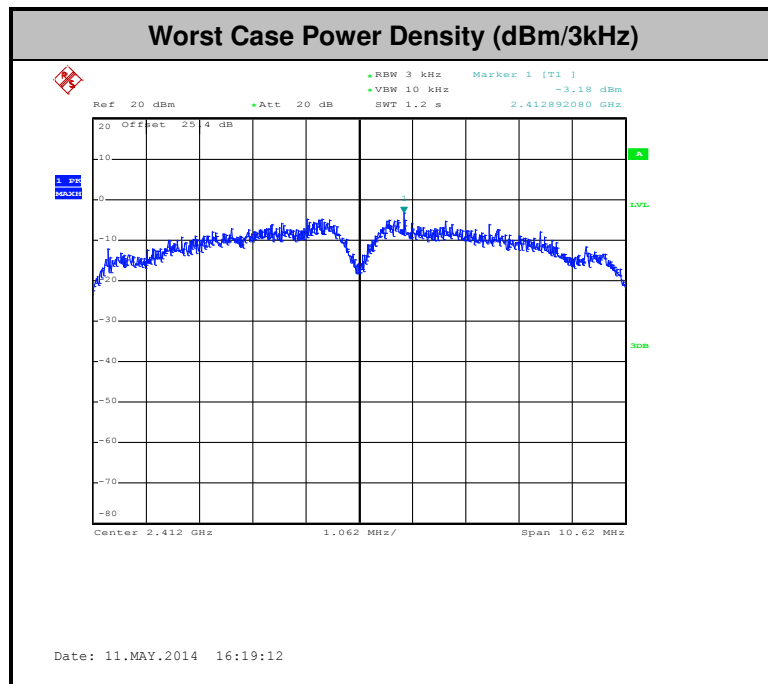

3.4 Conducted Band Edges and Spurious Emission Measurement

3.4.1 Limit of Conducted Band Edges and Spurious Emission Measurement

In any 100 kHz bandwidth outside of the authorized frequency band, the emissions which fall in the non-restricted bands shall be attenuated at least 20 dB / 30dB relative to the maximum PSD level in 100 kHz by RF conducted measurement and radiated emissions which fall in the restricted bands, as defined in Section 15.205(a), must also comply with the radiated emission limits specified in Section 15.209(a).

3.4.2 Measuring Instruments

The measuring equipment is listed in the section 4 of this test report.

3.4.3 Test Procedures

1. The testing follows FCC KDB Publication No. 558074 D01 DTS Meas. Guidance v03r02.
2. The RF output of EUT was connected to the spectrum analyzer by RF cable and attenuator. The path loss was compensated to the results for each measurement.
3. Set to the maximum power setting and enable the EUT transmit continuously.
4. Set RBW = 100 kHz, VBW=300 kHz, Peak Detector. Unwanted Emissions measured in any 100 kHz bandwidth outside of the authorized frequency band shall be attenuated by at least 20 dB relative to the maximum in-band peak PSD level in 100 kHz when maximum peak conducted output power procedure is used. If the transmitter complies with the conducted power limits based on the use of RMS averaging over a time interval, the attenuation required under this paragraph shall be 30 dB instead of 20 dB per 15.247(d).
5. Measure and record the results in the test report.
6. The RF fundamental frequency should be excluded against the limit line in the operating frequency band.

3.4.4 Test Setup

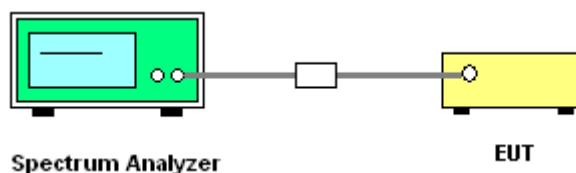



3.4.5 Test Result of Conducted Band Edges and Spurious Emission

| | | | |
|----------------|------------|---------------------|----------|
| Test Mode : | 802.11b | Temperature : | 24~26°C |
| Test Band : | 2.4GHz Low | Relative Humidity : | 45~49% |
| Test Channel : | 01 | Test Engineer : | Alex Lee |

WLAN 802.11b Channel 01

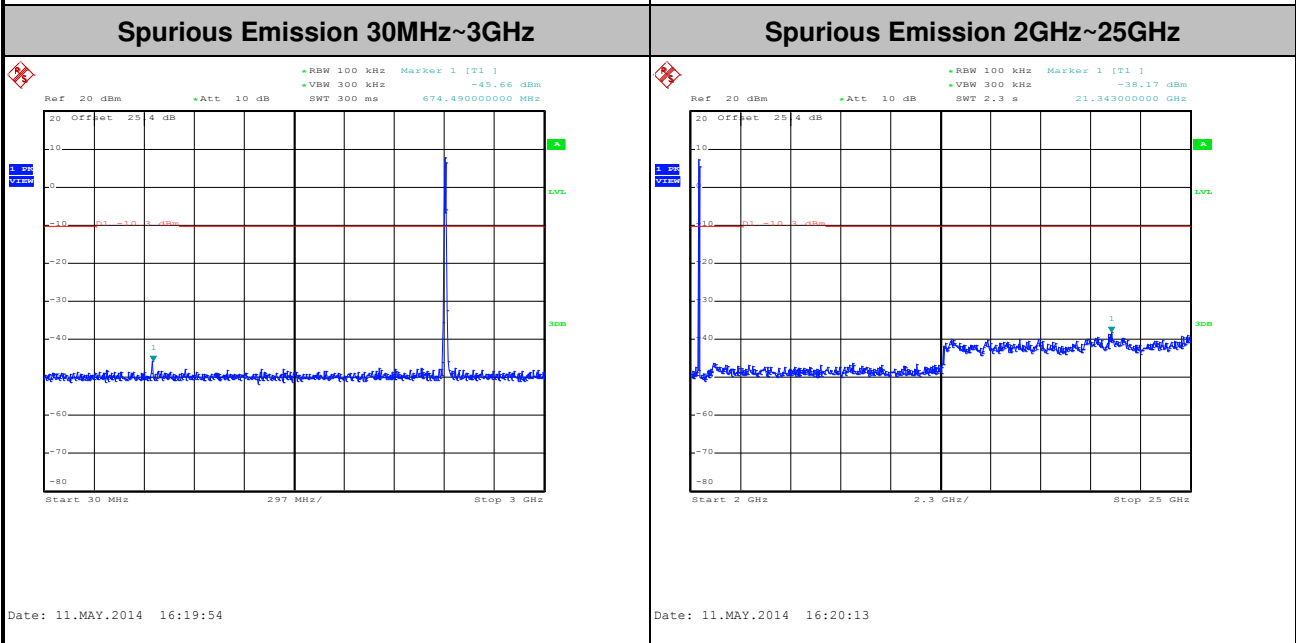
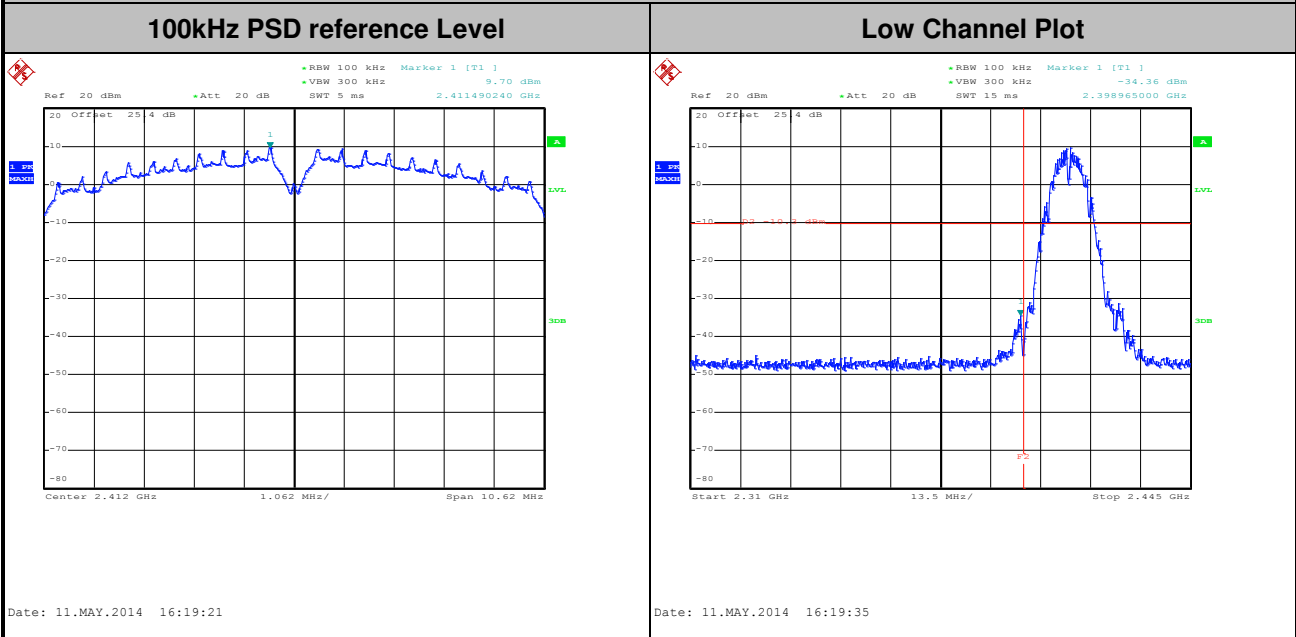



| | | | |
|----------------|------------|---------------------|----------|
| Test Mode : | 802.11b | Temperature : | 24~26°C |
| Test Band : | 2.4GHz Mid | Relative Humidity : | 45~49% |
| Test Channel : | 06 | Test Engineer : | Alex Lee |

WLAN 802.11b Channel 06

100kHz PSD reference Level

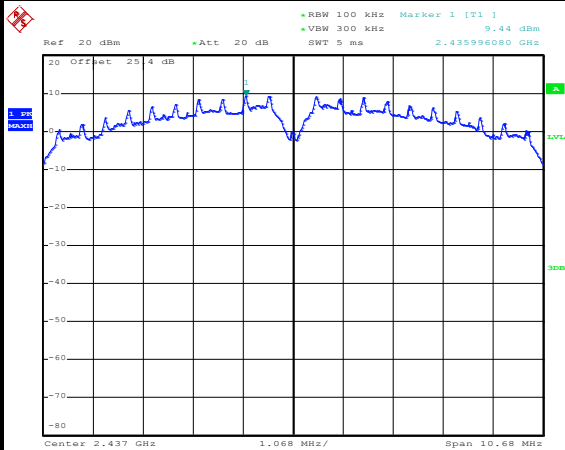

Date: 11.MAY.2014 15:57:21

Spurious Emission 30MHz~3GHz

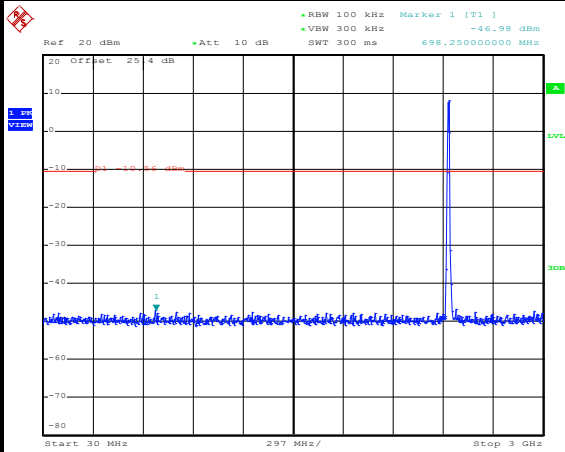

Date: 11.MAY.2014 15:57:40

Spurious Emission 2GHz~25GHz

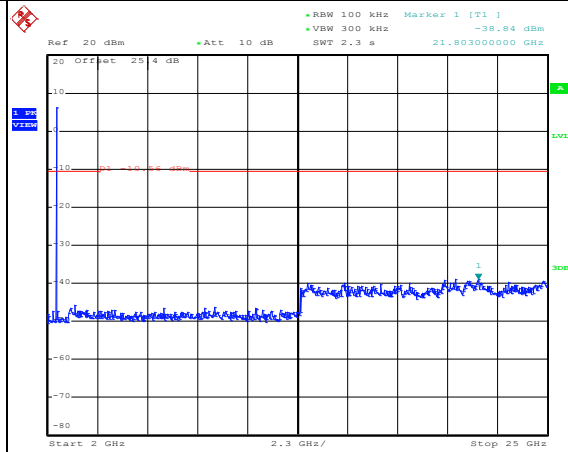

Date: 11.MAY.2014 15:57:59



| | | | |
|----------------|-------------|---------------------|----------|
| Test Mode : | 802.11b | Temperature : | 24~26°C |
| Test Band : | 2.4GHz High | Relative Humidity : | 45~49% |
| Test Channel : | 11 | Test Engineer : | Alex Lee |

WLAN 802.11b Channel 11

100kHz PSD reference Level

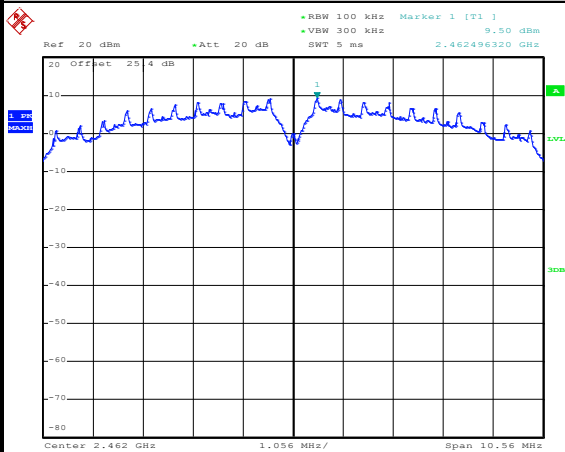

Date: 11.MAY.2014 15:59:31

High Channel Plot

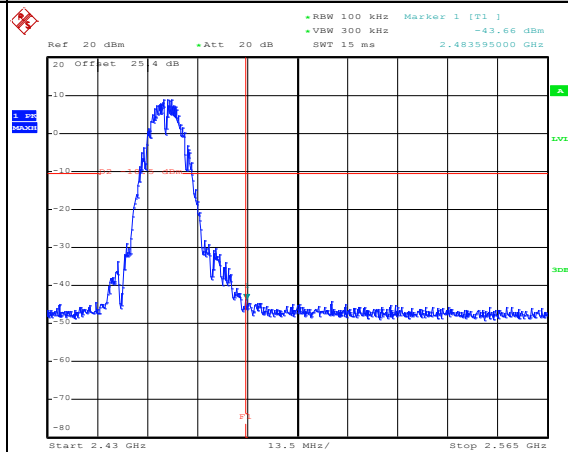

Date: 11.MAY.2014 15:59:45

Spurious Emission 30MHz~3GHz

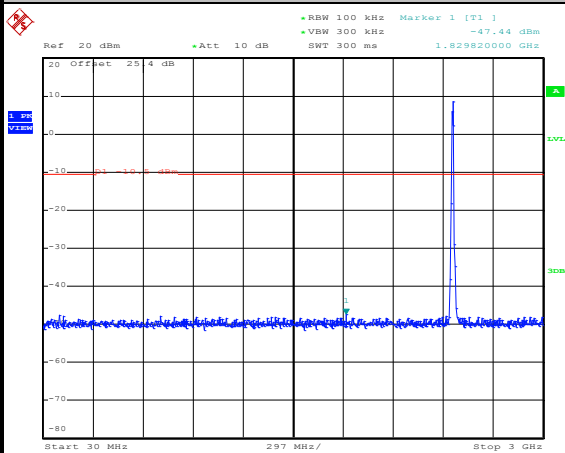

Date: 11.MAY.2014 16:00:04

Spurious Emission 2GHz~25GHz

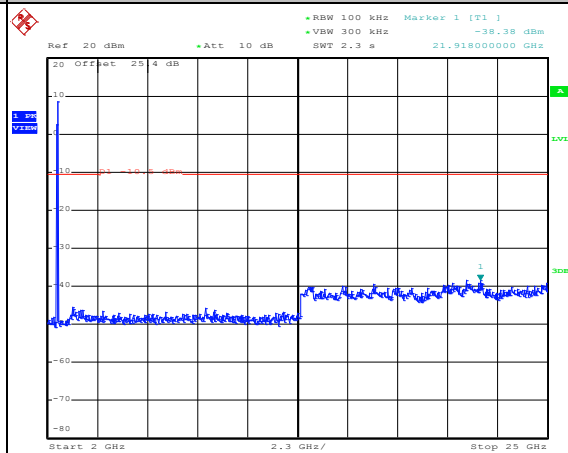

Date: 11.MAY.2014 16:00:23



| | | | |
|----------------|------------|---------------------|----------|
| Test Mode : | 802.11g | Temperature : | 24~26°C |
| Test Band : | 2.4GHz Low | Relative Humidity : | 45~49% |
| Test Channel : | 01 | Test Engineer : | Alex Lee |

WLAN 802.11g Channel 01

100kHz PSD reference Level

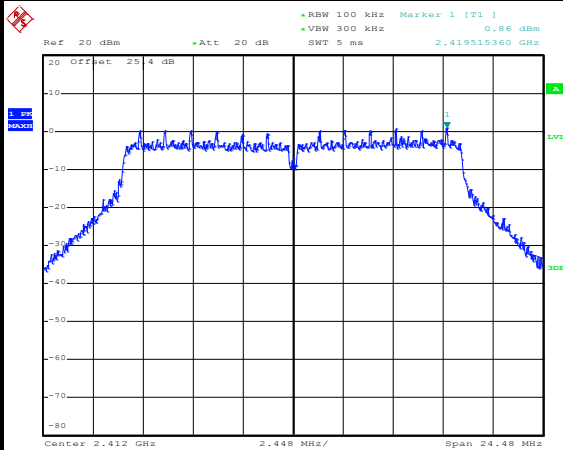

Date: 20.JUN.2014 13:48:26

Low Channel Plot

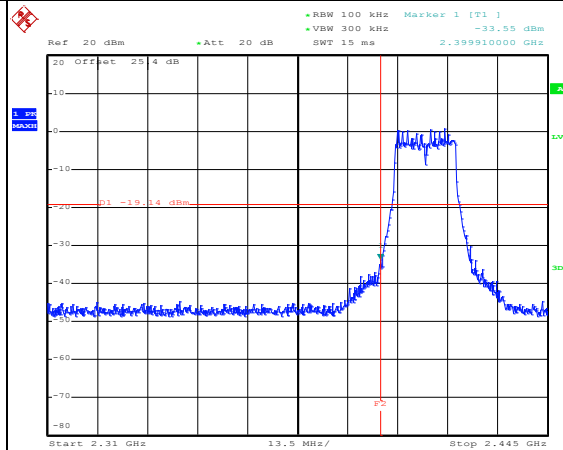

Date: 20.JUN.2014 15:09:17

Spurious Emission 30MHz~3GHz

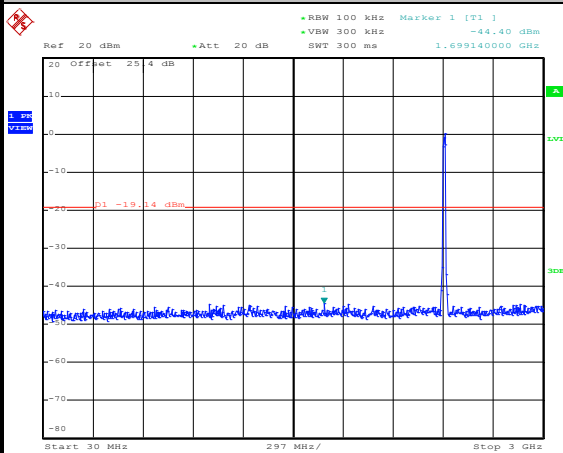

Date: 20.JUN.2014 13:49:22

Spurious Emission 2GHz~25GHz

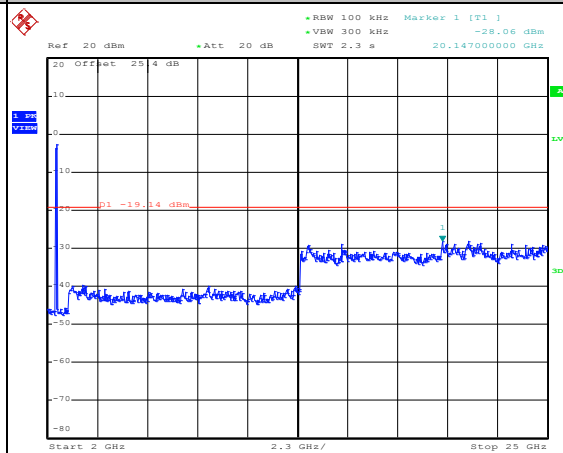

Date: 20.JUN.2014 13:49:40



| | | | |
|----------------|------------|---------------------|----------|
| Test Mode : | 802.11g | Temperature : | 24~26°C |
| Test Band : | 2.4GHz Mid | Relative Humidity : | 45~49% |
| Test Channel : | 06 | Test Engineer : | Alex Lee |

WLAN 802.11g Channel 06

100kHz PSD reference Level

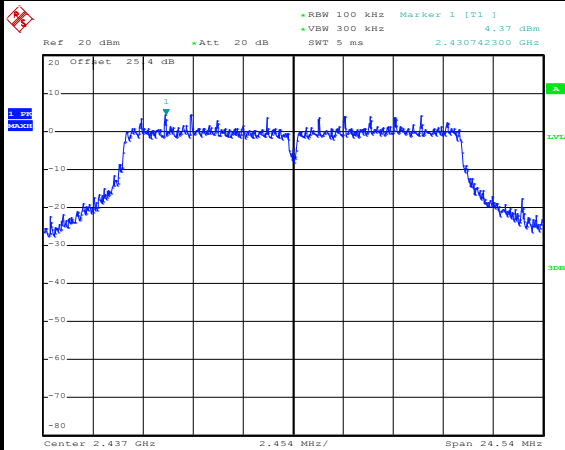

Date: 11.MAY.2014 16:04:43

Spurious Emission 30MHz~3GHz

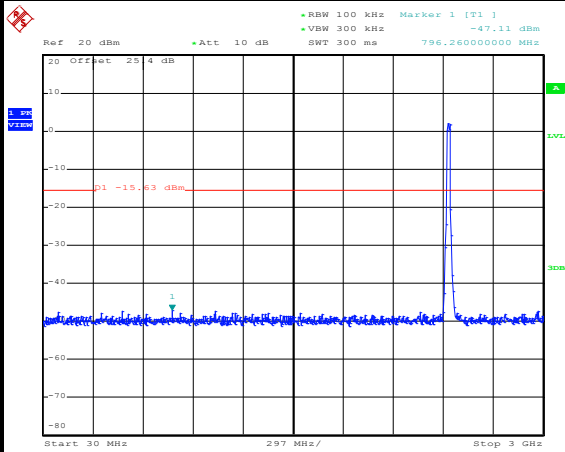

Date: 11.MAY.2014 16:05:03

Spurious Emission 2GHz~25GHz

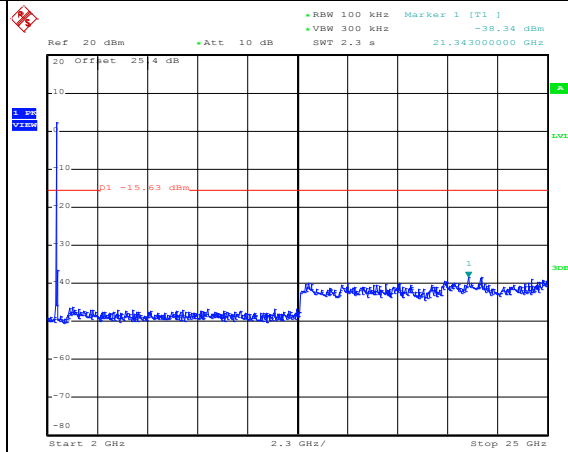

Date: 11.MAY.2014 16:05:22



| | | | |
|----------------|-------------|---------------------|----------|
| Test Mode : | 802.11g | Temperature : | 24~26°C |
| Test Band : | 2.4GHz High | Relative Humidity : | 45~49% |
| Test Channel : | 11 | Test Engineer : | Alex Lee |

WLAN 802.11g Channel 11

100kHz PSD reference Level

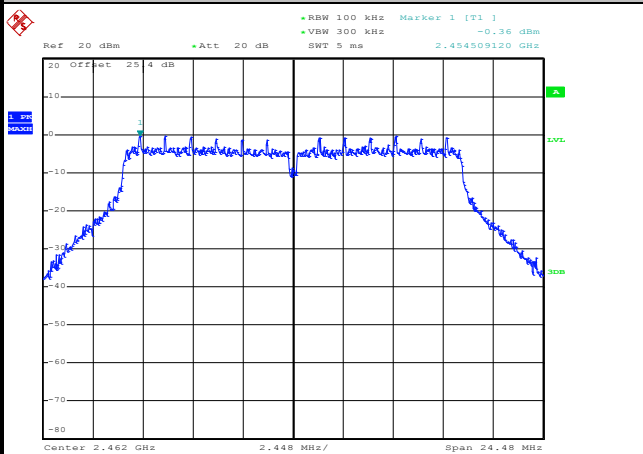

Date: 20.JUN.2014 13:58:16

High Channel Plot

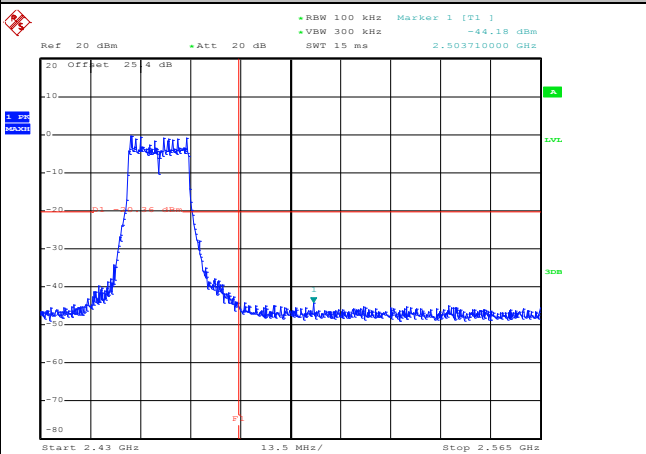

Date: 20.JUN.2014 15:08:05

Spurious Emission 30MHz~3GHz

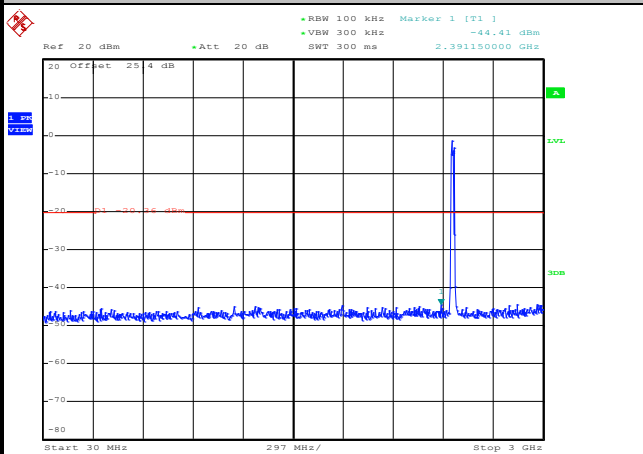

Date: 20.JUN.2014 14:06:41

Spurious Emission 2GHz~25GHz

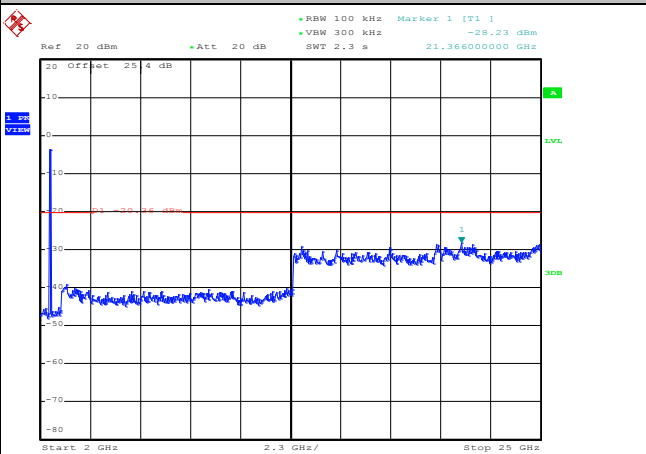

Date: 20.JUN.2014 14:06:59



| | | | |
|----------------|--------------|---------------------|----------|
| Test Mode : | 802.11n HT20 | Temperature : | 24~26°C |
| Test Band : | 2.4GHz Low | Relative Humidity : | 45~49% |
| Test Channel : | 01 | Test Engineer : | Alex Lee |

WLAN 802.11n HT20 Channel 01

100kHz PSD reference Level

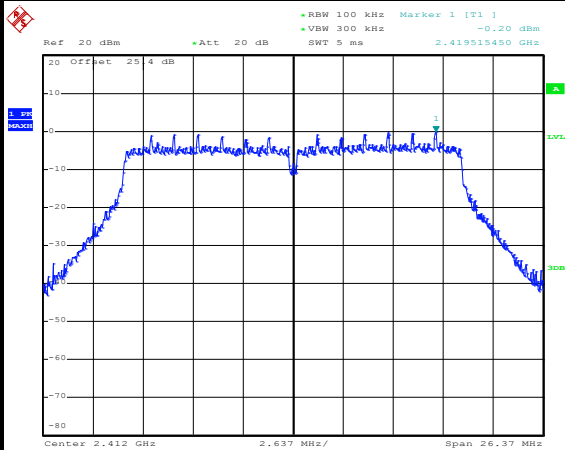

Date: 20.JUN.2014 14:56:34

Low Channel Plot

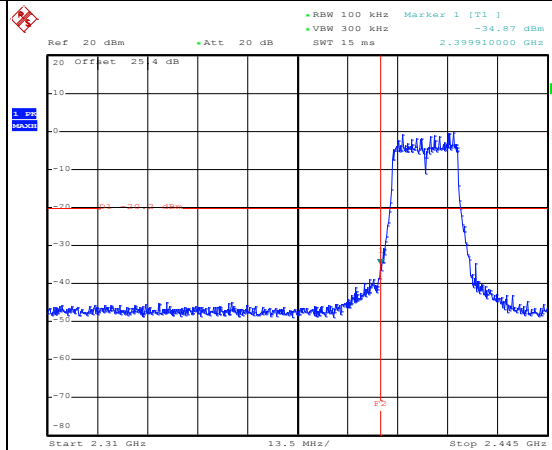

Date: 20.JUN.2014 14:56:54

Spurious Emission 30MHz~3GHz

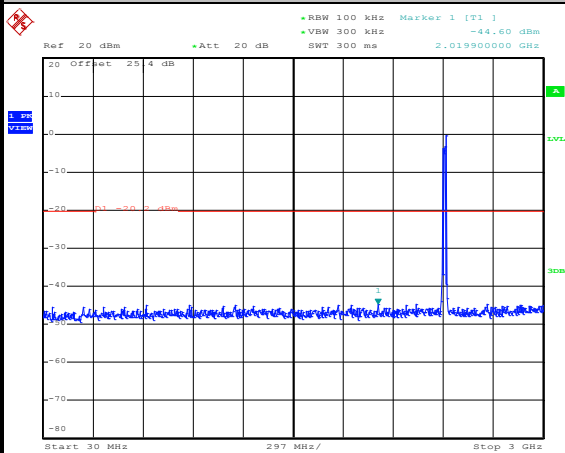

Date: 20.JUN.2014 14:57:16

Spurious Emission 2GHz~25GHz

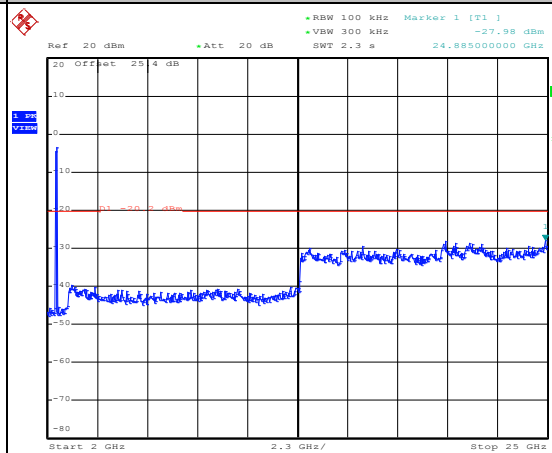

Date: 20.JUN.2014 14:57:34



| | | | |
|----------------|--------------|---------------------|----------|
| Test Mode : | 802.11n HT20 | Temperature : | 24~26°C |
| Test Band : | 2.4GHz Mid | Relative Humidity : | 45~49% |
| Test Channel : | 06 | Test Engineer : | Alex Lee |

WLAN 802.11n HT20 Channel 06

100kHz PSD reference Level

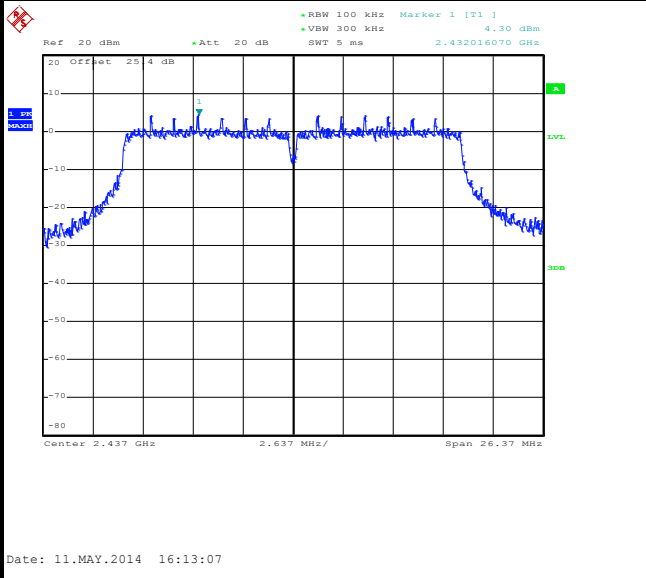

Spurious Emission 30MHz~3GHz

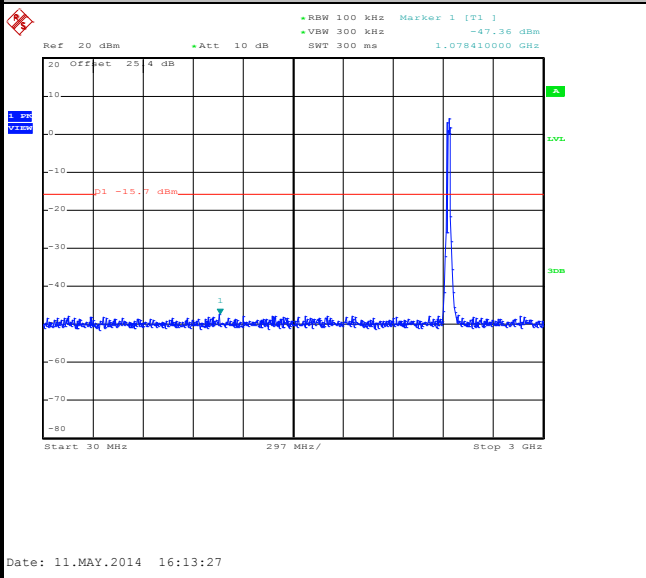

Spurious Emission 2GHz~25GHz

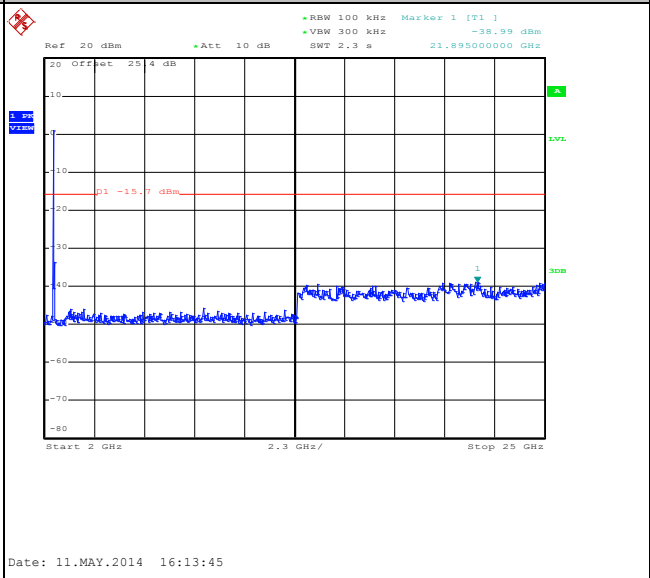



| | | | |
|----------------|--------------|---------------------|----------|
| Test Mode : | 802.11n HT20 | Temperature : | 24~26°C |
| Test Band : | 2.4GHz High | Relative Humidity : | 45~49% |
| Test Channel : | 11 | Test Engineer : | Alex Lee |

WLAN 802.11n HT20 Channel 11

100kHz PSD reference Level

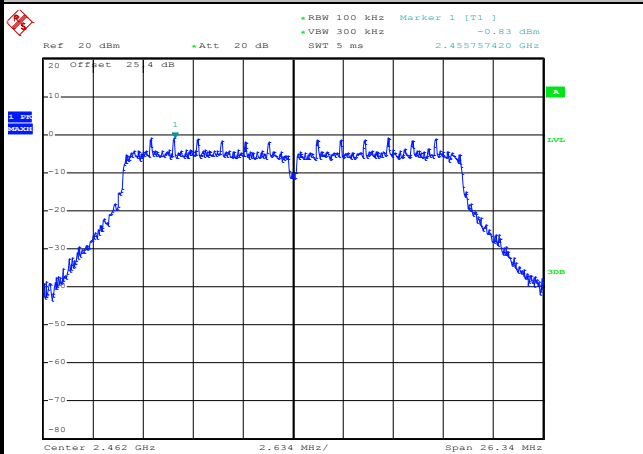

Date: 20.JUN.2014 14:26:00

High Channel Plot

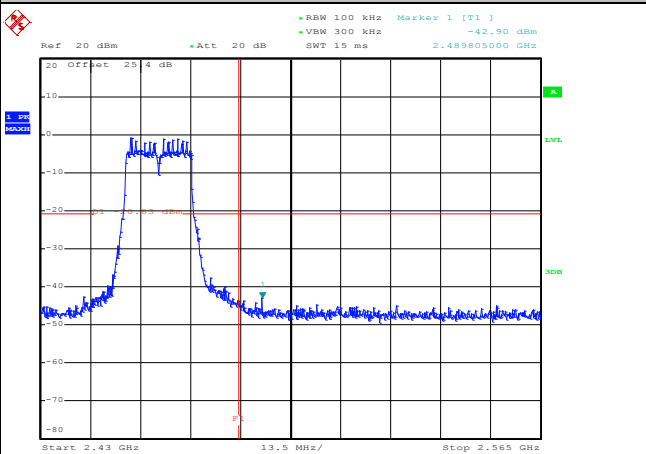

Date: 20.JUN.2014 14:34:09

Spurious Emission 30MHz~3GHz

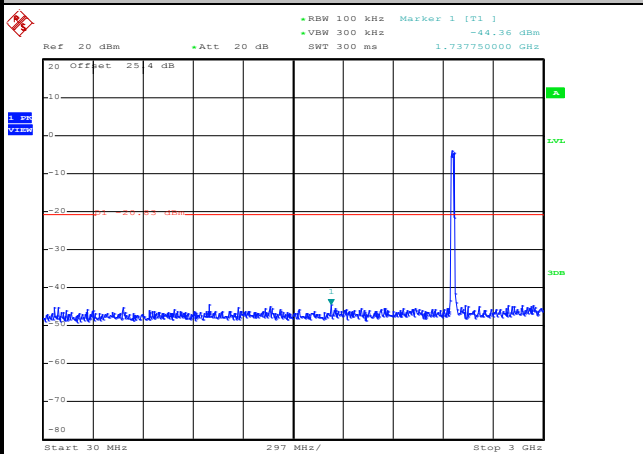

Date: 20.JUN.2014 14:30:37

Spurious Emission 2GHz~25GHz

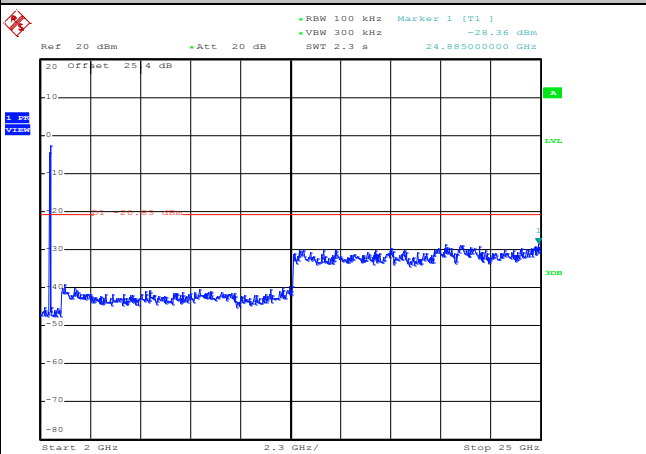

Date: 20.JUN.2014 14:30:55



3.5 Radiated Band Edges and Spurious Emission Measurement

3.5.1 Limit of Radiated band edge and Spurious Emission Measurement

In any 100 kHz bandwidth outside the intentional radiator frequency band, all harmonics/spurious must be at least 20 dB below the highest emission level within the authorized band. If the output power of this device was measured by spectrum analyzer, the attenuation under this paragraph shall be 30 dB instead of 20 dB. In addition, radiated emissions which fall in the restricted bands must also comply with the FCC section 15.209 limits as below.

| Frequency (MHz) | Field Strength (microvolts/meter) | Measurement Distance (meters) |
|-----------------|-----------------------------------|-------------------------------|
| 0.009 – 0.490 | 2400/F(kHz) | 300 |
| 0.490 – 1.705 | 24000/F(kHz) | 30 |
| 1.705 – 30.0 | 30 | 30 |
| 30 – 88 | 100 | 3 |
| 88 – 216 | 150 | 3 |
| 216 - 960 | 200 | 3 |
| Above 960 | 500 | 3 |

3.5.2 Measuring Instruments

The measuring equipment is listed in the section 4 of this test report.



3.5.3 Test Procedures

1. The testing follows FCC KDB Publication No. 558074 D01 DTS Meas. Guidance v03r02.
2. The EUT was arranged to its worst case and then tune the antenna tower (from 1 m to 4 m) and turntable (from 0 degree to 360 degrees) to find the maximum reading. A pre-amp and a high pass filter are used for the test in order to get better signal level.
3. The EUT was placed on a turntable with 0.8 meter above ground.
4. The EUT was set 3 meters from the interference receiving antenna, which was mounted on the top of a variable height antenna tower.
5. Corrected Reading: Antenna Factor + Cable Loss + Read Level - Preamp Factor = Level
6. For measurement below 1GHz, If the emission level of the EUT measured by the peak detector is 3 dB lower than the applicable limit, the peak emission level will be reported. Otherwise, the emission measurement will be repeated using the quasi-peak detector and reported.
7. Use the following spectrum analyzer settings:
 - (1) Span shall wide enough to fully capture the emission being measured;
 - (2) Set RBW=100 kHz for $f < 1$ GHz; $VBW \geq RBW$; Sweep = auto; Detector function = peak; Trace = max hold;
 - (3) Set RBW = 1 MHz, VBW= 3MHz for $f \geq 1$ GHz for peak measurement.

For average measurement:

 - $VBW = 10$ Hz, when duty cycle is no less than 98 percent.
 - $VBW \geq 1/T$, when duty cycle is less than 98 percent where T is the minimum transmission duration over which the transmitter is on and is transmitting at its maximum power control level for the tested mode of operation.

| Band | Duty Cycle(%) | T(μ s) | 1/T(kHz) | VBW Setting |
|--------------|---------------|-------------|----------|-------------|
| 802.11b | 97.63 | 8240 | 0.12 | 300Hz |
| 802.11g | 87.34 | 1380 | 0.72 | 1kHz |
| 802.11n HT20 | 86.49 | 1280 | 0.78 | 1kHz |

3.5.4 Test Setup

For radiated emissions below 30MHz

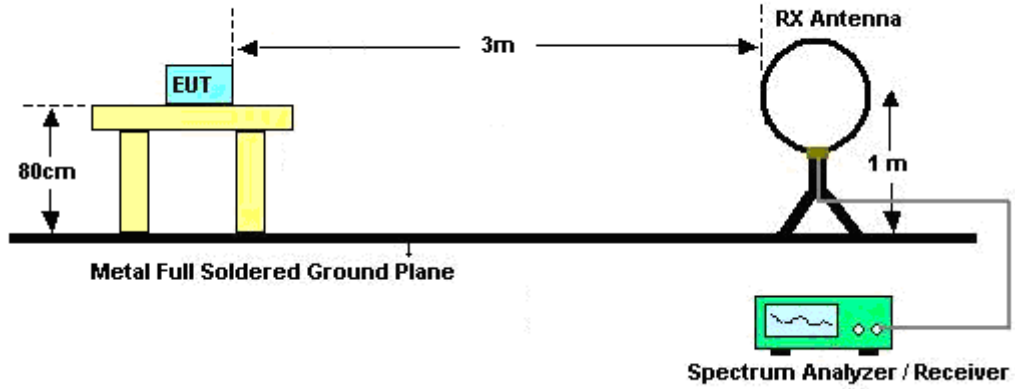

For radiated emissions from 30MHz to 1GHz

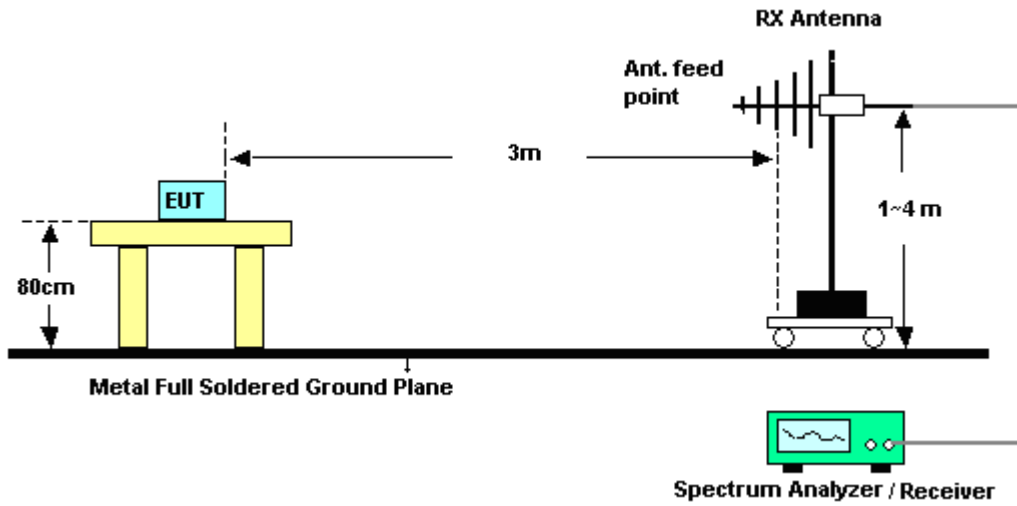

For radiated emissions above 1GHz

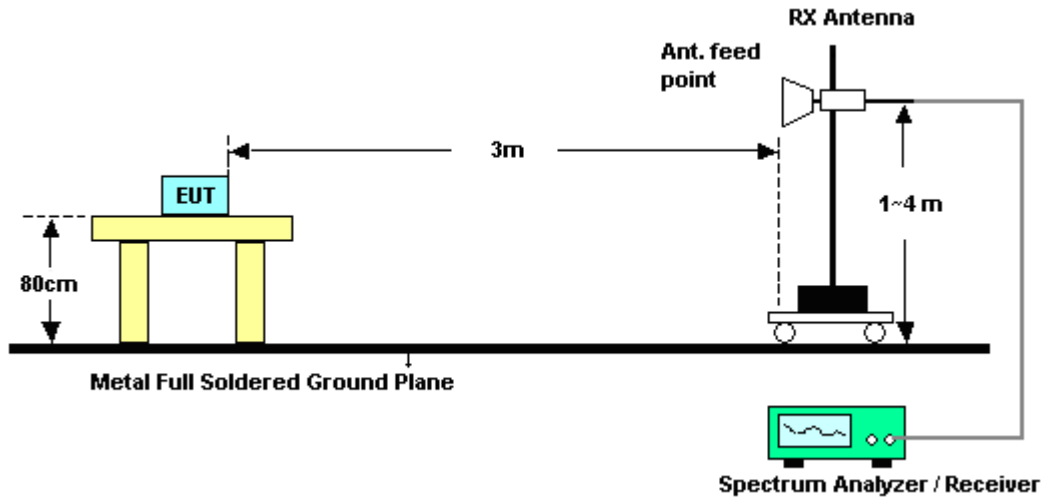

3.5.5 Test Results of Radiated Spurious Emissions (9kHz ~ 30MHz)

The low frequency, which started from 9 kHz to 30MHz, was pre-scanned and the result which was 20dB lower than the limit line per 15.31(o) was not reported.



3.5.6 Test Result of Radiated Spurious at Band Edges

| | | | |
|----------------|---------|---------------------|---------|
| Test Mode : | 802.11b | Temperature : | 24~25°C |
| Test Band : | Low | Relative Humidity : | 46~47% |
| Test Channel : | 01 | Test Engineer : | Abi Lin |

| ANTENNA POLARITY : HORIZONTAL | | | | | | | | | | |
|-------------------------------|---------------------|-------------------------|-----------------------------|---------------------------|-----------------------------|-------------------------|----------------------------|----------------------|-------------------------|---------|
| Frequency (MHz) | Level (dBµV/m) | Over Limit (dB) | Limit Line (dBµV/m) | Read Level (dBµV) | Antenna Factor (dB) | Cable Loss (dB) | Preamp Factor (dB) | Ant Pos (cm) | Table Pos (deg) | Remark |
| 2389.29 | 50.28 | -23.72 | 74 | 46.56 | 31.92 | 6.45 | 34.65 | 146 | 347 | Peak |
| 2390 | 38.95 | -15.05 | 54 | 35.22 | 31.92 | 6.45 | 34.64 | 146 | 347 | Average |

| ANTENNA POLARITY : VERTICAL | | | | | | | | | | |
|-----------------------------|---------------------|-------------------------|-----------------------------|---------------------------|-----------------------------|-------------------------|----------------------------|----------------------|-------------------------|---------|
| Frequency (MHz) | Level (dBµV/m) | Over Limit (dB) | Limit Line (dBµV/m) | Read Level (dBµV) | Antenna Factor (dB) | Cable Loss (dB) | Preamp Factor (dB) | Ant Pos (cm) | Table Pos (deg) | Remark |
| 2389.74 | 50.89 | -23.11 | 74 | 47.17 | 31.92 | 6.45 | 34.65 | 100 | 307 | Peak |
| 2389.83 | 39.63 | -14.37 | 54 | 35.9 | 31.92 | 6.45 | 34.64 | 100 | 307 | Average |

| | | | |
|----------------|---------|---------------------|---------|
| Test Mode : | 802.11b | Temperature : | 24~25°C |
| Test Band : | High | Relative Humidity : | 46~47% |
| Test Channel : | 11 | Test Engineer : | Abi Lin |

| ANTENNA POLARITY : HORIZONTAL | | | | | | | | | | |
|-------------------------------|---------------------|-------------------------|-----------------------------|---------------------------|-----------------------------|-------------------------|----------------------------|----------------------|-------------------------|---------|
| Frequency (MHz) | Level (dBµV/m) | Over Limit (dB) | Limit Line (dBµV/m) | Read Level (dBµV) | Antenna Factor (dB) | Cable Loss (dB) | Preamp Factor (dB) | Ant Pos (cm) | Table Pos (deg) | Remark |
| 2483.83 | 54.01 | -19.99 | 74 | 50.06 | 31.99 | 6.59 | 34.63 | 142 | 142 | Peak |
| 2486.71 | 43.73 | -10.27 | 54 | 39.78 | 31.99 | 6.59 | 34.63 | 142 | 142 | Average |

| ANTENNA POLARITY : VERTICAL | | | | | | | | | | |
|-----------------------------|---------------------|-------------------------|-----------------------------|---------------------------|-----------------------------|-------------------------|----------------------------|----------------------|-------------------------|---------|
| Frequency (MHz) | Level (dBµV/m) | Over Limit (dB) | Limit Line (dBµV/m) | Read Level (dBµV) | Antenna Factor (dB) | Cable Loss (dB) | Preamp Factor (dB) | Ant Pos (cm) | Table Pos (deg) | Remark |
| 2486.68 | 53.15 | -20.85 | 74 | 49.2 | 31.99 | 6.59 | 34.63 | 100 | 347 | Peak |
| 2486.89 | 42.61 | -11.39 | 54 | 38.66 | 31.99 | 6.59 | 34.63 | 100 | 347 | Average |



| | | | |
|----------------|---------|---------------------|---------|
| Test Mode : | 802.11g | Temperature : | 24~25°C |
| Test Band : | Low | Relative Humidity : | 46~47% |
| Test Channel : | 01 | Test Engineer : | Abi Lin |

| ANTENNA POLARITY : HORIZONTAL | | | | | | | | | | |
|-------------------------------|---------------------|-------------------------|-----------------------------|---------------------------|-----------------------------|-------------------------|----------------------------|----------------------|-------------------------|---------|
| Frequency (MHz) | Level (dBμV/m) | Over Limit (dB) | Limit Line (dBμV/m) | Read Level (dBμV) | Antenna Factor (dB) | Cable Loss (dB) | Preamp Factor (dB) | Ant Pos (cm) | Table Pos (deg) | Remark |
| 2389.56 | 70.25 | -3.75 | 74 | 66.53 | 31.92 | 6.45 | 34.65 | 146 | 140 | Peak |
| 2390 | 47.56 | -6.44 | 54 | 43.83 | 31.92 | 6.45 | 34.64 | 146 | 140 | Average |

| ANTENNA POLARITY : VERTICAL | | | | | | | | | | |
|-----------------------------|---------------------|-------------------------|-----------------------------|---------------------------|-----------------------------|-------------------------|----------------------------|----------------------|-------------------------|---------|
| Frequency (MHz) | Level (dBμV/m) | Over Limit (dB) | Limit Line (dBμV/m) | Read Level (dBμV) | Antenna Factor (dB) | Cable Loss (dB) | Preamp Factor (dB) | Ant Pos (cm) | Table Pos (deg) | Remark |
| 2389.83 | 72.57 | -1.43 | 74 | 68.84 | 31.92 | 6.45 | 34.64 | 100 | 312 | Peak |
| 2390 | 50.28 | -3.72 | 54 | 46.55 | 31.92 | 6.45 | 34.64 | 100 | 312 | Average |

| | | | |
|----------------|---------|---------------------|---------|
| Test Mode : | 802.11g | Temperature : | 24~25°C |
| Test Band : | High | Relative Humidity : | 46~47% |
| Test Channel : | 11 | Test Engineer : | Abi Lin |

| ANTENNA POLARITY : HORIZONTAL | | | | | | | | | | |
|-------------------------------|---------------------|-------------------------|-----------------------------|---------------------------|-----------------------------|-------------------------|----------------------------|----------------------|-------------------------|---------|
| Frequency (MHz) | Level (dBμV/m) | Over Limit (dB) | Limit Line (dBμV/m) | Read Level (dBμV) | Antenna Factor (dB) | Cable Loss (dB) | Preamp Factor (dB) | Ant Pos (cm) | Table Pos (deg) | Remark |
| 2484.04 | 69.09 | -4.91 | 74 | 65.14 | 31.99 | 6.59 | 34.63 | 115 | 140 | Peak |
| 2483.5 | 48.91 | -5.09 | 54 | 44.96 | 31.99 | 6.59 | 34.63 | 115 | 140 | Average |

| ANTENNA POLARITY : VERTICAL | | | | | | | | | | |
|-----------------------------|---------------------|-------------------------|-----------------------------|---------------------------|-----------------------------|-------------------------|----------------------------|----------------------|-------------------------|---------|
| Frequency (MHz) | Level (dBμV/m) | Over Limit (dB) | Limit Line (dBμV/m) | Read Level (dBμV) | Antenna Factor (dB) | Cable Loss (dB) | Preamp Factor (dB) | Ant Pos (cm) | Table Pos (deg) | Remark |
| 2483.5 | 72.99 | -1.01 | 74 | 69.04 | 31.99 | 6.59 | 34.63 | 120 | 285 | Peak |
| 2483.5 | 50.64 | -3.36 | 54 | 46.69 | 31.99 | 6.59 | 34.63 | 120 | 285 | Average |



| | | | |
|----------------|--------------|---------------------|---------|
| Test Mode : | 802.11n HT20 | Temperature : | 24~25°C |
| Test Band : | Low | Relative Humidity : | 46~47% |
| Test Channel : | 01 | Test Engineer : | Abi Lin |

| ANTENNA POLARITY : HORIZONTAL | | | | | | | | | | |
|-------------------------------|---------------------|-------------------------|-----------------------------|---------------------------|-----------------------------|-------------------------|----------------------------|----------------------|-------------------------|---------|
| Frequency (MHz) | Level (dBμV/m) | Over Limit (dB) | Limit Line (dBμV/m) | Read Level (dBμV) | Antenna Factor (dB) | Cable Loss (dB) | Preamp Factor (dB) | Ant Pos (cm) | Table Pos (deg) | Remark |
| 2388.660 | 63.83 | -10.17 | 74.00 | 60.11 | 31.92 | 6.45 | 34.65 | 152 | 314 | Peak |
| 2390.000 | 43.12 | -10.88 | 54.00 | 39.39 | 31.92 | 6.45 | 34.64 | 152 | 314 | Average |

| ANTENNA POLARITY : VERTICAL | | | | | | | | | | |
|-----------------------------|---------------------|-------------------------|-----------------------------|---------------------------|-----------------------------|-------------------------|----------------------------|----------------------|-------------------------|---------|
| Frequency (MHz) | Level (dBμV/m) | Over Limit (dB) | Limit Line (dBμV/m) | Read Level (dBμV) | Antenna Factor (dB) | Cable Loss (dB) | Preamp Factor (dB) | Ant Pos (cm) | Table Pos (deg) | Remark |
| 2389.200 | 71.93 | -2.07 | 74.00 | 68.21 | 31.92 | 6.45 | 34.65 | 100 | 120 | Peak |
| 2390.000 | 48.66 | -5.34 | 54.00 | 44.93 | 31.92 | 6.45 | 34.64 | 100 | 120 | Average |

| | | | |
|----------------|--------------|---------------------|---------|
| Test Mode : | 802.11n HT20 | Temperature : | 24~25°C |
| Test Band : | High | Relative Humidity : | 46~47% |
| Test Channel : | 11 | Test Engineer : | Abi Lin |

| ANTENNA POLARITY : HORIZONTAL | | | | | | | | | | |
|-------------------------------|---------------------|-------------------------|-----------------------------|---------------------------|-----------------------------|-------------------------|----------------------------|----------------------|-------------------------|---------|
| Frequency (MHz) | Level (dBμV/m) | Over Limit (dB) | Limit Line (dBμV/m) | Read Level (dBμV) | Antenna Factor (dB) | Cable Loss (dB) | Preamp Factor (dB) | Ant Pos (cm) | Table Pos (deg) | Remark |
| 2484.4 | 70.93 | -3.07 | 74 | 66.98 | 31.99 | 6.59 | 34.63 | 109 | 203 | Peak |
| 2483.5 | 49.3 | -4.7 | 54 | 45.35 | 31.99 | 6.59 | 34.63 | 109 | 203 | Average |

| ANTENNA POLARITY : VERTICAL | | | | | | | | | | |
|-----------------------------|---------------------|-------------------------|-----------------------------|---------------------------|-----------------------------|-------------------------|----------------------------|----------------------|-------------------------|---------|
| Frequency (MHz) | Level (dBμV/m) | Over Limit (dB) | Limit Line (dBμV/m) | Read Level (dBμV) | Antenna Factor (dB) | Cable Loss (dB) | Preamp Factor (dB) | Ant Pos (cm) | Table Pos (deg) | Remark |
| 2484.46 | 73.56 | -0.44 | 74 | 69.61 | 31.99 | 6.59 | 34.63 | 100 | 121 | Peak |
| 2483.5 | 51.6 | -2.4 | 54 | 47.65 | 31.99 | 6.59 | 34.63 | 100 | 121 | Average |



3.5.7 Test Result of Radiated Spurious Emission (30MHz ~ 10th Harmonic)

Note: Pre-scanned all test modes and only choose the worst case mode recorded in the test report for radiated spurious emission below 1GHz.

| | | | |
|------------------------|--|----------------------------|------------|
| Test Mode : | 802.11b | Temperature : | 24~25°C |
| Test Channel : | 01 | Relative Humidity : | 46~47% |
| Test Engineer : | Abi Lin | Polarization : | Horizontal |
| Remark : | 1. 2414 MHz is fundamental signal which can be ignored. 2. Average measurement was not performed if peak level went lower than the average limit. | | |

| Frequency (MHz) | Level (dBμV/m) | Over Limit (dB) | Limit Line (dBμV/m) | Read Level (dBμV) | Antenna Factor (dB) | Cable Loss (dB) | Preamp Factor (dB) | Ant Pos (cm) | Table Pos (deg) | Remark |
|-------------------|------------------|-------------------|-----------------------|---------------------|-----------------------|-------------------|----------------------|----------------|-------------------|---------|
| 2414 | 102.41 | - | - | 98.63 | 31.93 | 6.49 | 34.64 | 146 | 347 | Average |
| 2414 | 106.6 | - | - | 102.82 | 31.93 | 6.49 | 34.64 | 146 | 347 | Peak |
| 4824 | 44.82 | -29.18 | 74 | 61.06 | 34.4 | 10.17 | 60.81 | 100 | 0 | Peak |

| | | | |
|------------------------|--|----------------------------|----------|
| Test Mode : | 802.11b | Temperature : | 24~25°C |
| Test Channel : | 01 | Relative Humidity : | 46~47% |
| Test Engineer : | Abi Lin | Polarization : | Vertical |
| Remark : | 1. 2414 MHz is fundamental signal which can be ignored. 2. Average measurement was not performed if peak level went lower than the average limit. | | |

| Frequency (MHz) | Level (dBμV/m) | Over Limit (dB) | Limit Line (dBμV/m) | Read Level (dBμV) | Antenna Factor (dB) | Cable Loss (dB) | Preamp Factor (dB) | Ant Pos (cm) | Table Pos (deg) | Remark |
|-------------------|------------------|-------------------|-----------------------|---------------------|-----------------------|-------------------|----------------------|----------------|-------------------|---------|
| 2414 | 101.48 | - | - | 97.7 | 31.93 | 6.49 | 34.64 | 100 | 307 | Average |
| 2414 | 105.99 | - | - | 102.21 | 31.93 | 6.49 | 34.64 | 100 | 307 | Peak |
| 4824 | 41.86 | -32.14 | 74 | 58.1 | 34.4 | 10.17 | 60.81 | 100 | 0 | Peak |



| | | | |
|------------------------|--|----------------------------|------------|
| Test Mode : | 802.11b | Temperature : | 24~25°C |
| Test Channel : | 06 | Relative Humidity : | 46~47% |
| Test Engineer : | Abi Lin | Polarization : | Horizontal |
| Remark : | 1. 2436 MHz is fundamental signal which can be ignored. 2. Average measurement was not performed if peak level went lower than the average limit. | | |

| Frequency (MHz) | Level (dBμV/m) | Over Limit (dB) | Limit Line (dBμV/m) | Read Level (dBμV) | Antenna Factor (dB) | Cable Loss (dB) | Preamp Factor (dB) | Ant Pos (cm) | Table Pos (deg) | Remark |
|----------------------|---------------------|-------------------------|-----------------------------|---------------------------|-----------------------------|-------------------------|----------------------------|----------------------|-------------------------|---------|
| 2436 | 99.28 | - | - | 95.46 | 31.94 | 6.52 | 34.64 | 159 | 226 | Average |
| 2436 | 103.93 | - | - | 100.11 | 31.94 | 6.52 | 34.64 | 159 | 226 | Peak |
| 4875 | 46.96 | -27.04 | 74 | 63.1 | 34.37 | 10.18 | 60.69 | 100 | 0 | Peak |
| 7311 | 44.44 | -29.56 | 74 | 58.41 | 35.61 | 10.94 | 60.52 | 100 | 0 | Peak |

| | | | |
|------------------------|--|----------------------------|----------|
| Test Mode : | 802.11b | Temperature : | 24~25°C |
| Test Channel : | 06 | Relative Humidity : | 46~47% |
| Test Engineer : | Abi Lin | Polarization : | Vertical |
| Remark : | 1. 2438 MHz is fundamental signal which can be ignored. 2. Average measurement was not performed if peak level went lower than the average limit. | | |

| Frequency (MHz) | Level (dBμV/m) | Over Limit (dB) | Limit Line (dBμV/m) | Read Level (dBμV) | Antenna Factor (dB) | Cable Loss (dB) | Preamp Factor (dB) | Ant Pos (cm) | Table Pos (deg) | Remark |
|----------------------|---------------------|-------------------------|-----------------------------|---------------------------|-----------------------------|-------------------------|----------------------------|----------------------|-------------------------|---------|
| 2438 | 103.27 | - | - | 99.43 | 31.96 | 6.52 | 34.64 | 102 | 349 | Average |
| 2438 | 107.39 | - | - | 103.55 | 31.96 | 6.52 | 34.64 | 102 | 349 | Peak |
| 4875 | 47.19 | -26.81 | 74 | 63.33 | 34.37 | 10.18 | 60.69 | 100 | 0 | Peak |
| 7311 | 43.34 | -30.66 | 74 | 57.31 | 35.61 | 10.94 | 60.52 | 100 | 0 | Peak |



| | | | |
|------------------------|--|----------------------------|------------|
| Test Mode : | 802.11b | Temperature : | 24~25°C |
| Test Channel : | 11 | Relative Humidity : | 46~47% |
| Test Engineer : | Abi Lin | Polarization : | Horizontal |
| Remark : | 1. 2462 MHz is fundamental signal which can be ignored. 2. Average measurement was not performed if peak level went lower than the average limit. | | |

| Frequency (MHz) | Level (dBμV/m) | Over Limit (dB) | Limit Line (dBμV/m) | Read Level (dBμV) | Antenna Factor (dB) | Cable Loss (dB) | Preamp Factor (dB) | Ant Pos (cm) | Table Pos (deg) | Remark |
|----------------------|---------------------|-------------------------|-----------------------------|-------------------------|-----------------------------|-------------------------|----------------------------|----------------------|-------------------------|---------|
| 73.2 | 9.61 | -30.39 | 40 | 33.92 | 6.5 | 0.96 | 31.77 | - | - | Peak |
| 170.4 | 13.45 | -30.05 | 43.5 | 33.83 | 9.76 | 1.61 | 31.75 | - | - | Peak |
| 236.28 | 13 | -33 | 46 | 32.02 | 11.04 | 1.68 | 31.74 | - | - | Peak |
| 430.9 | 18.55 | -27.45 | 46 | 31.33 | 16.8 | 2.27 | 31.85 | - | - | Peak |
| 610.1 | 21.89 | -24.11 | 46 | 31.67 | 19.5 | 2.78 | 32.06 | - | - | Peak |
| 914.6 | 23.49 | -22.51 | 46 | 30.47 | 21.05 | 3.36 | 31.39 | 100 | 126 | Peak |
| 2462 | 103.16 | - | - | 99.27 | 31.97 | 6.56 | 34.64 | 142 | 142 | Average |
| 2462 | 107.68 | - | - | 103.79 | 31.97 | 6.56 | 34.64 | 142 | 142 | Peak |
| 4923 | 43.19 | -30.81 | 74 | 59.22 | 34.34 | 10.2 | 60.57 | 100 | 0 | Peak |
| 7386 | 43.46 | -30.54 | 74 | 57.54 | 35.56 | 10.92 | 60.56 | 100 | 0 | Peak |



| | | | |
|------------------------|--|----------------------------|----------|
| Test Mode : | 802.11b | Temperature : | 24~25°C |
| Test Channel : | 11 | Relative Humidity : | 46~47% |
| Test Engineer : | Abi Lin | Polarization : | Vertical |
| Remark : | 1. 2464 MHz is fundamental signal which can be ignored. 2. Average measurement was not performed if peak level went lower than the average limit. | | |

| Frequency (MHz) | Level (dBμV/m) | Over Limit (dB) | Limit Line (dBμV/m) | Read Level (dBμV) | Antenna Factor (dB) | Cable Loss (dB) | Preamp Factor (dB) | Ant Pos (cm) | Table Pos (deg) | Remark |
|----------------------|---------------------|-------------------------|-----------------------------|---------------------------|-----------------------------|-------------------------|----------------------------|----------------------|-------------------------|---------|
| 113.43 | 21.27 | -22.23 | 43.5 | 39.77 | 12.07 | 1.18 | 31.75 | - | - | Peak |
| 157.71 | 17.98 | -25.52 | 43.5 | 38.15 | 10.14 | 1.44 | 31.75 | - | - | Peak |
| 193.89 | 14.42 | -29.08 | 43.5 | 35.57 | 9.1 | 1.5 | 31.75 | - | - | Peak |
| 365.8 | 18.14 | -27.86 | 46 | 32.97 | 14.85 | 2.11 | 31.79 | - | - | Peak |
| 614.3 | 22.54 | -23.46 | 46 | 32.27 | 19.54 | 2.78 | 32.05 | - | - | Peak |
| 820.1 | 25.56 | -20.44 | 46 | 33.88 | 20.42 | 3.13 | 31.87 | 100 | 166 | Peak |
| 2464 | 103.46 | - | - | 99.57 | 31.97 | 6.56 | 34.64 | 100 | 347 | Average |
| 2464 | 107.48 | - | - | 103.59 | 31.97 | 6.56 | 34.64 | 100 | 347 | Peak |
| 4923 | 42.31 | -31.69 | 74 | 58.34 | 34.34 | 10.2 | 60.57 | 100 | 0 | Peak |
| 7386 | 43.56 | -30.44 | 74 | 57.64 | 35.56 | 10.92 | 60.56 | 100 | 0 | Peak |



| | | | |
|------------------------|--|----------------------------|------------|
| Test Mode : | 802.11g | Temperature : | 24~25°C |
| Test Channel : | 01 | Relative Humidity : | 46~47% |
| Test Engineer : | Abi Lin | Polarization : | Horizontal |
| Remark : | 1. 2410 MHz is fundamental signal which can be ignored. 2. Average measurement was not performed if peak level went lower than the average limit. | | |

| Frequency (MHz) | Level (dBμV/m) | Over Limit (dB) | Limit Line (dBμV/m) | Read Level (dBμV) | Antenna Factor (dB) | Cable Loss (dB) | Preamp Factor (dB) | Ant Pos (cm) | Table Pos (deg) | Remark |
|----------------------|---------------------|-------------------------|-----------------------------|-------------------------|-----------------------------|-------------------------|----------------------------|----------------------|-------------------------|---------|
| 2410 | 95 | - | - | 91.22 | 31.93 | 6.49 | 34.64 | 146 | 140 | Average |
| 2410 | 105.08 | - | - | 101.3 | 31.93 | 6.49 | 34.64 | 146 | 140 | Peak |
| 4824 | 40.96 | -33.04 | 74 | 57.2 | 34.4 | 10.17 | 60.81 | 100 | 0 | Peak |

| | | | |
|------------------------|--|----------------------------|----------|
| Test Mode : | 802.11g | Temperature : | 24~25°C |
| Test Channel : | 01 | Relative Humidity : | 46~47% |
| Test Engineer : | Abi Lin | Polarization : | Vertical |
| Remark : | 1. 2414 MHz is fundamental signal which can be ignored. 2. Average measurement was not performed if peak level went lower than the average limit. | | |

| Frequency (MHz) | Level (dBμV/m) | Over Limit (dB) | Limit Line (dBμV/m) | Read Level (dBμV) | Antenna Factor (dB) | Cable Loss (dB) | Preamp Factor (dB) | Ant Pos (cm) | Table Pos (deg) | Remark |
|----------------------|---------------------|-------------------------|-----------------------------|-------------------------|-----------------------------|-------------------------|----------------------------|----------------------|-------------------------|---------|
| 2414 | 96.16 | - | - | 92.38 | 31.93 | 6.49 | 34.64 | 100 | 312 | Average |
| 2414 | 107.36 | - | - | 103.58 | 31.93 | 6.49 | 34.64 | 100 | 312 | Peak |
| 4824 | 40.97 | -33.03 | 74 | 57.21 | 34.4 | 10.17 | 60.81 | 100 | 0 | Peak |



| | | | |
|------------------------|--|----------------------------|------------|
| Test Mode : | 802.11g | Temperature : | 24~25°C |
| Test Channel : | 06 | Relative Humidity : | 46~47% |
| Test Engineer : | Abi Lin | Polarization : | Horizontal |
| Remark : | 1. 2439 MHz is fundamental signal which can be ignored. 2. Average measurement was not performed if peak level went lower than the average limit. | | |

| Frequency (MHz) | Level (dBμV/m) | Over Limit (dB) | Limit Line (dBμV/m) | Read Level (dBμV) | Antenna Factor (dB) | Cable Loss (dB) | Preamp Factor (dB) | Ant Pos (cm) | Table Pos (deg) | Remark |
|----------------------|---------------------|-------------------------|-----------------------------|-------------------------|-----------------------------|-------------------------|----------------------------|----------------------|-------------------------|---------|
| 2439 | 98.64 | - | - | 94.8 | 31.96 | 6.52 | 34.64 | 141 | 142 | Average |
| 2439 | 108.94 | - | - | 105.1 | 31.96 | 6.52 | 34.64 | 141 | 142 | Peak |
| 4874 | 42.1 | -31.9 | 74 | 58.24 | 34.37 | 10.18 | 60.69 | 100 | 0 | Peak |
| 7311 | 43.51 | -30.49 | 74 | 57.48 | 35.61 | 10.94 | 60.52 | 100 | 0 | Peak |

| | | | |
|------------------------|--|----------------------------|----------|
| Test Mode : | 802.11g | Temperature : | 24~25°C |
| Test Channel : | 06 | Relative Humidity : | 46~47% |
| Test Engineer : | Abi Lin | Polarization : | Vertical |
| Remark : | 1. 2439 MHz is fundamental signal which can be ignored. 2. Average measurement was not performed if peak level went lower than the average limit. | | |

| Frequency (MHz) | Level (dBμV/m) | Over Limit (dB) | Limit Line (dBμV/m) | Read Level (dBμV) | Antenna Factor (dB) | Cable Loss (dB) | Preamp Factor (dB) | Ant Pos (cm) | Table Pos (deg) | Remark |
|----------------------|---------------------|-------------------------|-----------------------------|-------------------------|-----------------------------|-------------------------|----------------------------|----------------------|-------------------------|---------|
| 2439 | 97.26 | - | - | 93.42 | 31.96 | 6.52 | 34.64 | 100 | 171 | Average |
| 2439 | 107.89 | - | - | 104.05 | 31.96 | 6.52 | 34.64 | 100 | 171 | Peak |
| 4875 | 40.93 | -33.07 | 74 | 57.07 | 34.37 | 10.18 | 60.69 | 100 | 0 | Peak |
| 7311 | 42.75 | -31.25 | 74 | 56.72 | 35.61 | 10.94 | 60.52 | 100 | 0 | Peak |



| | | | |
|------------------------|--|----------------------------|------------|
| Test Mode : | 802.11g | Temperature : | 24~25°C |
| Test Channel : | 11 | Relative Humidity : | 46~47% |
| Test Engineer : | Abi Lin | Polarization : | Horizontal |
| Remark : | 1. 2464 MHz is fundamental signal which can be ignored. 2. Average measurement was not performed if peak level went lower than the average limit. | | |

| Frequency (MHz) | Level (dBμV/m) | Over Limit (dB) | Limit Line (dBμV/m) | Read Level (dBμV) | Antenna Factor (dB) | Cable Loss (dB) | Preamp Factor (dB) | Ant Pos (cm) | Table Pos (deg) | Remark |
|----------------------|---------------------|-------------------------|-----------------------------|-------------------------|-----------------------------|-------------------------|----------------------------|----------------------|-------------------------|---------|
| 38.64 | 11.91 | -28.09 | 40 | 29.55 | 13.42 | 0.73 | 31.79 | - | - | Peak |
| 113.7 | 20.44 | -23.06 | 43.5 | 38.94 | 12.07 | 1.18 | 31.75 | 100 | 215 | Peak |
| 265.71 | 16.77 | -29.23 | 46 | 33.34 | 13.36 | 1.8 | 31.73 | - | - | Peak |
| 365.1 | 18.06 | -27.94 | 46 | 32.88 | 14.85 | 2.11 | 31.78 | - | - | Peak |
| 668.9 | 22.14 | -23.86 | 46 | 31.85 | 19.49 | 2.83 | 32.03 | - | - | Peak |
| 834.8 | 23.79 | -22.21 | 46 | 31.76 | 20.65 | 3.18 | 31.8 | - | - | Peak |
| 2464 | 94.76 | - | - | 90.87 | 31.97 | 6.56 | 34.64 | 115 | 140 | Average |
| 2464 | 104.81 | - | - | 100.92 | 31.97 | 6.56 | 34.64 | 115 | 140 | Peak |
| 4924 | 40.57 | -33.43 | 74 | 56.59 | 34.34 | 10.21 | 60.57 | 100 | 0 | Peak |
| 7386 | 42.41 | -31.59 | 74 | 56.49 | 35.56 | 10.92 | 60.56 | 100 | 0 | Peak |



| | | | |
|------------------------|--|----------------------------|----------|
| Test Mode : | 802.11g | Temperature : | 24~25°C |
| Test Channel : | 11 | Relative Humidity : | 46~47% |
| Test Engineer : | Abi Lin | Polarization : | Vertical |
| Remark : | 1. 2460 MHz is fundamental signal which can be ignored. 2. Average measurement was not performed if peak level went lower than the average limit. | | |

| Frequency (MHz) | Level (dBμV/m) | Over Limit (dB) | Limit Line (dBμV/m) | Read Level (dBμV) | Antenna Factor (dB) | Cable Loss (dB) | Preamp Factor (dB) | Ant Pos (cm) | Table Pos (deg) | Remark |
|----------------------|---------------------|-------------------------|-----------------------------|-------------------------|-----------------------------|-------------------------|----------------------------|----------------------|-------------------------|---------|
| 103.71 | 15.19 | -28.31 | 43.5 | 34.38 | 11.44 | 1.12 | 31.75 | - | - | Peak |
| 222.51 | 14.62 | -31.38 | 46 | 35.33 | 9.4 | 1.63 | 31.74 | - | - | Peak |
| 292.17 | 14.88 | -31.12 | 46 | 31.69 | 13.04 | 1.87 | 31.72 | - | - | Peak |
| 411.3 | 18.68 | -27.32 | 46 | 31.94 | 16.35 | 2.22 | 31.83 | - | - | Peak |
| 671 | 20.62 | -25.38 | 46 | 30.32 | 19.49 | 2.84 | 32.03 | - | - | Peak |
| 865.6 | 23.1 | -22.9 | 46 | 30.65 | 20.85 | 3.27 | 31.67 | 100 | 256 | Peak |
| 2460 | 97.39 | - | - | 93.5 | 31.97 | 6.56 | 34.64 | 120 | 285 | Average |
| 2460 | 107.67 | - | - | 103.78 | 31.97 | 6.56 | 34.64 | 120 | 285 | Peak |
| 4923 | 40.51 | -33.49 | 74 | 56.54 | 34.34 | 10.2 | 60.57 | 100 | 0 | Peak |
| 7386 | 41.51 | -32.49 | 74 | 55.59 | 35.56 | 10.92 | 60.56 | 100 | 0 | Peak |



| | | | |
|------------------------|--|----------------------------|------------|
| Test Mode : | 2.4GHz 802.11n HT20 | Temperature : | 24~25°C |
| Test Channel : | 01 | Relative Humidity : | 46~47% |
| Test Engineer : | Abi Lin | Polarization : | Horizontal |
| Remark : | 1. 2410 MHz is fundamental signal which can be ignored. 2. Average measurement was not performed if peak level went lower than the average limit. | | |

| Frequency (MHz) | Level (dBμV/m) | Over Limit (dB) | Limit Line (dBμV/m) | Read Level (dBμV) | Antenna Factor (dB) | Cable Loss (dB) | Preamp Factor (dB) | Ant Pos (cm) | Table Pos (deg) | Remark |
|----------------------|---------------------|-------------------------|-----------------------------|-------------------------|-----------------------------|-------------------------|----------------------------|----------------------|-------------------------|---------|
| 2410 | 92.76 | - | - | 88.98 | 31.93 | 6.49 | 34.64 | 152 | 314 | Average |
| 2410 | 103.09 | - | - | 99.31 | 31.93 | 6.49 | 34.64 | 152 | 314 | Peak |
| 4824 | 39.96 | -34.04 | 74 | 56.2 | 34.4 | 10.17 | 60.81 | 100 | 0 | Peak |

| | | | |
|------------------------|--|----------------------------|----------|
| Test Mode : | 2.4GHz 802.11n HT20 | Temperature : | 24~25°C |
| Test Channel : | 01 | Relative Humidity : | 46~47% |
| Test Engineer : | Abi Lin | Polarization : | Vertical |
| Remark : | 1. 2410 MHz is fundamental signal which can be ignored. 2. Average measurement was not performed if peak level went lower than the average limit. | | |

| Frequency (MHz) | Level (dBμV/m) | Over Limit (dB) | Limit Line (dBμV/m) | Read Level (dBμV) | Antenna Factor (dB) | Cable Loss (dB) | Preamp Factor (dB) | Ant Pos (cm) | Table Pos (deg) | Remark |
|----------------------|---------------------|-------------------------|-----------------------------|-------------------------|-----------------------------|-------------------------|----------------------------|----------------------|-------------------------|---------|
| 2410 | 95.52 | - | - | 91.74 | 31.93 | 6.49 | 34.64 | 100 | 120 | Average |
| 2410 | 105.42 | - | - | 101.64 | 31.93 | 6.49 | 34.64 | 100 | 120 | Peak |
| 4824 | 40.66 | -33.34 | 74 | 56.9 | 34.4 | 10.17 | 60.81 | 100 | 0 | Peak |



| | | | |
|------------------------|--|----------------------------|------------|
| Test Mode : | 2.4GHz 802.11n HT20 | Temperature : | 24~25°C |
| Test Channel : | 06 | Relative Humidity : | 46~47% |
| Test Engineer : | Abi Lin | Polarization : | Horizontal |
| Remark : | 1. 2439 MHz is fundamental signal which can be ignored. 2. Average measurement was not performed if peak level went lower than the average limit. | | |

| Frequency (MHz) | Level (dBμV/m) | Over Limit (dB) | Limit Line (dBμV/m) | Read Level (dBμV) | Antenna Factor (dB) | Cable Loss (dB) | Preamp Factor (dB) | Ant Pos (cm) | Table Pos (deg) | Remark |
|----------------------|---------------------|-------------------------|-----------------------------|-------------------------|-----------------------------|-------------------------|----------------------------|----------------------|-------------------------|---------|
| 2439 | 100.98 | - | - | 97.14 | 31.96 | 6.52 | 34.64 | 200 | 58 | Average |
| 2439 | 111.17 | - | - | 107.33 | 31.96 | 6.52 | 34.64 | 200 | 58 | Peak |
| 4875 | 42.25 | -31.75 | 74 | 58.39 | 34.37 | 10.18 | 60.69 | 100 | 0 | Peak |
| 7311 | 44.43 | -29.57 | 74 | 58.4 | 35.61 | 10.94 | 60.52 | 100 | 0 | Peak |

| | | | |
|------------------------|--|----------------------------|----------|
| Test Mode : | 2.4GHz 802.11n HT20 | Temperature : | 24~25°C |
| Test Channel : | 06 | Relative Humidity : | 46~47% |
| Test Engineer : | Abi Lin | Polarization : | Vertical |
| Remark : | 1. 2439 MHz is fundamental signal which can be ignored. 2. Average measurement was not performed if peak level went lower than the average limit. | | |

| Frequency (MHz) | Level (dBμV/m) | Over Limit (dB) | Limit Line (dBμV/m) | Read Level (dBμV) | Antenna Factor (dB) | Cable Loss (dB) | Preamp Factor (dB) | Ant Pos (cm) | Table Pos (deg) | Remark |
|----------------------|---------------------|-------------------------|-----------------------------|-------------------------|-----------------------------|-------------------------|----------------------------|----------------------|-------------------------|---------|
| 2439 | 99.77 | - | - | 95.93 | 31.96 | 6.52 | 34.64 | 100 | 119 | Average |
| 2439 | 109.92 | - | - | 106.08 | 31.96 | 6.52 | 34.64 | 100 | 119 | Peak |
| 4875 | 41.56 | -32.44 | 74 | 57.7 | 34.37 | 10.18 | 60.69 | 100 | 0 | Peak |
| 7311 | 44.23 | -29.77 | 74 | 58.2 | 35.61 | 10.94 | 60.52 | 100 | 0 | Peak |



| | | | |
|------------------------|--|----------------------------|------------|
| Test Mode : | 2.4GHz 802.11n HT20 | Temperature : | 24~25°C |
| Test Channel : | 11 | Relative Humidity : | 46~47% |
| Test Engineer : | Abi Lin | Polarization : | Horizontal |
| Remark : | 1. 2464 MHz is fundamental signal which can be ignored. 2. Average measurement was not performed if peak level went lower than the average limit. | | |

| Frequency (MHz) | Level (dBμV/m) | Over Limit (dB) | Limit Line (dBμV/m) | Read Level (dBμV) | Antenna Factor (dB) | Cable Loss (dB) | Preamp Factor (dB) | Ant Pos (cm) | Table Pos (deg) | Remark |
|----------------------|---------------------|-------------------------|-----------------------------|-------------------------|-----------------------------|-------------------------|----------------------------|----------------------|-------------------------|---------|
| 88.32 | 11.61 | -31.89 | 43.5 | 34.05 | 8.28 | 1.04 | 31.76 | - | - | Peak |
| 149.34 | 18.75 | -24.75 | 43.5 | 38.48 | 10.68 | 1.34 | 31.75 | - | - | Peak |
| 187.41 | 12.51 | -30.99 | 43.5 | 33.75 | 9.04 | 1.47 | 31.75 | - | - | Peak |
| 414.1 | 21.04 | -24.96 | 46 | 34.15 | 16.5 | 2.23 | 31.84 | - | - | Peak |
| 700.4 | 26.33 | -19.67 | 46 | 36.06 | 19.4 | 2.89 | 32.02 | 100 | 244 | Peak |
| 908.3 | 23.82 | -22.18 | 46 | 30.89 | 21.02 | 3.37 | 31.46 | - | - | Peak |
| 2464 | 94.12 | - | - | 90.23 | 31.97 | 6.56 | 34.64 | 109 | 203 | Average |
| 2464 | 104.58 | - | - | 100.69 | 31.97 | 6.56 | 34.64 | 109 | 203 | Peak |
| 4923 | 40.66 | -33.34 | 74 | 56.69 | 34.34 | 10.2 | 60.57 | 100 | 0 | Peak |
| 7386 | 42.55 | -31.45 | 74 | 56.63 | 35.56 | 10.92 | 60.56 | 100 | 0 | Peak |



| | | | |
|------------------------|--|----------------------------|----------|
| Test Mode : | 2.4GHz 802.11n HT20 | Temperature : | 24~25°C |
| Test Channel : | 11 | Relative Humidity : | 46~47% |
| Test Engineer : | Abi Lin | Polarization : | Vertical |
| Remark : | 1. 2464 MHz is fundamental signal which can be ignored. 2. Average measurement was not performed if peak level went lower than the average limit. | | |

| Frequency (MHz) | Level (dBμV/m) | Over Limit (dB) | Limit Line (dBμV/m) | Read Level (dBμV) | Antenna Factor (dB) | Cable Loss (dB) | Preamp Factor (dB) | Ant Pos (cm) | Table Pos (deg) | Remark |
|----------------------|---------------------|-------------------------|-----------------------------|-------------------------|-----------------------------|-------------------------|----------------------------|----------------------|-------------------------|---------|
| 120.18 | 25.11 | -18.39 | 43.5 | 43.44 | 12.2 | 1.22 | 31.75 | 100 | 269 | Peak |
| 187.68 | 12.6 | -30.9 | 43.5 | 33.82 | 9.06 | 1.47 | 31.75 | - | - | Peak |
| 251.13 | 15.34 | -30.66 | 46 | 32.78 | 12.55 | 1.74 | 31.73 | - | - | Peak |
| 400.8 | 18 | -28 | 46 | 31.78 | 15.85 | 2.19 | 31.82 | - | - | Peak |
| 665.4 | 24.7 | -21.3 | 46 | 34.45 | 19.45 | 2.83 | 32.03 | - | - | Peak |
| 876.1 | 24.73 | -21.27 | 46 | 32.16 | 20.9 | 3.3 | 31.63 | - | - | Peak |
| 2464 | 97.54 | - | - | 93.65 | 31.97 | 6.56 | 34.64 | 100 | 121 | Average |
| 2464 | 108.24 | - | - | 104.35 | 31.97 | 6.56 | 34.64 | 100 | 121 | Peak |
| 4923 | 42.3 | -31.7 | 74 | 58.33 | 34.34 | 10.2 | 60.57 | 100 | 0 | Peak |
| 7386 | 42.84 | -31.16 | 74 | 56.92 | 35.56 | 10.92 | 60.56 | 100 | 0 | Peak |



3.6 AC Conducted Emission Measurement

3.6.1 Limit of AC Conducted Emission

For equipment that is designed to be connected to the public utility (AC) power line, the radio frequency voltage that is conducted back onto the AC power line on any frequency or frequencies within the band 150 kHz to 30 MHz shall not exceed the limits in the following table.

| Frequency of Emission (MHz) | Conducted Limit (dB μ V) | |
|--------------------------------|------------------------------|-----------|
| | Quasi-Peak | Average |
| 0.15-0.5 | 66 to 56* | 56 to 46* |
| 0.5-5 | 56 | 46 |
| 5-30 | 60 | 50 |

*Decreases with the logarithm of the frequency.

3.6.2 Measuring Instruments

The measuring equipment is listed in the section 4 of this test report.

3.6.3 Test Procedures

1. The EUT was placed 0.4 meter from the conducting wall of the shielding room, and it was kept at least 80 centimeters from any other grounded conducting surface.
2. Connect EUT to the power mains through a line impedance stabilization network (LISN).
3. All the support units are connecting to the other LISN.
4. The LISN provides 50 ohm coupling impedance for the measuring instrument.
5. The FCC states that a 50 ohm, 50 microhenry LISN should be used.
6. Both sides of AC line were checked for maximum conducted interference.
7. The frequency range from 150 kHz to 30 MHz was searched.
8. Set the test-receiver system to Peak Detect Function and specified bandwidth with Maximum Hold Mode.

3.6.4 Test Setup

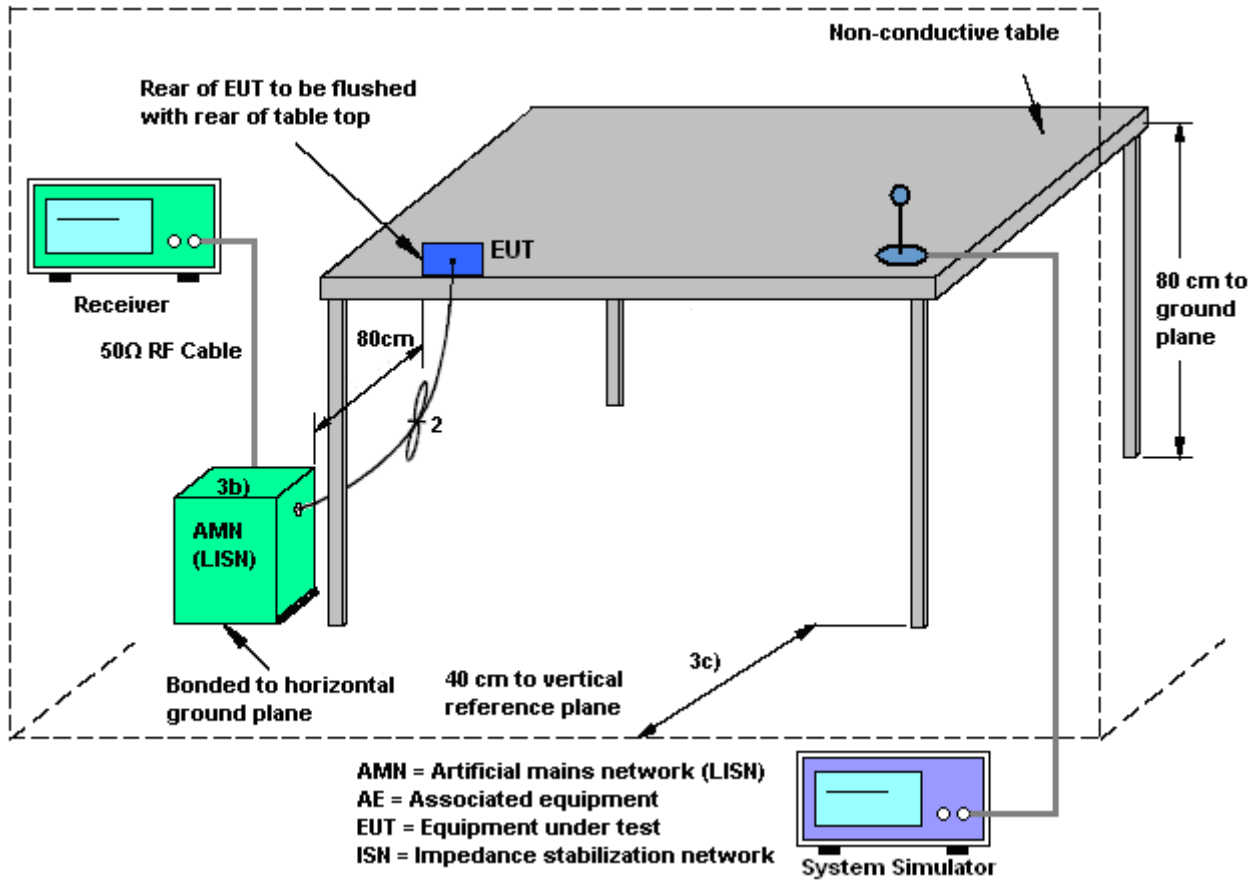

3.6.5 Test Result of AC Conducted Emission

| | | | |
|-----------------|--|---------------------|---------|
| Test Mode : | Mode 1 | Temperature : | 20~22°C |
| Test Engineer : | Cosmo Xu | Relative Humidity : | 45~47% |
| Test Voltage : | 120Vac / 60Hz | Phase : | Line |
| Function Type : | GSM850 Idle + Bluetooth Link + WLAN Link + USB Cable (Charging from Adapter) + Earphone + MP3 | | |

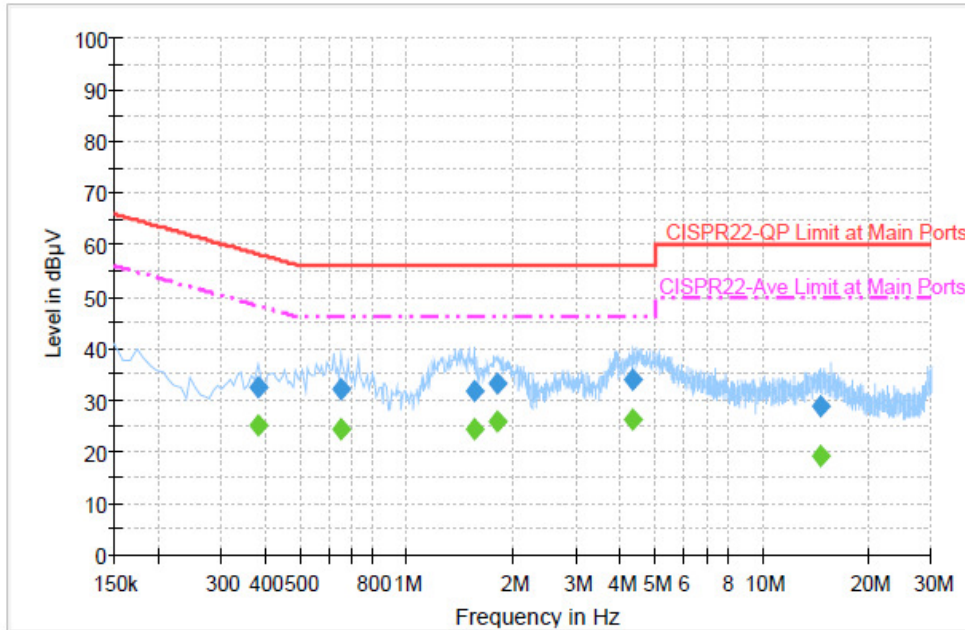

Final Result : Quasi-Peak

| Frequency (MHz) | Quasi-Peak (dBμV) | Filter | Line | Corr. (dB) | Margin (dB) | Limit (dBμV) |
|-----------------|-------------------|--------|------|------------|-------------|--------------|
| 0.382000 | 32.4 | Off | L1 | 19.3 | 25.8 | 58.2 |
| 0.654000 | 32.2 | Off | L1 | 19.4 | 23.8 | 56.0 |
| 1.550000 | 31.6 | Off | L1 | 19.4 | 24.4 | 56.0 |
| 1.790000 | 33.2 | Off | L1 | 19.5 | 22.8 | 56.0 |
| 4.342000 | 33.8 | Off | L1 | 19.6 | 22.2 | 56.0 |
| 14.694000 | 29.0 | Off | L1 | 19.9 | 31.0 | 60.0 |

Final Result : Average

| Frequency (MHz) | Average (dBμV) | Filter | Line | Corr. (dB) | Margin (dB) | Limit (dBμV) |
|-----------------|----------------|--------|------|------------|-------------|--------------|
| 0.382000 | 25.1 | Off | L1 | 19.3 | 23.1 | 48.2 |
| 0.654000 | 24.2 | Off | L1 | 19.4 | 21.8 | 46.0 |
| 1.550000 | 24.4 | Off | L1 | 19.4 | 21.6 | 46.0 |
| 1.790000 | 25.8 | Off | L1 | 19.5 | 20.2 | 46.0 |
| 4.342000 | 26.2 | Off | L1 | 19.6 | 19.8 | 46.0 |
| 14.694000 | 19.2 | Off | L1 | 19.9 | 30.8 | 50.0 |



| | | | |
|-----------------|--|---------------------|---------|
| Test Mode : | Mode 1 | Temperature : | 20~22°C |
| Test Engineer : | Cosmo Xu | Relative Humidity : | 45~47% |
| Test Voltage : | 120Vac / 60Hz | Phase : | Neutral |
| Function Type : | GSM850 Idle + Bluetooth Link + WLAN Link + USB Cable (Charging from Adapter) + Earphone + MP3 | | |

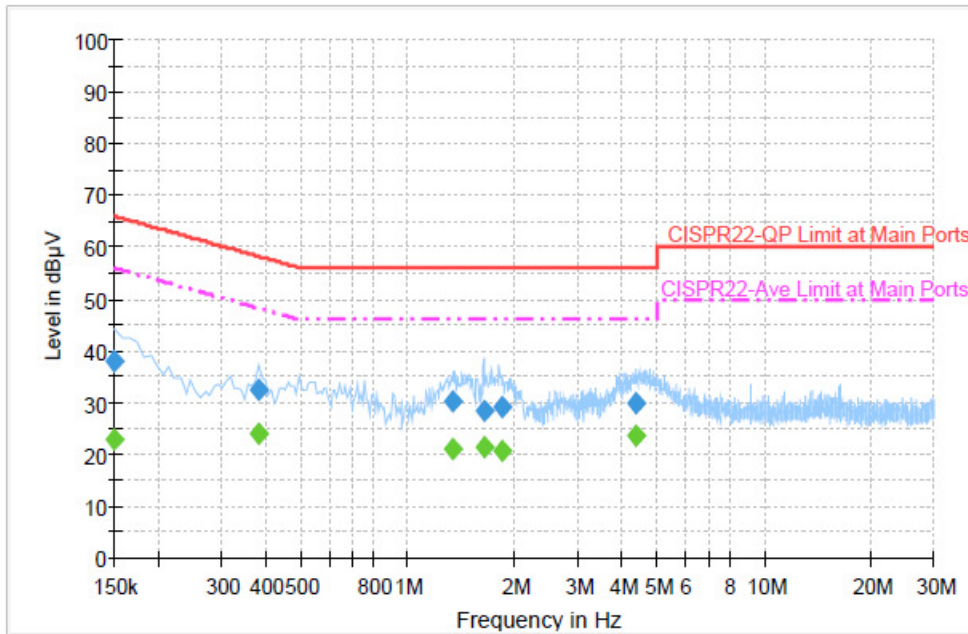

Final Result : Quasi-Peak

| Frequency (MHz) | Quasi-Peak (dBµV) | Filter | Line | Corr. (dB) | Margin (dB) | Limit (dBµV) |
|-----------------|-------------------|--------|------|------------|-------------|--------------|
| 0.150000 | 38.0 | Off | N | 19.4 | 28.0 | 66.0 |
| 0.382000 | 32.4 | Off | N | 19.3 | 25.8 | 58.2 |
| 1.334000 | 30.2 | Off | N | 19.5 | 25.8 | 56.0 |
| 1.638000 | 28.3 | Off | N | 19.5 | 27.7 | 56.0 |
| 1.830000 | 29.2 | Off | N | 19.6 | 26.8 | 56.0 |
| 4.366000 | 29.8 | Off | N | 19.6 | 26.2 | 56.0 |

Final Result : Average

| Frequency (MHz) | Average (dBµV) | Filter | Line | Corr. (dB) | Margin (dB) | Limit (dBµV) |
|-----------------|----------------|--------|------|------------|-------------|--------------|
| 0.150000 | 22.8 | Off | N | 19.4 | 33.2 | 56.0 |
| 0.382000 | 24.0 | Off | N | 19.3 | 24.2 | 48.2 |
| 1.334000 | 21.2 | Off | N | 19.5 | 24.8 | 46.0 |
| 1.638000 | 21.5 | Off | N | 19.5 | 24.5 | 46.0 |
| 1.830000 | 20.6 | Off | N | 19.6 | 25.4 | 46.0 |
| 4.366000 | 23.5 | Off | N | 19.6 | 22.5 | 46.0 |



3.7 Antenna Requirements

3.7.1 Standard Applicable

If directional gain of transmitting antennas is greater than 6dBi, the power shall be reduced by the same level in dB comparing to gain minus 6dBi. For the fixed point-to-point operation, the power shall be reduced by one dB for every 3 dB that the directional gain of the antenna exceeds 6 dBi. The use of a permanently attached antenna or of an antenna that uses a unique coupling to the intentional radiator shall be considered sufficient to comply with the FCC rule.

3.7.2 Antenna Anti-Replacement Construction

An embedded-in antenna design is used.

3.7.3 Antenna Gain

The antenna peak gain of EUT is less than 6 dBi. Therefore, it is not necessary to reduce maximum peak output power limit.



4 List of Measuring Equipment

| Instrument | Manufacturer | Model No. | Serial No. | Characteristics | Calibration Date | Test Date | Due Date | Remark |
|--------------------------------------|-----------------|-----------|-----------------|--------------------|------------------|---------------------------------|---------------|--------------------------|
| Spectrum Analyzer | Rohde & Schwarz | FSP40 | 100057 | 9kHz~40GHz | Oct. 23, 2013 | May 02, 2014~ Jun. 20, 2014 | Oct. 22, 2014 | Conducted (TH02-HY) |
| Power Meter | Anritsu | ML2495A | 1036004 | 300MHz~40GHz | Aug. 17, 2013 | May 02, 2014~ Jun. 20, 2014 | Aug. 16, 2014 | Conducted (TH02-HY) |
| Power Sensor | Anritsu | MA2411B | 1027253 | 300MHz~40GHz | Aug. 17, 2013 | May 02, 2014~ Jun. 20, 2014 | Aug. 16, 2014 | Conducted (TH02-HY) |
| Spectrum Analyzer | R&S | FSP30 | 101067 | 9kHz ~ 30GHz | Nov. 20, 2013 | Jun. 17, 2014~ Jun. 20, 2014 | Nov. 19, 2014 | Radiation (03CH06-HY) |
| Spectrum Analyzer | Agilent | E4408B | MY442110 30 | 9kHz ~ 26.5GHz | Dec. 02, 2013 | Jun. 17, 2014~ Jun. 20, 2014 | Dec. 01, 2014 | Radiation (03CH06-HY) |
| EMI Test Receiver | R&S | ESVS10 | 834468/00 03 | 20MHz ~ 1000MHz | May 06, 2014 | Jun. 17, 2014~ Jun. 20, 2014 | May 05, 2015 | Radiation (03CH06-HY) |
| Loop Antenna | Rohde & Schwarz | HFH2-Z2 | 860004/00 01 | 9kHz ~ 30MHz | Jul. 03, 2012 | Jun. 17, 2014~ Jun. 20, 2014 | Jul. 02, 2014 | Radiation (03CH06-HY) |
| Bilog Antenna | Schaffner | CBL6112B | 2885 | 30MHz ~ 2GHz | Oct. 10, 2013 | Jun. 17, 2014~ Jun. 20, 2014 | Oct. 09, 2014 | Radiation (03CH06-HY) |
| Double Ridge Horn Antenna | EMCO | 3117 | 00066583 | 1GHz ~ 18GHz | Aug. 02, 2013 | Jun. 17, 2014~ Jun. 20, 2014 | Aug. 01, 2014 | Radiation (03CH06-HY) |
| Amplifier | SONOMA | 310N | 186713 | 9kHz ~ 1GHz | Apr. 16, 2014 | Jun. 17, 2014~ Jun. 20, 2014 | Apr. 15, 2015 | Radiation (03CH06-HY) |
| Pre Amplifier | EMCI | EMC051845 | SN980048 | 1GHz ~ 18GHz | Jul. 18, 2013 | Jun. 17, 2014~ Jun. 20, 2014 | Jul. 17, 2014 | Radiation (03CH06-HY) |
| SHF-EHF Horn Antenna | SCHWARZBE CK | BBHA 9170 | BBHA917 0251 | 15GHz ~ 40GHz | Oct. 03, 2013 | Jun. 17, 2014~ Jun. 20, 2014 | Oct. 02, 2014 | Radiation (03CH06-HY) |
| Preamplifier | Agilent | 8449B | 3008A019 17 | 1GHz ~ 26.5GHz | Apr. 10, 2014 | Jun. 17, 2014~ Jun. 20, 2014 | Apr. 09, 2015 | Radiation (03CH06-HY) |
| Turn Table | INN-CO | DS2000 | 420/650/0 0 | 0 ~ 360 degree | N/A | Jun. 17, 2014~ Jun. 20, 2014 | N/A | Radiation (03CH06-HY) |
| Antenna Mast | MF | MF-7802 | MF780208 212 | 1 m ~ 4 m | N/A | Jun. 17, 2014~ Jun. 20, 2014 | N/A | Radiation (03CH06-HY) |
| EMI Test Receiver | Rohde & Schwarz | ESCS 30 | 100356 | 9kHz ~ 2.75GHz | Nov. 15, 2013 | May 29, 2014 | Nov. 14, 2014 | Conduction (CO05-HY) |
| LISN (for auxiliary equipment) | Rohde & Schwarz | ENV216 | 100081 | 9kHz ~ 30MHz | Dec. 12, 2013 | May 29, 2014 | Dec. 11, 2014 | Conduction (CO05-HY) |
| LISN | Rohde & Schwarz | ENV216 | 100080 | 9kHz ~ 30MHz | Dec. 04, 2013 | May 29, 2014 | Dec. 03, 2014 | Conduction (CO05-HY) |
| AC Power Source | ChainTek | APC-1000W | N/A | N/A | N/A | May 29, 2014 | N/A | Conduction (CO05-HY) |



5 Uncertainty of Evaluation

Uncertainty of Conducted Emission Measurement (150kHz ~ 30MHz)

| | |
|---|------|
| Measuring Uncertainty for a Level of Confidence of 95% ($U = 2Uc(y)$) | 2.26 |
|---|------|

Uncertainty of Radiated Emission Measurement (30 MHz ~ 1000 MHz)

| | |
|---|------|
| Measuring Uncertainty for a Level of Confidence of 95% ($U = 2Uc(y)$) | 4.50 |
|---|------|