



FCC RF Test Report

APPLICANT : Motorola Mobility, LLC
EQUIPMENT : Mobile Cellular Phone
BRAND NAME : Motorola Mobility, LLC
MODEL NAME : 3606
FCC ID : IHDT56QA3
STANDARD : FCC Part 15 Subpart C §15.247
CLASSIFICATION : (DTS) Digital Transmission System

The product was received on May 30, 2014. We, SPORTON INTERNATIONAL INC., would like to declare that the tested sample has been evaluated in accordance with the test procedures and has been in compliance with the applicable technical standards.

The test results in this report apply exclusively to the tested model / sample. Without written approval of SPORTON INTERNATIONAL INC., the test report shall not be reproduced except in full.

Reviewed by: Joseph Lin / Supervisor

Approved by: Jones Tsai / Manager



SPORTON INTERNATIONAL INC.

No. 52, Hwa Ya 1st Rd., Hwa Ya Technology Park, Kwei-Shan Hsiang, Tao Yuan Hsien, Taiwan, R.O.C.



TABLE OF CONTENTS

REVISION HISTORY..... 3

1 GENERAL DESCRIPTION 4

 1.1 Applicant 4

 1.2 Manufacturer..... 4

 1.3 Product Feature of Equipment Under Test..... 4

 1.4 Product Specification subjective to this standard 4

 1.5 Modification of EUT 4

APPENDIX A. ORIGINAL REPORT



1 General Description

1.1 Applicant

Motorola Mobility, LLC

222 W Merchandise Mart Plaza, Suite 1800, Chicago, IL 60654, United States

1.2 Manufacturer

Motorola Mobility, LLC

222 W Merchandise Mart Plaza, Suite 1800, Chicago, IL 60654, United States

1.3 Product Feature of Equipment Under Test

Product Feature	
Equipment	Mobile Cellular Phone
Brand Name	Motorola Mobility, LLC
Model Name	3606
FCC ID	IHDT56QA3
EUT supports Radios application	GSM/EGPRS/CDMA/EV-DOW/CDMA/HSPA/LTE/NFC WLAN 11b/g/n HT20 WLAN 11a/n HT20/HT40 WLAN 11ac VHT20/VHT40/VHT80 Bluetooth v3.0 + EDR Bluetooth v4.0 - LE
HW Version	P2
SW Version	KXE21.116-VICTARA-SHA1
EUT Stage	Identical Prototype

Remark: The above EUT's information was declared by manufacturer. Please refer to the specifications or user's manual for more detailed description.

1.4 Product Specification subjective to this standard

Product Specification subjective to this standard	
Tx/Rx Channel Frequency Range	802.11b/g/n : 2412 MHz ~ 2462 MHz
Antenna Type	Fixed Internal Antenna type with gain 0.00 dBi
Type of Modulation	802.11b : DSSS (DBPSK / DQPSK / CCK) 802.11g/n/ac : OFDM (BPSK / QPSK / 16QAM / 64QAM)

1.5 Modification of EUT

No modifications are made to the EUT during all test items.



Appendix A. Original Report

Please refer to Sporton report number FR442943C as below.



FCC RF Test Report

APPLICANT : Motorola Mobility, LLC
EQUIPMENT : Mobile Cellular Phone
BRAND NAME : Motorola Mobility, LLC
FCC MODEL NAME : 3578
FCC ID : IHDT56QA1
STANDARD : FCC Part 15 Subpart C §15.247
CLASSIFICATION : (DTS) Digital Transmission System

The product was received on Apr. 29, 2014 and testing was completed on Jun. 11, 2014. We, SPORTON INTERNATIONAL INC., would like to declare that the tested sample has been evaluated in accordance with the test procedures and has been in compliance with the applicable technical standards.

The test results in this report apply exclusively to the tested model / sample. Without written approval of SPORTON INTERNATIONAL INC., the test report shall not be reproduced except in full.

Reviewed by: Joseph Lin / Supervisor

Approved by: Jones Tsai / Manager



SPORTON INTERNATIONAL INC.

No. 52, Hwa Ya 1st Rd., Hwa Ya Technology Park, Kwei-Shan Hsiang, Tao Yuan Hsien, Taiwan, R.O.C.

SPORTON INTERNATIONAL INC.

TEL : 886-3-327-3456

FAX : 886-3-328-4978

FCC ID : IHDT56QA1

Page Number : 1 of 64

Report Issued Date : Jul. 11, 2014

Report Version : Rev. 02

Report Template No.: BU5-FR15CWL Version 1.0



TABLE OF CONTENTS

REVISION HISTORY.....3

SUMMARY OF TEST RESULT4

1 GENERAL DESCRIPTION.....5

1.1 Applicant.....5

1.2 Manufacturer.....5

1.3 Product Feature of Equipment Under Test.....5

1.4 Product Specification subjective to this standard6

1.5 Modification of EUT6

1.6 Testing Location7

1.7 Applicable Standards.....7

2 TEST CONFIGURATION OF EQUIPMENT UNDER TEST.....8

2.1 Carrier Frequency Channel8

2.2 Pre-Scanned RF Power.....9

2.3 Test Mode..... 11

2.4 Connection Diagram of Test System..... 12

2.5 Support Unit used in test configuration and system 13

2.6 EUT Operation Test Setup 13

2.7 Measurement Results Explanation Example..... 13

3 TEST RESULT..... 14

3.1 6dB and 99% Bandwidth Measurement 14

3.2 Output Power Measurement..... 16

3.3 Power Spectral Density Measurement 19

3.4 Conducted Band Edges and Spurious Emission Measurement21

3.5 Radiated Band Edges and Spurious Emission Measurement 34

3.6 AC Conducted Emission Measurement.....57

3.7 Antenna Requirements..... 62

4 LIST OF MEASURING EQUIPMENT..... 63

5 UNCERTAINTY OF EVALUATION..... 64



REVISION HISTORY

REPORT NO.	VERSION	DESCRIPTION	ISSUED DATE
FR442943C	Rev. 01	Initial issue of report	Jun. 19, 2014
FR442943C	Rev. 02	Revising AC Conducted Emission Phase in section 3.6.	Jul. 11, 2014

**SUMMARY OF TEST RESULT**

Report Section	FCC Rule	Description	Limit	Result	Remark
3.1	15.247(a)(2)	6dB Bandwidth	$\geq 0.5\text{MHz}$	Pass	-
3.1	-	99% Bandwidth	-	Pass	-
3.2	15.247(b)	Power Output Measurement	$\leq 30\text{dBm}$	Pass	-
3.3	15.247(e)	Power Spectral Density	$\leq 8\text{dBm}/3\text{kHz}$	Pass	-
3.4	15.247(d)	Conducted Band Edges	$\leq 20\text{dBc}$	Pass	-
		Conducted Spurious Emission		Pass	-
3.5	15.247(d)	Radiated Band Edges and Radiated Spurious Emission	15.209(a) & 15.247(d)	Pass	Under limit 0.35 dB at 2390.010 MHz
3.6	15.207	AC Conducted Emission	15.207(a)	Pass	Under limit 17.00 dB at 3.150 MHz
3.7	15.203 & 15.247(b)	Antenna Requirement	N/A	Pass	-



1 General Description

1.1 Applicant

Motorola Mobility, LLC

222 W Merchandise Mart Plaza, Suite 1800, Chicago, IL 60654, United States

1.2 Manufacturer

Motorola Mobility, LLC

222 W Merchandise Mart Plaza, Suite 1800, Chicago, IL 60654, United States

1.3 Product Feature of Equipment Under Test

Product Feature	
Equipment	Mobile Cellular Phone
Brand Name	Motorola Mobility, LLC
FCC Model Name	3578
FCC ID	IHDT56QA1
IMEI Code	359279050020145
EUT supports Radios application	GSM/EGPRS/WCDMA/HSPA/LTE/NFC WLAN 11b/g/n HT20 WLAN 11a/n HT20/HT40 WLAN 11ac VHT20/VHT40/VHT80 Bluetooth v3.0 + EDR Bluetooth v4.0 - LE
HW Version	P2
SW Version	KXE21.99.169
EUT Stage	Identical Prototype

Remark: The above EUT's information was declared by manufacturer. Please refer to the specifications or user's manual for more detailed description.

Accessory List	
AC Adapter	Brand Name : Motorola
	Model Name : SPN5788A
Earphone	Brand Name : Motorola
	Model Name : SJYN1305A



1.4 Product Specification subjective to this standard

Product Specification subjective to this standard	
Tx/Rx Channel Frequency Range	802.11b/g/n : 2412 MHz ~ 2462 MHz
Maximum (Peak) Output Power to Antenna	<2412 MHz ~ 2462 MHz> 802.11b : 20.08 dBm (0.1019 W) 802.11g : 22.08 dBm (0.1614 W) 802.11n HT20 : 22.24 dBm (0.1675 W) 802.11ac VHT20 : 21.32 dBm (0.1355 W)
99% Occupied Bandwidth	<2412 MHz ~ 2462 MHz> 802.11b : 13.60MHz 802.11g : 18.80MHz 802.11n HT20 : 19.50MHz 802.11ac VHT20 : 19.30MHz
Antenna Type	Fixed Internal Antenna type with gain 0.00 dBi
Type of Modulation	802.11b : DSSS (DBPSK / DQPSK / CCK) 802.11g/n/ac : OFDM (BPSK / QPSK / 16QAM / 64QAM)

1.5 Modification of EUT

No modifications are made to the EUT during all test items.



1.6 Testing Location

Sporton Lab is accredited to ISO 17025 by Taiwan Accreditation Foundation (TAF code : 1190) and the FCC designation No. TW1022 under the FCC 2.948(e) by Mutual Recognition Agreement (MRA) in FCC Test.

Test Site	SPORTON INTERNATIONAL INC.		
Test Site Location	No. 52, Hwa Ya 1 st Rd., Hwa Ya Technology Park, Kwei-Shan Hsiang, Tao Yuan Hsien, Taiwan, R.O.C. TEL: +886-3-3273456 / FAX: +886-3-3284978		
Test Site No.	Sporton Site No.		
	TH02-HY	CO05-HY	03CH06-HY

1.7 Applicable Standards

According to the specifications of the manufacturer, the EUT must comply with the requirements of the following standards:

- ♦ FCC Part 15 Subpart C §15.247
- ♦ FCC KDB Publication No. 558074 D01 DTS Meas. Guidance v03r02
- ♦ ANSI C63.4-2003

Remark:

1. All test items were verified and recorded according to the standards and without any deviation during the test.
2. This EUT has also been tested and complied with the requirements of FCC Part 15, Subpart B, recorded in a separate test report.



2 Test Configuration of Equipment Under Test

The EUT has been associated with peripherals and configuration operated in a manner tended to maximize its emission characteristics in a typical application. Frequency range investigated: conducted emission (150 kHz to 30 MHz) and radiated emission (9 kHz to the 10th harmonic of the highest fundamental frequency or to 40 GHz, whichever is lower). For radiated measurement, pre-scanned in three orthogonal panels, X, Y, Z. The worst cases (Z plane) were recorded in this report.

The final configuration from all the combinations and the worst-case data rates were investigated by measuring the maximum power across all the data rates and modulation modes under section 2.2.

Based on the worst configuration found above, the RF power setting is set individually to meet FCC compliance limit for the final conducted and radiated tests shown in section 2.3.

2.1 Carrier Frequency Channel

Frequency Band	Channel	Freq. (MHz)	Channel	Freq. (MHz)
2400-2483.5 MHz	1	2412	7	2442
	2	2417	8	2447
	3	2422	9	2452
	4	2427	10	2457
	5	2432	11	2462
	6	2437	-	-



2.2 Pre-Scanned RF Power

Preliminary tests were performed in different data rate and data rate associated with the highest power were chosen for full test shown in the following tables.

Channel	Frequency	2.4GHz 802.11b RF Power (dBm) (800ns)			
		DSSS Data Rate			
		1 Mbps	2 Mbps	5.5 Mbps	11 Mbps
CH 01	2412MHz	18.74	18.85	19.77	19.74
CH 06	2437MHz	18.81	18.94	20.08	19.94
CH 11	2462MHz	18.69	18.79	20.03	19.71

Channel	Frequency	2.4GHz 802.11b Average Power (dBm) (800ns)			
		DSSS Data Rate			
		1 Mbps	2 Mbps	5.5 Mbps	11 Mbps
CH 01	2412MHz	16.14	16.20	17.78	17.41
CH 06	2437MHz	16.32	16.41	17.97	17.56
CH 11	2462MHz	16.26	16.33	17.93	17.44

Channel	Frequency	2.4GHz 802.11g RF Power (dBm) (800ns)							
		OFDM Data Rate							
		6 Mbps	9 Mbps	12 Mbps	18 Mbps	24 Mbps	36 Mbps	48 Mbps	54 Mbps
CH 01	2412MHz	21.66	21.57	21.64	21.51	21.57	21.59	21.57	21.49
CH 06	2437MHz	22.08	22.03	22.01	22.00	21.89	21.86	21.81	21.28
CH 11	2462MHz	20.70	20.62	20.69	20.64	20.66	20.64	20.67	20.64

Channel	Frequency	2.4GHz 802.11g Average Power (dBm) (800ns)							
		OFDM Data Rate							
		6 Mbps	9 Mbps	12 Mbps	18 Mbps	24 Mbps	36 Mbps	48 Mbps	54 Mbps
CH 01	2412MHz	14.42	14.41	14.32	14.21	14.31	14.38	14.25	14.40
CH 06	2437MHz	15.81	15.58	15.64	15.61	14.71	14.78	14.80	13.81
CH 11	2462MHz	11.81	11.76	11.80	11.68	11.56	11.76	11.81	11.79



Channel	Frequency	2.4GHz 802.11n HT20 RF Power (dBm) (800ns)							
		OFDM Data Rate							
		MCS0	MCS1	MCS2	MCS3	MCS4	MCS5	MCS6	MCS7
CH 01	2412MHz	21.62	21.46	21.32	21.22	21.22	21.34	21.52	21.11
CH 06	2437MHz	22.24	21.95	21.92	21.78	21.63	21.41	21.13	21.42
CH 11	2462MHz	19.25	19.06	19.01	18.97	19.03	18.91	19.04	19.06

Channel	Frequency	2.4GHz 802.11n HT20 Average Power (dBm) (800ns)							
		OFDM Data Rate							
		MCS0	MCS1	MCS2	MCS3	MCS4	MCS5	MCS6	MCS7
CH 01	2412MHz	13.42	13.30	13.35	13.29	13.34	13.34	13.29	12.94
CH 06	2437MHz	15.95	15.92	15.54	15.00	14.66	14.12	13.35	12.29
CH 11	2462MHz	10.75	10.72	10.63	10.65	10.72	10.70	10.66	10.68

Channel	Frequency	2.4GHz 802.11n VHT20 RF Power (dBm) (800ns)								
		OFDM Data Rate								
		MCS0	MCS1	MCS2	MCS3	MCS4	MCS5	MCS6	MCS7	MCS8
CH 01	2412MHz	21.32	21.18	20.73	20.61	20.79	19.72	18.84	17.37	18.28
CH 06	2437MHz	21.23	21.06	20.47	20.07	20.30	19.48	18.47	17.35	17.50
CH 11	2462MHz	19.82	19.72	19.14	18.79	19.81	19.14	18.13	17.01	17.16

Channel	Frequency	2.4GHz 802.11n VHT20 Average Power (dBm) (800ns)								
		OFDM Data Rate								
		MCS0	MCS1	MCS2	MCS3	MCS4	MCS5	MCS6	MCS7	MCS8
CH 01	2412MHz	12.61	12.53	12.30	12.26	11.13	11.15	9.13	8.98	8.07
CH 06	2437MHz	13.09	13.02	12.61	12.09	11.67	11.23	10.07	8.89	8.93
CH 11	2462MHz	11.04	10.98	10.97	10.42	10.92	10.88	9.72	8.54	8.58



2.3 Test Mode

Final results of test modes, data rates and test channels are shown as following table.

<2.4GHz>

Test Cases				
	Test Items	Mode	Data Rate	Test Channel
Conducted TCs	6dB and 99% BW Power Spectral Density	802.11b	5.5 Mbps	1/6/11
		802.11g	6 Mbps	1/6/11
		802.11n HT20	MCS0	1/6/11
		802.11ac VHT20	MCS0	1/6/11
	Output Power	802.11b	5.5 Mbps	1/6/11
		802.11g	6 Mbps	1/6/11
		802.11n HT20	MCS0	1/6/11
		802.11ac VHT20	MCS0	1/6/11
	Conducted Band Edge	802.11b	5.5 Mbps	1/11
		802.11g	6 Mbps	1/11
		802.11n HT20	MCS0	1/11
		802.11ac VHT20	MCS0	1/11
	Conducted Spurious Emission	802.11b	5.5 Mbps	1/6/11
		802.11g	6 Mbps	1/6/11
		802.11n HT20	MCS0	1/6/11
		802.11ac VHT20	MCS0	1/6/11
Radiated TCs	Radiated Band Edge	802.11b	5.5 Mbps	1/11
		802.11g	6 Mbps	1/11
		802.11n HT20	MCS0	1/11
		802.11ac VHT20	MCS0	1/11
	Radiated Spurious Emission	802.11b	5.5 Mbps	1/6/11
		802.11g	6 Mbps	1/6/11
		802.11n HT20	MCS0	1/6/11
		802.11ac VHT20	MCS0	1/6/11

Test Cases	
AC Conducted Emission	Mode 1 : GSM850 Idle + Bluetooth Link + WLAN (2.4GHz) Link + USB Cable (Charging from Adapter) + Battery + Earphone + MP3

2.4 Connection Diagram of Test System

<WLAN Tx Mode>

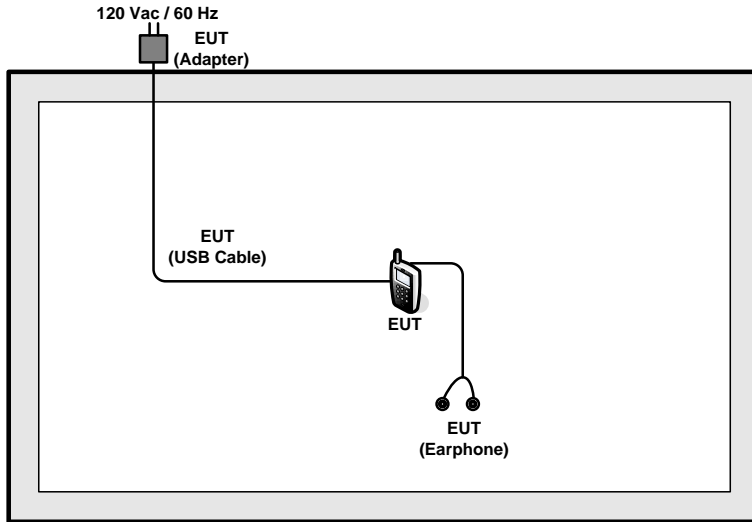

<AC Conducted Emission Mode>

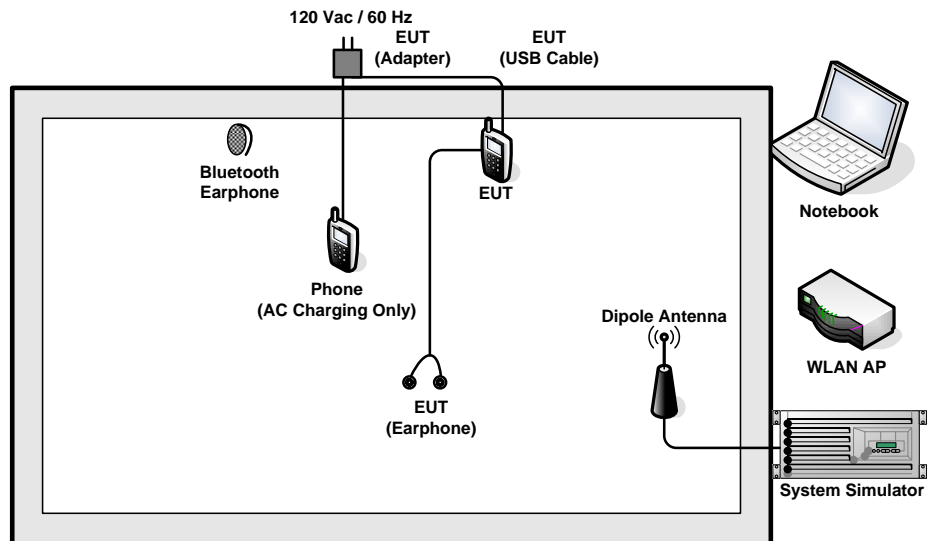



2.5 Support Unit used in test configuration and system

Item	Equipment	Trade Name	Model Name	FCC ID	Data Cable	Power Cord
1.	System Simulator	R&S	CMU 200	N/A	N/A	Unshielded, 1.8 m
2.	Bluetooth Earphone	Sony Ericsson	MW600	PY7DDA-2029	N/A	N/A
3.	WLAN AP	D-Link	DIR-628	KA2DIR628A2	N/A	Unshielded, 1.8 m
4.	Notebook	DELL	Latitude E6320	FCC DoC/ Contains FCC ID: QDS-BRCM1054	N/A	AC I/P: Unshielded, 1.2 m DC O/P: Shielded, 1.8 m

2.6 EUT Operation Test Setup

For WLAN RF test items, an engineering test program was provided and enabled to make EUT continuous transmit/receive.

2.7 Measurement Results Explanation Example

For all conducted test items:

The offset level is set in the spectrum analyzer to compensate the RF cable loss and attenuator factor between EUT conducted output port and spectrum analyzer. With the offset compensation, the spectrum analyzer reading level is exactly the EUT RF output level.

Example :

The spectrum analyzer offset is derived from RF cable loss and attenuator factor.

Offset = RF cable loss + attenuator factor.

Following shows an offset computation example with cable loss 4.2 dB and 10dB attenuator.

$$\begin{aligned} \text{Offset(dB)} &= \text{RF cable loss(dB)} + \text{attenuator factor(dB)}. \\ &= 4.2 + 10 = 14.2 \text{ (dB)} \end{aligned}$$

3 Test Result

3.1 6dB and 99% Bandwidth Measurement

3.1.1 Limit of 6dB and 99% Bandwidth

The minimum 6 dB bandwidth shall be at least 500 kHz.

3.1.2 Measuring Instruments

The measuring equipment is listed in the section 4 of this test report.

3.1.3 Test Procedures

1. The testing follows FCC KDB Publication No. 558074 DTS D01 Meas. Guidance v03r02.
2. The RF output of EUT was connected to the spectrum analyzer by RF cable and attenuator. The path loss was compensated to the results for each measurement.
3. Set to the maximum power setting and enable the EUT transmit continuously.
4. Make the measurement with the spectrum analyzer's resolution bandwidth (RBW) = 100 kHz. Set the Video bandwidth (VBW) = 300 kHz. In order to make an accurate measurement. The 6 dB bandwidth must be greater than 500 kHz.
5. For 99% Bandwidth Measurement, the spectrum analyzer's resolution bandwidth (RBW) = 1MHz and set the Video bandwidth (VBW) = 3MHz.
6. Measure and record the results in the test report.

3.1.4 Test Setup





3.1.5 Test Result of 6dB and 99% Occupied Bandwidth

Test Band :	2.4GHz	Temperature :	21~26°C
Test Engineer :	Alex Lee, Kenny Chen, and Bill Kuo	Relative Humidity :	45~54%

Mod.	Data Rate	N _{TX}	Channel	Freq. (MHz)	99% Bandwidth (MHz)	6dB Bandwidth (MHz)	6dB Bandwidth Min. Limit (MHz)	Pass/Fail
11b	5.5Mbps	1	1	2412	13.50	8.16	0.5	Pass
11b	5.5Mbps	1	6	2437	13.45	8.24	0.5	Pass
11b	5.5Mbps	1	11	2462	13.60	8.36	0.5	Pass
11g	6Mbps	1	1	2412	18.80	16.32	0.5	Pass
11g	6Mbps	1	6	2437	18.80	16.32	0.5	Pass
11g	6Mbps	1	11	2462	18.60	16.36	0.5	Pass
HT20	MCS0	1	1	2412	19.35	17.30	0.5	Pass
HT20	MCS0	1	6	2437	19.50	17.56	0.5	Pass
HT20	MCS0	1	11	2462	19.25	17.60	0.5	Pass
VHT20	MCS0	1	1	2412	19.30	17.32	0.5	Pass
VHT20	MCS0	1	6	2437	19.10	17.28	0.5	Pass
VHT20	MCS0	1	11	2462	19.30	17.56	0.5	Pass

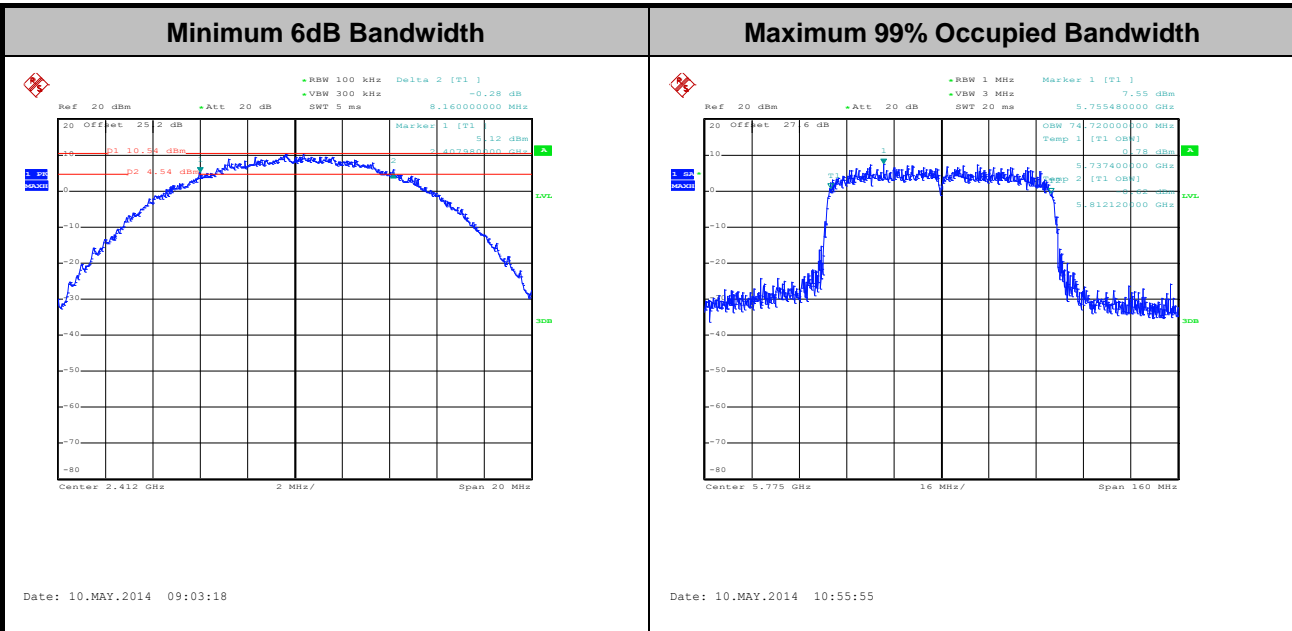

Note: The occupied channel bandwidth is maintained within the band of operation for all of the modulations.

3.2 Output Power Measurement

3.2.1 Limit of Output Power

For systems using digital modulation in the 2400-2483.5MHz, the limit for peak output power is 30dBm. If transmitting Antenna of directional gain greater than 6dBi are used the peak output power from the intentional radiator shall be reduced below the above stated value by the amount in dB that the directional gain of the Antenna exceeds 6 dBi. In case of point-to-point operation, the limit has to be reduced by 1dB for every 3dB that the directional gain of the Antenna exceeds 6dBi.

3.2.2 Measuring Instruments

The measuring equipment is listed in the section 4 of this test report.

3.2.3 Test Procedures

1. The testing follows the Measurement Procedure of FCC KDB No. 558074 DTS D01 Meas. Guidance v03r02.
2. The RF output of EUT was connected to the power meter by RF cable and attenuator. The path loss was compensated to the results for each measurement.
3. Set to the maximum power setting and enable the EUT transmit continuously.
4. Measure the conducted output power and record the results in the test report.

3.2.4 Test Setup

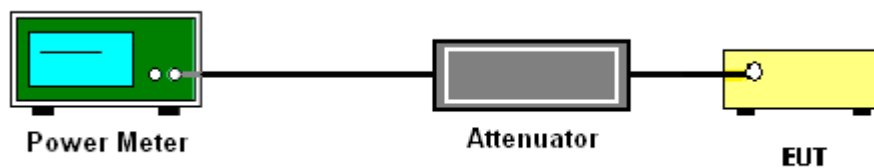



3.2.5 Test Result of Peak Output Power

Test Mode :	2.4GHz	Temperature :	21~26°C
Test Engineer :	Alex Lee, Kenny Chen, and Bill Kuo	Relative Humidity :	45~54%

Mod.	Data Rate	N _{TX}	Channel	Freq. (MHz)	RF Output Power (dBm)	Power Limit (dBm)	DG (dBi)	Pass/Fail
11b	5.5Mbps	1	1	2412	19.77	30	0.00	Pass
11b	5.5Mbps	1	6	2437	20.08	30	0.00	Pass
11b	5.5Mbps	1	11	2462	20.03	30	0.00	Pass
11g	6Mbps	1	1	2412	21.66	30	0.00	Pass
11g	6Mbps	1	6	2437	22.08	30	0.00	Pass
11g	6Mbps	1	11	2462	20.70	30	0.00	Pass
HT20	MCS0	1	1	2412	21.62	30	0.00	Pass
HT20	MCS0	1	6	2437	22.24	30	0.00	Pass
HT20	MCS0	1	11	2462	19.25	30	0.00	Pass
VHT20	MCS0	1	1	2412	21.32	30	0.00	Pass
VHT20	MCS0	1	6	2437	21.23	30	0.00	Pass
VHT20	MCS0	1	11	2462	19.82	30	0.00	Pass



3.2.6 Test Result of Average output Power (Reporting Only)

Test Mode :	2.4GHz	Temperature :	21~26°C
Test Engineer :	Alex Lee, Kenny Chen, and Bill Kuo	Relative Humidity :	45~54%

Mod.	Data Rate	N _{TX}	Channel	Freq. (MHz)	Duty Factor (dB)	Average Output Power (dBm)	Power Limit (dBm)	DG (dBi)	Pass/Fail
11b	5.5Mbps	1	1	2412	0.49	17.78	30	0.00	Pass
11b	5.5Mbps	1	6	2437	0.49	17.97	30	0.00	Pass
11b	5.5Mbps	1	11	2462	0.49	17.93	30	0.00	Pass
11g	6Mbps	1	1	2412	0.76	14.42	30	0.00	Pass
11g	6Mbps	1	6	2437	0.76	15.81	30	0.00	Pass
11g	6Mbps	1	11	2462	0.76	11.81	30	0.00	Pass
HT20	MCS0	1	1	2412	0.77	13.42	30	0.00	Pass
HT20	MCS0	1	6	2437	0.77	15.95	30	0.00	Pass
HT20	MCS0	1	11	2462	0.77	10.75	30	0.00	Pass
VHT20	MCS0	1	1	2412	0.81	12.61	30	0.00	Pass
VHT20	MCS0	1	6	2437	0.81	13.09	30	0.00	Pass
VHT20	MCS0	1	11	2462	0.81	11.04	30	0.00	Pass

3.3 Power Spectral Density Measurement

3.3.1 Limit of Power Spectral Density

The peak power spectral density shall not be greater than 8dBm in any 3kHz band at any time interval of continuous transmission.

3.3.2 Measuring Instruments

The measuring equipment is listed in the section 4 of this test report.

3.3.3 Test Procedures

1. The testing follows Measurement Procedure 10.2 Method PKPSD of FCC KDB Publication No. 558074 D01 DTS Meas. Guidance v03r02
2. The RF output of EUT was connected to the spectrum analyzer by RF cable and attenuator. The path loss was compensated to the results for each measurement.
3. Set to the maximum power setting and enable the EUT transmit continuously.
4. Make the measurement with the spectrum analyzer's resolution bandwidth (RBW) = 3 kHz. Video bandwidth VBW = 10 kHz In order to make an accurate measurement, set the span to 1.5 times DTS Channel Bandwidth. (6dB BW)
5. Detector = peak, Sweep time = auto couple, Trace mode = max hold, Allow trace to fully stabilize. Use the peak marker function to determine the maximum power level.
6. Measure and record the results in the test report.

3.3.4 Test Setup

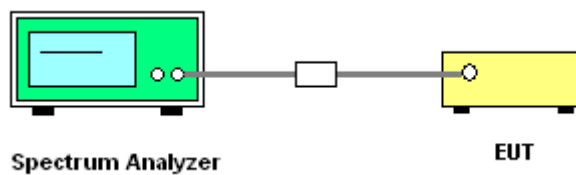



3.3.5 Test Result of Power Spectral Density

Test Mode :	2.4GHz	Temperature :	21~26°C
Test Engineer :	Alex Lee, Kenny Chen, and Bill Kuo	Relative Humidity :	45~54%

Mod.	Data Rate	N _{TX}	Channel	Freq. (MHz)	Peak Power Density (dBm/3kHz)	Max. Limits (dBm/3kHz)	DG (dBi)	Pass/Fail
11b	5.5Mbps	1	1	2412	-4.88	8	0.00	Pass
11b	5.5Mbps	1	6	2437	-4.48	8	0.00	Pass
11b	5.5Mbps	1	11	2462	-5.42	8	0.00	Pass
11g	6Mbps	1	1	2412	-10.63	8	0.00	Pass
11g	6Mbps	1	6	2437	-8.13	8	0.00	Pass
11g	6Mbps	1	11	2462	-12.77	8	0.00	Pass
HT20	MCS0	1	1	2412	-11.64	8	0.00	Pass
HT20	MCS0	1	6	2437	-5.17	8	0.00	Pass
HT20	MCS0	1	11	2462	-14.73	8	0.00	Pass
VHT20	MCS0	1	1	2412	-11.19	8	0.00	Pass
VHT20	MCS0	1	6	2437	-12.40	8	0.00	Pass
VHT20	MCS0	1	11	2462	-14.01	8	0.00	Pass

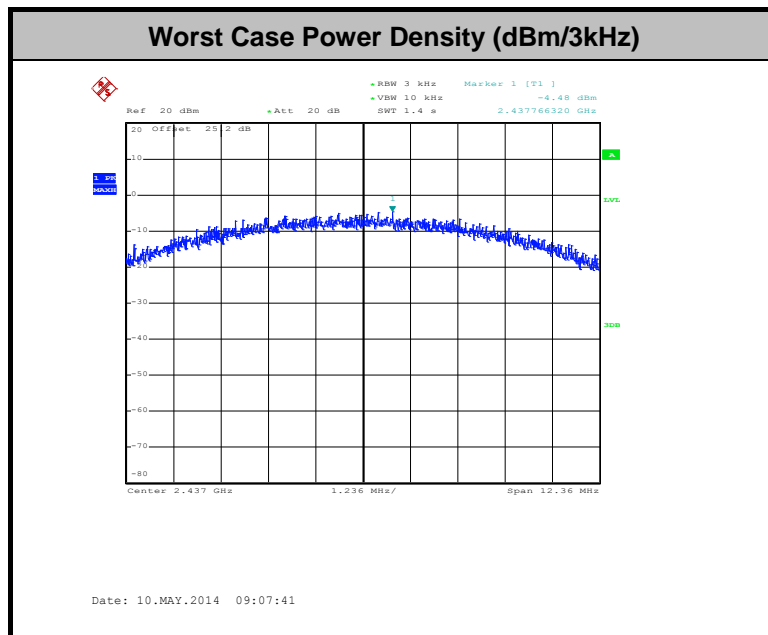

3.4 Conducted Band Edges and Spurious Emission Measurement

3.4.1 Limit of Conducted Band Edges and Spurious Emission Measurement

In any 100 kHz bandwidth outside of the authorized frequency band, the emissions which fall in the non-restricted bands shall be attenuated at least 20 dB / 30dB relative to the maximum PSD level in 100 kHz by RF conducted measurement and radiated emissions which fall in the restricted bands, as defined in Section 15.205(a), must also comply with the radiated emission limits specified in Section 15.209(a).

3.4.2 Measuring Instruments

The measuring equipment is listed in the section 4 of this test report.

3.4.3 Test Procedures

1. The testing follows FCC KDB Publication No. 558074 D01 DTS Meas. Guidance v03r02.
2. The RF output of EUT was connected to the spectrum analyzer by RF cable and attenuator. The path loss was compensated to the results for each measurement.
3. Set to the maximum power setting and enable the EUT transmit continuously.
4. Set RBW = 100 kHz, VBW=300 kHz, Peak Detector. Unwanted Emissions measured in any 100 kHz bandwidth outside of the authorized frequency band shall be attenuated by at least 20 dB relative to the maximum in-band peak PSD level in 100 kHz when maximum peak conducted output power procedure is used. If the transmitter complies with the conducted power limits based on the use of RMS averaging over a time interval, the attenuation required under this paragraph shall be 30 dB instead of 20 dB per 15.247(d).
5. Measure and record the results in the test report.
6. The RF fundamental frequency should be excluded against the limit line in the operating frequency band.

3.4.4 Test Setup

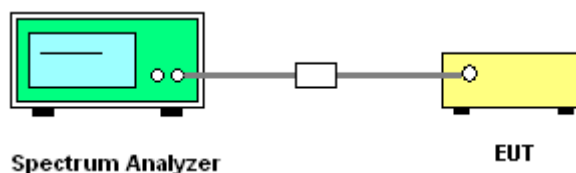



3.4.5 Test Result of Conducted Band Edges and Spurious Emission

Test Mode :	802.11b	Temperature :	21~26°C
Test Band :	2.4GHz Low	Relative Humidity :	45~54%
Test Channel :	01	Test Engineer :	Alex Lee, Kenny Chen, and Bill Kuo

WLAN 802.11b Channel 01

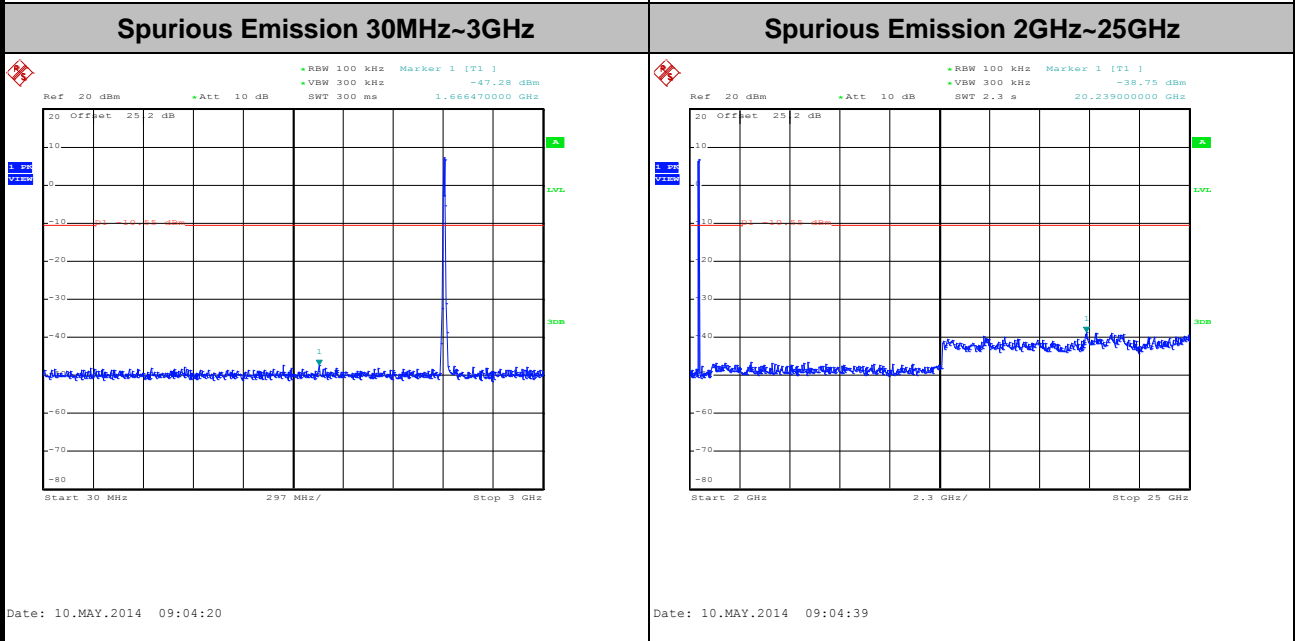
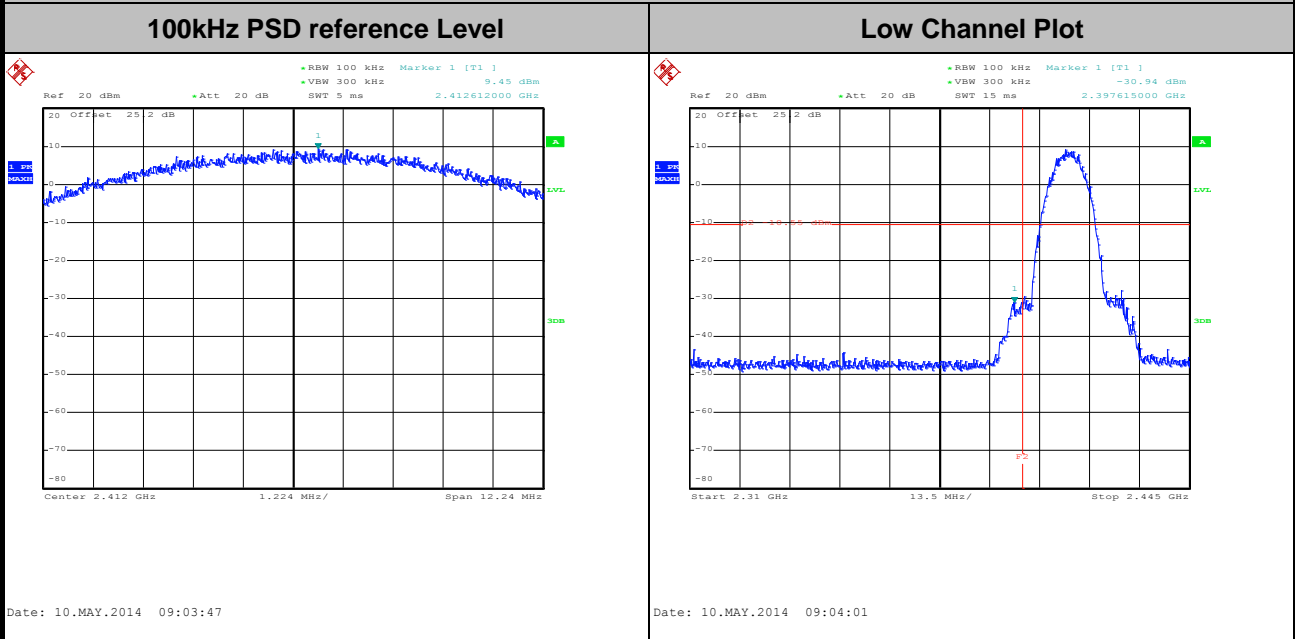



Test Mode :	802.11b	Temperature :	21~26°C
Test Band :	2.4GHz Mid	Relative Humidity :	45~54%
Test Channel :	06	Test Engineer :	Alex Lee, Kenny Chen, and Bill Kuo

WLAN 802.11b Channel 06

100kHz PSD reference Level

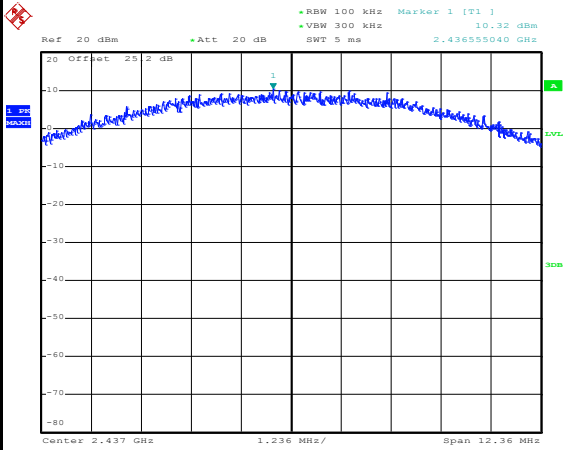

Date: 10.MAY.2014 09:07:50

Spurious Emission 30MHz~3GHz

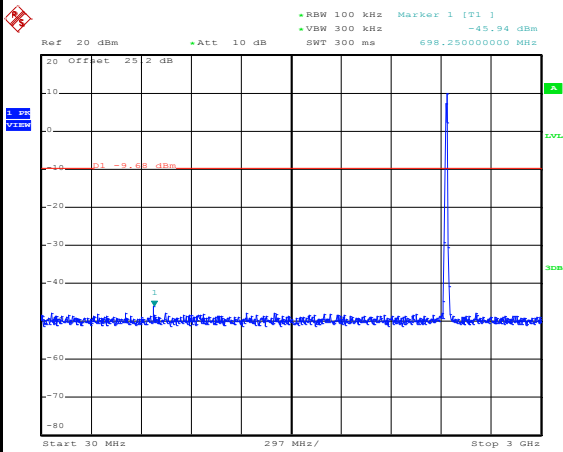

Date: 10.MAY.2014 09:08:10

Spurious Emission 2GHz~25GHz

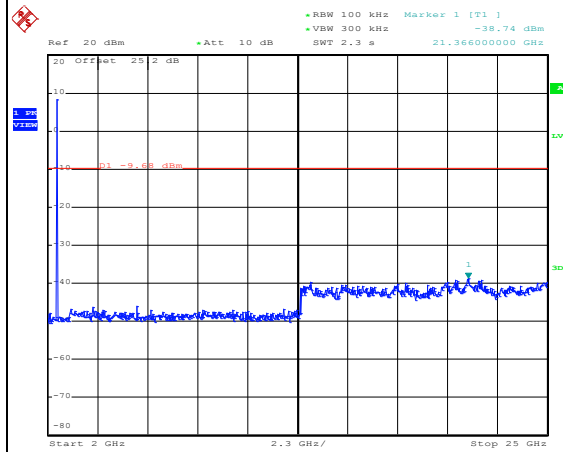

Date: 10.MAY.2014 09:08:28



Test Mode :	802.11b	Temperature :	21~26°C
Test Band :	2.4GHz High	Relative Humidity :	45~54%
Test Channel :	11	Test Engineer :	Alex Lee, Kenny Chen, and Bill Kuo

WLAN 802.11b Channel 11

100kHz PSD reference Level

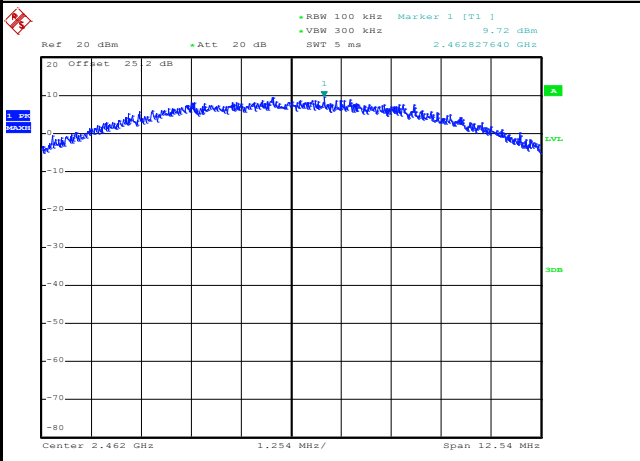

Date: 10.MAY.2014 09:11:20

High Channel Plot

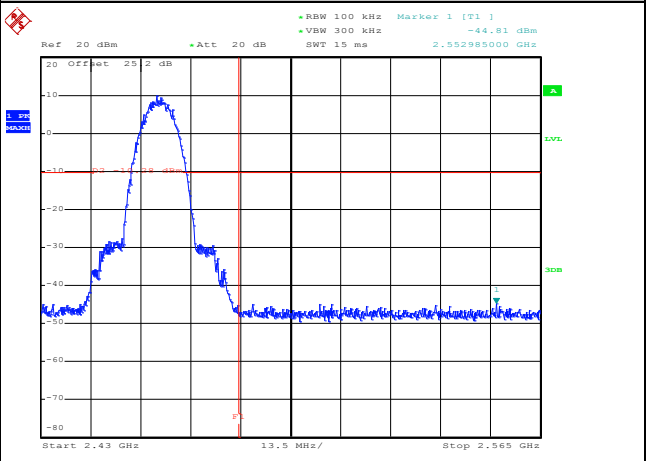

Date: 10.MAY.2014 09:11:34

Spurious Emission 30MHz~3GHz

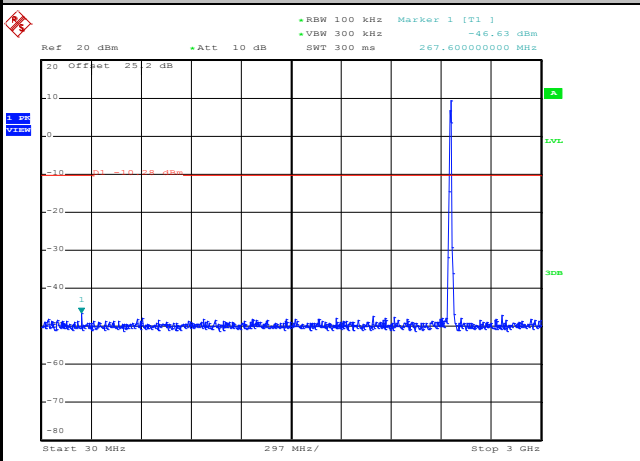

Date: 10.MAY.2014 09:11:53

Spurious Emission 2GHz~25GHz

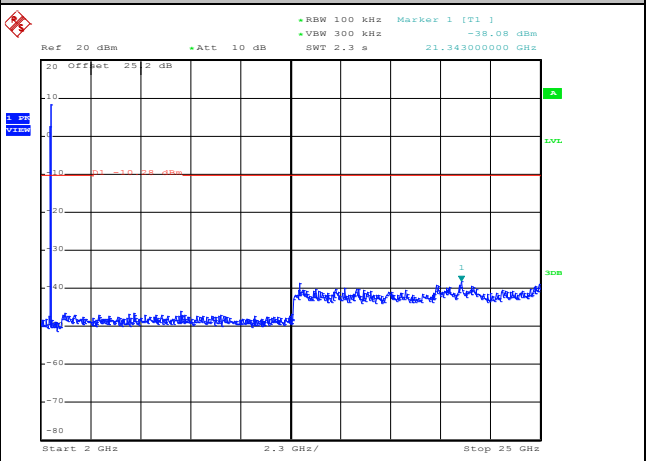

Date: 10.MAY.2014 09:12:12



Test Mode :	802.11g	Temperature :	21~26°C
Test Band :	2.4GHz Low	Relative Humidity :	45~54%
Test Channel :	01	Test Engineer :	Alex Lee, Kenny Chen, and Bill Kuo

WLAN 802.11g Channel 01

100kHz PSD reference Level

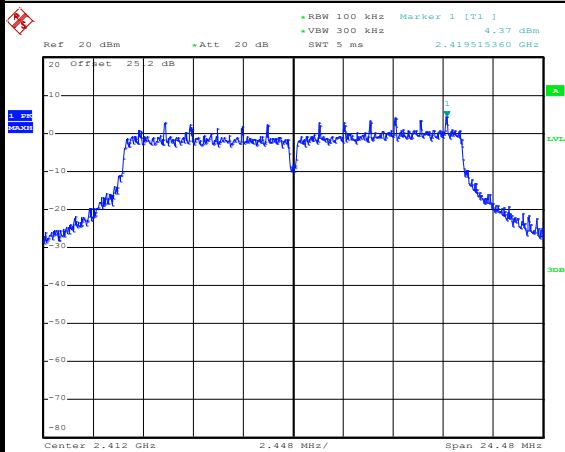

Date: 11.JUN.2014 14:53:23

Low Channel Plot

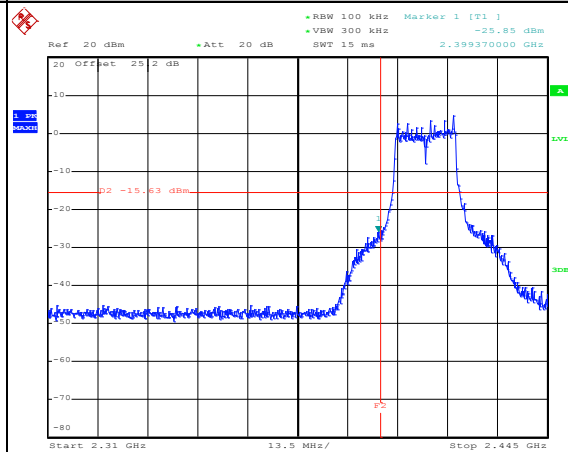

Date: 11.JUN.2014 14:53:37

Spurious Emission 30MHz~3GHz

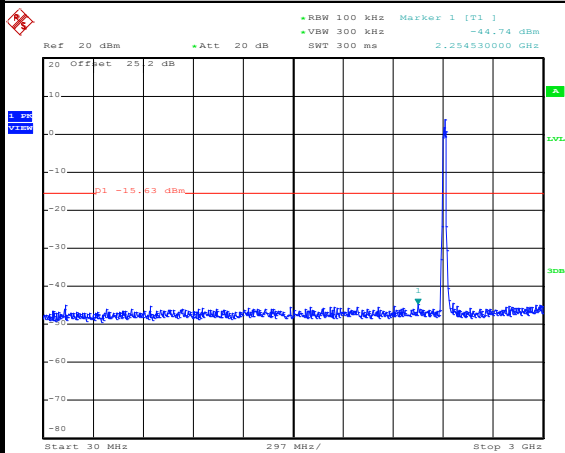

Date: 11.JUN.2014 14:53:56

Spurious Emission 2GHz~25GHz

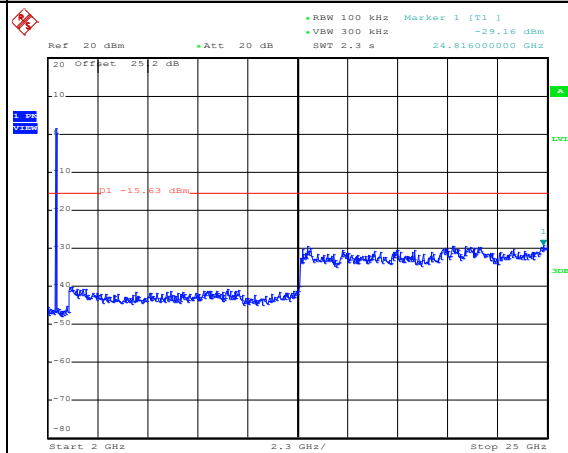

Date: 11.JUN.2014 14:54:15



Test Mode :	802.11g	Temperature :	21~26°C
Test Band :	2.4GHz Mid	Relative Humidity :	45~54%
Test Channel :	06	Test Engineer :	Alex Lee, Kenny Chen, and Bill Kuo

WLAN 802.11g Channel 06

100kHz PSD reference Level

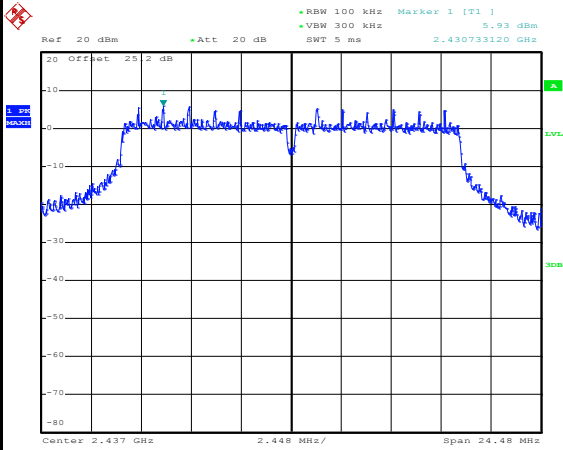

Date: 10.MAY.2014 09:20:37

Spurious Emission 30MHz~3GHz

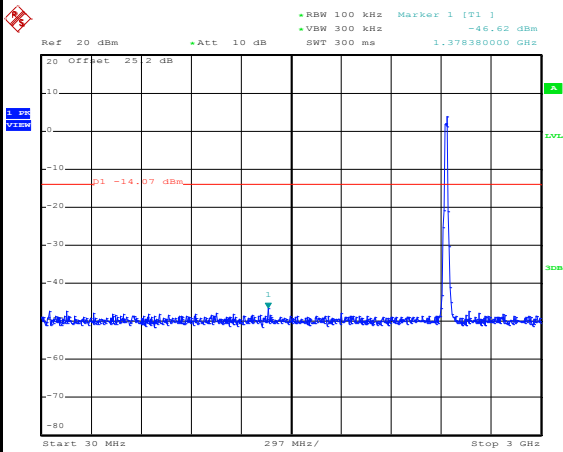

Date: 10.MAY.2014 09:20:57

Spurious Emission 2GHz~25GHz

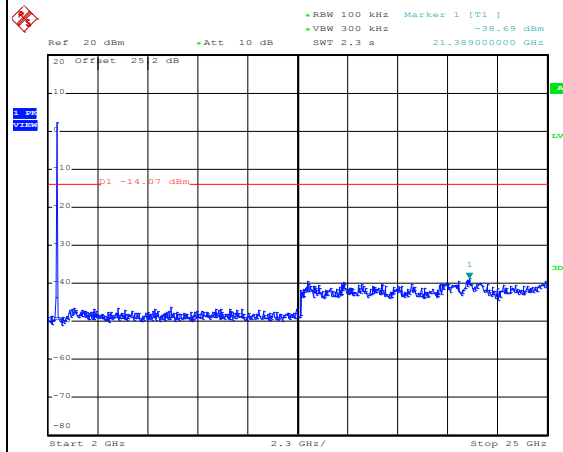

Date: 10.MAY.2014 09:21:16



Test Mode :	802.11g	Temperature :	21~26°C
Test Band :	2.4GHz High	Relative Humidity :	45~54%
Test Channel :	11	Test Engineer :	Alex Lee, Kenny Chen, and Bill Kuo

WLAN 802.11g Channel 11

100kHz PSD reference Level

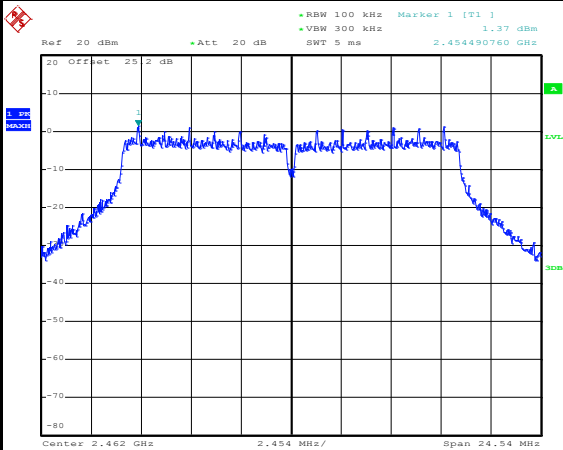

Date: 11.JUN.2014 14:58:20

High Channel Plot

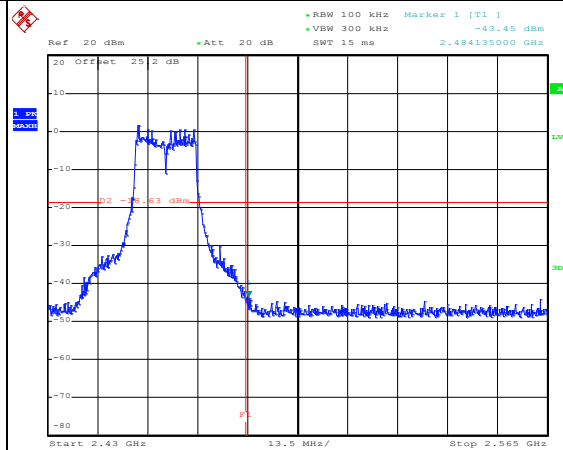

Date: 11.JUN.2014 14:58:34

Spurious Emission 30MHz~3GHz

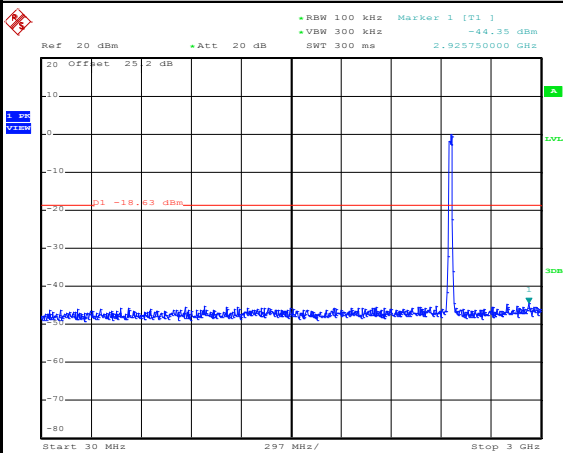

Date: 11.JUN.2014 14:58:53

Spurious Emission 2GHz~25GHz

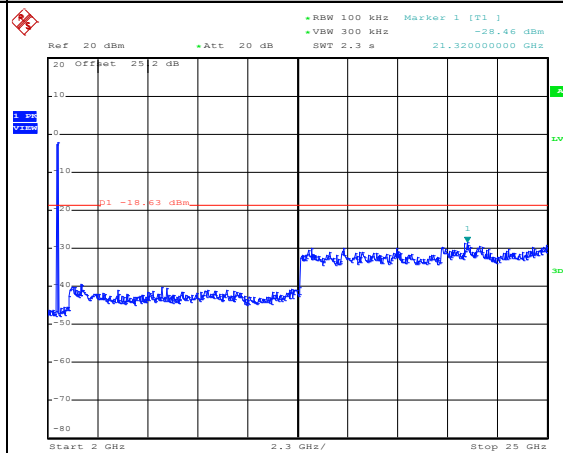

Date: 11.JUN.2014 14:59:12



Test Mode :	802.11n HT20	Temperature :	21~26°C
Test Band :	2.4GHz Low	Relative Humidity :	45~54%
Test Channel :	01	Test Engineer :	Alex Lee, Kenny Chen, and Bill Kuo

WLAN 802.11n HT20 Channel 01

100kHz PSD reference Level

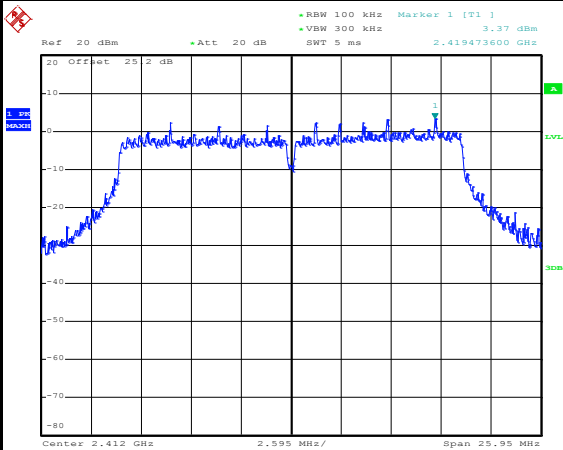

Date: 11.JUN.2014 15:11:00

Low Channel Plot

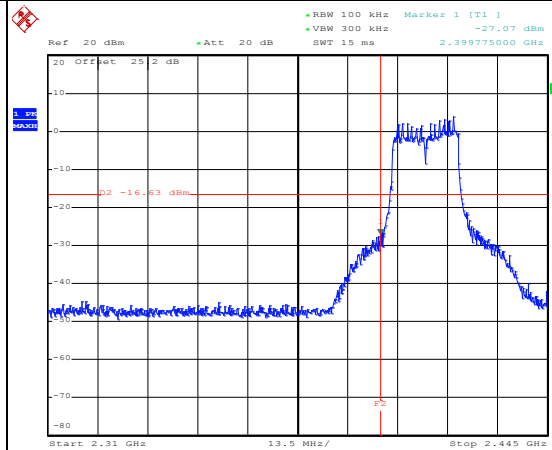

Date: 11.JUN.2014 15:11:14

Spurious Emission 30MHz~3GHz

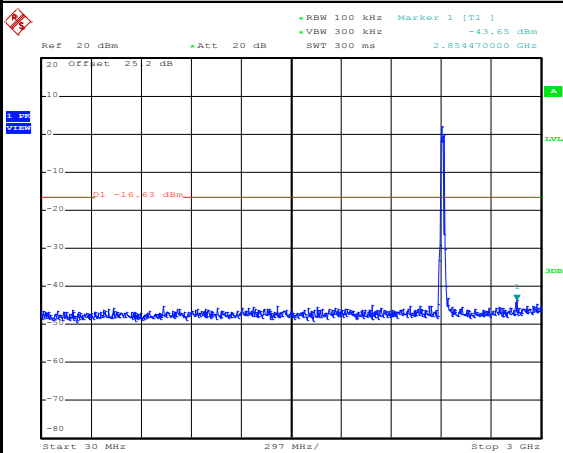

Date: 11.JUN.2014 15:11:33

Spurious Emission 2GHz~25GHz

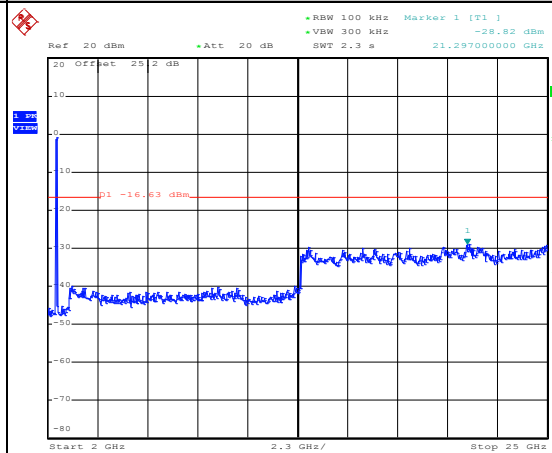

Date: 11.JUN.2014 15:11:52



Test Mode :	802.11n HT20	Temperature :	21~26°C
Test Band :	2.4GHz Mid	Relative Humidity :	45~54%
Test Channel :	06	Test Engineer :	Alex Lee, Kenny Chen, and Bill Kuo

WLAN 802.11n HT20 Channel 06

100kHz PSD reference Level

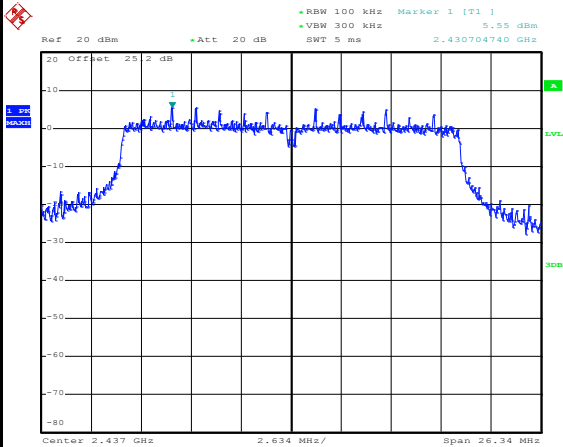

Date: 10.MAY.2014 09:30:06

Spurious Emission 30MHz~3GHz

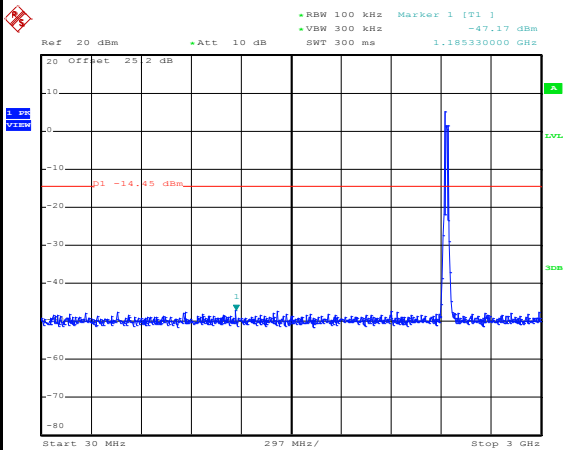

Date: 10.MAY.2014 09:30:26

Spurious Emission 2GHz~25GHz

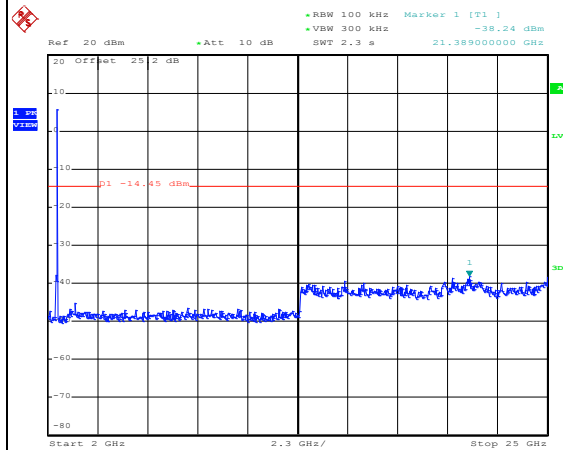

Date: 10.MAY.2014 09:30:44



Test Mode :	802.11n HT20	Temperature :	21~26°C
Test Band :	2.4GHz High	Relative Humidity :	45~54%
Test Channel :	11	Test Engineer :	Alex Lee, Kenny Chen, and Bill Kuo

WLAN 802.11n HT20 Channel 11

100kHz PSD reference Level

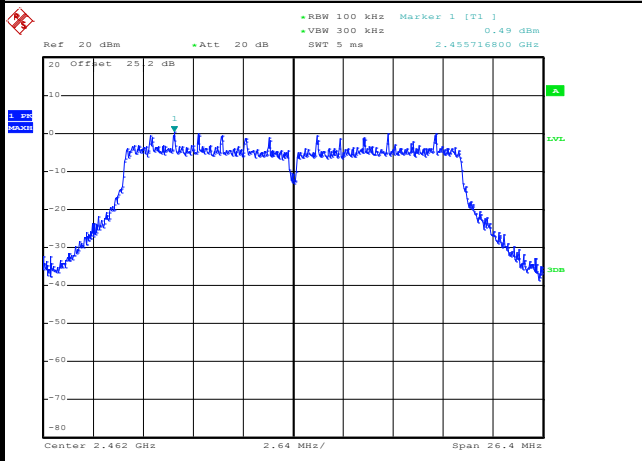

Date: 11.JUN.2014 15:06:21

High Channel Plot

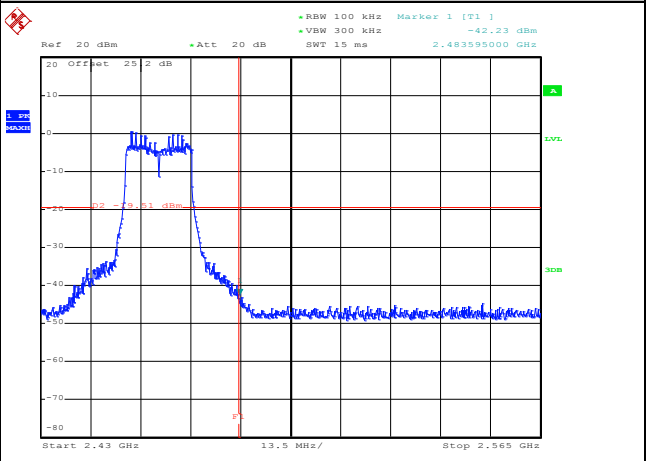

Date: 11.JUN.2014 15:06:35

Spurious Emission 30MHz~3GHz

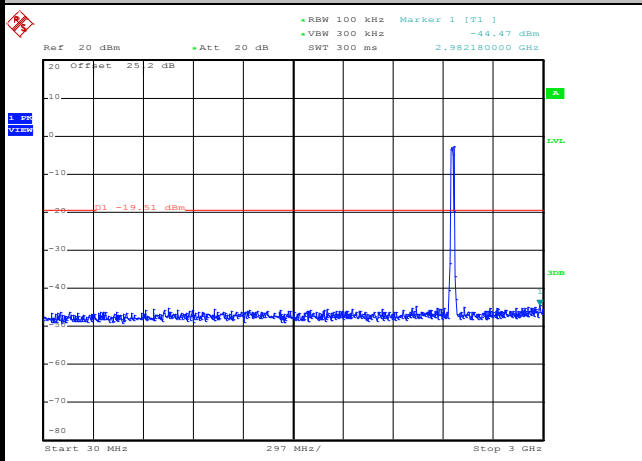

Date: 11.JUN.2014 15:06:54

Spurious Emission 2GHz~25GHz

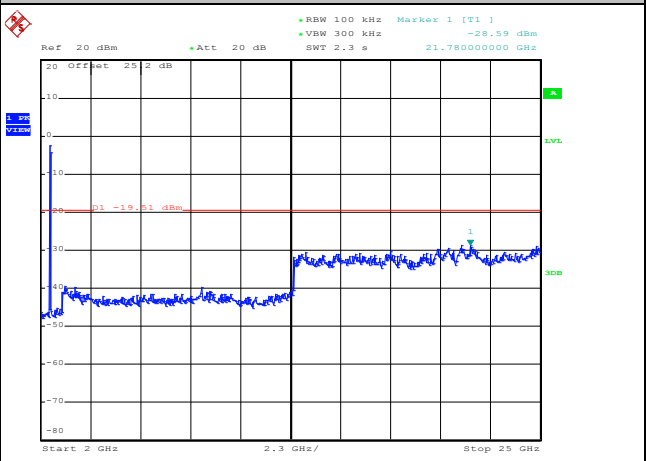

Date: 11.JUN.2014 15:07:13



Test Mode :	802.11ac VHT20	Temperature :	21~26°C
Test Band :	2.4GHz Low	Relative Humidity :	45~54%
Test Channel :	01	Test Engineer :	Alex Lee, Kenny Chen, and Bill Kuo

WLAN 802.11ac VHT20 Channel 01

100kHz PSD reference Level

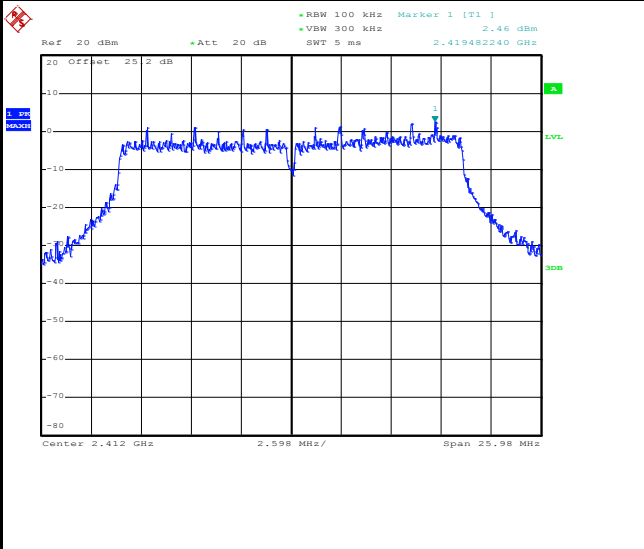

Low Channel Plot

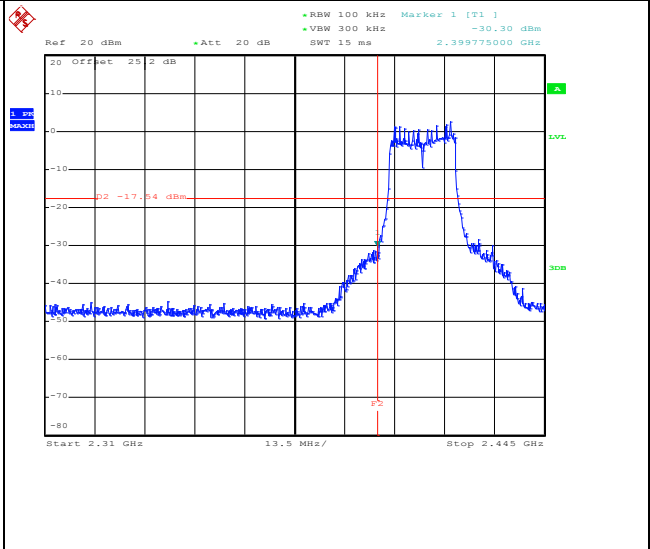

Spurious Emission 30MHz~3GHz

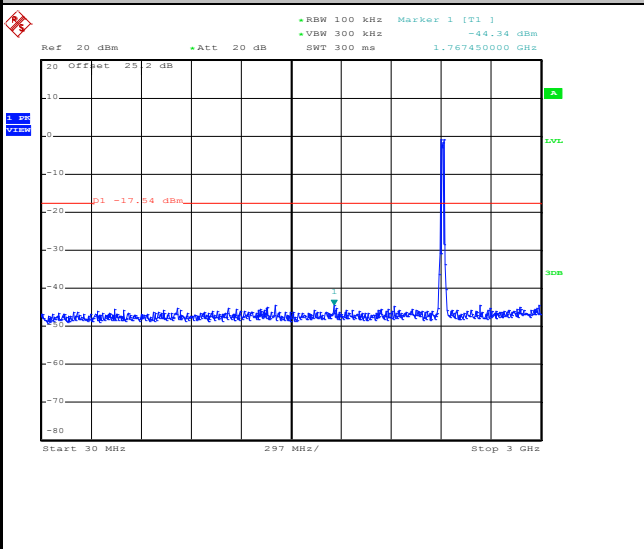

Spurious Emission 2GHz~25GHz

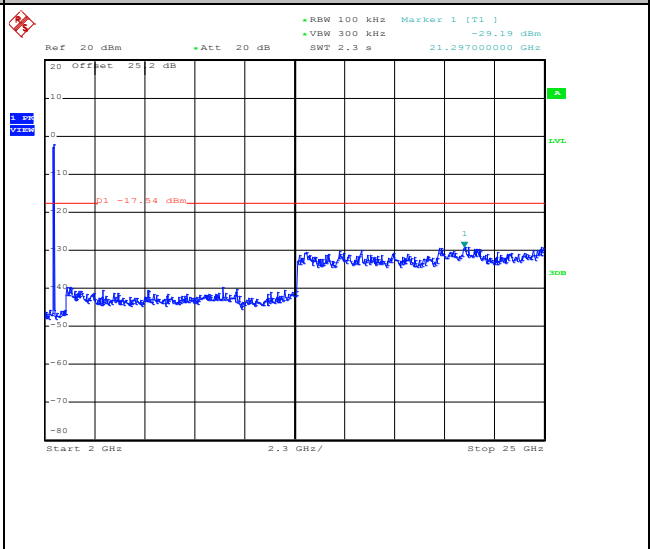



Test Mode :	802.11ac VHT20	Temperature :	21~26°C
Test Band :	2.4GHz Mid	Relative Humidity :	45~54%
Test Channel :	06	Test Engineer :	Alex Lee, Kenny Chen, and Bill Kuo

WLAN 802.11ac VHT20 Channel 06

100kHz PSD reference Level

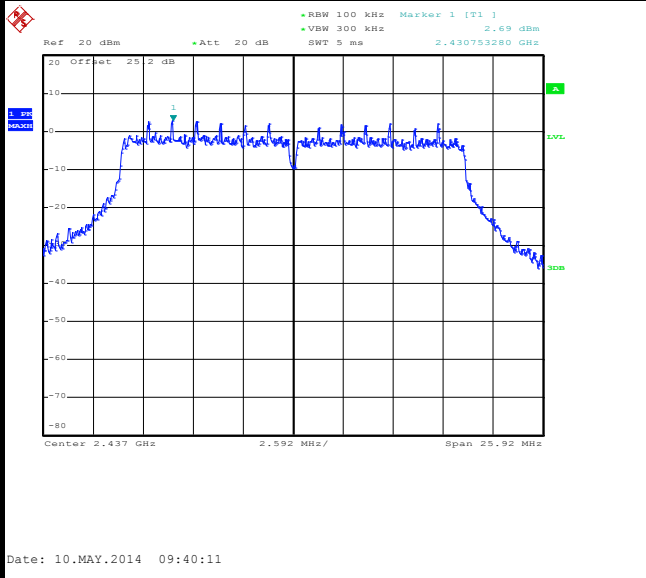

Spurious Emission 30MHz~3GHz

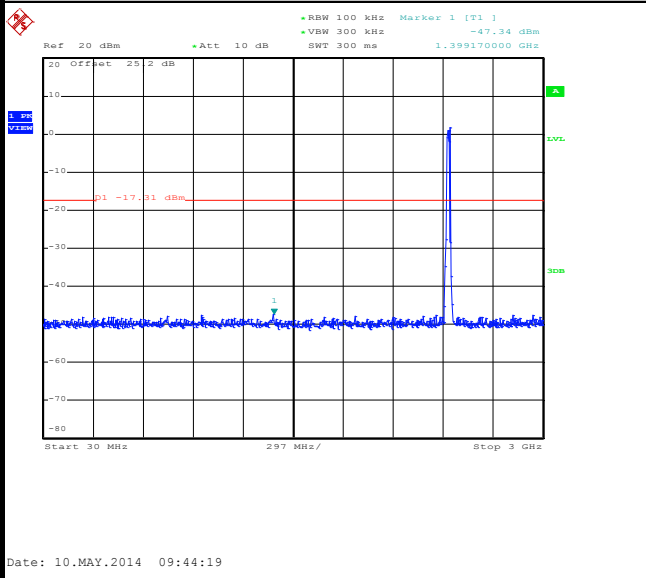

Spurious Emission 2GHz~25GHz

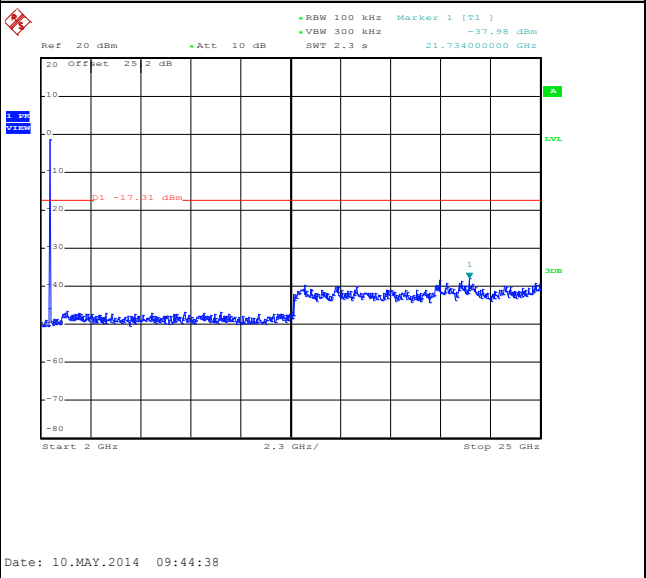



Test Mode :	802.11ac VHT20	Temperature :	21~26°C
Test Band :	2.4GHz High	Relative Humidity :	45~54%
Test Channel :	11	Test Engineer :	Alex Lee, Kenny Chen, and Bill Kuo

WLAN 802.11ac VHT20 Channel 11

100kHz PSD reference Level

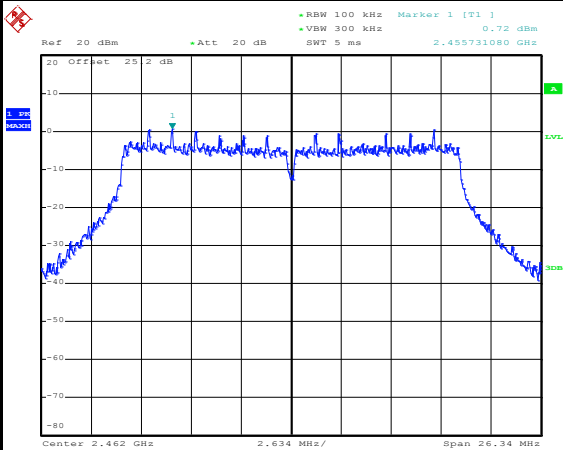

Date: 11.JUN.2014 15:20:42

High Channel Plot

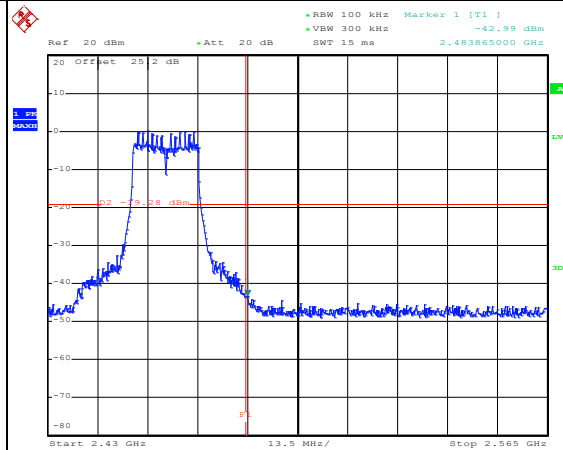

Date: 11.JUN.2014 15:20:56

Spurious Emission 30MHz~3GHz

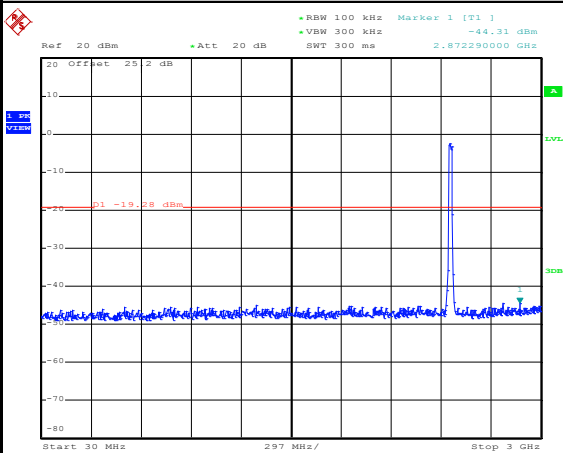

Date: 11.JUN.2014 15:21:15

Spurious Emission 2GHz~25GHz

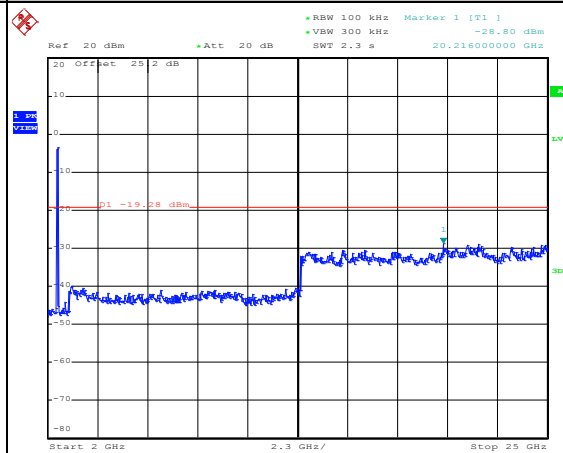

Date: 11.JUN.2014 15:21:34



3.5 Radiated Band Edges and Spurious Emission Measurement

3.5.1 Limit of Radiated band edge and Spurious Emission Measurement

In any 100 kHz bandwidth outside the intentional radiator frequency band, all harmonics/spurious must be at least 20 dB below the highest emission level within the authorized band. If the output power of this device was measured by spectrum analyzer, the attenuation under this paragraph shall be 30 dB instead of 20 dB. In addition, radiated emissions which fall in the restricted bands must also comply with the FCC section 15.209 limits as below.

Frequency (MHz)	Field Strength (microvolts/meter)	Measurement Distance (meters)
0.009 – 0.490	2400/F(kHz)	300
0.490 – 1.705	24000/F(kHz)	30
1.705 – 30.0	30	30
30 – 88	100	3
88 – 216	150	3
216 - 960	200	3
Above 960	500	3

3.5.2 Measuring Instruments

The measuring equipment is listed in the section 4 of this test report.



3.5.3 Test Procedures

1. The testing follows FCC KDB Publication No. 558074 D01 DTS Meas. Guidance v03r02.
2. The EUT was arranged to its worst case and then tune the antenna tower (from 1 m to 4 m) and turntable (from 0 degree to 360 degrees) to find the maximum reading. A pre-amp and a high pass filter are used for the test in order to get better signal level.
3. The EUT was placed on a turntable with 0.8 meter above ground.
4. The EUT was set 3 meters from the interference receiving antenna, which was mounted on the top of a variable height antenna tower.
5. Corrected Reading: Antenna Factor + Cable Loss + Read Level - Preamp Factor = Level
6. For measurement below 1GHz, If the emission level of the EUT measured by the peak detector is 3 dB lower than the applicable limit, the peak emission level will be reported. Otherwise, the emission measurement will be repeated using the quasi-peak detector and reported.
7. Use the following spectrum analyzer settings:
 - (1) Span shall wide enough to fully capture the emission being measured;
 - (2) Set RBW=100 kHz for f < 1 GHz; VBW ≥ RBW; Sweep = auto; Detector function = peak; Trace = max hold;
 - (3) Set RBW = 1 MHz, VBW= 3MHz for f ≥ 1 GHz for peak measurement.

For average measurement:

 - VBW = 10 Hz, when duty cycle is no less than 98 percent.
 - VBW ≥ 1/T, when duty cycle is less than 98 percent where T is the minimum transmission duration over which the transmitter is on and is transmitting at its maximum power control level for the tested mode of operation.

Band	Duty Cycle(%)	T(μs)	1/T(kHz)	VBW Setting
802.11b	89.25	1660	0.60	1kHz
802.11g	83.87	1040	0.96	1kHz
2.4GHz 802.11n HT20	83.76	980	1.02	3kHz
2.4GHz 802.11ac VHT20	83.05	980	1.02	3kHz

3.5.4 Test Setup

For radiated emissions below 30MHz

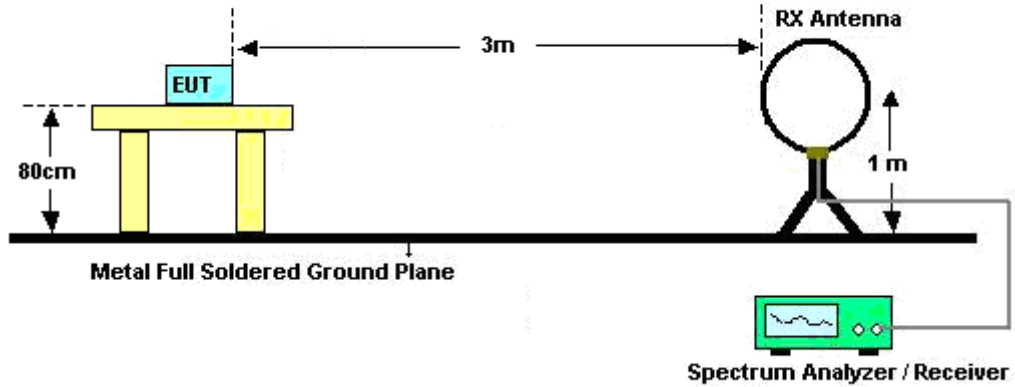

For radiated emissions from 30MHz to 1GHz

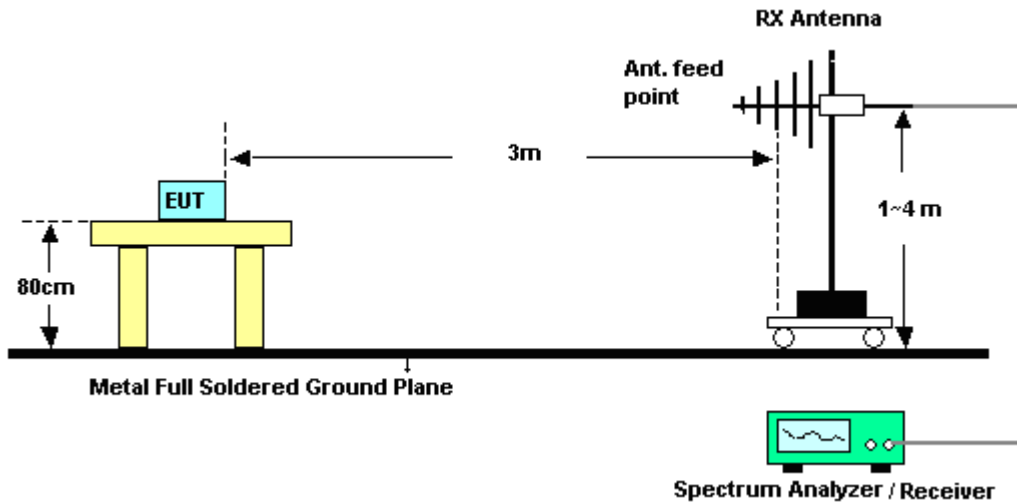

For radiated emissions above 1GHz

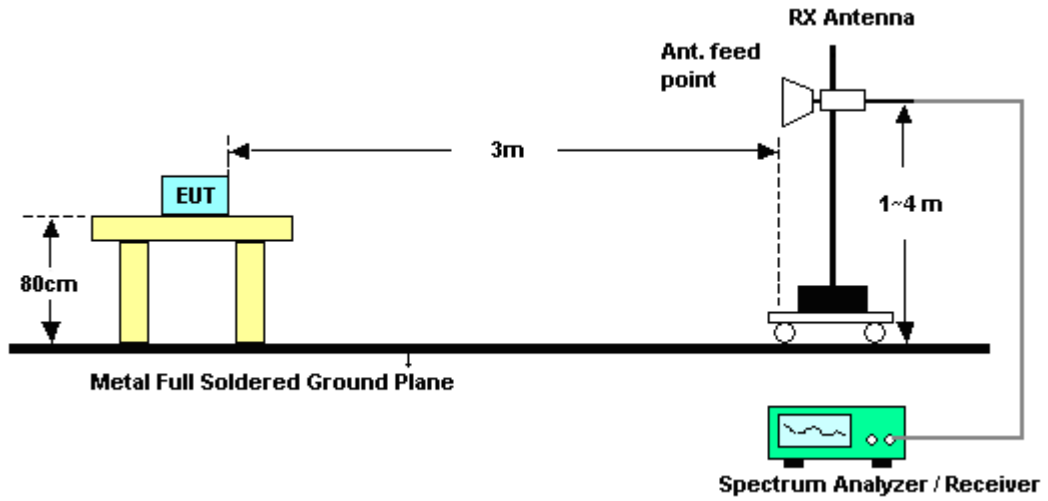

3.5.5 Test Results of Radiated Spurious Emissions (9kHz ~ 30MHz)

The low frequency, which started from 9 kHz to 30MHz, was pre-scanned and the result which was 20dB lower than the limit line per 15.31(o) was not reported.



3.5.6 Test Result of Radiated Spurious at Band Edges

Test Mode :	802.11b	Temperature :	20~23°C
Test Band :	Low	Relative Humidity :	52~53%
Test Channel :	01	Test Engineer :	Hayden Wu

ANTENNA POLARITY : HORIZONTAL										
Frequency (MHz)	Level (dB μ V/m)	Over Limit (dB)	Limit Line (dB μ V/m)	Read Level (dB μ V)	Antenna Factor (dB)	Cable Loss (dB)	Preamp Factor (dB)	Ant Pos (cm)	Table Pos (deg)	Remark
2390	50.39	-23.61	74	46.66	31.92	6.45	34.64	122	311	Peak
2389.83	38.8	-15.2	54	35.07	31.92	6.45	34.64	122	311	Average

ANTENNA POLARITY : VERTICAL										
Frequency (MHz)	Level (dB μ V/m)	Over Limit (dB)	Limit Line (dB μ V/m)	Read Level (dB μ V)	Antenna Factor (dB)	Cable Loss (dB)	Preamp Factor (dB)	Ant Pos (cm)	Table Pos (deg)	Remark
2390	50.28	-23.72	74	46.55	31.92	6.45	34.64	106	336	Peak
2390	39.38	-14.62	54	35.65	31.92	6.45	34.64	106	336	Average

Test Mode :	802.11b	Temperature :	20~23°C
Test Band :	High	Relative Humidity :	52~53%
Test Channel :	11	Test Engineer :	Hayden Wu

ANTENNA POLARITY : HORIZONTAL										
Frequency (MHz)	Level (dB μ V/m)	Over Limit (dB)	Limit Line (dB μ V/m)	Read Level (dB μ V)	Antenna Factor (dB)	Cable Loss (dB)	Preamp Factor (dB)	Ant Pos (cm)	Table Pos (deg)	Remark
2483.71	55.36	-18.64	74	51.41	31.99	6.59	34.63	106	333	Peak
2483.53	44.5	-9.5	54	40.55	31.99	6.59	34.63	106	333	Average

ANTENNA POLARITY : VERTICAL										
Frequency (MHz)	Level (dB μ V/m)	Over Limit (dB)	Limit Line (dB μ V/m)	Read Level (dB μ V)	Antenna Factor (dB)	Cable Loss (dB)	Preamp Factor (dB)	Ant Pos (cm)	Table Pos (deg)	Remark
2491.21	50.15	-23.85	74	46.19	32	6.59	34.63	100	328	Peak
2483.65	39.18	-14.82	54	35.23	31.99	6.59	34.63	100	328	Average



Test Mode :	802.11g	Temperature :	20~23°C
Test Band :	Low	Relative Humidity :	52~53%
Test Channel :	01	Test Engineer :	Hayden Wu

ANTENNA POLARITY : HORIZONTAL										
Frequency (MHz)	Level (dBµV/m)	Over Limit (dB)	Limit Line (dBµV/m)	Read Level (dBµV)	Antenna Factor (dB)	Cable Loss (dB)	Preamp Factor (dB)	Ant Pos (cm)	Table Pos (deg)	Remark
2389.92	72.91	-1.09	74	69.18	31.92	6.45	34.64	104	335	Peak
2390.01	51.17	-2.83	54	47.44	31.92	6.45	34.64	104	335	Average

ANTENNA POLARITY : VERTICAL										
Frequency (MHz)	Level (dBµV/m)	Over Limit (dB)	Limit Line (dBµV/m)	Read Level (dBµV)	Antenna Factor (dB)	Cable Loss (dB)	Preamp Factor (dB)	Ant Pos (cm)	Table Pos (deg)	Remark
2389.56	68.53	-5.47	74	64.81	31.92	6.45	34.65	100	317	Peak
2390.01	48.53	-5.47	54	44.8	31.92	6.45	34.64	100	317	Average

Test Mode :	802.11g	Temperature :	20~23°C
Test Band :	High	Relative Humidity :	52~53%
Test Channel :	11	Test Engineer :	Hayden Wu

ANTENNA POLARITY : HORIZONTAL										
Frequency (MHz)	Level (dBµV/m)	Over Limit (dB)	Limit Line (dBµV/m)	Read Level (dBµV)	Antenna Factor (dB)	Cable Loss (dB)	Preamp Factor (dB)	Ant Pos (cm)	Table Pos (deg)	Remark
2483.68	73.13	-0.87	74	69.18	31.99	6.59	34.63	105	336	Peak
2483.5	52.79	-1.21	54	48.84	31.99	6.59	34.63	105	336	Average

ANTENNA POLARITY : VERTICAL										
Frequency (MHz)	Level (dBµV/m)	Over Limit (dB)	Limit Line (dBµV/m)	Read Level (dBµV)	Antenna Factor (dB)	Cable Loss (dB)	Preamp Factor (dB)	Ant Pos (cm)	Table Pos (deg)	Remark
2483.89	65.77	-8.23	74	61.82	31.99	6.59	34.63	162	80	Peak
2483.71	46.04	-7.96	54	42.09	31.99	6.59	34.63	162	80	Average



Test Mode :	802.11n HT20	Temperature :	20~23°C
Test Band :	Low	Relative Humidity :	52~53%
Test Channel :	01	Test Engineer :	Hayden Wu

ANTENNA POLARITY : HORIZONTAL										
Frequency (MHz)	Level (dBμV/m)	Over Limit (dB)	Limit Line (dBμV/m)	Read Level (dBμV)	Antenna Factor (dB)	Cable Loss (dB)	Preamp Factor (dB)	Ant Pos (cm)	Table Pos (deg)	Remark
2389.2	72.23	-1.77	74	68.51	31.92	6.45	34.65	107	342	Peak
2390	51.22	-2.78	54	47.49	31.92	6.45	34.64	107	342	Average

ANTENNA POLARITY : VERTICAL										
Frequency (MHz)	Level (dBμV/m)	Over Limit (dB)	Limit Line (dBμV/m)	Read Level (dBμV)	Antenna Factor (dB)	Cable Loss (dB)	Preamp Factor (dB)	Ant Pos (cm)	Table Pos (deg)	Remark
2388.84	69.08	-4.92	74	65.36	31.92	6.45	34.65	100	317	Peak
2390	49.83	-4.17	54	46.1	31.92	6.45	34.64	100	317	Average

Test Mode :	802.11n HT20	Temperature :	20~23°C
Test Band :	High	Relative Humidity :	52~53%
Test Channel :	11	Test Engineer :	Hayden Wu

ANTENNA POLARITY : HORIZONTAL										
Frequency (MHz)	Level (dBμV/m)	Over Limit (dB)	Limit Line (dBμV/m)	Read Level (dBμV)	Antenna Factor (dB)	Cable Loss (dB)	Preamp Factor (dB)	Ant Pos (cm)	Table Pos (deg)	Remark
2484.1	72.76	-1.24	74	68.81	31.99	6.59	34.63	104	334	Peak
2483.5	52.15	-1.85	54	48.2	31.99	6.59	34.63	104	334	Average

ANTENNA POLARITY : VERTICAL										
Frequency (MHz)	Level (dBμV/m)	Over Limit (dB)	Limit Line (dBμV/m)	Read Level (dBμV)	Antenna Factor (dB)	Cable Loss (dB)	Preamp Factor (dB)	Ant Pos (cm)	Table Pos (deg)	Remark
2483.5	66.44	-7.56	74	62.49	31.99	6.59	34.63	135	273	Peak
2483.56	47.74	-6.26	54	43.79	31.99	6.59	34.63	135	273	Average



Test Mode :	802.11ac VHT20	Temperature :	20~23°C
Test Band :	Low	Relative Humidity :	52~53%
Test Channel :	01	Test Engineer :	Hayden Wu

ANTENNA POLARITY : HORIZONTAL										
Frequency (MHz)	Level (dBμV/m)	Over Limit (dB)	Limit Line (dBμV/m)	Read Level (dBμV)	Antenna Factor (dB)	Cable Loss (dB)	Preamp Factor (dB)	Ant Pos (cm)	Table Pos (deg)	Remark
2390.01	73.65	-0.35	74	69.92	31.92	6.45	34.64	105	332	Peak
2390.01	51.55	-2.45	54	47.82	31.92	6.45	34.64	105	332	Average

ANTENNA POLARITY : VERTICAL										
Frequency (MHz)	Level (dBμV/m)	Over Limit (dB)	Limit Line (dBμV/m)	Read Level (dBμV)	Antenna Factor (dB)	Cable Loss (dB)	Preamp Factor (dB)	Ant Pos (cm)	Table Pos (deg)	Remark
2390	70.46	-3.54	74	66.73	31.92	6.45	34.64	120	315	Peak
2390	48.22	-5.78	54	44.49	31.92	6.45	34.64	120	315	Average

Test Mode :	802.11ac VHT20	Temperature :	20~23°C
Test Band :	High	Relative Humidity :	52~53%
Test Channel :	11	Test Engineer :	Hayden Wu

ANTENNA POLARITY : HORIZONTAL										
Frequency (MHz)	Level (dBμV/m)	Over Limit (dB)	Limit Line (dBμV/m)	Read Level (dBμV)	Antenna Factor (dB)	Cable Loss (dB)	Preamp Factor (dB)	Ant Pos (cm)	Table Pos (deg)	Remark
2483.68	72.47	-1.53	74	68.52	31.99	6.59	34.63	104	334	Peak
2483.59	53.38	-0.62	54	49.43	31.99	6.59	34.63	104	334	Average

ANTENNA POLARITY : VERTICAL										
Frequency (MHz)	Level (dBμV/m)	Over Limit (dB)	Limit Line (dBμV/m)	Read Level (dBμV)	Antenna Factor (dB)	Cable Loss (dB)	Preamp Factor (dB)	Ant Pos (cm)	Table Pos (deg)	Remark
2483.71	62.48	-11.52	74	58.53	31.99	6.59	34.63	137	81	Peak
2483.5	44.43	-9.57	54	40.48	31.99	6.59	34.63	137	81	Average



3.5.7 Test Result of Radiated Spurious Emission (30MHz ~ 10th Harmonic)

Note: Pre-scanned all test modes and only choose the worst case mode recorded in the test report for radiated spurious emission below 1GHz.

Test Mode :	802.11b	Temperature :	20~23°C
Test Channel :	01	Relative Humidity :	52~53%
Test Engineer :	Hayden Wu	Polarization :	Horizontal
Remark :	1. 2414 MHz is fundamental signal which can be ignored. 2. Average measurement was not performed if peak level went lower than the average limit.		

Frequency (MHz)	Level (dBμV/m)	Over Limit (dB)	Limit Line (dBμV/m)	Read Level (dBμV)	Antenna Factor (dB)	Cable Loss (dB)	Preamp Factor (dB)	Ant Pos (cm)	Table Pos (deg)	Remark
2414	105.21	-	-	101.43	31.93	6.49	34.64	106	336	Average
2414	110.84	-	-	107.06	31.93	6.49	34.64	106	336	Peak
4824	40.29	-33.71	74	56.53	34.4	10.17	60.81	100	0	Peak

Test Mode :	802.11b	Temperature :	20~23°C
Test Channel :	01	Relative Humidity :	52~53%
Test Engineer :	Hayden Wu	Polarization :	Vertical
Remark :	1. 2414 MHz is fundamental signal which can be ignored. 2. Average measurement was not performed if peak level went lower than the average limit.		

Frequency (MHz)	Level (dBμV/m)	Over Limit (dB)	Limit Line (dBμV/m)	Read Level (dBμV)	Antenna Factor (dB)	Cable Loss (dB)	Preamp Factor (dB)	Ant Pos (cm)	Table Pos (deg)	Remark
2414	100.06	-	-	96.28	31.93	6.49	34.64	122	311	Average
2414	106.35	-	-	102.57	31.93	6.49	34.64	122	311	Peak
4824	40.87	-33.13	74	57.11	34.4	10.17	60.81	100	0	Peak



Test Mode :	802.11b	Temperature :	20~23°C
Test Channel :	06	Relative Humidity :	52~53%
Test Engineer :	Hayden Wu	Polarization :	Horizontal
Remark :	1. 2438 MHz is fundamental signal which can be ignored. 2. Average measurement was not performed if peak level went lower than the average limit.		

Frequency (MHz)	Level (dBµV/m)	Over Limit (dB)	Limit Line (dBµV/m)	Read Level (dBµV)	Antenna Factor (dB)	Cable Loss (dB)	Preamp Factor (dB)	Ant Pos (cm)	Table Pos (deg)	Remark
2438	102.51	-	-	98.67	31.96	6.52	34.64	191	57	Average
2438	108.76	-	-	104.92	31.96	6.52	34.64	191	57	Peak
4874	43.16	-30.84	74	59.3	34.37	10.18	60.69	100	0	Peak
7311	44.09	-29.91	74	58.06	35.61	10.94	60.52	100	0	Peak

Test Mode :	802.11b	Temperature :	20~23°C
Test Channel :	06	Relative Humidity :	52~53%
Test Engineer :	Hayden Wu	Polarization :	Vertical
Remark :	1. 2438 MHz is fundamental signal which can be ignored. 2. Average measurement was not performed if peak level went lower than the average limit.		

Frequency (MHz)	Level (dBµV/m)	Over Limit (dB)	Limit Line (dBµV/m)	Read Level (dBµV)	Antenna Factor (dB)	Cable Loss (dB)	Preamp Factor (dB)	Ant Pos (cm)	Table Pos (deg)	Remark
2438	100.99	-	-	97.15	31.96	6.52	34.64	119	308	Average
2438	107	-	-	103.16	31.96	6.52	34.64	119	308	Peak
4874	42.01	-31.99	74	58.15	34.37	10.18	60.69	100	0	Peak
7311	46.76	-27.24	74	60.73	35.61	10.94	60.52	100	0	Peak



Test Mode :	802.11b	Temperature :	20~23°C
Test Channel :	11	Relative Humidity :	52~53%
Test Engineer :	Hayden Wu	Polarization :	Horizontal
Remark :	1. 2464 MHz is fundamental signal which can be ignored. 2. Average measurement was not performed if peak level went lower than the average limit.		

Frequency (MHz)	Level (dBμV/m)	Over Limit (dB)	Limit Line (dBμV/m)	Read Level (dBμV)	Antenna Factor (dB)	Cable Loss (dB)	Preamp Factor (dB)	Ant Pos (cm)	Table Pos (deg)	Remark
99.12	20.34	-23.16	43.5	40.33	10.66	1.1	31.75	-	-	Peak
214.41	27.11	-16.39	43.5	48.13	9.14	1.59	31.75	-	-	Peak
291.36	29.81	-16.19	46	46.64	13.02	1.87	31.72	-	-	Peak
313.3	30.63	-15.37	46	46.93	13.49	1.94	31.73	100	28	Peak
415.5	29.33	-16.67	46	42.39	16.55	2.23	31.84	-	-	Peak
521.9	26.43	-19.57	46	37.82	18.06	2.51	31.96	-	-	Peak
2464	104.84	-	-	100.95	31.97	6.56	34.64	106	333	Average
2464	111.08	-	-	107.19	31.97	6.56	34.64	106	333	Peak
4924	43.61	-30.39	74	59.64	34.34	10.2	60.57	100	0	Peak
7386	43.32	-30.68	74	57.4	35.56	10.92	60.56	100	0	Peak



Test Mode :	802.11b	Temperature :	20~23°C
Test Channel :	11	Relative Humidity :	52~53%
Test Engineer :	Hayden Wu	Polarization :	Vertical
Remark :	1. 2462 MHz is fundamental signal which can be ignored. 2. Average measurement was not performed if peak level went lower than the average limit.		

Frequency (MHz)	Level (dBμV/m)	Over Limit (dB)	Limit Line (dBμV/m)	Read Level (dBμV)	Antenna Factor (dB)	Cable Loss (dB)	Preamp Factor (dB)	Ant Pos (cm)	Table Pos (deg)	Remark
32.43	26.11	-13.89	40	40.53	16.7	0.67	31.79	100	216	Peak
45.39	22.94	-17.06	40	44.57	9.38	0.77	31.78	-	-	Peak
96.96	24.18	-19.32	43.5	44.46	10.38	1.09	31.75	-	-	Peak
313.3	28.12	-17.88	46	44.42	13.49	1.94	31.73	-	-	Peak
461	29.43	-16.57	46	41.77	17.22	2.33	31.89	-	-	Peak
531	29.74	-16.26	46	40.82	18.37	2.52	31.97	-	-	Peak
2462	96.72	-	-	92.83	31.97	6.56	34.64	100	328	Average
2462	103.25	-	-	99.36	31.97	6.56	34.64	100	328	Peak
4924	41.77	-32.23	74	57.8	34.34	10.2	60.57	100	0	Peak
7386	45.57	-28.43	74	59.65	35.56	10.92	60.56	100	0	Peak



Test Mode :	802.11g	Temperature :	20~23°C
Test Channel :	01	Relative Humidity :	52~53%
Test Engineer :	Hayden Wu	Polarization :	Horizontal
Remark :	1. 2414 MHz is fundamental signal which can be ignored. 2. Average measurement was not performed if peak level went lower than the average limit.		

Frequency (MHz)	Level (dBμV/m)	Over Limit (dB)	Limit Line (dBμV/m)	Read Level (dBμV)	Antenna Factor (dB)	Cable Loss (dB)	Preamp Factor (dB)	Ant Pos (cm)	Table Pos (deg)	Remark
2414	99.48	-	-	95.69	31.94	6.49	34.64	104	335	Average
2414	108.73	-	-	104.94	31.94	6.49	34.64	104	335	Peak
4824	40.53	-33.47	74	56.77	34.4	10.17	60.81	100	0	Peak

Test Mode :	802.11g	Temperature :	20~23°C
Test Channel :	01	Relative Humidity :	52~53%
Test Engineer :	Hayden Wu	Polarization :	Vertical
Remark :	1. 2410 MHz is fundamental signal which can be ignored. 2. Average measurement was not performed if peak level went lower than the average limit.		

Frequency (MHz)	Level (dBμV/m)	Over Limit (dB)	Limit Line (dBμV/m)	Read Level (dBμV)	Antenna Factor (dB)	Cable Loss (dB)	Preamp Factor (dB)	Ant Pos (cm)	Table Pos (deg)	Remark
2410	93.88	-	-	90.1	31.93	6.49	34.64	100	317	Average
2410	103.63	-	-	99.85	31.93	6.49	34.64	100	317	Peak
4824	41.39	-32.61	74	57.63	34.4	10.17	60.81	100	0	Peak



Test Mode :	802.11g	Temperature :	20~23°C
Test Channel :	06	Relative Humidity :	52~53%
Test Engineer :	Hayden Wu	Polarization :	Horizontal
Remark :	1. 2438 MHz is fundamental signal which can be ignored. 2. Average measurement was not performed if peak level went lower than the average limit.		

Frequency (MHz)	Level (dBμV/m)	Over Limit (dB)	Limit Line (dBμV/m)	Read Level (dBμV)	Antenna Factor (dB)	Cable Loss (dB)	Preamp Factor (dB)	Ant Pos (cm)	Table Pos (deg)	Remark
2438	100.87	-	-	97.05	31.94	6.52	34.64	107	333	Average
2438	111.62	-	-	107.8	31.94	6.52	34.64	107	333	Peak
4874	42.59	-31.41	74	58.73	34.37	10.18	60.69	100	0	Peak
7311	45.63	-28.37	74	59.6	35.61	10.94	60.52	100	0	Peak

Test Mode :	802.11g	Temperature :	20~23°C
Test Channel :	06	Relative Humidity :	52~53%
Test Engineer :	Hayden Wu	Polarization :	Vertical
Remark :	1. 2438 MHz is fundamental signal which can be ignored. 2. Average measurement was not performed if peak level went lower than the average limit.		

Frequency (MHz)	Level (dBμV/m)	Over Limit (dB)	Limit Line (dBμV/m)	Read Level (dBμV)	Antenna Factor (dB)	Cable Loss (dB)	Preamp Factor (dB)	Ant Pos (cm)	Table Pos (deg)	Remark
2438	94.84	-	-	91	31.96	6.52	34.64	162	80	Average
2438	105.02	-	-	101.18	31.96	6.52	34.64	162	80	Peak
4874	42.28	-31.72	74	58.42	34.37	10.18	60.69	100	0	Peak
7311	45.52	-28.48	74	59.49	35.61	10.94	60.52	100	0	Peak



Test Mode :	802.11g	Temperature :	20~23°C
Test Channel :	11	Relative Humidity :	52~53%
Test Engineer :	Hayden Wu	Polarization :	Horizontal
Remark :	1. 2460 MHz is fundamental signal which can be ignored. 2. Average measurement was not performed if peak level went lower than the average limit.		

Frequency (MHz)	Level (dBμV/m)	Over Limit (dB)	Limit Line (dBμV/m)	Read Level (dBμV)	Antenna Factor (dB)	Cable Loss (dB)	Preamp Factor (dB)	Ant Pos (cm)	Table Pos (deg)	Remark
98.85	27.44	-16.06	43.5	47.43	10.66	1.1	31.75	-	-	Peak
201.72	28.07	-15.43	43.5	49.09	9.18	1.55	31.75	-	-	Peak
297.84	29.6	-16.4	46	46.26	13.16	1.9	31.72	-	-	Peak
310.5	31.32	-14.68	46	47.71	13.4	1.94	31.73	100	211	Peak
461	29.7	-16.3	46	42.04	17.22	2.33	31.89	-	-	Peak
508.6	28.11	-17.89	46	39.67	17.88	2.5	31.94	-	-	Peak
2460	97.51	-	-	93.62	31.97	6.56	34.64	105	336	Average
2460	107.81	-	-	103.92	31.97	6.56	34.64	105	336	Peak
4924	41.93	-32.07	74	57.96	34.34	10.2	60.57	100	0	Peak
7386	43.83	-30.17	74	57.91	35.56	10.92	60.56	100	0	Peak



Test Mode :	802.11g	Temperature :	20~23°C
Test Channel :	11	Relative Humidity :	52~53%
Test Engineer :	Hayden Wu	Polarization :	Vertical
Remark :	1. 2464 MHz is fundamental signal which can be ignored. 2. Average measurement was not performed if peak level went lower than the average limit.		

Frequency (MHz)	Level (dBμV/m)	Over Limit (dB)	Limit Line (dBμV/m)	Read Level (dBμV)	Antenna Factor (dB)	Cable Loss (dB)	Preamp Factor (dB)	Ant Pos (cm)	Table Pos (deg)	Remark
45.39	23.24	-16.76	40	44.87	9.38	0.77	31.78	-	-	Peak
96.69	24.51	-18.99	43.5	44.79	10.38	1.09	31.75	-	-	Peak
297.84	26.11	-19.89	46	42.77	13.16	1.9	31.72	-	-	Peak
313.3	27.87	-18.13	46	44.17	13.49	1.94	31.73	-	-	Peak
470.1	28.6	-17.4	46	40.79	17.4	2.31	31.9	-	-	Peak
531	29.65	-16.35	46	40.73	18.37	2.52	31.97	100	245	Peak
2464	92.81	-	-	88.91	31.97	6.56	34.63	162	80	Average
2464	102.65	-	-	98.75	31.97	6.56	34.63	162	80	Peak
4924	41.62	-32.38	74	57.65	34.34	10.2	60.57	100	0	Peak
7386	43.25	-30.75	74	57.33	35.56	10.92	60.56	100	0	Peak



Test Mode :	2.4GHz 802.11n HT20	Temperature :	20~23°C
Test Channel :	01	Relative Humidity :	52~53%
Test Engineer :	Hayden Wu	Polarization :	Horizontal
Remark :	1. 2414 MHz is fundamental signal which can be ignored. 2. Average measurement was not performed if peak level went lower than the average limit.		

Frequency (MHz)	Level (dBμV/m)	Over Limit (dB)	Limit Line (dBμV/m)	Read Level (dBμV)	Antenna Factor (dB)	Cable Loss (dB)	Preamp Factor (dB)	Ant Pos (cm)	Table Pos (deg)	Remark
2414	96.71	-	-	92.92	31.94	6.49	34.64	107	342	Average
2414	107	-	-	103.21	31.94	6.49	34.64	107	342	Peak
4824	41.34	-32.66	74	57.58	34.4	10.17	60.81	100	0	Peak

Test Mode :	2.4GHz 802.11n HT20	Temperature :	20~23°C
Test Channel :	01	Relative Humidity :	52~53%
Test Engineer :	Hayden Wu	Polarization :	Vertical
Remark :	1. 2410 MHz is fundamental signal which can be ignored. 2. Average measurement was not performed if peak level went lower than the average limit.		

Frequency (MHz)	Level (dBμV/m)	Over Limit (dB)	Limit Line (dBμV/m)	Read Level (dBμV)	Antenna Factor (dB)	Cable Loss (dB)	Preamp Factor (dB)	Ant Pos (cm)	Table Pos (deg)	Remark
2410	93.2	-	-	89.41	31.94	6.49	34.64	100	317	Average
2410	103.29	-	-	99.5	31.94	6.49	34.64	100	317	Peak
4824	41.45	-32.55	74	57.69	34.4	10.17	60.81	100	0	Peak



Test Mode :	2.4GHz 802.11n HT20	Temperature :	20~23°C
Test Channel :	06	Relative Humidity :	52~53%
Test Engineer :	Hayden Wu	Polarization :	Horizontal
Remark :	1. 2436 MHz is fundamental signal which can be ignored. 2. Average measurement was not performed if peak level went lower than the average limit.		

Frequency (MHz)	Level (dBμV/m)	Over Limit (dB)	Limit Line (dBμV/m)	Read Level (dBμV)	Antenna Factor (dB)	Cable Loss (dB)	Preamp Factor (dB)	Ant Pos (cm)	Table Pos (deg)	Remark
2436	99.99	-	-	96.17	31.94	6.52	34.64	105	336	Average
2436	110.45	-	-	106.63	31.94	6.52	34.64	105	336	Peak
4874	42.12	-31.88	74	58.26	34.37	10.18	60.69	100	0	Peak
7311	44.2	-29.8	74	58.17	35.61	10.94	60.52	100	0	Peak

Test Mode :	2.4GHz 802.11n HT20	Temperature :	20~23°C
Test Channel :	06	Relative Humidity :	52~53%
Test Engineer :	Hayden Wu	Polarization :	Vertical
Remark :	1. 2438 MHz is fundamental signal which can be ignored. 2. Average measurement was not performed if peak level went lower than the average limit.		

Frequency (MHz)	Level (dBμV/m)	Over Limit (dB)	Limit Line (dBμV/m)	Read Level (dBμV)	Antenna Factor (dB)	Cable Loss (dB)	Preamp Factor (dB)	Ant Pos (cm)	Table Pos (deg)	Remark
2438	97.38	-	-	93.56	31.94	6.52	34.64	117	270	Average
2438	107.41	-	-	103.59	31.94	6.52	34.64	117	270	Peak
4874	42.47	-31.53	74	58.61	34.37	10.18	60.69	100	0	Peak
7311	43.99	-30.01	74	57.96	35.61	10.94	60.52	100	0	Peak



Test Mode :	2.4GHz 802.11n HT20	Temperature :	20~23°C
Test Channel :	11	Relative Humidity :	52~53%
Test Engineer :	Hayden Wu	Polarization :	Horizontal
Remark :	1. 2460 MHz is fundamental signal which can be ignored. 2. Average measurement was not performed if peak level went lower than the average limit.		

Frequency (MHz)	Level (dBμV/m)	Over Limit (dB)	Limit Line (dBμV/m)	Read Level (dBμV)	Antenna Factor (dB)	Cable Loss (dB)	Preamp Factor (dB)	Ant Pos (cm)	Table Pos (deg)	Remark
171.21	25.56	-17.94	43.5	45.99	9.72	1.6	31.75	-	-	Peak
214.41	27.14	-16.36	43.5	48.16	9.14	1.59	31.75	-	-	Peak
291.36	28.65	-17.35	46	45.48	13.02	1.87	31.72	-	-	Peak
310.5	31.11	-14.89	46	47.5	13.4	1.94	31.73	105	36	Peak
402.9	28.01	-17.99	46	41.69	15.94	2.2	31.82	-	-	Peak
457.5	28.51	-17.49	46	40.92	17.14	2.33	31.88	-	-	Peak
2460	96.62	-	-	92.73	31.97	6.56	34.64	104	334	Average
2460	106.55	-	-	102.66	31.97	6.56	34.64	104	334	Peak
4924	41.5	-32.5	74	57.53	34.34	10.2	60.57	100	0	Peak
7386	43.47	-30.53	74	57.55	35.56	10.92	60.56	100	0	Peak



Test Mode :	2.4GHz 802.11n HT20	Temperature :	20~23°C
Test Channel :	11	Relative Humidity :	52~53%
Test Engineer :	Hayden Wu	Polarization :	Vertical
Remark :	1. 2460 MHz is fundamental signal which can be ignored. 2. Average measurement was not performed if peak level went lower than the average limit.		

Frequency (MHz)	Level (dBμV/m)	Over Limit (dB)	Limit Line (dBμV/m)	Read Level (dBμV)	Antenna Factor (dB)	Cable Loss (dB)	Preamp Factor (dB)	Ant Pos (cm)	Table Pos (deg)	Remark
32.16	21.95	-18.05	40	35.78	17.3	0.66	31.79	-	-	Peak
45.66	23.29	-16.71	40	44.92	9.38	0.77	31.78	-	-	Peak
96.96	23.73	-19.77	43.5	44.01	10.38	1.09	31.75	-	-	Peak
310.5	27.17	-18.83	46	43.56	13.4	1.94	31.73	-	-	Peak
454	28.4	-17.6	46	40.94	17.02	2.32	31.88	-	-	Peak
528.2	29.74	-16.26	46	40.92	18.27	2.52	31.97	100	25	Peak
2460	90.73	-	-	86.84	31.97	6.56	34.64	135	273	Average
2460	100.98	-	-	97.09	31.97	6.56	34.64	135	273	Peak
4924	42.26	-31.74	74	58.29	34.34	10.2	60.57	100	0	Peak
7386	43.19	-30.81	74	57.27	35.56	10.92	60.56	100	0	Peak



Test Mode :	2.4GHz 802.11ac VHT20	Temperature :	20~23°C
Test Channel :	01	Relative Humidity :	52~53%
Test Engineer :	Hayden Wu	Polarization :	Horizontal
Remark :	1. 2414 MHz is fundamental signal which can be ignored. 2. Average measurement was not performed if peak level went lower than the average limit.		

Frequency (MHz)	Level (dBμV/m)	Over Limit (dB)	Limit Line (dBμV/m)	Read Level (dBμV)	Antenna Factor (dB)	Cable Loss (dB)	Preamp Factor (dB)	Ant Pos (cm)	Table Pos (deg)	Remark
2414	98.72	-	-	94.93	31.94	6.49	34.64	105	332	Average
2414	107.66	-	-	103.87	31.94	6.49	34.64	105	332	Peak
4824	42.62	-31.38	74	58.86	34.4	10.17	60.81	100	0	Peak

Test Mode :	2.4GHz 802.11ac VHT20	Temperature :	20~23°C
Test Channel :	01	Relative Humidity :	52~53%
Test Engineer :	Hayden Wu	Polarization :	Vertical
Remark :	1. 2414 MHz is fundamental signal which can be ignored. 2. Average measurement was not performed if peak level went lower than the average limit.		

Frequency (MHz)	Level (dBμV/m)	Over Limit (dB)	Limit Line (dBμV/m)	Read Level (dBμV)	Antenna Factor (dB)	Cable Loss (dB)	Preamp Factor (dB)	Ant Pos (cm)	Table Pos (deg)	Remark
2414	93.94	-	-	90.16	31.93	6.49	34.64	120	315	Average
2414	103.76	-	-	99.98	31.93	6.49	34.64	120	315	Peak
4824	40.74	-33.26	74	56.98	34.4	10.17	60.81	100	0	Peak



Test Mode :	2.4GHz 802.11ac VHT20	Temperature :	20~23°C
Test Channel :	06	Relative Humidity :	52~53%
Test Engineer :	Hayden Wu	Polarization :	Horizontal
Remark :	1. 2436 MHz is fundamental signal which can be ignored. 2. Average measurement was not performed if peak level went lower than the average limit.		

Frequency (MHz)	Level (dBμV/m)	Over Limit (dB)	Limit Line (dBμV/m)	Read Level (dBμV)	Antenna Factor (dB)	Cable Loss (dB)	Preamp Factor (dB)	Ant Pos (cm)	Table Pos (deg)	Remark
2436	101.82	-	-	98	31.94	6.52	34.64	105	332	Average
2436	111.16	-	-	107.34	31.94	6.52	34.64	105	332	Peak
4874	40.98	-33.02	74	57.12	34.37	10.18	60.69	100	0	Peak
7311	45.5	-28.5	74	59.47	35.61	10.94	60.52	100	0	Peak

Test Mode :	2.4GHz 802.11ac VHT20	Temperature :	20~23°C
Test Channel :	06	Relative Humidity :	52~53%
Test Engineer :	Hayden Wu	Polarization :	Vertical
Remark :	1. 2438 MHz is fundamental signal which can be ignored. 2. Average measurement was not performed if peak level went lower than the average limit.		

Frequency (MHz)	Level (dBμV/m)	Over Limit (dB)	Limit Line (dBμV/m)	Read Level (dBμV)	Antenna Factor (dB)	Cable Loss (dB)	Preamp Factor (dB)	Ant Pos (cm)	Table Pos (deg)	Remark
2438	98.56	-	-	94.72	31.96	6.52	34.64	114	268	Average
2438	108.39	-	-	104.55	31.96	6.52	34.64	114	268	Peak
4874	41.19	-32.81	74	57.33	34.37	10.18	60.69	100	0	Peak
7311	44.07	-29.93	74	58.04	35.61	10.94	60.52	100	0	Peak



Test Mode :	2.4GHz 802.11ac VHT20	Temperature :	20~23°C
Test Channel :	11	Relative Humidity :	52~53%
Test Engineer :	Hayden Wu	Polarization :	Horizontal
Remark :	1. 2460 MHz is fundamental signal which can be ignored. 2. Average measurement was not performed if peak level went lower than the average limit.		

Frequency (MHz)	Level (dBμV/m)	Over Limit (dB)	Limit Line (dBμV/m)	Read Level (dBμV)	Antenna Factor (dB)	Cable Loss (dB)	Preamp Factor (dB)	Ant Pos (cm)	Table Pos (deg)	Remark
2460	97.04	-	-	93.15	31.97	6.56	34.64	104	334	Average
2460	106.64	-	-	102.75	31.97	6.56	34.64	104	334	Peak
4924	41.51	-32.49	74	57.54	34.34	10.2	60.57	100	0	Peak
7386	42.78	-31.22	74	56.86	35.56	10.92	60.56	100	0	Peak

Test Mode :	2.4GHz 802.11ac VHT20	Temperature :	20~23°C
Test Channel :	11	Relative Humidity :	52~53%
Test Engineer :	Hayden Wu	Polarization :	Vertical
Remark :	1. 2464 MHz is fundamental signal which can be ignored. 2. Average measurement was not performed if peak level went lower than the average limit.		

Frequency (MHz)	Level (dBμV/m)	Over Limit (dB)	Limit Line (dBμV/m)	Read Level (dBμV)	Antenna Factor (dB)	Cable Loss (dB)	Preamp Factor (dB)	Ant Pos (cm)	Table Pos (deg)	Remark
2464	91.88	-	-	87.98	31.97	6.56	34.63	137	81	Average
2464	101.29	-	-	97.39	31.97	6.56	34.63	137	81	Peak
4924	41.78	-32.22	74	57.81	34.34	10.2	60.57	100	0	Peak
7386	43.23	-30.77	74	57.31	35.56	10.92	60.56	100	0	Peak



3.6 AC Conducted Emission Measurement

3.6.1 Limit of AC Conducted Emission

For equipment that is designed to be connected to the public utility (AC) power line, the radio frequency voltage that is conducted back onto the AC power line on any frequency or frequencies within the band 150 kHz to 30 MHz shall not exceed the limits in the following table.

Frequency of Emission (MHz)	Conducted Limit (dB μ V)	
	Quasi-Peak	Average
0.15-0.5	66 to 56*	56 to 46*
0.5-5	56	46
5-30	60	50

*Decreases with the logarithm of the frequency.

3.6.2 Measuring Instruments

The measuring equipment is listed in the section 4 of this test report.

3.6.3 Test Procedures

1. The EUT was placed 0.4 meter from the conducting wall of the shielding room, and it was kept at least 80 centimeters from any other grounded conducting surface.
2. Connect EUT to the power mains through a line impedance stabilization network (LISN).
3. All the support units are connecting to the other LISN.
4. The LISN provides 50 ohm coupling impedance for the measuring instrument.
5. The FCC states that a 50 ohm, 50 microhenry LISN should be used.
6. Both sides of AC line were checked for maximum conducted interference.
7. The frequency range from 150 kHz to 30 MHz was searched.
8. Set the test-receiver system to Peak Detect Function and specified bandwidth with Maximum Hold Mode.

3.6.4 Test Setup

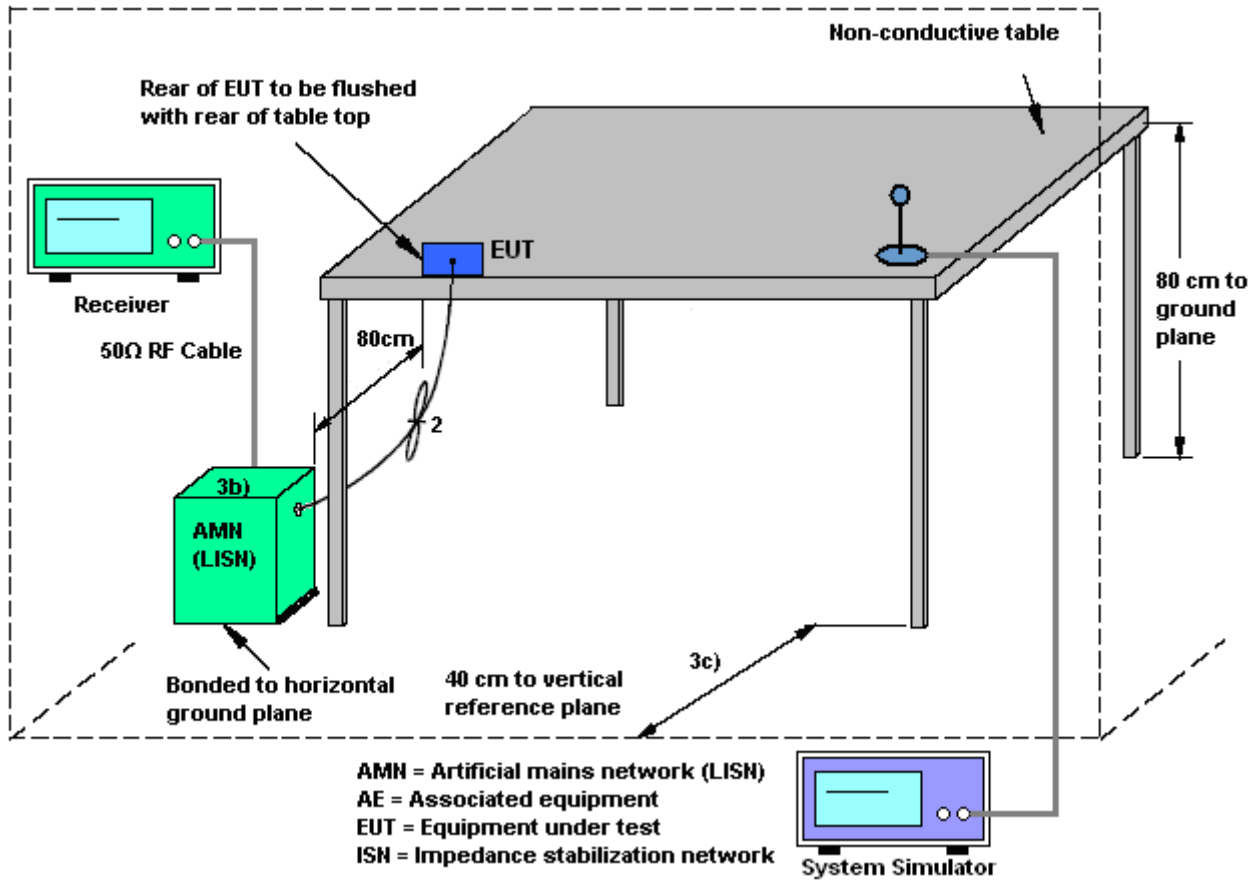



3.6.5 Test Result of AC Conducted Emission

Test Mode :	Mode 1	Temperature :	20~22°C
Test Engineer :	Cosmo Xu	Relative Humidity :	45~47%
Test Voltage :	120Vac / 60Hz	Phase :	Line
Function Type :	GSM850 Idle + Bluetooth Link + WLAN (2.4GHz) Link + USB Cable (Charging from Adapter) + Battery + Earphone + MP3		

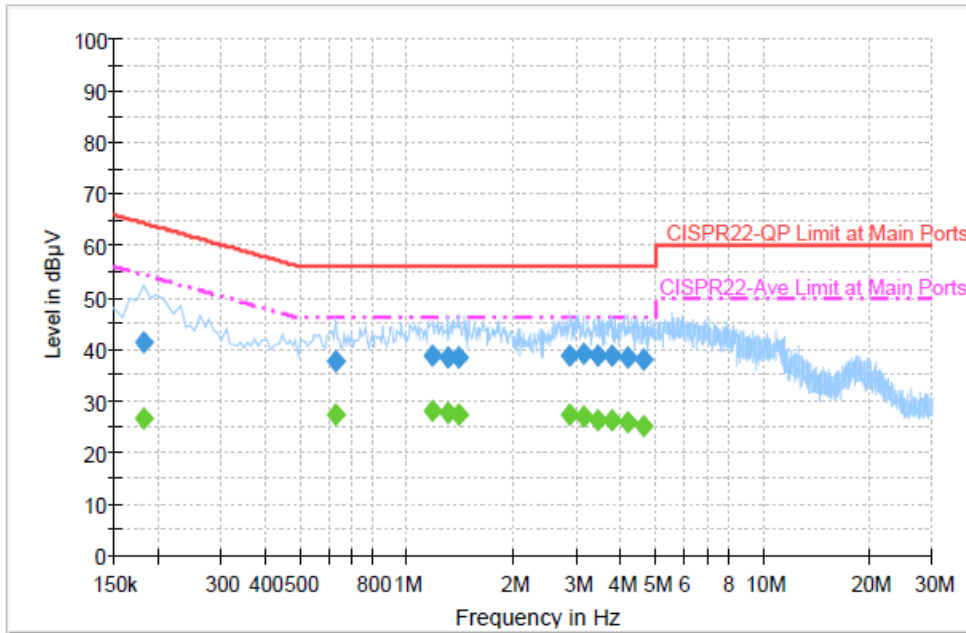

Final Result : Quasi-Peak

Frequency (MHz)	Quasi-Peak (dBµV)	Filter	Line	Corr. (dB)	Margin (dB)	Limit (dBµV)
0.182000	41.2	Off	L1	19.3	23.2	64.4
0.630000	37.6	Off	L1	19.4	18.4	56.0
1.182000	38.6	Off	L1	19.6	17.4	56.0
1.302000	38.5	Off	L1	19.5	17.5	56.0
1.398000	38.2	Off	L1	19.5	17.8	56.0
2.878000	38.7	Off	L1	19.6	17.3	56.0
3.150000	39.0	Off	L1	19.6	17.0	56.0
3.462000	38.7	Off	L1	19.6	17.3	56.0
3.750000	38.6	Off	L1	19.6	17.4	56.0
4.166000	38.4	Off	L1	19.6	17.6	56.0
4.606000	38.1	Off	L1	19.7	17.9	56.0



Test Mode :	Mode 1	Temperature :	20~22°C
Test Engineer :	Cosmo Xu	Relative Humidity :	45~47%
Test Voltage :	120Vac / 60Hz	Phase :	Line
Function Type :	GSM850 Idle + Bluetooth Link + WLAN (2.4GHz) Link + USB Cable (Charging from Adapter) + Battery + Earphone + MP3		

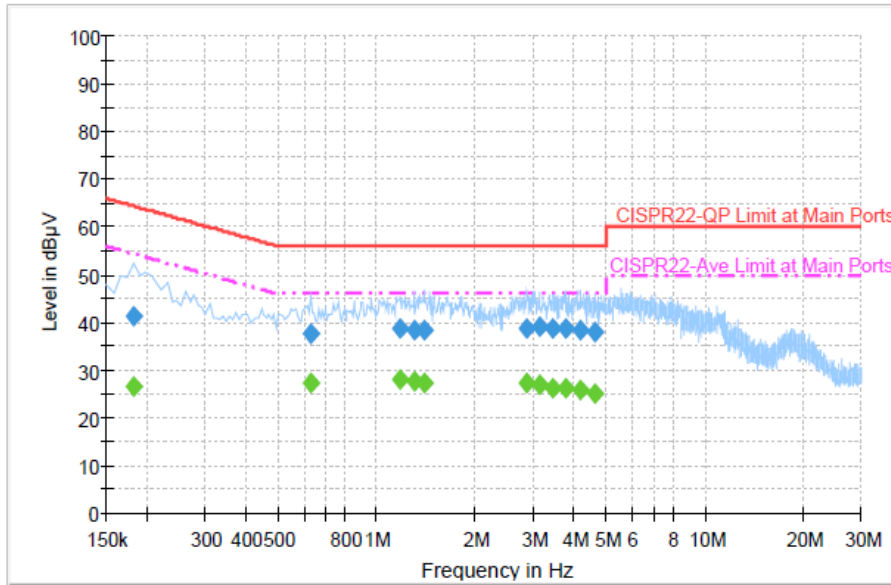

Final Result : Average

Frequency (MHz)	Average (dBµV)	Filter	Line	Corr. (dB)	Margin (dB)	Limit (dBµV)
0.182000	26.7	Off	L1	19.3	27.7	54.4
0.630000	27.1	Off	L1	19.4	18.9	46.0
1.182000	27.9	Off	L1	19.6	18.1	46.0
1.302000	27.7	Off	L1	19.5	18.3	46.0
1.398000	27.4	Off	L1	19.5	18.6	46.0
2.878000	27.2	Off	L1	19.6	18.8	46.0
3.150000	26.8	Off	L1	19.6	19.2	46.0
3.462000	26.1	Off	L1	19.6	19.9	46.0
3.750000	26.2	Off	L1	19.6	19.8	46.0
4.166000	25.8	Off	L1	19.6	20.2	46.0
4.606000	25.3	Off	L1	19.7	20.7	46.0

Test Mode :	Mode 1	Temperature :	20~22°C
-------------	--------	---------------	---------



Test Engineer :	Cosmo Xu	Relative Humidity :	45~47%
Test Voltage :	120Vac / 60Hz	Phase :	Neutral
Function Type :	GSM850 Idle + Bluetooth Link + WLAN (2.4GHz) Link + USB Cable (Charging from Adapter) + Battery + Earphone + MP3		

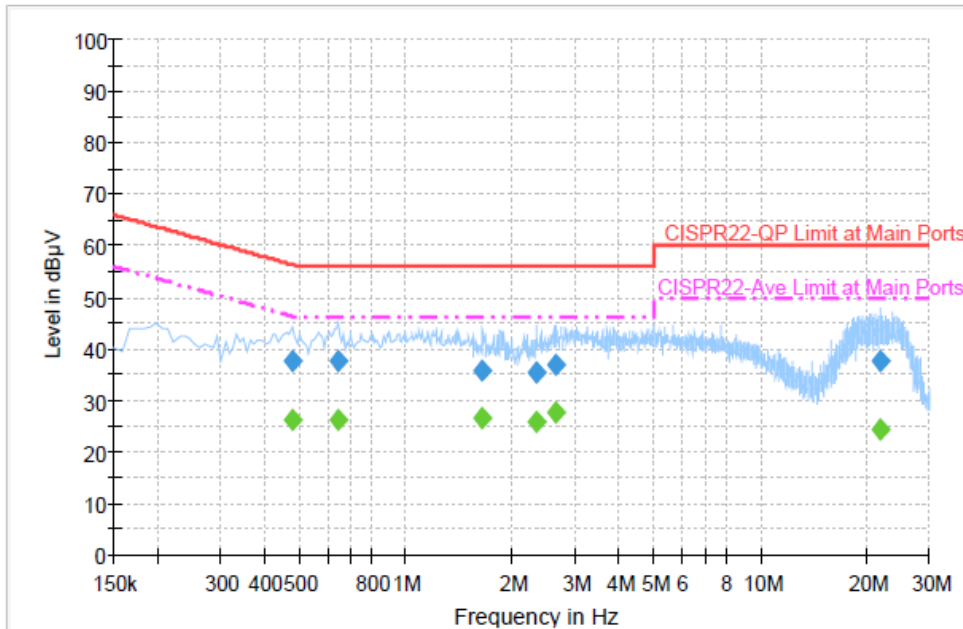

Final Result : Quasi-Peak

Frequency (MHz)	Quasi-Peak (dBµV)	Filter	Line	Corr. (dB)	Margin (dB)	Limit (dBµV)
0.478000	37.6	Off	N	19.4	18.8	56.4
0.646000	37.5	Off	N	19.4	18.5	56.0
1.646000	35.6	Off	N	19.5	20.4	56.0
2.334000	35.3	Off	N	19.6	20.7	56.0
2.662000	36.9	Off	N	19.5	19.1	56.0
21.734000	37.7	Off	N	20.0	22.3	60.0

Final Result : Average

Frequency (MHz)	Average (dBµV)	Filter	Line	Corr. (dB)	Margin (dB)	Limit (dBµV)
0.478000	26.3	Off	N	19.4	20.1	46.4
0.646000	26.3	Off	N	19.4	19.7	46.0
1.646000	26.4	Off	N	19.5	19.6	46.0
2.334000	25.9	Off	N	19.6	20.1	46.0
2.662000	27.5	Off	N	19.5	18.5	46.0
21.734000	24.5	Off	N	20.0	25.5	50.0



3.7 Antenna Requirements

3.7.1 Standard Applicable

If directional gain of transmitting antennas is greater than 6dBi, the power shall be reduced by the same level in dB comparing to gain minus 6dBi. For the fixed point-to-point operation, the power shall be reduced by one dB for every 3 dB that the directional gain of the antenna exceeds 6 dBi. The use of a permanently attached antenna or of an antenna that uses a unique coupling to the intentional radiator shall be considered sufficient to comply with the FCC rule.

3.7.2 Antenna Anti-Replacement Construction

An embedded-in antenna design is used.

3.7.3 Antenna Gain

The antenna peak gain of EUT is less than 6 dBi. Therefore, it is not necessary to reduce maximum peak output power limit.



4 List of Measuring Equipment

Instrument	Manufacturer	Model No.	Serial No.	Characteristics	Calibration Date	Test Date	Due Date	Remark
Spectrum Analyzer	Rohde & Schwarz	FSP40	100055	9kHz~40GHz	Jun. 07, 2013	Apr. 30, 2014~ Jun. 05, 2014	Jun. 06, 2014	Conducted (TH02-HY)
Spectrum Analyzer	Rohde & Schwarz	FSP40	100055	9kHz~40GHz	Jun. 09, 2014	Jun. 09, 2014~ Jun. 11, 2014	Jun. 08, 2015	Conducted (TH02-HY)
Power Meter	Anritsu	ML2495A	1036004	300MHz~40GHz	Aug. 17, 2013	Apr. 30, 2014~ Jun. 11, 2014	Aug. 16, 2014	Conducted (TH02-HY)
Power Sensor	Anritsu	MA2411B	1027253	300MHz~40GHz	Aug. 17, 2013	Apr. 30, 2014~ Jun. 11, 2014	Aug. 16, 2014	Conducted (TH02-HY)
Spectrum Analyzer	R&S	FSP30	101067	9kHz ~ 30GHz	Nov. 20, 2013	Jun. 02, 2014~ Jun. 07, 2014	Nov. 19, 2014	Radiation (03CH06-HY)
Spectrum Analyzer	Agilent	E4408B	MY44211 030	9kHz ~ 26.5GHz	Dec. 02, 2013	Jun. 02, 2014~ Jun. 07, 2014	Dec. 01, 2014	Radiation (03CH06-HY)
EMI Test Receiver	R&S	ESVS10	834468/0 003	20MHz ~ 1000MHz	May 06, 2014	Jun. 02, 2014~ Jun. 07, 2014	May 05, 2015	Radiation (03CH06-HY)
Loop Antenna	Rohde & Schwarz	HFH2-Z2	860004/0 001	9kHz ~ 30MHz	Jul. 03, 2012	Jun. 02, 2014~ Jun. 07, 2014	Jul. 02, 2014	Radiation (03CH06-HY)
Bilog Antenna	Schaffner	CBL6112B	2885	30MHz ~ 2GHz	Oct. 10, 2013	Jun. 02, 2014~ Jun. 07, 2014	Oct. 09, 2014	Radiation (03CH06-HY)
Double Ridge Horn Antenna	EMCO	3117	00066583	1GHz ~ 18GHz	Aug. 02, 2013	Jun. 02, 2014~ Jun. 07, 2014	Aug. 01, 2014	Radiation (03CH06-HY)
Amplifier	SONOMA	310N	186713	9kHz ~ 1GHz	Apr. 16, 2014	Jun. 02, 2014~ Jun. 07, 2014	Apr. 15, 2015	Radiation (03CH06-HY)
Pre Amplifier	EMCI	EMC051845	SN98004 8	1GHz ~ 18GHz	Jul. 18, 2013	Jun. 02, 2014~ Jun. 07, 2014	Jul. 17, 2014	Radiation (03CH06-HY)
SHF-EHF Horn Antenna	SCHWARZBE CK	BBHA 9170	BBHA917 0251	15GHz ~ 40GHz	Oct. 03, 2013	Jun. 02, 2014~ Jun. 07, 2014	Oct. 02, 2014	Radiation (03CH06-HY)
Preamplifier	Agilent	8449B	3008A01 917	1GHz ~ 26.5GHz	Apr. 10, 2014	Jun. 02, 2014~ Jun. 07, 2014	Apr. 09, 2015	Radiation (03CH06-HY)
Amplifier	EM	EM18G40G	060604	18GHz ~ 40GHz	Oct. 17, 2013	Jun. 02, 2014~ Jun. 07, 2014	Oct. 16, 2014	Radiation (03CH06-HY)
Turn Table	INN-CO	DS2000	420/650/0 0	0 ~ 360 degree	N/A	Jun. 02, 2014~ Jun. 07, 2014	N/A	Radiation (03CH06-HY)
Antenna Mast	MF	MF-7802	MF78020 8212	1 m ~ 4 m	N/A	Jun. 02, 2014~ Jun. 07, 2014	N/A	Radiation (03CH06-HY)
EMI Test Receiver	Rohde & Schwarz	ESCS 30	100356	9kHz ~ 2.75GHz	Nov. 15, 2013	May 14, 2014	Nov. 14, 2014	Conduction (CO05-HY)
LISN (for auxiliary equipment)	Rohde & Schwarz	ENV216	100081	9kHz ~ 30MHz	Dec. 12, 2013	May 14, 2014	Dec. 11, 2014	Conduction (CO05-HY)
LISN	Rohde & Schwarz	ENV216	100080	9kHz ~ 30MHz	Dec. 04, 2013	May 14, 2014	Dec. 03, 2014	Conduction (CO05-HY)
AC Power Source	ChainTek	APC-1000W	N/A	N/A	N/A	May 14, 2014	N/A	Conduction (CO05-HY)



5 Uncertainty of Evaluation

Uncertainty of Conducted Emission Measurement (150kHz ~ 30MHz)

Measuring Uncertainty for a Level of Confidence of 95% ($U = 2Uc(y)$)	2.26
-------------------------------------------------------------------------	------

Uncertainty of Radiated Emission Measurement (30 MHz ~ 1000 MHz)

Measuring Uncertainty for a Level of Confidence of 95% ($U = 2Uc(y)$)	4.50
-------------------------------------------------------------------------	------