



FCC RF Test Report

APPLICANT : Motorola Mobility, LLC
EQUIPMENT : Mobile Cellular Phone
BRAND NAME : Motorola Mobility, LLC
MODEL NAME : 3605
FCC ID : IHDT56QA2
STANDARD : FCC Part 15 Subpart E §15.407
CLASSIFICATION : (NII) Unlicensed National Information Infrastructure

The product was received on May 14, 2014. We, SPORTON INTERNATIONAL INC., would like to declare that the tested sample has been evaluated in accordance with the test procedures and has been in compliance with the applicable technical standards.

The test results in this report apply exclusively to the tested model / sample. Without written approval of SPORTON INTERNATIONAL INC., the test report shall not be reproduced except in full.

Reviewed by: Joseph Lin / Supervisor

Approved by: Jones Tsai / Manager



SPORTON INTERNATIONAL INC.

No. 52, Hwa Ya 1st Rd., Hwa Ya Technology Park, Kwei-Shan Hsiang, Tao Yuan Hsien, Taiwan, R.O.C.

SPORTON INTERNATIONAL INC.

TEL : 886-3-327-3456

FAX : 886-3-328-4978

FCC ID : IHDT56QA2

Page Number : 1 of 4

Report Issued Date : Jul. 12, 2014

Report Version : Rev. 01

Report Template No.: BU5-FR15EWL Version 1.0



TABLE OF CONTENTS

REVISION HISTORY 3

1 GENERAL DESCRIPTION 4

 1.1 Applicant 4

 1.2 Manufacturer 4

 1.3 Feature of Equipment Under Test 4

 1.4 Product Specification of Equipment Under Test 4

 1.5 Modification of EUT 4

APPENDIX A. ORIGINAL REPORT



REVISION HISTORY

REPORT NO.	VERSION	DESCRIPTION	ISSUED DATE
FR451423F	Rev. 01	The Bluetooth and WLAN circuitry of this variant model (3605) is identical to that of the parent product (3578), based on the product equality declaration by the manufacturer.	Jul. 12, 2014



1 General Description

1.1 Applicant

Motorola Mobility, LLC

222 W Merchandise Mart Plaza, Suite 1800, Chicago, IL 60654, United States

1.2 Manufacturer

Motorola Mobility, LLC

222 W Merchandise Mart Plaza, Suite 1800, Chicago, IL 60654, United States

1.3 Feature of Equipment Under Test

Product Feature	
Equipment	Mobile Cellular Phone
Brand Name	Motorola Mobility, LLC
Model Name	3605
FCC ID	IHDT56QA2
EUT supports Radios application	CDMA/EV-DO/GSM/EGPRS/WCDMA/HSPA/LTE/NFC WLAN 11b/g/n HT20 WLAN 11a/n HT20/HT40 WLAN 11ac VHT20/VHT40/VHT80 Bluetooth v3.0 + EDR Bluetooth v4.0 - LE
HW Version	P2A
SW Version	victara_verizon_userdebug_4.4.3_KXE21.110_73_intcfg_t est-keys_verizon_US(MSM8974BP_201.56.04.29R)
EUT Stage	Identical Prototype

Remark: The above EUT's information was declared by manufacturer. Please refer to the specifications or user's manual for more detailed description.

1.4 Product Specification of Equipment Under Test

Product Specification subjective to this standard	
Tx/Rx Channel Frequency Range	5725 MHz ~ 5850 MHz
Type of Modulation	802.11a/n : OFDM (BPSK / QPSK / 16QAM / 64QAM) 802.11ac : OFDM (BPSK / QPSK / 16QAM / 64QAM / 256QAM)
Antenna Type & Antenna Gain	Fixed Internal Antenna type with gain 0.00 dBi

1.5 Modification of EUT

No modifications are made to the EUT during all test items.



Appendix A. Original Report

Please refer to Sporton report number FR442943F as below.



FCC RF Test Report

APPLICANT : Motorola Mobility, LLC
EQUIPMENT : Mobile Cellular Phone
BRAND NAME : Motorola Mobility, LLC
MODEL NAME : 3578
FCC ID : IHDT56QA1
STANDARD : FCC Part 15 Subpart E §15.407
CLASSIFICATION : (NII) Unlicensed National Information Infrastructure

The product was received on Apr. 29, 2014 and testing was completed on Jul. 11, 2014. We, SPORTON INTERNATIONAL INC., would like to declare that the tested sample has been evaluated in accordance with the test procedures and has been in compliance with the applicable technical standards.

The test results in this report apply exclusively to the tested model / sample. Without written approval of SPORTON INTERNATIONAL INC., the test report shall not be reproduced except in full.

Reviewed by: Joseph Lin / Supervisor

Approved by: Jones Tsai / Manager



Testing Laboratory
1190

SPORTON INTERNATIONAL INC.

No. 52, Hwa Ya 1st Rd., Hwa Ya Technology Park, Kwei-Shan Hsiang, Tao Yuan Hsien, Taiwan, R.O.C.



TABLE OF CONTENTS

REVISION HISTORY..... 3

SUMMARY OF TEST RESULT 4

1 GENERAL DESCRIPTION 5

 1.1 Applicant 5

 1.2 Manufacturer..... 5

 1.3 Feature of Equipment Under Test 5

 1.4 Product Specification of Equipment Under Test..... 6

 1.5 Modification of EUT 6

 1.6 Testing Location 6

 1.7 Applicable Standards..... 7

2 TEST CONFIGURATION OF EQUIPMENT UNDER TEST 8

 2.1 Carrier Frequency and Channel 8

 2.2 Pre-Scanned RF Power..... 9

 2.3 Test Mode..... 11

 2.4 Connection Diagram of Test System..... 13

 2.5 Support Unit used in test configuration and system 14

 2.6 EUT Operation Test Setup 14

 2.7 Measurement Results Explanation Example..... 14

3 TEST RESULT..... 15

 3.1 6dB Bandwidth Measurement 15

 3.2 Maximum Conducted Output Power Measurement 18

 3.3 Power Spectral Density Measurement 20

 3.4 Unwanted Emissions Measurement 24

 3.5 AC Conducted Emission Measurement..... 55

 3.6 Frequency Stability Measurement 60

 3.7 Automatically Discontinue Transmission 62

 3.8 Antenna Requirements 63

4 LIST OF MEASURING EQUIPMENT 64

5 UNCERTAINTY OF EVALUATION 65



REVISION HISTORY

REPORT NO.	VERSION	DESCRIPTION	ISSUED DATE
FR442943F	Rev. 01	Initial issue of report	Jul. 11, 2014



SUMMARY OF TEST RESULT

Report Section	FCC Rule	Description	Limit	Result	Remark
3.1	15.403(i)	6dB Bandwidth	> 500kHz	Pass	-
3.2	15.407(a)	Maximum Conducted Output Power	≤ 30 dBm	Pass	-
3.3	15.407(a)	Power Spectral Density	≤ 30 dBm/500kHz	Pass	-
3.4	15.407(b)	Unwanted Emissions	≤ -17, -27 dBm/MHz & 15.209(a)	Pass	Under limit 0.14 dB at 5724.680 MHz
3.5	15.207	AC Conducted Emission	15.207(a)	Pass	Under limit 16.60 dB at 2.918 MHz
3.6	15.407(g)	Frequency Stability	Within Operation Band	Pass	-
3.7	15.407(c)	Automatically Discontinue Transmission	Discontinue Transmission	Pass	-
3.8	15.203 & 15.407(a)	Antenna Requirement	N/A	Pass	-



1 General Description

1.1 Applicant

Motorola Mobility, LLC

222 W Merchandise Mart Plaza, Suite 1800, Chicago, IL 60654, United States

1.2 Manufacturer

Motorola Mobility, LLC

222 W Merchandise Mart Plaza, Suite 1800, Chicago, IL 60654, United States

1.3 Feature of Equipment Under Test

Product Feature	
Equipment	Mobile Cellular Phone
Brand Name	Motorola Mobility, LLC
Model Name	3578
FCC ID	IHDT56QA1
EUT supports Radios application	GSM/EGPRS/WCDMA/HSPA/LTE/NFC WLAN 11b/g/n HT20 WLAN 11a/n HT20/HT40 WLAN 11ac VHT20/VHT40/VHT80 Bluetooth v3.0 + EDR Bluetooth v4.0 - LE
HW Version	P2
SW Version	KXE21.99.169
EUT Stage	Identical Prototype

Remark: The above EUT's information was declared by manufacturer. Please refer to the specifications or user's manual for more detailed description.

Accessory List	
AC Adapter	Brand Name : Motorola
	Model Name : SPN5788A
Earphone	Brand Name : Motorola
	Model Name : SJYN1305A



1.4 Product Specification of Equipment Under Test

Product Specification subjective to this standard	
Tx/Rx Channel Frequency Range	5725 MHz ~ 5850 MHz
Maximum Output Power	802.11a : 16.97 dBm / 0.0498 W 802.11n HT20 : 16.96 dBm / 0.0497 W 802.11n HT40 : 15.98 dBm / 0.0396 W 802.11ac VHT20: 17.14 dBm / 0.0518 W 802.11ac VHT40: 16.42 dBm / 0.0439 W 802.11ac VHT80: 9.37 dBm / 0.0025 W
Type of Modulation	802.11a/n : OFDM (BPSK / QPSK / 16QAM / 64QAM) 802.11ac : OFDM (BPSK / QPSK / 16QAM / 64QAM / 256QAM)
Antenna Type	Fixed Internal Antenna type with gain 0.00 dBi

1.5 Modification of EUT

No modifications are made to the EUT during all test items.

1.6 Testing Location

Sporton Lab is accredited to ISO 17025 by Taiwan Accreditation Foundation (TAF code : 1190) and the FCC designation No. TW1022 under the FCC 2.948(e) by Mutual Recognition Agreement (MRA) in FCC Test.

Test Site	SPORTON INTERNATIONAL INC.		
Test Site Location	No. 52, Hwa Ya 1 st Rd., Hwa Ya Technology Park, Kwei-Shan Hsiang, Tao Yuan Hsien, Taiwan, R.O.C. TEL: +886-3-3273456 / FAX: +886-3-3284978		
Test Site No.	Sporton Site No.		
	TH02-HY	CO05-HY	03CH06-HY



1.7 Applicable Standards

According to the specifications of the manufacturer, the EUT must comply with the requirements of the following standards:

- ♦ FCC Part 15 Subpart E
- ♦ FCC KDB 789033 D02 General UNII Test Procedures New Rules v01
- ♦ ANSI C63.4-2003

Remark:

1. All test items were verified and recorded according to the standards and without any deviation during the test.
2. This EUT has also been tested and complied with the requirements of FCC Part 15, Subpart B, recorded in a separate test report.



2 Test Configuration of Equipment Under Test

The EUT has been associated with peripherals and configuration operated in a manner tended to maximize its emission characteristics in a typical application. Frequency range investigated: conducted emission (150 kHz to 30 MHz) and radiated emission (9 kHz to the 10th harmonic of the highest fundamental frequency or to 40 GHz, whichever is lower). For radiated measurement, pre-scanned in three orthogonal panels, X, Y, Z. The worst cases (Y plane) were recorded in this report.

The final configuration from all the combinations and the worst-case data rates were investigated by measuring the maximum power across all the data rates and modulation modes under section 2.2.

Based on the worst configuration found above, the RF power setting is set individually to meet FCC compliance limit for the final conducted and radiated tests shown in section 2.3.

2.1 Carrier Frequency and Channel

Frequency Band	Channel	Freq. (MHz)	Channel	Freq. (MHz)
5725-5850 MHz Band 4 (U-NII-3)	149	5745	157	5785
	151	5755	159	5795
	153	5765	161	5805
	155	5775	165	5825

Note: The above Frequency and Channel in boldface were 802.11n HT40.



2.2 Pre-Scanned RF Power

Preliminary tests were performed in different data rate and data rate associated with the highest power were chosen for full test in the following tables. Final Output Power equals to Measured Output Power adds the duty factor.

Channel	Frequency	5GHz 802.11a Average Power (dBm) (800ns)							
		Data Rate							
		6 Mbps	9 Mbps	12 Mbps	18 Mbps	24 Mbps	36 Mbps	48 Mbps	54 Mbps
CH 149	5745MHz	10.49	10.47	10.47	10.47	10.36	10.43	10.45	10.46
CH 157	5785MHz	16.97	16.82	16.85	16.75	16.69	15.67	14.66	13.86
CH 165	5825MHz	12.07	12.03	12.04	12.04	12.05	12.03	12.06	12.06

Channel	Frequency	5GHz 802.11a Peak Power (dBm) (800ns)							
		Data Rate							
		6 Mbps	9 Mbps	12 Mbps	18 Mbps	24 Mbps	36 Mbps	48 Mbps	54 Mbps
CH 149	5745MHz	21.21	21.18	20.98	21.08	21.20	21.15	21.05	21.05
CH 157	5785MHz	24.82	24.69	24.41	24.61	24.69	24.45	24.05	23.38
CH 165	5825MHz	22.66	22.60	22.55	22.50	22.45	22.51	22.60	22.60

Channel	Frequency	5GHz 802.11n HT20 Average Power (dBm) (800ns)							
		Data Rate							
		MCS0	MCS1	MCS2	MCS3	MCS4	MCS5	MCS6	MCS7
CH 149	5745MHz	10.74	10.69	10.69	10.70	10.69	10.71	10.66	10.72
CH 157	5785MHz	16.96	16.94	16.94	16.90	16.01	14.96	14.12	13.13
CH 165	5825MHz	12.91	12.87	12.89	12.90	12.89	12.85	12.86	12.83

Channel	Frequency	5GHz 802.11n HT20 Peak Power (dBm) (800ns)							
		Data Rate							
		MCS0	MCS1	MCS2	MCS3	MCS4	MCS5	MCS6	MCS7
CH 149	5745MHz	21.78	21.71	21.65	21.61	21.55	21.51	21.50	21.45
CH 157	5785MHz	24.80	24.67	24.77	24.72	24.75	24.11	23.95	22.99
CH 165	5825MHz	23.21	23.15	23.12	23.16	23.13	23.10	23.05	23.09



Channel	Frequency	5GHz 802.11n HT40 Average Power (dBm) (800ns)							
		Data Rate							
		MCS0	MCS1	MCS2	MCS3	MCS4	MCS5	MCS6	MCS7
CH 151	5755MHz	9.52	9.45	9.48	9.46	9.50	9.51	9.45	9.48
CH 159	5795MHz	15.98	15.94	15.97	15.90	15.90	15.05	14.21	13.10

Channel	Frequency	5GHz 802.11n HT40 Peak Power (dBm) (800ns)							
		Data Rate							
		MCS0	MCS1	MCS2	MCS3	MCS4	MCS5	MCS6	MCS7
CH 151	5755MHz	19.55	19.41	19.40	19.35	19.31	19.25	19.21	19.20
CH 159	5795MHz	24.89	24.81	24.75	24.71	24.65	24.23	23.67	22.21

Channel	Frequency	5GHz 802.11ac VHT20 Average Power (dBm) (800ns)								
		Data Rate								
		MCS0	MCS1	MCS2	MCS3	MCS4	MCS5	MCS6	MCS7	MCS8
CH 149	5745MHz	10.31	10.19	10.22	10.29	10.06	10.26	10.14	10.16	10.05
CH 157	5785MHz	17.14	17.03	17.13	16.95	16.00	15.10	14.20	13.26	11.97
CH 165	5825MHz	13.53	13.45	13.22	13.41	13.20	13.49	13.52	13.45	12.29

Channel	Frequency	5GHz 802.11ac VHT20 Peak Power (dBm) (800ns)								
		Data Rate								
		MCS0	MCS1	MCS2	MCS3	MCS4	MCS5	MCS6	MCS7	MCS8
CH 149	5745MHz	20.11	19.91	19.55	19.42	19.89	19.21	19.21	19.25	19.66
CH 157	5785MHz	24.84	24.71	24.57	24.65	24.55	23.59	23.02	22.37	21.19
CH 165	5825MHz	23.19	23.11	22.69	22.56	23.08	22.43	22.35	22.36	21.41

Channel	Frequency	5GHz 802.11ac VHT40 Average Power (dBm) (800ns)									
		Data Rate									
		MCS0	MCS1	MCS2	MCS3	MCS4	MCS5	MCS6	MCS7	MCS8	MCS9
CH 151	5755MHz	9.48	9.36	9.33	9.43	9.44	9.46	9.46	9.29	9.43	9.44
CH 159	5795MHz	16.42	16.12	16.33	16.12	15.89	15.27	14.32	12.90	12.31	12.23

Channel	Frequency	5GHz 802.11ac VHT40 Peak Power (dBm) (800ns)									
		Data Rate									
		MCS0	MCS1	MCS2	MCS3	MCS4	MCS5	MCS6	MCS7	MCS8	MCS9
CH 151	5755MHz	18.72	18.70	18.49	18.37	18.22	18.70	18.60	18.21	18.15	18.34
CH 159	5795MHz	24.82	24.80	24.78	24.80	24.48	24.80	23.71	21.91	21.21	21.73



Channel	Frequency	5GHz 802.11ac VHT80 Average Power (dBm) (800ns)									
		Data Rate									
		MCS0	MCS1	MCS2	MCS3	MCS4	MCS5	MCS6	MCS7	MCS8	MCS9
CH 155	5775MHZ	9.37	9.33	9.19	9.10	9.31	9.28	9.03	9.14	9.29	9.33

Channel	Frequency	5GHz 802.11ac VHT80 Peak Power (dBm) (800ns)									
		Data Rate									
		MCS0	MCS1	MCS2	MCS3	MCS4	MCS5	MCS6	MCS7	MCS8	MCS9
CH 155	5775MHZ	18.74	18.71	18.66	18.55	18.70	18.72	18.73	18.71	18.59	18.61

2.3 Test Mode

Final results of test modes, data rates and test channels are shown as following table.

Test Cases				
Conducted TCs	Test Items	Mode	Data rate	Test Channel
		6dB Bandwidth Power Spectral Density	802.11a	6 Mbps
802.11n HT20			MCS0	L/M/H
802.11n HT40			MCS0	L/H
802.11ac VHT20			MCS0	L/M/H
802.11ac VHT40			MCS0	L/H
802.11ac VHT80			MCS0	M
Output Power		802.11a	6 Mbps	L/M/H
		802.11n HT20	MCS0	L/M/H
		802.11n HT40	MCS0	L/H
		802.11ac VHT20	MCS0	L/M/H
		802.11ac VHT40	MCS0	L/H
		802.11ac VHT80	MCS0	M
	Frequency Stability	802.11a	6 Mbps	L



Test Cases					
Radiated TCs	Test Items		Mode	Data rate	Test Channel
	Radiated Band Edge		802.11a	6 Mbps	L/H
			802.11n HT20	MCS0	L/H
			802.11n HT40	MCS0	L/H
			802.11ac VHT20	MCS0	L/H
			802.11ac VHT40	MCS0	L/H
			802.11ac VHT80	MCS0	M
	Radiated Spurious Emission		802.11a	6 Mbps	L/M/H
			802.11n HT20	MCS0	L/M/H
			802.11n HT40	MCS0	L/M/H
			802.11ac VHT20	MCS0	L/M/H
			802.11ac VHT40	MCS0	L/M/H
			802.11ac VHT80	MCS0	M
AC Conducted Emission	Mode 1 : GSM850 Idle + Bluetooth Link + WLAN (5GHz) Link + Earphone + MP3 + Battery + USB Cable (Charging from Adapter)				

Ch. #		Band IV : 5725-5850 MHz		
		802.11a	802.11n HT20	802.11n HT40
L	Low	149	149	151
M	Middle	157	157	-
H	High	165	165	159

Ch. #		Band IV : 5725-5850 MHz		
		802.11ac VHT20	802.11ac VHT40	802.11ac VHT80
L	Low	149	151	-
M	Middle	157	-	155
H	High	165	159	-

2.4 Connection Diagram of Test System

<Radiated Emission Mode>

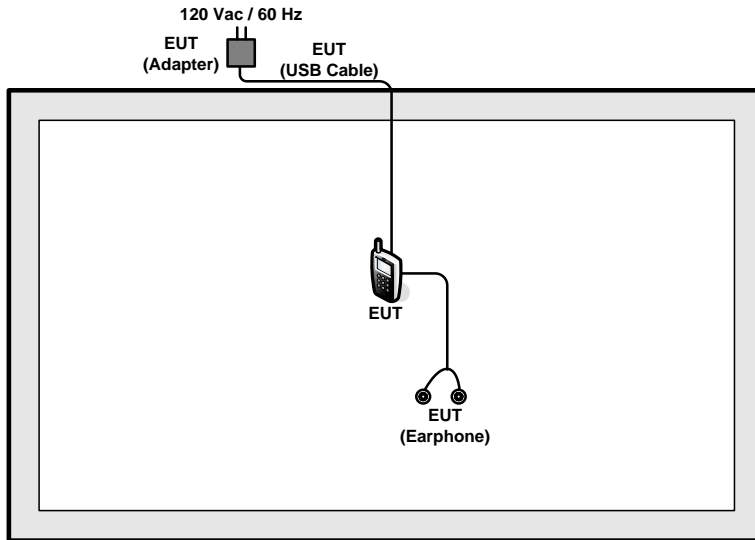

<AC Conducted Emission Mode>

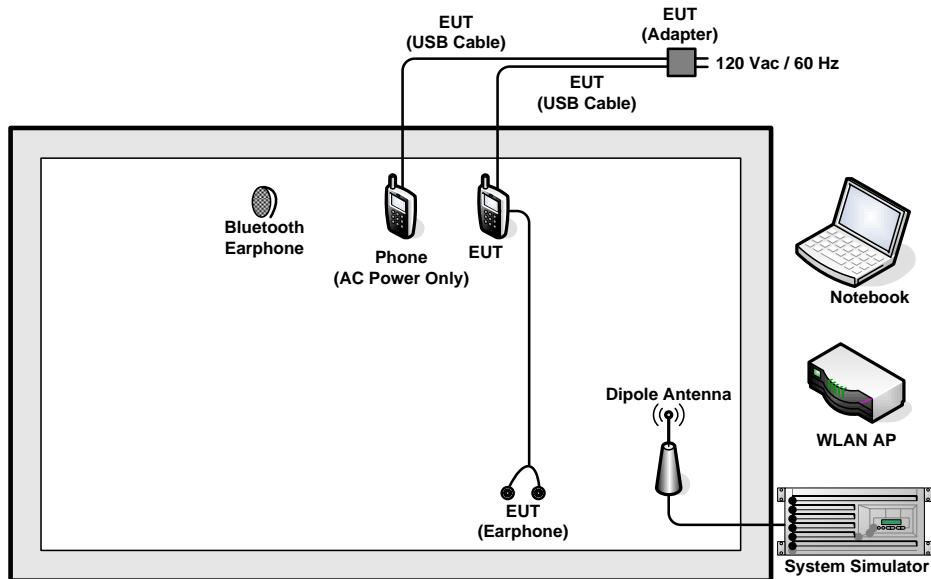



2.5 Support Unit used in test configuration and system

Item	Equipment	Trade Name	Model Name	FCC ID	Data Cable	Power Cord
1.	System Simulator	R&S	CMU 200	N/A	N/A	Unshielded, 1.8 m
2.	Bluetooth Earphone	Sony Ericsson	MW600	PY7DDA-2029	N/A	N/A
3.	WLAN AP	D-Link	DIR-628	KA2DIR628A2	N/A	Unshielded, 1.8 m
4.	Notebook	DELL	Latitude E6320	FCC DoC/ Contains FCC ID: QDS-BRCM1054	N/A	AC I/P: Unshielded, 1.2 m DC O/P: Shielded, 1.8 m
5.	SD Card	SanDisk	MicroSD HC	FCC DoC	N/A	N/A

2.6 EUT Operation Test Setup

For WLAN function, programmed RF utility, "QRCT" installed in the EUT provide functions like channel selection and power level for continuous transmitting and receiving signals.

2.7 Measurement Results Explanation Example

For all conducted test items:

The offset level is set in the spectrum analyzer to compensate the RF cable loss and attenuator factor between EUT conducted output port and spectrum analyzer. With the offset compensation, the spectrum analyzer reading level is exactly the EUT RF output level.

Example :

The spectrum analyzer offset is derived from RF cable loss and attenuator factor.

Offset = RF cable loss + attenuator factor.

Following shows an offset computation example with cable loss 4.2 dB and 10dB attenuator.

$$\begin{aligned} \text{Offset(dB)} &= \text{RF cable loss(dB)} + \text{attenuator factor(dB)}. \\ &= 4.2 + 10 = 14.2 \text{ (dB)} \end{aligned}$$

3 Test Result

3.1 6dB Bandwidth Measurement

3.1.1 Description of 6dB Bandwidth

This section is for reporting purpose only.

There is no restriction limits for bandwidth.

3.1.2 Measuring Instruments

The measuring equipment is listed in the section 4 of this test report.

3.1.3 Test Procedures

1. The testing follows FCC KDB 789033 D02 General UNII Test Procedures New Rules v01.
Section C) Emission bandwidth for the band 5.725-5.85GHz
2. Set RBW = 100kHz.
3. Set the VBW $\geq 3 \times$ RBW.
4. Detector = Peak.
5. Trace mode = max hold
6. Measure the maximum width of the emission that is 6 dB down from the peak of the emission.
7. Measure and record the results in the test report.

3.1.4 Test Setup

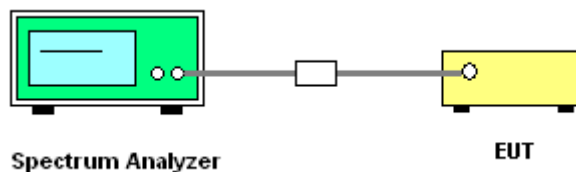



3.1.5 Test Result of 6dB Bandwidth

Test Band :	5GHz band 4	Temperature :	21~26°C
Test Engineer :	Alex Lee	Relative Humidity :	45~54%

Mod.	Data Rate	Ntx	Channel	Freq. (MHz)	6 dB Bandwidth (MHz)	FCC 6 dB Bandwidth Min. Limit (MHz)	Pass/Fail
11a	6Mbps	1	149	5745	16.32	0.5	Pass
11a	6Mbps	1	157	5785	16.36	0.5	Pass
11a	6Mbps	1	165	5825	16.32	0.5	Pass
HT20	MCS0	1	149	5745	17.60	0.5	Pass
HT20	MCS0	1	157	5785	17.60	0.5	Pass
HT20	MCS0	1	165	5825	17.56	0.5	Pass
HT40	MCS0	1	151	5755	35.12	0.5	Pass
HT40	MCS0	1	159	5795	35.36	0.5	Pass
VHT20	MCS0	1	149	5745	17.56	0.5	Pass
VHT20	MCS0	1	157	5785	17.56	0.5	Pass
VHT20	MCS0	1	165	5825	17.56	0.5	Pass
VHT40	MCS0	1	151	5755	35.12	0.5	Pass
VHT40	MCS0	1	159	5795	35.20	0.5	Pass
VHT80	MCS0	1	155	5775	75.20	0.5	Pass

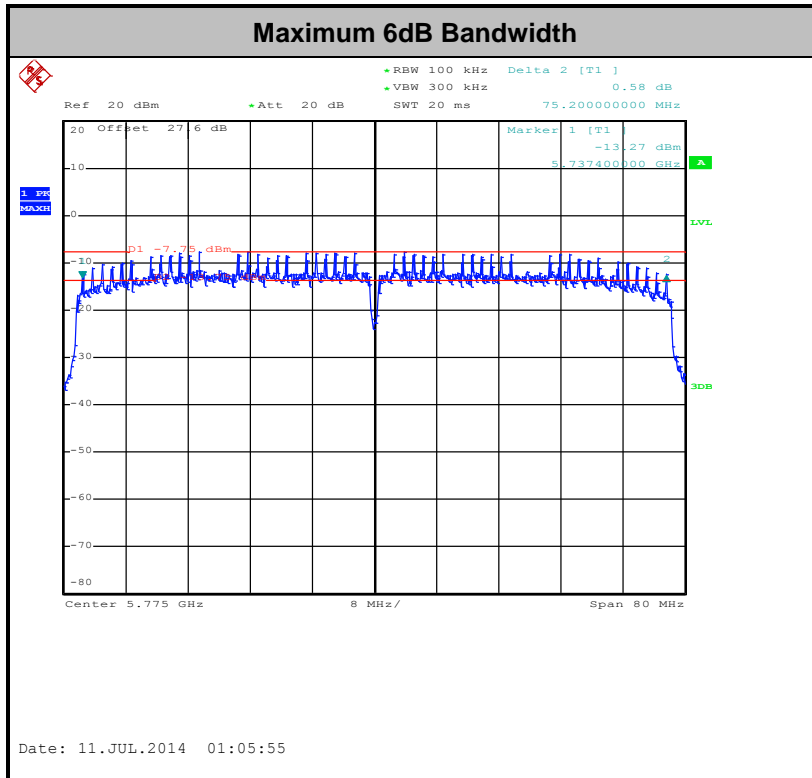

3.2 Maximum Conducted Output Power Measurement

3.2.1 Limit of Maximum Conducted Output Power

<FCC 14-30 CFR 15.407>

For the band 5.725–5.85 GHz, the maximum conducted output power over the frequency band of operation shall not exceed 1 W.

If transmitting antennas of directional gain greater than 6 dBi are used, the peak output power shall be reduced by the amount in dB that the directional gain of the antenna exceeds 6 dBi.

3.2.2 Measuring Instruments

The measuring equipment is listed in the section 4 of this test report.

3.2.3 Test Procedures

The testing follows Method PM of FCC KDB 789033 D02 General UNII Test Procedures New Rules v01.

Method PM (Measurement using an RF average power meter):

1. Measurement is performed using a wideband RF power meter.
2. The EUT is configured to transmit continuously with a consistent duty cycle at its maximum power control level.
3. Measure the average power of the transmitter, and the average power is corrected with duty factor, $10 \log(1/x)$, where x is the duty cycle.

3.2.4 Test Setup

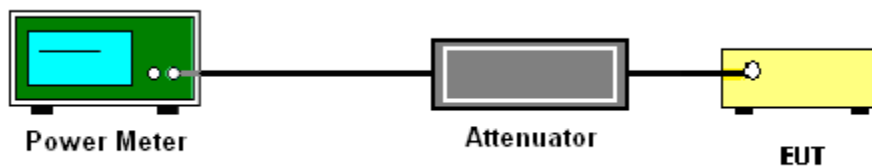



3.2.5 Test Result of Maximum Conducted Output Power

Test Band :	5GHz band 4	Temperature :	21~26°C
Test Engineer :	Alex Lee	Relative Humidity :	45~54%

Mod.	Data Rate	Ntx	Channel	Freq. (MHz)	Duty Factor (dB)	Average Conducted Power (dBm)	FCC Conducted Power Limit (dBm)	DG (dBi)	Pass /Fail
11a	6Mbps	1	149	5745	0.59	10.49	30.00	1.20	Pass
11a	6Mbps	1	157	5785	0.59	16.97	30.00	1.20	Pass
11a	6Mbps	1	165	5825	0.59	12.07	30.00	1.20	Pass
HT20	MCS0	1	149	5745	0.63	10.74	30.00	1.20	Pass
HT20	MCS0	1	157	5785	0.63	16.96	30.00	1.20	Pass
HT20	MCS0	1	165	5825	0.63	12.91	30.00	1.20	Pass
HT40	MCS0	1	151	5755	1.17	9.52	30.00	1.20	Pass
HT40	MCS0	1	159	5795	1.17	15.98	30.00	1.20	Pass
VHT20	MCS0	1	149	5745	0.80	10.31	30.00	1.20	Pass
VHT20	MCS0	1	157	5785	0.80	17.14	30.00	1.20	Pass
VHT20	MCS0	1	165	5825	0.80	13.53	30.00	1.20	Pass
VHT40	MCS0	1	151	5755	1.47	9.48	30.00	1.20	Pass
VHT40	MCS0	1	159	5795	1.47	16.42	30.00	1.20	Pass
VHT80	MCS0	1	155	5775	2.55	9.37	30.00	1.20	Pass



3.3 Power Spectral Density Measurement

3.3.1 Limit of Power Spectral Density

<FCC 14-30 CFR 15.407>

For the band 5.725–5.85 GHz, the maximum power spectral density shall not exceed 30 dBm in any 500-kHz band.

If transmitting antennas of directional gain greater than 6 dBi are used, the peak output power shall be reduced by the amount in dB that the directional gain of the antenna exceeds 6 dBi.

3.3.2 Measuring Instruments

The measuring equipment is listed in the section 4 of this test report.

3.3.3 Test Procedures

The testing follows FCC KDB 789033 D02 General UNII Test Procedures New Rules v01. Section F) Maximum power spectral density.

Method SA-2

(trace averaging across on and off times of the EUT transmissions, followed by duty cycle correction).

1. The testing follows Method SA-2 of FCC KDB 789033 D01 General UNII Test Procedures v01r03.
 - Measure the duty cycle.
 - Set span to encompass the entire emission bandwidth (EBW) of the signal.
 - Set RBW = 300 kHz.
 - Set VBW \geq 1 MHz.
 - Number of points in sweep \geq 2 Span / RBW.
 - Sweep time = auto.
 - Detector = RMS
 - Trace average at least 100 traces in power averaging mode.
 - Add $10 \log(500\text{kHz}/\text{RBW})$ to the test result.
 - Add $10 \log(1/x)$, where x is the duty cycle, to the measured power in order to compute the average power during the actual transmission times. For example, add $10 \log(1/0.25) = 6$ dB if the duty cycle is 25 percent.

2. The RF output of EUT was connected to the spectrum analyzer by a low loss cable.
3. Each plot has already offset with cable loss, and attenuator loss. Measure the PPSD and record it.
4. For MIMO mode, calculation method follows FCC KDB 662911 D01 Multiple Transmitter Output v02r01.

Method (1): Measure and sum the spectra across the outputs.

The total final Power Spectral Density is from a device with 2 transmitter outputs. The spectrum measurements of the individual outputs are all performed with the same span and number of points, the spectrum value in the first spectral bin of output 1 is summed with that in the first spectral bin of output 2 to obtain the value for the first frequency bin of the summed spectrum.

3.3.4 Test Setup

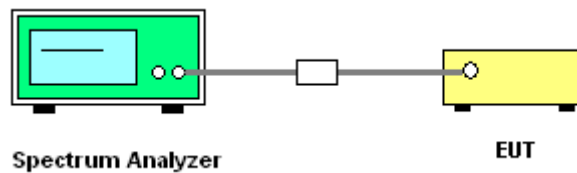



3.3.5 Test Result of Power Spectral Density

Test Band :	5GHz band 4	Temperature :	21~26°C
Test Engineer :	Alex Lee	Relative Humidity :	45~54%

Mod.	Data Rate	NTX	Ch.	Freq. (MHz)	Duty Factor (dB)	10log (500kHz/RBW) Factor (dB)	Average Power Density (dBm/500kHz)	Average PSD Limit (dBm/500kHz)	DG (dBi)	Pass /Fail
11a	6Mbps	1	149	5745	0.59	2.22	-3.38	30.00	1.20	Pass
11a	6Mbps	1	157	5785	0.59	2.22	3.01	30.00	1.20	Pass
11a	6Mbps	1	165	5825	0.59	2.22	-1.94	30.00	1.20	Pass
HT20	MCS0	1	149	5745	0.63	2.22	-3.81	30.00	1.20	Pass
HT20	MCS0	1	157	5785	0.63	2.22	3.09	30.00	1.20	Pass
HT20	MCS0	1	165	5825	0.63	2.22	-1.35	30.00	1.20	Pass
HT40	MCS0	1	151	5755	1.17	2.22	-7.45	30.00	1.20	Pass
HT40	MCS0	1	159	5795	1.17	2.22	-1.32	30.00	1.20	Pass
VHT20	MCS0	1	149	5745	0.80	2.22	-4.72	30.00	1.20	Pass
VHT20	MCS0	1	157	5785	0.80	2.22	2.86	30.00	1.20	Pass
VHT20	MCS0	1	165	5825	0.80	2.22	-0.86	30.00	1.20	Pass
VHT40	MCS0	1	151	5755	1.47	2.22	-7.42	30.00	1.20	Pass
VHT40	MCS0	1	159	5795	1.47	2.22	-0.49	30.00	1.20	Pass
VHT80	MCS0	1	155	5775	2.55	2.22	-9.39	30.00	1.20	Pass

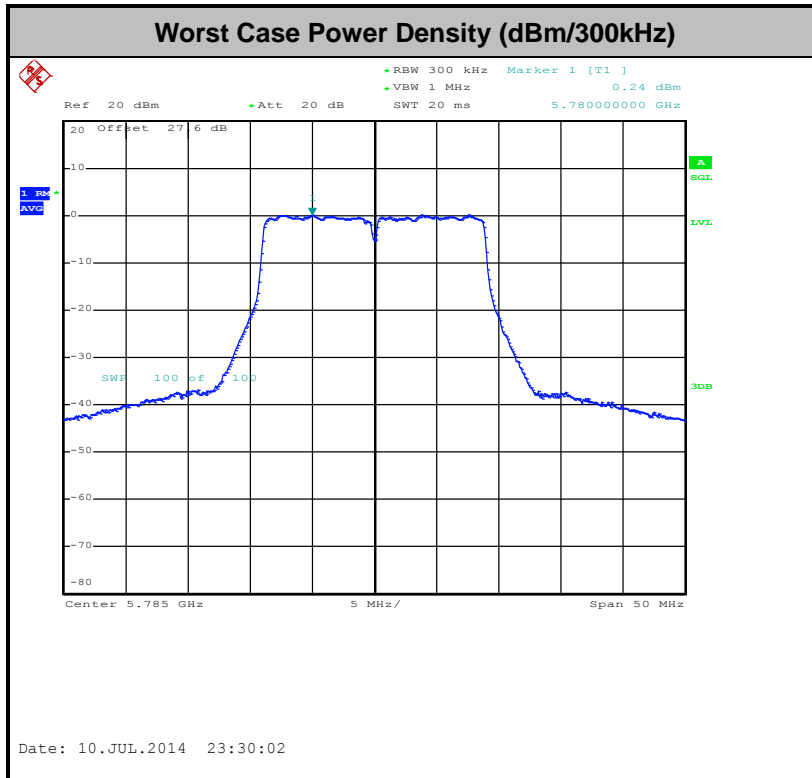



3.4 Unwanted Emissions Measurement

This section as specified in FCC Part 15.407(b) is to measure unwanted emissions through radiated measurement for band edge spurious emissions and out of band emissions measurement. The unwanted emissions shall comply with 15.407(b)(1) to (6), and restricted bands per FCC Part15.205.

3.4.1 Limit of Unwanted Emissions

- (1) For transmitters operating in the 5725-5850 MHz band: all emissions within the frequency range from the band edge to 10 MHz above or below the band edge shall not exceed an EIRP of -17 dBm/MHz (78.3dBµV/m); for frequencies 10 MHz or greater above or below the band edge, emissions shall not exceed an EIRP of -27 dBm/MHz (68.3dBµV/m).
- (2) Unwanted spurious emissions fallen in restricted bands per FCC Part15.205 shall comply with the general field strength limits set forth in § 15.209 as below table,

Frequency (MHz)	Field Strength (microvolts/meter)	Measurement Distance (meters)
0.009 – 0.490	2400/F(kHz)	300
0.490 – 1.705	24000/F(kHz)	30
1.705 – 30.0	30	30
30 – 88	100	3
88 – 216	150	3
216 - 960	200	3
Above 960	500	3

Note: The following formula is used to convert the EIRP to field strength.

$$E = \frac{1000000\sqrt{30P}}{3} \mu\text{V/m, where P is the eirp (Watts)}$$

EIRP (dBm)	Field Strength at 3m (dBµV/m)
-17	78.3
- 27	68.3

- (3) KDB789033 v01r03 H)2)c)(i) As specified in 15.407(b), emissions above 1000 MHz that are outside of the restricted bands are subject to a peak emission limit of -27 dBm/MHz (or -17 dBm/MHz as specified in 15.407(b)(4)). However, an out-of-band emission that complies with both the average and peak limits of 15.209 is not required to satisfy the -27 dBm/MHz or -17 dBm/MHz peak emission limit.



3.4.2 Measuring Instruments

The measuring equipment is listed in the section 4 of this test report.

3.4.3 Test Procedures

1. The testing follows FCC KDB 789033 D02 General UNII Test Procedures New Rules v01. Section G) Unwanted emissions measurement.

(1) Procedure for Unwanted Emissions Measurements Below 1000MHz

- RBW = 120 kHz
- VBW = 300 kHz
- Detector = Peak
- Trace mode = max hold

(2) Procedure for Peak Unwanted Emissions Measurements Above 1000 MHz

- RBW = 1 MHz
- VBW \geq 3 MHz
- Detector = Peak
- Sweep time = auto
- Trace mode = max hold



(3) Procedures for Average Unwanted Emissions Measurements Above 1000MHz

- RBW = 1 MHz
- VBW = 10 Hz, when duty cycle is no less than 98 percent.
- $VBW \geq 1/T$, when duty cycle is less than 98 percent where T is the minimum transmission duration over which the transmitter is on and is transmitting at its maximum power control level for the tested mode of operation.

Band	Duty Cycle(%)	T(us)	1/T(kHz)	VBW Setting
802.11a	87.18	1360.00	0.74	1kHz
802.11n HT20	86.49	1280.00	0.78	1kHz
802.11n HT40	76.43	642.00	1.56	3kHz
802.11n VHT20	82.99	976.00	1.02	3kHz
802.11n VHT40	71.26	496.00	2.02	3kHz
802.11n VHT80	54.63	248.00	4.03	5kHz

2. The EUT was placed on a rotatable table top 0.8 meter above ground.
3. The EUT was set 3 meters from the interference receiving antenna which was mounted on the top of a variable height antenna tower.
4. The antenna is a broadband antenna and its height is adjusted between one meter and four meters above ground to find the maximum value of the field strength for both horizontal polarization and vertical polarization of the antenna.
5. For each suspected emission, the EUT was arranged to its worst case and then adjust the antenna tower (from 1 m to 4 m) and turntable (from 0 degree to 360 degrees) to find the maximum reading.
6. For testing below 1GHz, if the emission level of the EUT in peak mode was 3 dB lower than the limit specified, then peak values of EUT will be reported, otherwise, the emissions will be repeated one by one using the CISPR quasi-peak method and reported.
7. For testing above 1GHz, the emission level of the EUT in peak mode was 20dB lower than average limit (that means the emission level in average mode also complies with the limit in average mode), then peak values of EUT will be reported, otherwise, the emissions will be measured in average mode again and reported.

3.4.4 Test Setup

For radiated emissions below 30MHz

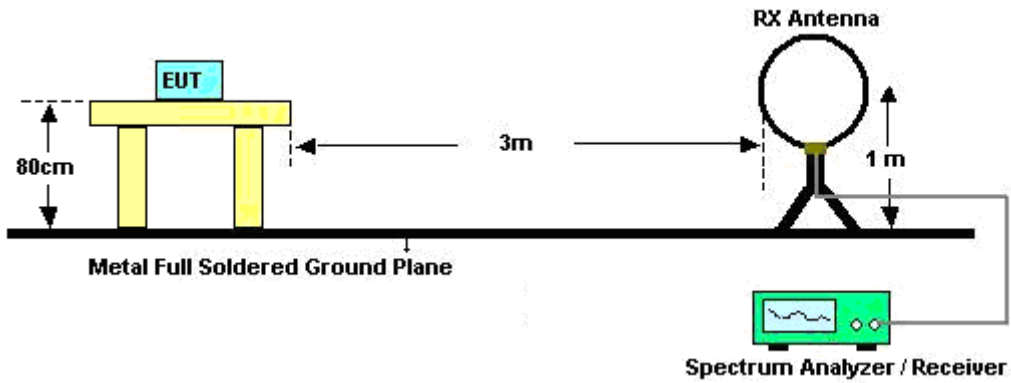

For radiated emissions from 30MHz to 1GHz

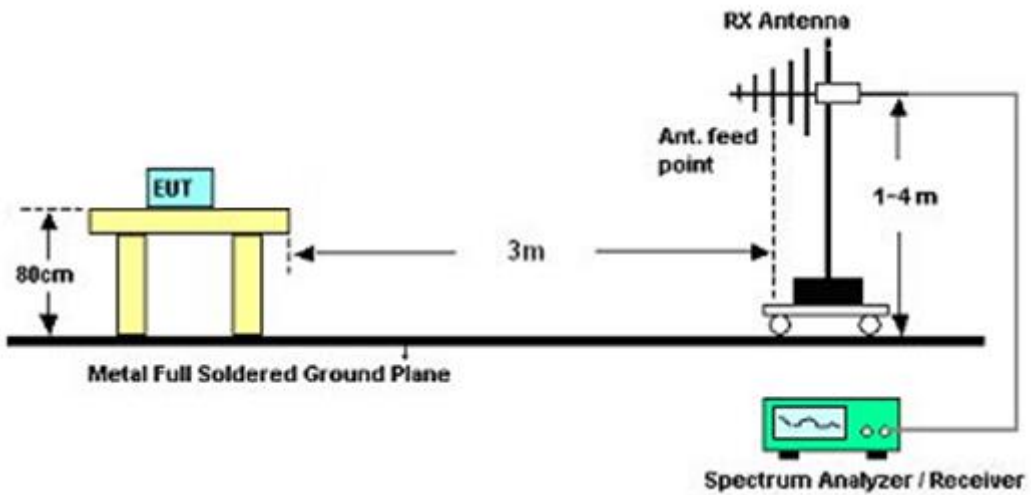

For radiated emissions above 1GHz

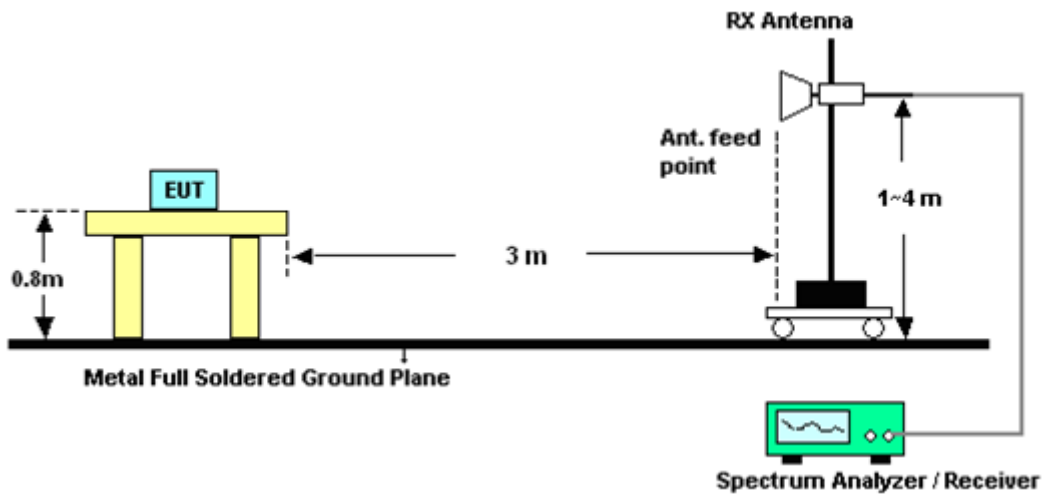

3.4.5 Test Results of Radiated Emissions (9 kHz ~ 30 MHz)

The low frequency, which started from 9 kHz to 30MHz, was pre-scanned and the result which was 20dB lower than the limit line per 15.31(o) was not reported.



3.4.6 Test Result of Radiated Band Edges

Test Mode :	802.11a	Temperature :	22~23°C
Test Channel :	149	Relative Humidity :	52~53%
Test Engineer :	Hayden Wu		

ANTENNA POLARITY : HORIZONTAL										
Frequency (MHz)	Level (dBμV/m)	Over Limit (dB)	Limit Line (dBμV/m)	Read Level (dBμV)	Antenna Factor (dB)	Cable Loss (dB)	Preamp Factor (dB)	Ant Pos (cm)	Table Pos (deg)	Remark
5724.6	70.97	-3.03	74	58.6	35.02	11.34	33.99	100	8	Peak
5725	51.87	-2.13	54	39.5	35.02	11.34	33.99	100	8	Average

ANTENNA POLARITY : VERTICAL										
Frequency (MHz)	Level (dBμV/m)	Over Limit (dB)	Limit Line (dBμV/m)	Read Level (dBμV)	Antenna Factor (dB)	Cable Loss (dB)	Preamp Factor (dB)	Ant Pos (cm)	Table Pos (deg)	Remark
5724.92	60.77	-13.23	74	48.4	35.02	11.34	33.99	100	150	Peak
5725	46.18	-7.82	54	33.81	35.02	11.34	33.99	100	150	Average

Test Mode :	802.11a	Temperature :	22~23°C
Test Channel :	165	Relative Humidity :	52~53%
Test Engineer :	Hayden Wu		

ANTENNA POLARITY : HORIZONTAL										
Frequency (MHz)	Level (dBμV/m)	Over Limit (dB)	Limit Line (dBμV/m)	Read Level (dBμV)	Antenna Factor (dB)	Cable Loss (dB)	Preamp Factor (dB)	Ant Pos (cm)	Table Pos (deg)	Remark
5851.36	72.41	-1.59	74	59.71	35.14	11.56	34	115	1	Peak
5877.44	48.87	-5.13	54	36.09	35.18	11.6	34	115	1	Average

ANTENNA POLARITY : VERTICAL										
Frequency (MHz)	Level (dBμV/m)	Over Limit (dB)	Limit Line (dBμV/m)	Read Level (dBμV)	Antenna Factor (dB)	Cable Loss (dB)	Preamp Factor (dB)	Ant Pos (cm)	Table Pos (deg)	Remark
5850.56	58.97	-15.03	74	46.27	35.14	11.56	34	200	350	Peak
5877.6	45.67	-8.33	54	32.89	35.18	11.6	34	200	350	Average



Test Mode :	802.11n HT20	Temperature :	22~23°C
Test Channel :	149	Relative Humidity :	52~53%
Test Engineer :	Hayden Wu		

ANTENNA POLARITY : HORIZONTAL										
Frequency (MHz)	Level (dBμV/m)	Over Limit (dB)	Limit Line (dBμV/m)	Read Level (dBμV)	Antenna Factor (dB)	Cable Loss (dB)	Preamp Factor (dB)	Ant Pos (cm)	Table Pos (deg)	Remark
5724.68	73.86	-0.14	74	61.49	35.02	11.34	33.99	105	2	Peak
5724.84	53.18	-0.82	54	40.81	35.02	11.34	33.99	105	2	Average

ANTENNA POLARITY : VERTICAL										
Frequency (MHz)	Level (dBμV/m)	Over Limit (dB)	Limit Line (dBμV/m)	Read Level (dBμV)	Antenna Factor (dB)	Cable Loss (dB)	Preamp Factor (dB)	Ant Pos (cm)	Table Pos (deg)	Remark
5724.44	62.17	-11.83	74	49.8	35.02	11.34	33.99	200	348	Peak
5724.92	47.29	-6.71	54	34.92	35.02	11.34	33.99	200	348	Average

Test Mode :	802.11n HT20	Temperature :	22~23°C
Test Channel :	165	Relative Humidity :	52~53%
Test Engineer :	Hayden Wu		

ANTENNA POLARITY : HORIZONTAL										
Frequency (MHz)	Level (dBμV/m)	Over Limit (dB)	Limit Line (dBμV/m)	Read Level (dBμV)	Antenna Factor (dB)	Cable Loss (dB)	Preamp Factor (dB)	Ant Pos (cm)	Table Pos (deg)	Remark
5853.36	72.87	-1.13	74	60.17	35.14	11.56	34	105	1	Peak
5850	50.17	-3.83	54	37.47	35.14	11.56	34	105	1	Average

ANTENNA POLARITY : VERTICAL										
Frequency (MHz)	Level (dBμV/m)	Over Limit (dB)	Limit Line (dBμV/m)	Read Level (dBμV)	Antenna Factor (dB)	Cable Loss (dB)	Preamp Factor (dB)	Ant Pos (cm)	Table Pos (deg)	Remark
5850.64	61.98	-12.02	74	49.28	35.14	11.56	34	200	349	Peak
5850.24	46.03	-7.97	54	33.33	35.14	11.56	34	200	349	Average



Test Mode :	802.11n HT40	Temperature :	22~23°C
Test Channel :	151	Relative Humidity :	52~53%
Test Engineer :	Hayden Wu		

ANTENNA POLARITY : HORIZONTAL										
Frequency (MHz)	Level (dBμV/m)	Over Limit (dB)	Limit Line (dBμV/m)	Read Level (dBμV)	Antenna Factor (dB)	Cable Loss (dB)	Preamp Factor (dB)	Ant Pos (cm)	Table Pos (deg)	Remark
5721.4	70.25	-3.75	74	57.88	35.02	11.34	33.99	105	2	Peak
5724.92	52.77	-1.23	54	40.4	35.02	11.34	33.99	105	2	Average
5861.68	57.77	-16.23	74	45.01	35.16	11.6	34	105	2	Peak
5858.96	46.23	-7.77	54	33.51	35.16	11.56	34	105	2	Average

ANTENNA POLARITY : VERTICAL										
Frequency (MHz)	Level (dBμV/m)	Over Limit (dB)	Limit Line (dBμV/m)	Read Level (dBμV)	Antenna Factor (dB)	Cable Loss (dB)	Preamp Factor (dB)	Ant Pos (cm)	Table Pos (deg)	Remark
5723.16	61.09	-12.91	74	48.72	35.02	11.34	33.99	200	348	Peak
5723.64	47.33	-6.67	54	34.96	35.02	11.34	33.99	200	348	Average
5857.36	56.64	-17.36	74	43.92	35.16	11.56	34	200	348	Peak
5861.04	45.67	-8.33	54	32.91	35.16	11.6	34	200	348	Average



Test Mode :	802.11n HT40	Temperature :	22~23°C
Test Channel :	159	Relative Humidity :	52~53%
Test Engineer :	Hayden Wu		

ANTENNA POLARITY : HORIZONTAL										
Frequency (MHz)	Level (dBμV/m)	Over Limit (dB)	Limit Line (dBμV/m)	Read Level (dBμV)	Antenna Factor (dB)	Cable Loss (dB)	Preamp Factor (dB)	Ant Pos (cm)	Table Pos (deg)	Remark
5716.6	70.06	-3.94	74	57.7	35.01	11.34	33.99	106	2	Peak
5691.8	50.07	-3.93	54	37.81	34.99	11.26	33.99	106	2	Average
5853.92	72.83	-1.17	74	60.11	35.16	11.56	34	106	2	Peak
5851.2	53.07	-0.93	54	40.37	35.14	11.56	34	106	2	Average

ANTENNA POLARITY : VERTICAL										
Frequency (MHz)	Level (dBμV/m)	Over Limit (dB)	Limit Line (dBμV/m)	Read Level (dBμV)	Antenna Factor (dB)	Cable Loss (dB)	Preamp Factor (dB)	Ant Pos (cm)	Table Pos (deg)	Remark
5724.12	60.41	-13.59	74	48.04	35.02	11.34	33.99	200	348	Peak
5724.84	45.8	-8.2	54	33.43	35.02	11.34	33.99	200	348	Average
5851.76	63.8	-10.2	74	51.1	35.14	11.56	34	200	348	Peak
5850.24	47.42	-6.58	54	34.72	35.14	11.56	34	200	348	Average



Test Mode :	802.11n VHT20	Temperature :	22~23°C
Test Channel :	149	Relative Humidity :	52~53%
Test Engineer :	Hayden Wu		

ANTENNA POLARITY : HORIZONTAL										
Frequency (MHz)	Level (dBμV/m)	Over Limit (dB)	Limit Line (dBμV/m)	Read Level (dBμV)	Antenna Factor (dB)	Cable Loss (dB)	Preamp Factor (dB)	Ant Pos (cm)	Table Pos (deg)	Remark
5724.44	71.75	-2.25	74	59.38	35.02	11.34	33.99	107	1	Peak
5725	53.04	-0.96	54	40.67	35.02	11.34	33.99	107	1	Average

ANTENNA POLARITY : VERTICAL										
Frequency (MHz)	Level (dBμV/m)	Over Limit (dB)	Limit Line (dBμV/m)	Read Level (dBμV)	Antenna Factor (dB)	Cable Loss (dB)	Preamp Factor (dB)	Ant Pos (cm)	Table Pos (deg)	Remark
5723.32	63.03	-10.97	74	50.66	35.02	11.34	33.99	200	348	Peak
5724.92	46.99	-7.01	54	34.62	35.02	11.34	33.99	200	348	Average

Test Mode :	802.11n VHT20	Temperature :	22~23°C
Test Channel :	165	Relative Humidity :	52~53%
Test Engineer :	Hayden Wu		

ANTENNA POLARITY : HORIZONTAL										
Frequency (MHz)	Level (dBμV/m)	Over Limit (dB)	Limit Line (dBμV/m)	Read Level (dBμV)	Antenna Factor (dB)	Cable Loss (dB)	Preamp Factor (dB)	Ant Pos (cm)	Table Pos (deg)	Remark
5850.32	73.11	-0.89	74	60.41	35.14	11.56	34	104	3	Peak
5850.24	52.17	-1.83	54	39.47	35.14	11.56	34	104	3	Average

ANTENNA POLARITY : VERTICAL										
Frequency (MHz)	Level (dBμV/m)	Over Limit (dB)	Limit Line (dBμV/m)	Read Level (dBμV)	Antenna Factor (dB)	Cable Loss (dB)	Preamp Factor (dB)	Ant Pos (cm)	Table Pos (deg)	Remark
5850.56	62.27	-11.73	74	49.57	35.14	11.56	34	200	349	Peak
5850	46.81	-7.19	54	34.11	35.14	11.56	34	200	349	Average



Test Mode :	802.11n VHT40	Temperature :	22~23°C
Test Channel :	151	Relative Humidity :	52~53%
Test Engineer :	Hayden Wu		

ANTENNA POLARITY : HORIZONTAL										
Frequency (MHz)	Level (dBμV/m)	Over Limit (dB)	Limit Line (dBμV/m)	Read Level (dBμV)	Antenna Factor (dB)	Cable Loss (dB)	Preamp Factor (dB)	Ant Pos (cm)	Table Pos (deg)	Remark
5724.6	70.17	-3.83	74	57.8	35.02	11.34	33.99	107	0	Peak
5723.48	53.42	-0.58	54	41.05	35.02	11.34	33.99	107	0	Average
5858.08	56.3	-17.7	74	43.58	35.16	11.56	34	107	0	Peak
5856.88	45.96	-8.04	54	33.24	35.16	11.56	34	107	0	Average

ANTENNA POLARITY : VERTICAL										
Frequency (MHz)	Level (dBμV/m)	Over Limit (dB)	Limit Line (dBμV/m)	Read Level (dBμV)	Antenna Factor (dB)	Cable Loss (dB)	Preamp Factor (dB)	Ant Pos (cm)	Table Pos (deg)	Remark
5724.12	60.25	-13.75	74	47.88	35.02	11.34	33.99	100	30	Peak
5725	46.35	-7.65	54	33.98	35.02	11.34	33.99	100	30	Average
5886.88	56.72	-17.28	74	43.9	35.18	11.64	34	100	30	Peak
5884.4	45.58	-8.42	54	32.76	35.18	11.64	34	100	30	Average



Test Mode :	802.11n VHT40	Temperature :	22~23°C
Test Channel :	159	Relative Humidity :	52~53%
Test Engineer :	Hayden Wu		

ANTENNA POLARITY : HORIZONTAL										
Frequency (MHz)	Level (dBμV/m)	Over Limit (dB)	Limit Line (dBμV/m)	Read Level (dBμV)	Antenna Factor (dB)	Cable Loss (dB)	Preamp Factor (dB)	Ant Pos (cm)	Table Pos (deg)	Remark
5721.08	64.29	-9.71	74	51.92	35.02	11.34	33.99	106	0	Peak
5691.56	49.26	-4.74	54	37	34.99	11.26	33.99	106	0	Average
5850.16	53.69	-0.31	54	40.99	35.14	11.56	34	106	0	Average
5850.8	70.06	-3.94	74	57.36	35.14	11.56	34	106	0	Peak

ANTENNA POLARITY : VERTICAL										
Frequency (MHz)	Level (dBμV/m)	Over Limit (dB)	Limit Line (dBμV/m)	Read Level (dBμV)	Antenna Factor (dB)	Cable Loss (dB)	Preamp Factor (dB)	Ant Pos (cm)	Table Pos (deg)	Remark
5708.92	55.88	-18.12	74	43.56	35.01	11.3	33.99	108	30	Peak
5715	45.25	-8.75	54	32.93	35.01	11.3	33.99	108	30	Average
5850.56	61.8	-12.2	74	49.1	35.14	11.56	34	108	30	Peak
5850.64	47.62	-6.38	54	34.92	35.14	11.56	34	108	30	Average



Test Mode :	802.11n VHT80	Temperature :	22~23°C
Test Channel :	155	Relative Humidity :	52~53%
Test Engineer :	Hayden Wu		

ANTENNA POLARITY : HORIZONTAL										
Frequency (MHz)	Level (dBμV/m)	Over Limit (dB)	Limit Line (dBμV/m)	Read Level (dBμV)	Antenna Factor (dB)	Cable Loss (dB)	Preamp Factor (dB)	Ant Pos (cm)	Table Pos (deg)	Remark
5724.68	68.46	-5.54	74	56.09	35.02	11.34	33.99	106	0	Peak
5722.84	52.77	-1.23	54	40.4	35.02	11.34	33.99	106	0	Average
5851.2	57.71	-16.29	74	45.01	35.14	11.56	34	106	0	Peak
5850	46.45	-7.55	54	33.75	35.14	11.56	34	106	0	Average

ANTENNA POLARITY : VERTICAL										
Frequency (MHz)	Level (dBμV/m)	Over Limit (dB)	Limit Line (dBμV/m)	Read Level (dBμV)	Antenna Factor (dB)	Cable Loss (dB)	Preamp Factor (dB)	Ant Pos (cm)	Table Pos (deg)	Remark
5724.52	58.76	-15.24	74	46.39	35.02	11.34	33.99	110	29	Peak
5722.28	45.98	-8.02	54	33.61	35.02	11.34	33.99	110	29	Average
5854.08	56.19	-17.81	74	43.47	35.16	11.56	34	110	29	Peak
5859.68	45.55	-8.45	54	32.83	35.16	11.56	34	110	29	Average



3.4.7 Test Result of Unwanted Radiated Emission (30MHz ~ 10th Harmonic)

Test Mode :	802.11a	Temperature :	22~23°C
Test Channel :	149	Relative Humidity :	52~53%
Test Engineer :	Hayden Wu	Polarization :	Horizontal
Remark :	<ol style="list-style-type: none"> 5745 MHz is fundamental signal which can be ignored. 11490 MHz is not within a restricted band, and satisfies both the average and peak limits of 15.209. Average measurement was not performed if peak level went lower than the average limit. 		

Frequency (MHz)	Level (dBμV/m)	Over Limit (dB)	Limit Line (dBμV/m)	Read Level (dBμV)	Antenna Factor (dB)	Cable Loss (dB)	Preamp Factor (dB)	Ant Pos (cm)	Table Pos (deg)	Remark
5745	100.47	-	-	88.03	35.04	11.39	33.99	100	8	Average
5745	109.88	-	-	97.44	35.04	11.39	33.99	100	8	Peak
11490	45.32	-28.68	74	55.01	37.79	11.04	58.52	100	0	Peak
17235	47.48	-26.52	74	52.68	41.13	12.27	58.6	100	0	Peak

Test Mode :	802.11a	Temperature :	22~23°C
Test Channel :	149	Relative Humidity :	52~53%
Test Engineer :	Hayden Wu	Polarization :	Vertical
Remark :	<ol style="list-style-type: none"> 5745 MHz is fundamental signal which can be ignored. 11490 MHz is not within a restricted band, and satisfies both the average and peak limits of 15.209. Average measurement was not performed if peak level went lower than the average limit. 		

Frequency (MHz)	Level (dBμV/m)	Over Limit (dB)	Limit Line (dBμV/m)	Read Level (dBμV)	Antenna Factor (dB)	Cable Loss (dB)	Preamp Factor (dB)	Ant Pos (cm)	Table Pos (deg)	Remark
5745	86.6	-	-	74.16	35.04	11.39	33.99	100	150	Average
5745	97.24	-	-	84.8	35.04	11.39	33.99	100	150	Peak
11490	46.17	-27.83	74	55.86	37.79	11.04	58.52	100	0	Peak
17235	47.22	-26.78	74	52.42	41.13	12.27	58.6	100	0	Peak



Test Mode :	802.11a	Temperature :	22~23°C
Test Channel :	157	Relative Humidity :	52~53%
Test Engineer :	Hayden Wu	Polarization :	Horizontal
Remark :	1. 5787 MHz is fundamental signal which can be ignored. 2. 11571 MHz is not within a restricted band, and satisfies both the average and peak limits of 15.209. 3. Average measurement was not performed if peak level went lower than the average limit.		

Frequency (MHz)	Level (dBμV/m)	Over Limit (dB)	Limit Line (dBμV/m)	Read Level (dBμV)	Antenna Factor (dB)	Cable Loss (dB)	Preamp Factor (dB)	Ant Pos (cm)	Table Pos (deg)	Remark
5787	103.7	-	-	91.14	35.09	11.47	34	117	1	Average
5787	114.01	-	-	101.45	35.09	11.47	34	117	1	Peak
11571	44.77	-29.23	74	54.3	37.92	11.09	58.54	100	0	Peak
17355	48.22	-25.78	74	53.46	40.94	12.42	58.6	100	0	Peak

Test Mode :	802.11a	Temperature :	22~23°C
Test Channel :	157	Relative Humidity :	52~53%
Test Engineer :	Hayden Wu	Polarization :	Vertical
Remark :	1. 5783 MHz is fundamental signal which can be ignored. 2. 11571 MHz is not within a restricted band, and satisfies both the average and peak limits of 15.209. 3. Average measurement was not performed if peak level went lower than the average limit.		

Frequency (MHz)	Level (dBμV/m)	Over Limit (dB)	Limit Line (dBμV/m)	Read Level (dBμV)	Antenna Factor (dB)	Cable Loss (dB)	Preamp Factor (dB)	Ant Pos (cm)	Table Pos (deg)	Remark
5783	96.62	-	-	84.11	35.08	11.43	34	199	349	Average
5783	106.93	-	-	94.42	35.08	11.43	34	199	349	Peak
11571	45.47	-28.53	74	55	37.92	11.09	58.54	100	0	Peak
17355	48.24	-25.76	74	53.48	40.94	12.42	58.6	100	0	Peak



Test Mode :	802.11a	Temperature :	22~23°C
Test Channel :	165	Relative Humidity :	52~53%
Test Engineer :	Hayden Wu	Polarization :	Horizontal
Remark :	1. 5822 MHz is fundamental signal which can be ignored. 2. 11649 MHz is not within a restricted band, and satisfies both the average and peak limits of 15.209. 3. Average measurement was not performed if peak level went lower than the average limit.		

Frequency (MHz)	Level (dBμV/m)	Over Limit (dB)	Limit Line (dBμV/m)	Read Level (dBμV)	Antenna Factor (dB)	Cable Loss (dB)	Preamp Factor (dB)	Ant Pos (cm)	Table Pos (deg)	Remark
131.25	21.14	-22.36	43.5	40.18	11.44	1.27	31.75	-	-	Peak
183.36	28.13	-15.37	43.5	49.3	9.12	1.46	31.75	100	250	Peak
272.46	25.5	-20.5	46	42.46	12.95	1.82	31.73	-	-	Peak
433	25.61	-20.39	46	38.4	16.8	2.27	31.86	-	-	Peak
664	29.15	-16.85	46	38.9	19.45	2.83	32.03	-	-	Peak
832	25.12	-20.88	46	33.15	20.62	3.17	31.82	-	-	Peak
5822	100.13	-	-	87.51	35.11	11.51	34	115	1	Average
5822	110.62	-	-	98	35.11	11.51	34	115	1	Peak
11649	45.27	-28.73	74	54.66	38.05	11.14	58.58	100	0	Peak
17475	48.41	-25.59	74	53.69	40.75	12.57	58.6	100	0	Peak



Test Mode :	802.11a	Temperature :	22~23°C
Test Channel :	165	Relative Humidity :	52~53%
Test Engineer :	Hayden Wu	Polarization :	Vertical
Remark :	1. 5827 MHz is fundamental signal which can be ignored. 2. 11649 MHz is not within a restricted band, and satisfies both the average and peak limits of 15.209. 3. Average measurement was not performed if peak level went lower than the average limit.		

Frequency (MHz)	Level (dBμV/m)	Over Limit (dB)	Limit Line (dBμV/m)	Read Level (dBμV)	Antenna Factor (dB)	Cable Loss (dB)	Preamp Factor (dB)	Ant Pos (cm)	Table Pos (deg)	Remark
50.25	21.99	-18.01	40	44.67	8.3	0.8	31.78	100	279	Peak
143.94	25.37	-18.13	43.5	45.03	10.77	1.32	31.75	-	-	Peak
233.04	23.42	-22.58	46	42.94	10.56	1.66	31.74	-	-	Peak
366.5	24.59	-21.41	46	39.41	14.86	2.11	31.79	-	-	Peak
664	26.32	-19.68	46	36.07	19.45	2.83	32.03	-	-	Peak
907.6	24.79	-21.21	46	31.86	21.02	3.37	31.46	-	-	Peak
5827	90.68	-	-	78.06	35.11	11.51	34	200	350	Average
5827	100.96	-	-	88.34	35.11	11.51	34	200	350	Peak
11649	45.22	-28.78	74	54.61	38.05	11.14	58.58	100	0	Peak
17475	48.6	-25.4	74	53.88	40.75	12.57	58.6	100	0	Peak



Test Mode :	802.11n HT20	Temperature :	22~23°C
Test Channel :	149	Relative Humidity :	52~53%
Test Engineer :	Hayden Wu	Polarization :	Horizontal
Remark :	1. 5748 MHz is fundamental signal which can be ignored.. 2. 11490 MHz is not within a restricted band, and satisfies both the average and peak limits of 15.209. 3. Average measurement was not performed if peak level went lower than the average limit.		

Frequency (MHz)	Level (dBμV/m)	Over Limit (dB)	Limit Line (dBμV/m)	Read Level (dBμV)	Antenna Factor (dB)	Cable Loss (dB)	Preamp Factor (dB)	Ant Pos (cm)	Table Pos (deg)	Remark
86.7	18.03	-21.97	40	40.8	7.96	1.03	31.76	-	-	Peak
181.74	29.61	-13.89	43.5	50.67	9.24	1.45	31.75	156	322	Peak
246	27.69	-18.31	46	45.67	12.04	1.72	31.74	-	-	Peak
331.5	26.8	-19.2	46	42.81	13.75	1.99	31.75	-	-	Peak
433	25.83	-20.17	46	38.62	16.8	2.27	31.86	-	-	Peak
867	24.7	-21.3	46	32.22	20.87	3.28	31.67	-	-	Peak
5748	99.51	-	-	87.07	35.04	11.39	33.99	105	2	Average
5748	109.72	-	-	97.28	35.04	11.39	33.99	105	2	Peak
11490	45.53	-28.47	74	55.22	37.79	11.04	58.52	100	0	Peak
17235	47.93	-26.07	74	53.13	41.13	12.27	58.6	100	0	Peak



Test Mode :	802.11n HT20	Temperature :	22~23°C
Test Channel :	149	Relative Humidity :	52~53%
Test Engineer :	Hayden Wu	Polarization :	Vertical
Remark :	1. 5743 MHz is fundamental signal which can be ignored. 2. 11490 MHz is not within a restricted band, and satisfies both the average and peak limits of 15.209. 3. Average measurement was not performed if peak level went lower than the average limit.		

Frequency (MHz)	Level (dBμV/m)	Over Limit (dB)	Limit Line (dBμV/m)	Read Level (dBμV)	Antenna Factor (dB)	Cable Loss (dB)	Preamp Factor (dB)	Ant Pos (cm)	Table Pos (deg)	Remark
48.36	21.54	-18.46	40	43.8	8.73	0.79	31.78	-	-	Peak
147.45	25.23	-18.27	43.5	45.01	10.64	1.33	31.75	-	-	Peak
246	23.5	-22.5	46	41.48	12.04	1.72	31.74	-	-	Peak
366.5	23.59	-22.41	46	38.41	14.86	2.11	31.79	-	-	Peak
665.4	28.16	-17.84	46	37.91	19.45	2.83	32.03	142	317	Peak
884.5	26.31	-19.69	46	33.68	20.9	3.33	31.6	-	-	Peak
5743	89.13	-	-	76.67	35.06	11.39	33.99	200	348	Average
5743	99.57	-	-	87.11	35.06	11.39	33.99	200	348	Peak
11490	45.3	-28.7	74	54.99	37.79	11.04	58.52	100	0	Peak
17235	47.31	-26.69	74	52.51	41.13	12.27	58.6	100	0	Peak



Test Mode :	802.11n HT20	Temperature :	22~23°C
Test Channel :	157	Relative Humidity :	52~53%
Test Engineer :	Hayden Wu	Polarization :	Horizontal
Remark :	<ol style="list-style-type: none"> 5783 MHz is fundamental signal which can be ignored. 11571 MHz is not within a restricted band, and satisfies both the average and peak limits of 15.209. Average measurement was not performed if peak level went lower than the average limit. 		

Frequency (MHz)	Level (dBμV/m)	Over Limit (dB)	Limit Line (dBμV/m)	Read Level (dBμV)	Antenna Factor (dB)	Cable Loss (dB)	Preamp Factor (dB)	Ant Pos (cm)	Table Pos (deg)	Remark
5783	104.28	-	-	91.77	35.08	11.43	34	105	2	Average
5783	114.51	-	-	102	35.08	11.43	34	105	2	Peak
11571	45.31	-28.69	74	54.84	37.92	11.09	58.54	100	0	Peak
17355	49.66	-24.34	74	54.9	40.94	12.42	58.6	100	0	Peak

Test Mode :	802.11n HT20	Temperature :	22~23°C
Test Channel :	157	Relative Humidity :	52~53%
Test Engineer :	Hayden Wu	Polarization :	Vertical
Remark :	<ol style="list-style-type: none"> 5783 MHz is fundamental signal which can be ignored. 11571 MHz is not within a restricted band, and satisfies both the average and peak limits of 15.209. Average measurement was not performed if peak level went lower than the average limit. 		

Frequency (MHz)	Level (dBμV/m)	Over Limit (dB)	Limit Line (dBμV/m)	Read Level (dBμV)	Antenna Factor (dB)	Cable Loss (dB)	Preamp Factor (dB)	Ant Pos (cm)	Table Pos (deg)	Remark
5783	96.57	-	-	84.06	35.08	11.43	34	200	348	Average
5783	106.83	-	-	94.32	35.08	11.43	34	200	348	Peak
11571	46.13	-27.87	74	55.66	37.92	11.09	58.54	100	0	Peak
17355	49.56	-24.44	74	54.8	40.94	12.42	58.6	100	0	Peak



Test Mode :	802.11n HT20	Temperature :	22~23°C
Test Channel :	165	Relative Humidity :	52~53%
Test Engineer :	Hayden Wu	Polarization :	Horizontal
Remark :	<ol style="list-style-type: none"> 5827 MHz is fundamental signal which can be ignored. 11649 MHz is not within a restricted band, and satisfies both the average and peak limits of 15.209. Average measurement was not performed if peak level went lower than the average limit. 		

Frequency (MHz)	Level (dBμV/m)	Over Limit (dB)	Limit Line (dBμV/m)	Read Level (dBμV)	Antenna Factor (dB)	Cable Loss (dB)	Preamp Factor (dB)	Ant Pos (cm)	Table Pos (deg)	Remark
5827	101.33	-	-	88.71	35.11	11.51	34	105	1	Average
5827	111.67	-	-	99.05	35.11	11.51	34	105	1	Peak
11649	45.34	-28.66	74	54.73	38.05	11.14	58.58	100	0	Peak
17475	48.32	-25.68	74	53.6	40.75	12.57	58.6	100	0	Peak

Test Mode :	802.11n HT20	Temperature :	22~23°C
Test Channel :	165	Relative Humidity :	52~53%
Test Engineer :	Hayden Wu	Polarization :	Vertical
Remark :	<ol style="list-style-type: none"> 5823 MHz is fundamental signal which can be ignored. 11649 MHz is not within a restricted band, and satisfies both the average and peak limits of 15.209. Average measurement was not performed if peak level went lower than the average limit. 		

Frequency (MHz)	Level (dBμV/m)	Over Limit (dB)	Limit Line (dBμV/m)	Read Level (dBμV)	Antenna Factor (dB)	Cable Loss (dB)	Preamp Factor (dB)	Ant Pos (cm)	Table Pos (deg)	Remark
5823	90.81	-	-	78.17	35.13	11.51	34	200	349	Average
5823	101.28	-	-	88.64	35.13	11.51	34	200	349	Peak
11649	45.19	-28.81	74	54.58	38.05	11.14	58.58	100	0	Peak
17475	48.54	-25.46	74	53.82	40.75	12.57	58.6	100	0	Peak



Test Mode :	802.11n HT40	Temperature :	22~23°C
Test Channel :	151	Relative Humidity :	52~53%
Test Engineer :	Hayden Wu	Polarization :	Horizontal
Remark :	<ol style="list-style-type: none"> 5753 MHz is fundamental signal which can be ignored. 11511 MHz is not within a restricted band, and satisfies both the average and peak limits of 15.209. Average measurement was not performed if peak level went lower than the average limit. 		

Frequency (MHz)	Level (dBμV/m)	Over Limit (dB)	Limit Line (dBμV/m)	Read Level (dBμV)	Antenna Factor (dB)	Cable Loss (dB)	Preamp Factor (dB)	Ant Pos (cm)	Table Pos (deg)	Remark
5753	95.9	-	-	83.46	35.04	11.39	33.99	105	2	Average
5753	105.28	-	-	92.84	35.04	11.39	33.99	105	2	Peak
11511	45.62	-28.38	74	55.26	37.8	11.06	58.5	100	0	Peak
17265	47.71	-26.29	74	52.91	41.07	12.33	58.6	100	0	Peak

Test Mode :	802.11n HT40	Temperature :	22~23°C
Test Channel :	151	Relative Humidity :	52~53%
Test Engineer :	Hayden Wu	Polarization :	Vertical
Remark :	<ol style="list-style-type: none"> 5752 MHz is fundamental signal which can be ignored. 11511 MHz is not within a restricted band, and satisfies both the average and peak limits of 15.209. Average measurement was not performed if peak level went lower than the average limit. 		

Frequency (MHz)	Level (dBμV/m)	Over Limit (dB)	Limit Line (dBμV/m)	Read Level (dBμV)	Antenna Factor (dB)	Cable Loss (dB)	Preamp Factor (dB)	Ant Pos (cm)	Table Pos (deg)	Remark
5752	86.5	-	-	74.04	35.06	11.39	33.99	200	348	Average
5752	95.96	-	-	83.5	35.06	11.39	33.99	200	348	Peak
11511	46.07	-27.93	74	55.71	37.8	11.06	58.5	100	0	Peak
17265	47.6	-26.4	74	52.8	41.07	12.33	58.6	100	0	Peak



Test Mode :	802.11n HT40	Temperature :	22~23°C
Test Channel :	159	Relative Humidity :	52~53%
Test Engineer :	Hayden Wu	Polarization :	Horizontal
Remark :	1. 5792 MHz is fundamental signal which can be ignored. 2. 11589 MHz is not within a restricted band, and satisfies both the average and peak limits of 15.209. 3. Average measurement was not performed if peak level went lower than the average limit.		

Frequency (MHz)	Level (dBμV/m)	Over Limit (dB)	Limit Line (dBμV/m)	Read Level (dBμV)	Antenna Factor (dB)	Cable Loss (dB)	Preamp Factor (dB)	Ant Pos (cm)	Table Pos (deg)	Remark
86.16	18.34	-21.66	40	41.11	7.96	1.03	31.76	-	-	Peak
182.55	33.48	-10.02	43.5	54.59	9.18	1.46	31.75	115	107	Peak
246.54	28.15	-17.85	46	46.13	12.04	1.72	31.74	-	-	Peak
333.6	28.6	-17.4	46	44.55	13.81	1.99	31.75	-	-	Peak
429.5	26.33	-19.67	46	39.12	16.8	2.26	31.85	-	-	Peak
664	26.92	-19.08	46	36.67	19.45	2.83	32.03	-	-	Peak
5792	100.84	-	-	88.33	35.08	11.43	34	106	2	Average
5792	111.04	-	-	98.53	35.08	11.43	34	106	2	Peak
11589	45.64	-28.36	74	55.13	37.96	11.1	58.55	100	0	Peak
17385	48.3	-25.7	74	53.53	40.89	12.48	58.6	100	0	Peak



Test Mode :	802.11n HT40	Temperature :	22~23°C
Test Channel :	159	Relative Humidity :	52~53%
Test Engineer :	Hayden Wu	Polarization :	Vertical
Remark :	1. 5792 MHz is fundamental signal which can be ignored. 2. 11589 MHz is not within a restricted band, and satisfies both the average and peak limits of 15.209. 3. Average measurement was not performed if peak level went lower than the average limit.		

Frequency (MHz)	Level (dBμV/m)	Over Limit (dB)	Limit Line (dBμV/m)	Read Level (dBμV)	Antenna Factor (dB)	Cable Loss (dB)	Preamp Factor (dB)	Ant Pos (cm)	Table Pos (deg)	Remark
48.36	22.5	-17.5	40	44.76	8.73	0.79	31.78	-	-	Peak
189.3	27.2	-16.3	43.5	48.39	9.08	1.48	31.75	-	-	Peak
232.5	23.18	-22.82	46	42.7	10.56	1.66	31.74	-	-	Peak
336.4	25.59	-20.41	46	41.46	13.89	2	31.76	-	-	Peak
664	31.53	-14.47	46	41.28	19.45	2.83	32.03	116	127	Peak
853	25.86	-20.14	46	33.55	20.8	3.24	31.73	-	-	Peak
5792	92.3	-	-	79.74	35.09	11.47	34	200	348	Average
5792	102.32	-	-	89.76	35.09	11.47	34	200	348	Peak
11589	45.24	-28.76	74	54.73	37.96	11.1	58.55	100	0	Peak
17385	48.09	-25.91	74	53.32	40.89	12.48	58.6	100	0	Peak



Test Mode :	802.11n VHT20	Temperature :	22~23°C
Test Channel :	149	Relative Humidity :	52~53%
Test Engineer :	Hayden Wu	Polarization :	Horizontal
Remark :	<ol style="list-style-type: none"> 5747 MHz is fundamental signal which can be ignored.. 11490 MHz is not within a restricted band, and satisfies both the average and peak limits of 15.209. Average measurement was not performed if peak level went lower than the average limit. 		

Frequency (MHz)	Level (dBμV/m)	Over Limit (dB)	Limit Line (dBμV/m)	Read Level (dBμV)	Antenna Factor (dB)	Cable Loss (dB)	Preamp Factor (dB)	Ant Pos (cm)	Table Pos (deg)	Remark
5747	99.96	-	-	87.5	35.06	11.39	33.99	107	1	Average
5747	109.43	-	-	96.97	35.06	11.39	33.99	107	1	Peak
11490	45.93	-28.07	74	55.62	37.79	11.04	58.52	100	0	Peak
17235	47.34	-26.66	74	44.38	21.7	12.27	31.01	100	0	Peak

Test Mode :	802.11n VHT20	Temperature :	22~23°C
Test Channel :	149	Relative Humidity :	52~53%
Test Engineer :	Hayden Wu	Polarization :	Vertical
Remark :	<ol style="list-style-type: none"> 5748 MHz is fundamental signal which can be ignored. 11490 MHz is not within a restricted band, and satisfies both the average and peak limits of 15.209. Average measurement was not performed if peak level went lower than the average limit. 		

Frequency (MHz)	Level (dBμV/m)	Over Limit (dB)	Limit Line (dBμV/m)	Read Level (dBμV)	Antenna Factor (dB)	Cable Loss (dB)	Preamp Factor (dB)	Ant Pos (cm)	Table Pos (deg)	Remark
5748	89.99	-	-	77.55	35.04	11.39	33.99	200	348	Average
5748	99.54	-	-	87.1	35.04	11.39	33.99	200	348	Peak
11490	45.37	-28.63	74	55.06	37.79	11.04	58.52	100	0	Peak
17235	46.87	-27.13	74	43.91	21.7	12.27	31.01	100	0	Peak



Test Mode :	802.11n VHT20	Temperature :	22~23°C
Test Channel :	157	Relative Humidity :	52~53%
Test Engineer :	Hayden Wu	Polarization :	Horizontal
Remark :	<ol style="list-style-type: none"> 5784 MHz is fundamental signal which can be ignored. 11571 MHz is not within a restricted band, and satisfies both the average and peak limits of 15.209. Average measurement was not performed if peak level went lower than the average limit. 		

Frequency (MHz)	Level (dBμV/m)	Over Limit (dB)	Limit Line (dBμV/m)	Read Level (dBμV)	Antenna Factor (dB)	Cable Loss (dB)	Preamp Factor (dB)	Ant Pos (cm)	Table Pos (deg)	Remark
5784	104.47	-	-	91.96	35.08	11.43	34	106	1	Average
5784	113.87	-	-	101.36	35.08	11.43	34	106	1	Peak
11571	44.7	-29.3	74	54.23	37.92	11.09	58.54	100	0	Peak
17355	47.98	-26.02	74	44.71	21.82	12.42	30.97	100	0	Peak

Test Mode :	802.11n VHT20	Temperature :	22~23°C
Test Channel :	157	Relative Humidity :	52~53%
Test Engineer :	Hayden Wu	Polarization :	Vertical
Remark :	<ol style="list-style-type: none"> 5782 MHz is fundamental signal which can be ignored. 11571 MHz is not within a restricted band, and satisfies both the average and peak limits of 15.209. Average measurement was not performed if peak level went lower than the average limit. 		

Frequency (MHz)	Level (dBμV/m)	Over Limit (dB)	Limit Line (dBμV/m)	Read Level (dBμV)	Antenna Factor (dB)	Cable Loss (dB)	Preamp Factor (dB)	Ant Pos (cm)	Table Pos (deg)	Remark
5782	97.51	-	-	85	35.08	11.43	34	199	348	Average
5782	107.1	-	-	94.59	35.08	11.43	34	199	348	Peak
11571	44.87	-29.13	74	54.4	37.92	11.09	58.54	100	0	Peak
17355	47.84	-26.16	74	44.57	21.82	12.42	30.97	100	0	Peak



Test Mode :	802.11n VHT20	Temperature :	22~23°C
Test Channel :	165	Relative Humidity :	52~53%
Test Engineer :	Hayden Wu	Polarization :	Horizontal
Remark :	<ol style="list-style-type: none"> 5823 MHz is fundamental signal which can be ignored. 11649 MHz is not within a restricted band, and satisfies both the average and peak limits of 15.209. Average measurement was not performed if peak level went lower than the average limit. 		

Frequency (MHz)	Level (dBμV/m)	Over Limit (dB)	Limit Line (dBμV/m)	Read Level (dBμV)	Antenna Factor (dB)	Cable Loss (dB)	Preamp Factor (dB)	Ant Pos (cm)	Table Pos (deg)	Remark
5823	102.24	-	-	89.62	35.11	11.51	34	104	3	Average
5823	112.33	-	-	99.71	35.11	11.51	34	104	3	Peak
11649	44.59	-29.41	74	53.98	38.05	11.14	58.58	100	0	Peak
17475	47.64	-26.36	74	44.3	21.69	12.57	30.92	100	0	Peak

Test Mode :	802.11n VHT20	Temperature :	22~23°C
Test Channel :	165	Relative Humidity :	52~53%
Test Engineer :	Hayden Wu	Polarization :	Vertical
Remark :	<ol style="list-style-type: none"> 5827 MHz is fundamental signal which can be ignored. 11649 MHz is not within a restricted band, and satisfies both the average and peak limits of 15.209. Average measurement was not performed if peak level went lower than the average limit. 		

Frequency (MHz)	Level (dBμV/m)	Over Limit (dB)	Limit Line (dBμV/m)	Read Level (dBμV)	Antenna Factor (dB)	Cable Loss (dB)	Preamp Factor (dB)	Ant Pos (cm)	Table Pos (deg)	Remark
5827	92.11	-	-	79.47	35.13	11.51	34	200	349	Average
5827	102.86	-	-	90.22	35.13	11.51	34	200	349	Peak
11649	44.98	-29.02	74	54.37	38.05	11.14	58.58	100	0	Peak
17475	48.73	-25.27	74	45.39	21.69	12.57	30.92	100	0	Peak



Test Mode :	802.11n VHT40	Temperature :	22~23°C
Test Channel :	151	Relative Humidity :	52~53%
Test Engineer :	Hayden Wu	Polarization :	Horizontal
Remark :	<ol style="list-style-type: none"> 5755 MHz is fundamental signal which can be ignored. 11511 MHz is not within a restricted band, and satisfies both the average and peak limits of 15.209. Average measurement was not performed if peak level went lower than the average limit. 		

Frequency (MHz)	Level (dBμV/m)	Over Limit (dB)	Limit Line (dBμV/m)	Read Level (dBμV)	Antenna Factor (dB)	Cable Loss (dB)	Preamp Factor (dB)	Ant Pos (cm)	Table Pos (deg)	Remark
5755	96.97	-	-	84.51	35.06	11.39	33.99	107	0	Average
5755	106.09	-	-	93.63	35.06	11.39	33.99	107	0	Peak
11511	45.53	-28.47	74	55.17	37.8	11.06	58.5	100	0	Peak
17265	48.19	-25.81	74	45.11	21.75	12.33	31	100	0	Peak

Test Mode :	802.11n VHT40	Temperature :	22~23°C
Test Channel :	151	Relative Humidity :	52~53%
Test Engineer :	Hayden Wu	Polarization :	Vertical
Remark :	<ol style="list-style-type: none"> 5755 MHz is fundamental signal which can be ignored. 11511 MHz is not within a restricted band, and satisfies both the average and peak limits of 15.209. Average measurement was not performed if peak level went lower than the average limit. 		

Frequency (MHz)	Level (dBμV/m)	Over Limit (dB)	Limit Line (dBμV/m)	Read Level (dBμV)	Antenna Factor (dB)	Cable Loss (dB)	Preamp Factor (dB)	Ant Pos (cm)	Table Pos (deg)	Remark
5755	82.94	-	-	70.48	35.06	11.39	33.99	100	30	Average
5755	92.63	-	-	80.17	35.06	11.39	33.99	100	30	Peak
11511	45.23	-28.77	74	54.87	37.8	11.06	58.5	100	0	Peak
17265	47.91	-26.09	74	44.83	21.75	12.33	31	100	0	Peak



Test Mode :	802.11n VHT40	Temperature :	22~23°C
Test Channel :	159	Relative Humidity :	52~53%
Test Engineer :	Hayden Wu	Polarization :	Horizontal
Remark :	<ol style="list-style-type: none"> 5795 MHz is fundamental signal which can be ignored. 11589 MHz is not within a restricted band, and satisfies both the average and peak limits of 15.209. Average measurement was not performed if peak level went lower than the average limit. 		

Frequency (MHz)	Level (dBμV/m)	Over Limit (dB)	Limit Line (dBμV/m)	Read Level (dBμV)	Antenna Factor (dB)	Cable Loss (dB)	Preamp Factor (dB)	Ant Pos (cm)	Table Pos (deg)	Remark
5795	99.63	-	-	87.07	35.09	11.47	34	106	0	Average
5795	108.92	-	-	96.36	35.09	11.47	34	106	0	Peak
11589	46.1	-27.9	74	55.59	37.96	11.1	58.55	100	0	Peak
17385	48.21	-25.79	74	44.84	21.84	12.48	30.95	100	0	Peak

Test Mode :	802.11n VHT40	Temperature :	22~23°C
Test Channel :	159	Relative Humidity :	52~53%
Test Engineer :	Hayden Wu	Polarization :	Vertical
Remark :	<ol style="list-style-type: none"> 5795 MHz is fundamental signal which can be ignored. 11589 MHz is not within a restricted band, and satisfies both the average and peak limits of 15.209. Average measurement was not performed if peak level went lower than the average limit. 		

Frequency (MHz)	Level (dBμV/m)	Over Limit (dB)	Limit Line (dBμV/m)	Read Level (dBμV)	Antenna Factor (dB)	Cable Loss (dB)	Preamp Factor (dB)	Ant Pos (cm)	Table Pos (deg)	Remark
5795	89.31	-	-	76.75	35.09	11.47	34	108	30	Average
5795	98.79	-	-	86.23	35.09	11.47	34	108	30	Peak
11589	45.22	-28.78	74	54.71	37.96	11.1	58.55	100	0	Peak
17385	47.88	-26.12	74	44.51	21.84	12.48	30.95	100	0	Peak



Test Mode :	802.11ac VHT80	Temperature :	22~23°C
Test Channel :	155	Relative Humidity :	52~53%
Test Engineer :	Hayden Wu	Polarization :	Horizontal
Remark :	1. 5775 MHz is fundamental signal which can be ignored. 2. 11550 MHz is not within a restricted band, and satisfies both the average and peak limits of 15.209. 3. Average measurement was not performed if peak level went lower than the average limit.		

Frequency (MHz)	Level (dBμV/m)	Over Limit (dB)	Limit Line (dBμV/m)	Read Level (dBμV)	Antenna Factor (dB)	Cable Loss (dB)	Preamp Factor (dB)	Ant Pos (cm)	Table Pos (deg)	Remark
85.89	17.67	-22.33	40	40.44	7.96	1.03	31.76	-	-	Peak
182.82	29.3	-14.2	43.5	50.47	9.12	1.46	31.75	157	234	Peak
269.22	23.71	-22.29	46	40.63	13	1.81	31.73	-	-	Peak
426	26.4	-19.6	46	39.2	16.8	2.25	31.85	-	-	Peak
664	24.85	-21.15	46	34.6	19.45	2.83	32.03	-	-	Peak
928.6	26.2	-19.8	46	32.92	21.18	3.36	31.26	-	-	Peak
5775	93.45	-	-	80.94	35.08	11.43	34	106	0	Average
5775	103.06	-	-	90.55	35.08	11.43	34	106	0	Peak
11550	45.57	-28.43	74	55.12	37.89	11.09	58.53	100	0	Peak
17325	48.28	-25.72	74	53.5	40.99	12.39	58.6	100	0	Peak



Test Mode :	802.11ac VHT80	Temperature :	22~23°C
Test Channel :	155	Relative Humidity :	52~53%
Test Engineer :	Hayden Wu	Polarization :	Vertical
Remark :	1. 5775 MHz is fundamental signal which can be ignored. 2. 11550 MHz is not within a restricted band, and satisfies both the average and peak limits of 15.209. 3. Average measurement was not performed if peak level went lower than the average limit.		

Frequency (MHz)	Level (dBμV/m)	Over Limit (dB)	Limit Line (dBμV/m)	Read Level (dBμV)	Antenna Factor (dB)	Cable Loss (dB)	Preamp Factor (dB)	Ant Pos (cm)	Table Pos (deg)	Remark
99.66	16.54	-26.96	43.5	36.39	10.8	1.1	31.75	-	-	Peak
179.04	25.51	-17.99	43.5	46.44	9.35	1.47	31.75	146	253	Peak
232.5	23.23	-22.77	46	42.75	10.56	1.66	31.74	-	-	Peak
433	23.26	-22.74	46	36.05	16.8	2.27	31.86	-	-	Peak
667.5	26.5	-19.5	46	36.23	19.47	2.83	32.03	-	-	Peak
944	24.9	-21.1	46	31.37	21.3	3.35	31.12	-	-	Peak
5775	80.24	-	-	67.73	35.08	11.43	34	110	29	Average
5775	89.43	-	-	76.92	35.08	11.43	34	110	29	Peak
11550	45.49	-28.51	74	55.04	37.89	11.09	58.53	100	0	Peak
17325	47.9	-26.1	74	53.12	40.99	12.39	58.6	100	0	Peak



3.5 AC Conducted Emission Measurement

3.5.1 Limit of AC Conducted Emission

For equipment that is designed to be connected to the public utility (AC) power line, the radio frequency voltage that is conducted back onto the AC power line on any frequency or frequencies within the band 150 kHz to 30 MHz shall not exceed the limits in the following table.

Frequency of emission (MHz)	Conducted limit (dB μ V)	
	Quasi-peak	Average
0.15-0.5	66 to 56*	56 to 46*
0.5-5	56	46
5-30	60	50

*Decreases with the logarithm of the frequency.

3.5.2 Measuring Instruments

The measuring equipment is listed in the section 4 of this test report.

3.5.3 Test Procedures

1. The EUT was placed 0.4 meter from the conducting wall of the shielding room was kept at least 80 centimeters from any other grounded conducting surface.
2. Connect EUT to the power mains through a line impedance stabilization network (LISN).
3. All the support units are connecting to the other LISN.
4. The LISN provides 50 ohm coupling impedance for the measuring instrument.
5. The FCC states that a 50 ohm, 50 microhenry LISN should be used.
6. Both sides of AC line were checked for maximum conducted interference.
7. The frequency range from 150 kHz to 30 MHz was searched.
8. Set the test-receiver system to Peak Detect Function and specified bandwidth with Maximum Hold Mode.

3.5.4 Test Setup

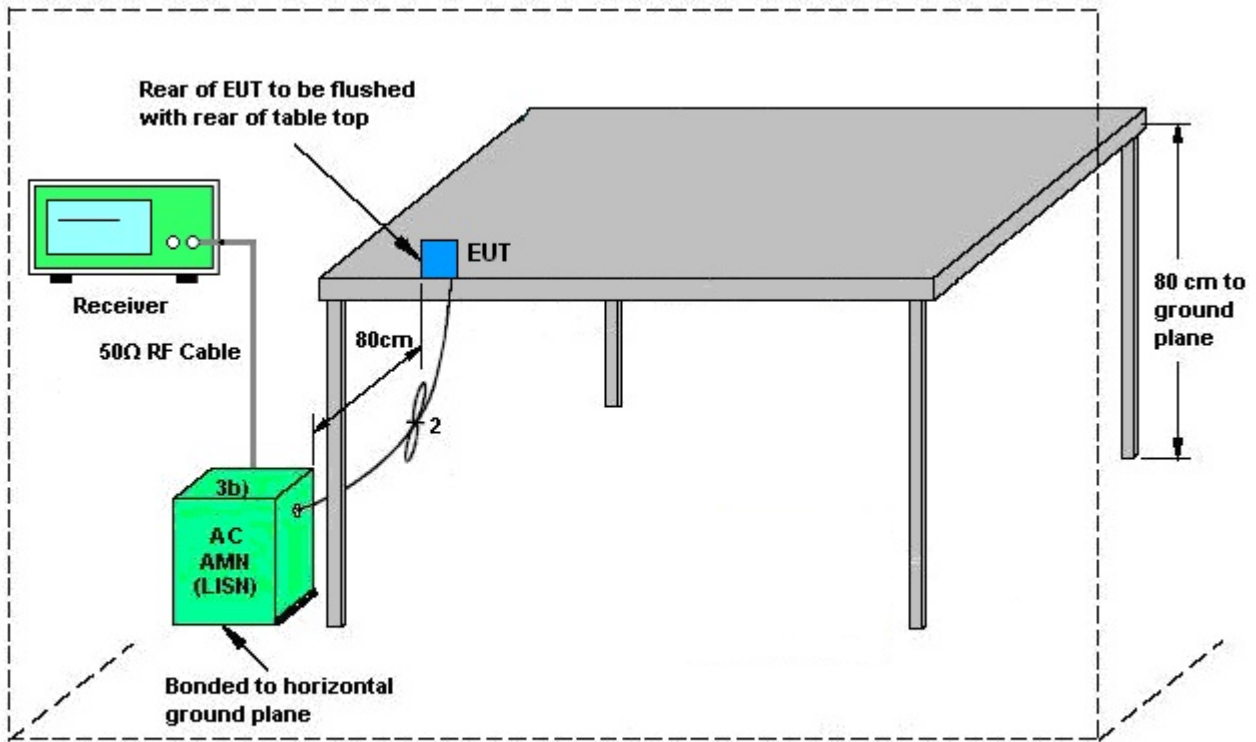

AMN = Artificial mains network (LISN)
AE = Associated equipment
EUT = Equipment under test
ISN = Impedance stabilization network



3.5.5 Test Result of AC Conducted Emission

Test Mode :	Mode 1	Temperature :	20~22°C
Test Engineer :	Cosmo Xu	Relative Humidity :	45~47%
Test Voltage :	120Vac / 60Hz	Phase :	Line
Function Type :	GSM850 Idle + Bluetooth Link + WLAN (5GHz) Link + Earphone + MP3 + Battery + USB Cable (Charging from Adapter)		

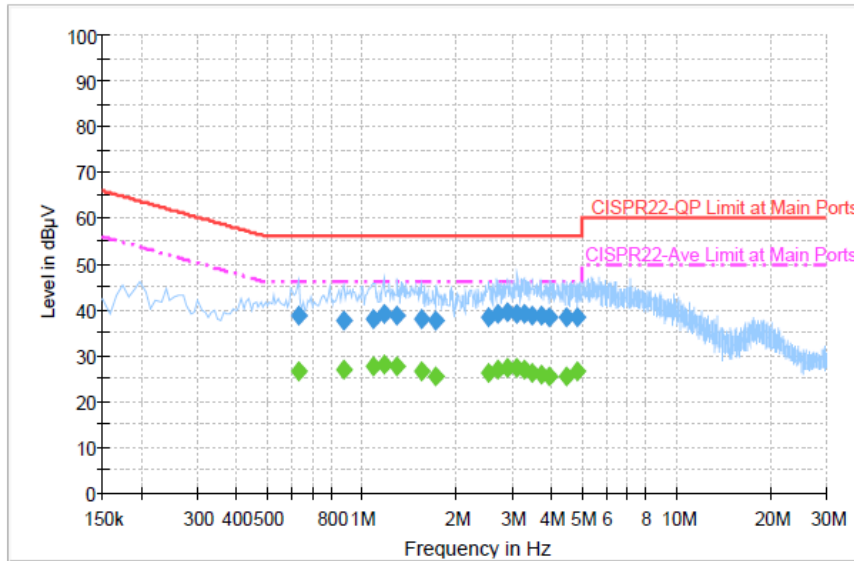

Final Result : QuasiPeak

Frequency (MHz)	QuasiPeak (dBµV)	Filter	Line	Corr. (dB)	Margin (dB)	Limit (dBµV)
0.630000	38.7	Off	L1	19.4	17.3	56.0
0.878000	37.8	Off	L1	19.4	18.2	56.0
1.086000	38.1	Off	L1	19.5	17.9	56.0
1.174000	39.0	Off	L1	19.5	17.0	56.0
1.294000	38.6	Off	L1	19.5	17.4	56.0
1.542000	37.9	Off	L1	19.4	18.1	56.0
1.718000	37.6	Off	L1	19.5	18.4	56.0
2.534000	38.5	Off	L1	19.6	17.5	56.0
2.702000	39.1	Off	L1	19.5	16.9	56.0
2.918000	39.4	Off	L1	19.6	16.6	56.0
3.118000	39.0	Off	L1	19.6	17.0	56.0
3.278000	39.2	Off	L1	19.6	16.8	56.0
3.486000	38.7	Off	L1	19.6	17.3	56.0
3.734000	38.7	Off	L1	19.6	17.3	56.0
3.942000	38.4	Off	L1	19.6	17.6	56.0
4.486000	38.2	Off	L1	19.6	17.8	56.0
4.838000	38.5	Off	L1	19.6	17.5	56.0



Test Mode :	Mode 1	Temperature :	20~22°C
Test Engineer :	Cosmo Xu	Relative Humidity :	45~47%
Test Voltage :	120Vac / 60Hz	Phase :	Line
Function Type :	GSM850 Idle + Bluetooth Link + WLAN (5GHz) Link + Earphone + MP3 + Battery + USB Cable (Charging from Adapter)		

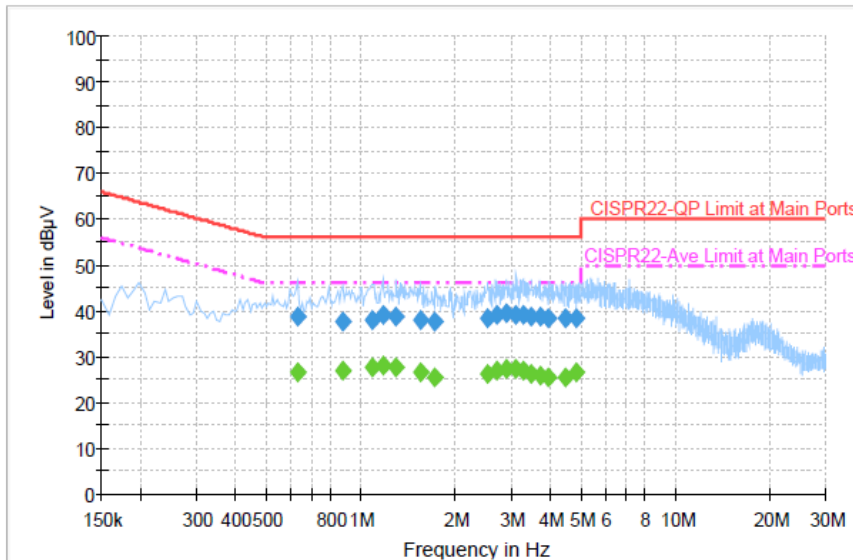

Final Result : Average

Frequency (MHz)	Average (dBµV)	Filter	Line	Corr. (dB)	Margin (dB)	Limit (dBµV)
0.630000	26.6	Off	L1	19.4	19.4	46.0
0.878000	27.1	Off	L1	19.4	18.9	46.0
1.086000	27.5	Off	L1	19.5	18.5	46.0
1.174000	27.9	Off	L1	19.5	18.1	46.0
1.294000	27.6	Off	L1	19.5	18.4	46.0
1.542000	26.5	Off	L1	19.4	19.5	46.0
1.718000	25.5	Off	L1	19.5	20.5	46.0
2.534000	26.1	Off	L1	19.6	19.9	46.0
2.702000	26.9	Off	L1	19.5	19.1	46.0
2.918000	27.4	Off	L1	19.6	18.6	46.0
3.118000	27.2	Off	L1	19.6	18.8	46.0
3.278000	27.0	Off	L1	19.6	19.0	46.0
3.486000	26.3	Off	L1	19.6	19.7	46.0
3.734000	25.7	Off	L1	19.6	20.3	46.0
3.942000	25.5	Off	L1	19.6	20.5	46.0
4.486000	25.4	Off	L1	19.6	20.6	46.0
4.838000	26.5	Off	L1	19.6	19.5	46.0



Test Mode :	Mode 1	Temperature :	20~22°C
Test Engineer :	Cosmo Xu	Relative Humidity :	45~47%
Test Voltage :	120Vac / 60Hz	Phase :	Neutral
Function Type :	GSM850 Idle + Bluetooth Link + WLAN (5GHz) Link + Earphone + MP3 + Battery + USB Cable (Charging from Adapter)		

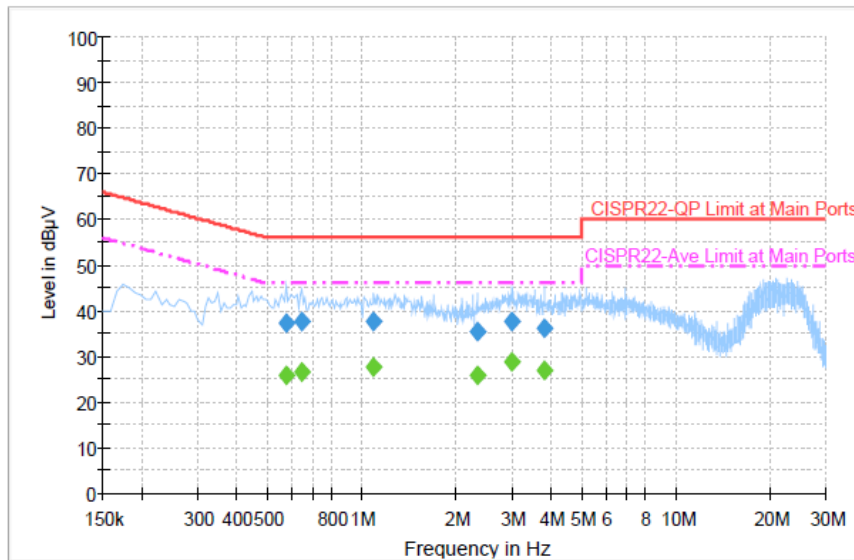

Final Result : QuasiPeak

Frequency (MHz)	QuasiPeak (dBµV)	Filter	Line	Corr. (dB)	Margin (dB)	Limit (dBµV)
0.574000	37.4	Off	N	19.3	18.6	56.0
0.646000	37.5	Off	N	19.4	18.5	56.0
1.094000	37.5	Off	N	19.5	18.5	56.0
2.334000	35.3	Off	N	19.6	20.7	56.0
3.014000	37.6	Off	N	19.6	18.4	56.0
3.814000	36.1	Off	N	19.6	19.9	56.0

Final Result : Average

Frequency (MHz)	Average (dBµV)	Filter	Line	Corr. (dB)	Margin (dB)	Limit (dBµV)
0.574000	25.7	Off	N	19.3	20.3	46.0
0.646000	26.5	Off	N	19.4	19.5	46.0
1.094000	27.8	Off	N	19.5	18.2	46.0
2.334000	25.8	Off	N	19.6	20.2	46.0
3.014000	28.7	Off	N	19.6	17.3	46.0
3.814000	26.9	Off	N	19.6	19.1	46.0

3.6 Frequency Stability Measurement

3.6.1 Limit of Frequency Stability

Manufacturers of U-NII devices are responsible for ensuring frequency stability such that an emission is maintained within the band of operation under all conditions of normal operation as specified in the user's manual.

3.6.2 Measuring Instruments

The measuring equipment is listed in the section 4 of this test report.

3.6.3 Test Procedures

1. To ensure emission at the band edge is maintained within the authorized band, those values shall be measured by radiation emissions at upper and lower frequency points, and finally compensated by frequency deviation as procedures below.
2. The EUT was operated at the maximum output power, and connected to the spectrum analyzer, which is set to maximum hold function and peak detector. The peak value of the power envelope was measured and noted. The upper and lower frequency points were respectively measured relatively 10dB lower than the measured peak value.
3. The frequency deviation was calculated by adding the upper frequency point and the lower frequency point divided by two. Those detailed values of frequency deviation are provided in table below.

3.6.4 Test Setup





3.6.5 Test Result of Frequency Stability

Test Band :	5GHz band 4	Test Engineer :	Alex Lee
-------------	-------------	-----------------	----------

Mod.	Data Rate	N _{TX}	Channel	Freq. (MHz)	Center Frequency (MHz)	Frequency Deviation (MHz)	Frequency Stability (ppm)	Temperature (°C)	Voltage (V)
11a	6Mbps	1	149	5745	5745.000	0.000	0.00	20	3.4
11a	6Mbps	1	149	5745	5745.025	0.025	4.35	20	4.35
11a	6Mbps	1	149	5745	5745.050	0.050	8.70	20	3.9
11a	6Mbps	1	149	5745	5745.025	0.025	4.35	-30	3.9
11a	6Mbps	1	149	5745	5745.000	0.000	0.00	60	3.9

Note: Center Frequency = (Low Frequency + High Frequency) / 2.



3.7 Automatically Discontinue Transmission

3.7.1 Limit of Automatically Discontinue Transmission

The device shall automatically discontinue transmission in case of either absence of information to transmit or operational failure. These provisions are not intended to preclude the transmission of control or signaling information or the use of repetitive codes used by certain digital technologies to complete frame or burst intervals. Applicants shall include in their application for equipment authorization to describe how this requirement is met.

3.7.2 Measuring Instruments

The measuring equipment is listed in the section 4 of this test report.

3.7.3 Test Result of Automatically Discontinue Transmission

While the EUT is not transmitting any information, the EUT can automatically discontinue transmission and become standby mode for power saving. The EUT can detect the controlling signal of ACK message transmitting from remote device and verify whether it shall resend or discontinue transmission.



3.8 Antenna Requirements

3.8.1 Standard Applicable

According to FCC 47 CFR Section 15.407(a)(1)(2) ,if transmitting antenna directional gain is greater than 6 dBi, both the peak transmit power and the peak power spectral density shall be reduced by the amount in dB that the directional gain of the antenna exceeds 6 dBi.

3.8.2 Antenna Anti-Replacement Construction

An embedded-in antenna design is used.

3.8.3 Antenna Gain

The antenna gain is less than 6 dBi. Therefore, it is not necessary to reduce maximum peak output power limit.



4 List of Measuring Equipment

Instrument	Manufacturer	Model No.	Serial No.	Characteristics	Calibration Date	Test Date	Due Date	Remark
Spectrum Analyzer	Rohde & Schwarz	FSP40	100057	9kHz~40GHz	Oct. 23, 2013	May 01, 2014 ~ Jul. 11, 2014	Oct. 22, 2014	Conducted (TH02-HY)
Power Meter	Anritsu	ML2495A	1036004	300MHz~40GHz	Aug. 17, 2013	May 01, 2014 ~ Jul. 11, 2014	Aug. 16, 2014	Conducted (TH02-HY)
Power Sensor	Anritsu	MA2411B	1027253	300MHz~40GHz	Aug. 17, 2013	May 01, 2014 ~ Jul. 11, 2014	Aug. 16, 2014	Conducted (TH02-HY)
Spectrum Analyzer	R&S	FSP30	101067	9kHz ~ 30GHz	Nov. 20, 2013	Jul. 08, 2014 ~ Jul. 11, 2014	Nov. 19, 2014	Radiation (03CH06-HY)
Spectrum Analyzer	Agilent	E4408B	MY44211030	9kHz ~ 26.5GHz	Dec. 02, 2013	Jul. 08, 2014 ~ Jul. 11, 2014	Dec. 01, 2014	Radiation (03CH06-HY)
EMI Test Receiver	R&S	ESVS10	834468/0003	20MHz ~ 1000MHz	May 06, 2014	Jul. 08, 2014 ~ Jul. 11, 2014	May 05, 2015	Radiation (03CH06-HY)
Loop Antenna	Rohde & Schwarz	HFH2-Z2	860004/0001	9kHz ~ 30MHz	Jul. 03, 2012	Jun. 08, 2014 ~ Jun. 11, 2014	Jul. 02, 2014	Radiation (03CH06-HY)
Loop Antenna	TESEQ	HLA6120	31244	9kHz ~ 30MHz	Dec. 02, 2012	Jul. 11, 2014	Dec. 01, 2014	Radiation (03CH06-HY)
Bilog Antenna	Schaffner	CBL6112B	2885	30MHz ~ 2GHz	Oct. 10, 2013	Jul. 08, 2014 ~ Jul. 11, 2014	Oct. 09, 2014	Radiation (03CH06-HY)
Double Ridge Horn Antenna	EMCO	3117	00066583	1GHz ~ 18GHz	Aug. 02, 2013	Jul. 08, 2014 ~ Jul. 11, 2014	Aug. 01, 2014	Radiation (03CH06-HY)
Amplifier	SONOMA	310N	186713	9kHz ~ 1GHz	Apr. 16, 2014	Jul. 08, 2014 ~ Jul. 11, 2014	Apr. 15, 2015	Radiation (03CH06-HY)
Pre Amplifier	EMCI	EMC051845	SN980048	1GHz ~ 18GHz	Jul. 18, 2013	Jul. 08, 2014 ~ Jul. 11, 2014	Jul. 17, 2014	Radiation (03CH06-HY)
SHF-EHF Horn Antenna	SCHWARZBECK	BBHA 9170	BBHA9170251	15GHz ~ 40GHz	Oct. 03, 2013	Jul. 08, 2014 ~ Jul. 11, 2014	Oct. 02, 2014	Radiation (03CH06-HY)
Preamplifier	Agilent	8449B	3008A01917	1GHz ~ 26.5GHz	Apr. 10, 2014	Jul. 08, 2014 ~ Jul. 11, 2014	Apr. 09, 2015	Radiation (03CH06-HY)
Amplifier	EM	EM18G40G	060604	18GHz ~ 40GHz	Oct. 17, 2013	Jul. 08, 2014 ~ Jul. 11, 2014	Oct. 16, 2014	Radiation (03CH06-HY)
Turn Table	INN-CO	DS2000	420/650/00	0 ~ 360 degree	N/A	Jul. 08, 2014 ~ Jul. 11, 2014	N/A	Radiation (03CH06-HY)
Antenna Mast	MF	MF-7802	MF780208212	1 m ~ 4 m	N/A	Jul. 08, 2014 ~ Jul. 11, 2014	N/A	Radiation (03CH06-HY)
EMI Test Receiver	Rohde & Schwarz	ESCS 30	100356	9kHz ~ 2.75GHz	Nov. 15, 2013	May 14, 2014	Nov. 14, 2014	Conduction (CO05-HY)
LISN (for auxiliary equipment)	Rohde & Schwarz	ENV216	100081	9kHz ~ 30MHz	Dec. 12, 2013	May 14, 2014	Dec. 11, 2014	Conduction (CO05-HY)
LISN	Rohde & Schwarz	ENV216	100080	9kHz ~ 30MHz	Dec. 04, 2013	May 14, 2014	Dec. 03, 2014	Conduction (CO05-HY)
AC Power Source	ChainTek	APC-1000W	N/A	N/A	N/A	May 14, 2014	N/A	Conduction (CO05-HY)



5 Uncertainty of Evaluation

Uncertainty of Conducted Emission Measurement (150kHz ~ 30MHz)

Measuring Uncertainty for a Level of Confidence of 95% ($U = 2Uc(y)$)	2.26
---	------

Uncertainty of Radiated Emission Measurement (30 MHz ~ 1000 MHz)

Measuring Uncertainty for a Level of Confidence of 95% ($U = 2Uc(y)$)	4.50
---	------