



# FCC RF Test Report

APPLICANT : Motorola Mobility, LLC  
EQUIPMENT : Mobile Cellular Phone  
BRAND NAME : Motorola Mobility, LLC  
FCC MODEL NAME : 3578  
FCC ID : IHDT56QA1  
STANDARD : FCC Part 15 Subpart C §15.247  
CLASSIFICATION : (DSS) Spread Spectrum Transmitt

The product was received on Apr. 29, 2014 and testing was completed on Jun. 07, 2014. We, SPORTON INTERNATIONAL INC., would like to declare that the tested sample has been evaluated in accordance with the test procedures and has been in compliance with the applicable technical standards.

The test results in this report apply exclusively to the tested model / sample. Without written approval of SPORTON INTERNATIONAL INC., the test report shall not be reproduced except in full.

Reviewed by: Joseph Lin / Supervisor

Approved by: Jones Tsai / Manager



## SPORTON INTERNATIONAL INC.

No. 52, Hwa Ya 1<sup>st</sup> Rd., Hwa Ya Technology Park, Kwei-Shan Hsiang, Tao Yuan Hsien, Taiwan, R.O.C.



# TABLE OF CONTENTS

**REVISION HISTORY..... 3**

**SUMMARY OF TEST RESULT ..... 4**

**1 GENERAL DESCRIPTION..... 5**

1.1 Applicant ..... 5

1.2 Manufacturer..... 5

1.3 Product Feature of Equipment Under Test..... 5

1.4 Product Specification subjective to this standard ..... 6

1.5 Modification of EUT ..... 6

1.6 Testing Location ..... 6

1.7 Applicable Standards..... 7

**2 TEST CONFIGURATION OF EQUIPMENT UNDER TEST..... 8**

2.1 Descriptions of Test Mode ..... 8

2.2 Test Mode..... 9

2.3 Connection Diagram of Test System..... 10

2.4 Support Unit used in test configuration and system ..... 11

2.5 EUT Operation Test Setup ..... 11

2.6 Measurement Results Explanation Example..... 12

**3 TEST RESULT ..... 13**

3.1 Number of Channel Measurement ..... 13

3.2 Hopping Channel Separation Measurement ..... 15

3.3 Dwell Time Measurement..... 22

3.4 20dB and 99% Bandwidth Measurement ..... 25

3.5 Peak Output Power Measurement ..... 38

3.6 Conducted Band Edges Measurement..... 40

3.7 Conducted Spurious Emission Measurement ..... 50

3.8 Radiated Band Edges and Spurious Emission Measurement ..... 60

3.9 AC Conducted Emission Measurement..... 71

3.10 Antenna Requirements..... 76

**4 LIST OF MEASURING EQUIPMENT..... 77**

**5 UNCERTAINTY OF EVALUATION..... 78**



### REVISION HISTORY

REPORT NO.	VERSION	DESCRIPTION	ISSUED DATE
FR442943A	Rev. 01	Initial issue of report	Jul. 11, 2014



### SUMMARY OF TEST RESULT

Report Section	FCC Rule	Description	Limit	Result	Remark
3.1	15.247(a)(1)	Number of Channels	≥ 15Chs	Pass	-
3.2	15.247(a)(1)	Hopping Channel Separation	≥ 2/3 of 20dB BW	Pass	-
3.3	15.247(a)(1)	Dwell Time of Each Channel	≤ 0.4sec in 31.6sec period	Pass	-
3.4	15.247(a)(1)	20dB Bandwidth	NA	Pass	-
	-	99% Bandwidth	-	Pass	-
3.5	15.247(b)(1)	Peak Output Power	≤ 125 mW	Pass	-
3.6	15.247(d)	Conducted Band Edges	≤ 20dBc	Pass	-
3.7	15.247(d)	Conducted Spurious Emission	≤ 20dBc	Pass	-
3.8	15.247(d)	Radiated Band Edges and Radiated Spurious Emission	15.209(a) & 15.247(d)	Pass	Under limit 6.93 dB at 30.000 MHz
3.9	15.207	AC Conducted Emission	15.207(a)	Pass	Under limit 17.00 dB at 3.150 MHz
3.10	15.203 & 15.247(b)	Antenna Requirement	N/A	Pass	-



# 1 General Description

## 1.1 Applicant

**Motorola Mobility, LLC**

222 W Merchandise Mart Plaza, Suite 1800, Chicago, IL 60654, United States

## 1.2 Manufacturer

**Motorola Mobility, LLC**

222 W Merchandise Mart Plaza, Suite 1800, Chicago, IL 60654, United States

## 1.3 Product Feature of Equipment Under Test

Product Feature	
<b>Equipment</b>	Mobile Cellular Phone
<b>Brand Name</b>	Motorola Mobility, LLC
<b>FCC Model Name</b>	3578
<b>FCC ID</b>	IHDT56QA1
<b>IMEI Code</b>	359279050020145
<b>EUT supports Radios application</b>	GSM/EGPRS/WCDMA/HSPA/LTE/NFC WLAN 11b/g/n HT20 WLAN 11a/n HT20/HT40 WLAN 11ac VHT20/VHT40/VHT80 Bluetooth v3.0 + EDR Bluetooth v4.0 - LE
<b>HW Version</b>	P2
<b>SW Version</b>	KXE21.99.169
<b>EUT Stage</b>	Identical Prototype

**Remark:** The above EUT's information was declared by manufacturer. Please refer to the specifications or user's manual for more detailed description.

Accessory List	
<b>AC Adapter</b>	Brand Name : Motorola
	Model Name : SPN5788A
<b>Earphone</b>	Brand Name : Motorola
	Model Name : SJYN1305A



### 1.4 Product Specification subjective to this standard

Product Specification subjective to this standard	
<b>Tx/Rx Frequency Range</b>	2402 MHz ~ 2480 MHz
<b>Number of Channels</b>	79
<b>Carrier Frequency of Each Channel</b>	2402+n*1 MHz; n=0~78
<b>Maximum Output Power to Antenna</b>	Bluetooth BR(1Mbps) : 11.89 dBm (0.0154 W) Bluetooth EDR (2Mbps) : 11.90 dBm (0.0155 W) Bluetooth EDR (3Mbps) : 12.21 dBm (0.0166 W)
<b>99% Occupied Bandwidth</b>	Bluetooth BR(1Mbps) : 0.868MHz Bluetooth EDR (2Mbps) : 1.168MHz Bluetooth EDR (3Mbps) : 1.156MHz
<b>Antenna Type</b>	Fixed Internal Antenna Type with gain 0.00 dBi
<b>Type of Modulation</b>	Bluetooth BR (1Mbps) : GFSK Bluetooth EDR (2Mbps) : $\pi/4$ -DQPSK Bluetooth EDR (3Mbps) : 8-DPSK

### 1.5 Modification of EUT

No modifications are made to the EUT during all test items.

### 1.6 Testing Location

Sporton Lab is accredited to ISO 17025 by Taiwan Accreditation Foundation (TAF code : 1190) and the FCC designation No. TW1022 under the FCC 2.948(e) by Mutual Recognition Agreement (MRA) in FCC Test.

<b>Test Site</b>	SPORTON INTERNATIONAL INC.		
<b>Test Site Location</b>	No. 52, Hwa Ya 1 <sup>st</sup> Rd., Hwa Ya Technology Park, Kwei-Shan Hsiang, Tao Yuan Hsien, Taiwan, R.O.C. TEL: +886-3-327-3456 FAX: +886-3-328-4978		
<b>Test Site No.</b>	<b>Sporton Site No.</b>		
	TH02-HY	CO05-HY	03CH06-HY



## **1.7 Applicable Standards**

According to the specifications of the manufacturer, the EUT must comply with the requirements of the following standards:

- ♦ FCC Part 15 Subpart C §15.247
- ♦ FCC Public Notice DA 00-705
- ♦ ANSI C63.4-2003

**Remark:**

1. All test items were verified and recorded according to the standards and without any deviation during the test.
2. This EUT has also been tested and complied with the requirements of FCC Part 15, Subpart B, recorded in a separate test report.

## 2 Test Configuration of Equipment Under Test

### 2.1 Descriptions of Test Mode

Preliminary tests were performed in different data rates and recorded the RF output power in the following table:

Channel	Frequency	Bluetooth RF Output Power		
		Data Rate / Modulation		
		GFSK	$\pi/4$ -DQPSK	8-DPSK
		1Mbps	2Mbps	3Mbps
Ch00	2402MHz	10.45 dBm	10.46 dBm	10.77 dBm
Ch39	2441MHz	11.89 dBm	11.90 dBm	12.21 dBm
Ch78	2480MHz	10.26 dBm	10.20 dBm	10.54 dBm

Channel	Frequency	Bluetooth Average Power		
		Data Rate / Modulation		
		GFSK	$\pi/4$ -DQPSK	8-DPSK
		1Mbps	2Mbps	3Mbps
Ch00	2402MHz	10.29 dBm	8.35 dBm	8.36 dBm
Ch39	2441MHz	11.80 dBm	10.02 dBm	10.06 dBm
Ch78	2480MHz	10.16 dBm	8.31 dBm	8.32 dBm

**Remark:**

1. All the test data for each data rate were verified, but only the worst case was reported.
  2. The data rate was set in 3Mbps for all the test items due to the highest RF output power.
- a. The EUT has been associated with peripherals and configuration operated in a manner tended to maximize its emission characteristics in a typical application. Frequency range investigated: conduction (150 kHz to 30 MHz), radiation (9 kHz to the 10th harmonic of the highest fundamental frequency or to 40 GHz, whichever is lower). Pre-scanned tests, X, Y, Z in three orthogonal panels, and different data rates were conducted to determine the final configuration (Z plane as worst plane) from all possible combinations, and the worst mode of radiated spurious emissions is Bluetooth 3Mbps mode, and recorded in this report.
- b. AC power line Conducted Emission was tested under maximum output power.





## 2.2 Test Mode

The following summary table is showing all test modes to demonstrate in compliance with the standard.

Summary table of Test Cases			
Test Item	Data Rate / Modulation		
	Bluetooth BR 1Mbps GFSK	Bluetooth EDR 2Mbps $\pi/4$ -DQPSK	Bluetooth EDR 3Mbps 8-DPSK
Conducted Test Cases	Mode 1: CH00_2402 MHz Mode 2: CH39_2441 MHz Mode 3: CH78_2480 MHz	Mode 4: CH00_2402 MHz Mode 5: CH39_2441 MHz Mode 6: CH78_2480 MHz	Mode 7: CH00_2402 MHz Mode 8: CH39_2441 MHz Mode 9: CH78_2480 MHz
Radiated Test Cases	Bluetooth EDR 3Mbps 8-DPSK		
	Mode 1: CH00_2402 MHz Mode 2: CH39_2441 MHz Mode 3: CH78_2480 MHz		
AC Conducted Emission	Mode 1 :GSM850 Idle + Bluetooth Link + WLAN (2.4GHz) Link + USB Cable (Charging from Adapter) + Battery + Earphone + MP3		
<b>Remark:</b> For radiated test cases, the worst mode data rate 3Mbps was reported only, because this data rate has the highest RF output power at preliminary tests, and the conducted spurious emissions and conducted band edge measurement for each data rate are no worse than 3Mbps, and no other significantly frequencies found in conducted spurious emission.			

## 2.3 Connection Diagram of Test System

### <Bluetooth Tx Mode>

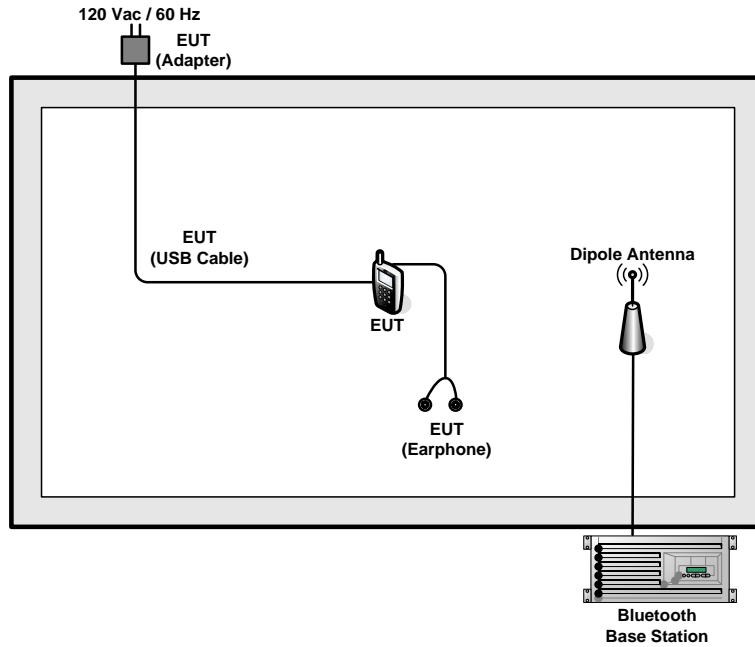

### <AC Conducted Emission Mode>

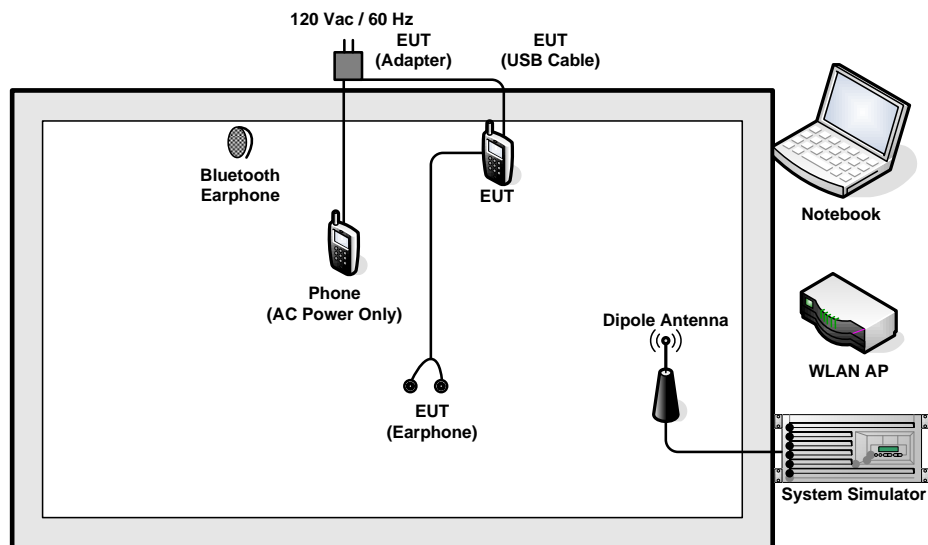



## 2.4 Support Unit used in test configuration and system

Item	Equipment	Trade Name	Model Name	FCC ID	Data Cable	Power Cord
1.	Bluetooth Base Station	R&S	CBT32	N/A	N/A	Unshielded, 1.8 m
2.	System Simulator	R&S	CMU 200	N/A	N/A	Unshielded, 1.8 m
3.	Bluetooth Earphone	Sony Ericsson	MW600	PY7DDA-2029	N/A	N/A
4.	WLAN AP	D-Link	DIR-628	KA2DIR628A2	N/A	Unshielded, 1.8 m
5.	Notebook	DELL	Latitude E6320	FCC DoC/ Contains FCC ID: QDS-BRCM1054	N/A	AC I/P: Unshielded, 1.2 m DC O/P: Shielded, 1.8 m

## 2.5 EUT Operation Test Setup

For Bluetooth test items, an engineering test program was provided and enabled to make EUT contact with Bluetooth base station for continuous transmitting and receiving signals.



## 2.6 Measurement Results Explanation Example

For all conducted test items:

The offset level is set in the spectrum analyzer to compensate the RF cable loss and attenuator factor between EUT conducted output port and spectrum analyzer. With the offset compensation, the spectrum analyzer reading level is exactly the EUT RF output level.

Example:

The spectrum analyzer offset is derived from RF cable loss and attenuator factor.

*Offset = RF cable loss + attenuator factor.*

Following shows an offset computation example with cable loss 4.2 dB and 10dB attenuator.

$$\begin{aligned} \text{Offset(dB)} &= \text{RF cable loss(dB)} + \text{attenuator factor(dB)}. \\ &= 4.2 + 10 = 14.2 \text{ (dB)} \end{aligned}$$

### 3 Test Result

#### 3.1 Number of Channel Measurement

##### 3.1.1 Limits of Number of Hopping Frequency

Frequency hopping systems in the 2400-2483.5 MHz band shall use at least 15 channels.

##### 3.1.2 Measuring Instruments

The measuring equipment is listed in the section 4 of this test report.

##### 3.1.3 Test Procedure

1. The testing follows FCC Public Notice DA 00-705 Measurement Guidelines.
2. The RF output of EUT was connected to the spectrum analyzer by RF cable and attenuator. The path loss was compensated to the results for each measurement.
3. Set to the maximum power setting and enable the EUT transmit continuously.
4. Enable the EUT hopping function.
5. Use the following spectrum analyzer settings: Span = the frequency band of operation; RBW  $\geq$  1% of the span; VBW  $\geq$  RBW; Sweep = auto; Detector function = peak; Trace = max hold.
6. The number of hopping frequency used is defined as the number of total channel.
7. Record the measurement data derived from spectrum analyzer.

##### 3.1.4 Test Setup

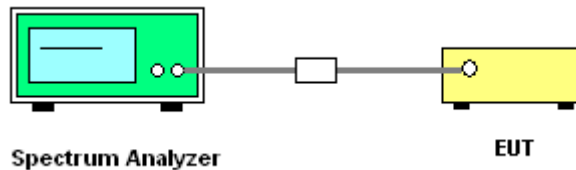

##### 3.1.5 Test Result of Number of Hopping Frequency

Test Mode :	3Mbps	Temperature :	24~26°C
Test Engineer :	Bill Kuo	Relative Humidity :	50~53%
Number of Hopping (Channel)	Adaptive Frequency Hopping (Channel)	Limits (Channel)	Pass/Fail
79	20	> 15	Pass

#### Number of Hopping Channel Plot on Channel 00 - 78

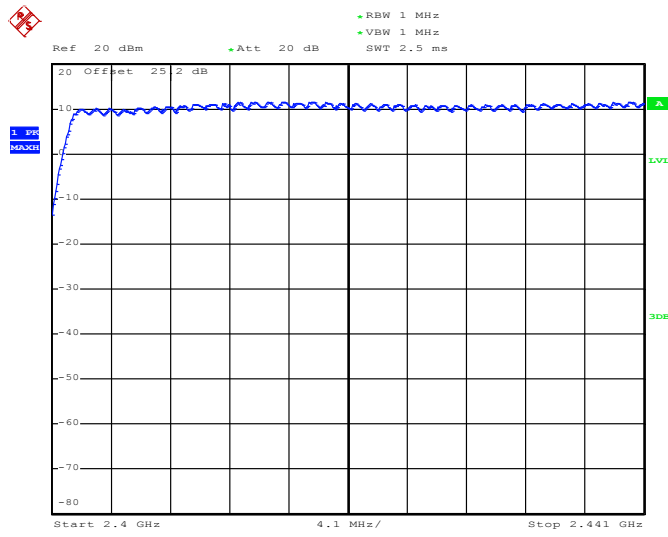

Date: 10.MAY.2014 13:36:16

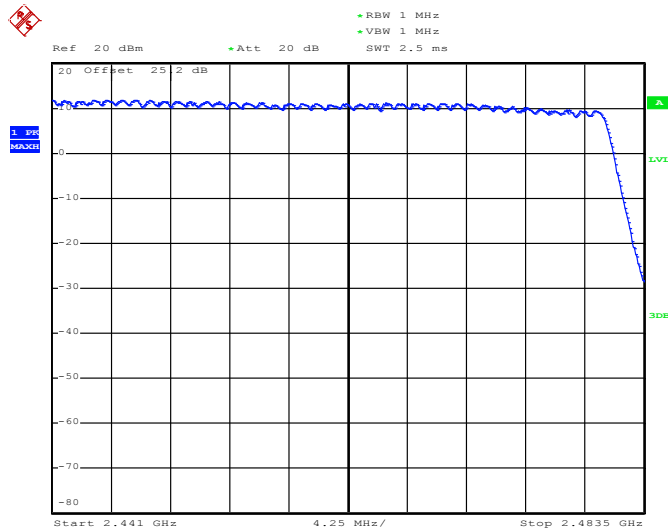

Date: 10.MAY.2014 13:37:40

## 3.2 Hopping Channel Separation Measurement

### 3.2.1 Limit of Hopping Channel Separation

Frequency hopping systems operating in the 2400-2483.5 MHz band may have hopping channel carrier frequencies that are separated by 25 kHz or two-thirds of the 20 dB bandwidth of the hopping channel, whichever is greater.

### 3.2.2 Measuring Instruments

The measuring equipment is listed in the section 4 of this test report.

### 3.2.3 Test Procedures

1. The testing follows FCC Public Notice DA 00-705 Measurement Guidelines.
2. The RF output of EUT was connected to the spectrum analyzer by RF cable and attenuator. The path loss was compensated to the results for each measurement.
3. Set to the maximum power setting and enable the EUT transmit continuously.
4. Enable the EUT hopping function.
5. Use the following spectrum analyzer settings:  
Span = wide enough to capture the peaks of two adjacent channels; RBW  $\geq$  1% of the span;  
VBW  $\geq$  RBW; Sweep = auto; Detector function = peak; Trace = max hold.
6. Measure and record the results in the test report.

### 3.2.4 Test Setup

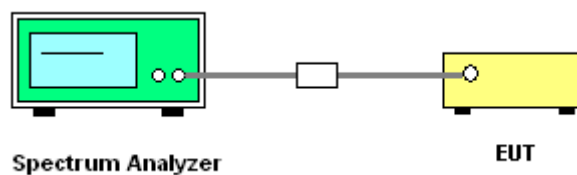



### 3.2.5 Test Result of Hopping Channel Separation

Test Mode :	1Mbps	Temperature :	24~26°C
Test Engineer :	Bill Kuo	Relative Humidity :	50~53%

Channel	Frequency (MHz)	Frequency Separation (MHz)	(2/3 of 20dB BW) Limits (MHz)	Pass/Fail
00	2402	1.002	0.5867	Pass
39	2441	1.002	0.5893	Pass
78	2480	1.002	0.5893	Pass

Channel Separation Plot on Channel 00 - 01

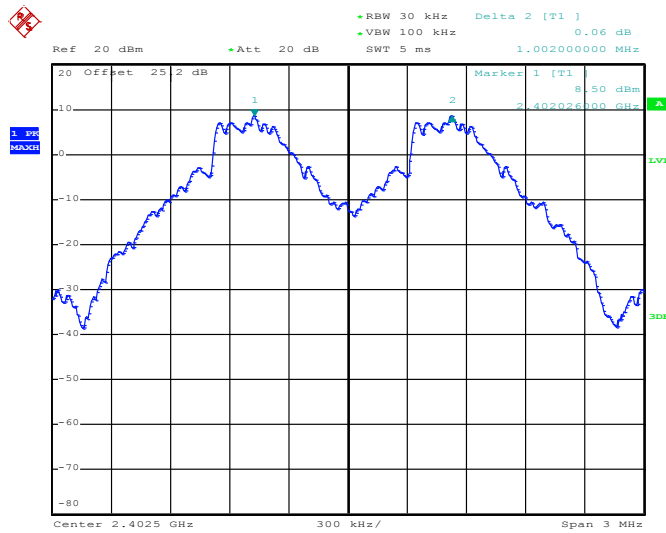

Date: 10.MAY.2014 12:26:16





### Channel Separation Plot on Channel 39 - 40

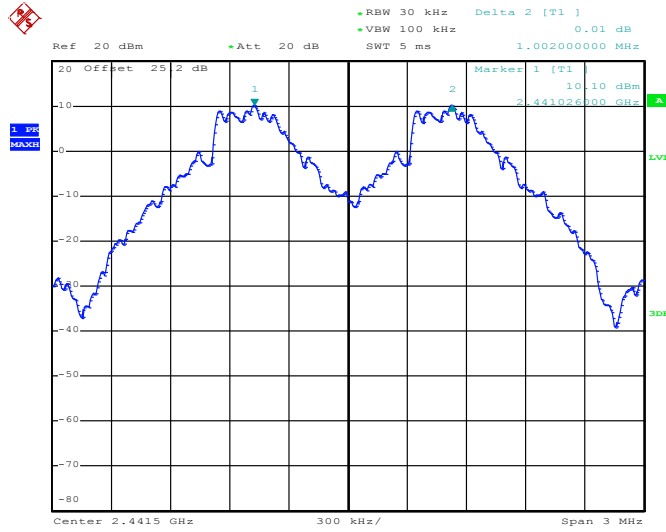

Date: 10.MAY.2014 12:27:28

### Channel Separation Plot on Channel 77 - 78

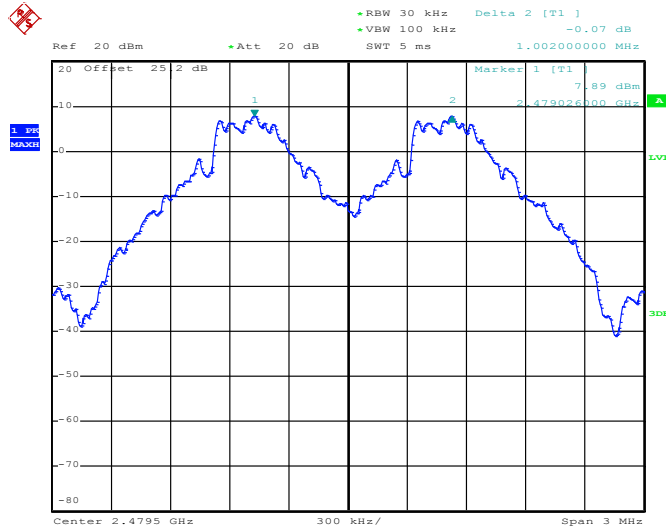

Date: 10.MAY.2014 12:28:25



Test Mode :	2Mbps	Temperature :	24~26°C
Test Engineer :	Bill Kuo	Relative Humidity :	50~53%

Channel	Frequency (MHz)	Frequency Separation (MHz)	(2/3 of 20dB BW) Limits (MHz)	Pass/Fail
00	2402	1.008	0.8400	Pass
39	2441	1.002	0.8400	Pass
78	2480	1.002	0.8400	Pass

Channel Separation Plot on Channel 00 - 01

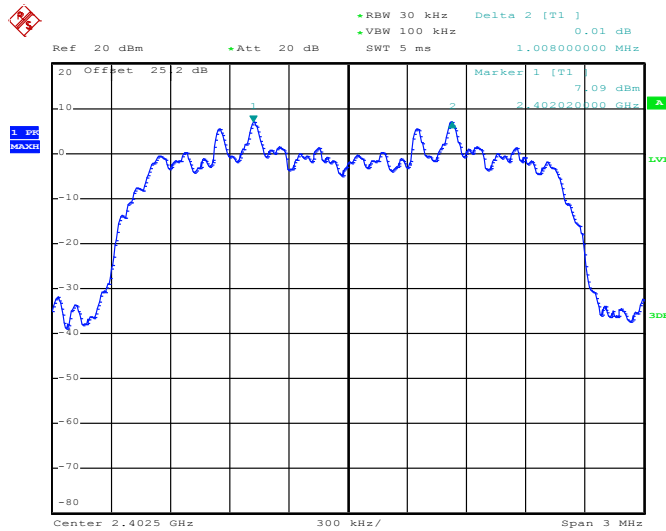

Date: 10.MAY.2014 13:09:21



Channel Separation Plot on Channel 39 - 40

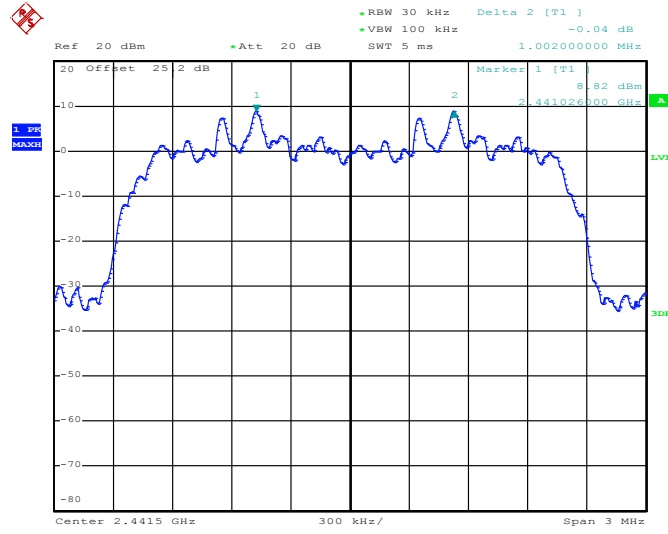

Date: 10.MAY.2014 13:16:03

Channel Separation Plot on Channel 77 - 78

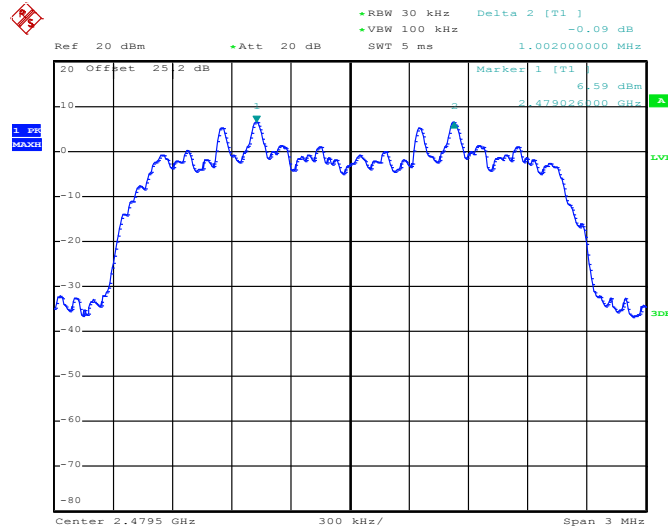

Date: 10.MAY.2014 13:17:06



Test Mode :	3Mbps	Temperature :	24~26°C
Test Engineer :	Bill Kuo	Relative Humidity :	50~53%

Channel	Frequency (MHz)	Frequency Separation (MHz)	(2/3 of 20dB BW) Limits (MHz)	Pass/Fail
00	2402	1.002	0.8200	Pass
39	2441	1.002	0.8200	Pass
78	2480	1.002	0.8200	Pass

Channel Separation Plot on Channel 00 - 01

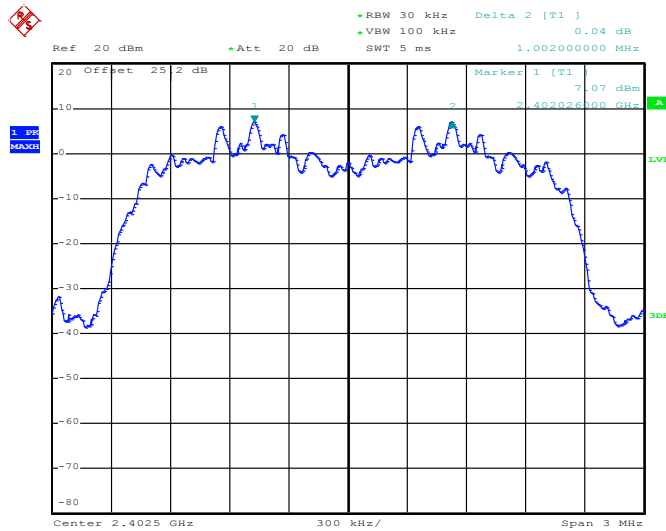

Date: 10.MAY.2014 13:34:47



Channel Separation Plot on Channel 39 - 40

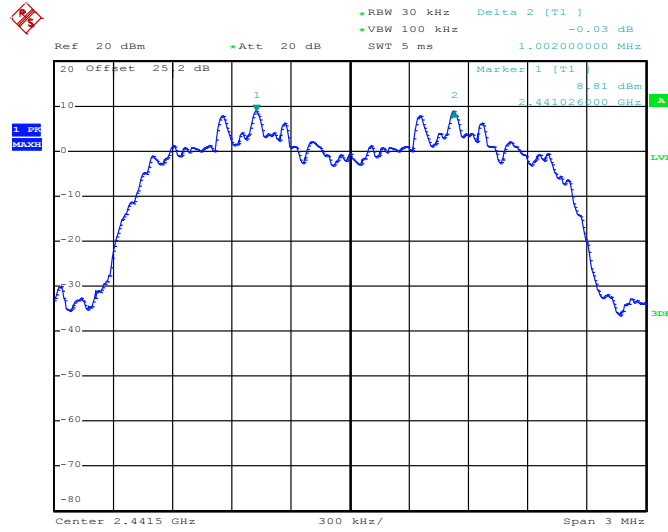

Date: 10.MAY.2014 13:30:49

Channel Separation Plot on Channel 77 - 78

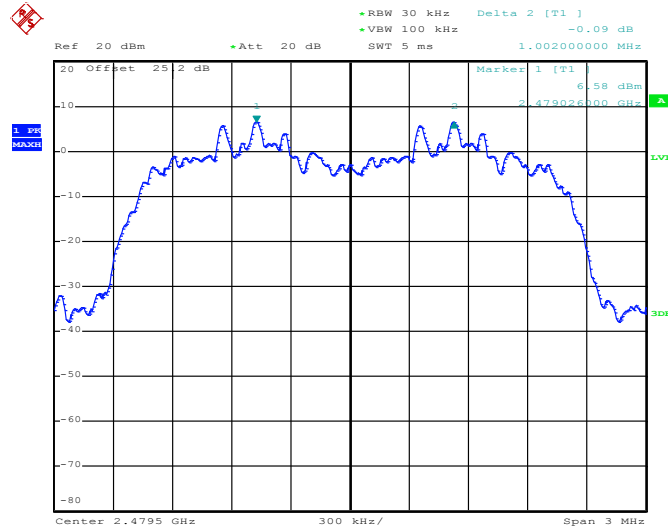

Date: 10.MAY.2014 13:26:54

### 3.3 Dwell Time Measurement

#### 3.3.1 Limit of Dwell Time

The average time of occupancy on any channel shall not be greater than 0.4 seconds within a period of 0.4 seconds multiplied by the number of hopping channels employed.

#### 3.3.2 Measuring Instruments

The measuring equipment is listed in the section 4 of this test report.

#### 3.3.3 Test Procedures

1. The testing follows FCC Public Notice DA 00-705 Measurement Guidelines.
2. The RF output of EUT was connected to the spectrum analyzer by RF cable and attenuator. The path loss was compensated to the results for each measurement.
3. Set to the maximum power setting and enable the EUT transmit continuously.
4. Enable the EUT hopping function.
5. Use the following spectrum analyzer settings: Span = zero span, centered on a hopping channel; RBW = 1 MHz; VBW  $\geq$  RBW; Sweep = as necessary to capture the entire dwell time per hopping channel; Detector function = peak; Trace = max hold.
6. Measure and record the results in the test report.

#### 3.3.4 Test Setup





3.3.5 Test Result of Dwell Time

Test Mode :	DH5	Temperature :	24~26°C
Test Engineer :	Bill Kuo	Relative Humidity :	50~53%

Mode	Hopping Channel Number	Hops Over Occupancy Time(hops)	Package Transfer Time (msec)	Dwell Time (sec)	Limits (sec)	Pass/Fail
Normal	79	106.67	2.90	0.31	0.4	Pass
AFH	20	53.34	2.90	0.15	0.4	Pass

Remark:

- In normal mode, hopping rate is 1600 hops/s with 6 slots in 79 hopping channels.  
With channel hopping rate (1600 / 6 / 79) in Occupancy Time Limit (0.4 x 79) (s),  
Hops Over Occupancy Time comes to (1600 / 6 / 79) x (0.4 x 79) = 106.67 hops.
- In AFH mode, hopping rate is 800 hops/s with 6 slots in 20 hopping channels.  
With channel hopping rate (800 / 6 / 20) in Occupancy Time Limit (0.4 x 20) (s),  
Hops Over Occupancy Time comes to (800 / 6 / 20) x (0.4 x 20) = 53.33 hops.
- Dwell Time(s) = Hops Over Occupancy Time (hops) x Package Transfer Time



Package Transfer Time Plot

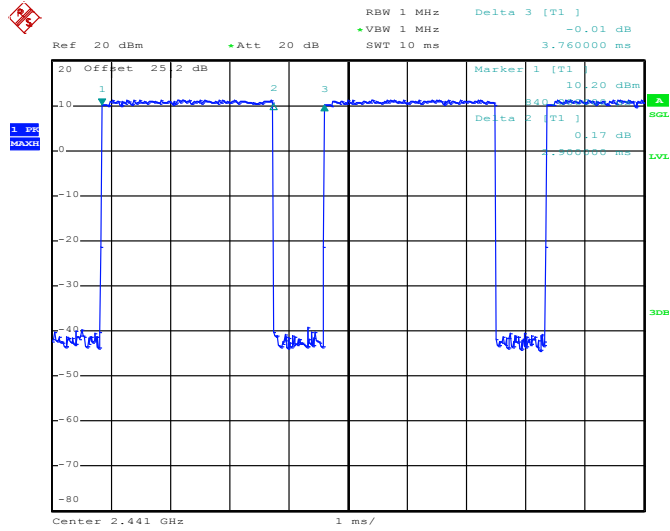

Date: 2.MAY.2014 21:17:19



### **3.4 20dB and 99% Bandwidth Measurement**

#### **3.4.1 Limit of 20dB and 99% Bandwidth**

Reporting only

#### **3.4.2 Measuring Instruments**

The measuring equipment is listed in the section 4 of this test report.

#### **3.4.3 Test Procedures**

1. The testing follows FCC Public Notice DA 00-705 Measurement Guidelines.
2. The RF output of EUT was connected to the spectrum analyzer by RF cable and attenuator. The path loss was compensated to the results for each measurement.
3. Set to the maximum power setting and enable the EUT transmit continuously.
4. Use the following spectrum analyzer settings for 20dB Bandwidth measurement.  
Span = approximately 2 to 3 times the 20 dB bandwidth, centered on a hopping channel;  
RBW  $\geq$  1% of the 20 dB bandwidth; VBW  $\geq$  RBW; Sweep = auto; Detector function = peak;  
Trace = max hold.
5. Use the following spectrum analyzer settings for 99 % Bandwidth measurement.  
For 99% Bandwidth measurement, the RBW=30kHz, and VBW = 100kHz. Sweep = auto ;  
Detector function = sample. Trace = max hold.
6. Measure and record the results in the test report.

#### **3.4.4 Test Setup**





3.4.5 Test Result of 20dB Bandwidth

Test Mode :	1Mbps	Temperature :	24~26°C
Test Engineer :	Bill Kuo	Relative Humidity :	50~53%

Channel	Frequency (MHz)	20dB Bandwidth (MHz)
00	2402	0.880
39	2441	0.884
78	2480	0.884

20 dB Bandwidth Plot on Channel 00

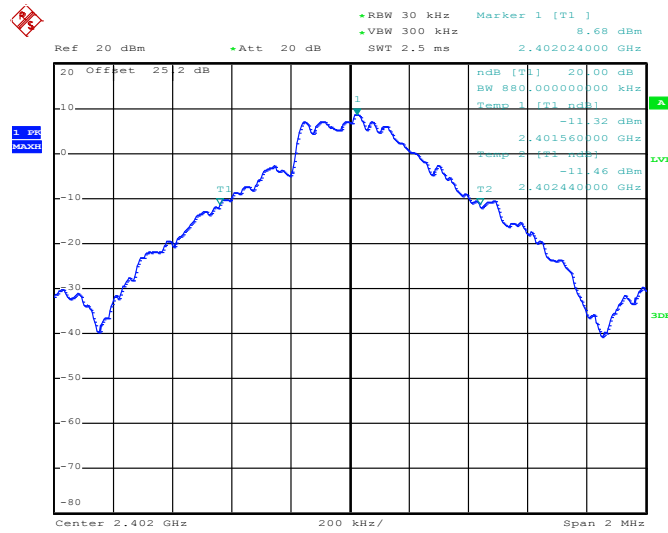

Date: 10.MAY.2014 12:35:14



20 dB Bandwidth Plot on Channel 39

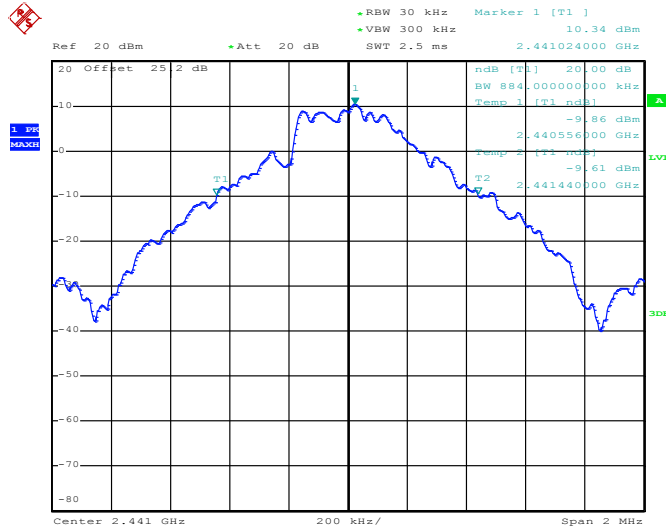

Date: 10.MAY.2014 12:31:40

20 dB Bandwidth Plot on Channel 78

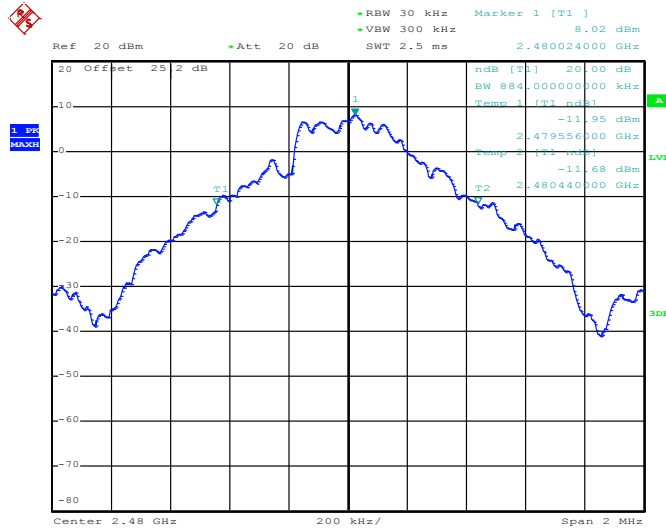

Date: 10.MAY.2014 12:29:00



Test Mode :	2Mbps	Temperature :	24~26°C
Test Engineer :	Bill Kuo	Relative Humidity :	50~53%

Channel	Frequency (MHz)	20dB Bandwidth (MHz)
00	2402	1.260
39	2441	1.260
78	2480	1.260

20 dB Bandwidth Plot on Channel 00

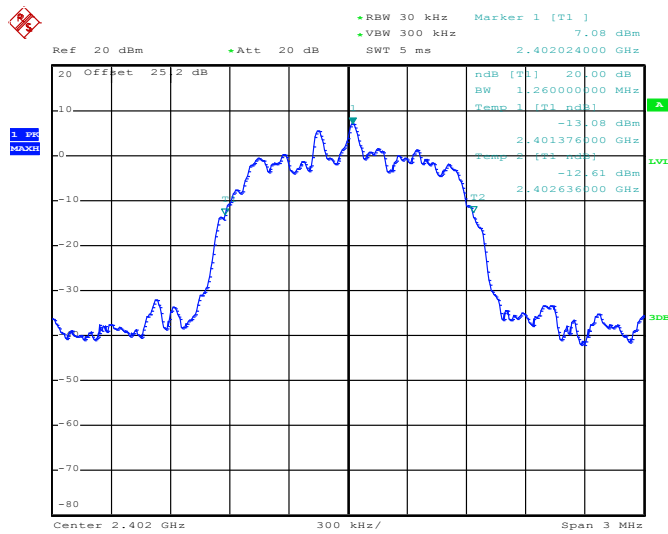

Date: 10.MAY.2014 13:09:48



20 dB Bandwidth Plot on Channel 39

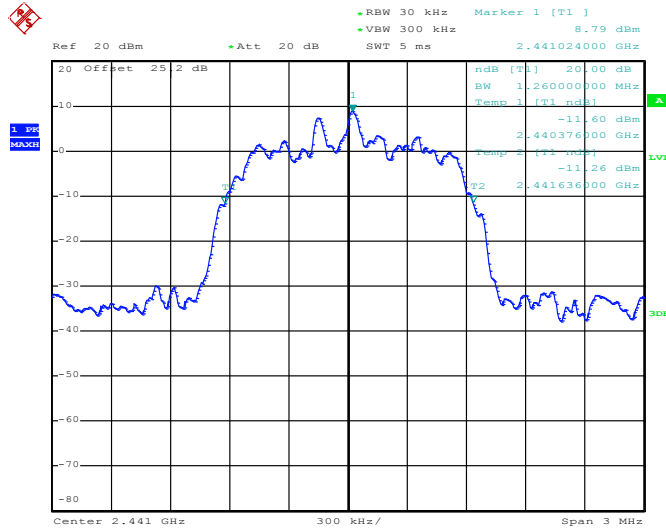

Date: 10.MAY.2014 13:13:47

20 dB Bandwidth Plot on Channel 78

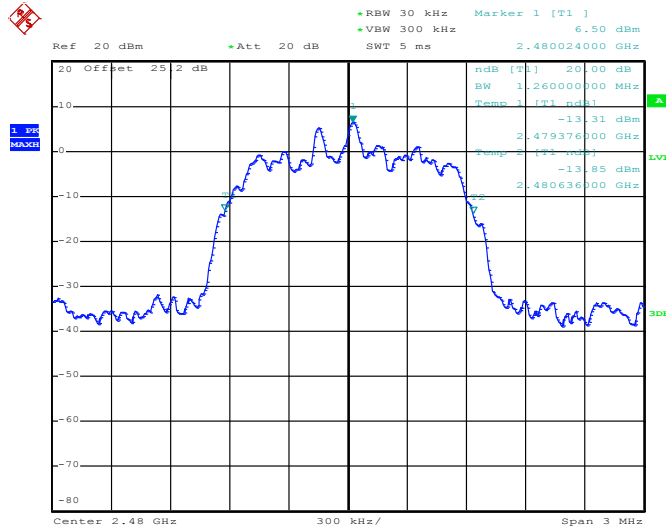

Date: 10.MAY.2014 13:17:33



Test Mode :	3Mbps	Temperature :	24~26°C
Test Engineer :	Bill Kuo	Relative Humidity :	50~53%

Channel	Frequency (MHz)	20dB Bandwidth (MHz)
00	2402	1.230
39	2441	1.230
78	2480	1.230

20 dB Bandwidth Plot on Channel 00

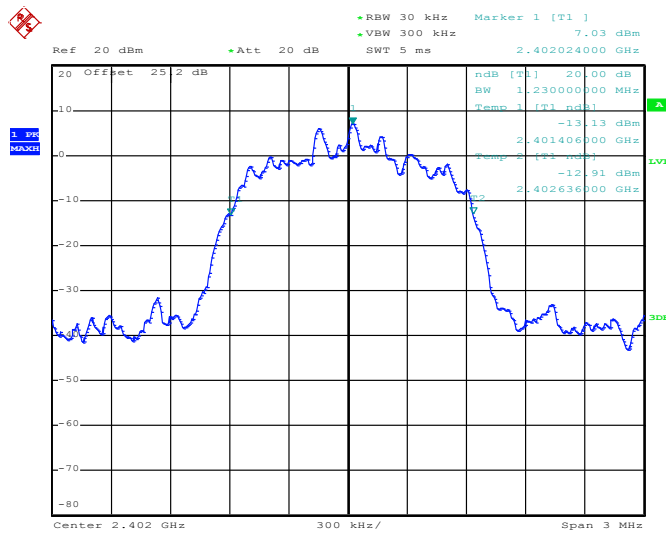

Date: 10.MAY.2014 13:31:22



20 dB Bandwidth Plot on Channel 39

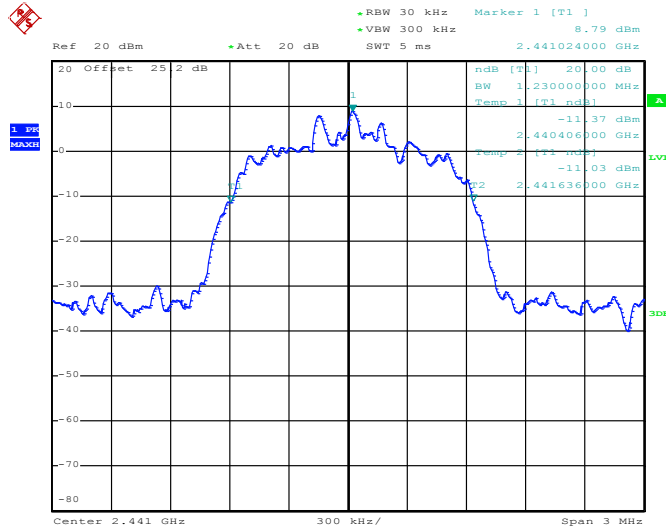

Date: 10.MAY.2014 13:27:32

20 dB Bandwidth Plot on Channel 78

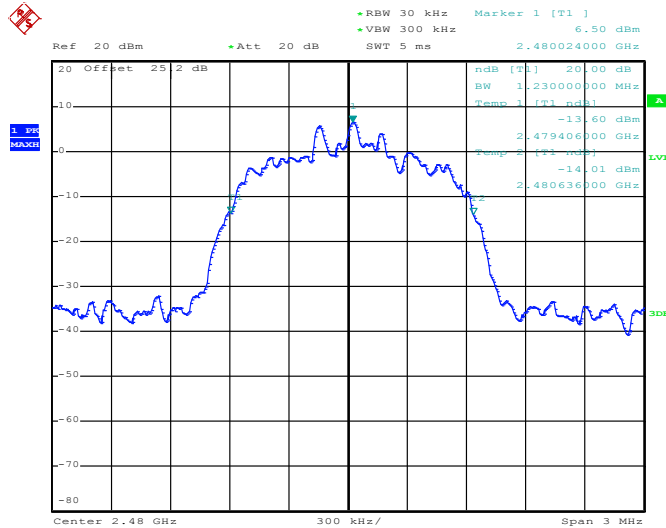

Date: 10.MAY.2014 13:23:26



3.4.6 Test Result of 99% Occupied Bandwidth

Test Mode :	1Mbps	Temperature :	24~26°C
Test Engineer :	Bill Kuo	Relative Humidity :	50~53%

Channel	Frequency (MHz)	99% Occupied Bandwidth (MHz)
00	2402	0.868
39	2441	0.856
78	2480	0.860

99% Occupied Bandwidth Plot on Channel 00

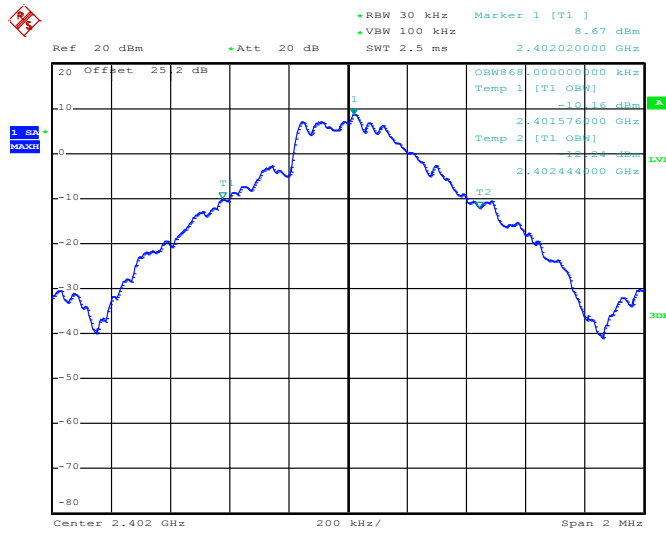

Date: 10.MAY.2014 12:36:06





99% Occupied Bandwidth Plot on Channel 39

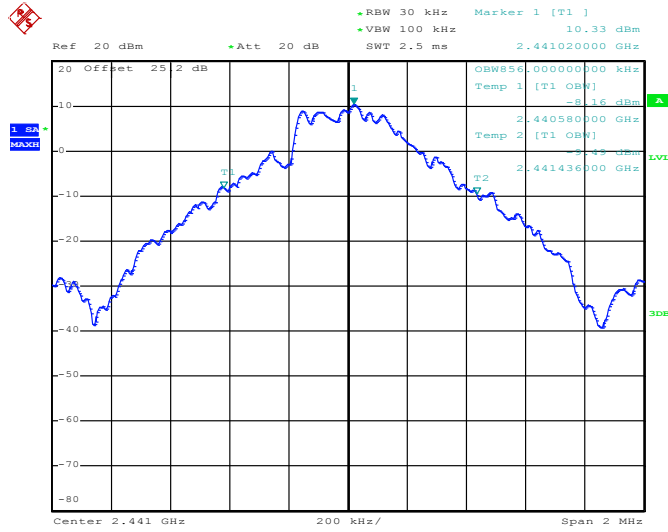

Date: 10.MAY.2014 12:32:14

99% Occupied Bandwidth Plot on Channel 78

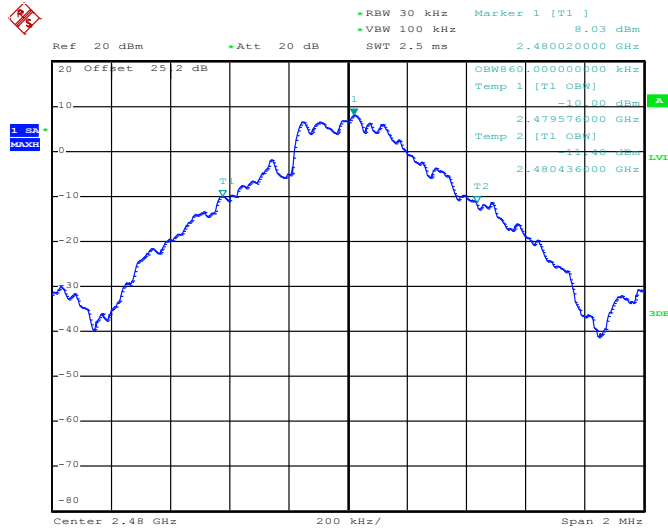

Date: 10.MAY.2014 12:30:06



Test Mode :	2Mbps	Temperature :	24~26°C
Test Engineer :	Bill Kuo	Relative Humidity :	50~53%

Channel	Frequency (MHz)	99% Occupied Bandwidth (MHz)
00	2402	1.168
39	2441	1.168
78	2480	1.168

99% Occupied Bandwidth Plot on Channel 00

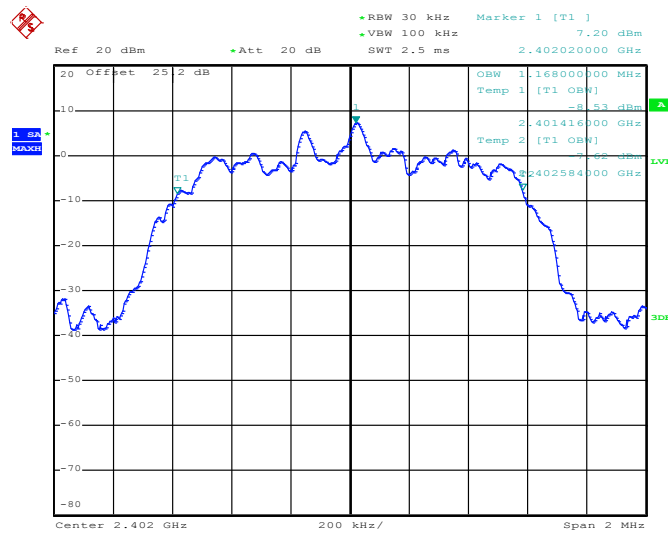

Date: 10.MAY.2014 13:10:43



99% Occupied Bandwidth Plot on Channel 39

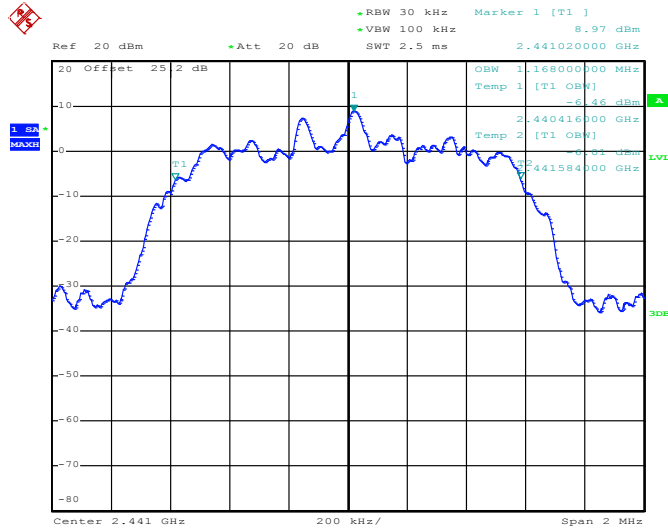

Date: 10.MAY.2014 13:14:25

99% Occupied Bandwidth Plot on Channel 78

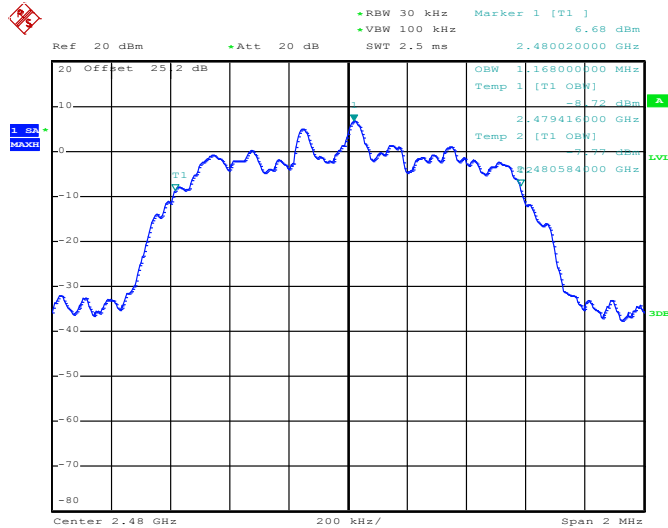

Date: 10.MAY.2014 13:18:29



Test Mode :	3Mbps	Temperature :	24~26°C
Test Engineer :	Bill Kuo	Relative Humidity :	50~53%

Channel	Frequency (MHz)	99% Occupied Bandwidth (MHz)
00	2402	1.156
39	2441	1.152
78	2480	1.152

99% Occupied Bandwidth Plot on Channel 00

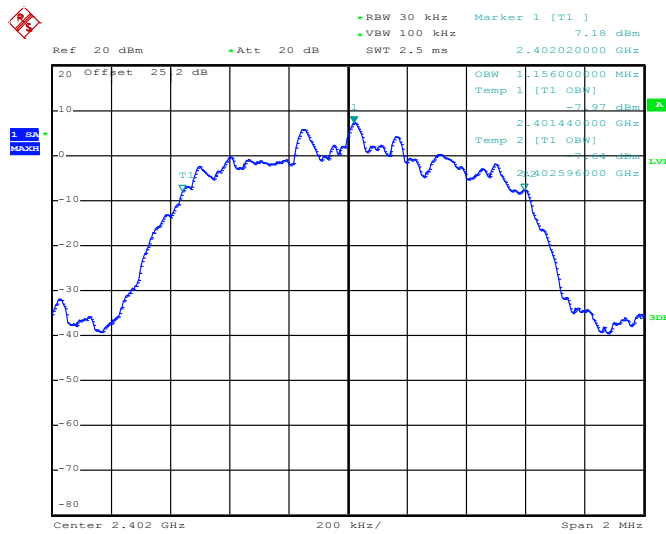

Date: 10.MAY.2014 13:32:15



### 99% Occupied Bandwidth Plot on Channel 39

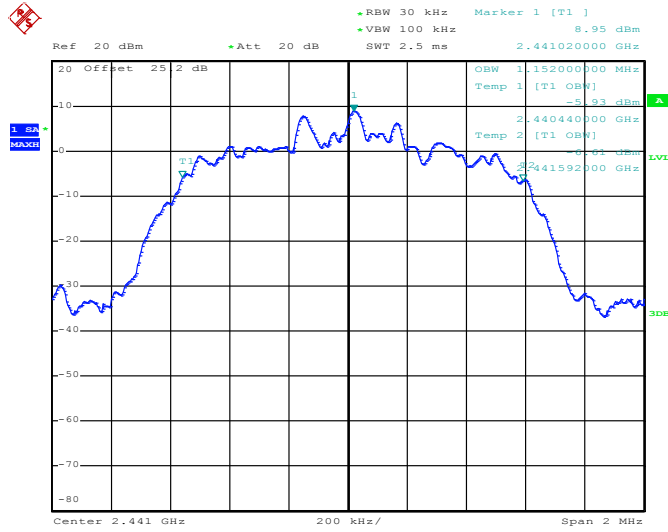

Date: 10.MAY.2014 13:28:09

### 99% Occupied Bandwidth Plot on Channel 78

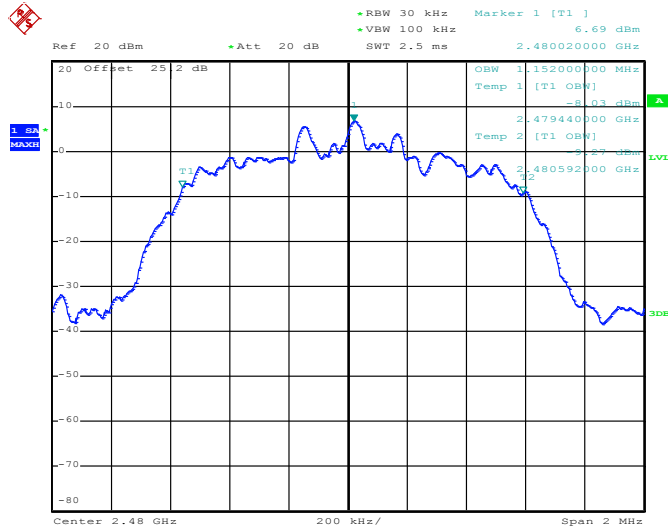

Date: 10.MAY.2014 13:24:18

**Note:** The occupied channel bandwidth is maintained within the band of operation for all of the modulations.

### 3.5 Peak Output Power Measurement

#### 3.5.1 Limit of Peak Output Power

Section 15.247 (b) The maximum peak conducted output power of the intentional radiator shall not exceed the following: (1) For frequency hopping systems operating in the 2400-2483.5 MHz band employing at least 75 non-overlapping hopping channels, and all frequency hopping systems in the 5725-5850 MHz band: 1 watt. For all other frequency hopping systems in the 2400-2483.5 MHz band 0.125 watts. The power limit for 1Mbps is 1watt, and for 2Mbps, 3Mbps and AFH are 0.125 watts.

#### 3.5.2 Measuring Instruments

The measuring equipment is listed in the section 4 of this test report.

#### 3.5.3 Test Procedures

1. The testing follows FCC Public Notice DA 00-705 Measurement Guidelines.
2. The RF output of EUT was connected to the power meter by RF cable and attenuator. The path loss was compensated to the results for each measurement.
3. Set to the maximum power setting and enable the EUT transmit continuously.
4. Measure the conducted output power with cable loss and record the results in the test report.
5. Measure and record the results in the test report.

#### 3.5.4 Test Setup

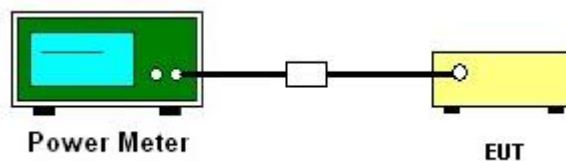



3.5.5 Test Result of Peak Output Power

Test Mode :	1Mbps	Temperature :	24~26°C
Test Engineer :	Bill Kuo	Relative Humidity :	50~53%

Channel	Frequency (MHz)	RF Power (dBm)		
		GFSK	Max. Limits (dBm)	Pass/Fail
		1 Mbps		
00	2402	10.45	20.97	Pass
39	2441	11.89	20.97	Pass
78	2480	10.26	20.97	Pass

Note: For AFH mode using 20 hopping channels, the maximum output power limit is 20.97dBm.

Test Mode :	2Mbps	Temperature :	24~26°C
Test Engineer :	Bill Kuo	Relative Humidity :	50~53%

Channel	Frequency (MHz)	RF Power (dBm)		
		$\pi/4$ -DQPSK	Max. Limits (dBm)	Pass/Fail
		2 Mbps		
00	2402	10.46	20.97	Pass
39	2441	11.90	20.97	Pass
78	2480	10.20	20.97	Pass

Test Mode :	3Mbps	Temperature :	24~26°C
Test Engineer :	Bill Kuo	Relative Humidity :	50~53%

Channel	Frequency (MHz)	RF Power (dBm)		
		8-DPSK	Max. Limits (dBm)	Pass/Fail
		3 Mbps		
00	2402	10.77	20.97	Pass
39	2441	12.21	20.97	Pass
78	2480	10.54	20.97	Pass

## 3.6 Conducted Band Edges Measurement

### 3.6.1 Limit of Band Edges

In any 100 kHz bandwidth outside the intentional radiation frequency band, the radio frequency power shall be at least 20 dB below the highest level of the radiated power. In addition, radiated emissions which fall in the restricted bands must also comply with the radiated emission limits.

### 3.6.2 Measuring Instruments

The measuring equipment is listed in the section 4 of this test report.

### 3.6.3 Test Procedures

1. The testing follows the guidelines in Band-edge Compliance of RF Conducted Emissions of FCC Public Notice DA 00-705 Measurement Guidelines.
2. Set to the maximum power setting and enable the EUT transmit continuously.
3. Set RBW = 100kHz ( $\geq 1\%$  span=10MHz ), VBW = 300kHz ( $\geq$  RBW). Band edge emissions must be at least 20 dB down from the highest emission level within the authorized band as measured with a 100kHz RBW. The attenuation shall be 30 dB instead of 20 dB when RMS conducted output power procedure is used.
4. Enable hopping function of the EUT and then repeat step 2. and 3.
5. Measure and record the results in the test report.

### 3.6.4 Test Setup

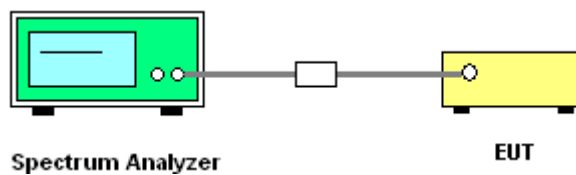





### 3.6.5 Test Result of Conducted Band Edges

Test Mode :	1Mbps	Temperature :	24~26°C
Test Channel :	00 and 78	Relative Humidity :	50~53%
		Test Engineer :	Bill Kuo

Low Band Edge Plot on Channel 00

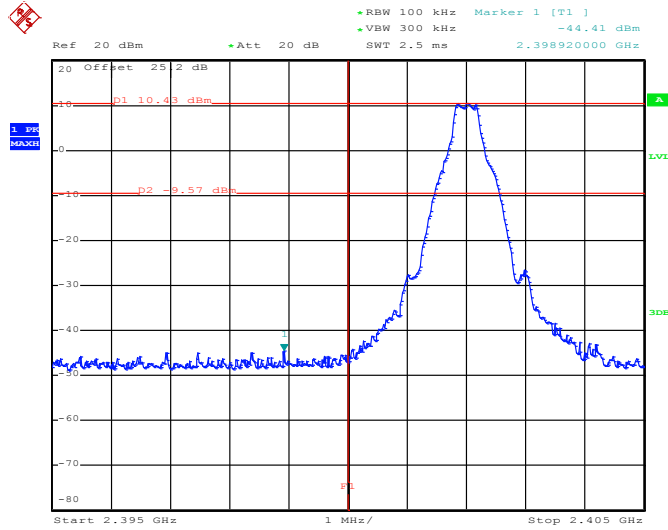

Date: 10.MAY.2014 12:35:32



High Band Edge Plot on Channel 78

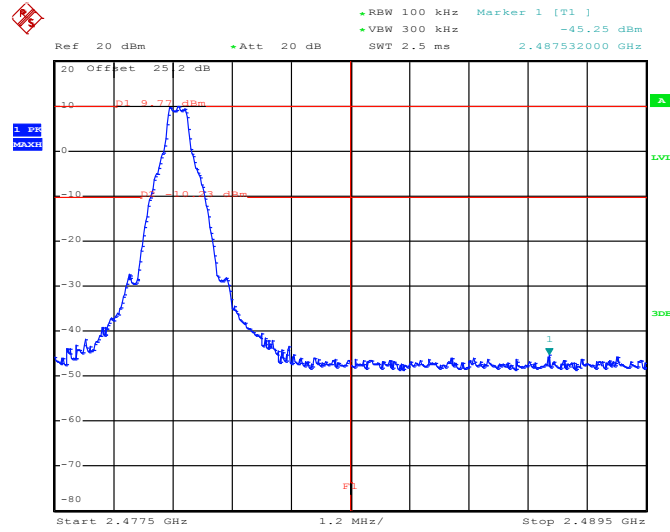

Date: 10.MAY.2014 12:29:30



Test Mode :	2Mbps	Temperature :	24~26°C
Test Channel :	00 and 78	Relative Humidity :	50~53%
		Test Engineer :	Bill Kuo

Low Band Edge Plot on Channel 00

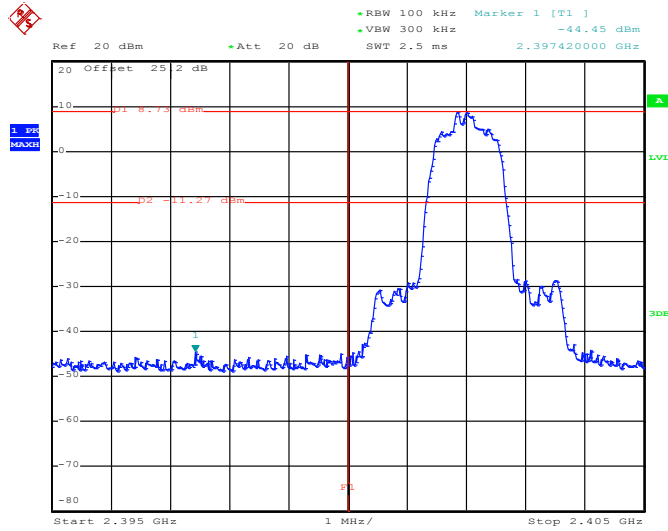

Date: 10.MAY.2014 13:10:08



High Band Edge Plot on Channel 78

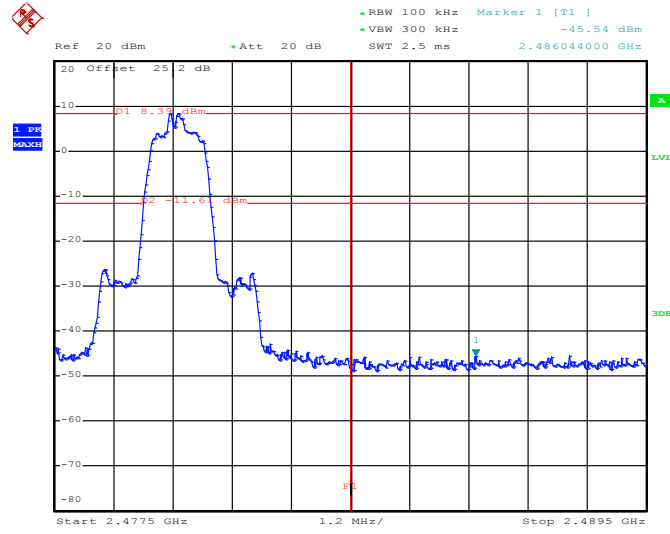

Date: 10.MAY.2014 13:17:53



Test Mode :	3Mbps	Temperature :	24~26°C
Test Channel :	00 and 78	Relative Humidity :	50~53%
		Test Engineer :	Bill Kuo

Low Band Edge Plot on Channel 00

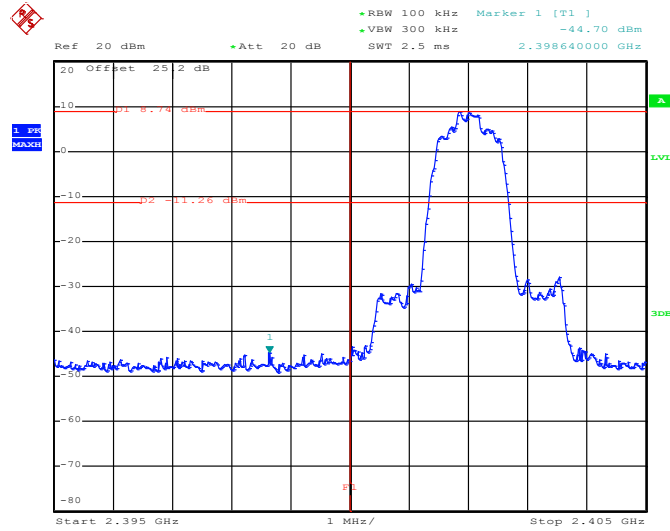

Date: 10.MAY.2014 13:31:42



### High Band Edge Plot on Channel 78

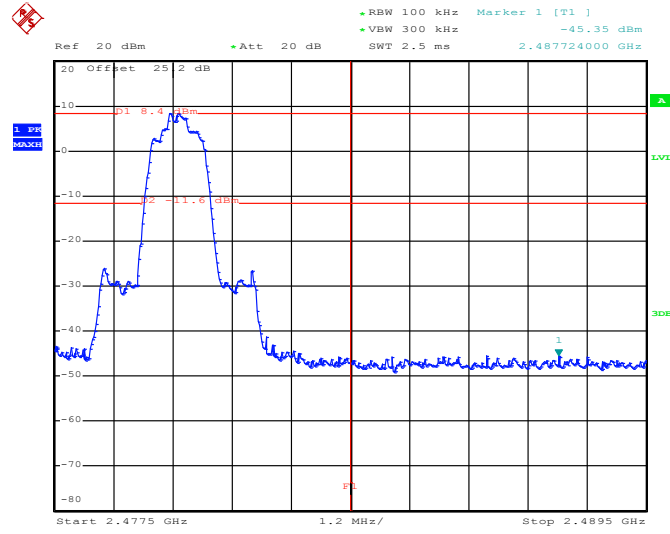

Date: 10.MAY.2014 13:23:45



### 3.6.6 Test Result of Conducted Hopping Mode Band Edges

Test Mode :	1Mbps	Temperature :	24~26°C
Test Engineer :	Bill Kuo	Relative Humidity :	50~53%

#### 1Mbps Hopping Mode Low Band Edge Plot

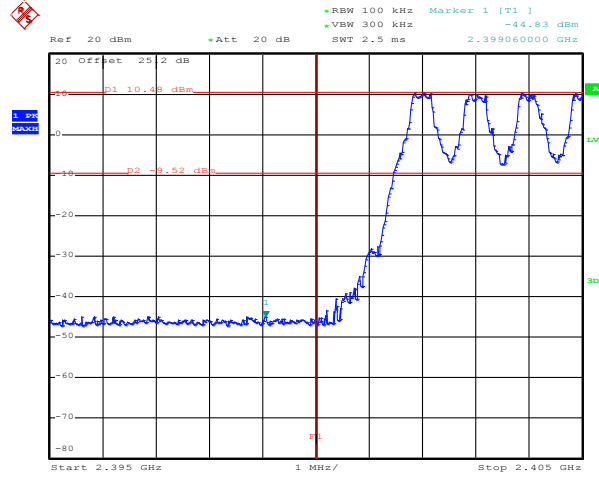

Date: 10.MAY.2014 14:06:26

#### 1Mbps Hopping Mode High Band Edge Plot

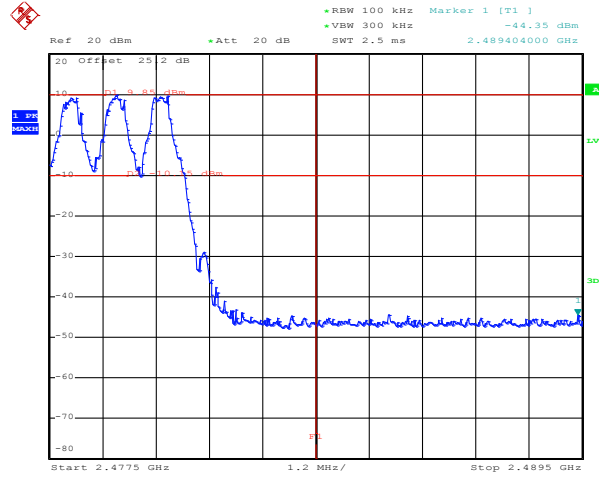

Date: 10.MAY.2014 14:07:48



Test Mode :	2Mbps	Temperature :	24~26°C
Test Engineer :	Bill Kuo	Relative Humidity :	50~53%

2Mbps Hopping Mode Low Band Edge Plot

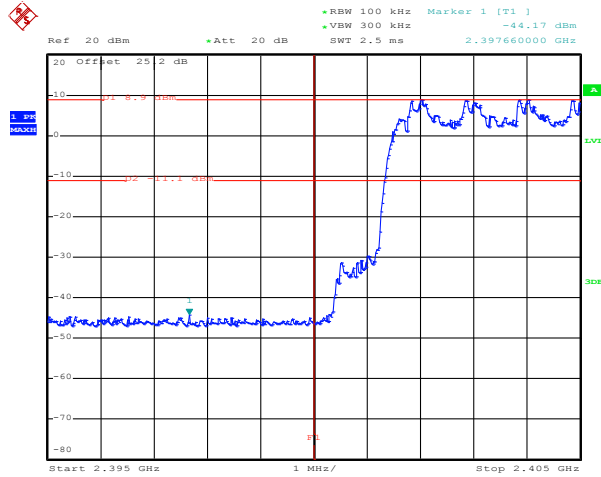

Date: 10.MAY.2014 14:02:51

2Mbps Hopping Mode High Band Edge Plot

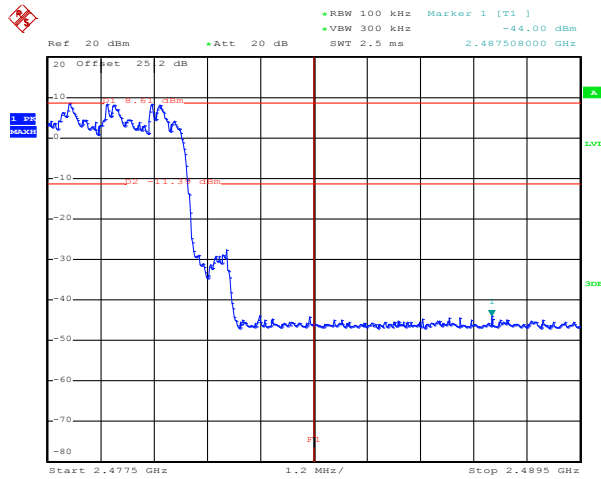

Date: 10.MAY.2014 13:57:41





Test Mode :	3Mbps	Temperature :	24~26°C
Test Engineer :	Bill Kuo	Relative Humidity :	50~53%

3Mbps Hopping Mode Low Band Edge Plot

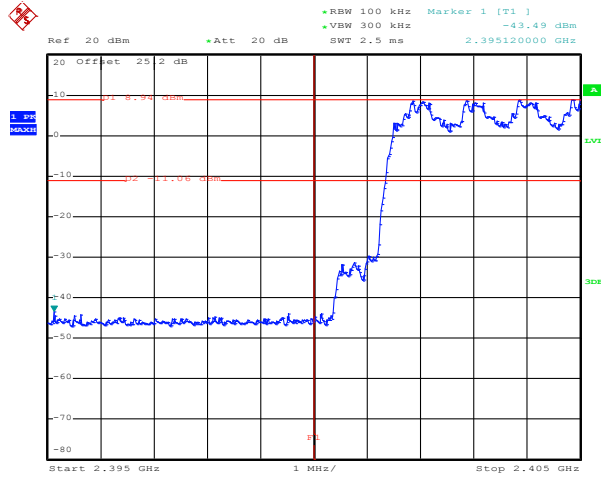

Date: 10.MAY.2014 13:51:54

3Mbps Hopping Mode High Band Edge Plot

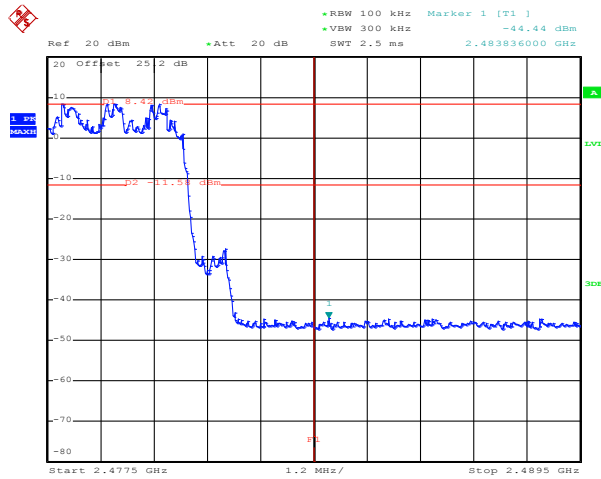

Date: 10.MAY.2014 13:54:26

### 3.7 Conducted Spurious Emission Measurement

#### 3.7.1 Limit of Spurious Emission Measurement

In any 100 kHz bandwidth outside the intentional radiation frequency band, the radio frequency power shall be at least 20 dB below the highest level of the radiated power. In addition, radiated emissions which fall in the restricted bands must also comply with the radiated emission limits.

#### 3.7.2 Measuring Instruments

The measuring equipment is listed in the section 4 of this test report.

#### 3.7.3 Test Procedure

1. The testing follows the guidelines in Spurious RF Conducted Emissions of FCC Public Notice DA 00-705 Measurement Guidelines
2. The RF output of EUT was connected to the spectrum analyzer by RF cable and attenuator. The path loss was compensated to the results for each measurement.
3. Set to the maximum power setting and enable the EUT transmit continuously.
4. Set RBW = 100 kHz, VBW = 300kHz, scan up through 10th harmonic. All harmonics / spurs must be at least 20 dB down from the highest emission level within the authorized band as measured with a 100 kHz RBW.
5. Measure and record the results in the test report.
6. The RF fundamental frequency should be excluded against the limit line in the operating frequency band.

#### 3.7.4 Test Setup

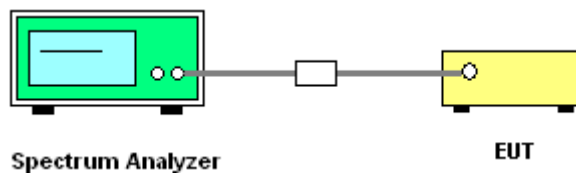



3.7.5 Test Result of Conducted Spurious Emission

Test Mode :	1Mbps	Temperature :	24~26°C
Test Channel :	00	Relative Humidity :	50~53%
		Test Engineer :	Bill Kuo

1Mbps CSE Plot on Ch 00 between 30MHz ~ 3 GHz

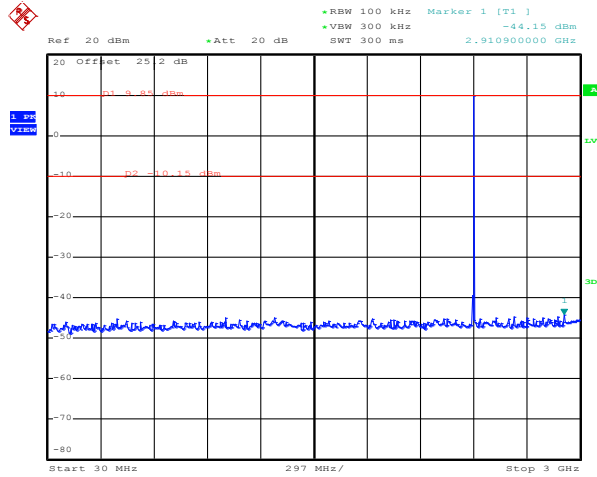

Date: 10.MAY.2014 12:37:25

1Mbps CSE Plot on Ch 00 between 2 GHz ~ 25 GHz

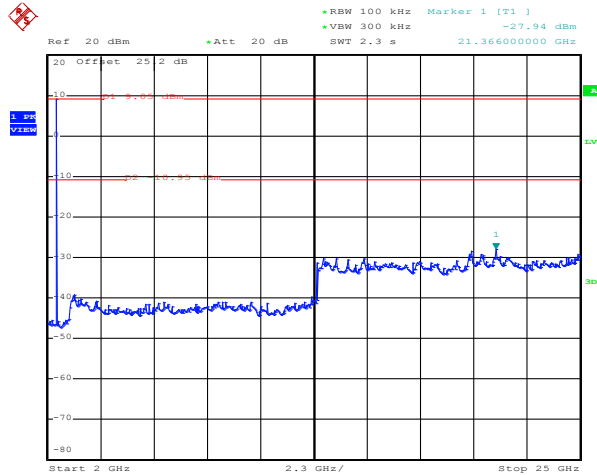

Date: 10.MAY.2014 12:37:47



Test Mode :	1Mbps	Temperature :	24~26°C
Test Channel :	39	Relative Humidity :	50~53%
		Test Engineer :	Bill Kuo

1Mbps CSE Plot on Ch 39 between 30MHz ~ 3 GHz

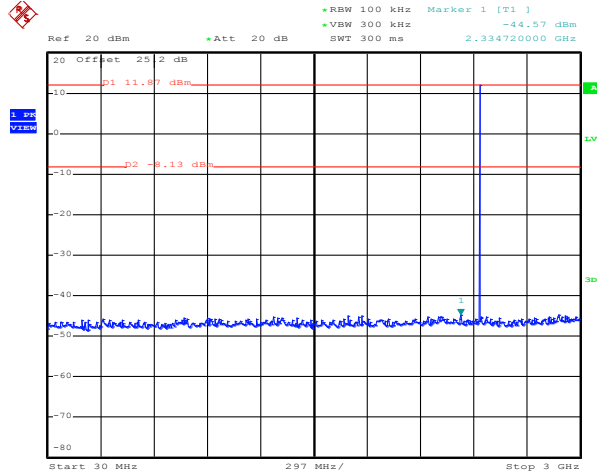

Date: 10.MAY.2014 12:34:09

1Mbps CSE Plot on Ch 39 between 2 GHz ~ 25 GHz

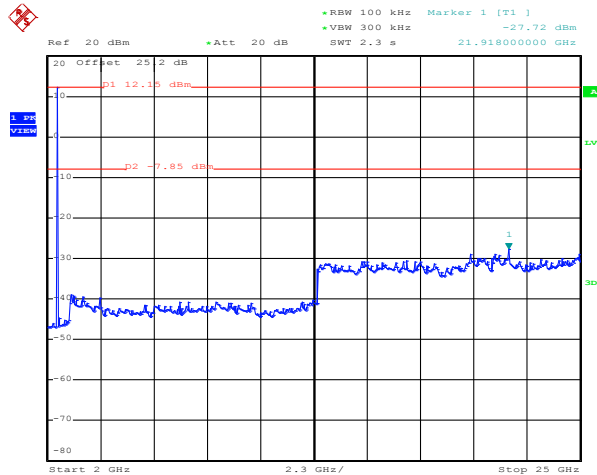

Date: 10.MAY.2014 12:34:31



Test Mode :	1Mbps	Temperature :	24~26°C
Test Channel :	78	Relative Humidity :	50~53%
		Test Engineer :	Bill Kuo

1Mbps CSE Plot on Ch 78 between 30MHz ~ 3 GHz

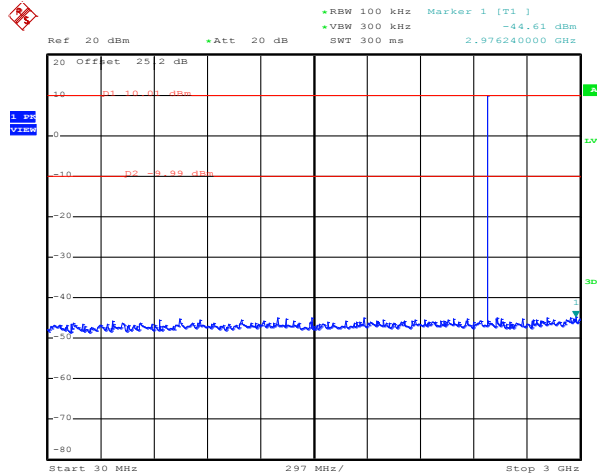

Date: 10.MAY.2014 12:30:35

1Mbps CSE Plot on Ch 78 between 2 GHz ~ 25 GHz

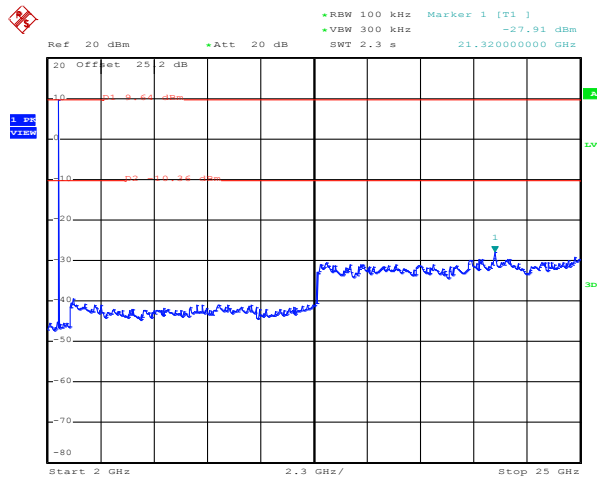

Date: 10.MAY.2014 12:30:56



Test Mode :	2Mbps	Temperature :	24~26°C
Test Channel :	00	Relative Humidity :	50~53%
		Test Engineer :	Bill Kuo

2Mbps CSE Plot on Ch 00 between 30MHz ~ 3 GHz

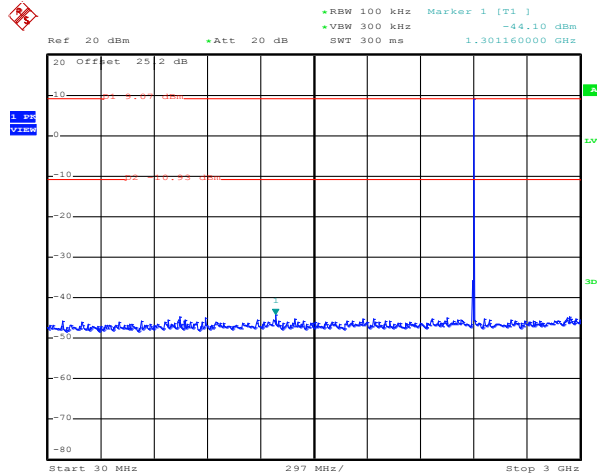

Date: 10.MAY.2014 13:12:39

2Mbps CSE Plot on Ch 00 between 2 GHz ~ 25 GHz

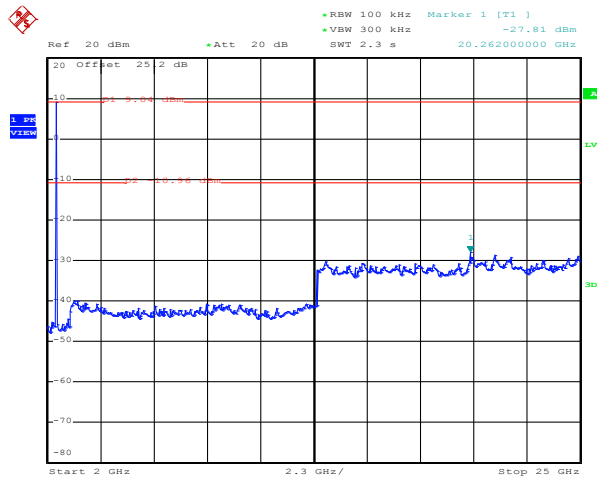

Date: 10.MAY.2014 13:13:01



Test Mode :	2Mbps	Temperature :	24~26°C
Test Channel :	39	Relative Humidity :	50~53%
		Test Engineer :	Bill Kuo

2Mbps CSE Plot on Ch 39 between 30MHz ~ 3 GHz

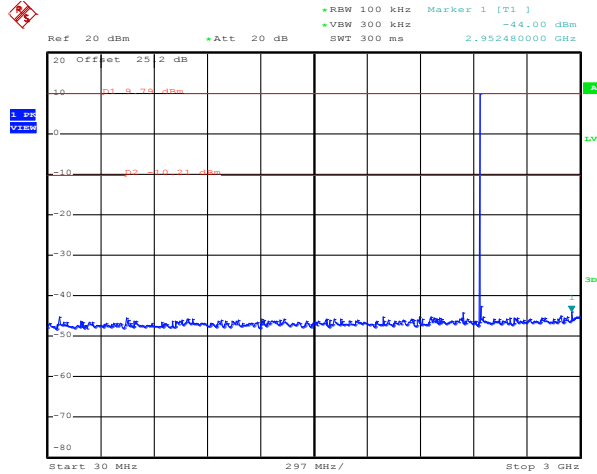

Date: 10.MAY.2014 13:14:49

2Mbps CSE Plot on Ch 39 between 2 GHz ~ 25 GHz

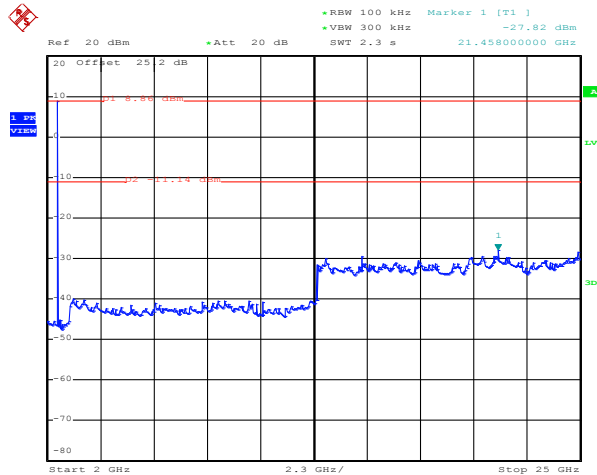

Date: 10.MAY.2014 13:15:11



Test Mode :	2Mbps	Temperature :	24~26°C
Test Channel :	78	Relative Humidity :	50~53%
		Test Engineer :	Bill Kuo

2Mbps CSE Plot on Ch 78 between 30MHz ~ 3 GHz

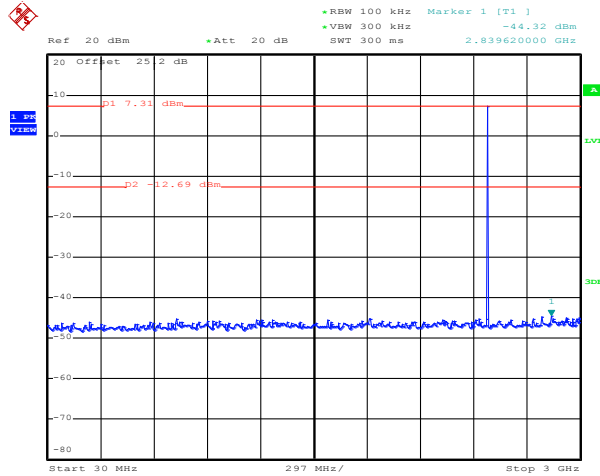

Date: 10.MAY.2014 13:22:08

2Mbps CSE Plot on Ch 78 between 2 GHz ~ 25 GHz

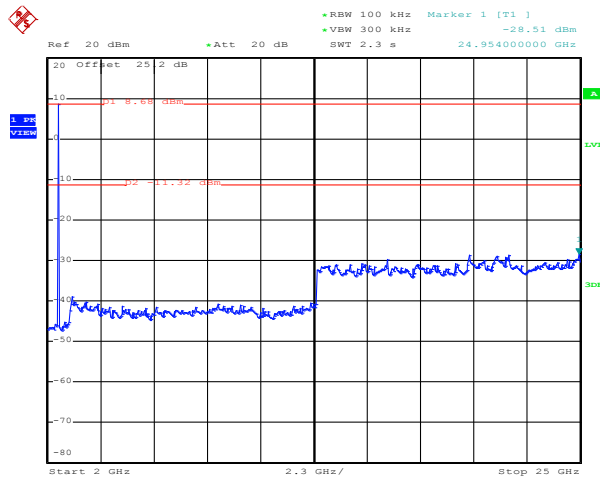

Date: 10.MAY.2014 13:22:30





Test Mode :	3Mbps	Temperature :	24~26°C
Test Channel :	00	Relative Humidity :	50~53%
		Test Engineer :	Bill Kuo

3Mbps CSE Plot on Ch 00 between 30MHz ~ 3 GHz

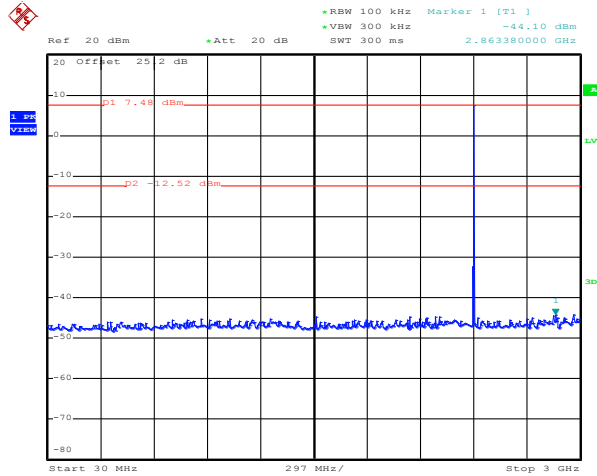

Date: 10.MAY.2014 13:33:29

3Mbps CSE Plot on Ch 00 between 2 GHz ~ 25 GHz

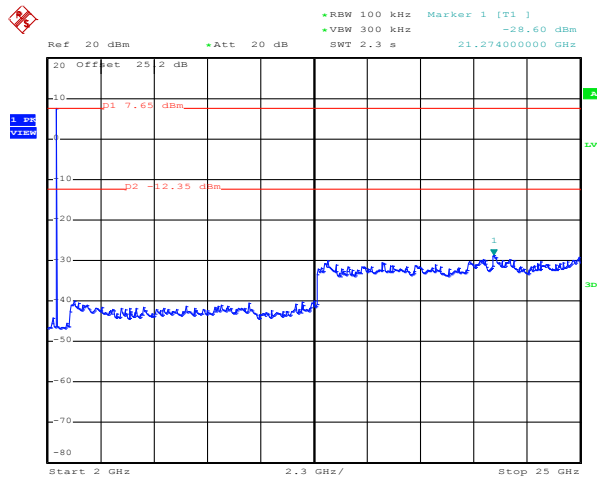

Date: 10.MAY.2014 13:33:50



Test Mode :	3Mbps	Temperature :	24~26°C
Test Channel :	39	Relative Humidity :	50~53%
		Test Engineer :	Bill Kuo

3Mbps CSE Plot on Ch 39 between 30MHz ~ 3 GHz

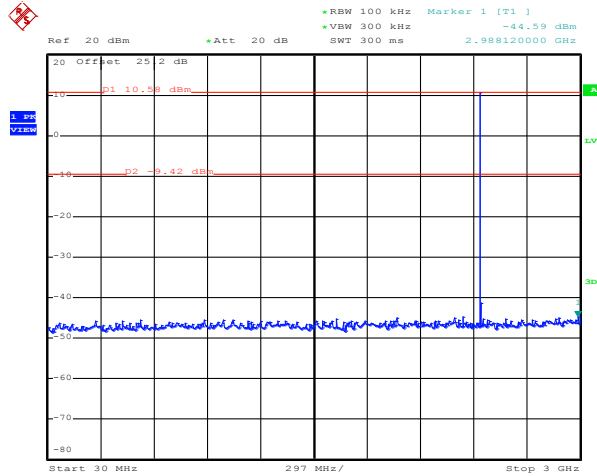

Date: 10.MAY.2014 13:29:19

3Mbps CSE Plot on Ch 39 between 2 GHz ~ 25 GHz

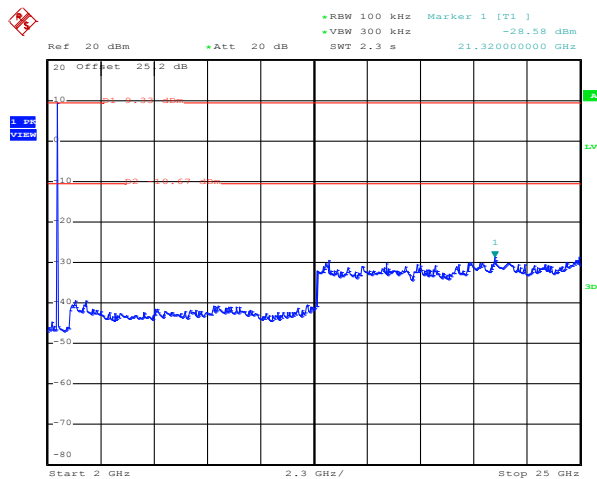

Date: 10.MAY.2014 13:29:40



Test Mode :	3Mbps	Temperature :	24~26°C
Test Channel :	78	Relative Humidity :	50~53%
		Test Engineer :	Bill Kuo

3Mbps CSE Plot on Ch 78 between 30MHz ~ 3 GHz

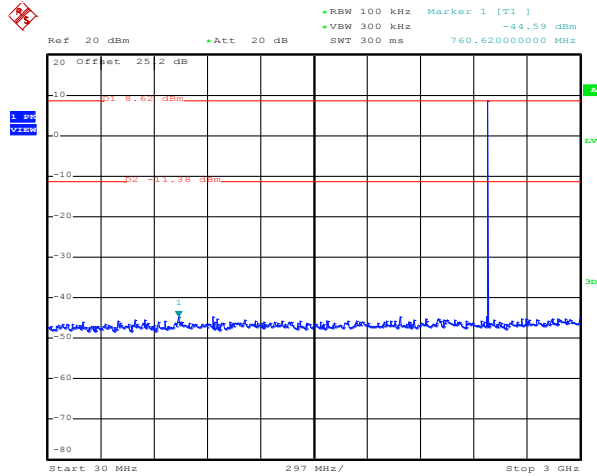

Date: 10.MAY.2014 13:25:33

3Mbps CSE Plot on Ch 78 between 2 GHz ~ 25 GHz

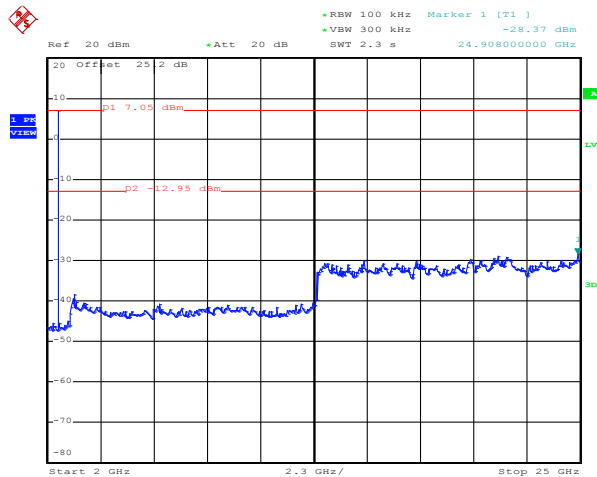

Date: 10.MAY.2014 13:25:55



### 3.8 Radiated Band Edges and Spurious Emission Measurement

#### 3.8.1 Limit of Radiated Band Edges and Spurious Emission

In any 100 kHz bandwidth outside the intentional radiator frequency band, all harmonics/spurious must be at least 20 dB below the highest emission level within the authorized band. In addition, radiated emissions which fall in the restricted bands must also comply with the FCC section 15.209 limits as below.

Frequency (MHz)	Field Strength (microvolts/meter)	Measurement Distance (meters)
0.009 – 0.490	2400/F(kHz)	300
0.490 – 1.705	24000/F(kHz)	30
1.705 – 30.0	30	30
30 – 88	100	3
88 – 216	150	3
216 - 960	200	3
Above 960	500	3

#### 3.8.2 Measuring Instruments

The measuring equipment is listed in the section 4 of this test report.



### 3.8.3 Test Procedures

1. The testing follows the guidelines in Spurious Radiated Emissions of FCC Public Notice DA 00-705 Measurement Guidelines.
2. The EUT was placed on a turntable with 0.8 meter above ground.
3. The EUT was set 3 meters from the interference receiving antenna, which was mounted on the top of a variable height antenna tower.
4. For each suspected emission, the EUT was arranged to its worst case and then tune the Antenna tower (from 1 m to 4 m) and turntable (from 0 degree to 360 degrees) to find the maximum reading. A pre-amp and a high pass filter are used for the test in order to get better signal level to comply with the guidelines.
5. Set to the maximum power setting and enable the EUT transmit continuously.
6. Use the following spectrum analyzer settings:
  - (1) Span shall wide enough to fully capture the emission being measured;
  - (2) Set RBW=100 kHz for  $f < 1$  GHz, RBW=1MHz for  $f > 1$ GHz ; VBW  $\geq$  RBW; Sweep = auto; Detector function = peak; Trace = max hold for peak
  - (3) For average measurement: use duty cycle correction factor method per 15.35(c).  
Duty cycle = On time/100 milliseconds  
On time =  $N_1 * L_1 + N_2 * L_2 + \dots + N_{n-1} * L_{n-1} + N_n * L_n$   
Where  $N_1$  is number of type 1 pulses,  $L_1$  is length of type 1 pulses, etc.  
Average Emission Level = Peak Emission Level +  $20 * \log(\text{Duty cycle})$
7. Corrected Reading: Antenna Factor + Cable Loss + Read Level - Preamp Factor = Level

Note: The average levels were calculated from the peak level corrected with duty cycle correction factor (24.86dB) derived from  $20 \log(\text{dwell time}/100\text{ms})$ . This correction is only for signals that hop with the fundamental signal, such as band-edge and harmonic. Other spurious signals that are independent of the hopping signal would not use this correction.

### 3.8.4 Test Setup

For radiated emissions below 30MHz

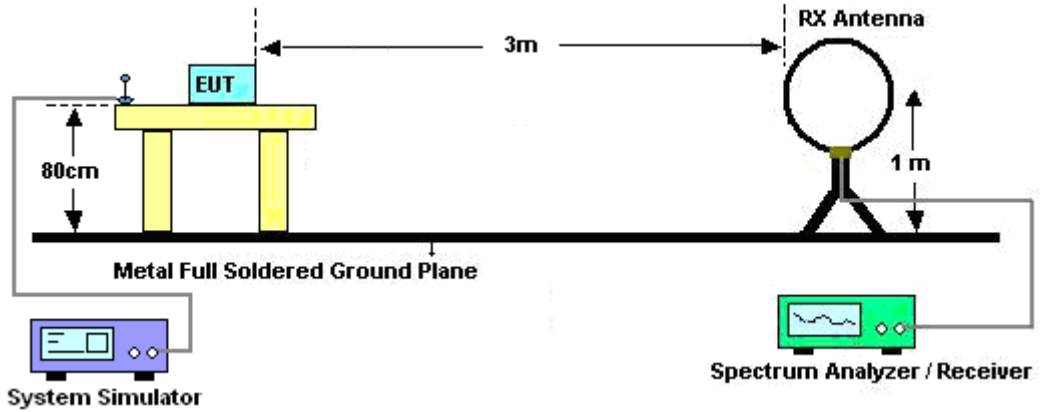

For radiated emissions from 30MHz to 1GHz

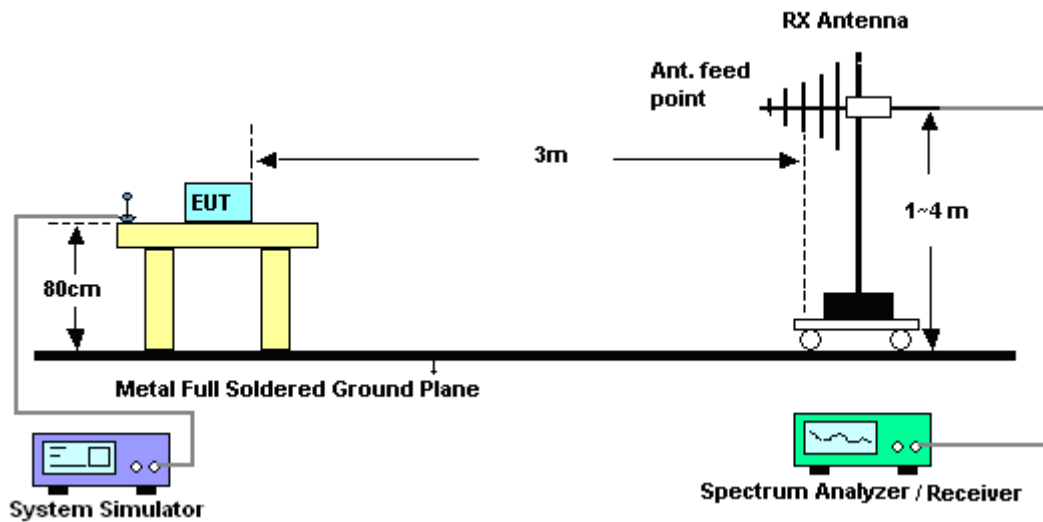

For radiated emissions above 1GHz

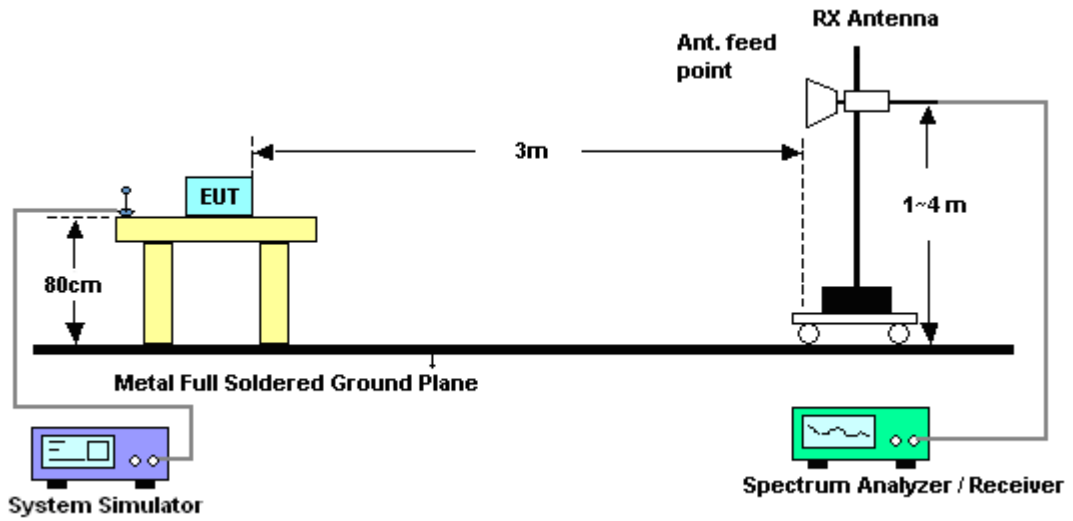

### 3.8.5 Test Results of Radiated Spurious Emissions (9 kHz ~ 30 MHz)

The low frequency, which started from 9 kHz to 30MHz, was pre-scanned and the result which was 20dB lower than the limit line per 15.31(o) was not reported.



### 3.8.6 Duty cycle correction factor for average measurement

#### 3DH5 on time (One Pulse) Plot on Channel 39

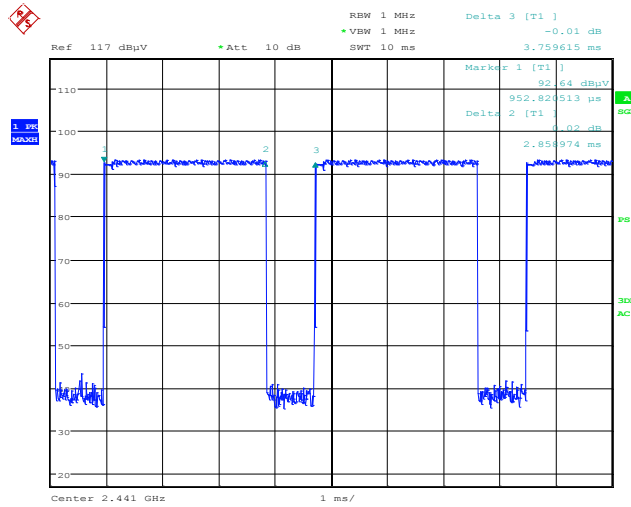

Date: 7.JUN.2014 06:43:17

#### 3DH5 on time (Count Pulses) Plot on Channel 39

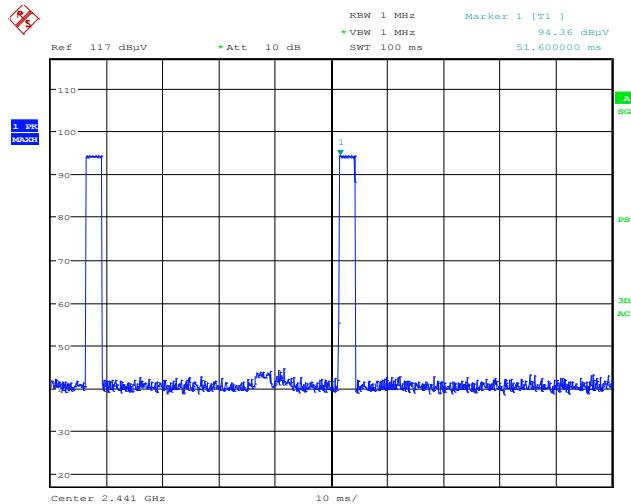

Date: 7.JUN.2014 06:45:13

#### Note:

1. Worst case Duty cycle = on time/100 milliseconds =  $2 * 2.858974 / 100 = 5.72 \%$
2. Worst case Duty cycle correction factor =  $20 * \log(\text{Duty cycle}) = -24.86 \text{ dB}$
3. 3DH5 has the highest duty cycle worst case and is reported.





**Duty Cycle Correction Factor Consideration for AFH mode:**

Bluetooth normal hopping rate is 1600Hz and reduced to 800Hz in AFH mode; due to the reduced number of hopping frequencies, with the same packet configuration the dwell time in each channel frequency within 100msec period is longer in AFH mode than normal mode.

In AFH mode, the minimum hopping frequencies are 20, to get the longest dwell time DH5 packet is observed; the period to have DH5 packet completing one hopping sequence is

$$2.858974 \text{ ms} \times 20 \text{ channels} = 57.2 \text{ ms}$$

There cannot be 2 complete hopping sequences within 100ms period, considering the random hopping behavior, maximum 2 hops can be possibly observed within the period.  $[100\text{ms} / 57.6\text{ms}] = 2 \text{ hops}$

Thus, the maximum possible ON time:

$$2.858974 \text{ ms} \times 2 = 5.72 \text{ ms}$$

Worst case Duty Cycle Correction factor, which is derived from the maximum possible ON time,

$$20 \times \log(5.72 \text{ ms}/100\text{ms}) = -24.86 \text{ dB}$$



3.8.7 Test Result of Radiated Spurious at Band Edges

Test Mode :	3Mbps	Temperature :	22~23°C
Test Channel :	00	Relative Humidity :	52~53%
		Test Engineer :	Hayden Wu

ANTENNA POLARITY : HORIZONTAL										
Frequency ( MHz )	Level ( dBμV/m )	Over Limit ( dB )	Limit Line ( dBμV/m )	Read Level ( dBμV )	Antenna Factor ( dB )	Cable Loss ( dB )	Preamp Factor ( dB )	Ant Pos ( cm )	Table Pos ( deg )	Remark
2350.41	48.79	-25.21	74	45.18	31.88	6.38	34.65	200	334	Peak
2350.41	23.93	-30.07	54	-	-	-	-	-	-	Average

ANTENNA POLARITY : VERTICAL										
Frequency ( MHz )	Level ( dBμV/m )	Over Limit ( dB )	Limit Line ( dBμV/m )	Read Level ( dBμV )	Antenna Factor ( dB )	Cable Loss ( dB )	Preamp Factor ( dB )	Ant Pos ( cm )	Table Pos ( deg )	Remark
2312.88	48.19	-25.81	74	44.64	31.85	6.35	34.65	122	308	Peak
2312.88	23.33	-30.67	54	-	-	-	-	-	-	Average

Test Mode :	3Mbps	Temperature :	22~23°C
Test Channel :	78	Relative Humidity :	52~53%
		Test Engineer :	Hayden Wu

ANTENNA POLARITY : HORIZONTAL										
Frequency ( MHz )	Level ( dBμV/m )	Over Limit ( dB )	Limit Line ( dBμV/m )	Read Level ( dBμV )	Antenna Factor ( dB )	Cable Loss ( dB )	Preamp Factor ( dB )	Ant Pos ( cm )	Table Pos ( deg )	Remark
2483.5	61.86	-12.14	74	57.91	31.99	6.59	34.63	164	330	Peak
2483.5	37	-17	54	-	-	-	-	-	-	Average

ANTENNA POLARITY : VERTICAL										
Frequency ( MHz )	Level ( dBμV/m )	Over Limit ( dB )	Limit Line ( dBμV/m )	Read Level ( dBμV )	Antenna Factor ( dB )	Cable Loss ( dB )	Preamp Factor ( dB )	Ant Pos ( cm )	Table Pos ( deg )	Remark
2483.53	60.22	-13.78	74	56.27	31.99	6.59	34.63	109	255	Peak
2483.53	35.36	-18.64	54	-	-	-	-	-	-	Average

Note: Average Emission Level = Peak Emission Level + duty cycle correction factor(24.86dB)



3.8.8 Test Result of Radiated Spurious Emission (30MHz ~ 10<sup>th</sup> Harmonic)

Note: Pre-scanned all test modes and only choose the worst case mode recorded in the test report for radiated spurious emission below 1GHz.

Table with 4 rows and 4 columns: Test Mode (3Mbps), Temperature (22~23°C), Test Channel (00), Relative Humidity (52~53%), Test Engineer (Hayden Wu), Polarization (Horizontal), Remark (2403 MHz is fundamental signal which can be ignored).

Table with 11 columns: Frequency (MHz), Level (dBµV/m), Over Limit (dB), Limit Line (dBµV/m), Read Level (dBµV), Antenna Factor (dB), Cable Loss (dB), Preamp Factor (dB), Ant Pos (cm), Table Pos (deg), Remark. Rows include data for 2403 and 4803 MHz at Peak and Average levels.

- Note: 1. Other harmonics are lower than background noise.
2. Average Emission Level = Peak Emission Level + duty cycle correction factor( 24.86)

Table with 4 rows and 4 columns: Test Mode (3Mbps), Temperature (22~23°C), Test Channel (00), Relative Humidity (52~53%), Test Engineer (Hayden Wu), Polarization (Vertical), Remark (2403 MHz is fundamental signal which can be ignored).

Table with 11 columns: Frequency (MHz), Level (dBµV/m), Over Limit (dB), Limit Line (dBµV/m), Read Level (dBµV), Antenna Factor (dB), Cable Loss (dB), Preamp Factor (dB), Ant Pos (cm), Table Pos (deg), Remark. Rows include data for 2403 and 4803 MHz at Peak and Average levels.

- Note: 1. Other harmonics are lower than background noise.
2. Average Emission Level = Peak Emission Level + duty cycle correction factor( 24.86)



<b>Test Mode :</b>	3Mbps	<b>Temperature :</b>	22~23°C
<b>Test Channel :</b>	39	<b>Relative Humidity :</b>	52~53%
<b>Test Engineer :</b>	Hayden Wu	<b>Polarization :</b>	Horizontal
<b>Remark :</b>	2441 MHz is fundamental signal which can be ignored.		

Frequency ( MHz )	Level ( dBµV/m )	Over Limit ( dB )	Limit Line ( dBµV/m )	Read Level ( dBµV )	Antenna Factor ( dB )	Cable Loss ( dB )	Preamp Factor ( dB )	Ant Pos ( cm )	Table Pos ( deg )	Remark
2441	106.92	-	-	103.08	31.96	6.52	34.64	200	336	Peak
2441	82.06	-	-	-	-	-	-	-	-	Average
4881	40.76	-33.24	74	56.89	34.37	10.19	60.69	100	0	Peak
4881	15.9	-38.1	54	-	-	-	-	-	-	Average
7323	43.14	-30.86	74	57.13	35.6	10.94	60.53	100	0	Peak
7323	18.28	-35.72	54	-	-	-	-	-	-	Average

- Note:** 1. Other harmonics are lower than background noise.  
2. Average Emission Level = Peak Emission Level + duty cycle correction factor( 24.86)

<b>Test Mode :</b>	3Mbps	<b>Temperature :</b>	22~23°C
<b>Test Channel :</b>	39	<b>Relative Humidity :</b>	52~53%
<b>Test Engineer :</b>	Hayden Wu	<b>Polarization :</b>	Vertical
<b>Remark :</b>	2441 MHz is fundamental signal which can be ignored.		

Frequency ( MHz )	Level ( dBµV/m )	Over Limit ( dB )	Limit Line ( dBµV/m )	Read Level ( dBµV )	Antenna Factor ( dB )	Cable Loss ( dB )	Preamp Factor ( dB )	Ant Pos ( cm )	Table Pos ( deg )	Remark
2441	104.72	-	-	100.88	31.96	6.52	34.64	114	274	Peak
2441	79.86	-	-	-	-	-	-	-	-	Average
4881	42.87	-31.13	74	59	34.37	10.19	60.69	100	0	Peak
4881	18.01	-35.99	54	-	-	-	-	-	-	Average
7323	43.74	-30.26	74	57.73	35.6	10.94	60.53	100	0	Peak
7323	18.88	-35.12	54	-	-	-	-	-	-	Average

- Note:** 1. Other harmonics are lower than background noise.  
2. Average Emission Level = Peak Emission Level + duty cycle correction factor( 24.86)



<b>Test Mode :</b>	3Mbps	<b>Temperature :</b>	22~23°C
<b>Test Channel :</b>	78	<b>Relative Humidity :</b>	52~53%
<b>Test Engineer :</b>	Hayden Wu	<b>Polarization :</b>	Horizontal
<b>Remark :</b>	2481 MHz is fundamental signal which can be ignored.		

Frequency ( MHz )	Level ( dBμV/m )	Over Limit ( dB )	Limit Line ( dBμV/m )	Read Level ( dBμV )	Antenna Factor ( dB )	Cable Loss ( dB )	Preamp Factor ( dB )	Ant Pos ( cm )	Table Pos ( deg )	Remark
102.9	27.83	-15.67	43.5	47.18	11.28	1.12	31.75	100	136	Peak
212.79	26.05	-17.45	43.5	47.1	9.12	1.58	31.75	-	-	Peak
294.6	28.51	-17.49	46	45.25	13.1	1.88	31.72	-	-	Peak
305.6	30.16	-15.84	46	46.66	13.31	1.92	31.73	-	-	Peak
380.5	29.58	-16.42	46	44.15	15.1	2.13	31.8	-	-	Peak
502.3	25.54	-20.46	46	37.16	17.82	2.49	31.93	-	-	Peak
2481	106.42	-	-	102.47	31.99	6.59	34.63	164	330	Peak
2481	81.56	-	-	-	-	-	-	-	-	Average
4959	41.32	-32.68	74	57.27	34.32	10.21	60.48	100	0	Peak
4959	16.46	-37.54	54	-	-	-	-	-	-	Average
7440	44.04	-29.96	74	58.19	35.53	10.9	60.58	100	0	Peak
7440	19.18	-34.82	54	-	-	-	-	-	-	Average

**Note:** 1. Other harmonics are lower than background noise.

2. Average Emission Level = Peak Emission Level + duty cycle correction factor( 24.86)



<b>Test Mode :</b>	3Mbps	<b>Temperature :</b>	22~23°C
<b>Test Channel :</b>	78	<b>Relative Humidity :</b>	52~53%
<b>Test Engineer :</b>	Hayden Wu	<b>Polarization :</b>	Vertical
<b>Remark :</b>	2481 MHz is fundamental signal which can be ignored.		

Frequency ( MHz )	Level ( dBμV/m )	Over Limit ( dB )	Limit Line ( dBμV/m )	Read Level ( dBμV )	Antenna Factor ( dB )	Cable Loss ( dB )	Preamp Factor ( dB )	Ant Pos ( cm )	Table Pos ( deg )	Remark
30	33.07	-6.93	40	45.73	18.5	0.64	31.8	100	26	Peak
97.23	27.26	-16.24	43.5	47.54	10.38	1.09	31.75	-	-	Peak
299.46	25.76	-20.24	46	42.37	13.2	1.91	31.72	-	-	Peak
310.5	26.72	-19.28	46	43.11	13.4	1.94	31.73	-	-	Peak
454	30.75	-15.25	46	43.29	17.02	2.32	31.88	-	-	Peak
523.3	30.1	-15.9	46	41.43	18.12	2.51	31.96	-	-	Peak
2481	103.72	-	-	99.77	31.99	6.59	34.63	109	255	Peak
2481	78.86	-	-	-	-	-	-	-	-	Average
4959	42.04	-31.96	74	57.99	34.32	10.21	60.48	100	0	Peak
4959	17.18	-36.82	54	-	-	-	-	-	-	Average
7440	44.24	-29.76	74	58.39	35.53	10.9	60.58	100	0	Peak
7440	19.38	-34.62	54	-	-	-	-	-	-	Average

**Note:** 1. Other harmonics are lower than background noise.

2. Average Emission Level = Peak Emission Level + duty cycle correction factor( 24.86)



### 3.9 AC Conducted Emission Measurement

#### 3.9.1 Limit of AC Conducted Emission

For equipment that is designed to be connected to the public utility (AC) power line, the radio frequency voltage that is conducted back onto the AC power line on any frequency or frequencies within the band 150 kHz to 30 MHz shall not exceed the limits in the following table.

Frequency of emission (MHz)	Conducted limit (dBµV)	
	Quasi-peak	Average
0.15-0.5	66 to 56*	56 to 46*
0.5-5	56	46
5-30	60	50

\*Decreases with the logarithm of the frequency.

#### 3.9.2 Measuring Instruments

The measuring equipment is listed in the section 4 of this test report.

#### 3.9.3 Test Procedures

1. The EUT was placed 0.4 meter from the conducting wall of the shielding room was kept at least 80 centimeters from any other grounded conducting surface.
2. Connect EUT to the power mains through a line impedance stabilization network (LISN).
3. All the support units are connecting to the other LISN.
4. The LISN provides 50 ohm coupling impedance for the measuring instrument.
5. The FCC states that a 50 ohm, 50 microhenry LISN should be used.
6. Both sides of AC line were checked for maximum conducted interference.
7. The frequency range from 150 kHz to 30 MHz was searched.
8. Set the test-receiver system to Peak Detect Function and specified bandwidth with Maximum Hold Mode.

### 3.9.4 Test Setup

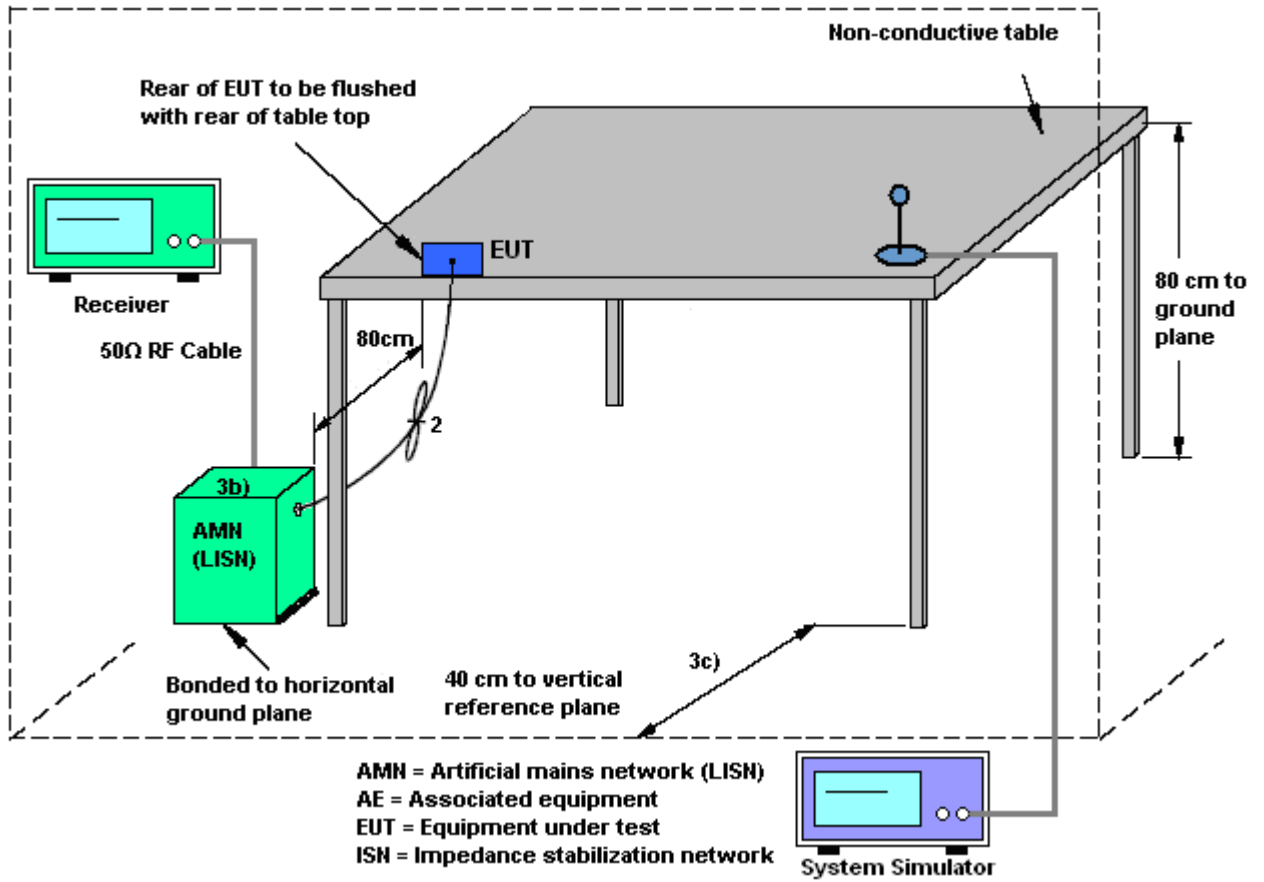





### 3.9.5 Test Result of AC Conducted Emission

Test Mode :	Mode 1	Temperature :	20~22°C
Test Engineer :	Cosmo Xu	Relative Humidity :	45~47%
Test Voltage :	120Vac / 60Hz	Phase :	Line
Function Type :	GSM850 Idle + Bluetooth Link + WLAN (2.4GHz) Link + USB Cable (Charging from Adapter) + Battery + Earphone + MP3		

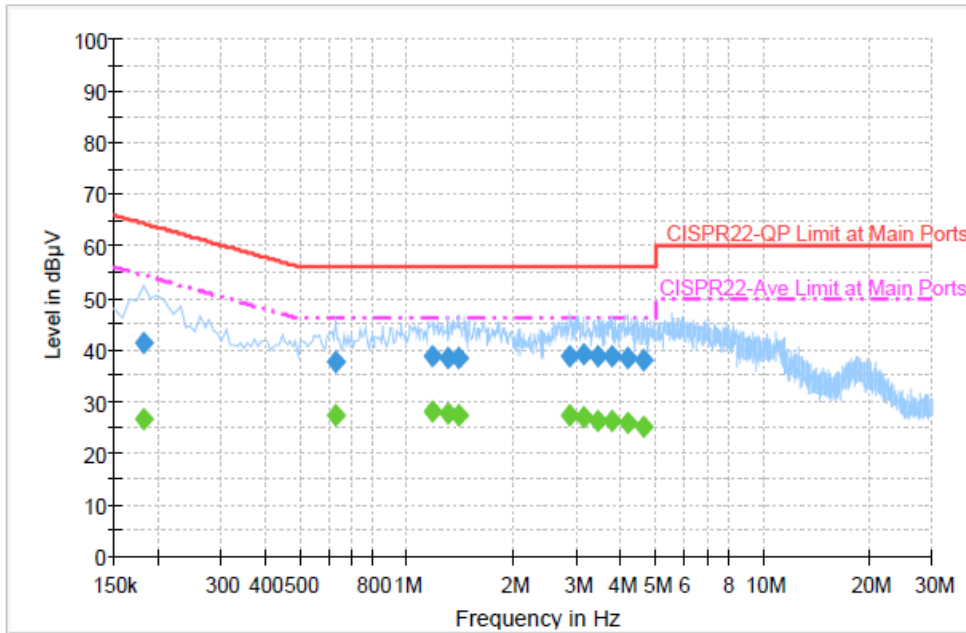

**Final Result : Quasi-Peak**

Frequency (MHz)	Quasi-Peak (dBµV)	Filter	Line	Corr. (dB)	Margin (dB)	Limit (dBµV)
0.182000	41.2	Off	L1	19.3	23.2	64.4
0.630000	37.6	Off	L1	19.4	18.4	56.0
1.182000	38.6	Off	L1	19.6	17.4	56.0
1.302000	38.5	Off	L1	19.5	17.5	56.0
1.398000	38.2	Off	L1	19.5	17.8	56.0
2.878000	38.7	Off	L1	19.6	17.3	56.0
3.150000	39.0	Off	L1	19.6	17.0	56.0
3.462000	38.7	Off	L1	19.6	17.3	56.0
3.750000	38.6	Off	L1	19.6	17.4	56.0
4.166000	38.4	Off	L1	19.6	17.6	56.0
4.606000	38.1	Off	L1	19.7	17.9	56.0



Test Mode :	Mode 1	Temperature :	20~22°C
Test Engineer :	Cosmo Xu	Relative Humidity :	45~47%
Test Voltage :	120Vac / 60Hz	Phase :	Line
Function Type :	GSM850 Idle + Bluetooth Link + WLAN (2.4GHz) Link + USB Cable (Charging from Adapter) + Battery + Earphone + MP3		

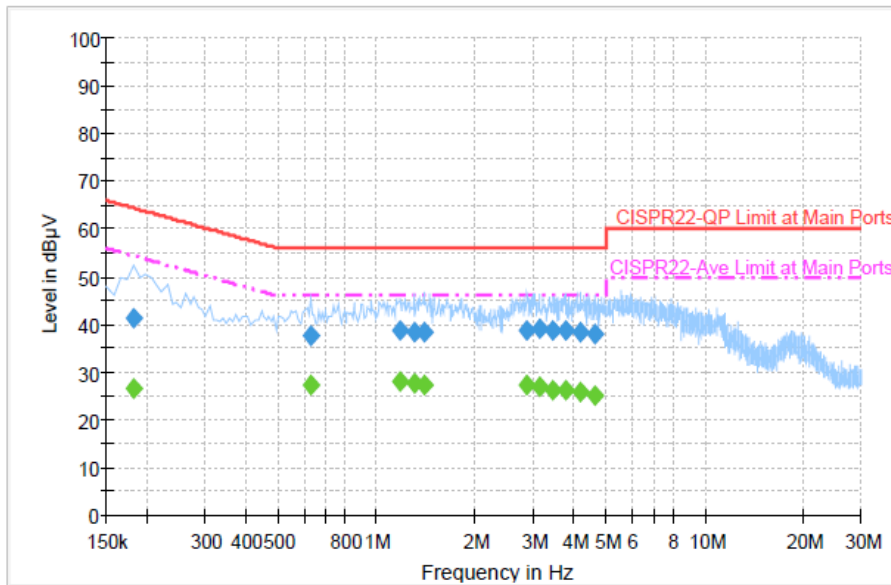

Final Result : Average

Frequency (MHz)	Average (dBµV)	Filter	Line	Corr. (dB)	Margin (dB)	Limit (dBµV)
0.182000	26.7	Off	L1	19.3	27.7	54.4
0.630000	27.1	Off	L1	19.4	18.9	46.0
1.182000	27.9	Off	L1	19.6	18.1	46.0
1.302000	27.7	Off	L1	19.5	18.3	46.0
1.398000	27.4	Off	L1	19.5	18.6	46.0
2.878000	27.2	Off	L1	19.6	18.8	46.0
3.150000	26.8	Off	L1	19.6	19.2	46.0
3.462000	26.1	Off	L1	19.6	19.9	46.0
3.750000	26.2	Off	L1	19.6	19.8	46.0
4.166000	25.8	Off	L1	19.6	20.2	46.0
4.606000	25.3	Off	L1	19.7	20.7	46.0



Test Mode :	Mode 1	Temperature :	20~22°C
Test Engineer :	Cosmo Xu	Relative Humidity :	45~47%
Test Voltage :	120Vac / 60Hz	Phase :	Neutral
Function Type :	GSM850 Idle + Bluetooth Link + WLAN (2.4GHz) Link + USB Cable (Charging from Adapter) + Battery + Earphone + MP3		

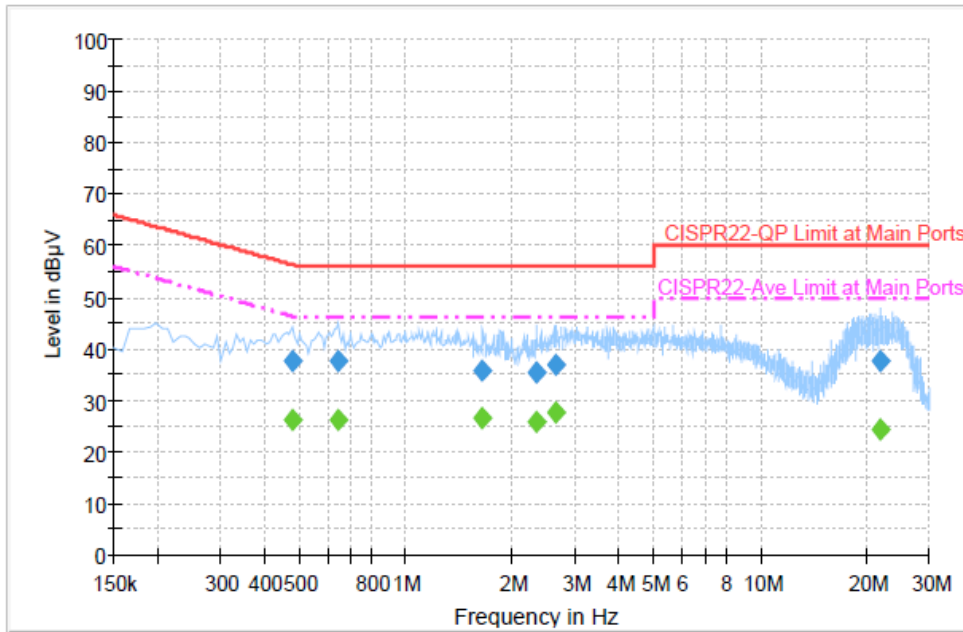

**Final Result : Quasi-Peak**

Frequency (MHz)	Quasi-Peak (dBµV)	Filter	Line	Corr. (dB)	Margin (dB)	Limit (dBµV)
0.478000	37.6	Off	N	19.4	18.8	56.4
0.646000	37.5	Off	N	19.4	18.5	56.0
1.646000	35.6	Off	N	19.5	20.4	56.0
2.334000	35.3	Off	N	19.6	20.7	56.0
2.662000	36.9	Off	N	19.5	19.1	56.0
21.734000	37.7	Off	N	20.0	22.3	60.0

**Final Result : Average**

Frequency (MHz)	Average (dBµV)	Filter	Line	Corr. (dB)	Margin (dB)	Limit (dBµV)
0.478000	26.3	Off	N	19.4	20.1	46.4
0.646000	26.3	Off	N	19.4	19.7	46.0
1.646000	26.4	Off	N	19.5	19.6	46.0
2.334000	25.9	Off	N	19.6	20.1	46.0
2.662000	27.5	Off	N	19.5	18.5	46.0
21.734000	24.5	Off	N	20.0	25.5	50.0



## **3.10 Antenna Requirements**

### **3.10.1 Standard Applicable**

If directional gain of transmitting antennas is greater than 6dBi, the power shall be reduced by the same level in dB comparing to gain minus 6dBi. The use of a permanently attached antenna or of an antenna that uses a unique coupling to the intentional radiator shall be considered sufficient to comply with the FCC rule.

### **3.10.2 Antenna Anti-Replacement Construction**

An embedded-in antenna design is used.

### **3.10.3 Antenna Gain**

The antenna peak gain of EUT is less than 6 dBi. Therefore, it is not necessary to reduce maximum peak output power limit.



## 4 List of Measuring Equipment

Instrument	Manufacturer	Model No.	Serial No.	Characteristics	Calibration Date	Test Date	Due Date	Remark
Spectrum Analyzer	Rohde & Schwarz	FSP40	100055	9kHz~40GHz	Jun. 07, 2013	May 02, 2014~ May 10, 2014	Jun. 06, 2014	Conducted (TH02-HY)
Power Meter	Agilent	E4416A	GB41292344	300MHz~40GHz	Jan. 28, 2014	May 02, 2014~ May 10, 2014	Jan. 27, 2015	Conducted (TH02-HY)
Power Sensor	Agilent	E9327A	US40441548	300MHz~40GHz	Jan. 28, 2014	May 02, 2014~ May 10, 2014	Jan. 27, 2015	Conducted (TH02-HY)
Spectrum Analyzer	R&S	FSP30	101067	9kHz ~ 30GHz	Nov. 20, 2013	Jun. 07, 2014	Nov. 19, 2014	Radiation (03CH06-HY)
Spectrum Analyzer	Agilent	E4408B	MY44211030	9kHz ~ 26.5GHz	Dec. 02, 2013	Jun. 07, 2014	Dec. 01, 2014	Radiation (03CH06-HY)
EMI Test Receiver	R&S	ESVS10	834468/0003	20MHz ~ 1GMHz	May 06, 2014	Jun. 07, 2014	May 05, 2015	Radiation (03CH06-HY)
Loop Antenna	Rohde & Schwarz	HFH2-Z2	860004/0001	9kHz ~ 30MHz	Jul. 03, 2012	Jun. 07, 2014	Jul. 02, 2014	Radiation (03CH06-HY)
Bilog Antenna	Schaffner	CBL6112B	2885	30MHz ~ 2GHz	Oct. 10, 2013	Jun. 07, 2014	Oct. 09, 2014	Radiation (03CH06-HY)
Double Ridge Horn Antenna	EMCO	3117	00066583	1GHz ~ 18GHz	Aug. 02, 2013	Jun. 07, 2014	Aug. 01, 2014	Radiation (03CH06-HY)
Amplifier	SONOMA	310N	186713	9kHz ~ 1GHz	Apr. 16, 2014	Jun. 07, 2014	Apr. 15, 2015	Radiation (03CH06-HY)
Pre Amplifier	EMCI	EMC051845	SN980048	1GHz ~ 18GHz	Jul. 18, 2013	Jun. 07, 2014	Jul. 17, 2014	Radiation (03CH06-HY)
SHF-EHF Horn Antenna	SCHWARZB ECK	BBHA 9170	BBHA91702 51	15GHz ~ 40GHz	Oct. 03, 2013	Jun. 07, 2014	Oct. 02, 2014	Radiation (03CH06-HY)
Preamplifier	Agilent	8449B	3008A01917	1GHz ~ 26.5GHz	Apr. 10, 2014	Jun. 07, 2014	Apr. 09, 2015	Radiation (03CH06-HY)
Turn Table	INN-CO	DS2000	420/650/00	0 ~ 360 degree	N/A	Jun. 07, 2014	N/A	Radiation (03CH06-HY)
Antenna Mast	MF	MF-7802	MF78020821 2	1 m ~ 4 m	N/A	Jun. 07, 2014	N/A	Radiation (03CH06-HY)
EMI Test Receiver	Rohde & Schwarz	ESCS 30	100356	9kHz ~ 2.75GHz	Nov. 15, 2013	May 14, 2014	Nov. 14, 2014	Conduction (CO05-HY)
LISN (for auxiliary equipment)	Rohde & Schwarz	ENV216	100081	9kHz ~ 30MHz	Dec. 12, 2013	May 14, 2014	Dec. 11, 2014	Conduction (CO05-HY)
LISN	Rohde & Schwarz	ENV216	100080	9kHz ~ 30MHz	Dec. 04, 2013	May 14, 2014	Dec. 03, 2014	Conduction (CO05-HY)
AC Power Source	ChainTek	APC-1000W	N/A	N/A	N/A	May 14, 2014	N/A	Conduction (CO05-HY)



## 5 Uncertainty of Evaluation

### Uncertainty of Conducted Emission Measurement (150 kHz ~ 30 MHz)

Measuring Uncertainty for a Level of Confidence of 95% ( $U = 2Uc(y)$ )	2.26
---	------

### Uncertainty of Radiated Emission Measurement (30 MHz ~ 1000 MHz)

Measuring Uncertainty for a Level of Confidence of 95% ( $U = 2Uc(y)$ )	4.50
---	------