



FCC RF Test Report

APPLICANT : Motorola Mobility, LLC
EQUIPMENT : Mobile Cellular Phone
BRAND NAME : Motorola Mobility, LLC
FCC MODEL NAME : 3578
FCC ID : IHDT56QA1
STANDARD : FCC Part 15 Subpart C §15.247
CLASSIFICATION : (DTS) Digital Transmission System

The product was received on Apr. 29, 2014 and testing was completed on Jun. 06, 2014. We, SPORTON INTERNATIONAL INC., would like to declare that the tested sample has been evaluated in accordance with the test procedures and has been in compliance with the applicable technical standards.

The test results in this report apply exclusively to the tested model / sample. Without written approval of SPORTON INTERNATIONAL INC., the test report shall not be reproduced except in full.

Reviewed by: Joseph Lin / Supervisor

Approved by: Jones Tsai / Manager



SPORTON INTERNATIONAL INC.

No. 52, Hwa Ya 1st Rd., Hwa Ya Technology Park, Kwei-Shan Hsiang, Tao Yuan Hsien, Taiwan, R.O.C.

SPORTON INTERNATIONAL INC.

TEL : 886-3-327-3456

FAX : 886-3-328-4978

FCC ID : IHDT56QA1

Page Number : 1 of 50

Report Issued Date : Jul. 11, 2014

Report Version : Rev. 01

Report Template No.: BU5-FR15CBT4.0 Version 1.0



TABLE OF CONTENTS

REVISION HISTORY 3

SUMMARY OF TEST RESULT 4

1 GENERAL DESCRIPTION..... 5

 1.1 Applicant 5

 1.2 Manufacturer..... 5

 1.3 Product Feature of Equipment Under Test..... 5

 1.4 Product Specification subjective to this standard 6

 1.5 Modification of EUT 6

 1.6 Testing Location 6

 1.7 Applicable Standards..... 7

2 TEST CONFIGURATION OF EQUIPMENT UNDER TEST..... 8

 2.1 Descriptions of Test Mode 8

 2.2 Test Mode..... 9

 2.3 Connection Diagram of Test System..... 10

 2.4 Support Unit used in test configuration and system 11

 2.5 EUT Operation Test Setup 11

 2.6 Measurement Results Explanation Example..... 11

3 TEST RESULT 12

 3.1 6dB and 99% Bandwidth Measurement 12

 3.2 Peak Output Power Measurement 17

 3.3 Power Spectral Density Measurement 19

 3.4 Conducted Band Edges and Spurious Emission Measurement 25

 3.5 Radiated Band Edges and Spurious Emission Measurement 34

 3.6 AC Conducted Emission Measurement..... 43

 3.7 Antenna Requirements 48

4 LIST OF MEASURING EQUIPMENT..... 49

5 UNCERTAINTY OF EVALUATION..... 50



SUMMARY OF TEST RESULT

Report Section	FCC Rule	Description	Limit	Result	Remark
3.1	15.247(a)(2)	6dB Bandwidth	$\geq 0.5\text{MHz}$	Pass	-
3.1	-	99% Bandwidth	-	Pass	-
3.2	15.247(b)(1)	Peak Output Power	$\leq 30\text{dBm}$	Pass	-
3.3	15.247(e)	Power Spectral Density	$\leq 8\text{dBm}$	Pass	-
3.4	15.247(d)	Conducted Band Edges and Spurious Emission	$\leq 20\text{dBc}$	Pass	-
3.5	15.247(d)	Radiated Band Edges and Spurious Emission	15.209(a) & 15.247(d)	Pass	Under limit 2.49 dB at 2483.500 MHz
3.6	15.207	AC Conducted Emission	15.207(a)	Pass	Under limit 17.00 dB at 3.150 MHz
3.7	15.203 & 15.247(b)	Antenna Requirement	N/A	Pass	-



1 General Description

1.1 Applicant

Motorola Mobility, LLC

222 W Merchandise Mart Plaza, Suite 1800, Chicago, IL 60654, United States

1.2 Manufacturer

Motorola Mobility, LLC

222 W Merchandise Mart Plaza, Suite 1800, Chicago, IL 60654, United States

1.3 Product Feature of Equipment Under Test

Product Feature	
Equipment	Mobile Cellular Phone
Brand Name	Motorola Mobility, LLC
FCC Model Name	3578
FCC ID	IHDT56QA1
IMEI Code	359279050020145
EUT supports Radios application	GSM/EGPRS/WCDMA/HSPA/LTE/NFC WLAN 11b/g/n HT20 WLAN 11a/n HT20/HT40 WLAN 11ac VHT20/VHT40/VHT80 Bluetooth v3.0 + EDR Bluetooth v4.0 - LE
HW Version	P2
SW Version	KXE21.99.169
EUT Stage	Identical Prototype

Remark: The above EUT's information was declared by manufacturer. Please refer to the specifications or user's manual for more detailed description.

Accessory List	
AC Adapter	Brand Name : Motorola
	Model Name : SPN5788A
Earphone	Brand Name : Motorola
	Model Name : SJYN1305A



1.4 Product Specification subjective to this standard

Product Specification subjective to this standard	
Tx/Rx Frequency Range	2402 MHz ~ 2480 MHz
Number of Channels	40
Carrier Frequency of Each Channel	40 Channel(37 hopping + 3 advertising channel)
Maximum Output Power to Antenna	2.94 dBm (0.0020 W)
99% Occupied Bandwidth	1.06MHz
Antenna Type	Fixed Internal Antenna Type with gain 0.00 dBi
Type of Modulation	Bluetooth LE : GFSK

1.5 Modification of EUT

No modifications are made to the EUT during all test items.

1.6 Testing Location

Sporton Lab is accredited to ISO 17025 by Taiwan Accreditation Foundation (TAF code : 1190) and the FCC designation No. TW1022 under the FCC 2.948(e) by Mutual Recognition Agreement (MRA) in FCC Test.

Test Site	SPORTON INTERNATIONAL INC.		
Test Site Location	No. 52, Hwa Ya 1 st Rd., Hwa Ya Technology Park, Kwei-Shan Hsiang, Tao Yuan Hsien, Taiwan, R.O.C. TEL: +886-3-327-3456 FAX: +886-3-328-4978		
Test Site No.	Sporton Site No.		
	TH02-HY	CO05-HY	03CH06-HY



1.7 Applicable Standards

According to the specifications of the manufacturer, the EUT must comply with the requirements of the following standards:

- ♦ FCC Part 15 Subpart C §15.247
- ♦ FCC KDB Publication No. 558074 D01 DTS Meas. Guidance v03r02
- ♦ ANSI C63.4-2003

Remark:

1. All test items were verified and recorded according to the standards and without any deviation during the test.
2. This EUT has also been tested and complied with the requirements of FCC Part 15, Subpart B, recorded in a separate test report.



2 Test Configuration of Equipment Under Test

2.1 Descriptions of Test Mode

The RF output power was recorded in the following table:

Channel	Frequency	Bluetooth 4.0 – LE RF Output Power	
		Data Rate / Modulation	
		GFSK	
		1Mbps	
Ch00	2402MHz	2.01 dBm	
Ch19	2440MHz	2.94 dBm	
Ch39	2480MHz	1.61 dBm	

Channel	Frequency	Bluetooth 4.0 – Average Power	
		Data Rate / Modulation	
		GFSK	
		1Mbps	
Ch00	2402MHz	1.44 dBm	
Ch19	2440MHz	2.48 dBm	
Ch39	2480MHz	1.05 dBm	

- a. The EUT has been associated with peripherals and configuration operated in a manner tended to maximize its emission characteristics in a typical application. Frequency range investigated: conduction (150 kHz to 30 MHz), radiation (9 kHz to the 10th harmonic of the highest fundamental frequency or to 40 GHz, whichever is lower). Pre-scanned tests, X, Y, Z in three orthogonal panels to determine the final configuration (Y plane as worst plane) from all possible combinations.

- b. AC power line Conducted Emission was tested under maximum output power.



2.2 Test Mode

The following summary table is showing all test modes to demonstrate in compliance with the standard.

Summary table of Test Cases	
Test Item	Data Rate / Modulation
	Bluetooth 4.0 – LE / GFSK
Conducted TCs	Mode 1: Bluetooth Tx CH00_2402 MHz_1Mbps Mode 2: Bluetooth Tx CH19_2440 MHz_1Mbps Mode 3: Bluetooth Tx CH39_2480 MHz_1Mbps
Radiated TCs	Mode 1: Bluetooth Tx CH00_2402 MHz_1Mbps Mode 2: Bluetooth Tx CH19_2440 MHz_1Mbps Mode 3: Bluetooth Tx CH39_2480 MHz_1Mbps
AC Conducted Emission	Mode 1: GSM850 Idle + Bluetooth Link + WLAN (2.4GHz) Link + USB Cable (Charging from Adapter) + Battery + Earphone + MP3

2.3 Connection Diagram of Test System

<Bluetooth 4.0 – LE Tx Mode>

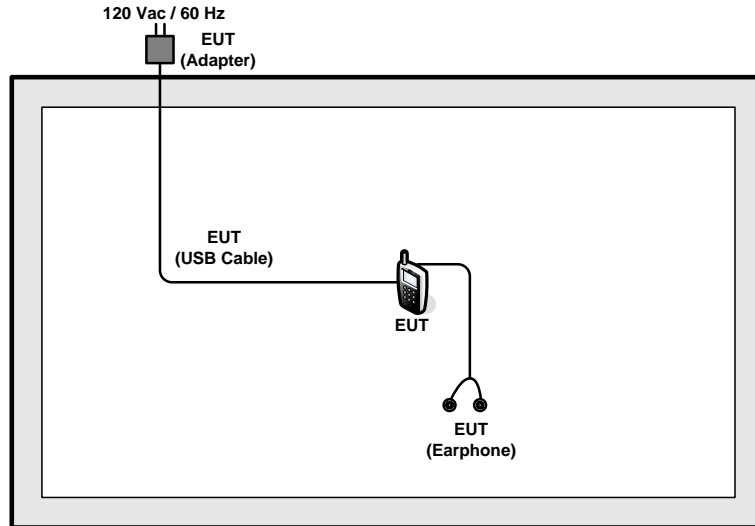

<AC Conducted Emission Mode>

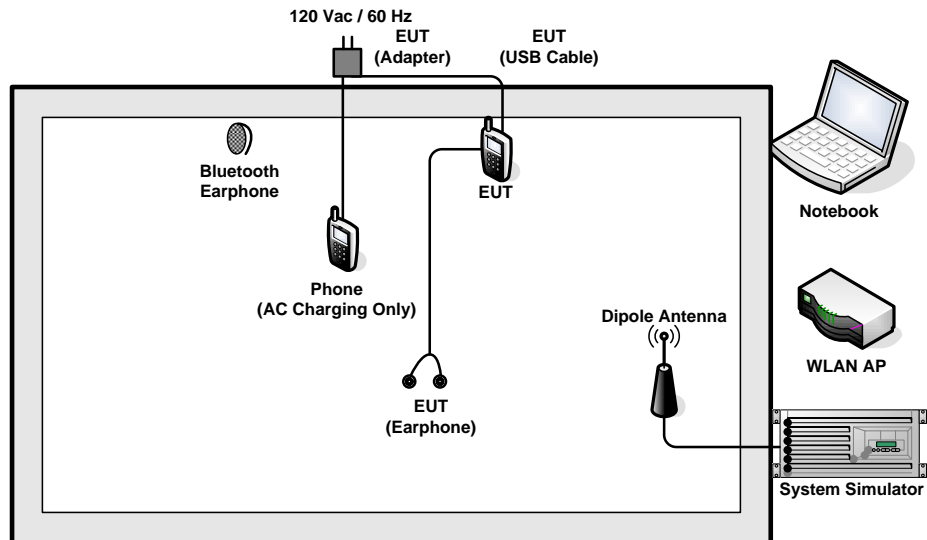



2.4 Support Unit used in test configuration and system

Item	Equipment	Trade Name	Model Name	FCC ID	Data Cable	Power Cord
1.	System Simulator	R&S	CMU 200	N/A	N/A	Unshielded, 1.8 m
2.	Bluetooth Earphone	Sony Ericsson	MW600	PY7DDA-2029	N/A	N/A
3.	WLAN AP	D-Link	DIR-628	KA2DIR628A2	N/A	Unshielded, 1.8 m
4.	Notebook	DELL	Latitude E6320	FCC DoC/ Contains FCC ID: QDS-BRCM1054	N/A	AC I/P: Unshielded, 1.2 m DC O/P: Shielded, 1.8 m

2.5 EUT Operation Test Setup

For WLAN RF test items, an engineering test program was provided and enabled to make EUT transmitting and receiving signals.

2.6 Measurement Results Explanation Example

For all conducted test items:

The offset level is set in the spectrum analyzer to compensate the RF cable loss and attenuator factor between EUT conducted output port and spectrum analyzer. With the offset compensation, the spectrum analyzer reading level is exactly the EUT RF output level.

Example :

The spectrum analyzer offset is derived from RF cable loss and attenuator factor.

Offset = RF cable loss + attenuator factor.

Following shows an offset computation example with cable loss 4.2 dB and 10dB attenuator.

$$\begin{aligned}
 \text{Offset(dB)} &= \text{RF cable loss(dB)} + \text{attenuator factor(dB)}. \\
 &= 4.2 + 10 = 14.2 \text{ (dB)}
 \end{aligned}$$

3 Test Result

3.1 6dB and 99% Bandwidth Measurement

3.1.1 Limit of 6dB and 99% Bandwidth

The minimum 6 dB bandwidth shall be at least 500 kHz.

3.1.2 Measuring Instruments

The section 4.0 of List of Measuring Equipment of this test report is used for test.

3.1.3 Test Procedures

1. The testing follows FCC KDB Publication No. 558074 D01 DTS Meas. Guidance v03r02.
2. The RF output of EUT was connected to the spectrum analyzer by RF cable and attenuator. The path loss was compensated to the results for each measurement.
3. Set to the maximum power setting and enable the EUT transmit continuously.
4. Make the measurement with the spectrum analyzer's resolution bandwidth (RBW) = 100 kHz. Set the Video bandwidth (VBW) = 300 kHz. In order to make an accurate measurement. The 6 dB bandwidth must be greater than 500 kHz.
5. For 99% Bandwidth Measurement, the spectrum analyzer's resolution bandwidth (RBW) is set 30kHz and set the Video bandwidth (VBW) = 100kHz.
6. Measure and record the results in the test report.

3.1.4 Test Setup





3.1.5 Test Result of 6dB Bandwidth

Test Mode :	Bluetooth 4.0 - LE	Temperature :	22~25°C
Test Engineer :	Alex Lee and Bill Kuo	Relative Humidity :	51~55%

Channel	Frequency (MHz)	6dB Bandwidth (MHz)	6dB Bandwidth Min. Limit (MHz)	Pass/Fail
00	2402	0.66	0.5	Pass
19	2440	0.66	0.5	Pass
39	2480	0.66	0.5	Pass

6 dB Bandwidth Plot on Channel 00

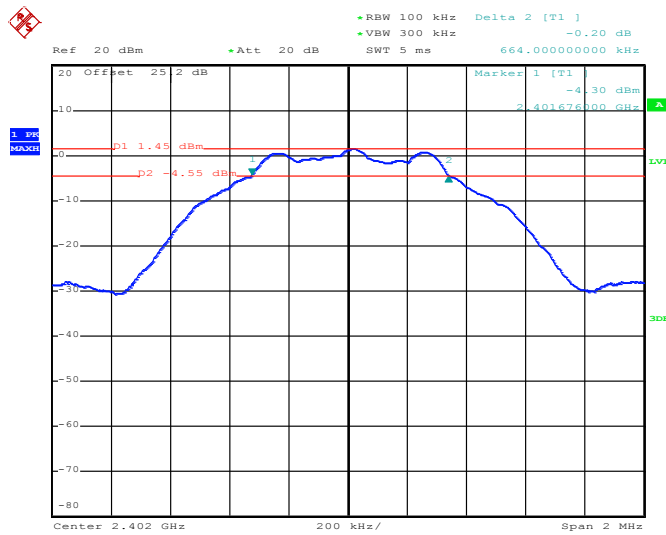

Date: 10.MAY.2014 12:03:49



6 dB Bandwidth Plot on Channel 19

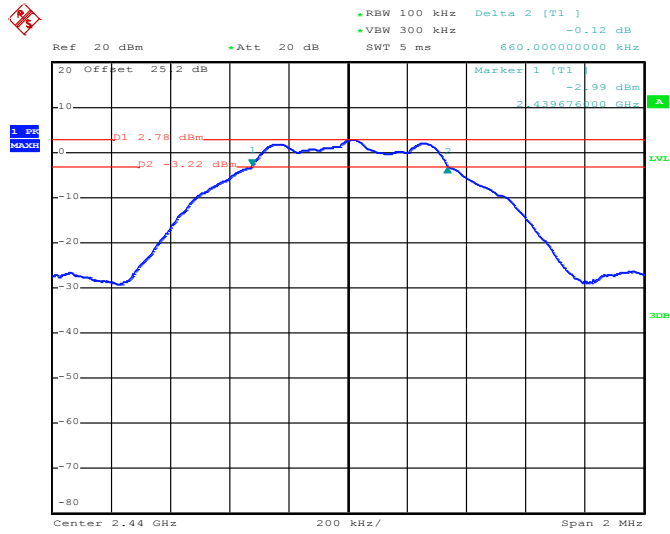

Date: 10.MAY.2014 12:00:17

6 dB Bandwidth Plot on Channel 39

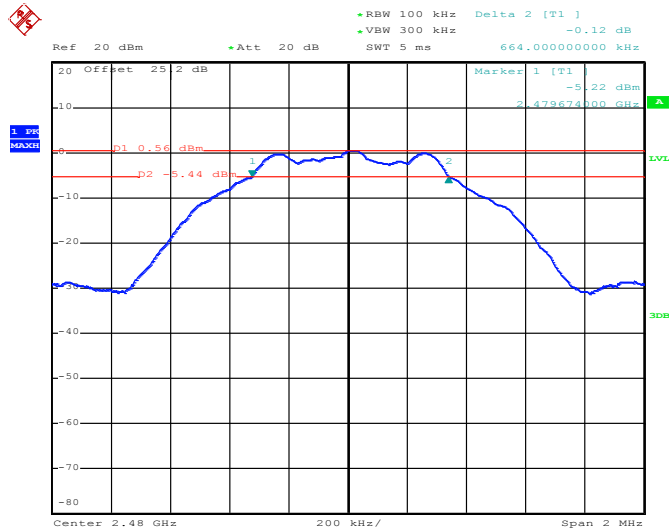

Date: 10.MAY.2014 12:06:20



3.1.6 Test Result of 99% Occupied Bandwidth

Test Mode :	Bluetooth 4.0 - LE	Temperature :	22~25°C
Test Engineer :	Alex Lee and Bill Kuo	Relative Humidity :	51~55%

Channel	Frequency (MHz)	99% Occupied Bandwidth (MHz)
00	2402	1.06
19	2440	1.06
39	2480	1.06

99% Bandwidth Plot on Channel 00

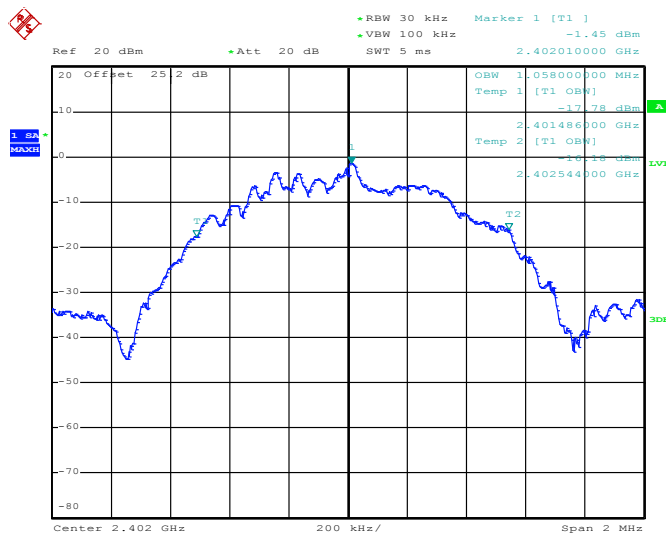

Date: 10.MAY.2014 12:05:20



99% Occupied Bandwidth Plot on Channel 19

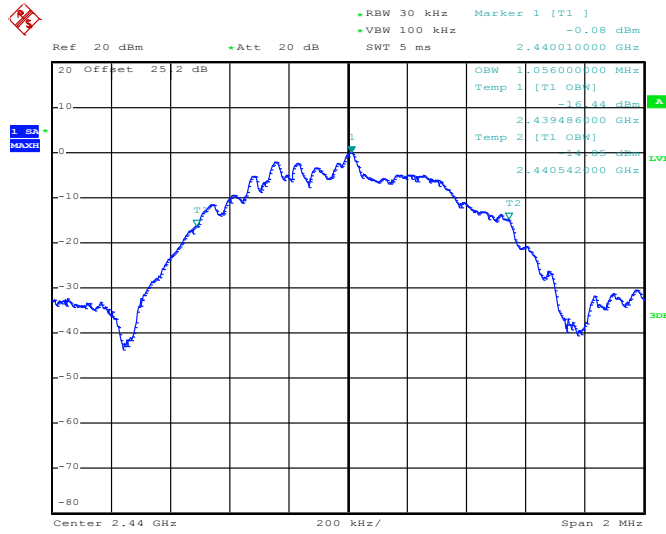

Date: 10.MAY.2014 12:00:57

99% Occupied Bandwidth Plot on Channel 39

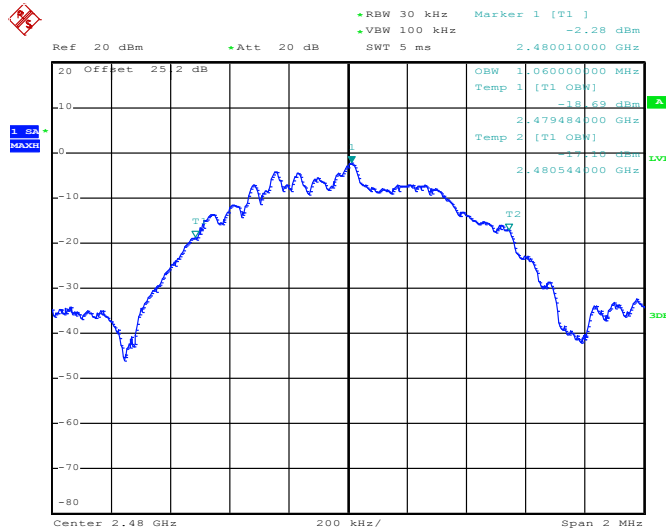

Date: 10.MAY.2014 12:07:50

Note: The occupied channel bandwidth is maintained within the band of operation for all of the modulations.

3.2 Peak Output Power Measurement

3.2.1 Limit of Peak Output Power

For systems using digital modulation in the 2400-2483.5MHz, the limit for peak output power is 30dBm. If transmitting antenna of directional gain greater than 6dBi is used, the peak output power from the intentional radiator shall be reduced below the above stated value by the amount in dB that the directional gain of the antenna exceeds 6 dBi. In case of point-to-point operation, the limit has to be reduced by 1dB for every 3dB that the directional gain of the antenna exceeds 6dBi.

3.2.2 Measuring Instruments

The section 4.0 of List of Measuring Equipment of this test report is used for test.

3.2.3 Test Procedures

1. The testing follows the Measurement Procedure of FCC KDB No. 558074 DTS D01 Meas. Guidance v03r02.
2. The RF output of EUT was connected to the power meter by RF cable and attenuator. The path loss was compensated to the results for each measurement.
3. Set to the maximum power setting and enable the EUT transmit continuously.
4. Measure the conducted output power and record the results in the test report.

3.2.4 Test Setup

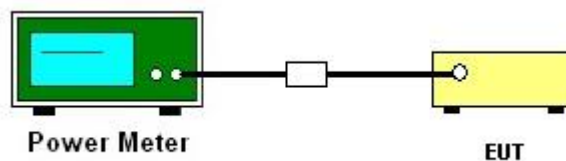



3.2.5 Test Result of Peak Output Power

Test Mode :	Bluetooth 4.0 - LE	Temperature :	22~25°C
Test Engineer :	Alex Lee and Bill Kuo	Relative Humidity :	51~55%

Channel	Frequency (MHz)	RF Power (dBm)		
		GFSK	Max. Limits (dBm)	Pass/Fail
		1 Mbps		
00	2402	2.01	30.00	Pass
19	2440	2.94	30.00	Pass
39	2480	1.61	30.00	Pass

3.3 Power Spectral Density Measurement

3.3.1 Limit of Power Spectral Density

The peak power spectral density shall not be greater than 8dBm in any 3kHz band at any time interval of continuous transmission.

3.3.2 Measuring Instruments

The section 4.0 of List of Measuring Equipment of this test report is used for test.

3.3.3 Test Procedures

1. The testing follows Measurement Procedure 10.2 Method PKPSD of FCC KDB Publication No. 558074 D01 DTS Meas. Guidance v03r02
2. The RF output of EUT was connected to the spectrum analyzer by RF cable and attenuator. The path loss was compensated to the results for each measurement.
3. Set to the maximum power setting and enable the EUT transmit continuously.
4. Make the measurement with the spectrum analyzer's resolution bandwidth (RBW) = 3 kHz. Video bandwidth VBW = 10 kHz In order to make an accurate measurement, set the span to 1.5 times DTS Channel Bandwidth. (6dB BW)
5. Detector = peak, Sweep time = auto couple, Trace mode = max hold, Allow trace to fully stabilize. Use the peak marker function to determine the maximum power level.
6. Measure and record the results in the test report.
7. The Measured power density (dBm)/ 100kHz is a reference level and used as 20dBc down limit line for Conducted Band Edges and Conducted Spurious Emission.

3.3.4 Test Setup

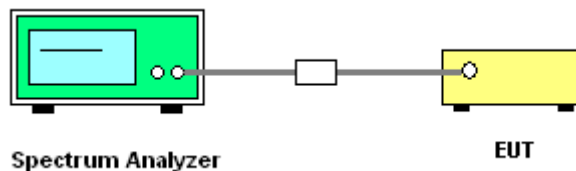



3.3.5 Test Result of Power Spectral Density

Test Mode :	Bluetooth 4.0 - LE	Temperature :	22~25°C
Test Engineer :	Alex Lee and Bill Kuo	Relative Humidity :	51~55%

Channel	Frequency (MHz)	Power Density		Max. Limits (dBm/3kHz)	Pass/Fail
		PSD/100kHz (dBm)	PSD/3kHz (dBm)		
00	2402	1.45	-13.87	8	Pass
19	2440	2.76	-12.43	8	Pass
39	2480	0.56	-14.63	8	Pass

Note:

1. Measured power density (dBm) has offset with cable loss.
2. The Measured power density (dBm)/ 100kHz is reference level and used as 20dBc down for Conducted Band Edges and Conducted Spurious Emission limit line.



3.3.6 Test Result of Power Spectral Density Plots (100kHz)

PSD 100kHz Plot on Channel 00

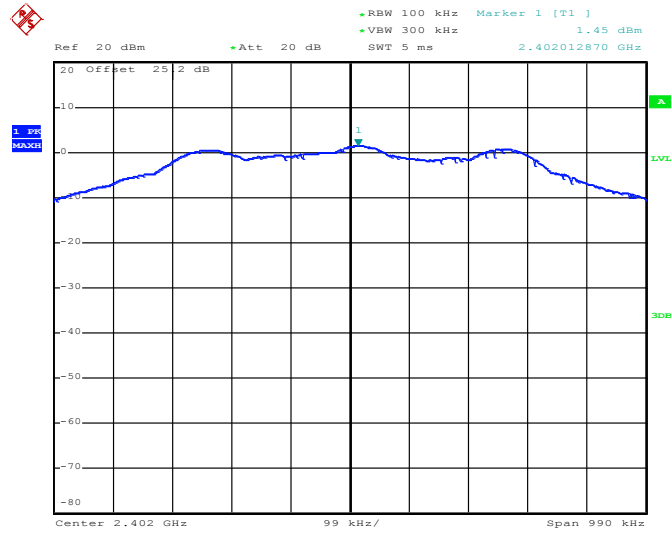

Date: 10.MAY.2014 12:04:17



PSD 100kHz Plot on Channel 19

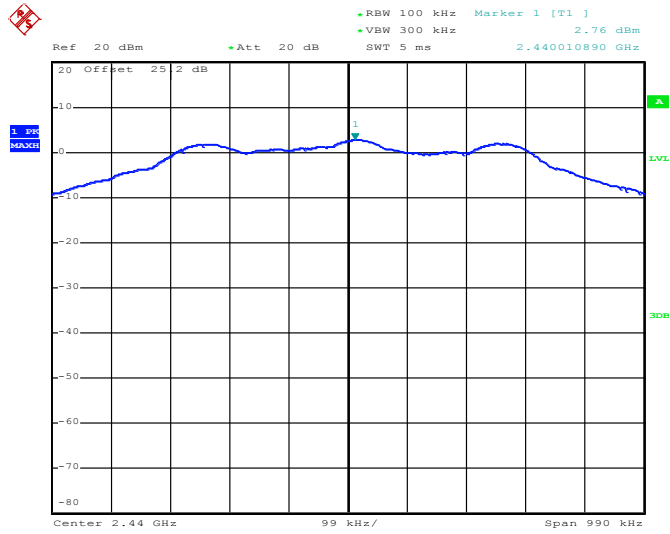

Date: 10.MAY.2014 12:00:45

PSD 100kHz Plot on Channel 39

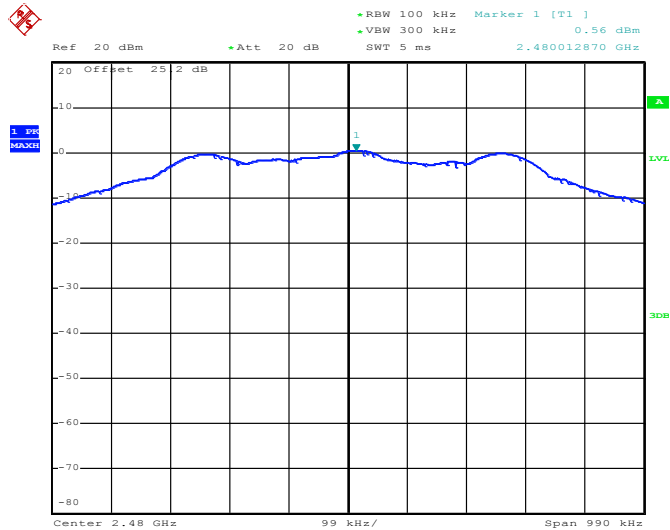

Date: 10.MAY.2014 12:06:48



3.3.7 Test Result of Power Spectral Density Plots (3kHz)

PSD 3kHz Plot on Channel 00

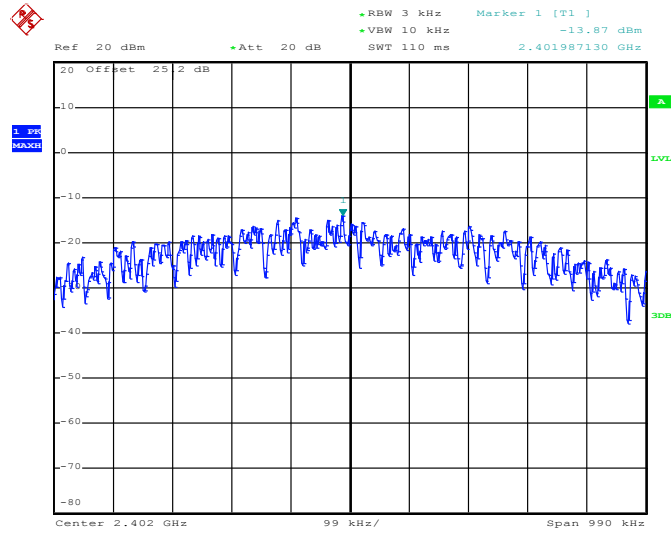

Date: 10.MAY.2014 12:04:09



PSD 3kHz Plot on Channel 19

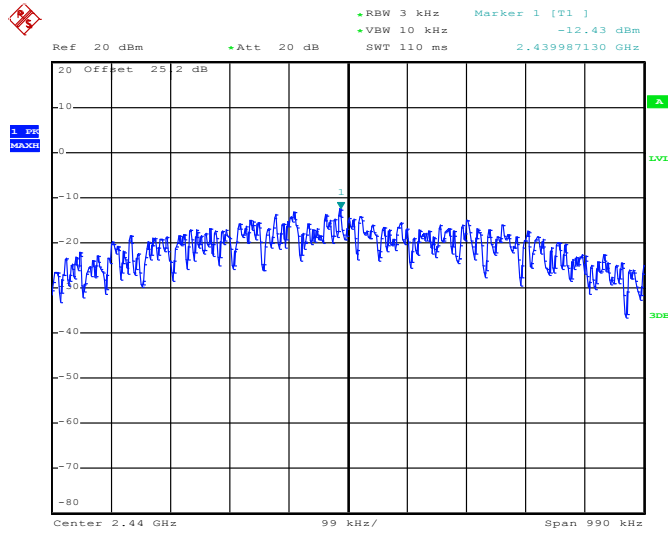

Date: 10.MAY.2014 12:00:37

PSD 3kHz Plot on Channel 39

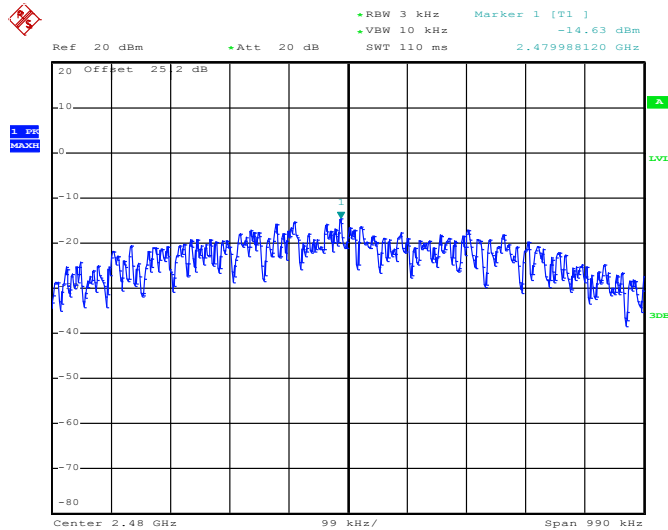

Date: 10.MAY.2014 12:06:39

3.4 Conducted Band Edges and Spurious Emission Measurement

3.4.1 Limit of Conducted Band Edges and Spurious Emission

All harmonics/spurious must be at least 20 dB down from the highest emission level within the authorized band.

3.4.2 Measuring Instruments

The section 4.0 of List of Measuring Equipment of this test report is used for test.

3.4.3 Test Procedure

1. The testing follows FCC KDB Publication No. 558074 D01 DTS Meas. Guidance v03r02.
2. The RF output of EUT was connected to the spectrum analyzer by RF cable and attenuator. The path loss was compensated to the results for each measurement.
3. Set to the maximum power setting and enable the EUT transmit continuously.
4. Set RBW = 100 kHz, VBW=300 kHz, Peak Detector. Unwanted Emissions measured in any 100 kHz bandwidth outside of the authorized frequency band shall be attenuated by at least 20 dB relative to the maximum in-band peak PSD level in 100 kHz when maximum peak conducted output power procedure is used. If the transmitter complies with the conducted power limits based on the use of RMS averaging over a time interval, the attenuation required under this paragraph shall be 30 dB instead of 20 dB per 15.247(d).
5. Measure and record the results in the test report.
6. The RF fundamental frequency should be excluded against the limit line in the operating frequency band.

3.4.4 Test Setup





3.4.5 Test Result of Conducted Band Edges

Test Mode :	Bluetooth 4.0 - LE	Temperature :	22~25°C
Test Channel :	00 and 39	Relative Humidity :	51~55%
		Test Engineer :	Alex Lee and Bill Kuo

Low Band Edge Plot on Channel 00

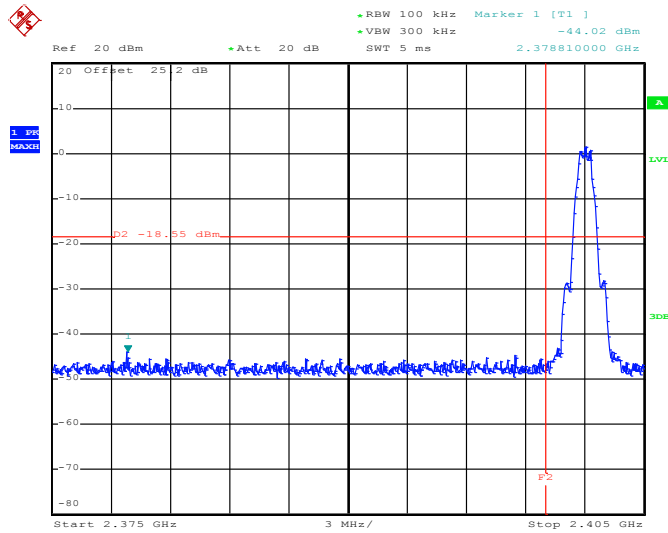

Date: 10.MAY.2014 12:04:31



High Band Edge Plot on Channel 39

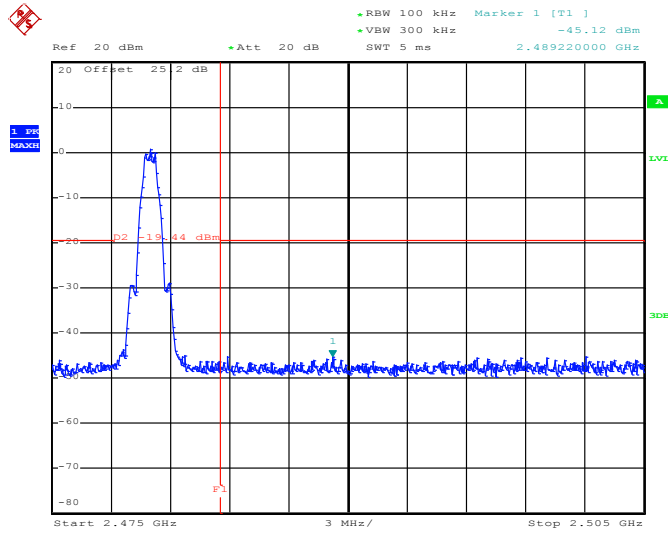

Date: 10.MAY.2014 12:07:02



3.4.6 Test Result of Conducted Spurious Emission

Test Mode :	Bluetooth 4.0 - LE	Temperature :	22~25°C
Test Channel :	00	Relative Humidity :	51~55%
		Test Engineer :	Alex Lee and Bill Kuo

Conducted Spurious Emission Plot on Bluetooth LE 1Mbps GFSK Channel 00

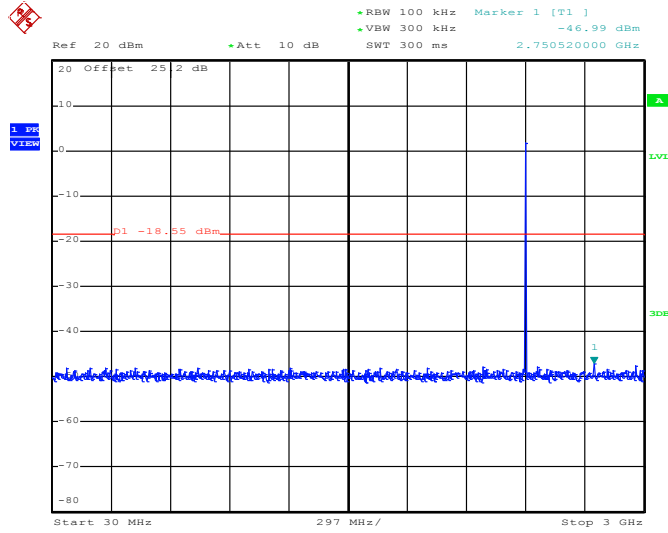

Date: 10.MAY.2014 12:04:50



Conducted Spurious Emission Plot on Bluetooth LE 1Mbps
GFSK Channel 00

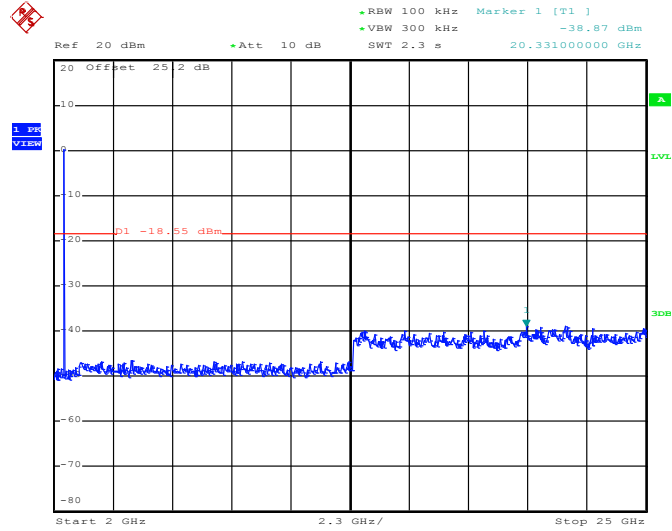

Date: 10.MAY.2014 12:05:09



Test Mode :	Bluetooth 4.0 - LE	Temperature :	22~25°C
Test Channel :	19	Relative Humidity :	51~55%
		Test Engineer :	Alex Lee and Bill Kuo

Conducted Spurious Emission Plot on Bluetooth LE 1Mbps
GFSK Channel 19

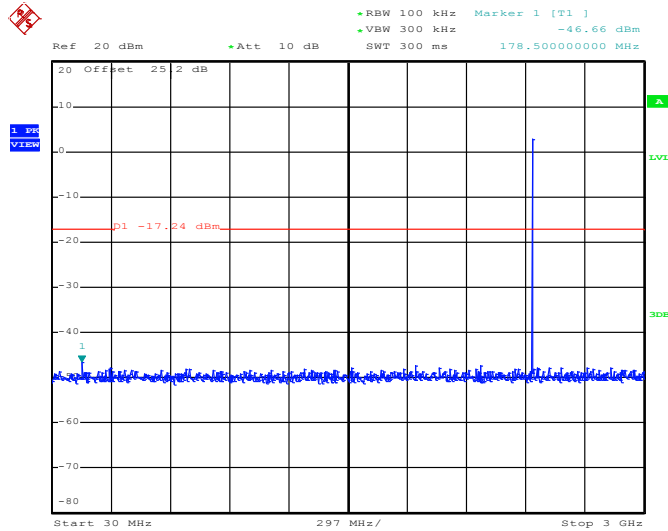

Date: 10.MAY.2014 12:01:38



Test Mode :	Bluetooth 4.0 - LE	Temperature :	22~25°C
Test Channel :	39	Relative Humidity :	51~55%
		Test Engineer :	Alex Lee and Bill Kuo

Conducted Spurious Emission Plot on Bluetooth LE 1Mbps
GFSK Channel 39

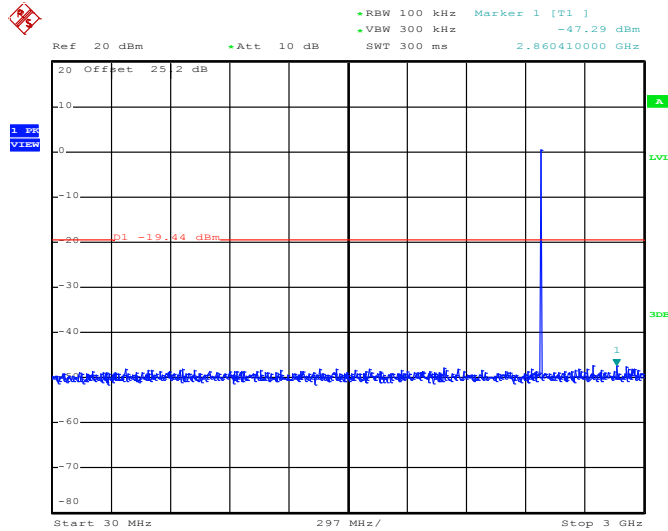

Date: 10.MAY.2014 12:07:21



Conducted Spurious Emission Plot on Bluetooth LE 1Mbps
GFSK Channel 39

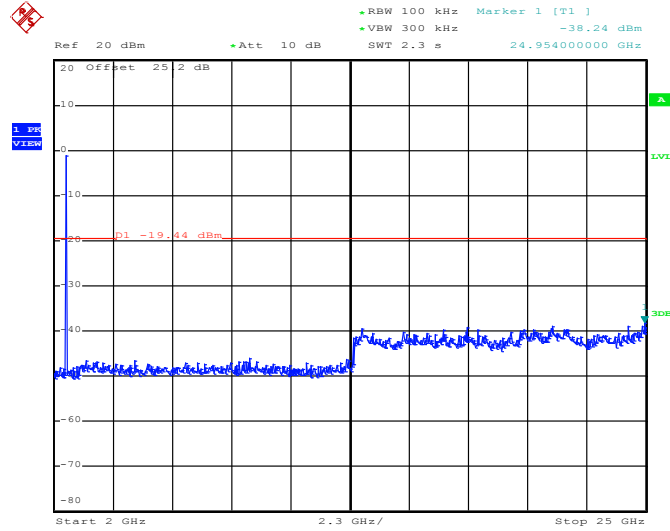

Date: 10.MAY.2014 12:07:40



3.5 Radiated Band Edges and Spurious Emission Measurement

3.5.1 Limit of Radiated Band Edges and Spurious Emission

In any 100 kHz bandwidth outside the intentional radiator frequency band, all harmonics/spurious must be at least 20 dB below the highest emission level within the authorized band. If the output power of this device was measured by spectrum analyzer, the attenuation under this paragraph shall be 30 dB instead of 20 dB. In addition, radiated emissions which fall in the restricted bands must also comply with the FCC section 15.209 limits as below.

Frequency (MHz)	Field Strength (microvolts/meter)	Measurement Distance (meters)
0.009 – 0.490	2400/F(kHz)	300
0.490 – 1.705	24000/F(kHz)	30
1.705 – 30.0	30	30
30 – 88	100	3
88 – 216	150	3
216 - 960	200	3
Above 960	500	3

3.5.2 Measuring Instruments

The section 4.0 of List of Measuring Equipment of this test report is used for test.



3.5.3 Test Procedures

1. The testing follows FCC KDB Publication No. 558074 D01 DTS Meas. Guidance v03r02.
2. The EUT was arranged to its worst case and then tune the antenna tower (from 1 m to 4 m) and turntable (from 0 degree to 360 degrees) to find the maximum reading. A pre-amp and a high pass filter are used for the test in order to get better signal level.
3. The EUT was placed on a turntable with 0.8 meter above ground.
4. The EUT was set 3 meters from the interference receiving antenna, which was mounted on the top of a variable height antenna tower.
5. Corrected Reading: Antenna Factor + Cable Loss + Read Level - Preamp Factor = Level
6. For measurement below 1GHz, If the emission level of the EUT measured by the peak detector is 3 dB lower than the applicable limit, the peak emission level will be reported. Otherwise, the emission measurement will be repeated using the quasi-peak detector and reported.
7. Use the following spectrum analyzer settings:
 - (1) Span shall wide enough to fully capture the emission being measured;
 - (2) Set RBW=100 kHz for $f < 1$ GHz; $VBW \geq RBW$; Sweep = auto; Detector function = peak; Trace = max hold;
 - (3) Set RBW = 1 MHz, VBW= 3MHz for $f \geq 1$ GHz for peak measurement.

For average measurement:

 - $VBW = 10$ Hz, when duty cycle is no less than 98 percent.
 - $VBW \geq 1/T$, when duty cycle is less than 98 percent where T is the minimum transmission duration over which the transmitter is on and is transmitting at its maximum power control level for the tested mode of operation.

Band	Duty Cycle(%)	T(μs)	1/T(kHz)	VBW Setting
Bluetooth 4.0 - LE	62.42	392	2.55	3kHz

3.5.4 Test Setup

For radiated emissions below 30MHz

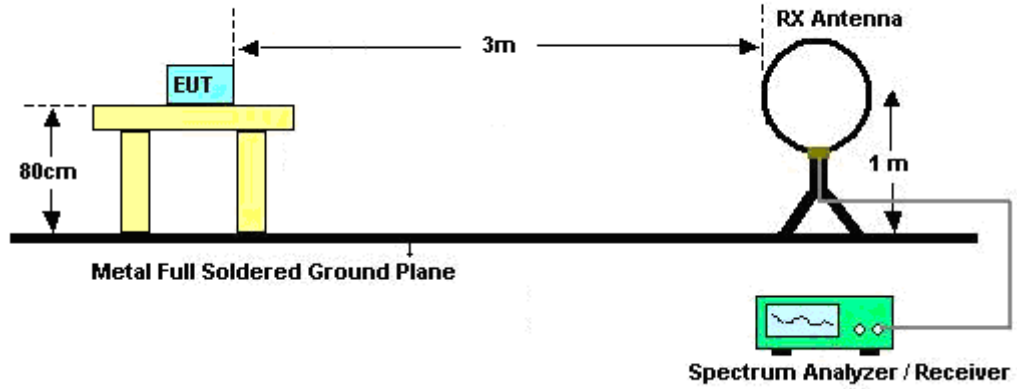

For radiated emissions from 30MHz to 1GHz

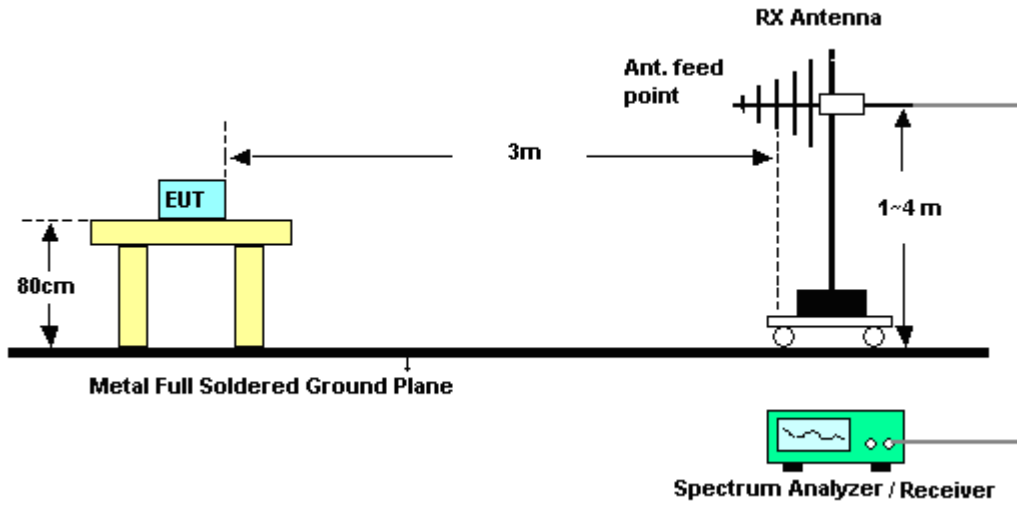

For radiated emissions above 1GHz

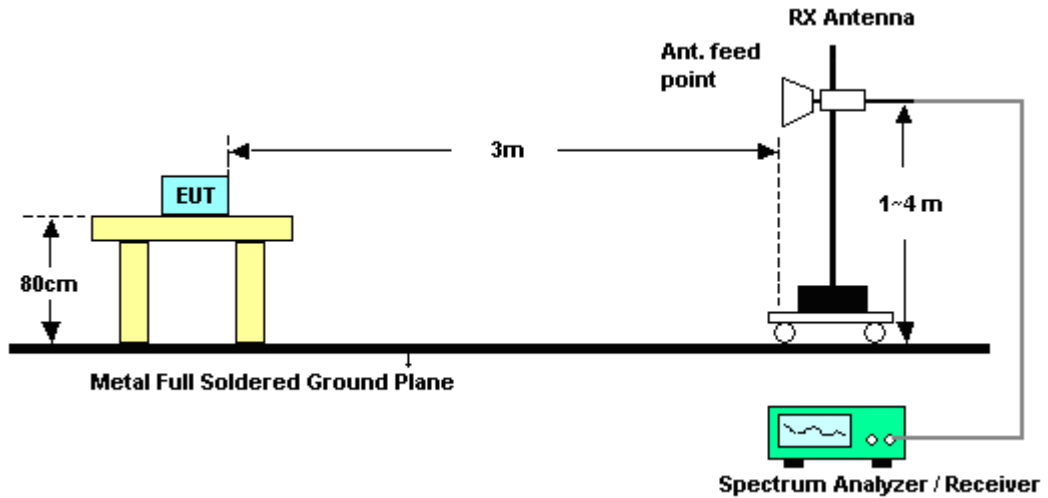

3.5.5 Test Results of Radiated Spurious Emissions (9 kHz ~ 30 MHz)

The low frequency, which started from 9 kHz to 30MHz, was pre-scanned and the result which was 20dB lower than the limit line per 15.31(o) was not reported.



3.5.6 Test Result of Radiated Spurious at Band Edges

Test Mode :	Mode 1	Temperature :	22~23°C
Test Channel :	00	Relative Humidity :	52~53%
		Test Engineer :	Hayden Wu

ANTENNA POLARITY : HORIZONTAL										
Frequency (MHz)	Level (dBμV /m)	Over Limit (dB)	Limit Line (dBμV /m)	Read Level (dBμV)	Antenna Factor (dB)	Cable Loss (dB)	Preamp Factor (dB)	Ant Pos (cm)	Table Pos (deg)	Remark
2364	48.87	-25.13	74	45.21	31.89	6.42	34.65	100	205	Peak
2388.3	37.79	-16.21	54	34.07	31.92	6.45	34.65	100	205	Average

ANTENNA POLARITY : VERTICAL										
Frequency (MHz)	Level (dBμV /m)	Over Limit (dB)	Limit Line (dBμV /m)	Read Level (dBμV)	Antenna Factor (dB)	Cable Loss (dB)	Preamp Factor (dB)	Ant Pos (cm)	Table Pos (deg)	Remark
2366.43	48.74	-25.26	74	45.08	31.89	6.42	34.65	106	345	Peak
2361.75	37.89	-16.11	54	34.23	31.89	6.42	34.65	106	345	Average

Test Mode :	Mode 3	Temperature :	22~23°C
Test Channel :	39	Relative Humidity :	52~53%
		Test Engineer :	Hayden Wu

ANTENNA POLARITY : HORIZONTAL										
Frequency (MHz)	Level (dBμV /m)	Over Limit (dB)	Limit Line (dBμV /m)	Read Level (dBμV)	Antenna Factor (dB)	Cable Loss (dB)	Preamp Factor (dB)	Ant Pos (cm)	Table Pos (deg)	Remark
2483.5	53.31	-20.69	74	49.36	31.99	6.59	34.63	100	323	Peak
2483.5	47.77	-6.23	54	43.82	31.99	6.59	34.63	100	323	Average

ANTENNA POLARITY : VERTICAL										
Frequency (MHz)	Level (dBμV /m)	Over Limit (dB)	Limit Line (dBμV /m)	Read Level (dBμV)	Antenna Factor (dB)	Cable Loss (dB)	Preamp Factor (dB)	Ant Pos (cm)	Table Pos (deg)	Remark
2483.5	56.33	-17.67	74	52.38	31.99	6.59	34.63	100	334	Peak
2483.5	51.51	-2.49	54	47.56	31.99	6.59	34.63	100	334	Average



3.5.7 Test Result of Radiated Spurious Emission (30MHz ~ 10th Harmonic)

Note: Pre-scanned all test modes and only choose the worst case mode recorded in the test report for radiated spurious emission below 1GHz.

Test Mode :	Mode 1	Temperature :	22~23°C
Test Channel :	00	Relative Humidity :	52~53%
Test Engineer :	Hayden Wu	Polarization :	Horizontal
Remark :	1. 2402 MHz is fundamental signal which can be ignored. 2. Average measurement was not performed if peak level went lower than the average limit.		

Frequency (MHz)	Level (dBμV/m)	Over Limit (dB)	Limit Line (dBμV/m)	Read Level (dBμV)	Antenna Factor (dB)	Cable Loss (dB)	Preamp Factor (dB)	Ant Pos (cm)	Table Pos (deg)	Remark
2402	93.44	-	-	89.71	31.92	6.45	34.64	100	205	Average
2402	94.38	-	-	90.65	31.92	6.45	34.64	100	205	Peak
4803	41	-33	74	57.29	34.41	10.16	60.86	100	0	Peak

Note: Other harmonics are lower than background noise.

Test Mode :	Mode 1	Temperature :	22~23°C
Test Channel :	00	Relative Humidity :	52~53%
Test Engineer :	Hayden Wu	Polarization :	Vertical
Remark :	1. 2402 MHz is fundamental signal which can be ignored. 2. Average measurement was not performed if peak level went lower than the average limit.		

Frequency (MHz)	Level (dBμV/m)	Over Limit (dB)	Limit Line (dBμV/m)	Read Level (dBμV)	Antenna Factor (dB)	Cable Loss (dB)	Preamp Factor (dB)	Ant Pos (cm)	Table Pos (deg)	Remark
2402	96.86	-	-	93.13	31.92	6.45	34.64	106	345	Average
2402	97.86	-	-	94.13	31.92	6.45	34.64	106	345	Peak
4803	41.17	-32.83	74	57.46	34.41	10.16	60.86	100	0	Peak

Note: Other harmonics are lower than background noise.



Test Mode :	Mode 2	Temperature :	22~23°C
Test Channel :	19	Relative Humidity :	52~53%
Test Engineer :	Hayden Wu	Polarization :	Horizontal
Remark :	1. 2440 MHz is fundamental signal which can be ignored. 2. Average measurement was not performed if peak level went lower than the average limit.		

Frequency (MHz)	Level (dBμV/m)	Over Limit (dB)	Limit Line (dBμV/m)	Read Level (dBμV)	Antenna Factor (dB)	Cable Loss (dB)	Preamp Factor (dB)	Ant Pos (cm)	Table Pos (deg)	Remark
2440	96.99	-	-	93.15	31.96	6.52	34.64	100	327	Average
2440	96.33	-	-	92.49	31.96	6.52	34.64	100	327	Peak
4881	41.56	-32.44	74	57.69	34.37	10.19	60.69	100	0	Peak
7320	43.71	-30.29	74	57.7	35.6	10.94	60.53	100	0	Peak

Note: Other harmonics are lower than background noise.

Test Mode :	Mode 2	Temperature :	22~23°C
Test Channel :	19	Relative Humidity :	52~53%
Test Engineer :	Hayden Wu	Polarization :	Vertical
Remark :	1. 2440 MHz is fundamental signal which can be ignored. 2. Average measurement was not performed if peak level went lower than the average limit.		

Frequency (MHz)	Level (dBμV/m)	Over Limit (dB)	Limit Line (dBμV/m)	Read Level (dBμV)	Antenna Factor (dB)	Cable Loss (dB)	Preamp Factor (dB)	Ant Pos (cm)	Table Pos (deg)	Remark
2440	97.74	-	-	93.9	31.96	6.52	34.64	102	346	Average
2440	98.57	-	-	94.73	31.96	6.52	34.64	102	346	Peak
4881	41.6	-32.4	74	57.73	34.37	10.19	60.69	100	0	Peak
7320	43.89	-30.11	74	57.88	35.6	10.94	60.53	100	0	Peak

Note: Other harmonics are lower than background noise.



Test Mode :	Mode 3	Temperature :	22~23°C
Test Channel :	39	Relative Humidity :	52~53%
Test Engineer :	Hayden Wu	Polarization :	Horizontal
Remark :	1. 2480 MHz is fundamental signal which can be ignored. 2. Average measurement was not performed if peak level went lower than the average limit.		

Frequency (MHz)	Level (dBμV/m)	Over Limit (dB)	Limit Line (dBμV/m)	Read Level (dBμV)	Antenna Factor (dB)	Cable Loss (dB)	Preamp Factor (dB)	Ant Pos (cm)	Table Pos (deg)	Remark
97.77	21.66	-21.84	43.5	41.8	10.52	1.09	31.75	-	-	Peak
214.41	27.67	-15.83	43.5	48.69	9.14	1.59	31.75	-	-	Peak
297.84	32.58	-13.42	46	49.24	13.16	1.9	31.72	-	-	Peak
310.5	34.36	-11.64	46	50.75	13.4	1.94	31.73	165	123	Peak
425.3	29.87	-16.13	46	42.67	16.8	2.25	31.85	-	-	Peak
502.3	27.28	-18.72	46	38.9	17.82	2.49	31.93	-	-	Peak
2480	94.01	-	-	90.06	31.99	6.59	34.63	100	323	Average
2480	95.16	-	-	91.21	31.99	6.59	34.63	100	323	Peak
4959	41.56	-32.44	74	57.51	34.32	10.21	60.48	100	0	Peak
7440	43.55	-30.45	74	57.7	35.53	10.9	60.58	100	0	Peak

Note: Other harmonics are lower than background noise.



Test Mode :	Mode 3	Temperature :	22~23°C
Test Channel :	39	Relative Humidity :	52~53%
Test Engineer :	Hayden Wu	Polarization :	Vertical
Remark :	1. 2480 MHz is fundamental signal which can be ignored. 2. Average measurement was not performed if peak level went lower than the average limit.		

Frequency (MHz)	Level (dBμV/m)	Over Limit (dB)	Limit Line (dBμV/m)	Read Level (dBμV)	Antenna Factor (dB)	Cable Loss (dB)	Preamp Factor (dB)	Ant Pos (cm)	Table Pos (deg)	Remark
30	23.79	-16.21	40	36.45	18.5	0.64	31.8	-	-	Peak
45.66	23.13	-16.87	40	44.76	9.38	0.77	31.78	-	-	Peak
98.04	26.65	-16.85	43.5	46.79	10.52	1.09	31.75	-	-	Peak
300.7	27.99	-18.01	46	44.58	13.22	1.91	31.72	-	-	Peak
461	30.51	-15.49	46	42.85	17.22	2.33	31.89	-	-	Peak
528.2	31.25	-14.75	46	42.43	18.27	2.52	31.97	100	126	Peak
2480	97.84	-	-	93.89	31.99	6.59	34.63	100	334	Average
2480	98.96	-	-	95.01	31.99	6.59	34.63	100	334	Peak
4959	42.94	-31.06	74	58.89	34.32	10.21	60.48	100	0	Peak
7440	43.66	-30.34	74	57.81	35.53	10.9	60.58	100	0	Peak

Note: Other harmonics are lower than background noise.



3.6 AC Conducted Emission Measurement

3.6.1 Limit of AC Conducted Emission

For equipment that is designed to be connected to the public utility (AC) power line, the radio frequency voltage that is conducted back onto the AC power line on any frequency or frequencies within the band 150 kHz to 30 MHz shall not exceed the limits in the following table.

Frequency of emission (MHz)	Conducted limit (dB μ V)	
	Quasi-peak	Average
0.15-0.5	66 to 56*	56 to 46*
0.5-5	56	46
5-30	60	50

*Decreases with the logarithm of the frequency.

3.6.2 Measuring Instruments

The section 4.0 of List of Measuring Equipment of this test report is used for test.

3.6.3 Test Procedures

1. The EUT was placed 0.4 meter from the conducting wall of the shielding room was kept at least 80 centimeters from any other grounded conducting surface.
2. Connect EUT to the power mains through a line impedance stabilization network (LISN).
3. All the support units are connecting to the other LISN.
4. The LISN provides 50 ohm coupling impedance for the measuring instrument.
5. The FCC states that a 50 ohm, 50 microhenry LISN should be used.
6. Both sides of AC line were checked for maximum conducted interference.
7. The frequency range from 150 kHz to 30 MHz was searched.
8. Set the test-receiver system to Peak Detect Function and specified bandwidth with Maximum Hold Mode.

3.6.4 Test Setup





3.6.5 Test Result of AC Conducted Emission

Test Mode :	Mode 1	Temperature :	20~22°C
Test Engineer :	Cosmo Xu	Relative Humidity :	45~47%
Test Voltage :	120Vac / 60Hz	Phase :	Line
Function Type :	GSM850 Idle + Bluetooth Link + WLAN (2.4GHz) Link + USB Cable (Charging from Adapter) + Battery + Earphone + MP3		

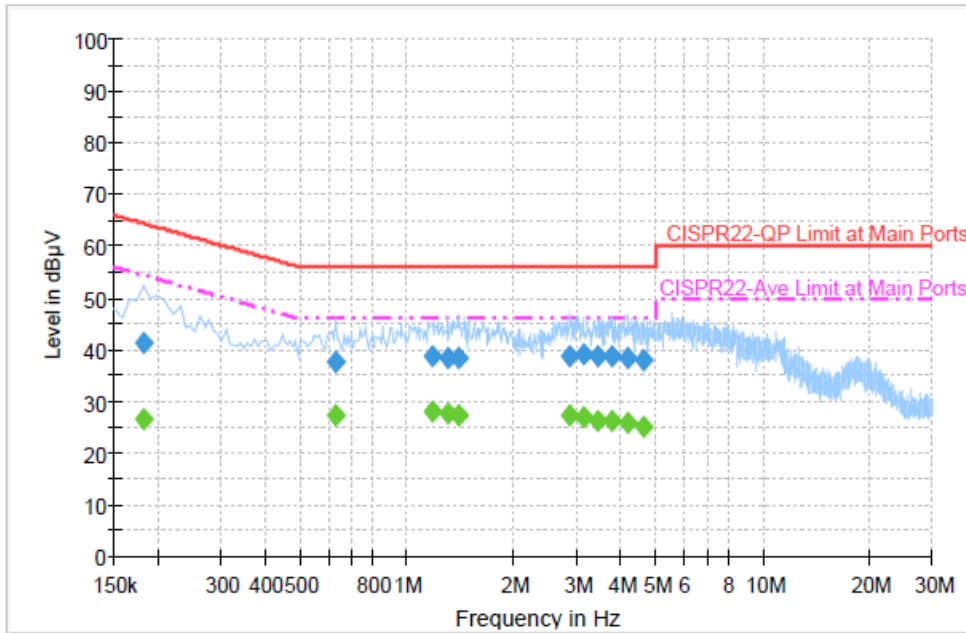

Final Result : Quasi-Peak

Frequency (MHz)	Quasi-Peak (dBµV)	Filter	Line	Corr. (dB)	Margin (dB)	Limit (dBµV)
0.182000	41.2	Off	L1	19.3	23.2	64.4
0.630000	37.6	Off	L1	19.4	18.4	56.0
1.182000	38.6	Off	L1	19.6	17.4	56.0
1.302000	38.5	Off	L1	19.5	17.5	56.0
1.398000	38.2	Off	L1	19.5	17.8	56.0
2.878000	38.7	Off	L1	19.6	17.3	56.0
3.150000	39.0	Off	L1	19.6	17.0	56.0
3.462000	38.7	Off	L1	19.6	17.3	56.0
3.750000	38.6	Off	L1	19.6	17.4	56.0
4.166000	38.4	Off	L1	19.6	17.6	56.0
4.606000	38.1	Off	L1	19.7	17.9	56.0



Test Mode :	Mode 1	Temperature :	20~22°C
Test Engineer :	Cosmo Xu	Relative Humidity :	45~47%
Test Voltage :	120Vac / 60Hz	Phase :	Line
Function Type :	GSM850 Idle + Bluetooth Link + WLAN (2.4GHz) Link + USB Cable (Charging from Adapter) + Battery + Earphone + MP3		

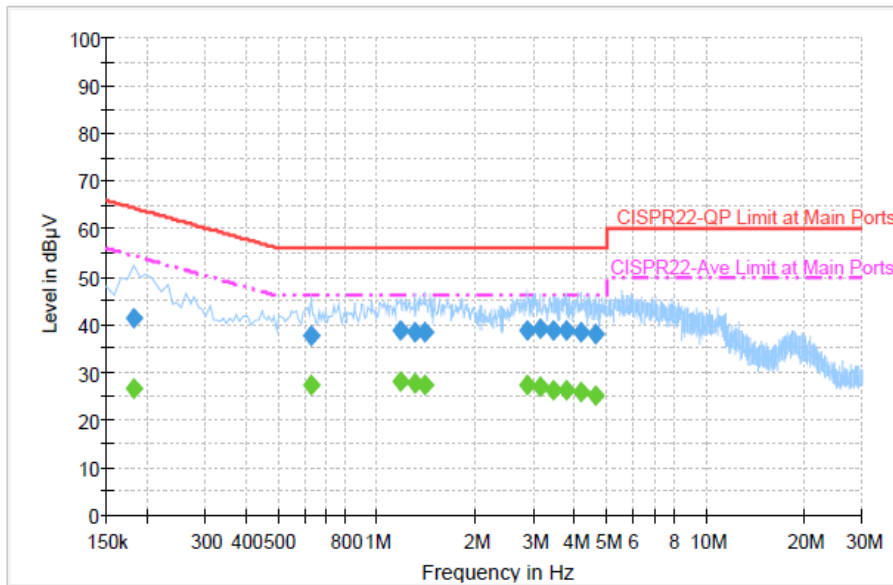

Final Result : Average

Frequency (MHz)	Average (dBµV)	Filter	Line	Corr. (dB)	Margin (dB)	Limit (dBµV)
0.182000	26.7	Off	L1	19.3	27.7	54.4
0.630000	27.1	Off	L1	19.4	18.9	46.0
1.182000	27.9	Off	L1	19.6	18.1	46.0
1.302000	27.7	Off	L1	19.5	18.3	46.0
1.398000	27.4	Off	L1	19.5	18.6	46.0
2.878000	27.2	Off	L1	19.6	18.8	46.0
3.150000	26.8	Off	L1	19.6	19.2	46.0
3.462000	26.1	Off	L1	19.6	19.9	46.0
3.750000	26.2	Off	L1	19.6	19.8	46.0
4.166000	25.8	Off	L1	19.6	20.2	46.0
4.606000	25.3	Off	L1	19.7	20.7	46.0



Test Mode :	Mode 1	Temperature :	20~22°C
Test Engineer :	Cosmo Xu	Relative Humidity :	45~47%
Test Voltage :	120Vac / 60Hz	Phase :	Neutral
Function Type :	GSM850 Idle + Bluetooth Link + WLAN (2.4GHz) Link + USB Cable (Charging from Adapter) + Battery + Earphone + MP3		

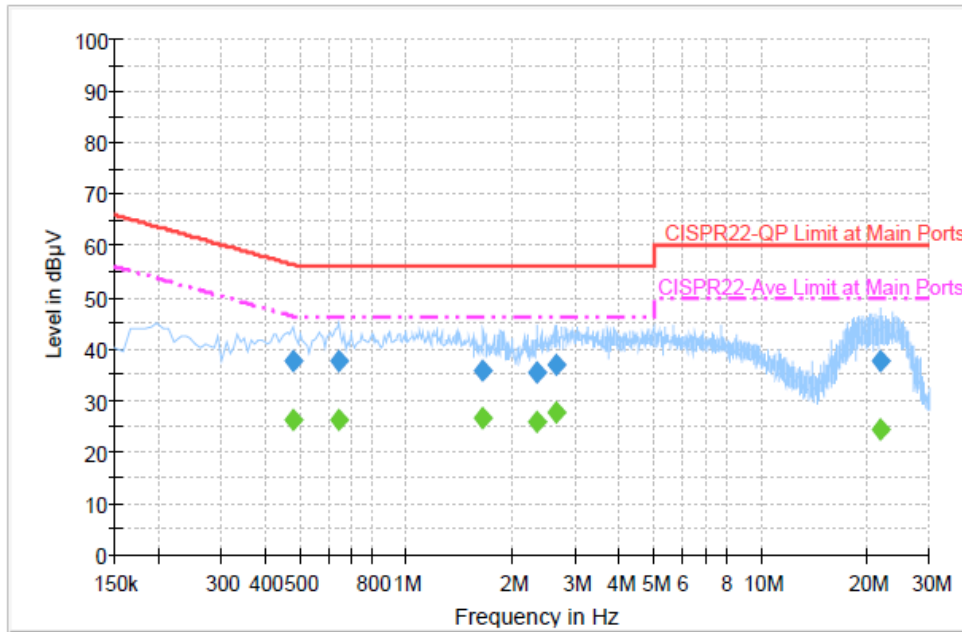

Final Result : Quasi-Peak

Frequency (MHz)	Quasi-Peak (dBµV)	Filter	Line	Corr. (dB)	Margin (dB)	Limit (dBµV)
0.478000	37.6	Off	N	19.4	18.8	56.4
0.646000	37.5	Off	N	19.4	18.5	56.0
1.646000	35.6	Off	N	19.5	20.4	56.0
2.334000	35.3	Off	N	19.6	20.7	56.0
2.662000	36.9	Off	N	19.5	19.1	56.0
21.734000	37.7	Off	N	20.0	22.3	60.0

Final Result : Average

Frequency (MHz)	Average (dBµV)	Filter	Line	Corr. (dB)	Margin (dB)	Limit (dBµV)
0.478000	26.3	Off	N	19.4	20.1	46.4
0.646000	26.3	Off	N	19.4	19.7	46.0
1.646000	26.4	Off	N	19.5	19.6	46.0
2.334000	25.9	Off	N	19.6	20.1	46.0
2.662000	27.5	Off	N	19.5	18.5	46.0
21.734000	24.5	Off	N	20.0	25.5	50.0



3.7 Antenna Requirements

3.7.1 Standard Applicable

If directional gain of transmitting antennas is greater than 6dBi, the power shall be reduced by the same level in dB comparing to gain minus 6dBi. The use of a permanently attached antenna or of an antenna that uses a unique coupling to the intentional radiator shall be considered sufficient to comply with the FCC rule.

3.7.2 Antenna Anti-Replacement Construction

An embedded-in antenna design is used.

3.7.3 Antenna Gain

The antenna peak gain of EUT is less than 6 dBi. Therefore, it is not necessary to reduce maximum peak output power limit.



4 List of Measuring Equipment

Instrument	Manufacturer	Model No.	Serial No.	Characteristics	Calibration Date	Test Date	Due Date	Remark
Spectrum Analyzer	Rohde & Schwarz	FSP40	100055	9kHz~40GHz	Jun. 07, 2013	May 02, 2014~ May 10, 2014	Jun. 06, 2014	Conducted (TH02-HY)
Power Meter	Agilent	E4416A	GB412923 44	300MHz~40GHz	Jan. 28, 2014	May 02, 2014~ May 10, 2014	Jan. 27, 2015	Conducted (TH02-HY)
Power Sensor	Agilent	E9327A	US404415 48	300MHz~40GHz	Jan. 28, 2014	May 02, 2014~ May 10, 2014	Jan. 27, 2015	Conducted (TH02-HY)
Spectrum Analyzer	R&S	FSP30	101067	9kHz ~ 30GHz	Nov. 20, 2013	Jun. 06, 2014	Nov. 19, 2014	Radiation (03CH06-HY)
Spectrum Analyzer	Agilent	E4408B	MY442110 30	9kHz ~ 26.5GHz	Dec. 02, 2013	Jun. 06, 2014	Dec. 01, 2014	Radiation (03CH06-HY)
EMI Test Receiver	R&S	ESVS10	834468/00 03	20MHz ~ 1000MHz	May 06, 2014	Jun. 06, 2014	May 05, 2015	Radiation (03CH06-HY)
Loop Antenna	Rohde & Schwarz	HFH2-Z2	860004/00 01	9kHz ~ 30MHz	Jul. 03, 2012	Jun. 06, 2014	Jul. 02, 2014	Radiation (03CH06-HY)
Bilog Antenna	Schaffner	CBL6112B	2885	30MHz ~ 2GHz	Oct. 10, 2013	Jun. 06, 2014	Oct. 09, 2014	Radiation (03CH06-HY)
Double Ridge Horn Antenna	EMCO	3117	00066583	1GHz ~ 18GHz	Aug. 02, 2013	Jun. 06, 2014	Aug. 01, 2014	Radiation (03CH06-HY)
Amplifier	SONOMA	310N	186713	9kHz ~ 1GHz	Apr. 16, 2014	Jun. 06, 2014	Apr. 15, 2015	Radiation (03CH06-HY)
Pre Amplifier	EMCI	EMC051845	SN980048	1GHz ~ 18GHz	Jul. 18, 2013	Jun. 06, 2014	Jul. 17, 2014	Radiation (03CH06-HY)
SHF-EHF Horn Antenna	SCHWARZBECK	BBHA 9170	BBHA9170 251	15GHz ~ 40GHz	Oct. 03, 2013	Jun. 06, 2014	Oct. 02, 2014	Radiation (03CH06-HY)
Preamplifier	Agilent	8449B	3008A0191 7	1GHz ~ 26.5GHz	Apr. 10, 2014	Jun. 06, 2014	Apr. 09, 2015	Radiation (03CH06-HY)
Turn Table	INN-CO	DS2000	420/650/00	0 ~ 360 degree	N/A	Jun. 06, 2014	N/A	Radiation (03CH06-HY)
Antenna Mast	MF	MF-7802	MF780208 212	1 m ~ 4 m	N/A	Jun. 06, 2014	N/A	Radiation (03CH06-HY)
EMI Test Receiver	Rohde & Schwarz	ESCS 30	100356	9kHz ~ 2.75GHz	Nov. 15, 2013	May 14, 2014	Nov. 14, 2014	Conduction (CO05-HY)
LISN (for auxiliary equipment)	Rohde & Schwarz	ENV216	100081	9kHz ~ 30MHz	Dec. 12, 2013	May 14, 2014	Dec. 11, 2014	Conduction (CO05-HY)
LISN	Rohde & Schwarz	ENV216	100080	9kHz ~ 30MHz	Dec. 04, 2013	May 14, 2014	Dec. 03, 2014	Conduction (CO05-HY)
AC Power Source	ChainTek	APC-1000W	N/A	N/A	N/A	May 14, 2014	N/A	Conduction (CO05-HY)



5 Uncertainty of Evaluation

Uncertainty of Conducted Emission Measurement (150 kHz ~ 30 MHz)

Measuring Uncertainty for a Level of Confidence of 95% ($U = 2Uc(y)$)	2.26
---	------

Uncertainty of Radiated Emission Measurement (30 MHz ~ 1000 MHz)

Measuring Uncertainty for a Level of Confidence of 95% ($U = 2Uc(y)$)	4.50
---	------