

FCC SAR Test Report

APPLICANT : Motorola Mobility LLC
EQUIPMENT : Mobile Cellular Phone
BRAND NAME : Motorola Mobility, LLC
MODEL NAME : 3578
FCC ID : IHDT56QA1
STANDARD : FCC 47 CFR Part 2 (2.1093)
ANSI/IEEE C95.1-1992
IEEE 1528-2003

We, SPORTON INTERNATIONAL INC., would like to declare that the tested sample has been evaluated in accordance with the procedures and shown the compliance with the applicable technical standards.

The test results in this report apply exclusively to the tested model / sample. Without written approval of SPORTON INTERNATIONAL INC., the test report shall not be reproduced except in full.

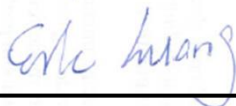

Reviewed by: Eric Huang / Deputy Manager



Approved by: Jones Tsai / Manager



SPORTON INTERNATIONAL INC.

No. 52, Hwa Ya 1st Rd., Hwa Ya Technology Park, Kwei-Shan Hsiang, Tao Yuan Hsien, Taiwan, R.O.C.



Table of Contents

- 1. Administration Data 3
- 2. Equipment Under Test (EUT) 4
 - 2.1 General Information 4
- 3. Specific Absorption Rate (SAR)..... 5
 - 3.1 Introduction 5
 - 3.2 SAR Definition..... 5
- 4. System Description and Setup 6
- 5. Transmitter power reduction conditions and modes 7
- 6. Test Setup Information, SAR Measurement Results, and Analysis 8
- 7. Uncertainty Assessment10
- 8. References.....12

Appendix A. Plots of SAR Measurement



Revision History

REPORT NO.	VERSION	DESCRIPTION	ISSUED DATE
FA442943B	Rev. 01	Initial issue of report	Jun. 20, 2014

1. Administration Data

Testing Laboratory	
Test Site	SPORTON INTERNATIONAL INC.
Test Site Location	No. 52, Hwa Ya 1 st Rd., Hwa Ya Technology Park, Kwei-Shan Hsiang, Tao Yuan Hsien, Taiwan, R.O.C. TEL: +886-3-327-3456 FAX: +886-3-328-4978

Applicant	
Company Name	Motorola Mobility LLC
Address	222 W Merchandise Mart Plaza, Suite 1800, Chicago, IL 60654, United States

Manufacturer	
Company Name	Motorola Mobility LLC
Address	222 W Merchandise Mart Plaza, Suite 1800, Chicago, IL 60654, United States

2. Equipment Under Test (EUT)

2.1 General Information

Product Feature & Specification	
Equipment Name	Mobile Cellular Phone
Brand Name	Motorola Mobility, LLC
Model Name	3578
FCC ID	IHDT56QA1
IMEI Code	Sample for WWAN SAR testing: 359279050020178 Sample for WLAN SAR testing: 359279050020160
Wireless Technology and Frequency Range	GSM850: 824.2 MHz ~ 848.8 MHz GSM1900: 1850.2 MHz ~ 1909.8 MHz WCDMA Band V: 826.4 MHz ~ 846.6 MHz WCDMA Band IV: 1712.4 MHz ~ 1752.6 MHz WCDMA Band II: 1852.4 MHz ~ 1907.6 MHz LTE Band 17: 706.5 MHz ~ 713.5 MHz LTE Band 5: 824.7 MHz ~ 848.3 MHz LTE Band 4: 1710.7 MHz ~ 1754.3 MHz LTE Band 2: 1850.7 MHz ~ 1909.3 MHz LTE Band 7: 2502.5 MHz ~ 2567.5 MHz WLAN 2.4GHz Band: 2412 MHz ~ 2462 MHz WLAN 5.2GHz Band: 5180 MHz ~ 5240 MHz WLAN 5.3GHz Band: 5260 MHz ~ 5320 MHz WLAN 5.5GHz Band: 5500 MHz ~ 5700 MHz WLAN 5.8GHz Band: 5745 MHz ~ 5825 MHz Bluetooth: 2402 MHz ~ 2480 MHz NFC: 13.56 MHz
Mode	<ul style="list-style-type: none"> • GSM/GPRS/EGPRS • RMC/AMR 12.2Kbps • HSDPA • HSUPA • DC-HSDPA • LTE: QPSK, 16QAM • 802.11a/b/g/n/ac HT20/HT40/VHT20/VHT40/VHT80 • Bluetooth v3.0+EDR · Bluetooth v4.0-LE • NFC:ASK
HW Version	P2
SW Version	KXE21.99.169
GSM / (E)GPRS Transfer mode	Class B – EUT cannot support Packet Switched and Circuit Switched Network simultaneously but can automatically switch between Packet and Circuit Switched Network.
EUT Stage	Identical Prototype
Remark: <ol style="list-style-type: none"> 1. This device supported VoIP in EGPRS, WCDMA, LTE (e.g. 3rd party VoIP). 2. This device 2.4GHz / 5.2GHz / 5.8GHz WLAN supports Hotspot operation and WiFi Direct (Group Client / Group Owner), and 5.3GHz / 5.5GHz WLAN supports WiFi Direct (Group Client). 3. While operating in body-adjacent exposure configurations during a mobile hotspot session, reduced power limits are enforced on the GSM1900, WCDMA B2 / B4, and LTE B2 / B4 / B7 transmitter. More detailed information which can be referred to “operational description”. 4. While operation simultaneously with any other transmitters active, like WiFi Direct or Hotspot function, a reduced maximum power limit is enforced on the WiFi transmitter in 2.4GHz / 5.2GHz / 5.8GHz WLAN. More detailed information which can be referred to “operational description”. 	

3. Specific Absorption Rate (SAR)

3.1 Introduction

SAR is related to the rate at which energy is absorbed per unit mass in an object exposed to a radio field. The SAR distribution in a biological body is complicated and is usually carried out by experimental techniques or numerical modeling. The standard recommends limits for two tiers of groups, occupational/controlled and general population/uncontrolled, based on a person's awareness and ability to exercise control over his or her exposure. In general, occupational/controlled exposure limits are higher than the limits for general population/uncontrolled.

3.2 SAR Definition

The SAR definition is the time derivative (rate) of the incremental energy (dW) absorbed by (dissipated in) an incremental mass (dm) contained in a volume element (dv) of a given density (ρ). The equation description is as below:

$$SAR = \frac{d}{dt} \left(\frac{dW}{dm} \right) = \frac{d}{dt} \left(\frac{dW}{\rho dv} \right)$$

SAR is expressed in units of Watts per kilogram (W/kg)

$$SAR = \frac{\sigma |E|^2}{\rho}$$

Where: σ is the conductivity of the tissue, ρ is the mass density of the tissue and E is the RMS electrical field strength.

4. System Description and Setup

The DASY system used for performing compliance tests consists of the following items:

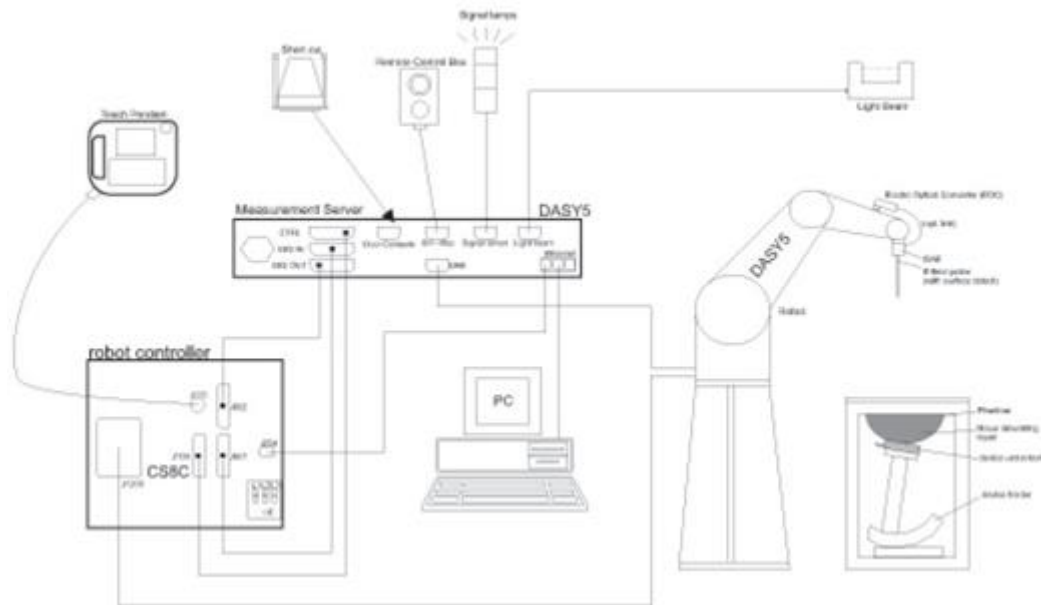

- A standard high precision 6-axis robot with controller, teach pendant and software. An arm extension for accommodating the data acquisition electronics (DAE).
- An isotropic Field probe optimized and calibrated for the targeted measurement.
- A data acquisition electronics (DAE) which performs the signal amplification, signal multiplexing, AD-conversion, offset measurements, mechanical surface detection, collision detection, etc. The unit is battery powered with standard or rechargeable batteries. The signal is optically transmitted to the EOC.
- The Electro-optical converter (EOC) performs the conversion from optical to electrical signals for the digital communication to the DAE. To use optical surface detection, a special version of the EOC is required. The EOC signal is transmitted to the measurement server.
- The function of the measurement server is to perform the time critical tasks such as signal filtering, control of the robot operation and fast movement interrupts.
- The Light Beam used is for probe alignment. This improves the (absolute) accuracy of the probe positioning.
- A computer running WinXP or Win7 and the DASY5 software.
- Remote control and teach pendant as well as additional circuitry for robot safety such as warning lamps, etc.
- The phantom, the device holder and other accessories according to the targeted measurement.

5. Transmitter power reduction conditions and modes

The phone utilizes reduced limits for the maximum transmit power for its transmitters when operation under the following noted conditions to ensure SAR exposure compliance is maintained. Tables of the reduced limits used for testing are given below. A complete description of this functionality is provided in the Operational Description. The implementation to trigger the reduction in power requires the device to be radiating, which prevents conducted power measurements of this functionality without modification to the unit

While operating in body-adjacent exposure configurations during a mobile hotspot session, reduced power limits are enforced on the GSM1900, WCDMA B2 / B4, and LTE B2 / B4 / B7 transmitter. More detailed information which can be referred to "operational description".

Mode(s) of Operation	GSM1900	WCDMA II	WCDMA IV
Frequency Range (MHz)	1850.2 ~ 1909.8	1852.4 ~ 1907.6	1712.4 ~ 1752.6
Maximum Output Power (dBm)	28.7	24.0	24.0
Reduced Maximum Output Power (dBm)	23.7	18.0	19.5

Mode(s) of Operation	LTE Band 2	LTE Band 4	LTE Band 7
Frequency Range (MHz)	1850.7 ~ 1909.3	1710.7 ~ 1754.3	2502.5 ~ 2567.5
Maximum Output Power (dBm)	24.0	24.0	24.0
Reduced Maximum Output Power (dBm)	18.5	18.5	17.5

6. Test Setup Information, SAR Measurement Results, and Analysis

The following SAR test data is being provided to demonstrate the device's effective utilization of power reduction conditions specified in Operational Description. The values in the table(s) are provided solely for purposes of confirming compliant power reduction operation and do not represent maximum SAR values of the product. For maximum reported SAR compliance values, refer to the Exhibit 11 SAR test report, report no: FA442943A.

The test conditions that produced the highest SAR values for each combination of EUT mode and exposure condition are indicated as bold numbers in the following tables. Plots of these tests are included in Appendix A of this report.

<GSM1900 during a mobile hotspot session>

Configuration	Channel	f (MHz)	1 g SAR value without Power Reduction		1 g SAR value with Power Reduction		Measured SAR Reduction (dB)
			Maximum Power Limit (dB)	Measured 1g SAR (W/kg)	Maximum Power Limit (dB)	Measured 1g SAR (W/kg)	
Bottom Edge of Phone 10 mm from Phantom	810	1909.8	28.7	1.940	23.7	0.633	4.86

<WCMDA Band II during a mobile hotspot session>

Configuration	Channel	f (MHz)	1 g SAR value without Power Reduction		1 g SAR value with Power Reduction		Measured SAR Reduction (dB)
			Maximum Power Limit (dB)	Measured 1g SAR (W/kg)	Maximum Power Limit (dB)	Measured 1g SAR (W/kg)	
Bottom Edge of Phone 10 mm from Phantom	9538	1907.6	24.0	2.910	18.0	0.811	5.54

<WCMDA Band IV during a mobile hotspot session>

Configuration	Channel	f (MHz)	1 g SAR value without Power Reduction		1 g SAR value with Power Reduction		Measured SAR Reduction (dB)
			Maximum Power Limit (dB)	Measured 1g SAR (W/kg)	Maximum Power Limit (dB)	Measured 1g SAR (W/kg)	
Bottom Edge of Phone 10 mm from Phantom	1312	1712.4	24.0	2.000	19.5	0.764	4.18

<LTE Band 2 during a mobile hotspot session>

Configuration	Channel	f (MHz)	1 g SAR value without Power Reduction		1 g SAR value with Power Reduction		Measured SAR Reduction (dB)
			Maximum Power Limit (dB)	Measured 1g SAR (W/kg)	Maximum Power Limit (dB)	Measured 1g SAR (W/kg)	
Bottom Edge of Phone 10 mm from Phantom	19100	1900	24.0	2.700	18.5	0.814	5.21

<LTE Band 4 during a mobile hotspot session>

Configuration	Channel	f (MHz)	1 g SAR value without Power Reduction		1 g SAR value with Power Reduction		Measured SAR Reduction (dB)
			Maximum Power Limit (dB)	Measured 1g SAR (W/kg)	Maximum Power Limit (dB)	Measured 1g SAR (W/kg)	
Bottom Edge of Phone 10 mm from Phantom	20300	1745	24.0	2.780	18.5	0.845	5.17

<LTE Band 7 during a mobile hotspot session>

Configuration	Channel	f (MHz)	1 g SAR value without Power Reduction		1 g SAR value with Power Reduction		Measured SAR Reduction (dB)
			Maximum Power Limit (dB)	Measured 1g SAR (W/kg)	Maximum Power Limit (dB)	Measured 1g SAR (W/kg)	
Bottom Edge of Phone 10 mm from Phantom	21350	2560	24.0	3.600	17.5	0.820	6.42

7. Uncertainty Assessment

The component of uncertainty may generally be categorized according to the methods used to evaluate them. The evaluation of uncertainty by the statistical analysis of a series of observations is termed a Type A evaluation of uncertainty. The evaluation of uncertainty by means other than the statistical analysis of a series of observation is termed a Type B evaluation of uncertainty. Each component of uncertainty, however evaluated, is represented by an estimated standard deviation, termed standard uncertainty, which is determined by the positive square root of the estimated variance.

A Type A evaluation of standard uncertainty may be based on any valid statistical method for treating data. This includes calculating the standard deviation of the mean of a series of independent observations; using the method of least squares to fit a curve to the data in order to estimate the parameter of the curve and their standard deviations; or carrying out an analysis of variance in order to identify and quantify random effects in certain kinds of measurement.

A type B evaluation of standard uncertainty is typically based on scientific judgment using all of the relevant information available. These may include previous measurement data, experience, and knowledge of the behavior and properties of relevant materials and instruments, manufacture’s specification, data provided in calibration reports and uncertainties assigned to reference data taken from handbooks. Broadly speaking, the uncertainty is either obtained from an outdoor source or obtained from an assumed distribution, such as the normal distribution, rectangular or triangular distributions indicated in Table 14.1

Uncertainty Distributions	Normal	Rectangular	Triangular	U-Shape
Multi-plying Factor ^(a)	1/k ^(b)	1/√3	1/√6	1/√2

(a) standard uncertainty is determined as the product of the multiplying factor and the estimated range of variations in the measured quantity

(b) κ is the coverage factor

Table 7.1. Standard Uncertainty for Assumed Distribution

The combined standard uncertainty of the measurement result represents the estimated standard deviation of the result. It is obtained by combining the individual standard uncertainties of both Type A and Type B evaluation using the usual “root-sum-squares” (RSS) methods of combining standard deviations by taking the positive square root of the estimated variances.

Expanded uncertainty is a measure of uncertainty that defines an interval about the measurement result within which the measured value is confidently believed to lie. It is obtained by multiplying the combined standard uncertainty by a coverage factor. Typically, the coverage factor ranges from 2 to 3. Using a coverage factor allows the true value of a measured quantity to be specified with a defined probability within the specified uncertainty range. For purpose of this document, a coverage factor two is used, which corresponds to confidence interval of about 95 %. The DASY uncertainty Budget is shown in the following tables.

Error Description	Uncertainty Value (±%)	Probability Distribution	Divisor	Ci (1g)	Ci (10g)	Standard Uncertainty (1g)	Standard Uncertainty (10g)
Measurement System							
Probe Calibration	6.0	Normal	1	1	1	± 6.0 %	± 6.0 %
Axial Isotropy	4.7	Rectangular	√3	0.7	0.7	± 1.9 %	± 1.9 %
Hemispherical Isotropy	9.6	Rectangular	√3	0.7	0.7	± 3.9 %	± 3.9 %
Boundary Effects	1.0	Rectangular	√3	1	1	± 0.6 %	± 0.6 %
Linearity	4.7	Rectangular	√3	1	1	± 2.7 %	± 2.7 %
System Detection Limits	1.0	Rectangular	√3	1	1	± 0.6 %	± 0.6 %
Readout Electronics	0.3	Normal	1	1	1	± 0.3 %	± 0.3 %
Response Time	0.8	Rectangular	√3	1	1	± 0.5 %	± 0.5 %
Integration Time	2.6	Rectangular	√3	1	1	± 1.5 %	± 1.5 %
RF Ambient Noise	3.0	Rectangular	√3	1	1	± 1.7 %	± 1.7 %
RF Ambient Reflections	3.0	Rectangular	√3	1	1	± 1.7 %	± 1.7 %
Probe Positioner	0.4	Rectangular	√3	1	1	± 0.2 %	± 0.2 %
Probe Positioning	2.9	Rectangular	√3	1	1	± 1.7 %	± 1.7 %
Max. SAR Eval.	1.0	Rectangular	√3	1	1	± 0.6 %	± 0.6 %
Test Sample Related							
Device Positioning	2.9	Normal	1	1	1	± 2.9 %	± 2.9 %
Device Holder	3.6	Normal	1	1	1	± 3.6 %	± 3.6 %
Power Drift	5.0	Rectangular	√3	1	1	± 2.9 %	± 2.9 %
Phantom and Setup							
Phantom Uncertainty	4.0	Rectangular	√3	1	1	± 2.3 %	± 2.3 %
Liquid Conductivity (Target)	5.0	Rectangular	√3	0.64	0.43	± 1.8 %	± 1.2 %
Liquid Conductivity (Meas.)	2.5	Normal	1	0.64	0.43	± 1.6 %	± 1.1 %
Liquid Permittivity (Target)	5.0	Rectangular	√3	0.6	0.49	± 1.7 %	± 1.4 %
Liquid Permittivity (Meas.)	2.5	Normal	1	0.6	0.49	± 1.5 %	± 1.2 %
Combined Standard Uncertainty						± 11.0 %	± 10.8 %
Coverage Factor for 95 %						K=2	
Expanded Uncertainty						± 22.0 %	± 21.5 %

Table 7.2. Uncertainty Budget for frequency range 300 MHz to 3 GHz

8. References

- [1] FCC 47 CFR Part 2 "Frequency Allocations and Radio Treaty Matters; General Rules and Regulations"
- [2] ANSI/IEEE Std. C95.1-1992, "IEEE Standard for Safety Levels with Respect to Human Exposure to Radio Frequency Electromagnetic Fields, 3 kHz to 300 GHz", September 1992
- [3] IEEE Std. 1528-2003, "Recommended Practice for Determining the Peak Spatial-Average Specific Absorption Rate (SAR) in the Human Head from Wireless Communications Devices: Measurement Techniques", December 2003
- [4] SPEAG DASY System Handbook
- [5] FCC KDB 248227 D01 v01r02, "SAR Measurement Procedures for 802.11 a/b/g Transmitters", May 2007
- [6] FCC KDB 447498 D01 v05r02, "Mobile and Portable Device RF Exposure Procedures and Equipment Authorization Policies", Feb 2014
- [7] FCC KDB 648474 D04 v01r02, "SAR Evaluation Considerations for Wireless Handsets", Dec 2013.
- [8] FCC KDB 941225 D01 v02, "SAR Measurement Procedures for 3G Devices – CDMA 2000 / Ev-Do / WCDMA / HSDPA / HSPA", October 2007
- [9] FCC KDB 941225 D02 v02r02, "SAR Guidance for HSPA, HSPA+, DC-HSDPA and 1x-Advanced", May 2013.
- [10] FCC KDB 941225 D03 v01, "Recommended SAR Test Reduction Procedures for GSM / GPRS / EDGE", December 2008
- [11] FCC KDB 941225 D05 v02r03, "SAR Evaluation Considerations for LTE Devices", Dec 2013
- [12] FCC KDB 941225 D06 v01r01, "SAR Evaluation Procedures for Portable Devices with Wireless Router Capabilities", May 2013.
- [13] FCC KDB 644545 D01 v01r02, "Guidance for IEEE 802.11ac and Pre-ac Device Emission Testing", Oct 2013.
- [14] FCC KDB 865664 D01 v01r03, "SAR Measurement Requirements for 100 MHz to 6 GHz", Feb 2014.
- [15] FCC KDB 865664 D02 v01r01, "RF Exposure Compliance Reporting and Documentation Considerations" May 2013.



Appendix A. Plots of SAR Measurement

The plots are shown as follows.

GSM1900_GPRS (2 Tx slots)_Bottom Side_1cm_Ch810

Communication System: PCS; Frequency: 1909.8 MHz; Duty Cycle: 1:4.15

Medium: MSL_1900_140508 Medium parameters used: $f = 1910$ MHz; $\sigma = 1.526$ S/m; $\epsilon_r = 53.581$; $\rho = 1000$ kg/m³

Ambient Temperature : 23.3 °C; Liquid Temperature : 22.3 °C

DASY5 Configuration:

- Probe: ES3DV3 - SN3270; ConvF(4.71, 4.71, 4.71); Calibrated: 2013/9/24;
- Sensor-Surface: 3mm (Mechanical Surface Detection)
- Electronics: DAE4 Sn778; Calibrated: 2013/8/21
- Phantom: SAM RIGHT; Type: SAM; Serial: 1719
- Measurement SW: DASY52, Version 52.8 (6); SEMCAD X Version 14.6.9 (7117)

Configuration/Ch810/Area Scan (41x71x1): Interpolated grid: dx=1.500 mm, dy=1.500 mm
 Maximum value of SAR (interpolated) = 0.849 W/kg

Configuration/Ch810/Zoom Scan (5x5x7)/Cube 0: Measurement grid: dx=8mm, dy=8mm, dz=5mm

Reference Value = 23.680 V/m; Power Drift = -0.04 dB

Peak SAR (extrapolated) = 1.08 W/kg

SAR(1 g) = 0.633 W/kg; SAR(10 g) = 0.336 W/kg

Maximum value of SAR (measured) = 0.779 W/kg

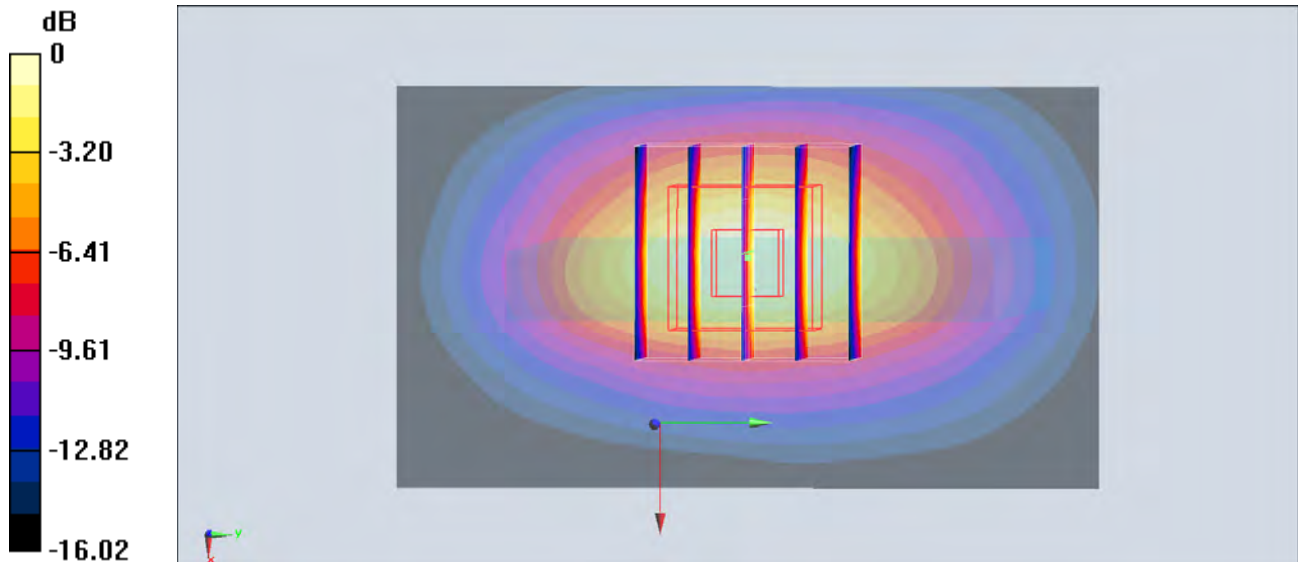

0 dB = 0.779 W/kg = -1.08 dBW/kg

GSM1900_GPRS (2 Tx slots)_Bottom Side_1cm_Ch810

Communication System: PCS; Frequency: 1909.8 MHz; Duty Cycle: 1:4.15

Medium: MSL_1900_140508 Medium parameters used: $f = 1910$ MHz; $\sigma = 1.526$ S/m; $\epsilon_r = 53.581$; $\rho = 1000$ kg/m³

Ambient Temperature : 23.3 °C; Liquid Temperature : 22.3 °C

DASY5 Configuration

- Probe: ES3DV3 - SN3270; ConvF(4.71, 4.71, 4.71); Calibrated: 2013/9/24;
- Sensor-Surface: 3mm (Mechanical Surface Detection)
- Electronics: DAE4 Sn778; Calibrated: 2013/8/21
- Phantom: SAM RIGHT; Type: SAM; Serial: 1719
- Measurement SW: DASY52, Version 52.8 (6); SEMCAD X Version 14.6.9 (7117)

Configuration/Ch810/Area Scan (31x71x1): Interpolated grid: dx=1.500 mm, dy=1.500 mm

Maximum value of SAR (interpolated) = 2.73 W/kg

Configuration/Ch810/Zoom Scan (5x5x7)/Cube 0: Measurement grid: dx=8mm, dy=8mm,

dz=5mm

Reference Value = 41.751 V/m; Power Drift = 0.02 dB

Peak SAR (extrapolated) = 3.46 W/kg

SAR(1 g) = 1.94 W/kg; SAR(10 g) = 0.956 W/kg

Maximum value of SAR (measured) = 2.43 W/kg

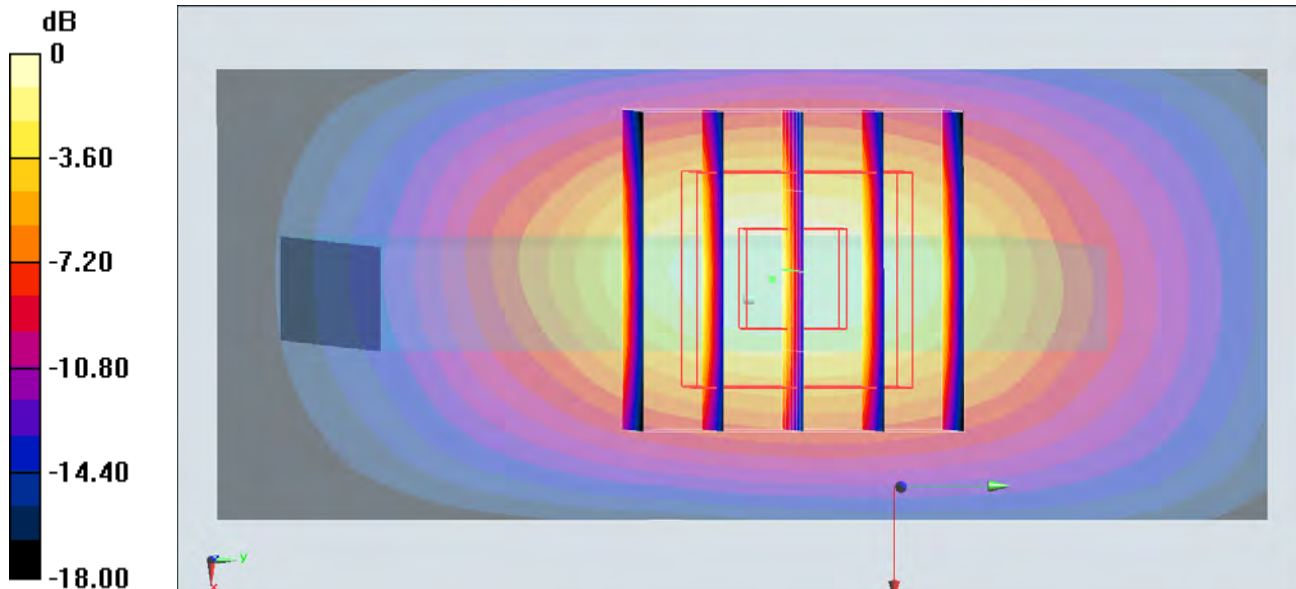

0 dB = 2.43 W/kg = 3.86 dBW/kg

WCDMA II_RMC 12.2Kbps_Bottom Side_1cm_Ch9538

Communication System: WCDMA; Frequency: 1907.6 MHz; Duty Cycle: 1:1

Medium: MSL_1900_140508 Medium parameters used: $f = 1908 \text{ MHz}$; $\sigma = 1.523 \text{ S/m}$; $\epsilon_r = 53.589$; $\rho = 1000 \text{ kg/m}^3$

Ambient Temperature : $23.3 \text{ }^\circ\text{C}$; Liquid Temperature : $22.3 \text{ }^\circ\text{C}$

DASY5 Configuration:

- Probe: ES3DV3 - SN3270; ConvF(4.71, 4.71, 4.71); Calibrated: 2013/9/24;
- Sensor-Surface: 3mm (Mechanical Surface Detection)
- Electronics: DAE4 Sn778; Calibrated: 2013/8/21
- Phantom: SAM RIGHT; Type: SAM; Serial: 1719
- Measurement SW: DASY52, Version 52.8 (6); SEMCAD X Version 14.6.9 (7117)

Configuration/Ch9538/Area Scan (41x71x1): Interpolated grid: $dx=1.500 \text{ mm}$, $dy=1.500 \text{ mm}$
Maximum value of SAR (interpolated) = 1.12 W/kg

Configuration/Ch9538/Zoom Scan (5x5x7)/Cube 0: Measurement grid: $dx=8\text{mm}$, $dy=8\text{mm}$, $dz=5\text{mm}$

Reference Value = 26.888 V/m ; Power Drift = 0.03 dB

Peak SAR (extrapolated) = 1.40 W/kg

SAR(1 g) = 0.811 W/kg ; SAR(10 g) = 0.423 W/kg

Maximum value of SAR (measured) = 1.01 W/kg

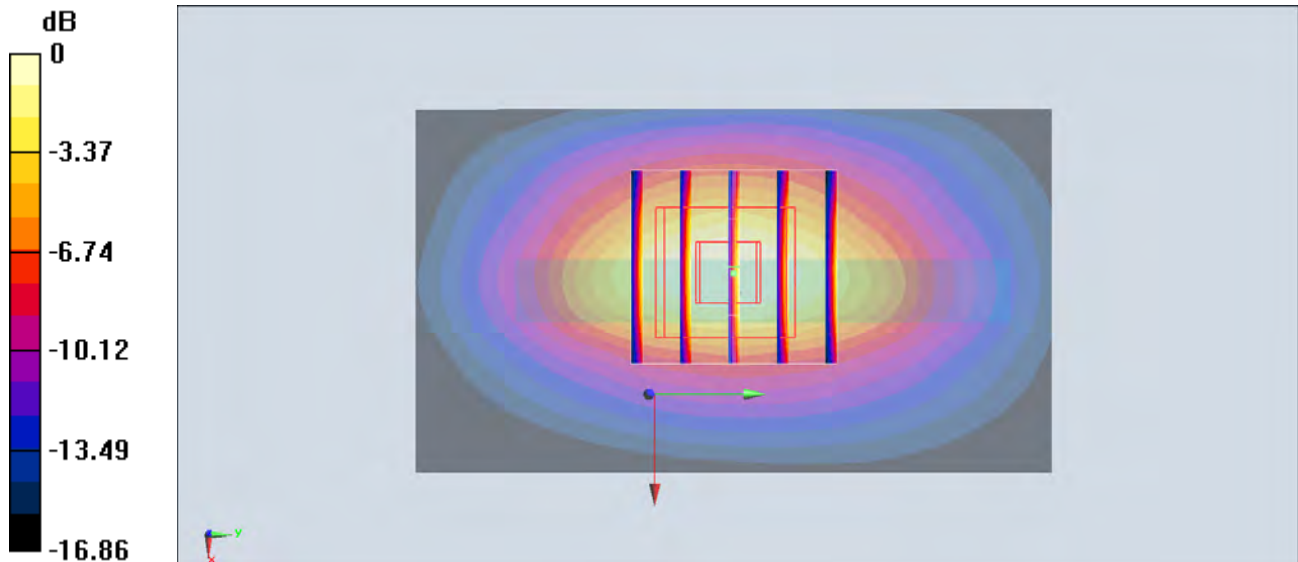

0 dB = 1.01 W/kg = 0.04 dBW/kg

WCDMA II_RMC12.2Kbps_Bottom Side_1cm_Ch9538

Communication System: WCDMA; Frequency: 1907.6 MHz; Duty Cycle: 1:1

Medium: MSL_1900_140508 Medium parameters used: $f = 1908$ MHz; $\sigma = 1.523$ S/m; $\epsilon_r = 53.589$; $\rho = 1000$ kg/m³

Ambient Temperature : 23.3 °C; Liquid Temperature : 22.3 °C

DASY5 Configuration

- Probe: ES3DV3 - SN3270; ConvF(4.71, 4.71, 4.71); Calibrated: 2013/9/24;
- Sensor-Surface: 3mm (Mechanical Surface Detection)
- Electronics: DAE4 Sn778; Calibrated: 2013/8/21
- Phantom: SAM RIGHT; Type: SAM; Serial: 1719
- Measurement SW: DASY52, Version 52.8 (6); SEMCAD X Version 14.6.9 (7117)

Configuration/Ch9538/Area Scan (31x71x1): Interpolated grid: dx=1.500 mm, dy=1.500 mm

Maximum value of SAR (interpolated) = 4.24 W/kg

Configuration/Ch9538/Zoom Scan (5x5x7)/Cube 0: Measurement grid: dx=8mm, dy=8mm, dz=5mm

Reference Value = 50.368 V/m; Power Drift = -0.01 dB

Peak SAR (extrapolated) = 5.22 W/kg

SAR(1 g) = 2.91 W/kg; SAR(10 g) = 1.44 W/kg

Maximum value of SAR (measured) = 3.59 W/kg

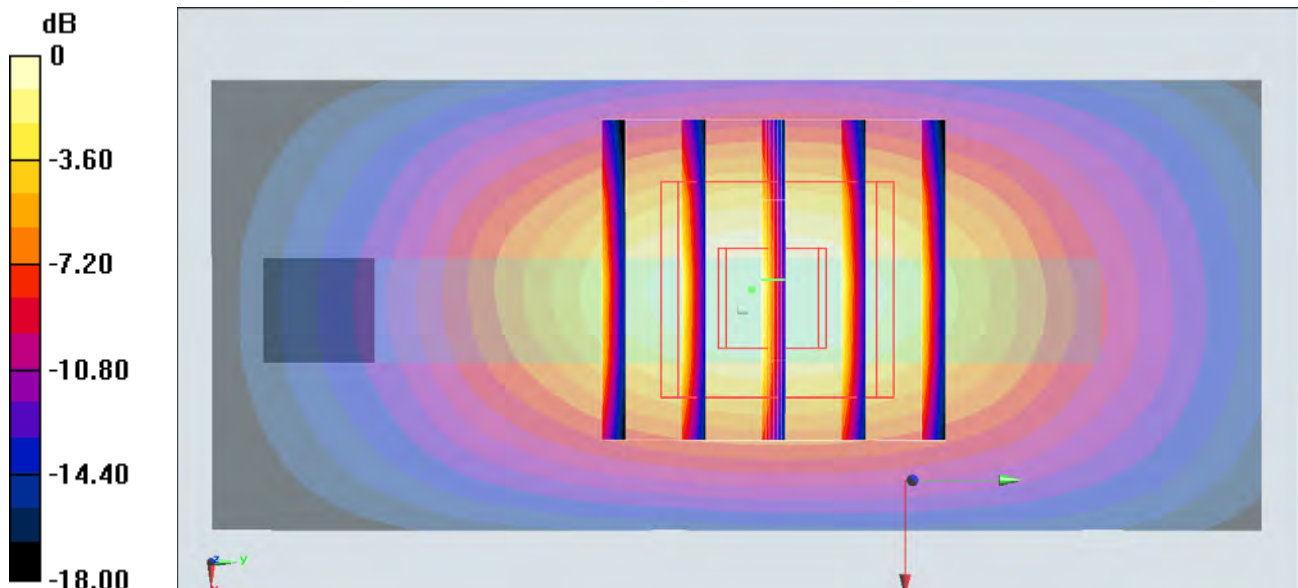

0 dB = 3.59 W/kg = 5.55 dBW/kg

WCDMA IV_RMC 12.2Kbps_Bottom Side_1cm_Ch1312

Communication System: WCDMA; Frequency: 1712.4 MHz; Duty Cycle: 1:1

Medium: MSL_1750_140617 Medium parameters used: $f = 1712.4 \text{ MHz}$; $\sigma = 1.49 \text{ S/m}$; $\epsilon_r = 51.879$; $\rho = 1000 \text{ kg/m}^3$

Ambient Temperature : $23.6 \text{ }^\circ\text{C}$; Liquid Temperature : $22.6 \text{ }^\circ\text{C}$

DASY5 Configuration:

- Probe: ES3DV3 - SN3270; ConvF(4.91, 4.91, 4.91); Calibrated: 2013/9/24;
- Sensor-Surface: 3mm (Mechanical Surface Detection)
- Electronics: DAE4 Sn778; Calibrated: 2013/8/21
- Phantom: SAM-Right; Type: QD 000 P40 C; Serial: TP-1446
- Measurement SW: DASY52, Version 52.8 (7); SEMCAD X Version 14.6.10 (7164)

Configuration/Ch1312/Area Scan (41x71x1): Interpolated grid: $dx=1.500 \text{ mm}$, $dy=1.500 \text{ mm}$
 Maximum value of SAR (interpolated) = 0.995 W/kg

Configuration/Ch1312/Zoom Scan (5x5x7)/Cube 0: Measurement grid: $dx=8\text{mm}$, $dy=8\text{mm}$, $dz=5\text{mm}$

Reference Value = 26.245 V/m ; Power Drift = -0.05 dB

Peak SAR (extrapolated) = 1.27 W/kg

SAR(1 g) = 0.764 W/kg ; SAR(10 g) = 0.412 W/kg

Maximum value of SAR (measured) = 0.925 W/kg

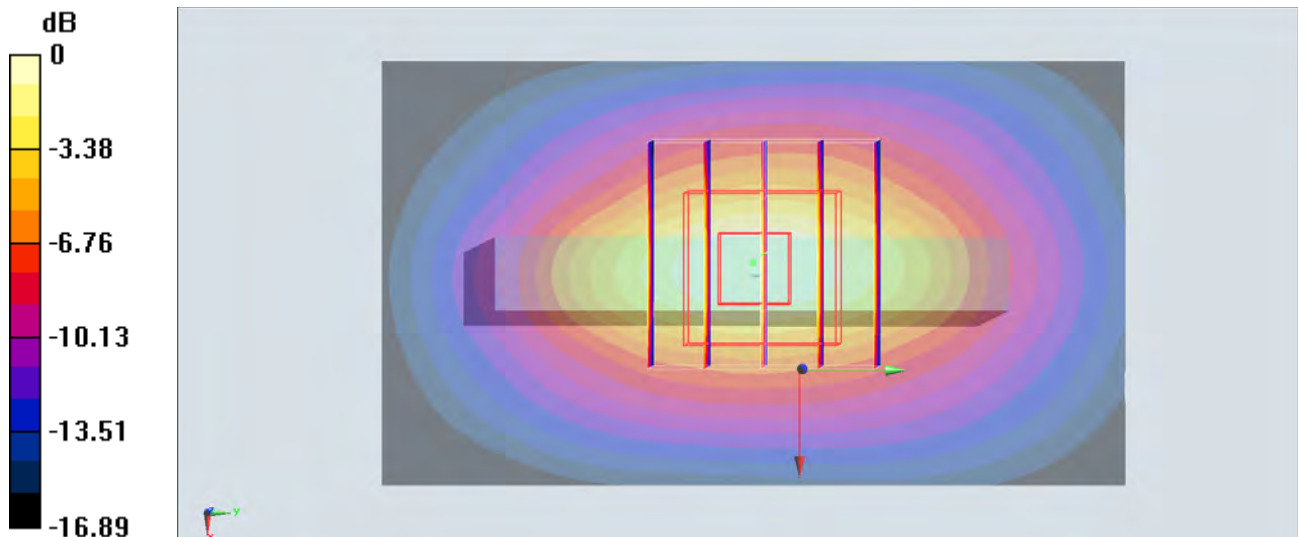

$0 \text{ dB} = 0.925 \text{ W/kg} = -0.34 \text{ dBW/kg}$

WCDMA IV_RMC 12.2Kbps_Bottom Side_1cm_Ch1312

Communication System: WCDMA; Frequency: 1712.4 MHz; Duty Cycle: 1:1

Medium: MSL_1750_140617 Medium parameters used: $f = 1712.4 \text{ MHz}$; $\sigma = 1.49 \text{ S/m}$; $\epsilon_r = 51.879$; $\rho = 1000 \text{ kg/m}^3$

Ambient Temperature : $23.6 \text{ }^\circ\text{C}$; Liquid Temperature : $22.6 \text{ }^\circ\text{C}$

DASY5 Configuration:

- Probe: ES3DV3 - SN3270; ConvF(4.91, 4.91, 4.91); Calibrated: 2013/9/24;
- Sensor-Surface: 3mm (Mechanical Surface Detection)
- Electronics: DAE4 Sn778; Calibrated: 2013/8/21
- Phantom: SAM-Right; Type: QD 000 P40 C; Serial: TP-1446
- Measurement SW: DASY52, Version 52.8 (7); SEMCAD X Version 14.6.10 (7164)

Configuration/Ch1312/Area Scan (41x71x1): Interpolated grid: $dx=1.500 \text{ mm}$, $dy=1.500 \text{ mm}$
 Maximum value of SAR (interpolated) = 2.63 W/kg

Configuration/Ch1312/Zoom Scan (5x5x7)/Cube 0: Measurement grid: $dx=8\text{mm}$, $dy=8\text{mm}$, $dz=5\text{mm}$

Reference Value = 42.787 V/m ; Power Drift = -0.05 dB

Peak SAR (extrapolated) = 3.30 W/kg

SAR(1 g) = 2 W/kg ; SAR(10 g) = 1.08 W/kg

Maximum value of SAR (measured) = 2.47 W/kg

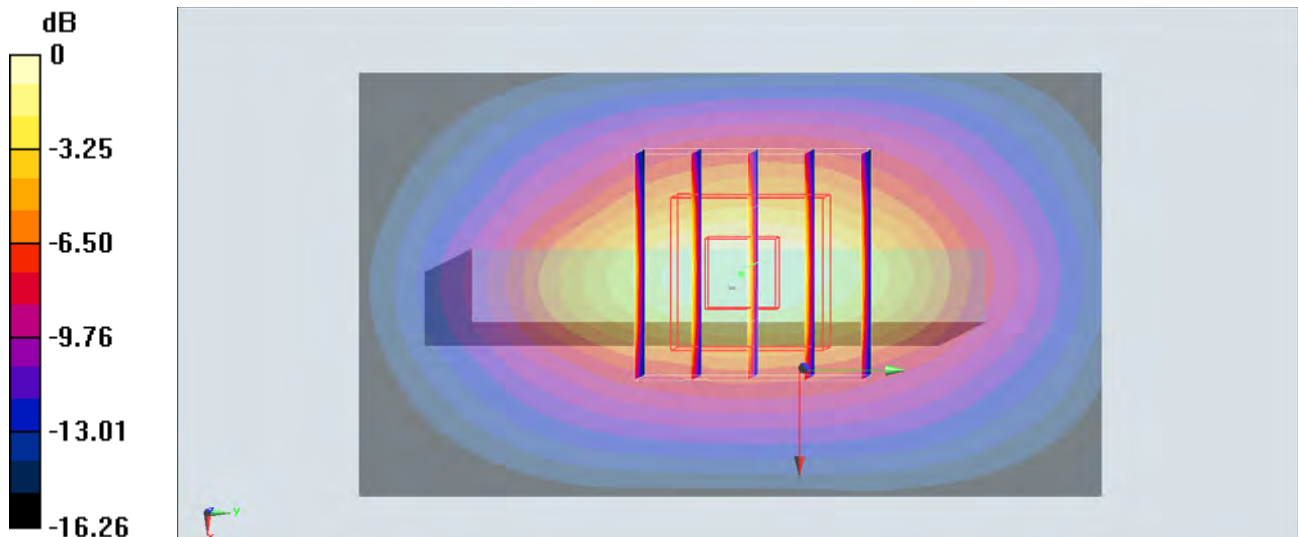

0 dB = $2.47 \text{ W/kg} = 3.93 \text{ dBW/kg}$

LTE Band 2_20M_QPSK_1RB_0Offset_Bottom Side_1cm_Ch19100

Communication System: LTE; Frequency: 1900 MHz; Duty Cycle: 1:1

Medium: MSL_1900_140509 Medium parameters used: $f = 1900$ MHz; $\sigma = 1.526$ S/m; $\epsilon_r = 52.813$; $\rho = 1000$ kg/m³

Ambient Temperature : 23.6 °C; Liquid Temperature : 22.6 °C

DASY5 Configuration:

- Probe: ES3DV3 - SN3270; ConvF(4.71, 4.71, 4.71); Calibrated: 2013/9/24;
- Sensor-Surface: 3mm (Mechanical Surface Detection)
- Electronics: DAE4 Sn778; Calibrated: 2013/8/21
- Phantom: SAM RIGHT; Type: SAM; Serial: 1719
- Measurement SW: DASY52, Version 52.8 (6); SEMCAD X Version 14.6.9 (7117)

Configuration/Ch19100/Area Scan (41x71x1): Interpolated grid: dx=1.500 mm, dy=1.500 mm
Maximum value of SAR (interpolated) = 1.14 W/kg

Configuration/Ch19100/Zoom Scan (5x5x7)/Cube 0: Measurement grid: dx=8mm, dy=8mm, dz=5mm

Reference Value = 26.958 V/m; Power Drift = -0.02 dB

Peak SAR (extrapolated) = 1.40 W/kg

SAR(1 g) = 0.814 W/kg; SAR(10 g) = 0.427 W/kg

Maximum value of SAR (measured) = 1.01 W/kg

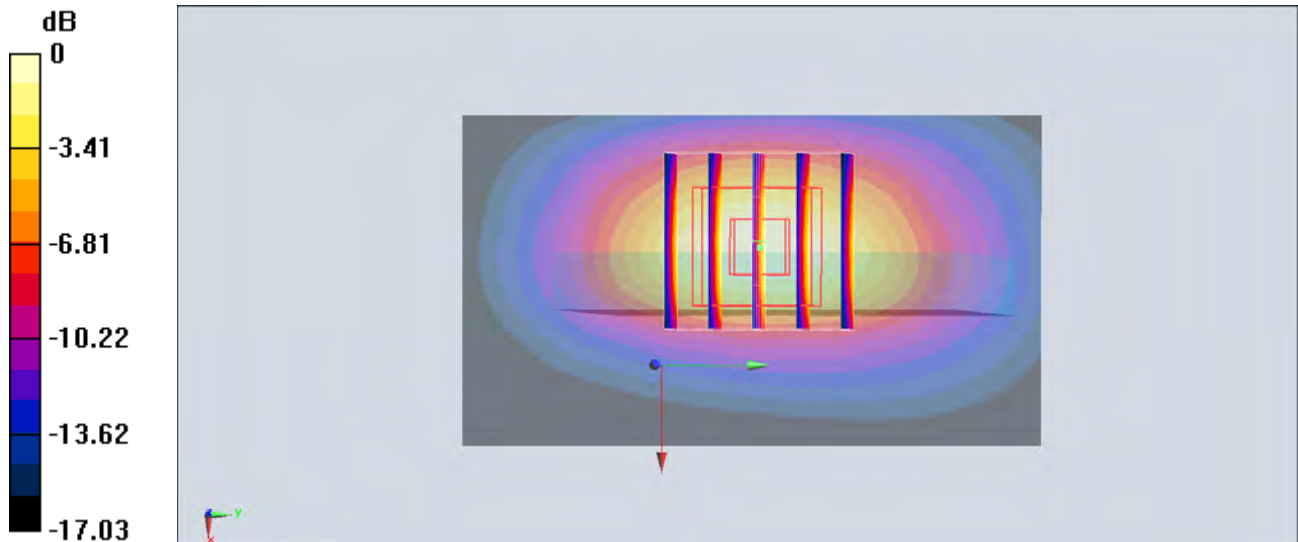

0 dB = 1.01 W/kg = 0.04 dBW/kg

LTE Band 2_20M_QPSK_1RB_0Offset_Bottom Side_1cm_Ch19100

Communication System: LTE; Frequency: 1900 MHz; Duty Cycle: 1:1

Medium: MSL_1900_140509 Medium parameters used: $f = 1900$ MHz; $\sigma = 1.526$ S/m; $\epsilon_r = 52.813$; $\rho = 1000$ kg/m³

Ambient Temperature : 23.6 °C; Liquid Temperature : 22.6 °C

DASY5 Configuration

- Probe: ES3DV3 - SN3270; ConvF(4.71, 4.71, 4.71); Calibrated: 2013/9/24;
- Sensor-Surface: 3mm (Mechanical Surface Detection)
- Electronics: DAE4 Sn778; Calibrated: 2013/8/21
- Phantom: SAM RIGHT; Type: SAM; Serial: 1719
- Measurement SW: DASY4, Version 4.7 (80); SEMCAD X Version 14.6.9 (7117)

Configuration/Ch19100/Area Scan (31x71x1): Interpolated grid: dx=1.500 mm, dy=1.500 mm
 Maximum value of SAR (interpolated) = 3.85 W/kg

Configuration/Ch19100/Zoom Scan (5x5x7)/Cube 0: Measurement grid: dx=8mm, dy=8mm, dz=5mm

Reference Value = 49.456 V/m; Power Drift = -0.01 dB

Peak SAR (extrapolated) = 4.79 W/kg

SAR(1 g) = 2.7 W/kg; SAR(10 g) = 1.37 W/kg

Maximum value of SAR (measured) = 3.40 W/kg

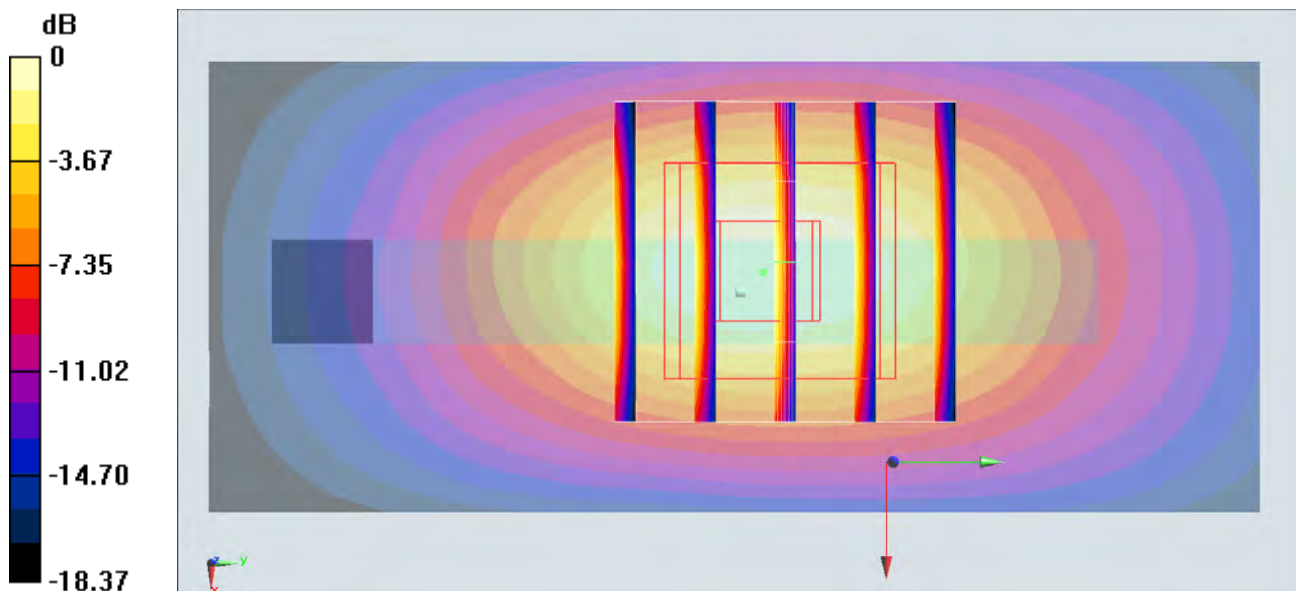

0 dB = 3.40 W/kg = 5.31 dBW/kg

LTE Band 4_20M_QPSK_1RB_0Offset_Bottom Side_1cm_Ch20300

Communication System: LTE; Frequency: 1745 MHz; Duty Cycle: 1:1

Medium: MSL_1750_140510 Medium parameters used: $f = 1745$ MHz; $\sigma = 1.518$ S/m; $\epsilon_r = 51.655$; $\rho = 1000$ kg/m³

Ambient Temperature : 23.7 °C; Liquid Temperature : 22.7 °C

DASY5 Configuration:

- Probe: ES3DV3 - SN3270; ConvF(4.91, 4.91, 4.91); Calibrated: 2013/9/24;
- Sensor-Surface: 3mm (Mechanical Surface Detection)
- Electronics: DAE4 Sn778; Calibrated: 2013/8/21
- Phantom: SAM RIGHT; Type: SAM; Serial: 1719
- Measurement SW: DASY52, Version 52.8 (6); SEMCAD X Version 14.6.9 (7117)

Configuration/Ch20300/Area Scan (41x71x1): Interpolated grid: dx=1.500 mm, dy=1.500 mm
Maximum value of SAR (interpolated) = 1.13 W/kg

Configuration/Ch20300/Zoom Scan (5x5x7)/Cube 0: Measurement grid: dx=8mm, dy=8mm, dz=5mm

Reference Value = 27.353 V/m; Power Drift = -0.06 dB

Peak SAR (extrapolated) = 1.42 W/kg

SAR(1 g) = 0.845 W/kg; SAR(10 g) = 0.449 W/kg

Maximum value of SAR (measured) = 1.01 W/kg

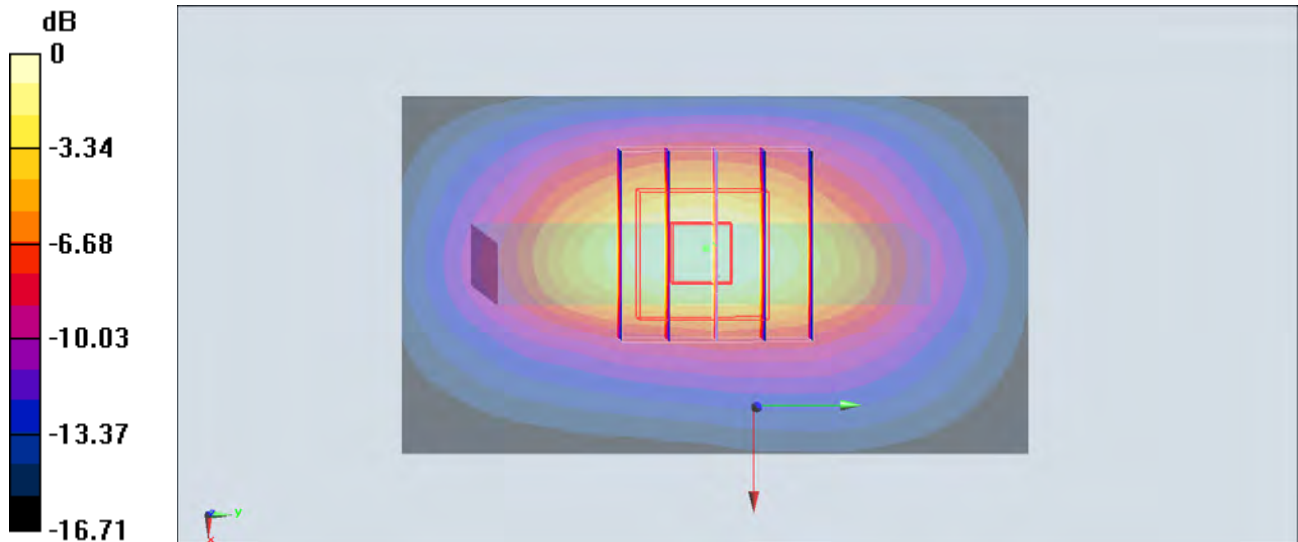

0 dB = 1.01 W/kg = 0.04 dBW/kg

LTE Band 4_20M_QPSK_1RB_0Offset_Bottom Side_1cm_Ch20300

Communication System: LTE; Frequency: 1745 MHz; Duty Cycle: 1:1

Medium: MSL_1750_140510 Medium parameters used: $f = 1745 \text{ MHz}$; $\sigma = 1.518 \text{ S/m}$; $\epsilon_r = 51.655$; $\rho = 1000 \text{ kg/m}^3$

Ambient Temperature : $23.7 \text{ }^\circ\text{C}$; Liquid Temperature : $22.7 \text{ }^\circ\text{C}$

DASY5 Configuration

- Probe: ES3DV3 - SN3270; ConvF(4.91, 4.91, 4.91); Calibrated: 2013/9/24;
- Sensor-Surface: 3mm (Mechanical Surface Detection)
- Electronics: DAE4 Sn778; Calibrated: 2013/8/21
- Phantom: SAM RIGHT; Type: SAM; Serial: 1719
- Measurement SW: DASY4, Version 4.7 (80); SEMCAD X Version 14.6.9 (7117)

Configuration/Ch20300/Area Scan (31x71x1): Interpolated grid: $dx=1.500 \text{ mm}$, $dy=1.500 \text{ mm}$
 Maximum value of SAR (interpolated) = 3.77 W/kg

Configuration/Ch20300/Zoom Scan (5x5x7)/Cube 0: Measurement grid: $dx=8\text{mm}$, $dy=8\text{mm}$, $dz=5\text{mm}$

Reference Value = 49.818 V/m ; Power Drift = -0.01 dB

Peak SAR (extrapolated) = 4.66 W/kg

SAR(1 g) = 2.78 W/kg ; SAR(10 g) = 1.49 W/kg

Maximum value of SAR (measured) = 3.44 W/kg

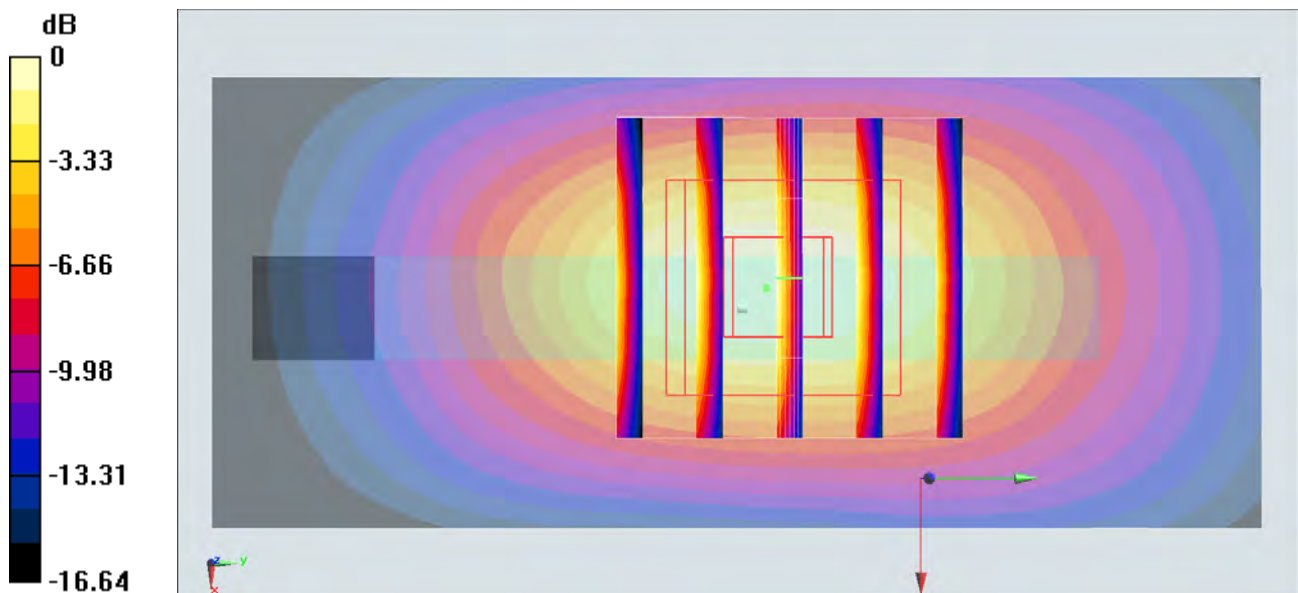

0 dB = 3.44 W/kg = 5.37 dBW/kg

LTE Band 7_20M_QPSK_1RB_0Offset_Bottom Side_1cm_Ch21350

Communication System: LTE; Frequency: 2560 MHz; Duty Cycle: 1:1

Medium: MSL_2600_140511 Medium parameters used: $f = 2560$ MHz; $\sigma = 2.156$ S/m; $\epsilon_r = 51.082$; $\rho = 1000$ kg/m³

Ambient Temperature : 23.4 °C; Liquid Temperature : 22.4 °C

DASY5 Configuration:

- Probe: EX3DV4 - SN3955; ConvF(7.58, 7.58, 7.58); Calibrated: 2013/12/23;
- Sensor-Surface: 2mm (Mechanical Surface Detection)
- Electronics: DAE4 Sn1399; Calibrated: 2013/11/7
- Phantom: SAM LEFT; Type: QD000P40CD; Serial: TP:1718
- Measurement SW: DASY52, Version 52.8 (6); SEMCAD X Version 14.6.9 (7117)

Configuration/Ch21350/Area Scan (41x101x1): Interpolated grid: dx=1.200 mm, dy=1.200 mm

Maximum value of SAR (interpolated) = 1.22 W/kg

Configuration/Ch21350/Zoom Scan (7x7x7)/Cube 0: Measurement grid: dx=5mm, dy=5mm, dz=5mm

Reference Value = 24.225 V/m; Power Drift = -0.05 dB

Peak SAR (extrapolated) = 1.59 W/kg

SAR(1 g) = 0.820 W/kg; SAR(10 g) = 0.397 W/kg

Maximum value of SAR (measured) = 1.21 W/kg

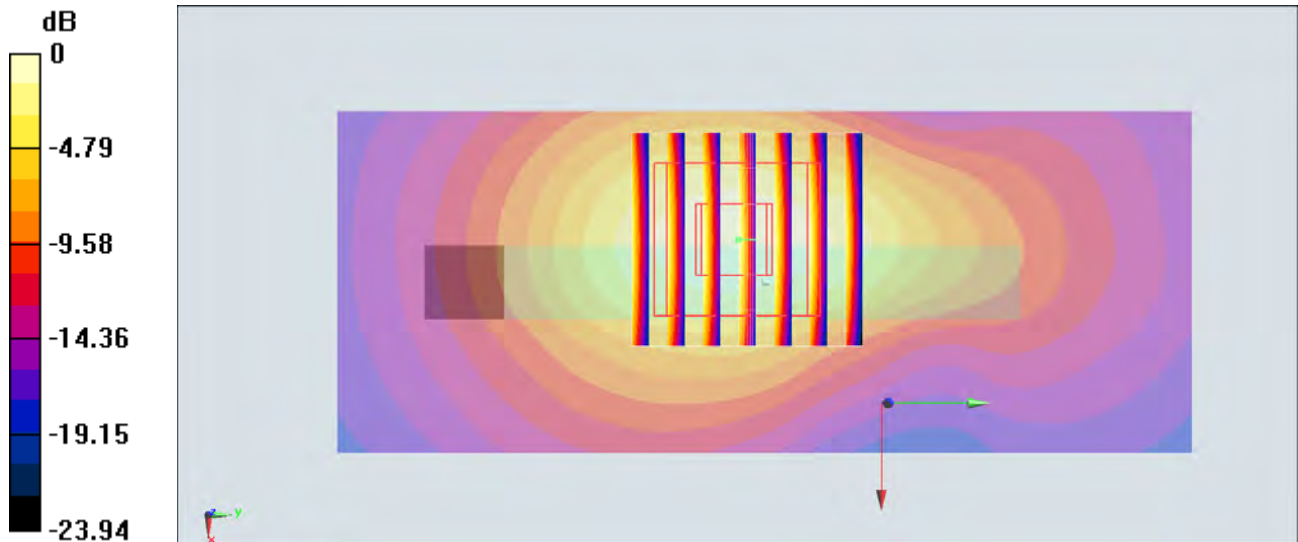

0 dB = 1.21 W/kg = 0.83 dBW/kg

LTE Band 7_20M_QPSK_1RB_0Offset_Bottom Side_1cm_Ch2135

Communication System: LTE; Frequency: 2560 MHz; Duty Cycle: 1:1

Medium: MSL_2600_140511 Medium parameters used: $f = 2560$ MHz; $\sigma = 2.156$ S/m; $\epsilon_r = 51.082$; $\rho = 1000$ kg/m³

Ambient Temperature : 23.4 °C; Liquid Temperature : 22.4 °C

DASY5 Configuration

- Probe: EX3DV4 - SN3955; ConvF(7.58, 7.58, 7.58); Calibrated: 2013/12/23;
- Sensor-Surface: 2mm (Mechanical Surface Detection)
- Electronics: DAE4 Sn1399; Calibrated: 2013/11/7
- Phantom: SAM LEFT; Type: QD000P40CD; Serial: TP:1718
- Measurement SW: DASY52, Version 52.8 (6); SEMCAD X Version 14.6.9 (7117)

Configuration/Ch21350/Area Scan (31x81x1): Interpolated grid: dx=1.200 mm, dy=1.200 mm
 Maximum value of SAR (interpolated) = 5.58 W/kg

Configuration/Ch21350/Zoom Scan (7x7x7)/Cube 0: Measurement grid: dx=5mm, dy=5mm, dz=5mm

Reference Value = 50.021 V/m; Power Drift = 0.02 dB

Peak SAR (extrapolated) = 7.16 W/kg

SAR(1 g) = 3.6 W/kg; SAR(10 g) = 1.73 W/kg

Maximum value of SAR (measured) = 5.36 W/kg

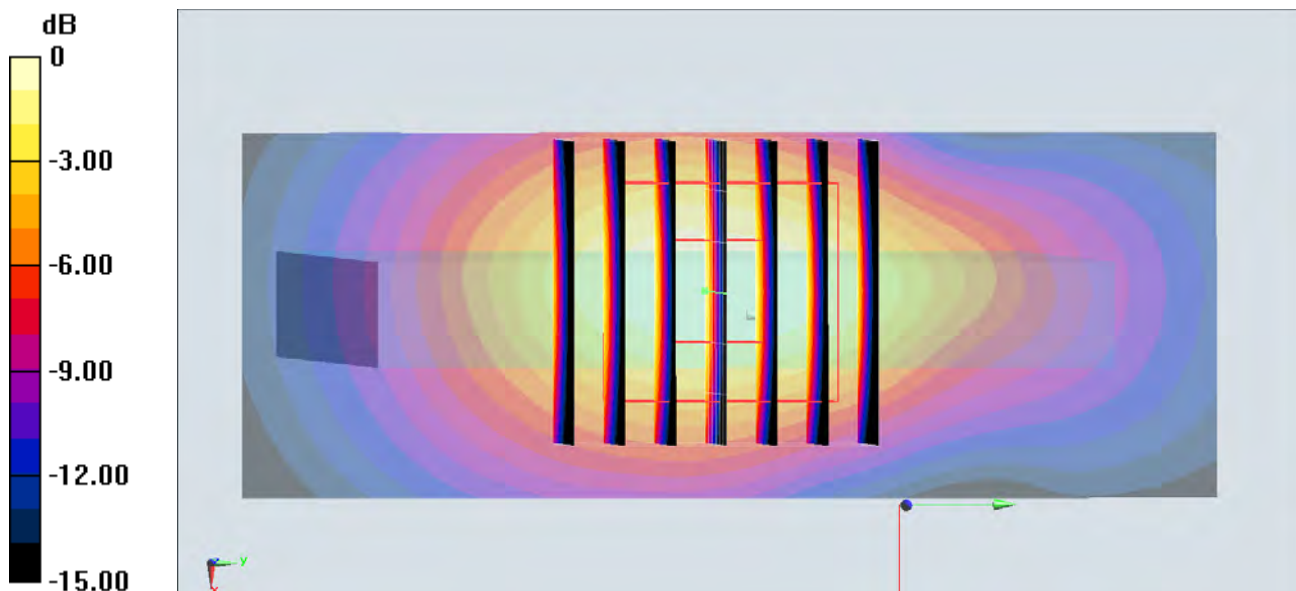

0 dB = 5.36 W/kg = 7.29 dBW/kg