

# FCC/IC RF Test Report

APPLICANT : Motorola Mobility, LLC  
EQUIPMENT : Mobile Cellular Phone  
BRAND NAME : Motorola Mobility, LLC  
MODEL NAME : 3578  
FCC ID : IHDT56QA1  
IC : 109O-T56QA1  
STANDARD : 47 CFR Part 2, 22(H), 24(E), 27  
IC RSS-130 issue 1  
IC RSS-132 issue 3  
IC RSS-133 issue 6  
IC RSS-139 issue 2  
IC RSS-199 issue 1

CLASSIFICATION : PCS Licensed Transmitter Held to Ear (PCE)

The product was received on Apr. 29, 2014 and testing was completed on May 18, 2014. We, SPORTON INTERNATIONAL INC., would like to declare that the tested sample has been evaluated in accordance with the test procedures given in ANSI / TIA / EIA-603-C-2004 and the testing has shown the tested sample to be in compliance with the applicable technical standards.

The test results in this report apply exclusively to the tested model / sample. Without written approval of SPORTON INTERNATIONAL INC., the test report shall not be reproduced except in full.



Reviewed by: Joseph Lin / Supervisor

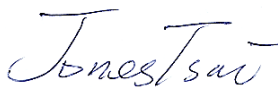

Approved by: Jones Tsai / Manager



## SPORTON INTERNATIONAL INC.

No. 52, Hwa Ya 1<sup>st</sup> Rd., Hwa Ya Technology Park, Kwei-Shan Hsiang, Tao Yuan Hsien, Taiwan, R.O.C.



# TABLE OF CONTENTS

REVISION HISTORY..... 3

SUMMARY OF TEST RESULT ..... 4

**1 GENERAL DESCRIPTION ..... 7**

    1.1 Applicant ..... 7

    1.2 Manufacturer ..... 7

    1.3 Product Feature of Equipment Under Test..... 7

    1.4 Product Specification subjective to this standard ..... 8

    1.5 Modification of EUT ..... 8

    1.6 Maximum ERP/EIRP Power, Frequency Tolerance, and Emission Designator ..... 9

    1.7 Testing Location ..... 11

    1.8 Applicable Standards..... 12

**2 TEST CONFIGURATION OF EQUIPMENT UNDER TEST ..... 13**

    2.1 Test Mode ..... 13

    2.2 Connection Diagram of Test System ..... 15

    2.3 Support Unit used in test configuration and system ..... 15

    2.4 Measurement Results Explanation Example..... 15

**3 TEST RESULT ..... 16**

    3.1 Conducted Output Power Measurement ..... 16

    3.2 Peak-to-Average Ratio ..... 28

    3.3 Effective Radiated Power and Equivalent Isotropic Radiated Power Measurement ..... 45

    3.4 Occupied Bandwidth ..... 69

    3.5 Conducted Band Edge Measurement ..... 202

    3.6 Conducted Spurious Emission Measurement ..... 292

    3.7 Radiated Spurious Emission Measurement ..... 360

    3.8 Frequency Stability Measurement ..... 494

**4 LIST OF MEASURING EQUIPMENT ..... 499**

**5 UNCERTAINTY OF EVALUATION ..... 500**





### SUMMARY OF TEST RESULT

Report Section	FCC Rule	IC Rule	Description	Limit	Result	Remark
3.1	§2.1046	RSS-Gen(4.8) RSS-130(4.4) RSS-132 (5.4) RSS-133 (6.4) RSS-139 (6.4) RSS-199 (4.4)	Conducted Output Power	Reporting Only	PASS	-
3.2	§24.232(d) §27.50(d)(5)	RSS-130(4.4) RSS-132 (5.4) RSS-133 (6.4) RSS-139 (6.4)	Peak-to-Average Ratio	<13 dB	PASS	-
3.3	§22.913(a)(2)	RSS-132(5.4) SRSP-503(5.1.3)	Effective Radiated Power (Band 5)	ERP < 7 Watt	PASS	-
	§27.50(c)(10)	N/A	Effective Radiated Power (Band 17)	ERP < 3 Watt		
	N/A	RSS-130(4.4)	Equivalent Isotropic Radiated Power (Band 17)	EIRP < 5 Watt		
	§24.232(c) §27.50(h)(2)	RSS-133 (6.4) SRSP-510(5.1.2) RSS-199 (4.4)	Equivalent Isotropic Radiated Power (Band 2) (Band 7)	EIRP < 2Watt		
	§27.50(d)(4)	RSS-139 (6.4) SRSP-513(5.1.2)	Equivalent Isotropic Radiated Power (Band 4)	EIRP < 1Watt		



Report Section	FCC Rule	IC Rule	Description	Limit	Result	Remark
3.4	§2.1049	RSS-GEN(4.6.1)	Occupied Bandwidth	Reporting Only	PASS	-
	§22.917(b)	RSS-132 (3.1)				
	§24.238(b)	RSS-133 (3.1)				
	§27.53(g)(3)	RSS-139 (3.1)				
	§27.53(l)(6)	RSS-199 (4.2)				
3.5	§2.1051	RSS-GEN(4.9)	Conducted Band Edge Measurement (Band 2) (Band 4) (Band 5) (Band 17) (Band 7)	< 43+10log10(P[Watt])	PASS	-
	§22.917(a)	RSS-132 (5.5)				
	§24.238(a)	RSS-133 (6.5.1)				
	§27.53(f)	RSS-130(4.6)				
	§27.53(g)	RSS-139 (6.5)				
3.6	§2.1051	RSS-GEN(4.9)	Conducted Spurious Emission (Band 2) (Band 4) (Band 5) (Band 17)	< 43+10log10(P[Watts])	PASS	-
	§22.917(a)	RSS-132 (5.5)				
	§24.238(a)	RSS-133 (6.5.1)				
	§27.53(f)	RSS-130(4.6)				
	§27.53(g)	RSS-139 (6.5)				
3.7	§2.1051	RSS-GEN(4.9)	Radiated Spurious Emission (Band 2) (Band 4) (Band 5) (Band 17)	< 43+10log10(P[Watts])	PASS	Under limit 15.01 dB at 10224.000 MHz
	§22.917(a)	RSS-132 (5.5)				
	§24.238(a)	RSS-133 (6.5.1)				
	§27.53(f)	RSS-130(4.6)				
	§27.53(g)	RSS-139 (6.5)				
3.6	§2.1051	RSS-GEN(4.9)	Conducted Spurious Emission (Band 7)	< 55+10log10(P[Watts])	PASS	-
	§27.53(l)(4)	RSS-199 (4.5)				
3.7	§2.1053	RSS-GEN(4.9)	Radiated Spurious Emission (Band 7)	< 55+10log10(P[Watts])	PASS	
	§27.53(l)(4)	RSS-199 (4.5)				



Report Section	FCC Rule	IC Rule	Description	Limit	Result	Remark
3.8	§2.1055 §22.355 §24.235 §27.54	RSS-GEN(4.7) RSS-132(5.3) RSS-133(6.3) RSS-130(4.3) RSS-139 (6.3) RSS-199 (4.3)	Frequency Stability Temperature & Voltage	< 2.5 ppm	PASS	-



# 1 General Description

## 1.1 Applicant

Motorola Mobility, LLC  
222 W Merchandise Mart Plaza, Suite 1800, Chicago, IL 60654, United States

## 1.2 Manufacturer

Motorola Mobility, LLC  
222 W Merchandise Mart Plaza, Suite 1800, Chicago, IL 60654, United States

## 1.3 Product Feature of Equipment Under Test

Product Feature	
Equipment	Mobile Cellular Phone
Brand Name	Motorola Mobility, LLC
Model Name	3578
FCC ID	IHDT56QA1
IC	109O-T56QA1
IMEI Code	359279050020079
EUT supports Radios application	GSM/EGPRS/WCDMA/HSPA/LTE/NFC WLAN 11b/g/n HT20 WLAN 11a/n HT20/HT40 WLAN 11ac VHT20/VHT40/VHT80 Bluetooth v3.0+ EDR Bluetooth v4.0 - LE
HW Version	P2
SW Version	KXE21.99.169
EUT Stage	Identical Prototype

**Remark:** The above EUT's information was declared by manufacturer. Please refer to the specifications or user's manual for more detailed description.

Accessory List	
AC Adapter	Brand Name : Motorola
	Model Name : SPN5788A
Earphone	Brand Name : Motorola
	Model Name : SJYN1305A

### 1.4 Product Specification subjective to this standard

Product Specification subjective to this standard	
<b>Tx Frequency</b>	LTE Band 2 : 1850.7 MHz ~ 1909.3 MHz LTE Band 4 : 1710.7 MHz ~ 1754.3 MHz LTE Band 5 : 824.7 MHz ~ 848.3 MHz LTE Band 7 : 2502.5 MHz ~ 2567.5 MHz LTE Band 17 : 706.5 MHz ~ 713.5 MHz
<b>Rx Frequency</b>	LTE Band 2 : 1930.7 MHz ~ 1989.3 MHz LTE Band 4 : 2110.7 MHz ~ 2154.3 MHz LTE Band 5 : 869.7 MHz ~ 893.3 MHz LTE Band 7 : 2622.5MHz ~ 2687.5 MHz LTE Band 17 : 736.5 MHz ~ 743.5 MHz
<b>Bandwidth</b>	LTE Band 2 : 1.4MHz / 3MHz / 5MHz / 10MHz / 15MHz / 20MHz LTE Band 4 : 1.4MHz / 3MHz / 5MHz / 10MHz / 15MHz / 20MHz LTE Band 5 : 1.4MHz / 3MHz / 5MHz / 10MHz LTE Band 7 : 5MHz / 10MHz / 15MHz / 20MHz LTE Band 17 : 5MHz / 10MHz
<b>Maximum Output Power to Antenna</b>	LTE Band 2 : 23.43 dBm LTE Band 4 : 23.72 dBm LTE Band 5 : 23.69 dBm LTE Band 7 : 23.77 dBm LTE Band 17 : 23.75 dBm
<b>Antenna Type</b>	Fixed Internal Antenna
<b>Type of Modulation</b>	QPSK / 16QAM

### 1.5 Modification of EUT

No modifications are made to the EUT during all test items.





### 1.6 Maximum ERP/EIRP Power, Frequency Tolerance, and Emission Designator

FCC Rule	System	Type of Modulation	BW	Emission Designator	Frequency Tolerance (ppm)	Maximum ERP/EIRP
Part 22	LTE Band 5	QPSK	1.4 MHz	1M10G7D	-	0.14 W
Part 22	LTE Band 5	16QAM	1.4 MHz	1M10D7W	-	0.07 W
Part 22	LTE Band 5	QPSK	3 MHz	2M73G7D	-	0.13 W
Part 22	LTE Band 5	16QAM	3 MHz	2M72D7W	-	0.07 W
Part 22	LTE Band 5	QPSK	5 MHz	4M49G7D	-	0.12 W
Part 22	LTE Band 5	16QAM	5 MHz	4M49D7W	-	0.08 W
Part 22	LTE Band 5	QPSK	10 MHz	9M10G7D	0.0106 ppm	0.13 W
Part 22	LTE Band 5	16QAM	10 MHz	9M08D7W	-	0.07 W
Part 24	LTE Band 2	QPSK	1.4 MHz	1M10G7D	-	0.48 W
Part 24	LTE Band 2	16QAM	1.4 MHz	1M10D7W	-	0.35 W
Part 24	LTE Band 2	QPSK	3 MHz	2M73G7D	-	0.47 W
Part 24	LTE Band 2	16QAM	3 MHz	2M73D7W	-	0.37 W
Part 24	LTE Band 2	QPSK	5 MHz	4M50G7D	-	0.50 W
Part 24	LTE Band 2	16QAM	5 MHz	4M51D7W	-	0.39 W
Part 24	LTE Band 2	QPSK	10 MHz	9M08G7D	0.0095 ppm	0.52 W
Part 24	LTE Band 2	16QAM	10 MHz	9M06D7W	-	0.40 W
Part 24	LTE Band 2	QPSK	15 MHz	13M5G7D	-	0.50 W
Part 24	LTE Band 2	16QAM	15 MHz	13M5D7W	-	0.40 W
Part 24	LTE Band 2	QPSK	20 MHz	18M5G7D	-	0.45 W
Part 24	LTE Band 2	16QAM	20 MHz	18M5D7W	-	0.37 W



FCC Rule	System	Type of Modulation	BW	Emission Designator	Frequency Tolerance (ppm)	Maximum ERP/EIRP
Part 27	LTE Band 4	QPSK	1.4 MHz	1M10G7D	-	0.60 W
Part 27	LTE Band 4	16QAM	1.4 MHz	1M10D7W	-	0.47 W
Part 27	LTE Band 4	QPSK	3 MHz	2M72G7D	-	0.45 W
Part 27	LTE Band 4	16QAM	3 MHz	2M72D7W	-	0.34 W
Part 27	LTE Band 4	QPSK	5MHz	4M50G7D	-	0.36 W
Part 27	LTE Band 4	16QAM	5MHz	4M50D7W	-	0.36 W
Part 27	LTE Band 4	QPSK	10MHz	9M08G7D	0.0094 ppm	0.44 W
Part 27	LTE Band 4	16QAM	10MHz	9M04D7W	-	0.34 W
Part 27	LTE Band 4	QPSK	15MHz	13M5G7D	-	0.39 W
Part 27	LTE Band 4	16QAM	15MHz	13M5D7W	-	0.31 W
Part 27	LTE Band 4	QPSK	20MHz	18M4G7D	-	0.33 W
Part 27	LTE Band 4	16QAM	20MHz	18M4D7W	-	0.26 W
Part 27	LTE Band 17	QPSK	5MHz	4M50G7D	-	0.09 W
Part 27	LTE Band 17	16QAM	5MHz	4M50D7W	-	0.05 W
Part 27	LTE Band 17	QPSK	10MHz	9M06G7D	0.0093 ppm	0.09 W
Part 27	LTE Band 17	16QAM	10MHz	9M04D7W	-	0.05 W
Part 27	LTE Band 7	QPSK	5MHz	4M50G7D	-	0.45 W
Part 27	LTE Band 7	16QAM	5MHz	4M50D7W	-	0.24 W
Part 27	LTE Band 7	QPSK	10MHz	9M10G7D	0.0129 ppm	0.36 W
Part 27	LTE Band 7	16QAM	10MHz	9M04D7W	-	0.20 W
Part 27	LTE Band 7	QPSK	15MHz	13M5G7D	-	0.32 W
Part 27	LTE Band 7	16QAM	15MHz	13M5D7W	-	0.21 W
Part 27	LTE Band 7	QPSK	20MHz	18M5G7D	-	0.29 W
Part 27	LTE Band 7	16QAM	20MHz	18M5D7W	-	0.20 W



### 1.7 Testing Location

Sporton Lab is accredited to ISO 17025 by Taiwan Accreditation Foundation (TAF code : 1190) and the FCC designation No. TW1022 under the FCC 2.948(e) by Mutual Recognition Agreement (MRA) in FCC Test.

<b>Test Site</b>	SPORTON INTERNATIONAL INC.		
<b>Test Site Location</b>	No. 52, Hwa Ya 1 <sup>st</sup> Rd., Hwa Ya Technology Park, Kwei-Shan Hsiang, Tao Yuan Hsien, Taiwan, R.O.C. TEL: +886-3-327-3456 FAX: +886-3-328-4978		
<b>Test Site No.</b>	<b>Sporton Site No.</b>		<b>IC Registration No.</b>
	TH02-HY	03CH07-HY	4086B-1

## 1.8 Applicable Standards

According to the specifications of the manufacturer, the EUT must comply with the requirements of the following standards:

- ♦ 47 CFR Part 2, 22(H), 24(E), 27
- ♦ ANSI / TIA / EIA-603-C-2004
- ♦ FCC KDB 971168 D01 Power Meas. License Digital Systems v02r01
- ♦ IC RSS-130 Issue1
- ♦ IC RSS-132 Issue 3
- ♦ IC RSS-133 Issue 6
- ♦ IC RSS-139 Issue 2
- ♦ IC RSS-199 Issue 1
- ♦ IC RSS-Gen Issue 3
- ♦ NOTICE 2012-DRS0126

### Remark:

1. All test items were verified and recorded according to the standards and without any deviation during the test.
2. This EUT has also been tested and complied with the requirements of FCC Part 15, Subpart B, recorded in a separate test report.
3. Per the section 2.2.3 of Notice of 2012-DRS0126, " Receivers Excluded from Industry Canada Requirements", only radiocommunication receivers operating in stand-alone mode within the band 30-960 MHz and scanner receivers are subject to Industry Canada requirements.



## 2 Test Configuration of Equipment Under Test

### 2.1 Test Mode

Antenna port conducted and radiated test items listed below are performed according to KDB 971168 D01 Power Meas. License Digital Systems v02r01 with maximum output power.

Radiated measurements are performed by rotating the EUT in three different orthogonal test planes to find the maximum emission.

Test Items	Band	Bandwidth (MHz)						Modulation		RB #			Test Channel		
		1.4	3	5	10	15	20	QPSK	16QAM	1	Half	Full	L	M	H
Max. Output Power	2	✓	✓	✓	✓	✓	✓	✓	✓	✓	✓	✓	✓	✓	✓
	4	✓	✓	✓	✓	✓	✓	✓	✓	✓	✓	✓	✓	✓	✓
	5	✓	✓	✓	✓	-	-	✓	✓	✓	✓	✓	✓	✓	✓
	7	-	-	✓	✓	✓	✓	✓	✓	✓	✓	✓	✓	✓	✓
	17	-	-	✓	✓	-	-	✓	✓	✓	✓	✓	✓	✓	✓
Peak-to-Average Ratio	2						✓		✓	✓		✓	✓	✓	✓
	4						✓		✓	✓		✓	✓	✓	✓
	5				✓	-	-		✓	✓		✓	✓	✓	✓
	7	-	-				✓		✓	✓		✓	✓	✓	✓
	17	-	-		✓	-	-		✓	✓		✓	✓	✓	✓
26dB and 99% Bandwidth	2	✓	✓	✓	✓	✓	✓	✓	✓			✓	✓	✓	✓
	4	✓	✓	✓	✓	✓	✓	✓	✓			✓	✓	✓	✓
	5	✓	✓	✓	✓	-	-	✓	✓			✓	✓	✓	✓
	7	-	-	✓	✓	✓	✓	✓	✓			✓	✓	✓	✓
	17	-	-	✓	✓	-	-	✓	✓			✓	✓	✓	✓
Conducted Band Edge	2	✓	✓	✓	✓	✓	✓	✓	✓	✓		✓	✓		✓
	4	✓	✓	✓	✓	✓	✓	✓	✓	✓		✓	✓		✓
	5	✓	✓	✓	✓	-	-	✓	✓	✓		✓	✓		✓
	7	-	-	✓	✓	✓	✓	✓	✓	✓		✓	✓		✓
	17	-	-	✓	✓	-	-	✓	✓	✓		✓	✓		✓



Test Items	Band	Bandwidth (MHz)						Modulation		RB #			Test Channel		
		1.4	3	5	10	15	20	QPSK	16QAM	1	Half	Full	L	M	H
Conducted Spurious Emission	2	√	√	√	√	√	√	√	√	√			√	√	√
	4	√	√	√	√	√	√	√	√	√			√	√	√
	5	√	√	√	√	-	-	√	√	√			√	√	√
	7	-	-	√	√	√	√	√	√	√			√	√	√
	17	-	-	√	√	-	-	√	√	√			√	√	√
Frequency Stability	2				√			√				√		√	
	4				√			√				√		√	
	5				√	-	-	√				√		√	
	7	-	-		√			√				√		√	
	17	-	-		√	-	-	√				√		√	
E.R.P./ E.I.R.P.	2	√	√	√	√	√	√	√	√	√			√	√	√
	4	√	√	√	√	√	√	√	√	√			√	√	√
	5	√	√	√	√	-	-	√	√	√			√	√	√
	7	-	-	√	√	√	√	√	√	√			√	√	√
	17	-	-	√	√	-	-	√	√	√			√	√	√
Radiated Spurious Emission	2	√	√	√	√	√	√	√		√			√	√	√
	4	√	√	√	√	√	√	√		√			√	√	√
	5	√	√	√	√	-	-	√		√			√	√	√
	7	-	-	√	√	√	√	√		√			√	√	√
	17	-	-	√	√	-	-	√		√			√	√	√
Note	<p>1. The mark “√” means that this configuration is chosen for testing</p> <p>2. The mark “-” means that this bandwidth is not supported.</p> <p>3. The device is investigated from 30MHz to 10 times of fundamental signal for radiated spurious emission test under different RB size/offset and modulations in exploratory test. Subsequently, only the worst case emissions are reported.</p>														

## 2.2 Connection Diagram of Test System

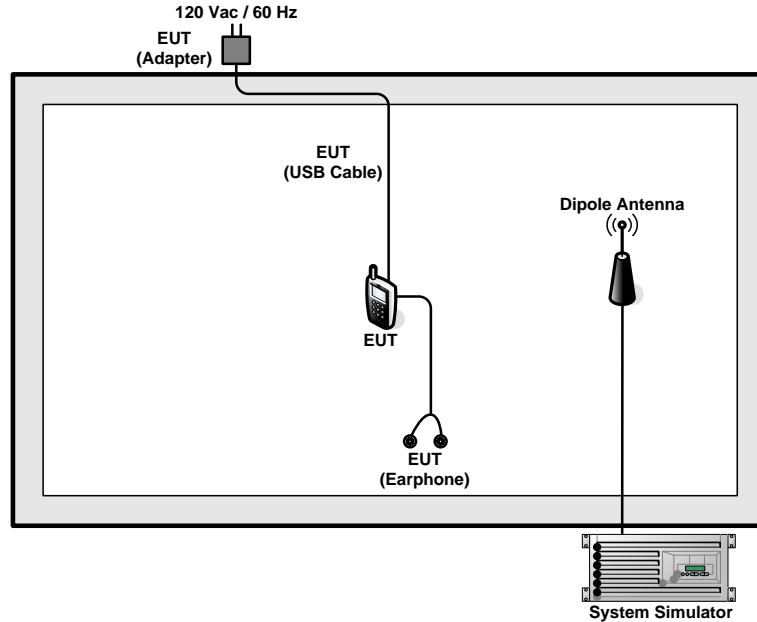

## 2.3 Support Unit used in test configuration and system

Item	Equipment	Trade Name	Model No.	FCC ID	Data Cable	Power Cord
1.	System Simulator	Anritsu	MT8820C	N/A	N/A	Unshielded, 1.8 m

## 2.4 Measurement Results Explanation Example

### For all conducted test items:

The offset level is set in the spectrum analyzer to compensate the RF cable loss and attenuator factor between EUT conducted output port and spectrum analyzer. With the offset compensation, the spectrum analyzer reading level is exactly the EUT RF output level.

The spectrum analyzer offset is derived from RF cable loss and attenuator factor.

*Offset = RF cable loss + attenuator factor.*

Following shows an offset computation example with cable loss 4.2 dB and 10dB attenuator.

Example :

$$\begin{aligned} \text{Offset(dB)} &= \text{RF cable loss(dB)} + \text{attenuator factor(dB)} \\ &= 4.2 + 10 = 14.2 \text{ (dB)} \end{aligned}$$

### 3 Test Result

#### 3.1 Conducted Output Power Measurement

##### 3.1.1 Description of the Conducted Output Power Measurement

A system simulator was used to establish communication with the EUT. Its parameters were set to force the EUT transmitting at maximum output power. The measured power in the radio frequency on the transmitter output terminals shall be reported.

##### 3.1.2 Measuring Instruments

The measuring equipment is listed in the section 4 of this test report.

##### 3.1.3 Test Procedures

1. The transmitter output port was connected to the system simulator.
2. Set EUT at maximum power through the system simulator.
3. Select lowest, middle, and highest channels for each band and different modulation.
4. Measure and record the power level from the system simulator.

##### 3.1.4 Test Setup







3.1.5 Test Result of Conducted Output Power

<LTE Band 5 Conducted Power>

BW [MHz]	Modulation	RB Size	RB Offset	Power (dBm) Low Ch. / Freq.	Power (dBm) Middle Ch. / Freq.	Power (dBm) High Ch. / Freq.
<b>Channel</b>				<b>20450</b>	<b>20525</b>	<b>20600</b>
<b>Frequency (MHz)</b>				<b>829</b>	<b>836.5</b>	<b>844</b>
10	QPSK	1	0	23.69	23.39	23.41
10	QPSK	1	24	23.41	23.38	23.53
10	QPSK	1	49	23.38	23.53	23.59
10	QPSK	25	0	22.52	22.42	22.52
10	QPSK	25	12	22.46	22.48	22.61
10	QPSK	25	24	22.47	22.47	22.61
10	QPSK	50	0	22.58	22.57	22.69
10	16QAM	1	0	22.58	22.39	22.46
10	16QAM	1	24	22.39	22.40	22.45
10	16QAM	1	49	22.42	22.53	22.44
10	16QAM	25	0	21.53	21.45	21.54
10	16QAM	25	12	21.46	21.44	21.62
10	16QAM	25	24	21.47	21.49	21.62
10	16QAM	50	0	21.50	21.51	21.67
<b>Channel</b>				<b>20425</b>	<b>20525</b>	<b>20625</b>
<b>Frequency (MHz)</b>				<b>826.5</b>	<b>836.5</b>	<b>846.5</b>
5	QPSK	1	0	23.59	23.42	23.56
5	QPSK	1	12	23.50	23.37	23.67
5	QPSK	1	24	23.44	23.40	23.58
5	QPSK	12	0	22.58	22.47	22.61
5	QPSK	12	6	22.52	22.45	22.69
5	QPSK	12	11	22.55	22.45	22.60
5	QPSK	25	0	22.53	22.46	22.62
5	16QAM	1	0	22.60	22.38	22.56
5	16QAM	1	12	22.43	22.31	22.60
5	16QAM	1	24	22.37	22.35	22.56
5	16QAM	12	0	21.57	21.48	21.63
5	16QAM	12	6	21.57	21.47	21.71
5	16QAM	12	11	21.57	21.47	21.64
5	16QAM	25	0	21.60	21.48	21.64



BW [MHz]	Modulation	RB Size	RB Offset	Power (dBm) Low Ch. / Freq.	Power (dBm) Middle Ch. / Freq.	Power (dBm) High Ch. / Freq.
<b>Channel</b>				<b>20415</b>	<b>20525</b>	<b>20635</b>
<b>Frequency (MHz)</b>				<b>825.5</b>	<b>836.5</b>	<b>847.5</b>
3	QPSK	1	0	23.64	23.38	23.67
3	QPSK	1	7	23.53	23.35	23.52
3	QPSK	1	14	23.55	23.41	23.57
3	QPSK	8	0	22.61	22.42	22.68
3	QPSK	8	4	22.52	22.46	22.60
3	QPSK	8	7	22.55	22.45	22.65
3	QPSK	15	0	22.60	22.49	22.60
3	16QAM	1	0	22.62	22.40	22.66
3	16QAM	1	7	22.42	22.31	22.48
3	16QAM	1	14	22.48	22.39	22.56
3	16QAM	8	0	21.69	21.51	21.74
3	16QAM	8	4	21.55	21.48	21.67
3	16QAM	8	7	21.60	21.53	21.61
3	16QAM	15	0	21.54	21.46	21.63
<b>Channel</b>				<b>20407</b>	<b>20525</b>	<b>20643</b>
<b>Frequency (MHz)</b>				<b>824.7</b>	<b>836.5</b>	<b>848.3</b>
1.4	QPSK	1	0	23.65	23.46	23.60
1.4	QPSK	1	2	23.64	23.45	23.59
1.4	QPSK	1	5	23.60	23.45	23.63
1.4	QPSK	3	0	23.68	23.48	23.67
1.4	QPSK	3	1	23.66	23.49	23.64
1.4	QPSK	3	2	23.62	23.44	23.65
1.4	QPSK	6	0	22.71	22.54	22.69
1.4	16QAM	1	0	22.65	22.44	22.59
1.4	16QAM	1	2	22.62	22.41	22.63
1.4	16QAM	1	5	22.49	22.41	22.62
1.4	16QAM	3	0	22.64	22.43	22.62
1.4	16QAM	3	1	22.63	22.42	22.60
1.4	16QAM	3	2	22.64	22.42	22.60
1.4	16QAM	6	0	21.56	21.34	21.53



<LTE Band 2 Conducted Power>

BW [MHz]	Modulation	RB Size	RB Offset	Power (dBm) Low Ch. / Freq.	Power (dBm) Middle Ch. / Freq.	Power (dBm) High Ch. / Freq.
<b>Channel</b>				<b>18700</b>	<b>18900</b>	<b>19100</b>
<b>Frequency (MHz)</b>				<b>1860</b>	<b>1880</b>	<b>1900</b>
20	QPSK	1	0	23.30	23.43	23.27
20	QPSK	1	49	23.25	23.38	23.21
20	QPSK	1	99	23.23	23.36	23.25
20	QPSK	50	0	22.32	22.35	22.49
20	QPSK	50	24	22.37	22.41	22.47
20	QPSK	50	49	22.36	22.40	22.40
20	QPSK	100	0	22.31	22.43	22.48
20	16QAM	1	0	22.28	22.24	22.43
20	16QAM	1	49	22.26	22.33	22.39
20	16QAM	1	99	22.14	22.34	22.35
20	16QAM	50	0	21.23	21.27	21.41
20	16QAM	50	24	21.26	21.34	21.43
20	16QAM	50	49	21.28	21.29	21.32
20	16QAM	100	0	21.25	21.36	21.42
<b>Channel</b>				<b>18675</b>	<b>18900</b>	<b>19125</b>
<b>Frequency (MHz)</b>				<b>1857.5</b>	<b>1880</b>	<b>1902.5</b>
15	QPSK	1	0	23.33	23.25	23.38
15	QPSK	1	37	23.28	23.37	23.37
15	QPSK	1	74	23.26	23.33	23.23
15	QPSK	36	0	22.27	22.37	22.41
15	QPSK	36	18	22.29	22.35	22.42
15	QPSK	36	37	22.32	22.36	22.40
15	QPSK	75	0	22.32	22.40	22.43
15	16QAM	1	0	22.27	22.19	22.36
15	16QAM	1	37	22.18	22.30	22.35
15	16QAM	1	74	22.22	22.27	22.33
15	16QAM	36	0	21.13	21.31	21.36
15	16QAM	36	18	21.20	21.28	21.38
15	16QAM	36	37	21.18	21.24	21.28
15	16QAM	75	0	21.27	21.34	21.34



BW [MHz]	Modulation	RB Size	RB Offset	Power (dBm) Low Ch. / Freq.	Power (dBm) Middle Ch. / Freq.	Power (dBm) High Ch. / Freq.
<b>Channel</b>				<b>18650</b>	<b>18900</b>	<b>19150</b>
<b>Frequency (MHz)</b>				<b>1855</b>	<b>1880</b>	<b>1905</b>
10	QPSK	1	0	23.31	23.28	23.40
10	QPSK	1	24	23.23	23.30	23.37
10	QPSK	1	49	23.27	23.32	23.36
10	QPSK	25	0	22.31	22.35	22.47
10	QPSK	25	12	22.22	22.35	22.37
10	QPSK	25	24	22.23	22.40	22.40
10	QPSK	50	0	22.31	22.43	22.42
10	16QAM	1	0	22.26	22.26	22.38
10	16QAM	1	24	22.17	22.34	22.35
10	16QAM	1	49	22.21	22.30	22.34
10	16QAM	25	0	21.33	21.34	21.42
10	16QAM	25	12	21.19	21.34	21.34
10	16QAM	25	24	21.23	21.32	21.34
10	16QAM	50	0	21.20	21.32	21.31
<b>Channel</b>				<b>18625</b>	<b>18900</b>	<b>19175</b>
<b>Frequency (MHz)</b>				<b>1852.5</b>	<b>1880</b>	<b>1907.5</b>
5	QPSK	1	0	23.29	23.26	23.41
5	QPSK	1	12	23.32	23.35	23.40
5	QPSK	1	24	23.21	23.36	23.36
5	QPSK	12	0	22.35	22.39	22.38
5	QPSK	12	6	22.31	22.37	22.41
5	QPSK	12	11	22.33	22.39	22.44
5	QPSK	25	0	22.29	22.37	22.39
5	16QAM	1	0	22.20	22.18	22.39
5	16QAM	1	12	22.23	22.24	22.32
5	16QAM	1	24	22.08	22.25	22.33
5	16QAM	12	0	21.29	21.35	21.36
5	16QAM	12	6	21.28	21.34	21.37
5	16QAM	12	11	21.28	21.32	21.39
5	16QAM	25	0	21.27	21.33	21.37



BW [MHz]	Modulation	RB Size	RB Offset	Power (dBm) Low Ch. / Freq.	Power (dBm) Middle Ch. / Freq.	Power (dBm) High Ch. / Freq.
<b>Channel</b>				<b>18615</b>	<b>18900</b>	<b>19185</b>
<b>Frequency (MHz)</b>				<b>1851.5</b>	<b>1880</b>	<b>1908.5</b>
3	QPSK	1	0	23.28	23.35	23.40
3	QPSK	1	7	23.24	23.36	23.36
3	QPSK	1	14	23.31	23.37	23.31
3	QPSK	8	0	22.29	22.39	22.42
3	QPSK	8	4	22.27	22.36	22.40
3	QPSK	8	7	22.28	22.40	22.41
3	QPSK	15	0	22.29	22.43	22.42
3	16QAM	1	0	22.24	22.28	22.34
3	16QAM	1	7	22.19	22.27	22.33
3	16QAM	1	14	22.23	22.26	22.40
3	16QAM	8	0	21.26	21.34	21.39
3	16QAM	8	4	21.27	21.38	21.39
3	16QAM	8	7	21.29	21.33	21.43
3	16QAM	15	0	21.25	21.30	21.38
<b>Channel</b>				<b>18607</b>	<b>18900</b>	<b>19193</b>
<b>Frequency (MHz)</b>				<b>1850.7</b>	<b>1880</b>	<b>1909.3</b>
1.4	QPSK	1	0	23.35	23.41	23.35
1.4	QPSK	1	2	23.32	23.38	23.32
1.4	QPSK	1	5	23.35	23.36	23.28
1.4	QPSK	3	0	23.33	23.35	23.26
1.4	QPSK	3	1	23.37	23.37	23.31
1.4	QPSK	3	2	23.37	23.31	23.30
1.4	QPSK	6	0	22.40	22.43	22.52
1.4	16QAM	1	0	22.28	22.35	22.39
1.4	16QAM	1	2	22.25	22.32	22.42
1.4	16QAM	1	5	22.25	22.31	22.34
1.4	16QAM	3	0	22.28	22.33	22.41
1.4	16QAM	3	1	22.26	22.31	22.38
1.4	16QAM	3	2	22.26	22.29	22.39
1.4	16QAM	6	0	21.12	21.23	21.27



<LTE Band 4 Conducted Power>

BW [MHz]	Modulation	RB Size	RB Offset	Power (dBm) Low Ch. / Freq.	Power (dBm) Middle Ch. / Freq.	Power (dBm) High Ch. / Freq.
<b>Channel</b>				<b>20050</b>	<b>20175</b>	<b>20300</b>
<b>Frequency (MHz)</b>				<b>1720</b>	<b>1732.5</b>	<b>1745</b>
20	QPSK	1	0	23.60	23.65	23.72
20	QPSK	1	49	23.59	23.66	23.68
20	QPSK	1	99	23.59	23.59	23.61
20	QPSK	50	0	22.73	22.77	22.75
20	QPSK	50	24	22.70	22.78	22.77
20	QPSK	50	49	22.65	22.72	22.70
20	QPSK	100	0	22.70	22.72	22.71
20	16QAM	1	0	22.55	22.65	22.70
20	16QAM	1	49	22.56	22.60	22.62
20	16QAM	1	99	22.58	22.55	22.53
20	16QAM	50	0	21.62	21.69	21.72
20	16QAM	50	24	21.64	21.69	21.70
20	16QAM	50	49	21.61	21.66	21.62
20	16QAM	100	0	21.61	21.71	21.72
<b>Channel</b>				<b>20025</b>	<b>20175</b>	<b>20325</b>
<b>Frequency (MHz)</b>				<b>1717.5</b>	<b>1732.5</b>	<b>1747.5</b>
15	QPSK	1	0	23.61	23.69	23.70
15	QPSK	1	37	23.58	23.64	23.69
15	QPSK	1	74	23.62	23.63	23.58
15	QPSK	36	0	22.63	22.71	22.69
15	QPSK	36	18	22.67	22.67	22.65
15	QPSK	36	37	22.60	22.72	22.64
15	QPSK	75	0	22.66	22.77	22.75
15	16QAM	1	0	22.60	22.64	22.70
15	16QAM	1	37	22.58	22.60	22.60
15	16QAM	1	74	22.58	22.56	22.53
15	16QAM	36	0	21.55	21.66	21.67
15	16QAM	36	18	21.58	21.61	21.61
15	16QAM	36	37	21.57	21.57	21.57
15	16QAM	75	0	21.59	21.69	21.67



BW [MHz]	Modulation	RB Size	RB Offset	Power (dBm) Low Ch. / Freq.	Power (dBm) Middle Ch. / Freq.	Power (dBm) High Ch. / Freq.
<b>Channel</b>				<b>20000</b>	<b>20175</b>	<b>20350</b>
<b>Frequency (MHz)</b>				<b>1715</b>	<b>1732.5</b>	<b>1750</b>
10	QPSK	1	0	23.56	23.64	23.69
10	QPSK	1	24	23.51	23.62	23.61
10	QPSK	1	49	23.55	23.66	23.56
10	QPSK	25	0	22.61	22.70	22.66
10	QPSK	25	12	22.58	22.66	22.70
10	QPSK	25	24	22.58	22.70	22.68
10	QPSK	50	0	22.67	22.75	22.75
10	16QAM	1	0	22.52	22.60	22.61
10	16QAM	1	24	22.50	22.57	22.61
10	16QAM	1	49	22.55	22.57	22.57
10	16QAM	25	0	21.57	21.65	21.68
10	16QAM	25	12	21.58	21.64	21.63
10	16QAM	25	24	21.59	21.61	21.61
10	16QAM	50	0	21.60	21.67	21.67
<b>Channel</b>				<b>19975</b>	<b>20175</b>	<b>20375</b>
<b>Frequency (MHz)</b>				<b>1712.5</b>	<b>1732.5</b>	<b>1752.5</b>
5	QPSK	1	0	23.58	23.64	23.61
5	QPSK	1	12	23.51	23.60	23.62
5	QPSK	1	24	23.52	23.65	23.61
5	QPSK	12	0	22.61	22.70	22.70
5	QPSK	12	6	22.61	22.64	22.64
5	QPSK	12	11	22.61	22.64	22.68
5	QPSK	25	0	22.58	22.66	22.62
5	16QAM	1	0	22.53	22.60	22.58
5	16QAM	1	12	22.52	22.57	22.55
5	16QAM	1	24	22.50	22.55	22.53
5	16QAM	12	0	21.60	21.68	21.68
5	16QAM	12	6	21.59	21.66	21.65
5	16QAM	12	11	21.58	21.65	21.64
5	16QAM	25	0	21.56	21.67	21.67



BW [MHz]	Modulation	RB Size	RB Offset	Power (dBm) Low Ch. / Freq.	Power (dBm) Middle Ch. / Freq.	Power (dBm) High Ch. / Freq.
<b>Channel</b>				<b>19965</b>	<b>20175</b>	<b>20385</b>
<b>Frequency (MHz)</b>				<b>1711.5</b>	<b>1732.5</b>	<b>1753.5</b>
3	QPSK	1	0	23.52	23.64	23.66
3	QPSK	1	7	23.55	23.64	23.62
3	QPSK	1	14	23.56	23.69	23.60
3	QPSK	8	0	22.57	22.65	22.70
3	QPSK	8	4	22.61	22.65	22.68
3	QPSK	8	7	22.57	22.68	22.65
3	QPSK	15	0	22.58	22.70	22.65
3	16QAM	1	0	22.51	22.63	22.62
3	16QAM	1	7	22.49	22.56	22.56
3	16QAM	1	14	22.55	22.62	22.58
3	16QAM	8	0	21.58	21.69	21.69
3	16QAM	8	4	21.60	21.71	21.69
3	16QAM	8	7	21.55	21.66	21.66
3	16QAM	15	0	21.54	21.63	21.62
<b>Channel</b>				<b>19957</b>	<b>20175</b>	<b>20393</b>
<b>Frequency (MHz)</b>				<b>1710.7</b>	<b>1732.5</b>	<b>1754.3</b>
1.4	QPSK	1	0	23.57	23.71	23.70
1.4	QPSK	1	2	23.56	23.67	23.63
1.4	QPSK	1	5	23.60	23.70	23.66
1.4	QPSK	3	0	23.57	23.69	23.68
1.4	QPSK	3	1	23.56	23.70	23.65
1.4	QPSK	3	2	23.58	23.64	23.67
1.4	QPSK	6	0	22.65	22.71	22.75
1.4	16QAM	1	0	22.52	22.67	22.63
1.4	16QAM	1	2	22.52	22.66	22.60
1.4	16QAM	1	5	22.52	22.59	22.59
1.4	16QAM	3	0	22.57	22.65	22.66
1.4	16QAM	3	1	22.52	22.61	22.61
1.4	16QAM	3	2	22.50	22.61	22.60
1.4	16QAM	6	0	21.46	21.55	21.55





<LTE Band 17 Conducted Power>

BW [MHz]	Modulation	RB Size	RB Offset	Power (dBm) Low Ch. / Freq.	Power (dBm) Middle Ch. / Freq.	Power (dBm) High Ch. / Freq.
<b>Channel</b>				<b>23780</b>	<b>23790</b>	<b>23800</b>
<b>Frequency (MHz)</b>				<b>709</b>	<b>710</b>	<b>711</b>
10	QPSK	1	0	23.67	23.75	23.56
10	QPSK	1	24	23.61	23.56	23.51
10	QPSK	1	49	23.59	23.55	23.60
10	QPSK	25	0	22.65	22.63	22.64
10	QPSK	25	12	22.67	22.64	22.68
10	QPSK	25	24	22.70	22.60	22.57
10	QPSK	50	0	22.77	22.71	22.74
10	16QAM	1	0	22.66	22.64	22.56
10	16QAM	1	24	22.61	22.58	22.53
10	16QAM	1	49	22.60	22.57	22.63
10	16QAM	25	0	21.64	21.63	21.65
10	16QAM	25	12	21.66	21.66	21.66
10	16QAM	25	24	21.74	21.60	21.62
10	16QAM	50	0	21.72	21.71	21.72
<b>Channel</b>				<b>23755</b>	<b>23790</b>	<b>23825</b>
<b>Frequency (MHz)</b>				<b>706.5</b>	<b>710</b>	<b>713.5</b>
5	QPSK	1	0	23.72	23.60	23.50
5	QPSK	1	12	23.60	23.65	23.53
5	QPSK	1	24	23.69	23.57	23.50
5	QPSK	12	0	22.73	22.67	22.64
5	QPSK	12	6	22.69	22.67	22.64
5	QPSK	12	11	22.69	22.74	22.66
5	QPSK	25	0	22.69	22.69	22.62
5	16QAM	1	0	22.71	22.59	22.49
5	16QAM	1	12	22.58	22.61	22.51
5	16QAM	1	24	22.66	22.55	22.54
5	16QAM	12	0	21.71	21.72	21.65
5	16QAM	12	6	21.72	21.74	21.64
5	16QAM	12	11	21.75	21.75	21.66
5	16QAM	25	0	21.73	21.71	21.63



<LTE Band 7 Conducted Power>

BW [MHz]	Modulation	RB Size	RB Offset	Power (dBm) Low Ch. / Freq.	Power (dBm) Middle Ch. / Freq.	Power (dBm) High Ch. / Freq.
<b>Channel</b>				<b>20850</b>	<b>21100</b>	<b>21350</b>
<b>Frequency (MHz)</b>				<b>2510</b>	<b>2535</b>	<b>2560</b>
20	QPSK	1	0	23.41	23.77	23.29
20	QPSK	1	49	23.44	23.71	23.29
20	QPSK	1	99	23.68	23.56	23.50
20	QPSK	50	0	22.43	22.67	22.30
20	QPSK	50	24	22.42	22.74	22.27
20	QPSK	50	49	22.55	22.73	22.33
20	QPSK	100	0	22.39	22.73	22.35
20	16QAM	1	0	22.35	22.32	22.44
20	16QAM	1	49	22.34	22.37	22.42
20	16QAM	1	99	22.39	22.17	22.39
20	16QAM	50	0	21.44	21.79	21.48
20	16QAM	50	24	21.45	21.80	21.33
20	16QAM	50	49	21.58	21.78	21.38
20	16QAM	100	0	21.51	21.74	21.34
<b>Channel</b>				<b>20825</b>	<b>21100</b>	<b>21375</b>
<b>Frequency (MHz)</b>				<b>2507.5</b>	<b>2535.0</b>	<b>2562.5</b>
15	QPSK	1	0	23.42	23.71	23.29
15	QPSK	1	37	23.40	23.72	23.35
15	QPSK	1	74	23.60	23.65	23.51
15	QPSK	36	0	22.40	22.71	22.28
15	QPSK	36	18	22.33	22.73	22.30
15	QPSK	36	37	22.50	22.67	22.34
15	QPSK	75	0	22.45	22.74	22.34
15	16QAM	1	0	22.38	22.63	22.23
15	16QAM	1	37	22.32	22.64	22.27
15	16QAM	1	74	22.51	22.54	22.39
15	16QAM	36	0	21.44	21.77	21.29
15	16QAM	36	18	21.37	21.74	21.31
15	16QAM	36	37	21.52	21.72	21.40
15	16QAM	75	0	21.50	21.78	21.37



BW [MHz]	Modulation	RB Size	RB Offset	Power (dBm) Low Ch. / Freq.	Power (dBm) Middle Ch. / Freq.	Power (dBm) High Ch. / Freq.
<b>Channel</b>				<b>20800</b>	<b>21100</b>	<b>21400</b>
<b>Frequency (MHz)</b>				<b>2505.0</b>	<b>2535.0</b>	<b>2565.0</b>
10	QPSK	1	0	23.38	23.74	23.32
10	QPSK	1	24	23.44	23.71	23.35
10	QPSK	1	49	23.46	23.73	23.50
10	QPSK	25	0	22.33	22.68	22.32
10	QPSK	25	12	22.44	22.64	22.34
10	QPSK	25	24	22.35	22.67	22.39
10	QPSK	50	0	22.38	22.66	22.39
10	16QAM	1	0	22.35	22.63	22.23
10	16QAM	1	24	22.34	22.63	22.27
10	16QAM	1	49	22.33	22.64	22.36
10	16QAM	25	0	21.39	21.81	21.39
10	16QAM	25	12	21.46	21.83	21.36
10	16QAM	25	24	21.41	21.79	21.45
10	16QAM	50	0	21.43	21.76	21.33
<b>Channel</b>				<b>20775</b>	<b>21100</b>	<b>21425</b>
<b>Frequency (MHz)</b>				<b>2502.5</b>	<b>2535.0</b>	<b>2567.5</b>
5	QPSK	1	0	23.37	23.71	23.37
5	QPSK	1	12	23.36	23.74	23.38
5	QPSK	1	24	23.42	23.72	23.50
5	QPSK	12	0	22.48	22.70	22.35
5	QPSK	12	6	22.37	22.73	22.36
5	QPSK	12	11	22.34	22.73	22.42
5	QPSK	25	0	22.38	22.74	22.37
5	16QAM	1	0	22.30	22.65	22.24
5	16QAM	1	12	22.23	22.66	22.27
5	16QAM	1	24	22.35	22.63	22.35
5	16QAM	12	0	21.51	21.80	21.40
5	16QAM	12	6	21.42	21.81	21.43
5	16QAM	12	11	21.43	21.80	21.46
5	16QAM	25	0	21.44	21.82	21.42

Note: maximum average power for LTE.

### 3.2 Peak-to-Average Ratio

#### 3.2.1 Description of the PAR Measurement

Power Complementary Cumulative Distribution Function (CCDF) curves provide a means for characterizing the power peaks of a digitally modulated signal on a statistical basis. A CCDF curve depicts the probability of the peak signal amplitude exceeding the average power level. Most contemporary measurement instrumentation include the capability to produce CCDF curves for an input signal provided that the instrument's resolution bandwidth can be set wide enough to accommodate the entire input signal bandwidth. In measuring transmissions in this band using an average power technique, the peak-to-average ratio (PAR) of the transmission may not exceed 13 dB.

#### 3.2.2 Measuring Instruments

The measuring equipment is listed in the section 4 of this test report.

#### 3.2.3 Test Procedures

1. The EUT was connected to spectrum and system simulator via a power divider.
2. Set the CCDF (Complementary Cumulative Distribution Function) option in spectrum analyzer.
3. The highest RF powers were measured and recorded the maximum PAPR level associated with a probability of 0.1 %.
4. Record the deviation as Peak to Average Ratio.

#### 3.2.4 Test Setup

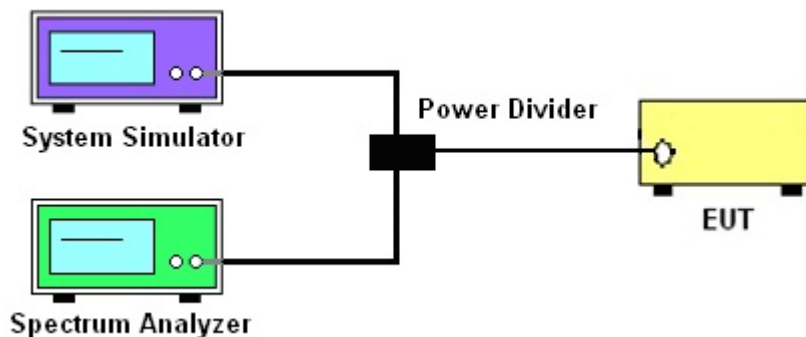



3.2.5 Test Result of Peak-to-Average Ratio

LTE Band 5						
BW [MHz]	Modulation	RB Size	RB Offset	Power (dBm) Low Ch. / Freq.	Power (dBm) Middle Ch. / Freq.	Power (dBm) High Ch. / Freq.
Channel				20450	20525	20600
Frequency (MHz)				829	836.5	844
10	16QAM	1	0	7.02	6.54	6.51
10	16QAM	50	0	6.60	6.41	6.60

LTE Band 2						
BW [MHz]	Modulation	RB Size	RB Offset	Power (dBm) Low Ch. / Freq.	Power (dBm) Middle Ch. / Freq.	Power (dBm) High Ch. / Freq.
Channel				18700	18900	19100
Frequency (MHz)				1860	1880	1900
20	16QAM	1	0	6.73	6.83	6.96
20	16QAM	100	0	6.54	6.70	6.44

LTE Band 4						
BW [MHz]	Modulation	RB Size	RB Offset	Power (dBm) Low Ch. / Freq.	Power (dBm) Middle Ch. / Freq.	Power (dBm) High Ch. / Freq.
Channel				20050	20175	20300
Frequency (MHz)				1720	1732.5	1745
20	16QAM	1	0	6.70	7.08	7.21
20	16QAM	100	0	6.70	6.70	6.57

LTE Band 17						
BW [MHz]	Modulation	RB Size	RB Offset	Power (dBm) Low Ch. / Freq.	Power (dBm) Middle Ch. / Freq.	Power (dBm) High Ch. / Freq.
Channel				23780	23790	23800
Frequency (MHz)				709	710	711
10	16QAM	1	0	6.70	6.70	6.73
10	16QAM	50	0	6.54	6.44	6.44

LTE Band 2						
BW [MHz]	Modulation	RB Size	RB Offset	Power (dBm) Low Ch. / Freq.	Power (dBm) Middle Ch. / Freq.	Power (dBm) High Ch. / Freq.
Channel				20850	21100	21350
Frequency (MHz)				2510.0	2535.0	2560.0
20	16QAM	1	0	5.19	6.22	6.35
20	16QAM	100	0	6.15	6.28	6.38



### 3.2.6 Peak to Average Power Ratio

#### Peak-to-Average Ratio on LTE Band 5

#### 10MHz / 16QAM in Ch. 20450 (1RB Size)

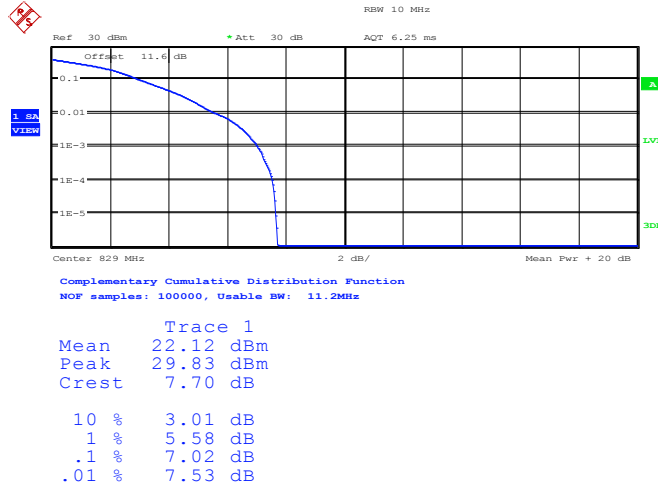

Date: 9.MAY.2014 14:49:35

#### Peak-to-Average Ratio on LTE Band 5

#### 10MHz / 16QAM in Ch. 20525 (1RB Size)

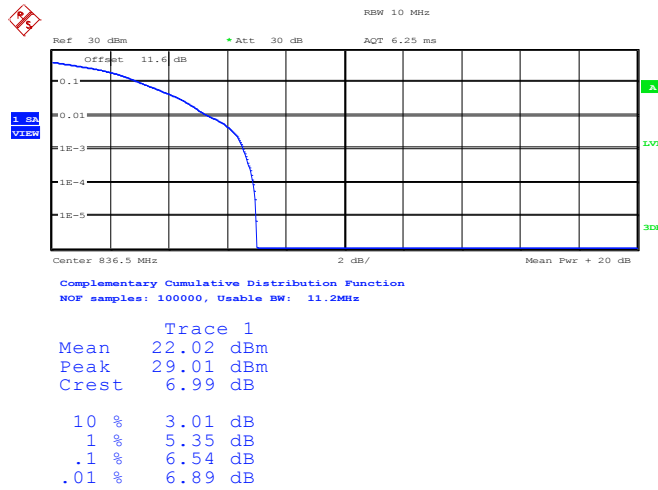

Date: 9.MAY.2014 14:50:15



Peak-to-Average Ratio on LTE Band 5

10MHz / 16QAM in Ch. 20600 (1RB Size)

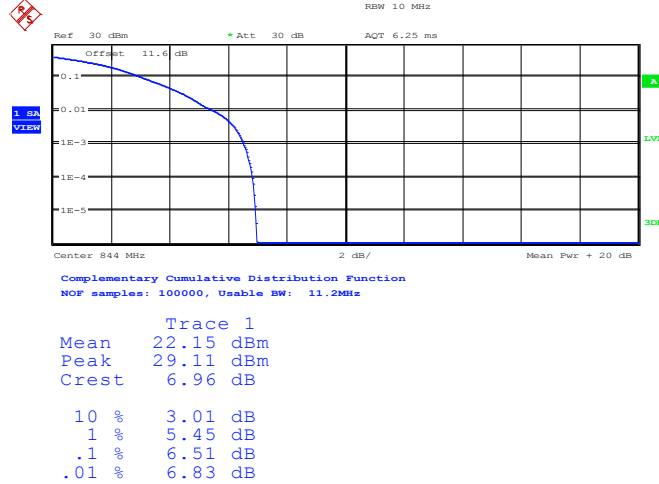

Date: 9.MAY.2014 14:51:12

Peak-to-Average Ratio on LTE Band 5

10MHz / 16QAM in Ch. 20450 (50RB Size)

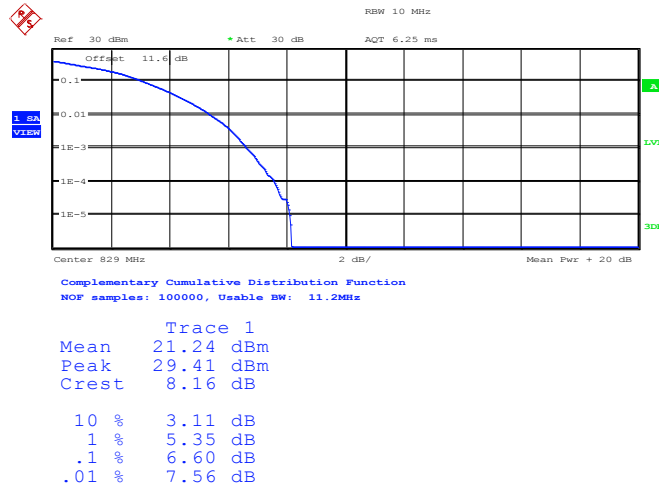

Date: 9.MAY.2014 14:49:56



Peak-to-Average Ratio on LTE Band 5  
10MHz / 16QAM in Ch. 20525 (50RB Size)

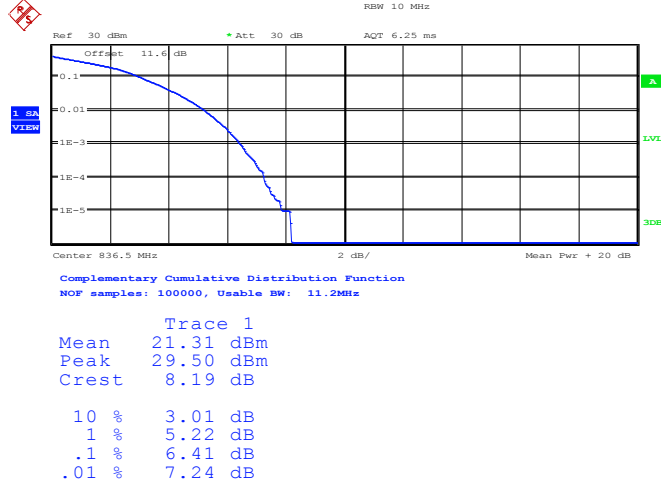

Date: 9.MAY.2014 14:50:52

Peak-to-Average Ratio on LTE Band 5  
10MHz / 16QAM in Ch. 20600 (50RB Size)

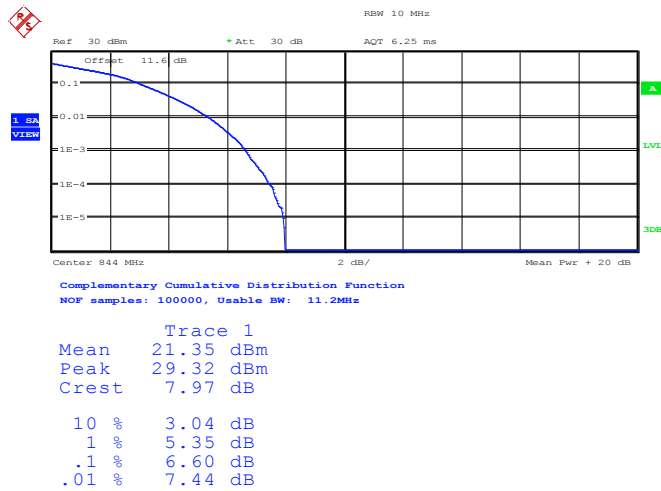

Date: 9.MAY.2014 14:51:35





Peak-to-Average Ratio on LTE Band 2  
20MHz / 16QAM in Ch. 18700 (1RB Size)

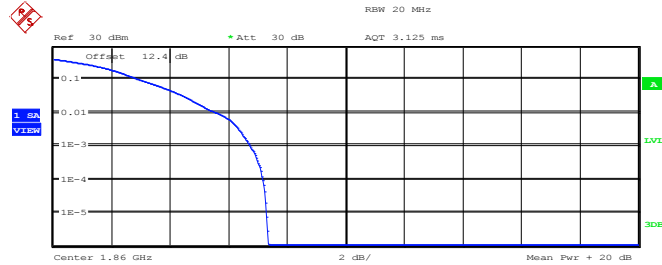

Complementary Cumulative Distribution Function  
NOF samples: 100000, Usable BW: 23.7MHz

Trace 1	
Mean	20.33 dBm
Peak	27.68 dBm
Crest	7.35 dB
10 %	2.95 dB
1 %	5.61 dB
.1 %	6.73 dB
.01 %	7.18 dB

Date: 9.MAY.2014 16:46:00

Peak-to-Average Ratio on LTE Band 2  
20MHz / 16QAM in Ch. 18900 (1RB Size)

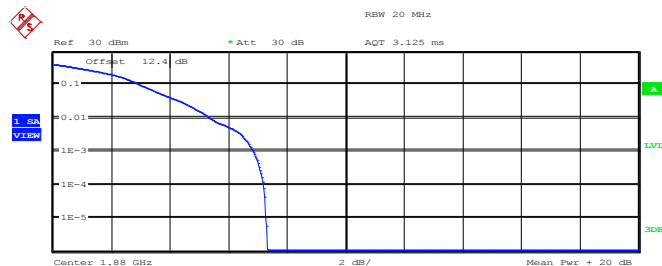

Complementary Cumulative Distribution Function  
NOF samples: 100000, Usable BW: 23.7MHz

Trace 1	
Mean	19.94 dBm
Peak	27.28 dBm
Crest	7.33 dB
10 %	2.98 dB
1 %	5.35 dB
.1 %	6.83 dB
.01 %	7.18 dB

Date: 9.MAY.2014 16:47:00



Peak-to-Average Ratio on LTE Band 2  
20MHz / 16QAM in Ch. 19100 (1RB Size)

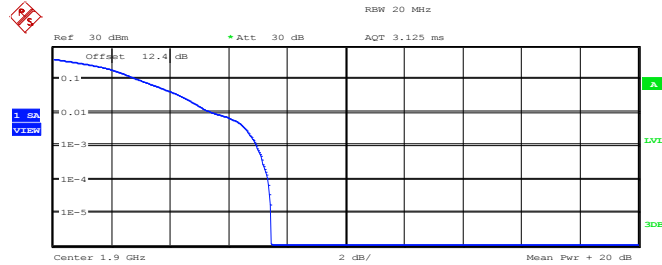

Complementary Cumulative Distribution Function  
NOF samples: 100000, Usable BW: 23.7MHz

Trace 1	
Mean	20.02 dBm
Peak	27.47 dBm
Crest	7.45 dB
10 %	2.92 dB
1 %	5.48 dB
.1 %	6.96 dB
.01 %	7.34 dB

Date: 9.MAY.2014 16:50:26

Peak-to-Average Ratio on LTE Band 2  
20MHz / 16QAM in Ch. 18700 (100RB Size)

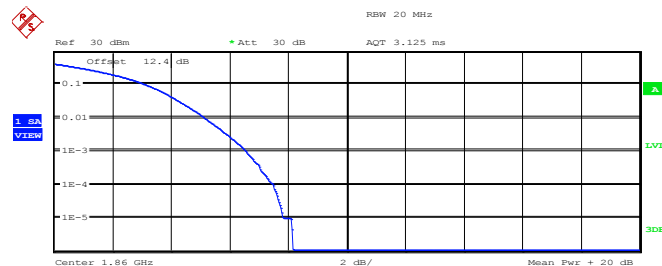

Complementary Cumulative Distribution Function  
NOF samples: 100000, Usable BW: 23.7MHz

Trace 1	
Mean	19.52 dBm
Peak	27.68 dBm
Crest	8.16 dB
10 %	3.14 dB
1 %	5.13 dB
.1 %	6.54 dB
.01 %	7.47 dB

Date: 9.MAY.2014 16:46:35



Peak-to-Average Ratio on LTE Band 2  
20MHz / 16QAM in Ch. 18900 (100RB Size)

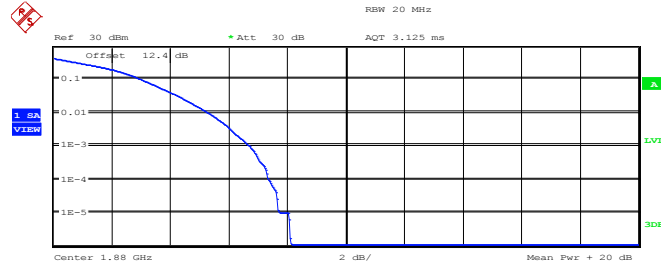

Complementary Cumulative Distribution Function  
NOF samples: 100000, Usable BW: 23.7MHz

Trace 1	
Mean	19.31 dBm
Peak	27.42 dBm
Crest	8.11 dB
10 %	2.98 dB
1 %	5.29 dB
.1 %	6.70 dB
.01 %	7.34 dB

Date: 9.MAY.2014 16:49:22

Peak-to-Average Ratio on LTE Band 2  
20MHz / 16QAM in Ch. 19100 (100RB Size)

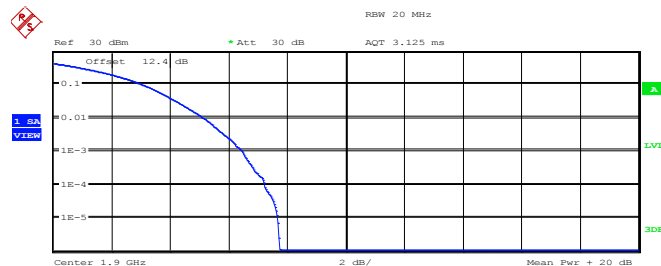

Complementary Cumulative Distribution Function  
NOF samples: 100000, Usable BW: 23.7MHz

Trace 1	
Mean	19.18 dBm
Peak	26.91 dBm
Crest	7.73 dB
10 %	3.04 dB
1 %	5.10 dB
.1 %	6.44 dB
.01 %	7.21 dB

Date: 9.MAY.2014 16:50:49



Peak-to-Average Ratio on LTE Band 4  
20MHz / 16QAM in Ch. 20050 (1RB Size)

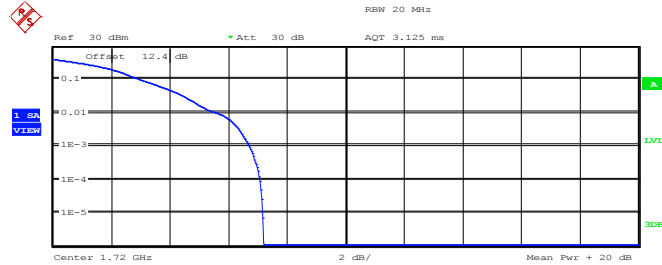

Complementary Cumulative Distribution Function  
NOF samples: 100000, Usable BW: 23.7MHz

Trace 1	
Mean	22.51 dBm
Peak	29.69 dBm
Crest	7.18 dB
10 %	2.98 dB
1 %	5.58 dB
.1 %	6.70 dB
.01 %	7.08 dB

Date: 10.MAY.2014 09:58:15

Peak-to-Average Ratio on LTE Band 4  
20MHz / 16QAM in Ch. 20175 (1RB Size)

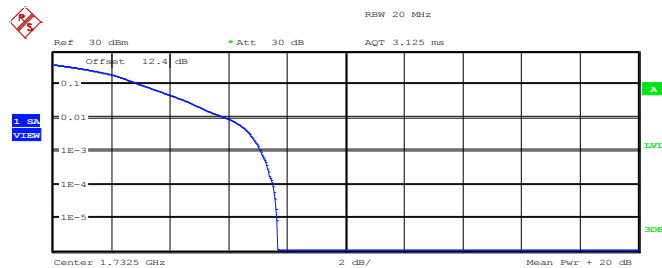

Complementary Cumulative Distribution Function  
NOF samples: 100000, Usable BW: 23.7MHz

Trace 1	
Mean	22.45 dBm
Peak	30.13 dBm
Crest	7.68 dB
10 %	3.01 dB
1 %	5.93 dB
.1 %	7.08 dB
.01 %	7.50 dB

Date: 10.MAY.2014 09:59:33



Peak-to-Average Ratio on LTE Band 4  
20MHz / 16QAM in Ch. 20300 (1RB Size)

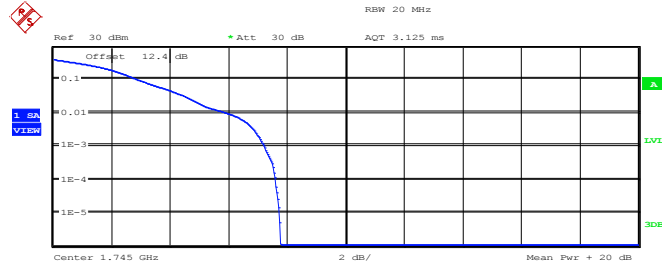

Complementary Cumulative Distribution Function  
NOF samples: 100000, Usable BW: 23.7MHz

Trace 1	
Mean	22.49 dBm
Peak	30.25 dBm
Crest	7.76 dB
10 %	2.88 dB
1 %	5.90 dB
.1 %	7.21 dB
.01 %	7.60 dB

Date: 10.MAY.2014 10:00:34

Peak-to-Average Ratio on LTE Band 4  
20MHz / 16QAM in Ch. 20500 (100RB Size)

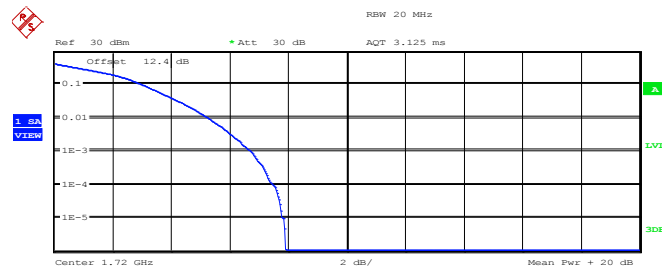

Complementary Cumulative Distribution Function  
NOF samples: 100000, Usable BW: 23.7MHz

Trace 1	
Mean	21.71 dBm
Peak	29.62 dBm
Crest	7.90 dB
10 %	3.01 dB
1 %	5.22 dB
.1 %	6.70 dB
.01 %	7.47 dB

Date: 10.MAY.2014 09:59:10



Peak-to-Average Ratio on LTE Band 4  
20MHz / 16QAM in Ch. 201750 (100RB Size)

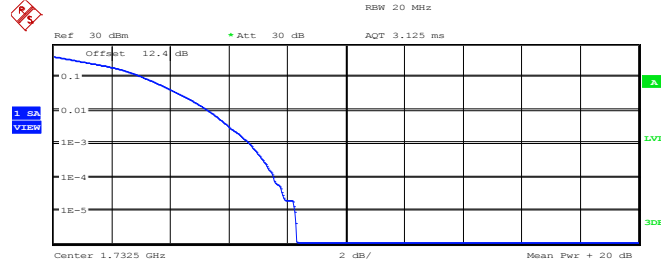

Complementary Cumulative Distribution Function  
NOF samples: 100000, Usable BW: 23.7MHz

Trace 1	
Mean	21.74 dBm
Peak	30.06 dBm
Crest	8.32 dB
10 %	3.08 dB
1 %	5.29 dB
.1 %	6.70 dB
.01 %	7.53 dB

Date: 10.MAY.2014 09:59:55

Peak-to-Average Ratio on LTE Band 4  
20MHz / 16QAM in Ch. 20300 (100RB Size)

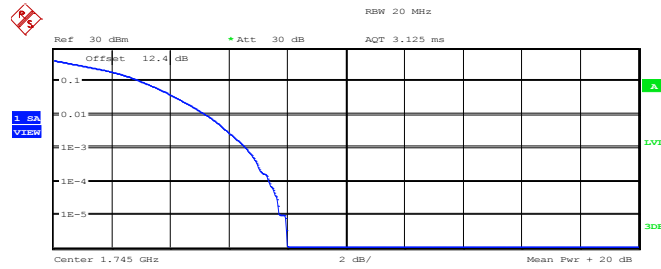

Complementary Cumulative Distribution Function  
NOF samples: 100000, Usable BW: 23.7MHz

Trace 1	
Mean	21.56 dBm
Peak	29.55 dBm
Crest	7.99 dB
10 %	3.01 dB
1 %	5.22 dB
.1 %	6.57 dB
.01 %	7.37 dB

Date: 10.MAY.2014 10:00:56



Peak-to-Average Ratio on LTE Band 17  
10MHz / 16QAM in Ch. 23780 (1RB Size)

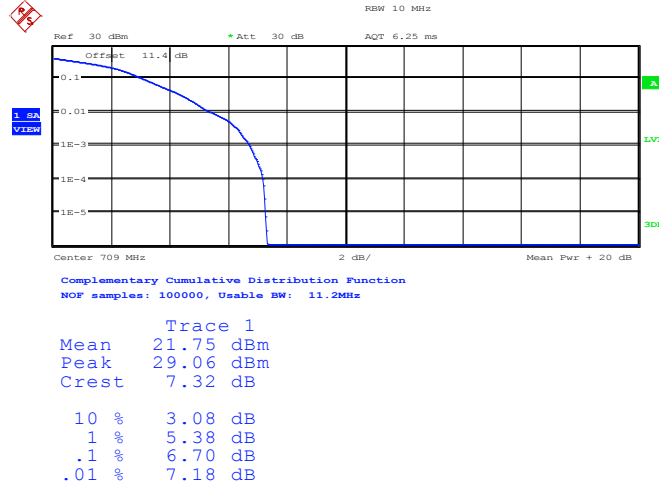

Date: 9.MAY.2014 11:53:41

Peak-to-Average Ratio on LTE Band 17  
10MHz / 16QAM in Ch. 23790 (1RB Size)

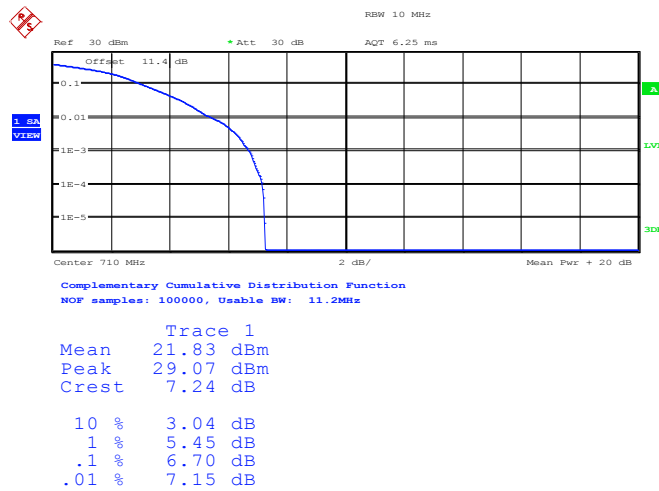

Date: 9.MAY.2014 11:54:30



Peak-to-Average Ratio on LTE Band 17  
10MHz / 16QAM in Ch. 23800 (1RB Size)

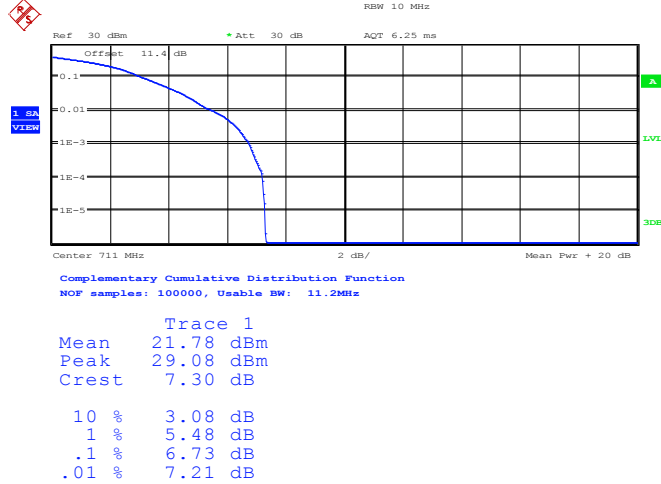

Date: 9.MAY.2014 11:55:19

Peak-to-Average Ratio on LTE Band 17  
10MHz / 16QAM in Ch. 23780 (50RB Size)

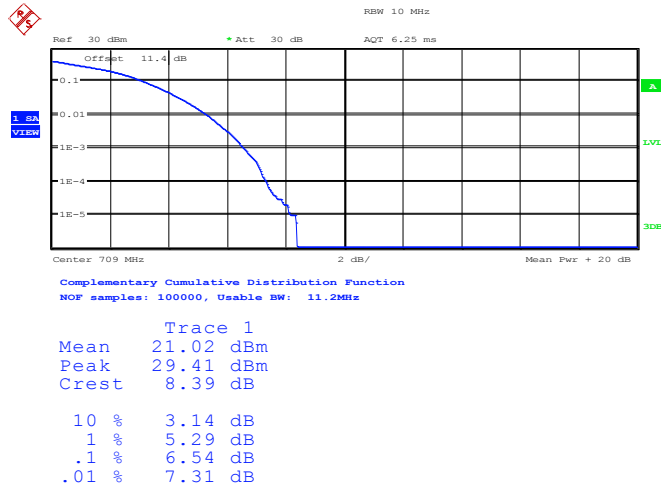

Date: 9.MAY.2014 11:54:07





Peak-to-Average Ratio on LTE Band 17  
10MHz / 16QAM in Ch. 23790 (50RB Size)

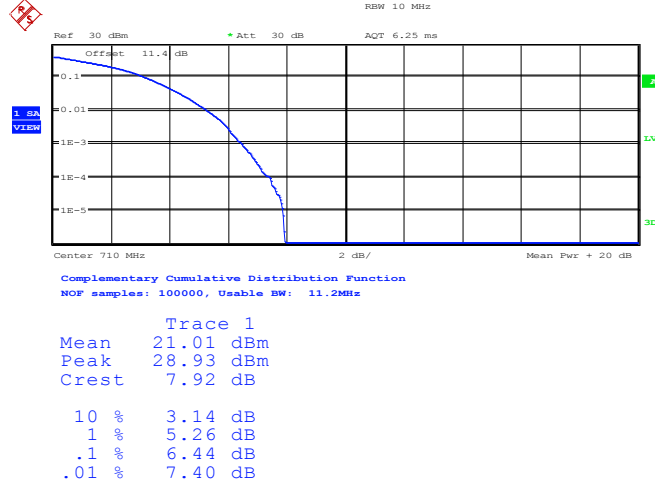

Date: 9.MAY.2014 11:54:56

Peak-to-Average Ratio on LTE Band 17  
10MHz / 16QAM in Ch. 23800 (50RB Size)

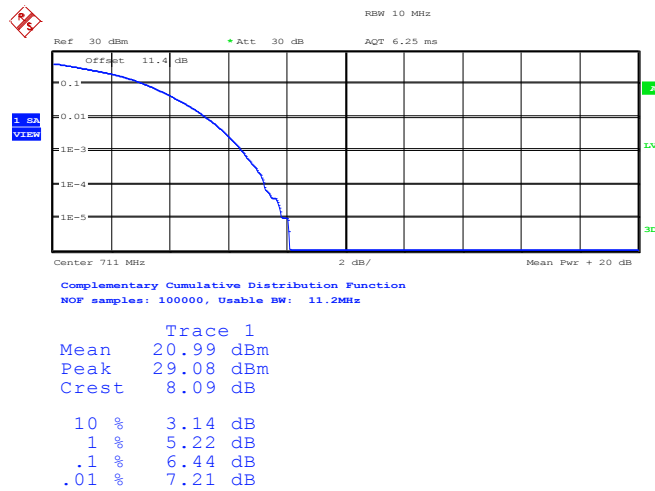

Date: 9.MAY.2014 11:55:48



Peak-to-Average Ratio on LTE Band 7  
20MHz / 16QAM in Ch. 20850 (1RB Size)

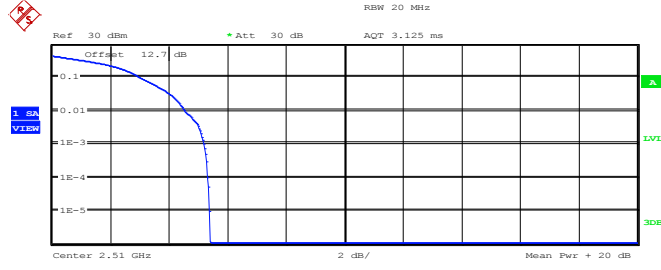

Complementary Cumulative Distribution Function  
NOF samples: 100000, Usable BW: 23.7MHz

Trace 1	
Mean	21.32 dBm
Peak	26.70 dBm
Crest	5.38 dB
10 %	3.01 dB
1 %	4.52 dB
.1 %	5.19 dB
.01 %	5.32 dB

Date: 9.MAY.2014 17:59:52

Peak-to-Average Ratio on LTE Band 7  
20MHz / 16QAM in Ch. 21100 (1RB Size)

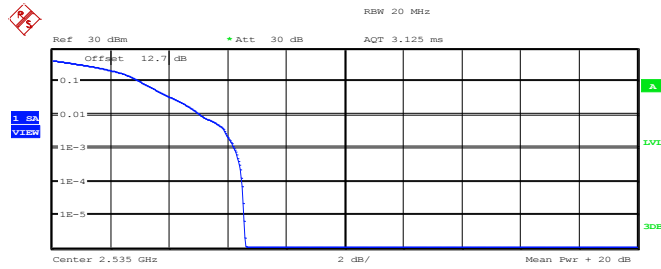

Complementary Cumulative Distribution Function  
NOF samples: 100000, Usable BW: 23.7MHz

Trace 1	
Mean	21.35 dBm
Peak	27.96 dBm
Crest	6.61 dB
10 %	3.01 dB
1 %	5.06 dB
.1 %	6.22 dB
.01 %	6.47 dB

Date: 9.MAY.2014 18:00:45



Peak-to-Average Ratio on LTE Band 7  
20MHz / 16QAM in Ch. 21350 (1RB Size)

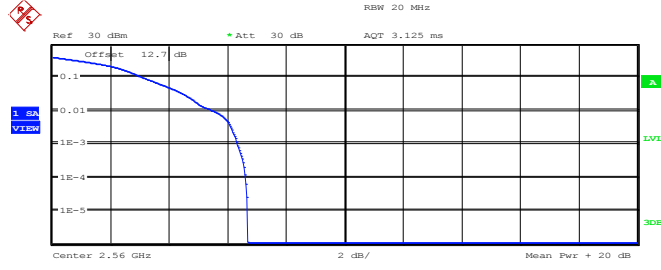

Complementary Cumulative Distribution Function  
NOF samples: 100000, Usable BW: 23.7MHz

Trace 1	
Mean	21.54 dBm
Peak	28.22 dBm
Crest	6.68 dB
10 %	3.11 dB
1 %	5.48 dB
.1 %	6.35 dB
.01 %	6.60 dB

Date: 9.MAY.2014 18:01:35

Peak-to-Average Ratio on LTE Band 7  
20MHz / 16QAM in Ch. 20850 (100RB Size)

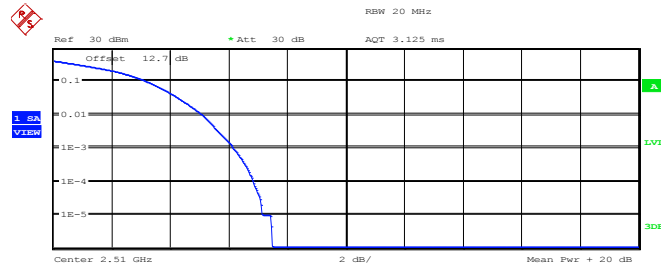

Complementary Cumulative Distribution Function  
NOF samples: 100000, Usable BW: 23.7MHz

Trace 1	
Mean	20.56 dBm
Peak	28.04 dBm
Crest	7.49 dB
10 %	3.21 dB
1 %	5.06 dB
.1 %	6.15 dB
.01 %	6.83 dB

Date: 9.MAY.2014 18:00:24



Peak-to-Average Ratio on LTE Band 7  
20MHz / 16QAM in Ch. 21100 (100RB Size)

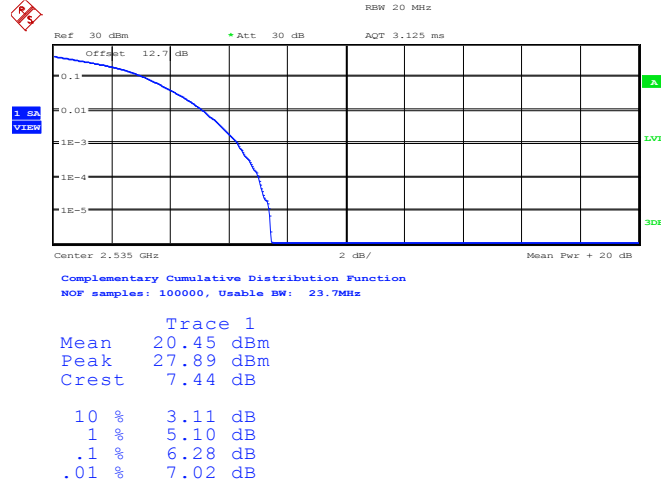

Date: 9.MAY.2014 18:01:09

Peak-to-Average Ratio on LTE Band 7  
20MHz / 16QAM in Ch. 21350 (100RB Size)

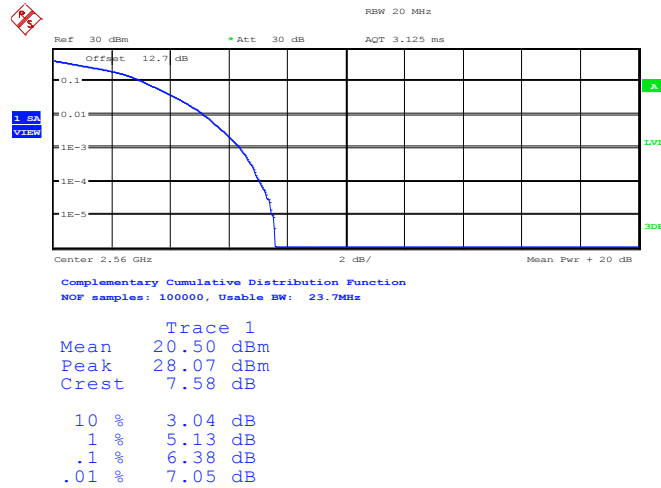

Date: 9.MAY.2014 18:01:59



### 3.3 Effective Radiated Power and Equivalent Isotropic Radiated Power Measurement

#### 3.3.1 Description of the ERP/EIRP Measurement

Effective radiated power output measurements by substitution method according to ANSI / TIA / EIA-603-C-2004, and the spectrum analyzer configuration follows KDB 971168 D01 Power Meas. License Digital Systems v02r01. Mobile and portable (hand-held) stations operating are limited to average ERP of 7 watts with LTE band 5 and 3 watts with LTE band 17.

Equivalent isotropic radiated power output measurements by substitution method according to ANSI / TIA / EIA-603-C-2004, and the spectrum analyzer configuration follows KDB 971168 D01 Power Meas. License Digital Systems v02r01. Mobile and portable (hand-held) stations operating are limited to average EIRP of 2 watts with LTE band 2 / 7 and 1 watt with LTE band 4.

#### 3.3.2 Measuring Instruments

The measuring equipment is listed in the section 4 of this test report.

#### 3.3.3 Test Procedures

1. The EUT was placed on a non-conductive rotating platform 0.8 meters high in a semi-anechoic chamber. The radiated emission at the fundamental frequency was measured at 3 m with a test antenna and a spectrum analyzer with RMS detector per section 5. of KDB 971168 D01.
2. During the measurement, the system simulator parameters were set to force the EUT transmitting at maximum output power. The maximum emission was recorded from analyzer power level (LVL) from the 360 degrees rotation of the turntable and the test antenna raised and lowered over a range from 1 to 4 meters in both horizontally and vertically polarized orientations.
3. Effective Isotropic Radiated Power (EIRP) was measured by substitution method according to TIA/EIA-603-C. The EUT was replaced by dipole antenna (substitution antenna) at same location, and then a known power from S.G. was applied into the dipole antenna through a Tx cable, and then recorded the maximum Analyzer reading through raised and lowered the test antenna. The correction factor (in dB) = S.G. - Tx Cable loss + Substitution antenna gain - Analyzer reading. Then the EUT's EIRP was calculated with the correction factor,  $EIRP = LVL + \text{Correction factor}$  and  $ERP = EIRP - 2.15$ .

### 3.3.4 Test Setup

For Effective Radiated Power

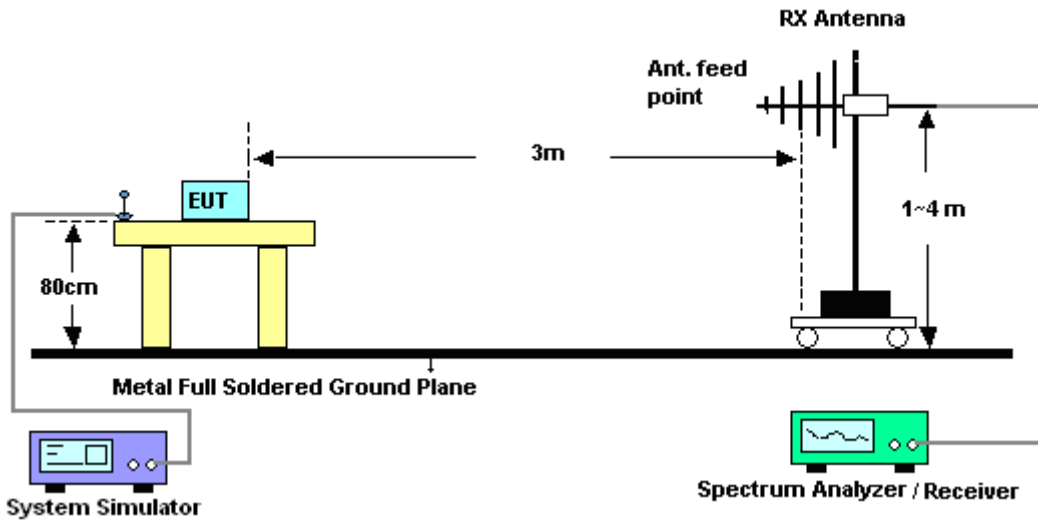

For Equivalent Isotropic Radiated Power

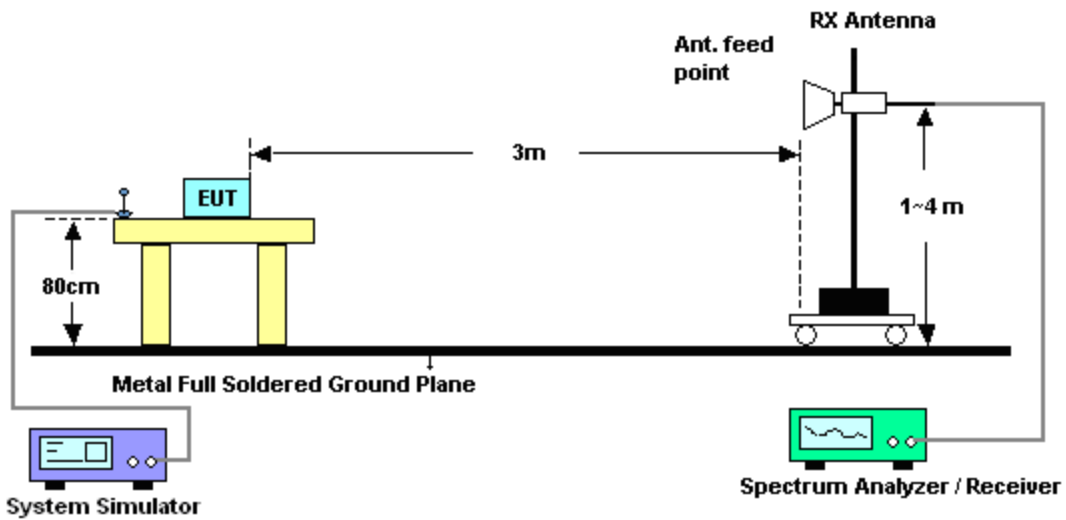

3.3.5 Test Result of ERP/EIRP

LTE Band 5 Radiated Power ERP for BW 1.4MHz / QPSK				
Horizontal Polarization				
Frequency (MHz)	LVL (dBm)	Correction Factor (dB)	ERP (dBm)	ERP (W)
824.7	-8.56	31.54	20.83	0.12
836.5	-9.29	32.04	20.60	0.11
848.3	-9.13	32.59	21.31	0.14
Vertical Polarization				
Frequency (MHz)	LVL (dBm)	Correction Factor (dB)	ERP (dBm)	ERP (W)
824.7	-17.62	32.93	13.16	0.02
836.5	-17.74	32.82	12.93	0.02
848.3	-18.07	33.62	13.40	0.02

\* ERP = LVL (dBm) + Correction Factor (dB) - 2.15

LTE Band 5 Radiated Power ERP for BW 1.4MHz / 16QAM				
Horizontal Polarization				
Frequency (MHz)	LVL (dBm)	Correction Factor (dB)	ERP (dBm)	ERP (W)
824.7	-11.28	31.54	18.11	0.06
836.5	-11.88	32.04	18.01	0.06
848.3	-11.74	32.59	18.70	0.07
Vertical Polarization				
Frequency (MHz)	LVL (dBm)	Correction Factor (dB)	ERP (dBm)	ERP (W)
824.7	-20.45	32.93	10.33	0.01
836.5	-20.32	32.82	10.35	0.01
848.3	-20.92	33.62	10.55	0.01

\* ERP = LVL (dBm) + Correction Factor (dB) - 2.15



LTE Band 5 Radiated Power ERP for BW 3MHz / QPSK				
Horizontal Polarization				
Frequency (MHz)	LVL (dBm)	Correction Factor (dB)	ERP (dBm)	ERP (W)
825.5	-8.65	31.54	20.74	0.12
836.5	-9.20	32.04	20.69	0.12
847.5	-9.17	32.59	21.27	0.13
Vertical Polarization				
Frequency (MHz)	LVL (dBm)	Correction Factor (dB)	ERP (dBm)	ERP (W)
825.5	-17.65	32.93	13.13	0.02
836.5	-17.88	32.82	12.79	0.02
847.5	-17.91	33.62	13.56	0.02

\* ERP = LVL (dBm) + Correction Factor (dB) - 2.15

LTE Band 5 Radiated Power ERP for BW 3MHz / 16QAM				
Horizontal Polarization				
Frequency (MHz)	LVL (dBm)	Correction Factor (dB)	ERP (dBm)	ERP (W)
825.5	-11.35	31.44	17.94	0.06
836.5	-11.81	32.04	18.08	0.06
847.5	-11.98	32.63	18.50	0.07
Vertical Polarization				
Frequency (MHz)	LVL (dBm)	Correction Factor (dB)	ERP (dBm)	ERP (W)
825.5	-20.39	32.78	10.24	0.01
836.5	-20.65	32.82	10.02	0.01
847.5	-20.79	33.4	10.46	0.01

\* ERP = LVL (dBm) + Correction Factor (dB) - 2.15





LTE Band 5 Radiated Power ERP for BW 5MHz / QPSK				
Horizontal Polarization				
Frequency (MHz)	LVL (dBm)	Correction Factor (dB)	ERP (dBm)	ERP (W)
826.5	-8.83	31.44	20.46	0.11
836.5	-9.26	32.04	20.63	0.12
846.5	-9.57	32.63	20.91	0.12
Vertical Polarization				
Frequency (MHz)	LVL (dBm)	Correction Factor (dB)	ERP (dBm)	ERP (W)
826.5	-17.92	32.78	12.71	0.02
836.5	-17.81	32.82	12.86	0.02
846.5	-17.65	33.4	13.60	0.02

\* ERP = LVL (dBm) + Correction Factor (dB) - 2.15

LTE Band 5 Radiated Power ERP for BW 5MHz / 16QAM				
Horizontal Polarization				
Frequency (MHz)	LVL (dBm)	Correction Factor (dB)	ERP (dBm)	ERP (W)
826.5	-11.30	31.44	17.99	0.06
836.5	-11.62	32.04	18.27	0.07
846.5	-11.65	32.63	18.83	0.08
Vertical Polarization				
Frequency (MHz)	LVL (dBm)	Correction Factor (dB)	ERP (dBm)	ERP (W)
826.5	-20.38	32.78	10.25	0.01
836.5	-20.15	32.82	10.52	0.01
846.5	-20.49	33.4	10.76	0.01

\* ERP = LVL (dBm) + Correction Factor (dB) - 2.15



LTE Band 5 Radiated Power ERP for BW 10MHz / QPSK				
Horizontal Polarization				
Frequency (MHz)	LVL (dBm)	Correction Factor (dB)	ERP (dBm)	ERP (W)
829.0	-8.72	31.44	20.57	0.11
836.5	-9.38	32.04	20.51	0.11
844.0	-9.41	32.63	21.07	0.13
Vertical Polarization				
Frequency (MHz)	LVL (dBm)	Correction Factor (dB)	ERP (dBm)	ERP (W)
829.0	-17.82	32.78	12.81	0.02
836.5	-17.88	32.82	12.79	0.02
844.0	-17.92	33.4	13.33	0.02

\* ERP = LVL (dBm) + Correction Factor (dB) - 2.15

LTE Band 5 Radiated Power ERP for BW 10MHz / 16QAM				
Horizontal Polarization				
Frequency (MHz)	LVL (dBm)	Correction Factor (dB)	ERP (dBm)	ERP (W)
829.0	-11.11	31.44	18.18	0.07
836.5	-11.63	32.04	18.26	0.07
844.0	-11.83	32.63	18.65	0.07
Vertical Polarization				
Frequency (MHz)	LVL (dBm)	Correction Factor (dB)	ERP (dBm)	ERP (W)
829.0	-20.46	32.78	10.17	0.01
836.5	-20.29	32.82	10.38	0.01
844.0	-20.37	33.4	10.88	0.01

\* ERP = LVL (dBm) + Correction Factor (dB) - 2.15



LTE Band 2 Radiated Power EIRP for BW 1.4MHz / QPSK				
Horizontal Polarization				
Frequency (MHz)	LVL (dBm)	Correction Factor (dB)	EIRP (dBm)	EIRP (W)
1850.7	-19.76	45.68	25.92	0.39
1880.0	-19.16	46.01	26.85	0.48
1909.3	-19.94	45.76	25.82	0.38
Vertical Polarization				
Frequency (MHz)	LVL (dBm)	Correction Factor (dB)	EIRP (dBm)	EIRP (W)
1850.7	-29.60	49.18	19.58	0.09
1880.0	-30.15	50.42	20.27	0.11
1909.3	-29.79	48.94	19.15	0.08

LTE Band 2 Radiated Power EIRP for BW 1.4MHz / 16QAM				
Horizontal Polarization				
Frequency (MHz)	LVL (dBm)	Correction Factor (dB)	EIRP (dBm)	EIRP (W)
1850.7	-20.82	45.68	24.86	0.31
1880.0	-20.59	46.01	25.42	0.35
1909.3	-21.09	45.76	24.67	0.29
Vertical Polarization				
Frequency (MHz)	LVL (dBm)	Correction Factor (dB)	EIRP (dBm)	EIRP (W)
1850.7	-31.44	49.18	17.74	0.06
1880.0	-31.70	50.42	18.72	0.07
1909.3	-31.18	48.94	17.76	0.06



LTE Band 2 Radiated Power EIRP for BW 3MHz / QPSK				
Horizontal Polarization				
Frequency (MHz)	LVL (dBm)	Correction Factor (dB)	EIRP (dBm)	EIRP (W)
1851.5	-19.79	45.76	25.97	0.40
1880.0	-19.65	46.01	26.36	0.43
1908.5	-19.23	45.95	26.72	0.47
Vertical Polarization				
Frequency (MHz)	LVL (dBm)	Correction Factor (dB)	EIRP (dBm)	EIRP (W)
1851.5	-29.62	49.03	19.41	0.09
1880.0	-29.55	50.42	20.87	0.12
1908.5	-29.82	48.86	19.04	0.08

LTE Band 2 Radiated Power EIRP for BW 3MHz / 16QAM				
Horizontal Polarization				
Frequency (MHz)	LVL (dBm)	Correction Factor (dB)	EIRP (dBm)	EIRP (W)
1851.5	-20.81	45.76	24.95	0.31
1880.0	-20.99	46.01	25.02	0.32
1908.5	-20.26	45.95	25.69	0.37
Vertical Polarization				
Frequency (MHz)	LVL (dBm)	Correction Factor (dB)	EIRP (dBm)	EIRP (W)
1851.5	-30.77	49.03	18.26	0.07
1880.0	-30.89	50.42	19.53	0.09
1908.5	-30.75	48.86	18.11	0.06



LTE Band 2 Radiated Power EIRP for BW 5MHz / QPSK				
Horizontal Polarization				
Frequency (MHz)	LVL (dBm)	Correction Factor (dB)	EIRP (dBm)	EIRP (W)
1852.5	-19.80	46.11	26.31	0.43
1880.0	-19.20	46.04	26.84	0.48
1907.5	-19.16	46.14	26.98	0.50
Vertical Polarization				
Frequency (MHz)	LVL (dBm)	Correction Factor (dB)	ERP (dBm)	ERP (W)
1852.5	-29.69	49.17	19.48	0.09
1880.0	-29.81	50.42	20.61	0.12
1907.5	-29.72	48.78	19.06	0.08

LTE Band 2 Radiated Power EIRP for BW 5MHz / 16QAM				
Horizontal Polarization				
Frequency (MHz)	LVL (dBm)	Correction Factor (dB)	EIRP (dBm)	EIRP (W)
1852.5	-20.49	46.11	25.62	0.36
1880.0	-20.11	46.04	25.93	0.39
1907.5	-20.42	46.14	25.72	0.37
Vertical Polarization				
Frequency (MHz)	LVL (dBm)	Correction Factor (dB)	ERP (dBm)	ERP (W)
1852.5	-30.81	49.17	18.36	0.07
1880.0	-30.92	50.42	19.50	0.09
1907.5	-30.71	48.78	18.07	0.06



LTE Band 2 Radiated Power EIRP for BW 10MHz / QPSK				
Horizontal Polarization				
Frequency (MHz)	LVL (dBm)	Correction Factor (dB)	EIRP (dBm)	EIRP (W)
1855.0	-19.34	46.10	26.76	0.47
1880.0	-19.05	46.01	26.96	0.50
1905.0	-19.24	46.39	27.15	0.52
Vertical Polarization				
Frequency (MHz)	LVL (dBm)	Correction Factor (dB)	EIRP (dBm)	EIRP (W)
1855.0	-29.46	49.73	20.27	0.11
1880.0	-29.51	50.42	20.91	0.12
1905.0	-29.26	48.30	19.04	0.08

LTE Band 2 Radiated Power EIRP for BW 10MHz / 16QAM				
Horizontal Polarization				
Frequency (MHz)	LVL (dBm)	Correction Factor (dB)	EIRP (dBm)	EIRP (W)
1855.0	-20.58	46.10	25.52	0.36
1880.0	-20.32	46.01	25.69	0.37
1905.0	-20.38	46.39	26.01	0.40
Vertical Polarization				
Frequency (MHz)	LVL (dBm)	Correction Factor (dB)	EIRP (dBm)	EIRP (W)
1855.0	-30.62	49.73	19.11	0.08
1880.0	-30.66	50.42	19.76	0.09
1905.0	-30.07	48.30	18.23	0.07



LTE Band 2 Radiated Power EIRP for BW 15MHz / QPSK				
Horizontal Polarization				
Frequency (MHz)	LVL (dBm)	Correction Factor (dB)	EIRP (dBm)	EIRP (W)
1857.5	-19.43	46.24	26.81	0.48
1880.0	-19.06	46.01	26.95	0.50
1902.5	-19.32	46.18	26.86	0.49
Vertical Polarization				
Frequency (MHz)	LVL (dBm)	Correction Factor (dB)	EIRP (dBm)	EIRP (W)
1857.5	-29.13	49.68	20.55	0.11
1880.0	-29.10	50.42	21.32	0.14
1902.5	-28.74	48.20	19.46	0.09

LTE Band 2 Radiated Power EIRP for BW 15MHz / 16QAM				
Horizontal Polarization				
Frequency (MHz)	LVL (dBm)	Correction Factor (dB)	EIRP (dBm)	EIRP (W)
1857.5	-20.49	46.24	25.75	0.38
1880.0	-20.01	46.01	26.00	0.40
1902.5	-20.30	46.18	25.88	0.39
Vertical Polarization				
Frequency (MHz)	LVL (dBm)	Correction Factor (dB)	EIRP (dBm)	EIRP (W)
1857.5	-30.13	49.68	19.55	0.09
1880.0	-30.44	50.42	19.98	0.10
1902.5	-29.86	48.20	18.34	0.07



LTE Band 2 Radiated Power EIRP for BW 20MHz / QPSK				
Horizontal Polarization				
Frequency (MHz)	LVL (dBm)	Correction Factor (dB)	EIRP (dBm)	EIRP (W)
1860.0	-20.32	46.88	26.56	0.45
1880.0	-19.50	46.01	26.51	0.45
1900.0	-20.01	46.57	26.56	0.45
Vertical Polarization				
Frequency (MHz)	LVL (dBm)	Correction Factor (dB)	EIRP (dBm)	EIRP (W)
1860.0	-29.41	49.69	20.28	0.11
1880.0	-29.84	50.42	20.58	0.11
1900.0	-28.90	48.87	19.97	0.10

LTE Band 2 Radiated Power EIRP for BW 20MHz / 16QAM				
Horizontal Polarization				
Frequency (MHz)	LVL (dBm)	Correction Factor (dB)	EIRP (dBm)	EIRP (W)
1860.0	-21.41	46.88	25.47	0.35
1880.0	-20.45	46.01	25.56	0.36
1900.0	-20.90	46.57	25.67	0.37
Vertical Polarization				
Frequency (MHz)	LVL (dBm)	Correction Factor (dB)	EIRP (dBm)	EIRP (W)
1860.0	-30.60	49.69	19.09	0.08
1880.0	-30.69	50.42	19.73	0.09
1900.0	-30.02	48.87	18.85	0.08





LTE Band 4 Radiated Power EIRP for BW 1.4MHz / QPSK				
Horizontal Polarization				
Frequency (MHz)	LVL (dBm)	Correction Factor (dB)	EIRP (dBm)	EIRP (W)
1710.7	-26.51	43.43	16.92	0.05
1732.5	-26.96	43.34	16.38	0.04
1754.3	-27.00	43.65	16.65	0.05
Vertical Polarization				
Frequency (MHz)	LVL (dBm)	Correction Factor (dB)	EIRP (dBm)	EIRP (W)
1710.7	-19.13	46.93	27.80	0.60
1732.5	-19.27	46.19	26.92	0.49
1754.3	-20.28	47.3	27.02	0.50

LTE Band 4 Radiated Power EIRP for BW 1.4MHz / 16QAM				
Horizontal Polarization				
Frequency (MHz)	LVL (dBm)	Correction Factor (dB)	EIRP (dBm)	EIRP (W)
1710.7	-27.86	43.43	15.57	0.04
1732.5	-28.16	43.34	15.18	0.03
1754.3	-28.31	43.65	15.34	0.03
Vertical Polarization				
Frequency (MHz)	LVL (dBm)	Correction Factor (dB)	EIRP (dBm)	EIRP (W)
1710.7	-20.20	46.93	26.73	0.47
1732.5	-20.41	46.19	25.78	0.38
1754.3	-21.35	47.3	25.95	0.39



LTE Band 4 Radiated Power EIRP for BW 3MHz / QPSK				
Horizontal Polarization				
Frequency (MHz)	LVL (dBm)	Correction Factor (dB)	EIRP (dBm)	EIRP (W)
1711.5	-26.53	43.38	16.85	0.05
1732.5	-27.03	43.34	16.31	0.04
1753.5	-26.69	43.51	16.82	0.05
Vertical Polarization				
Frequency (MHz)	LVL (dBm)	Correction Factor (dB)	EIRP (dBm)	EIRP (W)
1711.5	-20.13	46.65	26.52	0.45
1732.5	-20.57	46.19	25.62	0.36
1753.5	-21.31	47.65	26.34	0.43

LTE Band 4 Radiated Power EIRP for BW 3MHz / 16QAM				
Horizontal Polarization				
Frequency (MHz)	LVL (dBm)	Correction Factor (dB)	EIRP (dBm)	EIRP (W)
1711.5	-27.88	43.38	15.50	0.04
1732.5	-28.32	43.34	15.02	0.03
1753.5	-27.89	43.51	15.62	0.04
Vertical Polarization				
Frequency (MHz)	LVL (dBm)	Correction Factor (dB)	EIRP (dBm)	EIRP (W)
1711.5	-21.47	46.65	25.18	0.33
1732.5	-21.86	46.19	24.33	0.27
1753.5	-22.33	47.65	25.32	0.34



LTE Band 4 Radiated Power EIRP for BW 5MHz / QPSK				
Horizontal Polarization				
Frequency (MHz)	LVL (dBm)	Correction Factor (dB)	EIRP (dBm)	EIRP (W)
1712.5	-26.86	42.75	15.89	0.03
1732.5	-26.79	43.34	16.55	0.04
1752.5	-27.03	43.28	16.25	0.04
Vertical Polarization				
Frequency (MHz)	LVL (dBm)	Correction Factor (dB)	EIRP (dBm)	EIRP (W)
1712.5	-20.21	46.26	26.05	0.29
1732.5	-20.58	46.19	25.61	0.26
1752.5	-21.60	47.72	26.12	0.36

LTE Band 4 Radiated Power EIRP for BW 5MHz / 16QAM				
Horizontal Polarization				
Frequency (MHz)	LVL (dBm)	Correction Factor (dB)	EIRP (dBm)	EIRP (W)
1712.5	-28.07	42.75	14.68	0.03
1732.5	-27.82	43.34	15.52	0.04
1752.5	-27.75	43.28	15.53	0.04
Vertical Polarization				
Frequency (MHz)	LVL (dBm)	Correction Factor (dB)	EIRP (dBm)	EIRP (W)
1712.5	-21.59	46.26	24.67	0.29
1732.5	-22.07	46.19	24.12	0.26
1752.5	-22.17	47.72	25.55	0.36



LTE Band 4 Radiated Power EIRP for BW 10MHz / QPSK				
Horizontal Polarization				
Frequency (MHz)	LVL (dBm)	Correction Factor (dB)	EIRP (dBm)	EIRP (W)
1715.0	-26.95	42.22	15.27	0.03
1732.5	-27.22	43.34	16.12	0.04
1750.0	-27.69	44.37	16.68	0.05
Vertical Polarization				
Frequency (MHz)	LVL (dBm)	Correction Factor (dB)	EIRP (dBm)	EIRP (W)
1715.0	-20.45	45.79	25.34	0.34
1732.5	-21.12	46.19	25.07	0.32
1750.0	-20.77	47.21	26.44	0.44

LTE Band 4 Radiated Power EIRP for BW 10MHz / 16QAM				
Horizontal Polarization				
Frequency (MHz)	LVL (dBm)	Correction Factor (dB)	EIRP (dBm)	EIRP (W)
1715.0	-28.05	42.22	14.17	0.03
1732.5	-27.94	43.34	15.40	0.03
1750.0	-28.71	44.37	15.66	0.04
Vertical Polarization				
Frequency (MHz)	LVL (dBm)	Correction Factor (dB)	EIRP (dBm)	EIRP (W)
1715.0	-21.61	45.79	24.18	0.26
1732.5	-21.76	46.19	24.43	0.28
1750.0	-21.93	47.21	25.28	0.34



LTE Band 4 Radiated Power EIRP for BW 15MHz / QPSK				
Horizontal Polarization				
Frequency (MHz)	LVL (dBm)	Correction Factor (dB)	EIRP (dBm)	EIRP (W)
1717.5	-26.94	42.93	15.99	0.04
1732.5	-26.83	43.34	16.51	0.04
1747.5	-27.50	43.58	16.08	0.04
Vertical Polarization				
Frequency (MHz)	LVL (dBm)	Correction Factor (dB)	EIRP (dBm)	EIRP (W)
1717.5	-20.98	46.52	25.54	0.36
1732.5	-21.68	46.19	24.51	0.28
1747.5	-21.14	47.08	25.94	0.39

LTE Band 4 Radiated Power EIRP for BW 15MHz / 16QAM				
Horizontal Polarization				
Frequency (MHz)	LVL (dBm)	Correction Factor (dB)	EIRP (dBm)	EIRP (W)
1717.5	-27.94	42.93	14.99	0.03
1732.5	-27.51	43.34	15.83	0.04
1747.5	-28.33	43.58	15.25	0.03
Vertical Polarization				
Frequency (MHz)	LVL (dBm)	Correction Factor (dB)	EIRP (dBm)	EIRP (W)
1717.5	-21.93	46.52	24.59	0.29
1732.5	-22.22	46.19	23.97	0.25
1747.5	-22.12	47.08	24.96	0.31



LTE Band 4 Radiated Power EIRP for BW 20MHz / QPSK				
Horizontal Polarization				
Frequency (MHz)	LVL (dBm)	Correction Factor (dB)	EIRP (dBm)	EIRP (W)
1720.0	-27.19	43.42	16.23	0.04
1732.5	-26.53	43.34	16.81	0.05
1745.0	-26.62	43.62	17.00	0.05
Vertical Polarization				
Frequency (MHz)	LVL (dBm)	Correction Factor (dB)	EIRP (dBm)	EIRP (W)
1720.0	-21.52	46.18	24.66	0.29
1732.5	-22.46	46.19	23.73	0.24
1745.0	-21.36	46.54	25.18	0.33

LTE Band 4 Radiated Power EIRP for BW 20MHz / 16QAM				
Horizontal Polarization				
Frequency (MHz)	LVL (dBm)	Correction Factor (dB)	EIRP (dBm)	EIRP (W)
1720.0	-27.75	43.42	15.67	0.04
1732.5	-27.17	43.34	16.17	0.04
1745.0	-27.28	43.62	16.34	0.04
Vertical Polarization				
Frequency (MHz)	LVL (dBm)	Correction Factor (dB)	EIRP (dBm)	EIRP (W)
1720.0	-22.48	46.18	23.70	0.23
1732.5	-22.93	46.19	23.26	0.21
1745.00	-22.41	46.54	24.13	0.26



LTE Band 17 Radiated Power ERP / EIRP for BW 5MHz / QPSK						
Horizontal Polarization						
Frequency (MHz)	LVL (dBm)	Correction Factor (dB)	ERP (dBm)	EIRP (dBm)	ERP (W)	EIRP (W)
706.5	-9.34	30.84	19.35	17.20	0.09	0.05
710.0	-9.69	30.86	19.02	16.87	0.08	0.05
713.5	-9.59	30.81	19.07	16.92	0.08	0.05
Vertical Polarization						
Frequency (MHz)	LVL (dBm)	Correction Factor (dB)	ERP (dBm)	EIRP (dBm)	ERP (W)	EIRP (W)
706.5	-18.40	34.59	14.04	11.89	0.03	0.02
710.0	-18.58	34.03	13.30	11.15	0.02	0.01
713.5	-19.08	33.68	12.45	10.30	0.02	0.01

\* ERP = LVL (dBm) + Correction Factor (dB) - 2.15

LTE Band 17 Radiated Power ERP / EIRP for BW 5MHz / 16QAM						
Horizontal Polarization						
Frequency (MHz)	LVL (dBm)	Correction Factor (dB)	ERP (dBm)	EIRP (dBm)	ERP (W)	EIRP (W)
706.5	-11.60	30.84	17.09	14.94	0.05	0.03
710.0	-11.75	30.86	16.96	14.81	0.05	0.03
713.5	-12.16	30.81	16.50	14.35	0.04	0.03
Vertical Polarization						
Frequency (MHz)	LVL (dBm)	Correction Factor (dB)	ERP (dBm)	EIRP (dBm)	ERP (W)	EIRP (W)
706.5	-21.15	34.59	11.29	9.14	0.01	0.01
710.0	-21.53	34.03	10.35	8.20	0.01	0.01
713.5	-21.60	33.68	9.93	7.78	0.01	0.01

\* ERP = LVL (dBm) + Correction Factor (dB) - 2.15



LTE Band 17 Radiated Power ERP / EIRP for BW 10MHz / QPSK						
Horizontal Polarization						
Frequency (MHz)	LVL (dBm)	Correction Factor (dB)	ERP (dBm)	EIRP (dBm)	ERP (W)	EIRP (W)
709.0	-9.18	30.77	19.44	17.29	0.09	0.05
710.0	-9.67	30.86	19.04	16.89	0.08	0.05
711.0	-9.74	30.82	18.93	16.78	0.08	0.05
Vertical Polarization						
Frequency (MHz)	LVL (dBm)	Correction Factor (dB)	ERP (dBm)	EIRP (dBm)	ERP (W)	EIRP (W)
709.0	-18.48	34.16	13.53	11.38	0.02	0.01
710.0	-19.17	34.03	12.71	10.56	0.02	0.01
711.0	-19.29	33.94	12.50	10.35	0.02	0.01

\* ERP = LVL (dBm) + Correction Factor (dB) - 2.15

LTE Band 17 Radiated Power ERP / EIRP for BW 10MHz / 16QAM						
Horizontal Polarization						
Frequency (MHz)	LVL (dBm)	Correction Factor (dB)	ERP (dBm)	EIRP (dBm)	ERP (W)	EIRP (W)
709.0	-11.42	30.77	17.20	15.05	0.05	0.03
710.0	-11.55	30.86	17.16	15.01	0.05	0.03
711.0	-11.77	30.82	16.90	14.75	0.05	0.03
Vertical Polarization						
Frequency (MHz)	LVL (dBm)	Correction Factor (dB)	ERP (dBm)	EIRP (dBm)	ERP (W)	EIRP (W)
709.0	-20.88	34.16	11.13	8.98	0.01	0.01
710.0	-21.06	34.03	10.82	8.67	0.01	0.01
711.0	-21.16	33.94	10.63	8.48	0.01	0.01

\* ERP = LVL (dBm) + Correction Factor (dB) - 2.15





LTE Band 7 Radiated Power EIRP for BW 5MHz / QPSK				
Horizontal Polarization				
Frequency (MHz)	LVL (dBm)	Correction Factor (dB)	EIRP (dBm)	EIRP (W)
2502.5	-21.41	46.44	25.03	0.32
2535.0	-21.68	46.85	25.17	0.33
2567.5	-20.42	46.93	26.51	0.45
Vertical Polarization				
Frequency (MHz)	LVL (dBm)	Correction Factor (dB)	EIRP (dBm)	EIRP (W)
2502.5	-27.62	48.49	20.87	0.12
2535.0	-27.78	47.50	19.72	0.09
2567.5	-27.15	48.26	21.11	0.13

LTE Band 7 Radiated Power EIRP for BW 5MHz / 16QAM				
Horizontal Polarization				
Frequency (MHz)	LVL (dBm)	Correction Factor (dB)	EIRP (dBm)	EIRP (W)
2502.5	-23.39	46.44	23.05	0.20
2535.0	-23.66	46.85	23.19	0.21
2567.5	-23.12	46.93	23.81	0.24
Vertical Polarization				
Frequency (MHz)	LVL (dBm)	Correction Factor (dB)	EIRP (dBm)	EIRP (W)
2502.5	-29.61	48.49	18.88	0.08
2535.0	-30.47	47.50	17.03	0.05
2567.5	-29.77	48.26	18.49	0.07



LTE Band 7 Radiated Power EIRP for BW 10MHz / QPSK				
Horizontal Polarization				
Frequency (MHz)	LVL (dBm)	Correction Factor (dB)	EIRP (dBm)	EIRP (W)
2505.0	-21.83	46.38	24.55	0.29
2535.0	-21.96	46.85	24.89	0.31
2565.0	-21.28	46.89	25.61	0.36
Vertical Polarization				
Frequency (MHz)	LVL (dBm)	Correction Factor (dB)	EIRP (dBm)	EIRP (W)
2505.0	-27.83	48.26	20.43	0.11
2535.0	-27.70	47.50	19.80	0.10
2565.0	-27.44	48.10	20.66	0.12

LTE Band 7 Radiated Power EIRP for BW 10MHz / 16QAM				
Horizontal Polarization				
Frequency (MHz)	LVL (dBm)	Correction Factor (dB)	EIRP (dBm)	EIRP (W)
2505.0	-23.48	46.38	22.90	0.19
2535.0	-24.17	46.85	22.68	0.19
2565.0	-23.98	46.89	22.91	0.20
Vertical Polarization				
Frequency (MHz)	LVL (dBm)	Correction Factor (dB)	EIRP (dBm)	EIRP (W)
2505.0	-29.72	48.26	18.54	0.07
2535.0	-29.97	47.50	17.53	0.06
2565.0	-30.02	48.10	18.08	0.06



LTE Band 7 Radiated Power EIRP for BW 15MHz / QPSK				
Horizontal Polarization				
Frequency (MHz)	LVL (dBm)	Correction Factor (dB)	EIRP (dBm)	EIRP (W)
2507.5	-22.00	46.51	24.51	0.28
2535.0	-21.82	46.85	25.03	0.32
2562.5	-21.77	46.44	24.67	0.29
Vertical Polarization				
Frequency (MHz)	LVL (dBm)	Correction Factor (dB)	EIRP (dBm)	EIRP (W)
2507.5	-27.62	47.86	20.24	0.11
2535.0	-27.23	47.50	20.27	0.11
2562.5	-27.66	48.09	20.43	0.11

LTE Band 7 Radiated Power EIRP for BW 15MHz / 16QAM				
Horizontal Polarization				
Frequency (MHz)	LVL (dBm)	Correction Factor (dB)	EIRP (dBm)	EIRP (W)
2507.5	-23.39	46.51	23.12	0.21
2535.0	-24.56	46.85	22.29	0.17
2562.5	-24.23	46.44	22.21	0.17
Vertical Polarization				
Frequency (MHz)	LVL (dBm)	Correction Factor (dB)	EIRP (dBm)	EIRP (W)
2507.5	-29.26	47.86	18.60	0.07
2535.0	-29.63	47.50	17.87	0.06
2562.5	-30.42	48.09	17.67	0.06



LTE Band 7 Radiated Power EIRP for BW 20MHz / QPSK				
Horizontal Polarization				
Frequency (MHz)	LVL (dBm)	Correction Factor (dB)	EIRP (dBm)	EIRP (W)
2510.0	-21.95	46.54	24.59	0.29
2535.0	-22.19	46.85	24.66	0.29
2560.0	-22.30	46.49	24.19	0.26
Vertical Polarization				
Frequency (MHz)	LVL (dBm)	Correction Factor (dB)	EIRP (dBm)	EIRP (W)
2510.0	-28.23	47.75	19.52	0.09
2535.0	-27.57	47.50	19.93	0.10
2560.0	-28.58	48.43	19.85	0.10

LTE Band 7 Radiated Power EIRP for BW 20MHz / 16QAM				
Horizontal Polarization				
Frequency (MHz)	LVL (dBm)	Correction Factor (dB)	EIRP (dBm)	EIRP (W)
2510.0	-23.47	46.54	23.07	0.20
2535.0	-24.43	46.85	22.42	0.17
2560.0	-24.64	46.49	21.85	0.15
Vertical Polarization				
Frequency (MHz)	LVL (dBm)	Correction Factor (dB)	EIRP (dBm)	EIRP (W)
2510.0	-29.70	47.75	18.05	0.06
2535.0	-29.84	47.50	17.66	0.06
2560.0	-30.91	48.43	17.52	0.06

### 3.4 Occupied Bandwidth

#### 3.4.1 Description of Occupied Bandwidth Measurement

The occupied bandwidth is the width of a frequency band such that, below the lower and above the upper frequency limits, the mean powers emitted are each equal to a specified percentage 0.5% of the total mean transmitted power.

The 26 dB emission bandwidth is defined as the frequency range between two points, one above and one below the carrier frequency, at which the spectral density of the emission is attenuated 26 dB below the maximum in-band spectral density of the modulated signal. Spectral density (power per unit bandwidth) is to be measured with a detector of resolution bandwidth equal to approximately 1.0% of the emission bandwidth.

#### 3.4.2 Measuring Instruments

The measuring equipment is listed in the section 4 of this test report.

#### 3.4.3 Test Procedures

1. The EUT was connected to spectrum analyzer and system simulator via a power divider.
2. The 26dB and 99% occupied bandwidth (BW) of the middle channel for the highest RF power with full RB sizes were measured.

#### 3.4.4 Test Setup

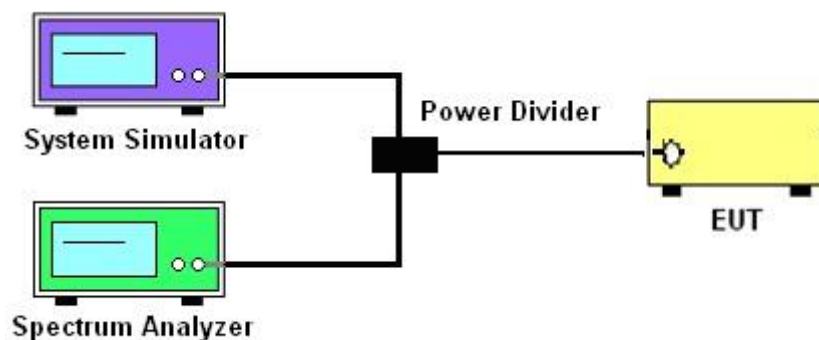



### 3.4.5 Test Result (Plots) of Occupied Bandwidth

Band :	LTE Band 5	BW / Mod. :	1.4MHz / QPSK
--------	------------	-------------	---------------

99% Occupied Bandwidth Plot on Channel 20407

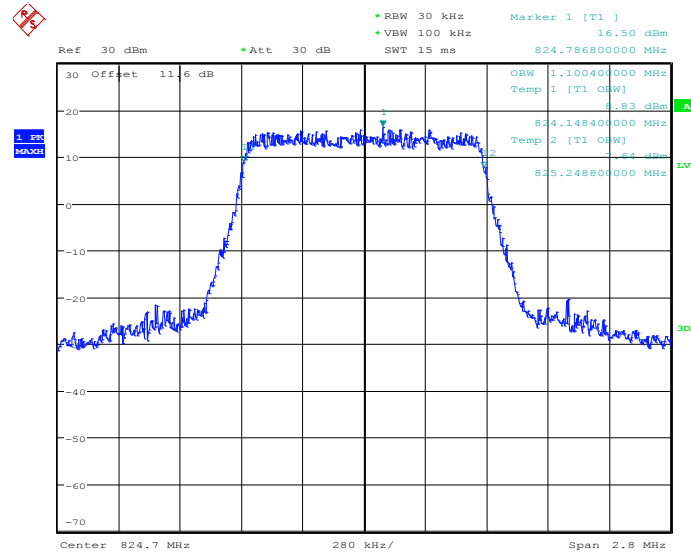

Date: 9.MAY.2014 13:42:59

26dB Bandwidth Plot on Channel 20407

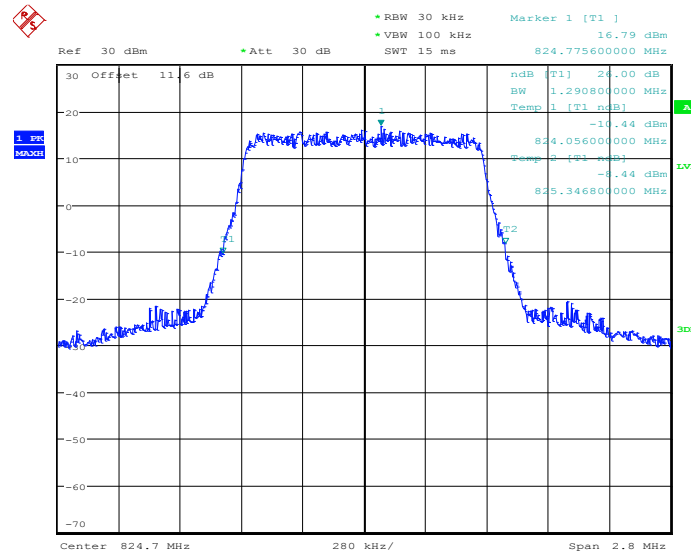

Date: 9.MAY.2014 13:43:52



99% Occupied Bandwidth Plot on Channel 20525

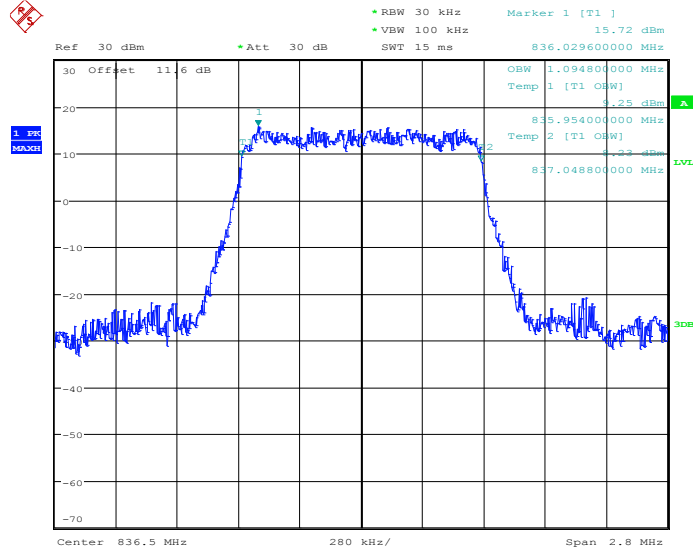

Date: 9.MAY.2014 13:49:18

26dB Bandwidth Plot on Channel 20525

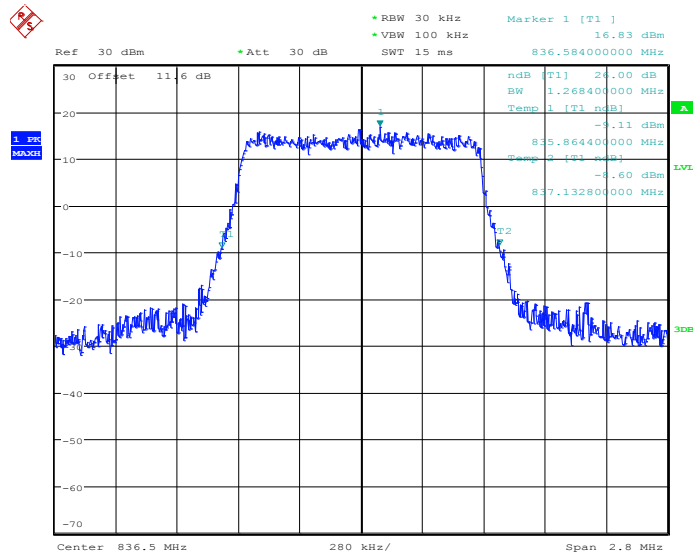

Date: 9.MAY.2014 13:49:52



### 99% Occupied Bandwidth Plot on Channel 20643

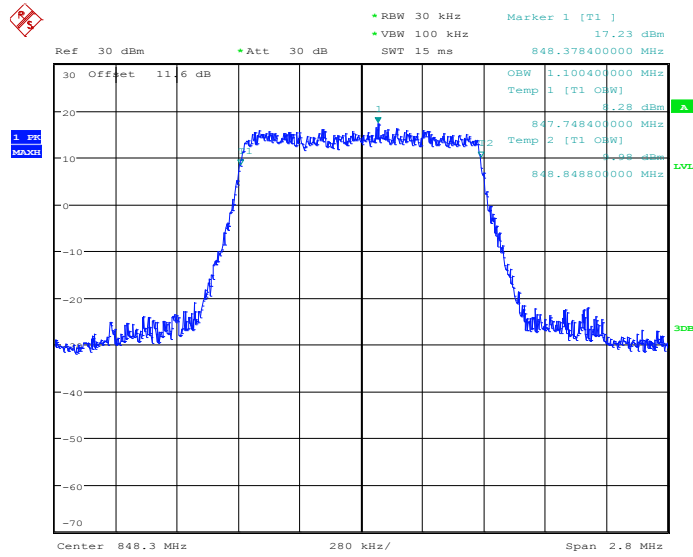

Date: 9.MAY.2014 13:52:27

### 26dB Bandwidth Plot on Channel 20643

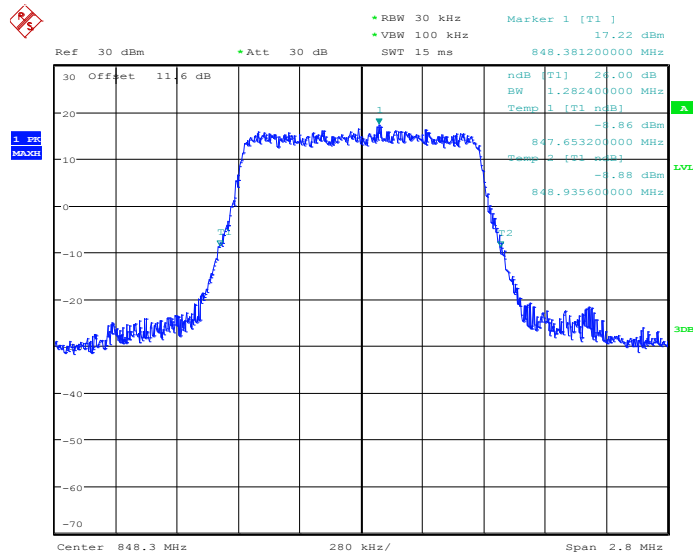

Date: 9.MAY.2014 13:53:00





<b>Band :</b>	LTE Band 5	<b>BW / Mod. :</b>	1.4MHz / 16QAM
---------------	------------	--------------------	----------------

99% Occupied Bandwidth Plot on Channel 20407

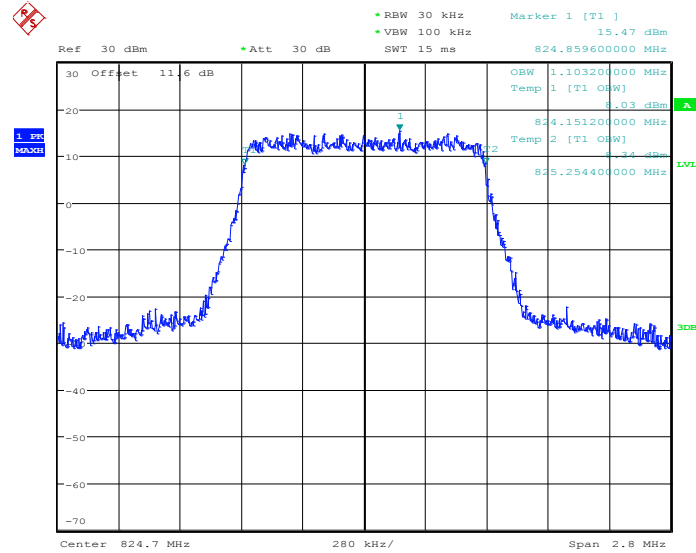

Date: 9.MAY.2014 13:43:16

26dB Bandwidth Plot on Channel 20407

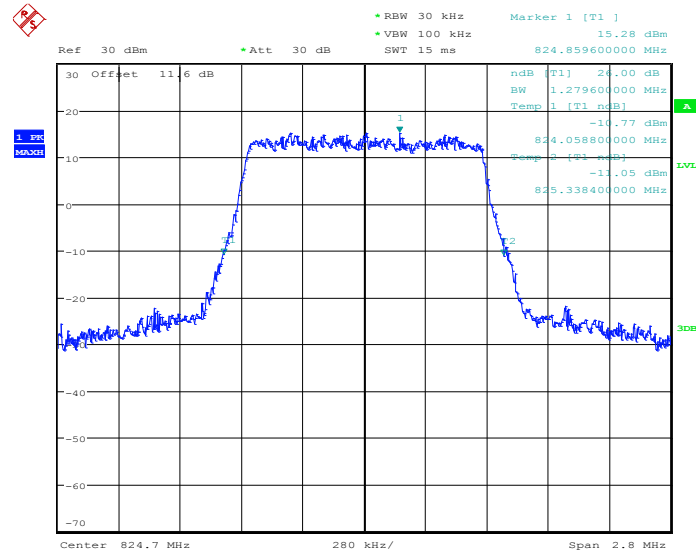

Date: 9.MAY.2014 13:43:34





99% Occupied Bandwidth Plot on Channel 20643

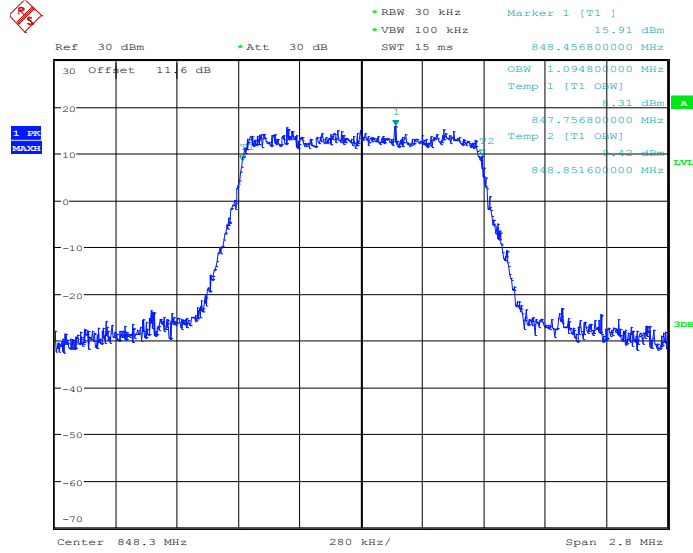

Date: 9.MAY.2014 13:52:43

26dB Bandwidth Plot on Channel 20643

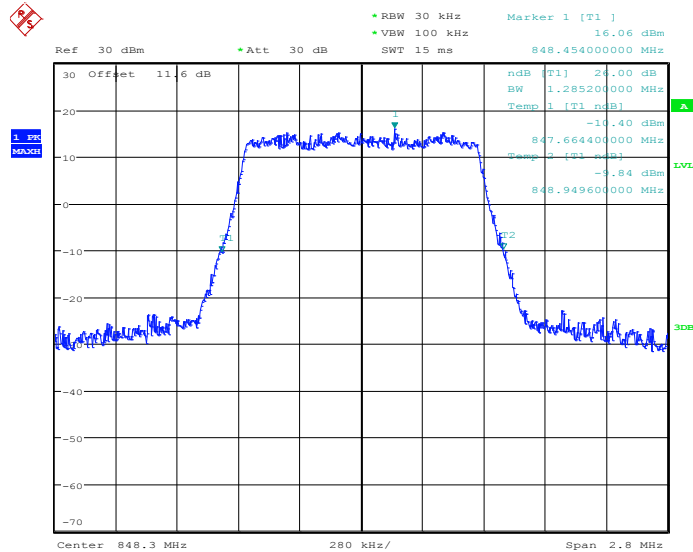

Date: 9.MAY.2014 13:53:18



Band :	LTE Band 5	BW / Mod. :	3MHz / QPSK
--------	------------	-------------	-------------

99% Occupied Bandwidth Plot on Channel 20415

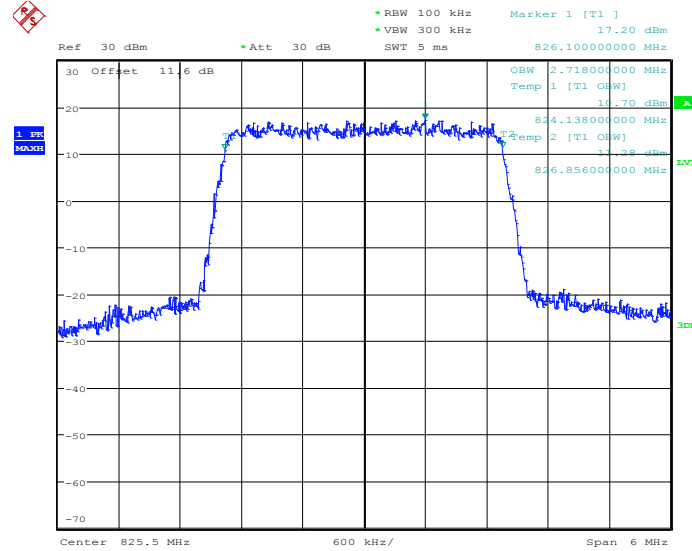

Date: 9.MAY.2014 14:01:14

26dB Bandwidth Plot on Channel 20415

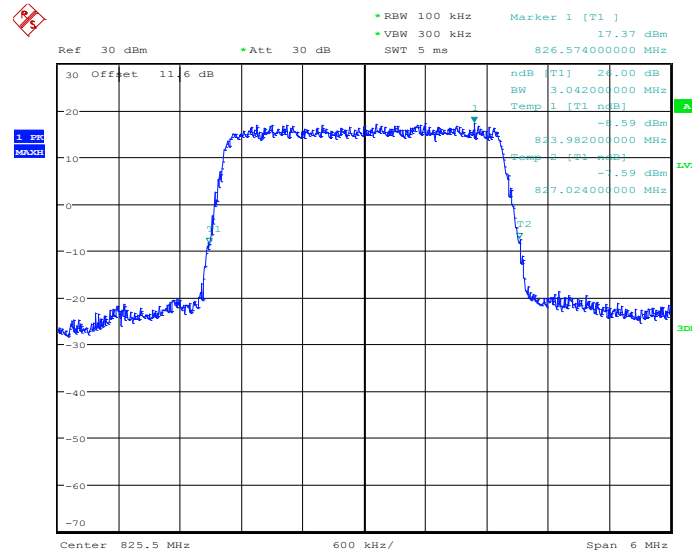

Date: 9.MAY.2014 14:01:48



99% Occupied Bandwidth Plot on Channel 20525

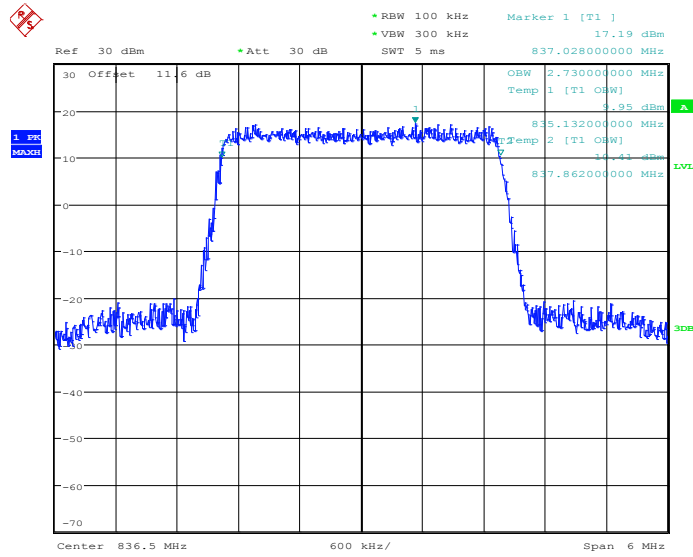

Date: 9.MAY.2014 14:07:32

26dB Bandwidth Plot on Channel 20525

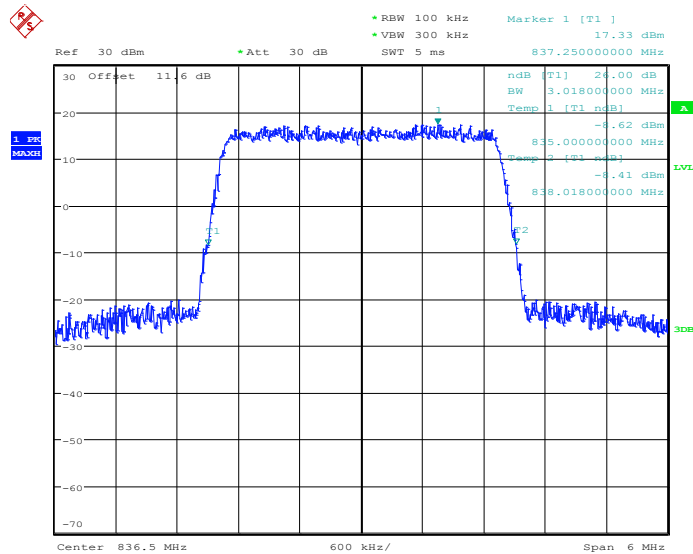

Date: 9.MAY.2014 14:08:06



99% Occupied Bandwidth Plot on Channel 20635

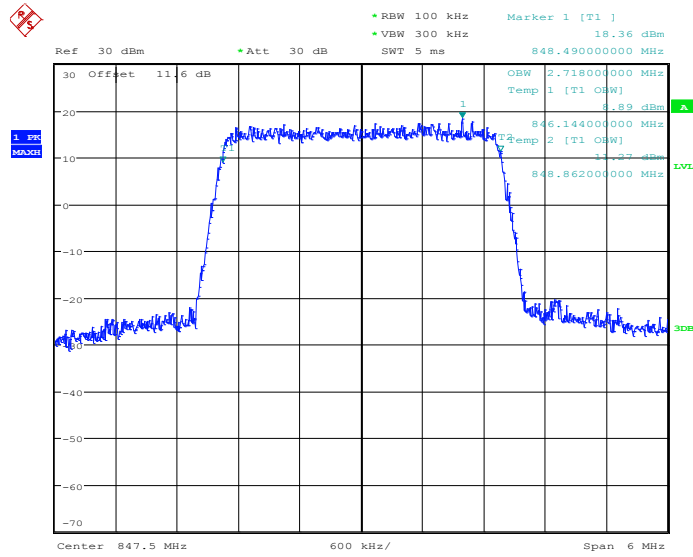

Date: 9.MAY.2014 14:10:42

26dB Bandwidth Plot on Channel 20635

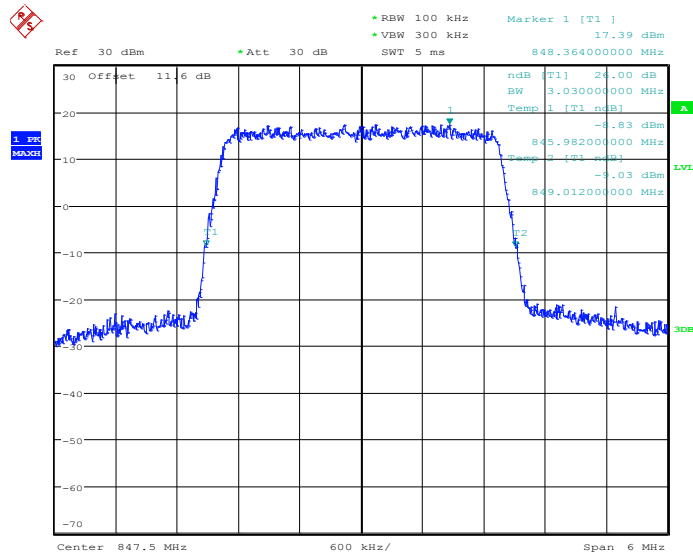

Date: 9.MAY.2014 14:11:16



<b>Band :</b>	LTE Band 5	<b>BW / Mod. :</b>	3MHz / 16QAM
---------------	------------	--------------------	--------------

99% Occupied Bandwidth Plot on Channel 20415

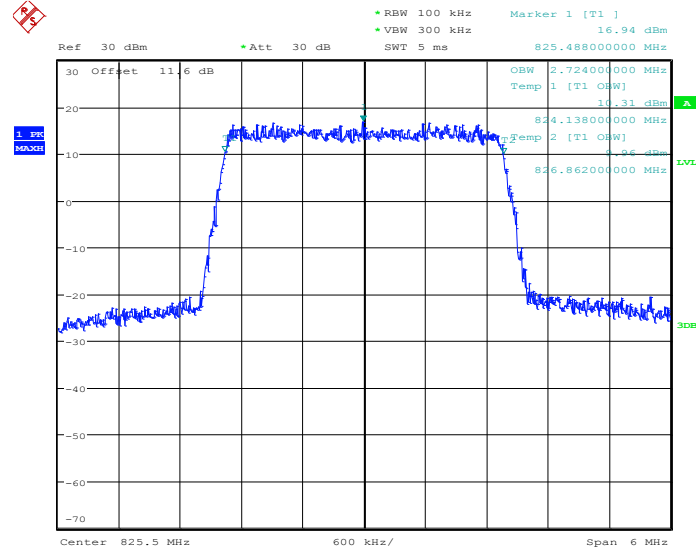

Date: 9.MAY.2014 14:01:30

26dB Bandwidth Plot on Channel 20415

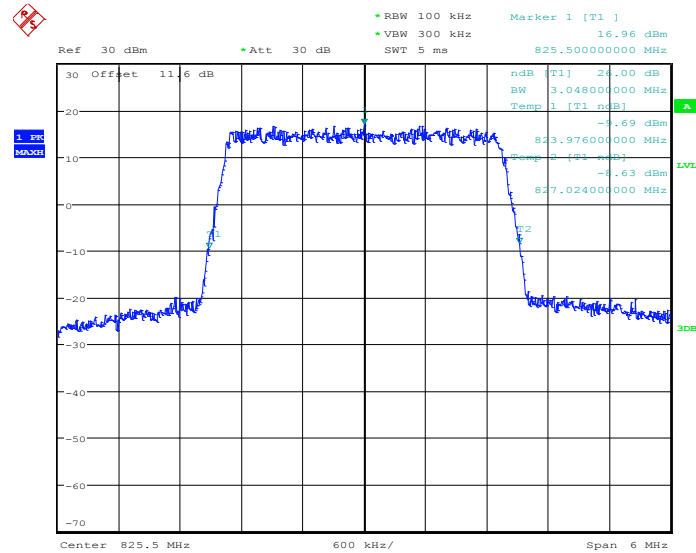

Date: 9.MAY.2014 14:02:06



99% Occupied Bandwidth Plot on Channel 20525

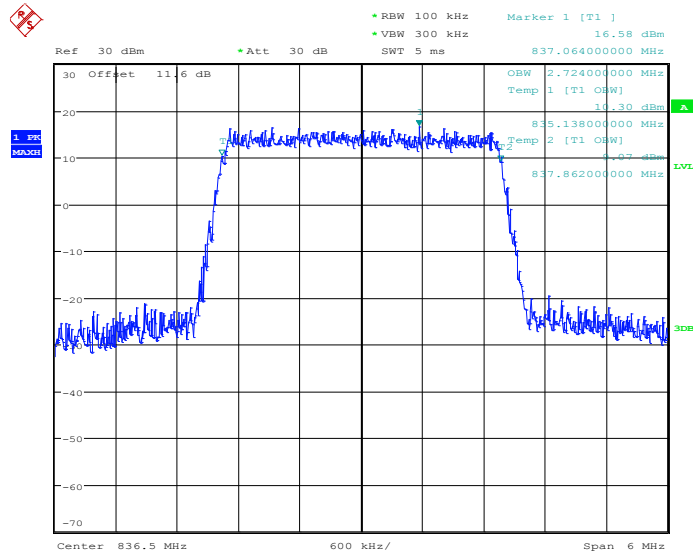

Date: 9.MAY.2014 14:07:48

26dB Bandwidth Plot on Channel 20525

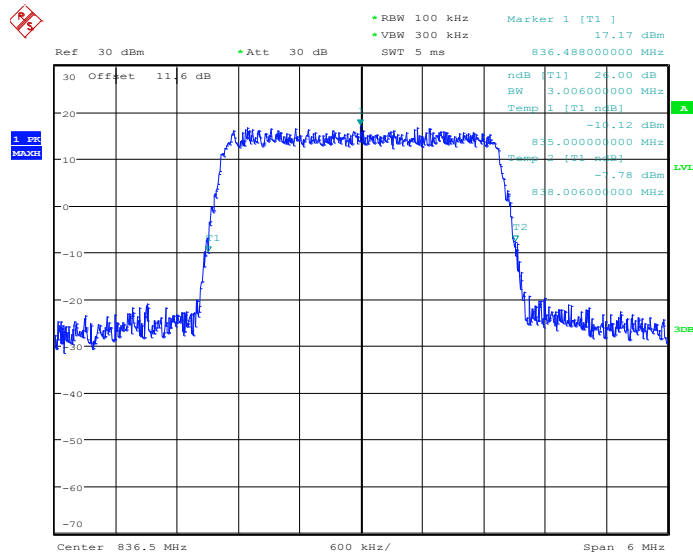

Date: 9.MAY.2014 14:08:24





99% Occupied Bandwidth Plot on Channel 20635

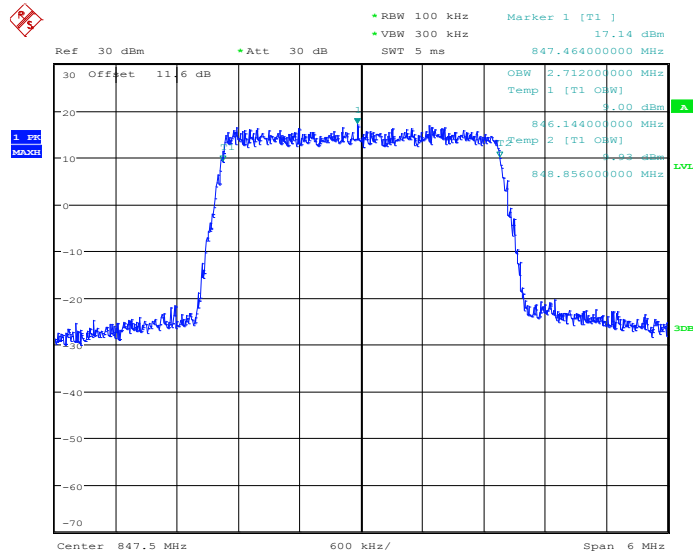

Date: 9.MAY.2014 14:10:58

26dB Bandwidth Plot on Channel 20635

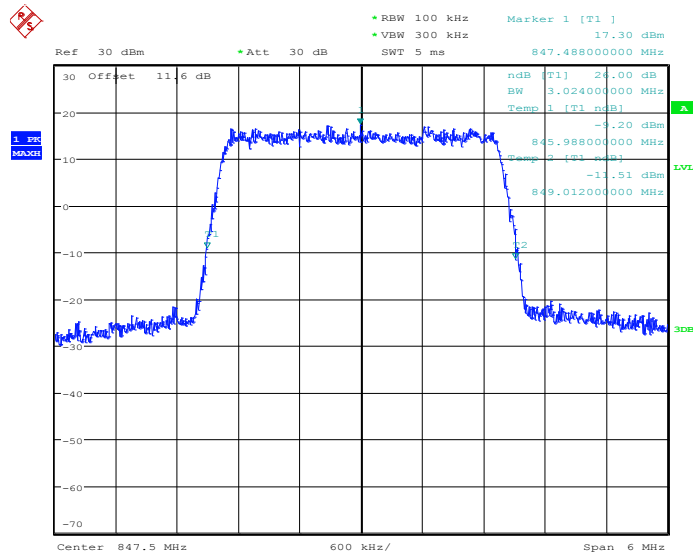

Date: 9.MAY.2014 14:11:34



Band :	LTE Band 5	BW / Mod. :	5MHz / QPSK
--------	------------	-------------	-------------

99% Occupied Bandwidth Plot on Channel 20425

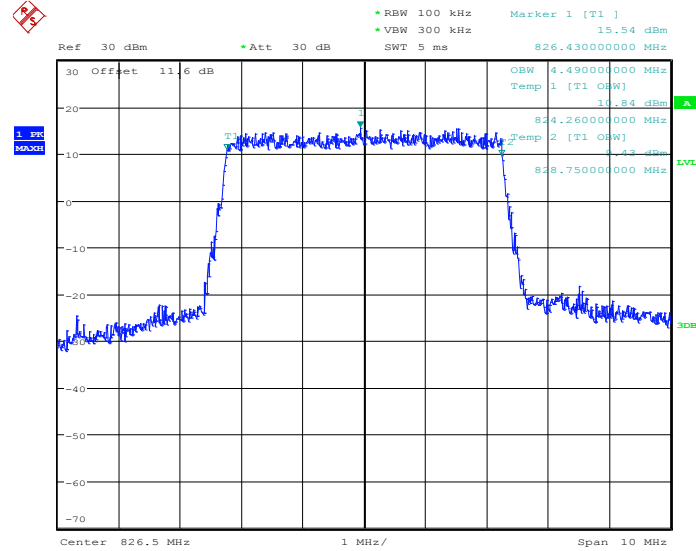

Date: 9.MAY.2014 14:17:01

26dB Bandwidth Plot on Channel 20425

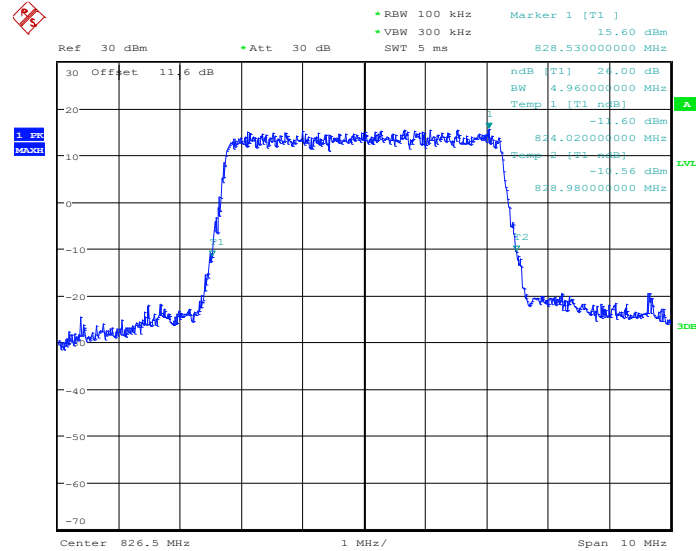

Date: 9.MAY.2014 14:17:34



### 99% Occupied Bandwidth Plot on Channel 20525

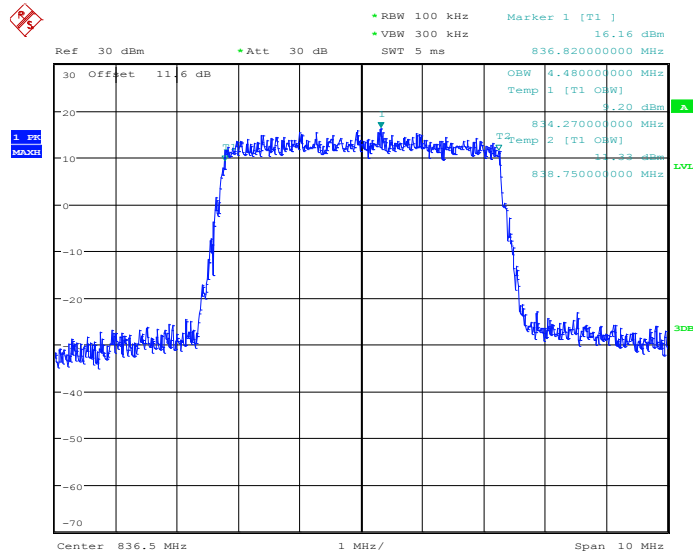

Date: 9.MAY.2014 14:23:18

### 26dB Bandwidth Plot on Channel 20525

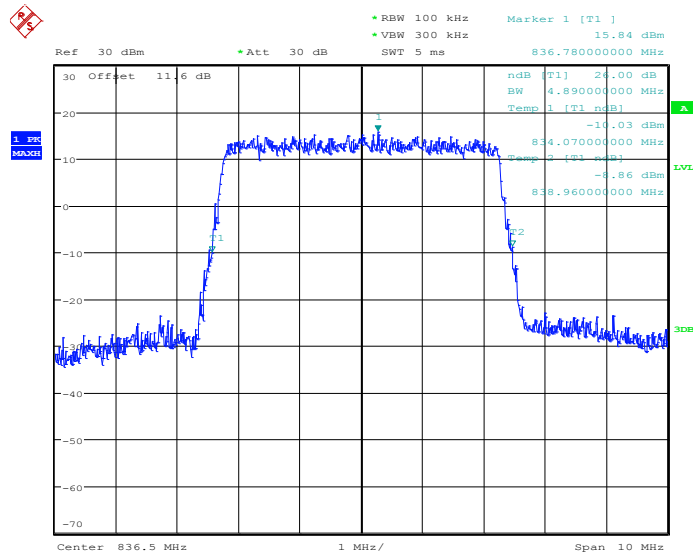

Date: 9.MAY.2014 14:23:52



99% Occupied Bandwidth Plot on Channel 20625

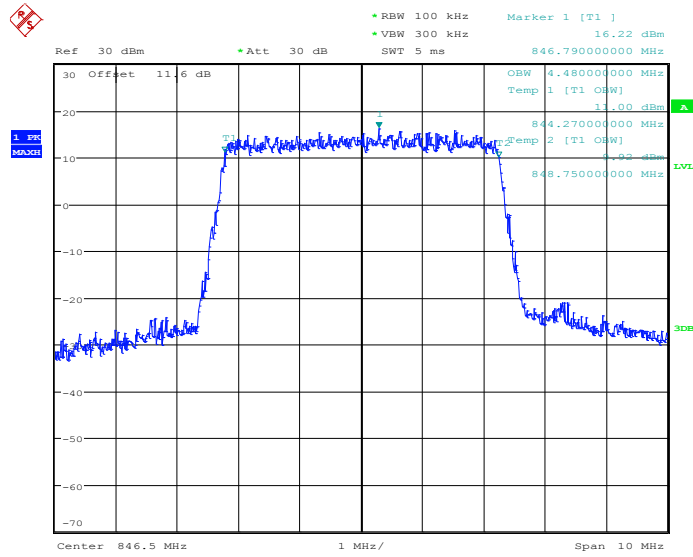

Date: 9.MAY.2014 14:26:27

26dB Bandwidth Plot on Channel 20625

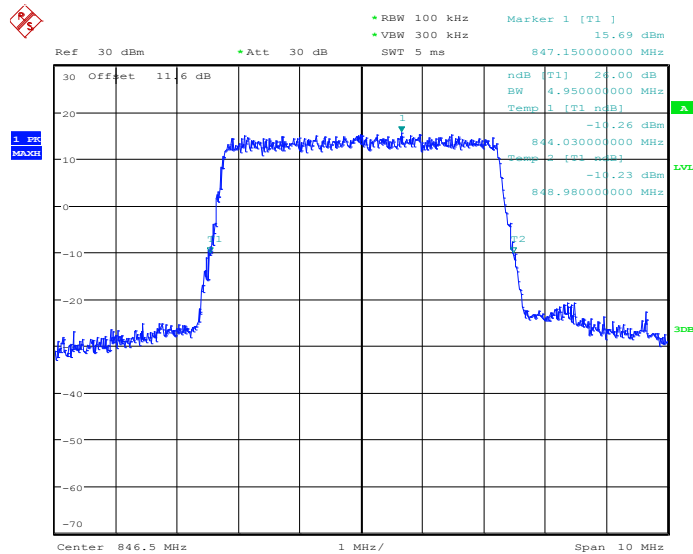

Date: 9.MAY.2014 14:27:00



Band :	LTE Band 5	BW / Mod. :	5MHz / 16QAM
--------	------------	-------------	--------------

99% Occupied Bandwidth Plot on Channel 20425

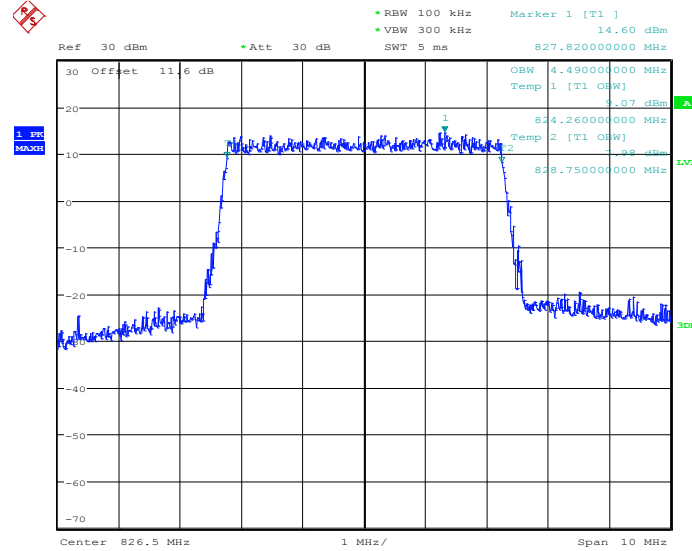

Date: 9.MAY.2014 14:17:17

26dB Bandwidth Plot on Channel 20425

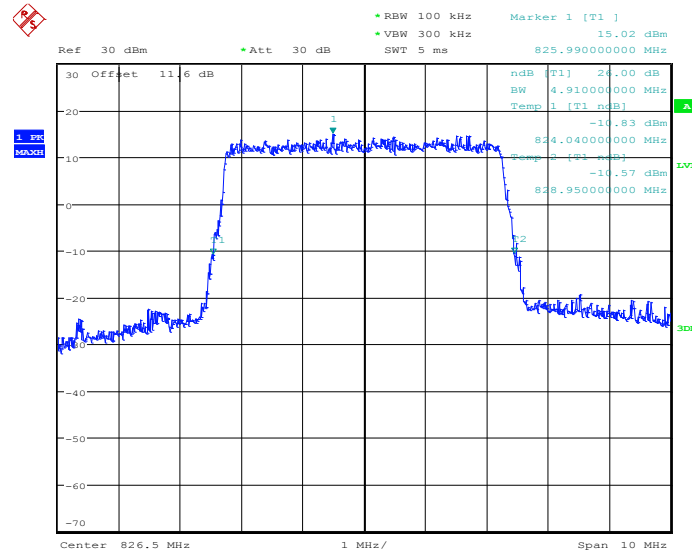

Date: 9.MAY.2014 14:17:52



99% Occupied Bandwidth Plot on Channel 20525

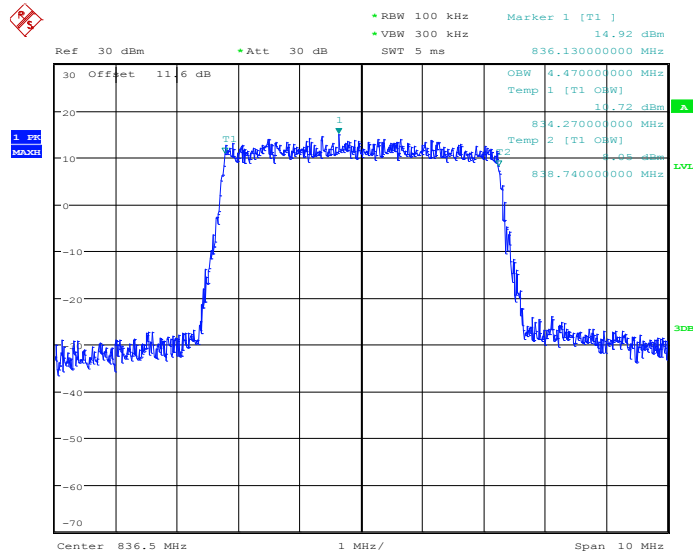

Date: 9.MAY.2014 14:23:34

26dB Bandwidth Plot on Channel 20525

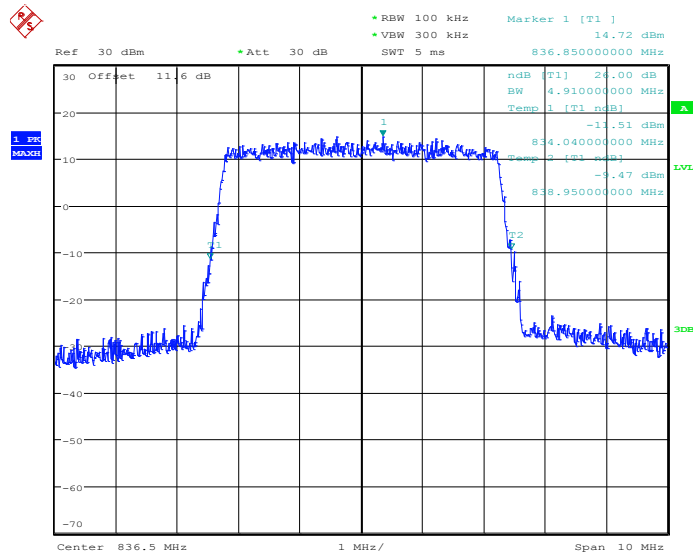

Date: 9.MAY.2014 14:24:10



99% Occupied Bandwidth Plot on Channel 20625

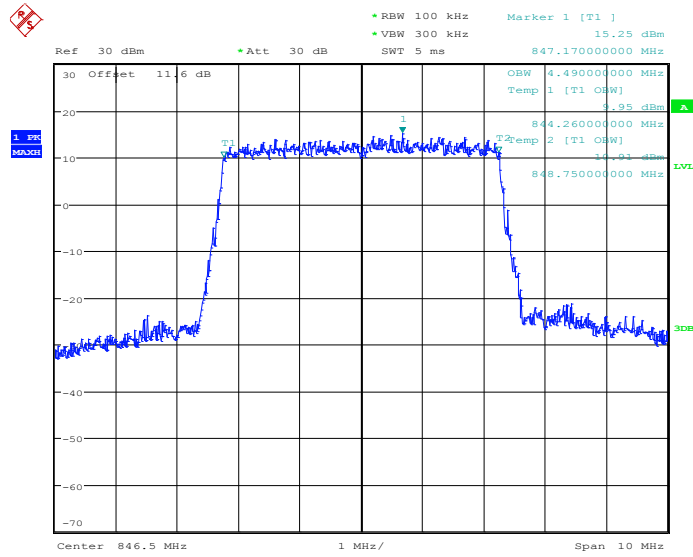

Date: 9.MAY.2014 14:26:43

26dB Bandwidth Plot on Channel 20625

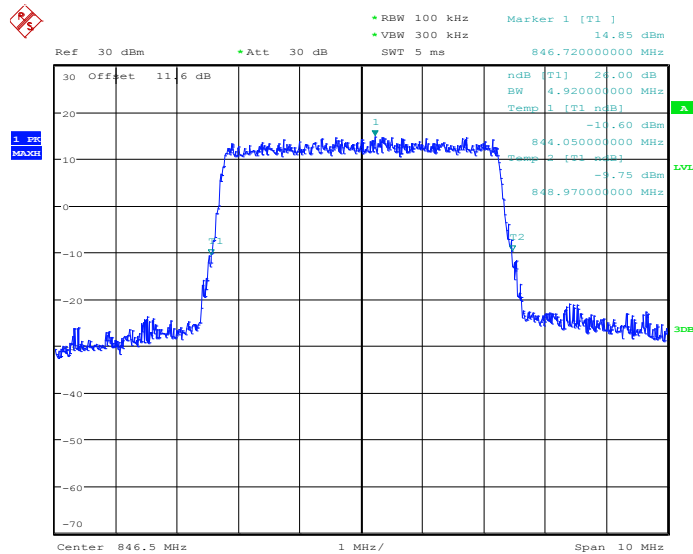

Date: 9.MAY.2014 14:27:18



Band :	LTE Band 5	BW / Mod. :	10MHz / QPSK
--------	------------	-------------	--------------

99% Occupied Bandwidth Plot on Channel 20450

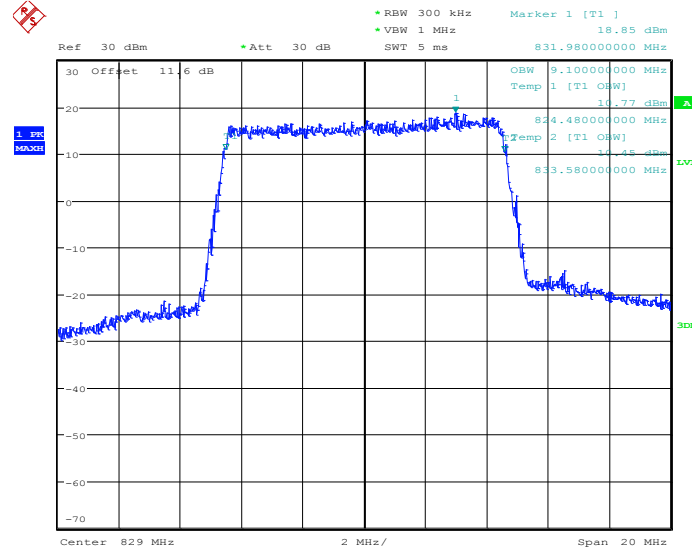

Date: 9.MAY.2014 14:32:44

26dB Bandwidth Plot on Channel 20450

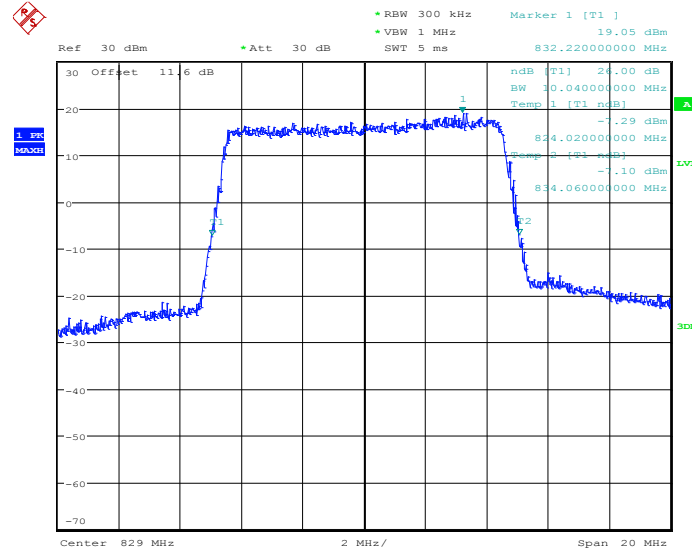

Date: 9.MAY.2014 14:33:18





99% Occupied Bandwidth Plot on Channel 20525

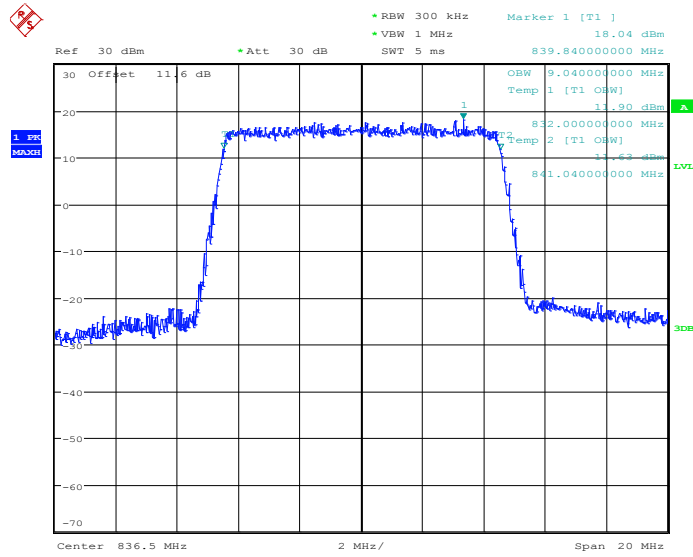

Date: 9.MAY.2014 14:39:01

26dB Bandwidth Plot on Channel 20525

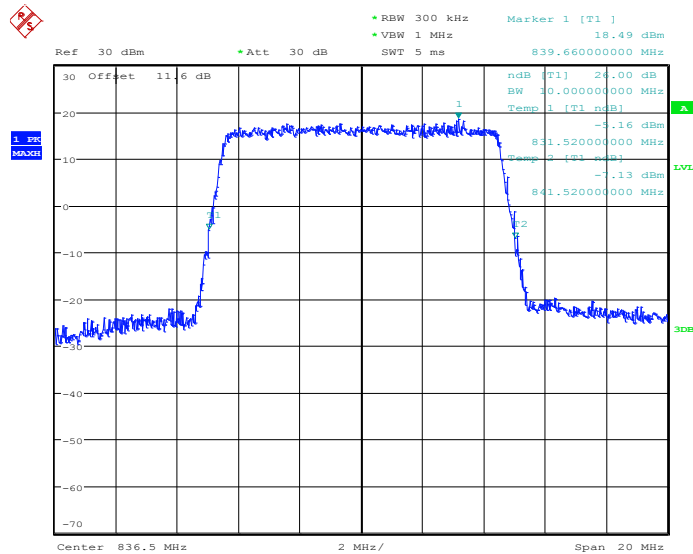

Date: 9.MAY.2014 14:39:35



99% Occupied Bandwidth Plot on Channel 20600

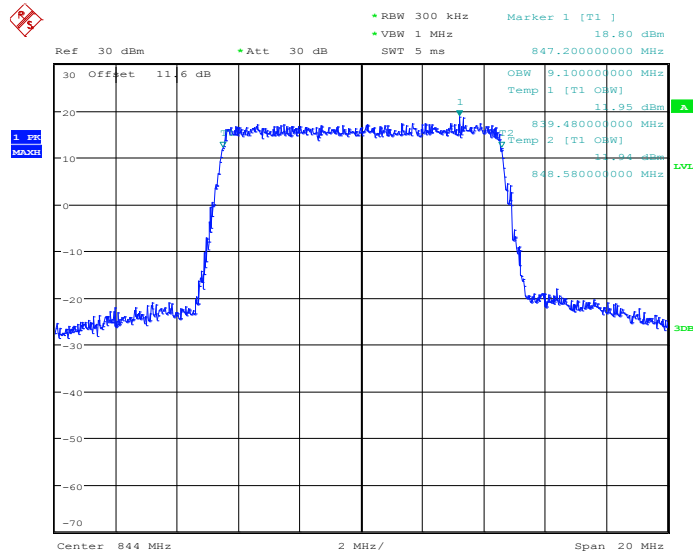

Date: 9.MAY.2014 14:42:10

26dB Bandwidth Plot on Channel 20600

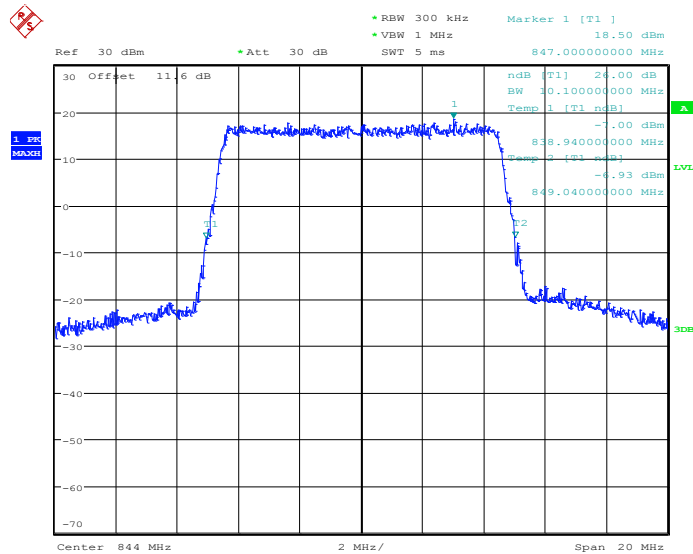

Date: 9.MAY.2014 14:42:43



<b>Band :</b>	LTE Band 5	<b>BW / Mod. :</b>	10MHz / 16QAM
---------------	------------	--------------------	---------------

99% Occupied Bandwidth Plot on Channel 20450

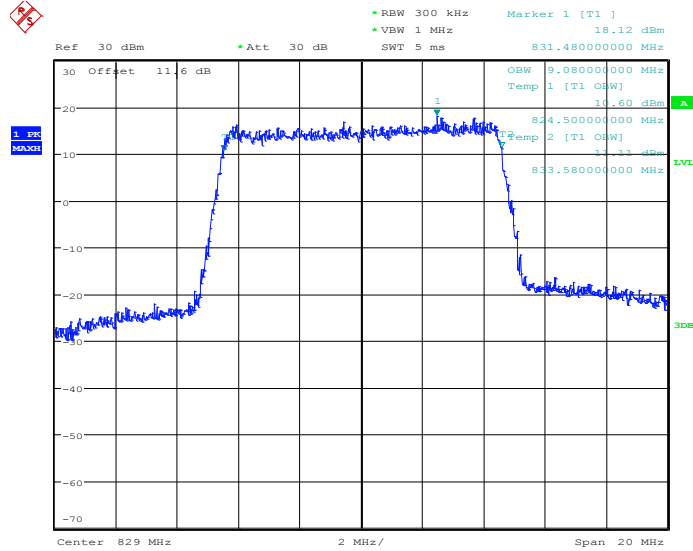

Date: 9.MAY.2014 14:33:00

26dB Bandwidth Plot on Channel 20450

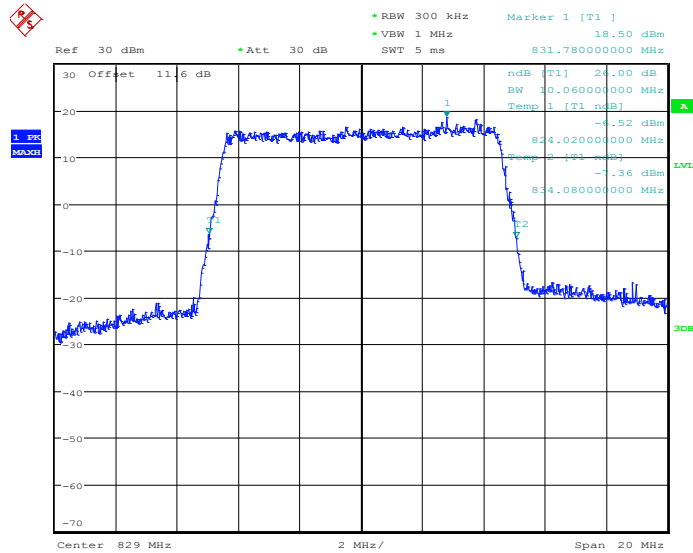

Date: 9.MAY.2014 14:33:36



99% Occupied Bandwidth Plot on Channel 20525

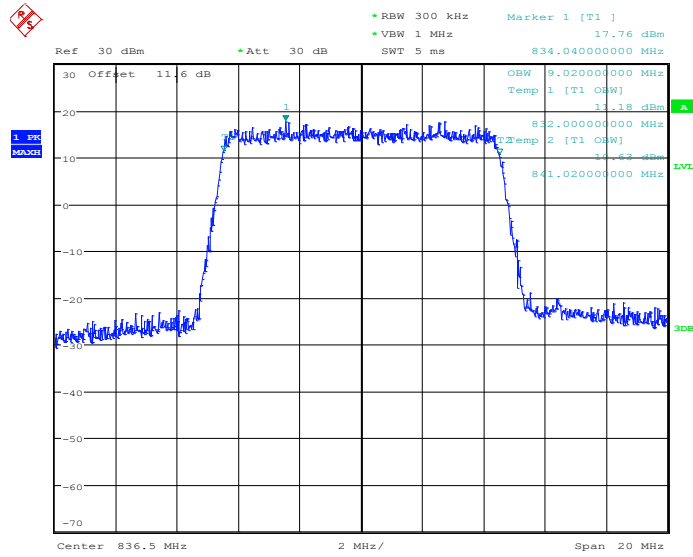

Date: 9.MAY.2014 14:39:17

26dB Bandwidth Plot on Channel 20525

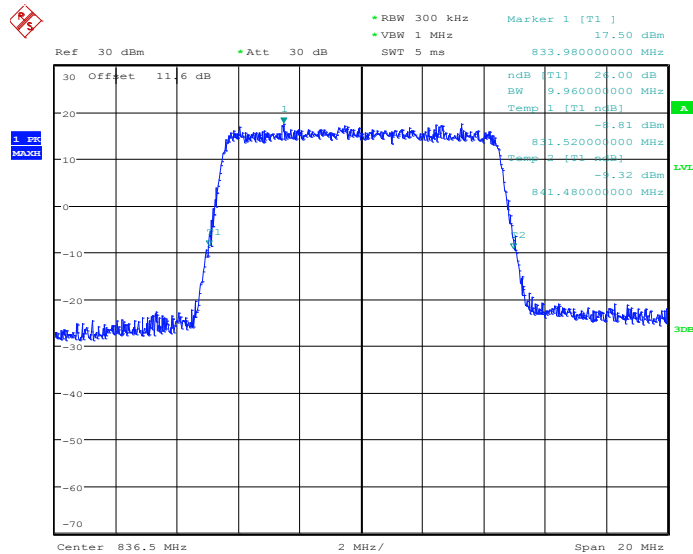

Date: 9.MAY.2014 14:39:53



99% Occupied Bandwidth Plot on Channel 20600

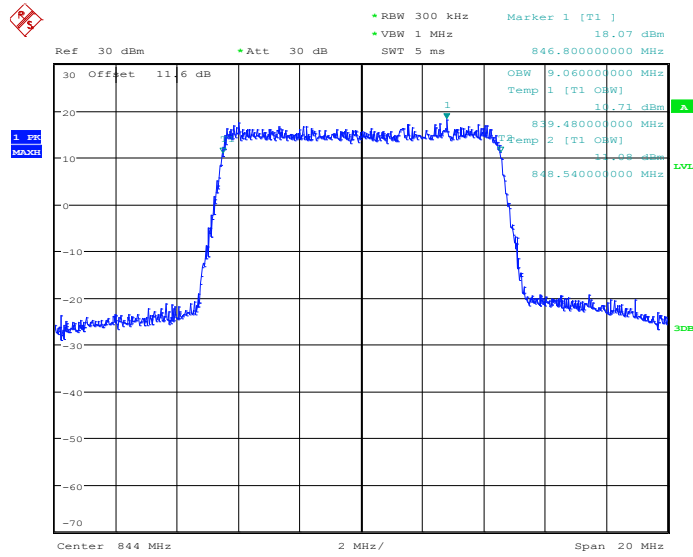

Date: 9.MAY.2014 14:42:26

26dB Bandwidth Plot on Channel 20600

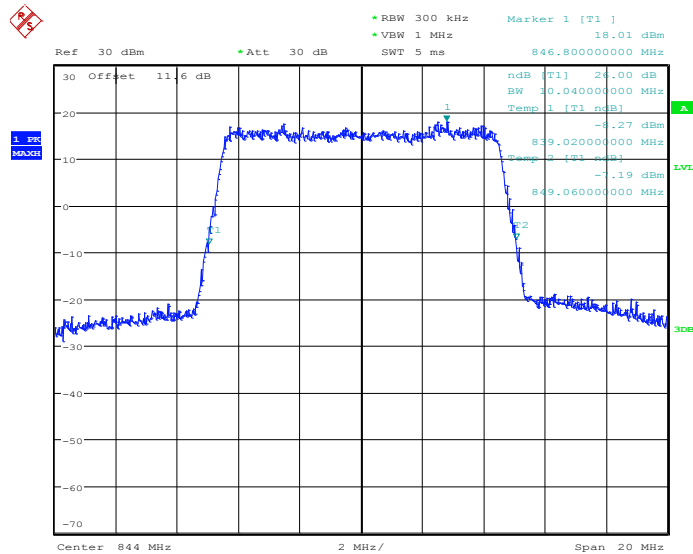

Date: 9.MAY.2014 14:43:01



<b>Band :</b>	LTE Band 2	<b>BW / Mod. :</b>	1.4MHz / QPSK
---------------	------------	--------------------	---------------

99% Occupied Bandwidth Plot on Channel 18607

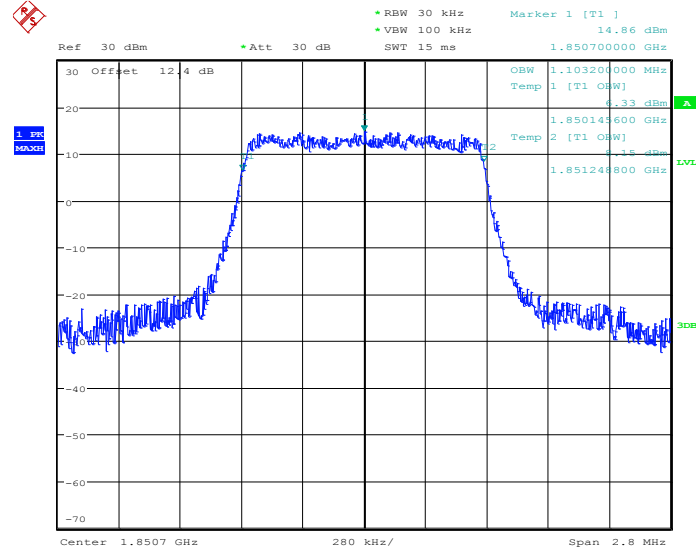

Date: 9.MAY.2014 15:02:06

26dB Bandwidth Plot on Channel 18607

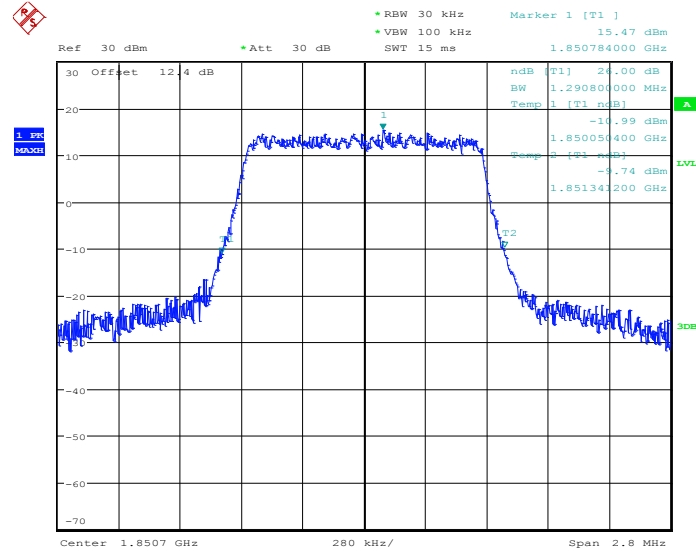

Date: 9.MAY.2014 15:02:40



<b>Band :</b>	LTE Band 2	<b>BW / Mod. :</b>	1.4MHz / QPSK
---------------	------------	--------------------	---------------

99% Occupied Bandwidth Plot on Channel 18900

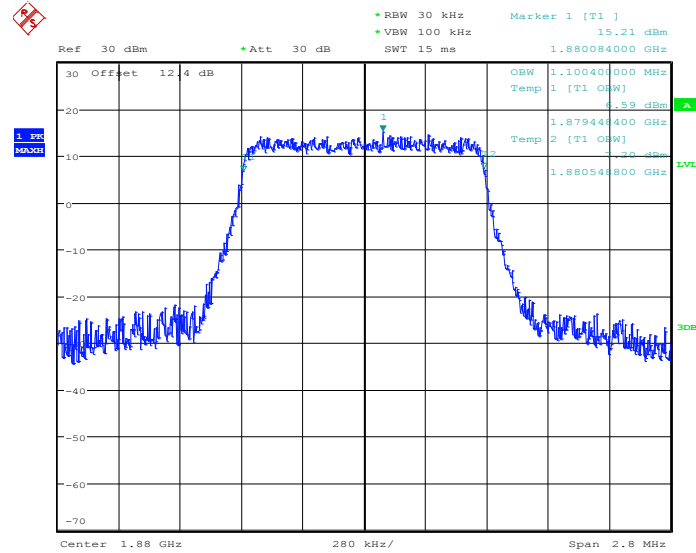

Date: 9.MAY.2014 15:08:24

26dB Bandwidth Plot on Channel 18900

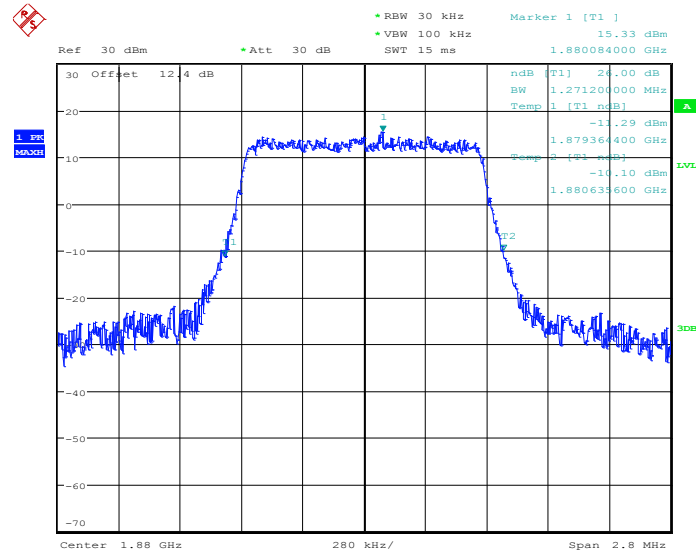

Date: 9.MAY.2014 15:08:58



99% Occupied Bandwidth Plot on Channel 19193

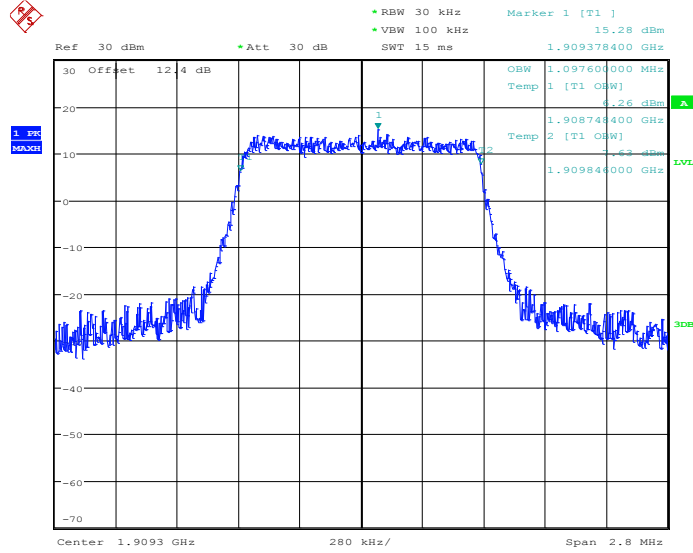

Date: 9.MAY.2014 15:11:32

26dB Bandwidth Plot on Channel 19193

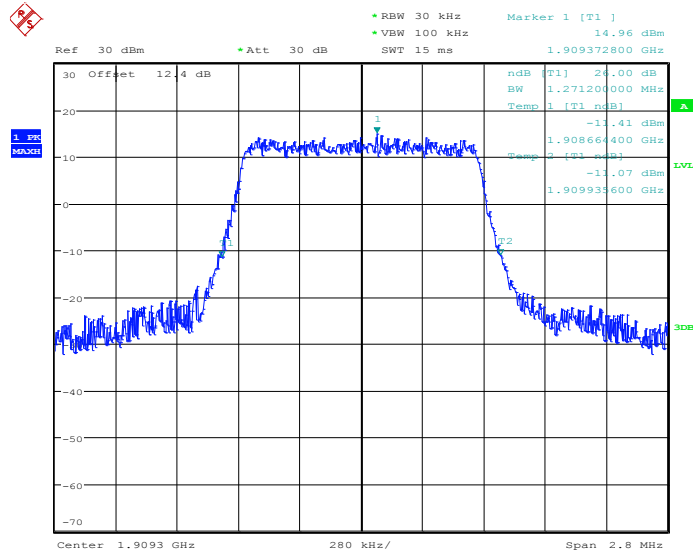

Date: 9.MAY.2014 15:12:06





<b>Band :</b>	LTE Band 2	<b>BW / Mod. :</b>	1.4MHz / 16QAM
---------------	------------	--------------------	----------------

99% Occupied Bandwidth Plot on Channel 18607

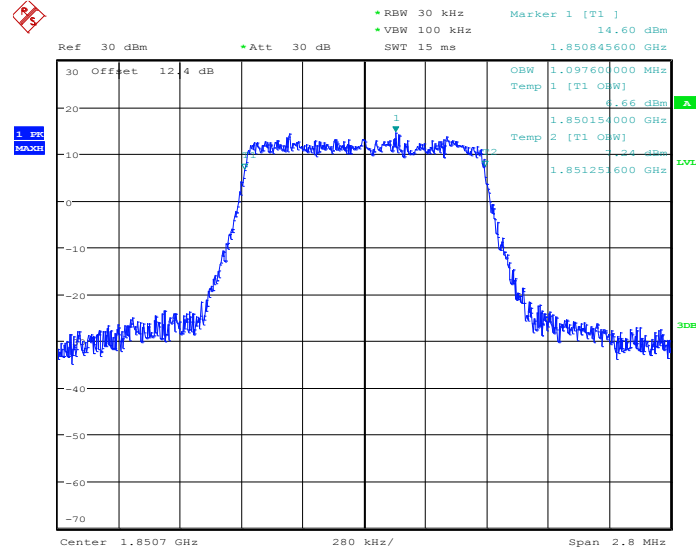

Date: 9.MAY.2014 15:02:22

26dB Bandwidth Plot on Channel 18607

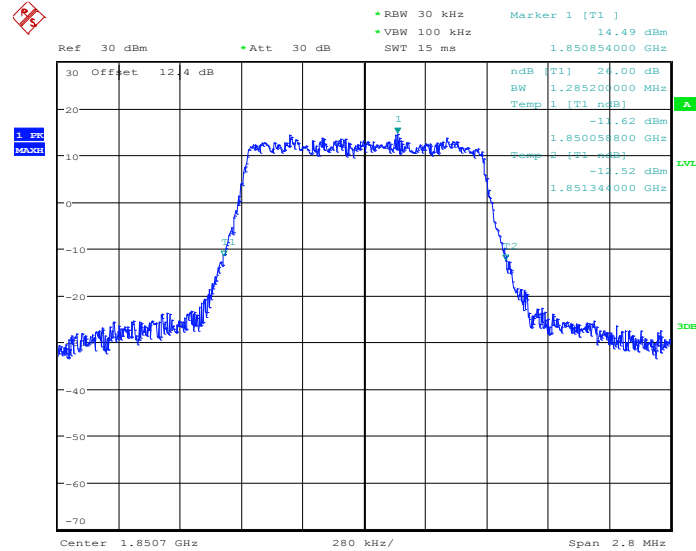

Date: 9.MAY.2014 15:02:58



99% Occupied Bandwidth Plot on Channel 18900

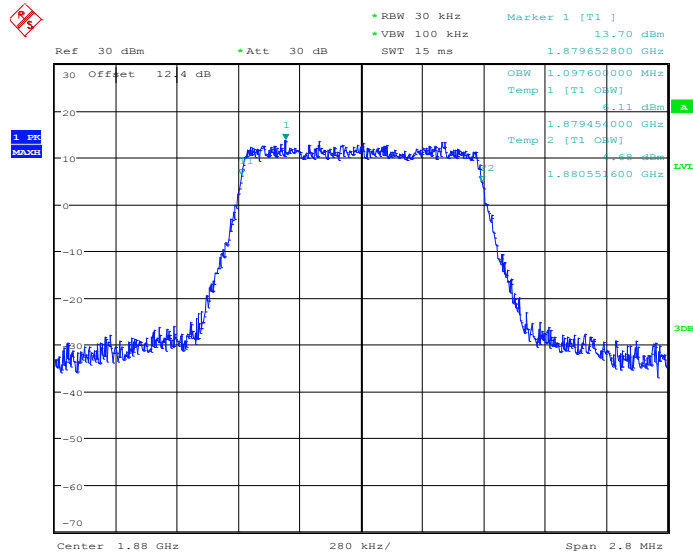

Date: 9.MAY.2014 15:08:40

26dB Bandwidth Plot on Channel 18900

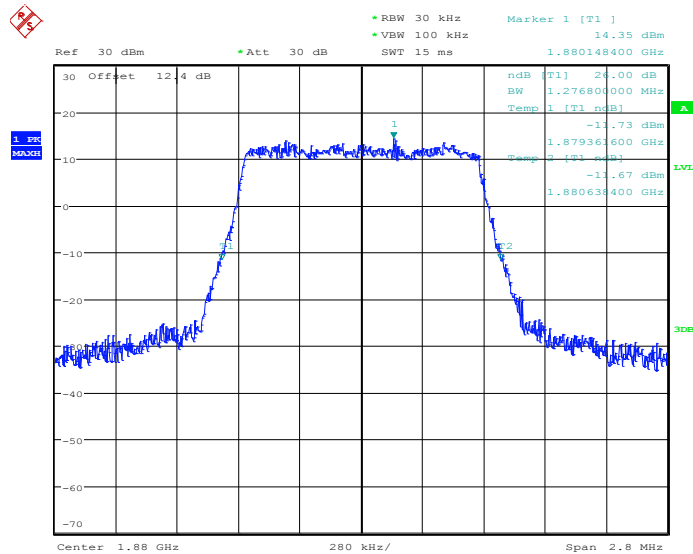

Date: 9.MAY.2014 15:09:16



99% Occupied Bandwidth Plot on Channel 19193

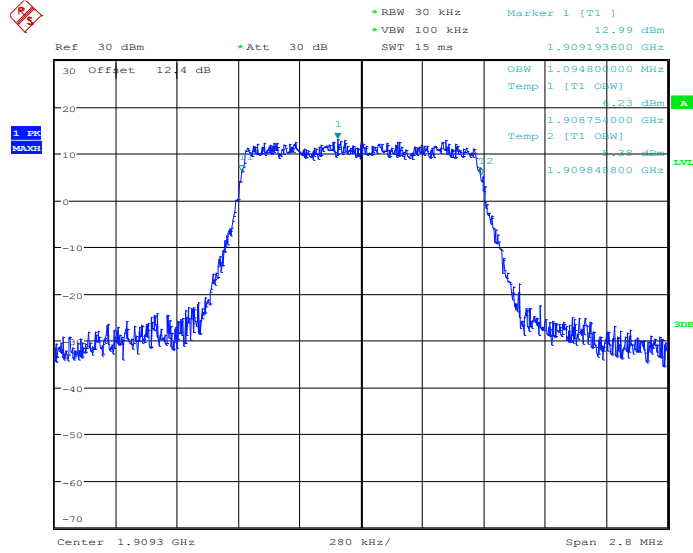

Date: 9.MAY.2014 15:11:48

26dB Bandwidth Plot on Channel 19193

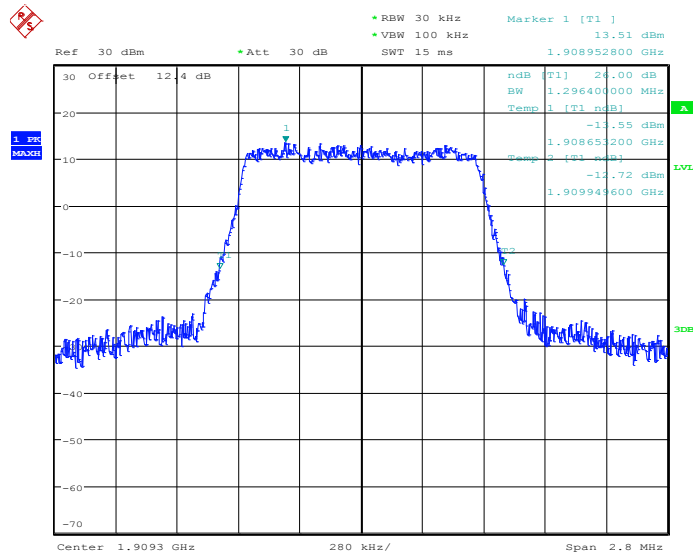

Date: 9.MAY.2014 15:12:24



Band :	LTE Band 2	BW / Mod. :	3MHz / QPSK
--------	------------	-------------	-------------

99% Occupied Bandwidth Plot on Channel 18615

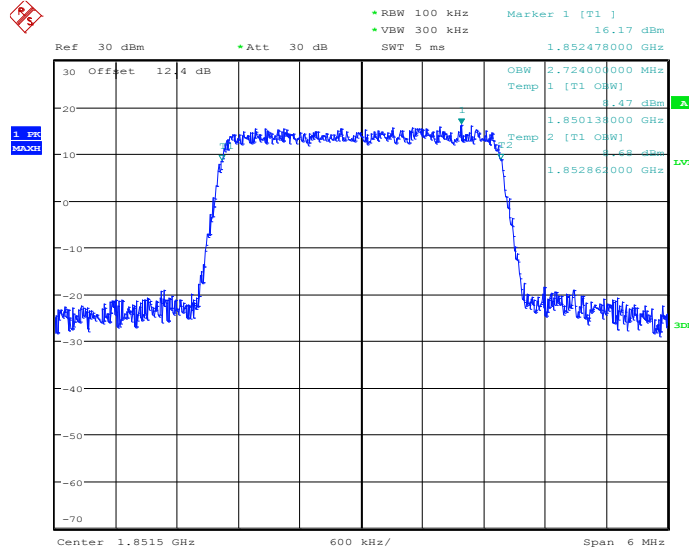

Date: 9.MAY.2014 15:18:27

26dB Bandwidth Plot on Channel 18615

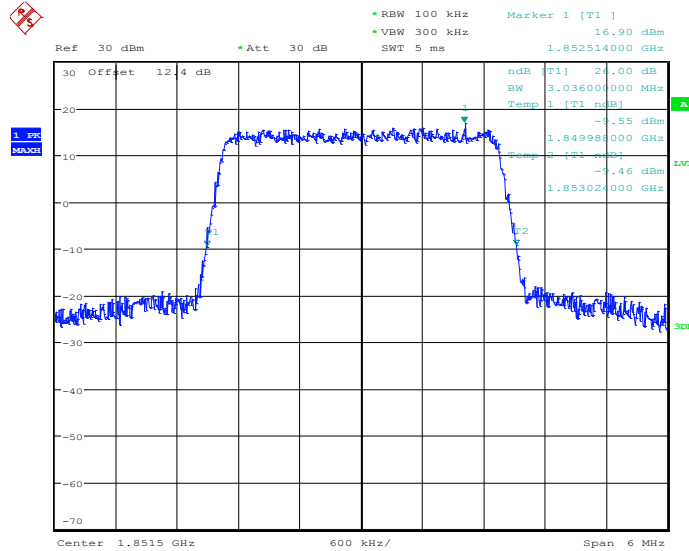

Date: 9.MAY.2014 15:19:01



99% Occupied Bandwidth Plot on Channel 18900

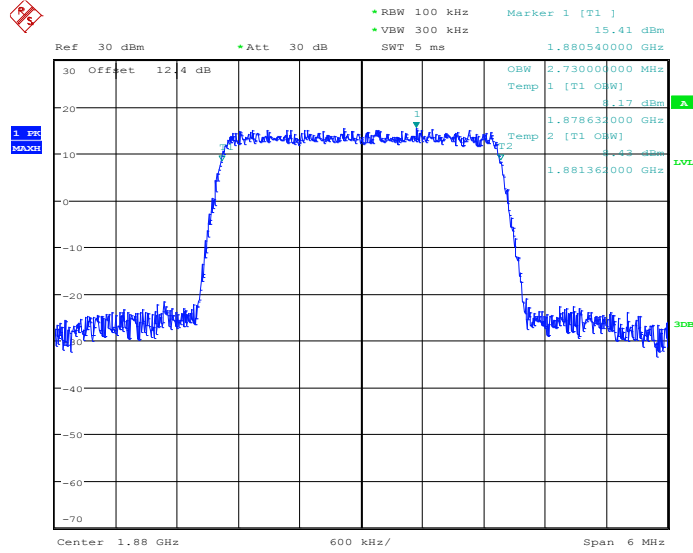

Date: 9.MAY.2014 15:32:52

26dB Bandwidth Plot on Channel 18900

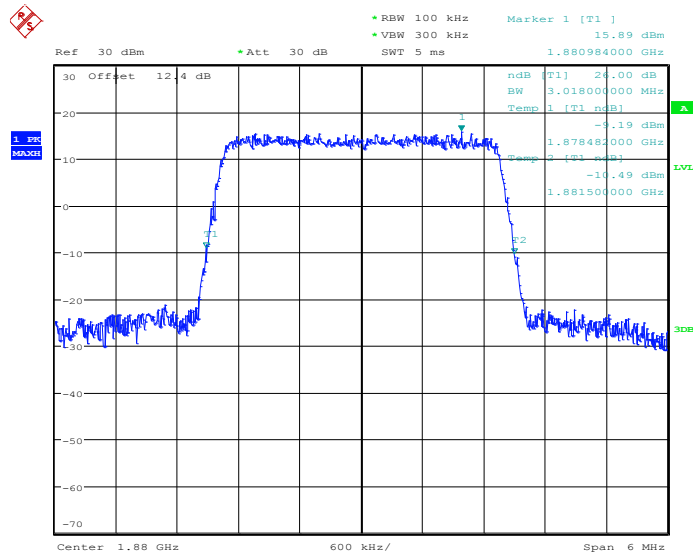

Date: 9.MAY.2014 15:33:26



### 99% Occupied Bandwidth Plot on Channel 19185

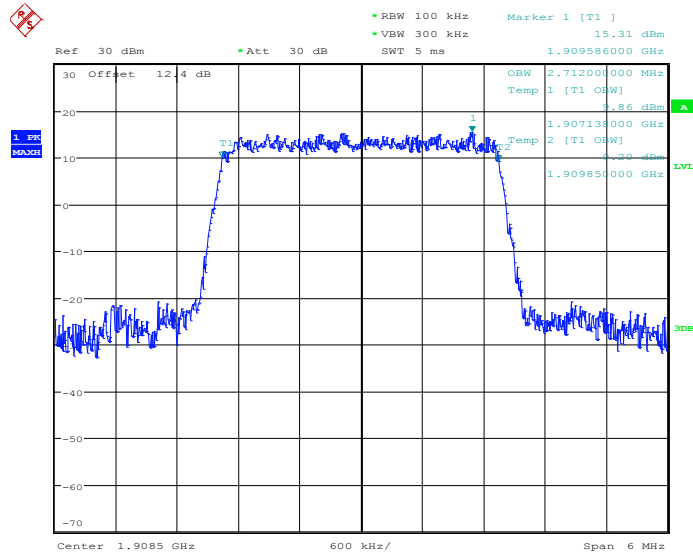

Date: 9.MAY.2014 15:36:01

### 26dB Bandwidth Plot on Channel 19185

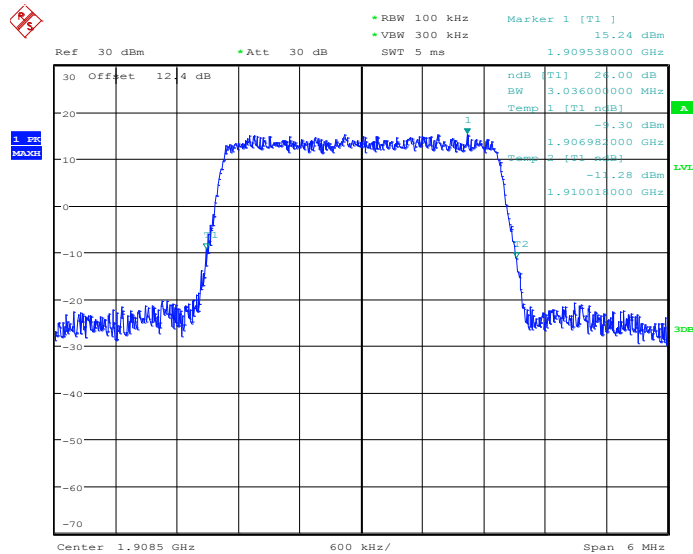

Date: 9.MAY.2014 15:36:35



Band :	LTE Band 2	BW / Mod. :	3MHz / 16QAM
--------	------------	-------------	--------------

99% Occupied Bandwidth Plot on Channel 18615

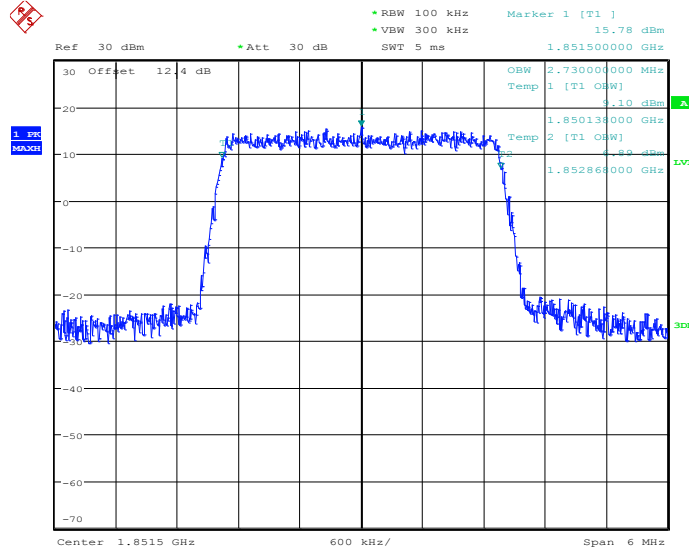

Date: 9.MAY.2014 15:18:43

26dB Bandwidth Plot on Channel 18615

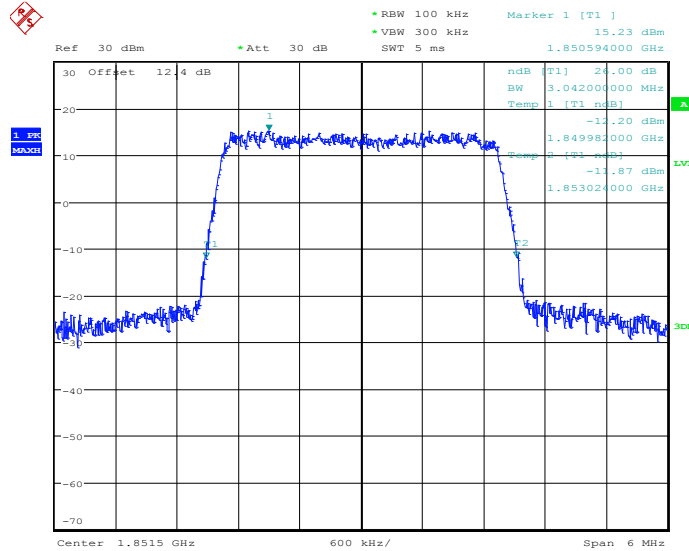

Date: 9.MAY.2014 15:19:19



99% Occupied Bandwidth Plot on Channel 18900

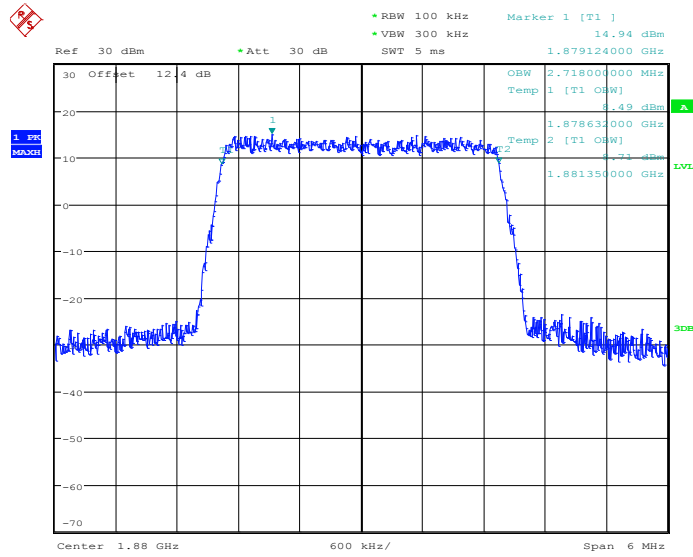

Date: 9.MAY.2014 15:33:08

26dB Bandwidth Plot on Channel 18900

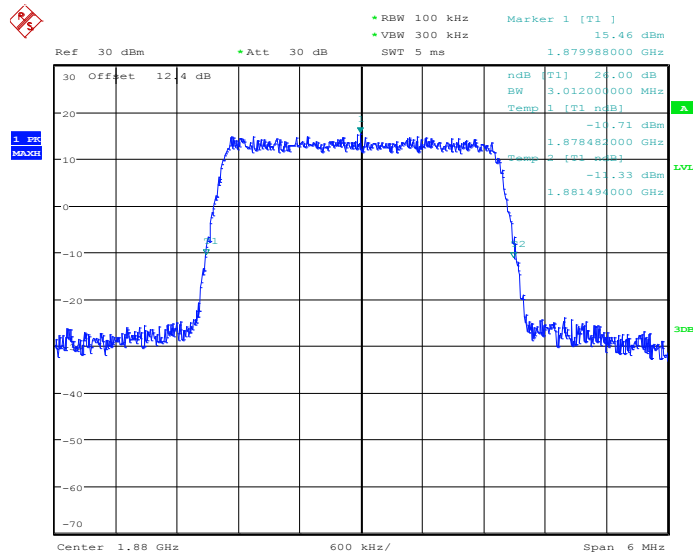

Date: 9.MAY.2014 15:33:44





### 99% Occupied Bandwidth Plot on Channel 19185

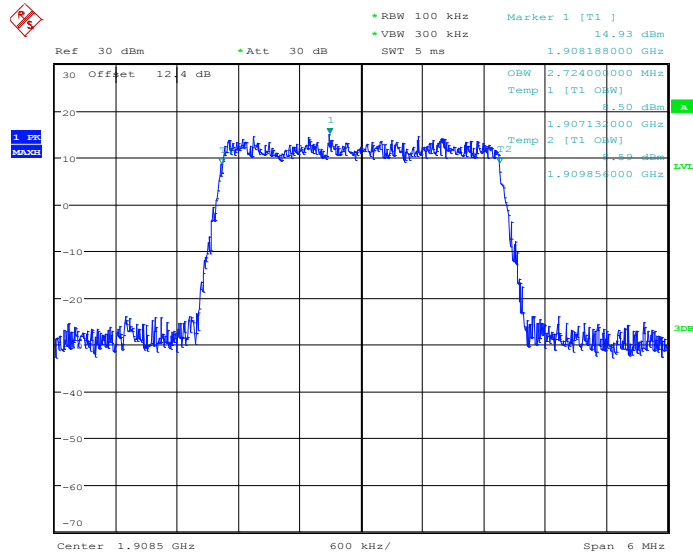

Date: 9.MAY.2014 15:36:17

### 26dB Bandwidth Plot on Channel 19185

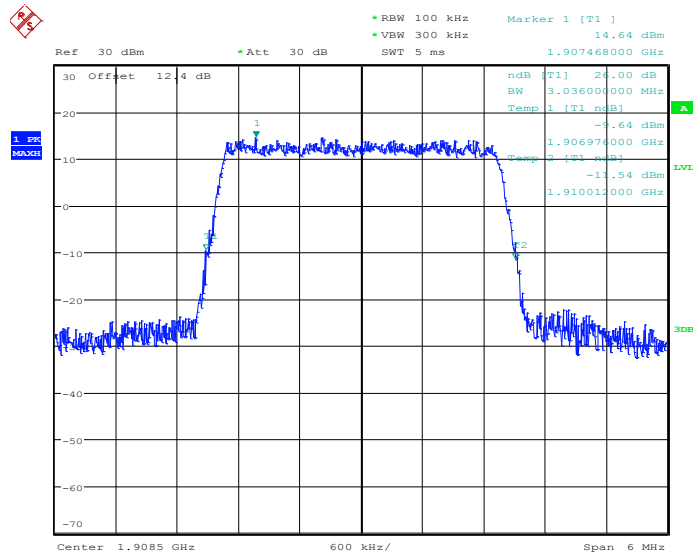

Date: 9.MAY.2014 15:36:53



Band :	LTE Band 2	BW / Mod. :	5MHz / QPSK
--------	------------	-------------	-------------

99% Occupied Bandwidth Plot on Channel 18625

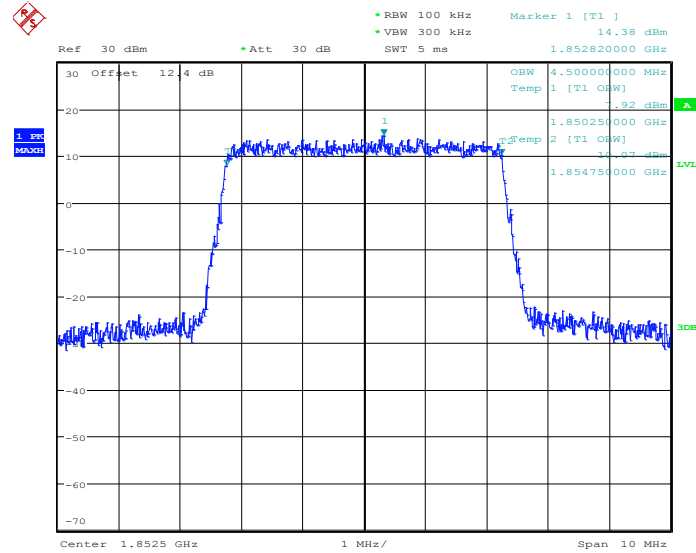

Date: 9.MAY.2014 15:42:20

26dB Bandwidth Plot on Channel 18625

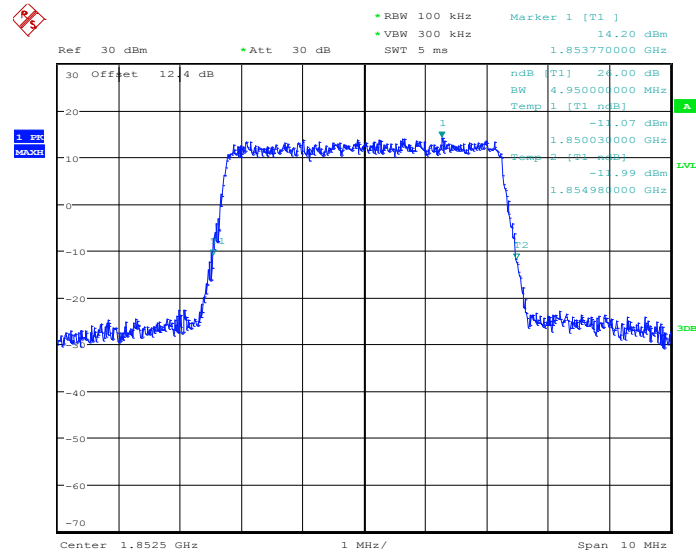

Date: 9.MAY.2014 15:42:54



### 99% Occupied Bandwidth Plot on Channel 18900

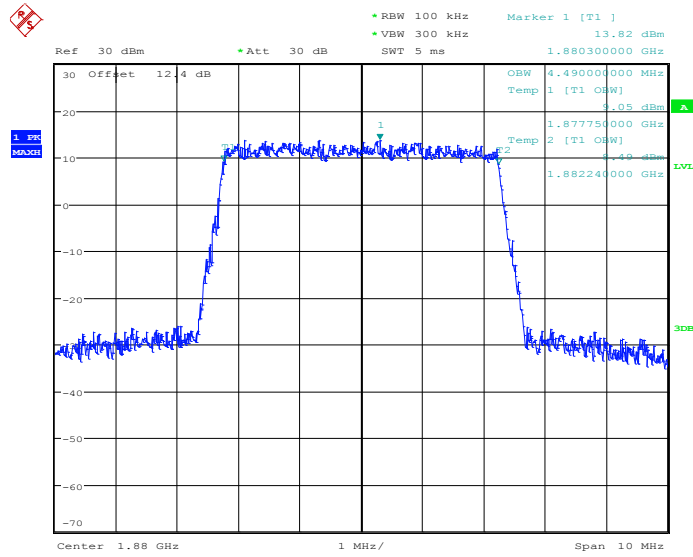

Date: 9.MAY.2014 15:48:39

### 26dB Bandwidth Plot on Channel 18900

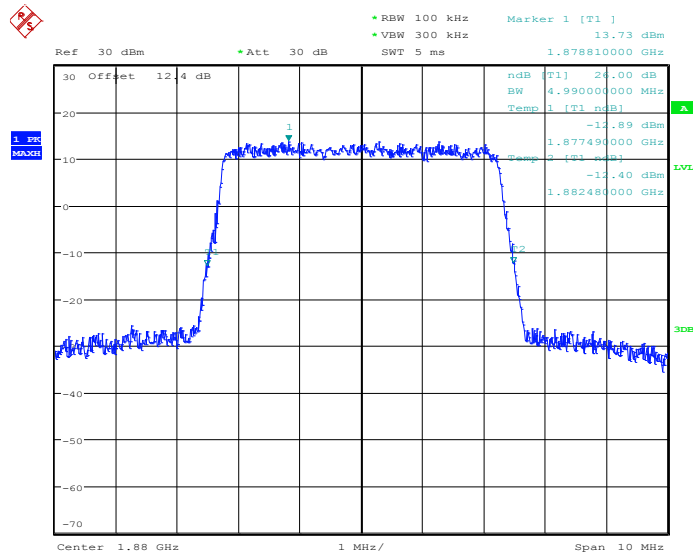

Date: 9.MAY.2014 15:49:12



99% Occupied Bandwidth Plot on Channel 19175

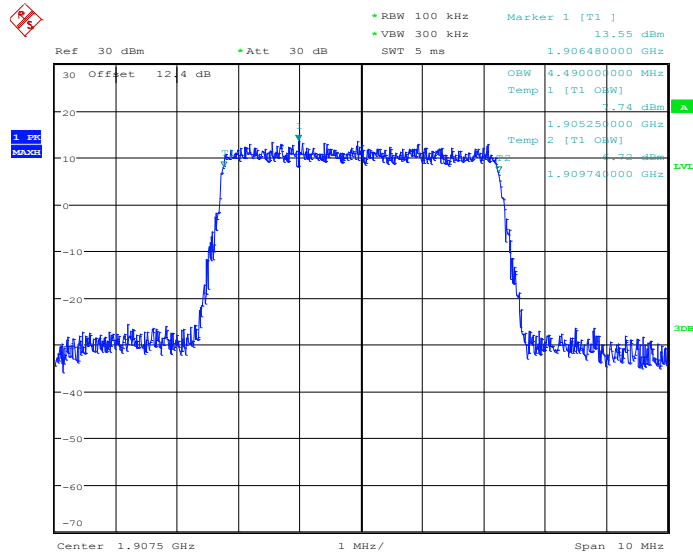

Date: 9.MAY.2014 15:51:47

26dB Bandwidth Plot on Channel 19175

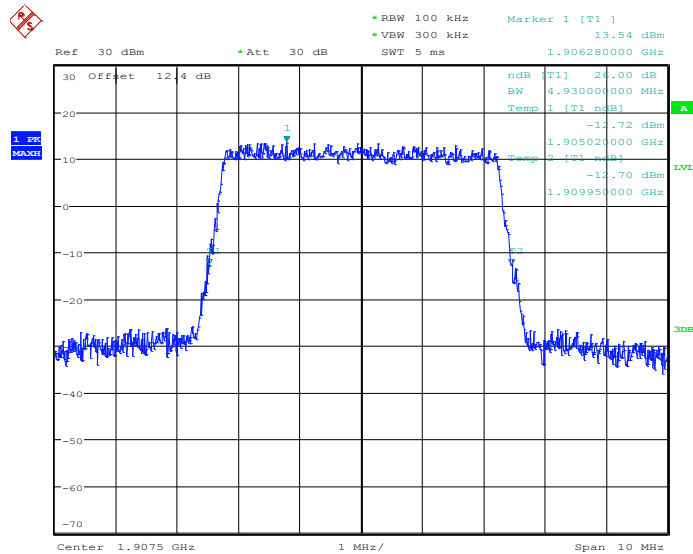

Date: 9.MAY.2014 15:52:21



Band :	LTE Band 2	BW / Mod. :	5MHz / 16QAM
--------	------------	-------------	--------------

99% Occupied Bandwidth Plot on Channel 18625

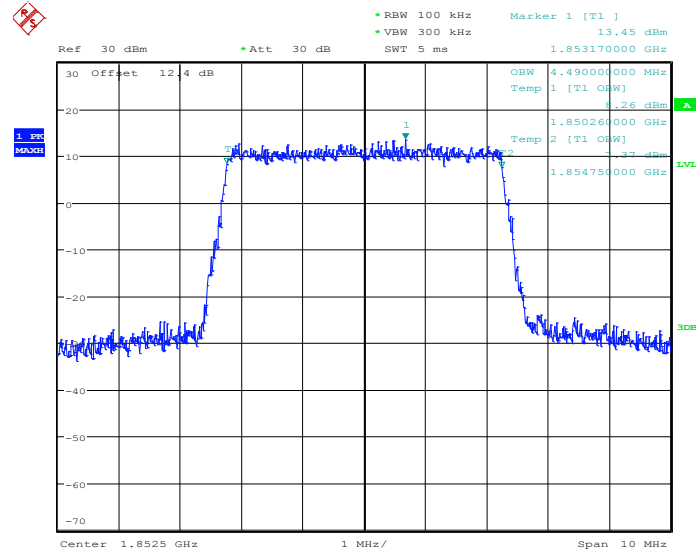

Date: 9.MAY.2014 15:42:36

26dB Bandwidth Plot on Channel 18625

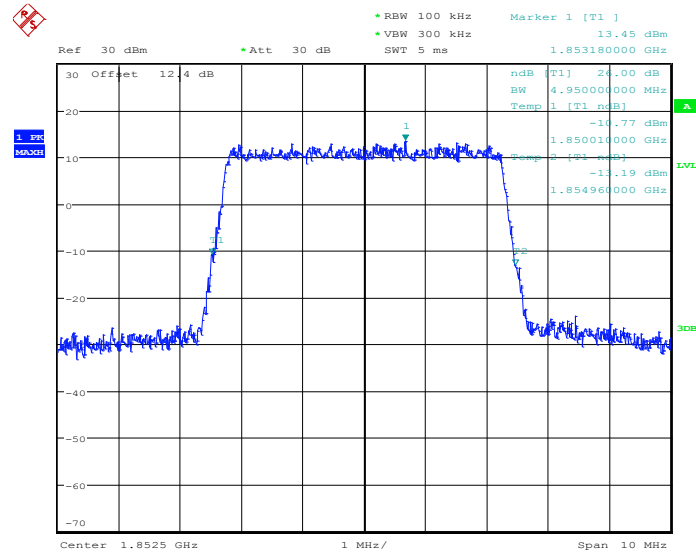

Date: 9.MAY.2014 15:43:12



99% Occupied Bandwidth Plot on Channel 18900

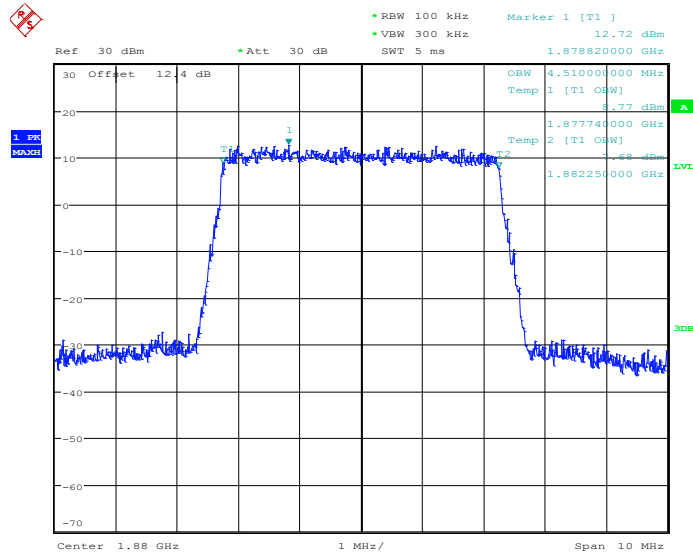

Date: 9.MAY.2014 15:48:55

26dB Bandwidth Plot on Channel 18900

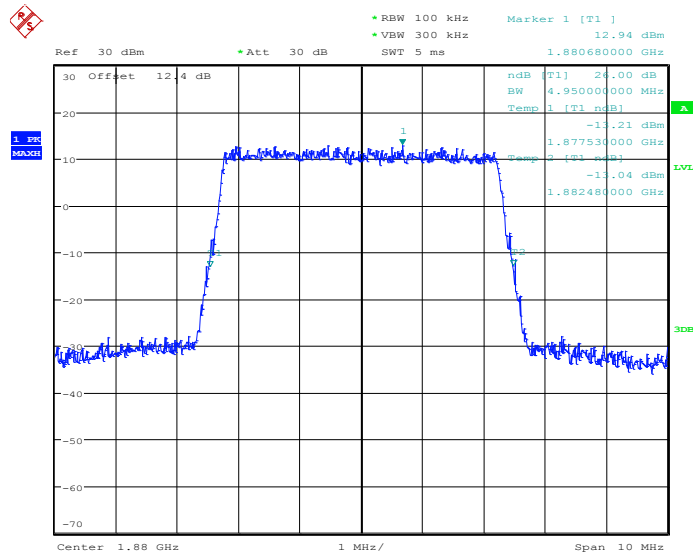

Date: 9.MAY.2014 15:49:30



99% Occupied Bandwidth Plot on Channel 19175

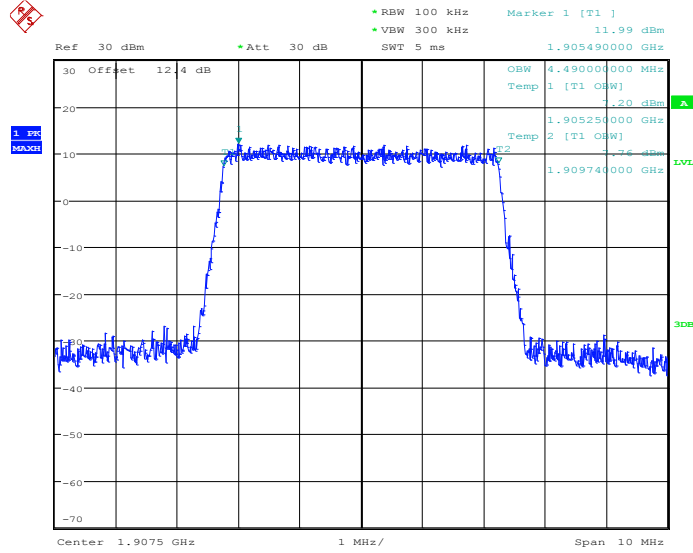

Date: 9.MAY.2014 15:52:03

26dB Bandwidth Plot on Channel 19175

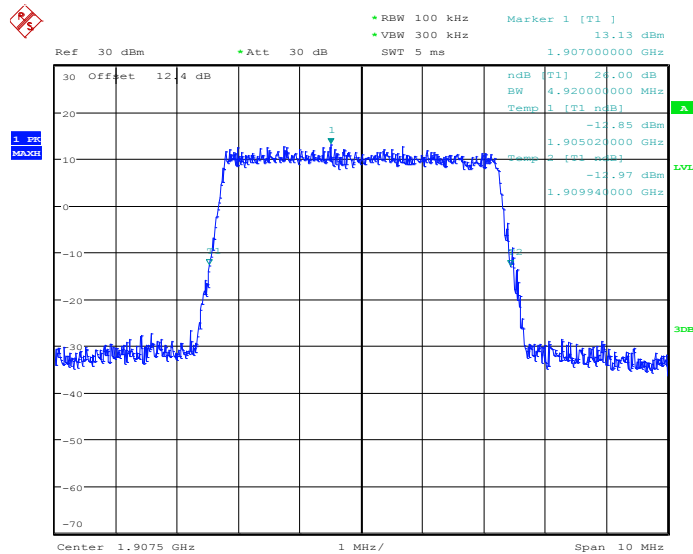

Date: 9.MAY.2014 15:52:39



<b>Band :</b>	LTE Band 2	<b>BW / Mod. :</b>	10MHz / QPSK
---------------	------------	--------------------	--------------

99% Occupied Bandwidth Plot on Channel 18650

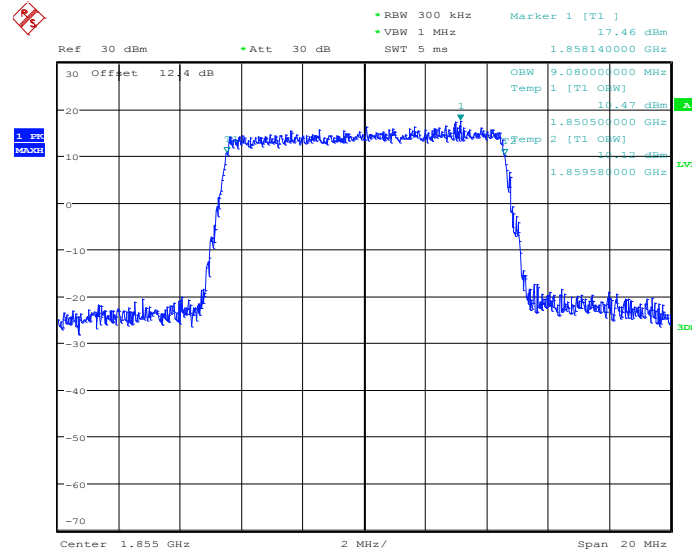

Date: 9.MAY.2014 15:58:05

26dB Bandwidth Plot on Channel 18650

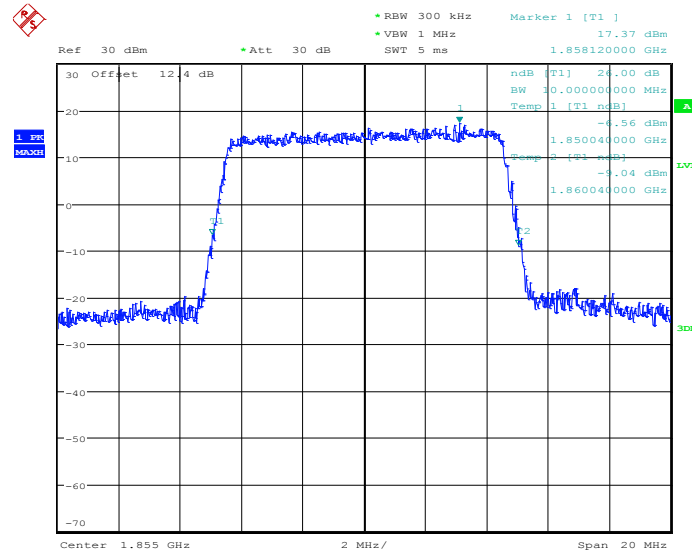

Date: 9.MAY.2014 15:58:39





99% Occupied Bandwidth Plot on Channel 18900

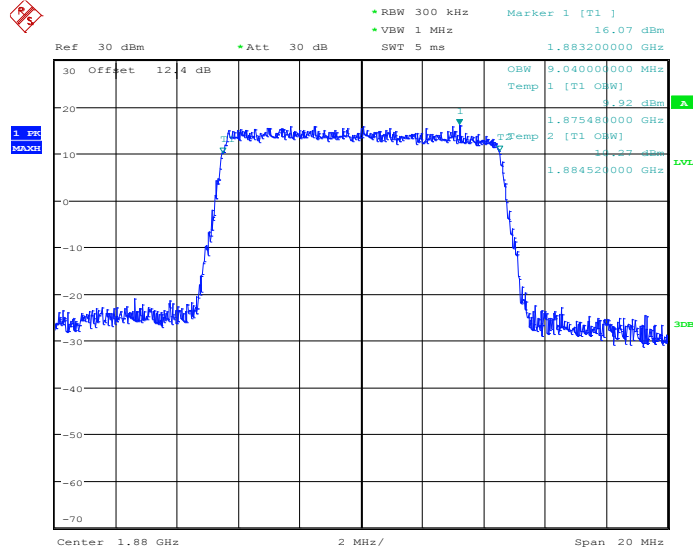

Date: 9.MAY.2014 16:04:23

26dB Bandwidth Plot on Channel 18900

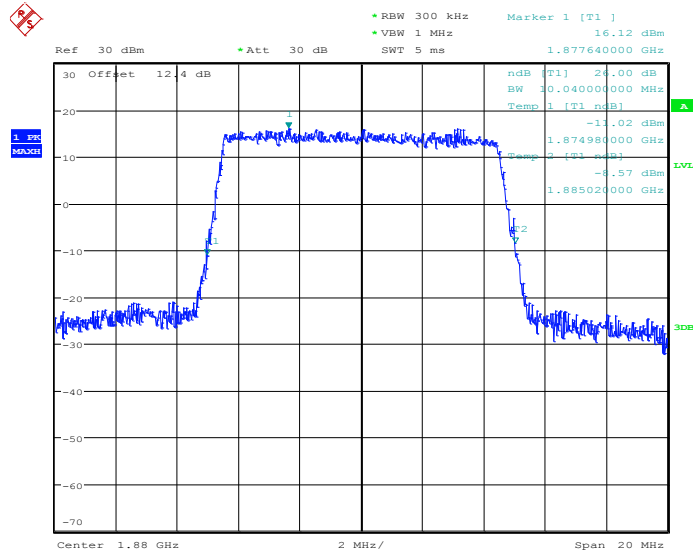

Date: 9.MAY.2014 16:04:57



99% Occupied Bandwidth Plot on Channel 19150

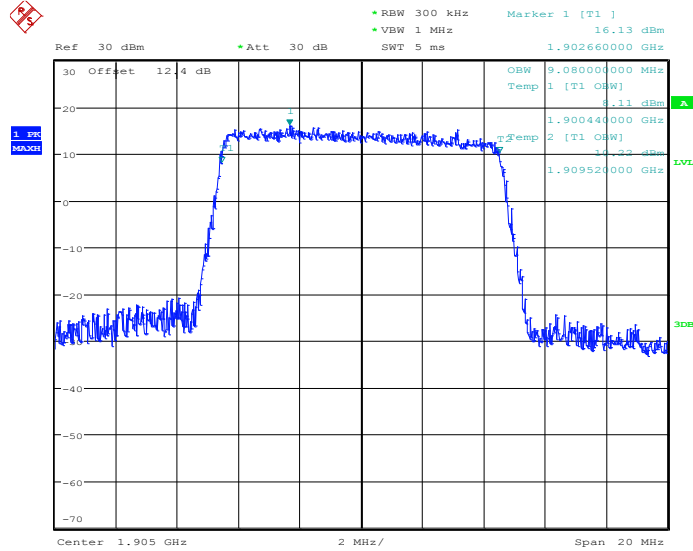

Date: 9.MAY.2014 16:07:32

26dB Bandwidth Plot on Channel 19150

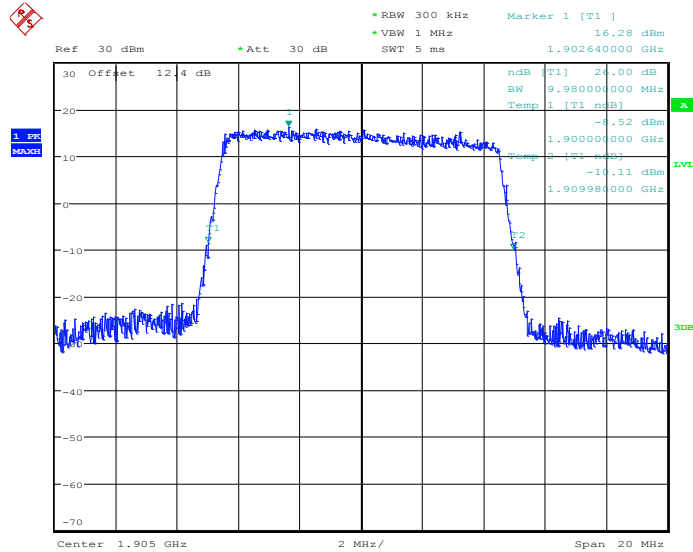

Date: 9.MAY.2014 16:08:05



Band :	LTE Band 2	BW / Mod. :	10MHz / 16QAM
--------	------------	-------------	---------------

99% Occupied Bandwidth Plot on Channel 18650

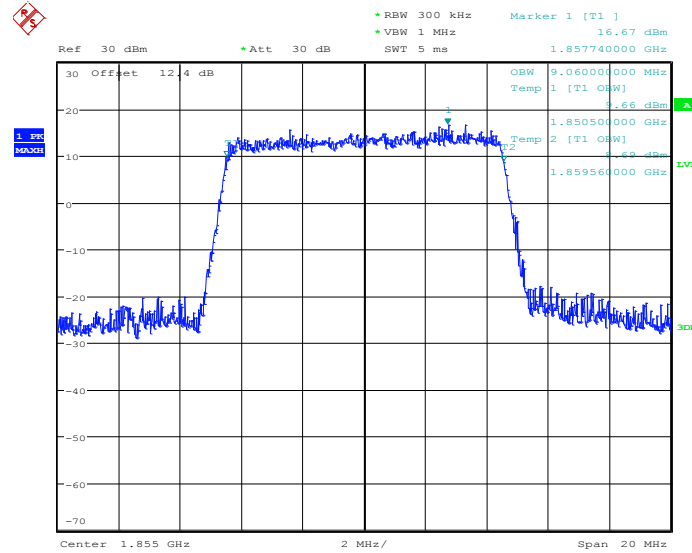

Date: 9.MAY.2014 15:58:21

26dB Bandwidth Plot on Channel 18650

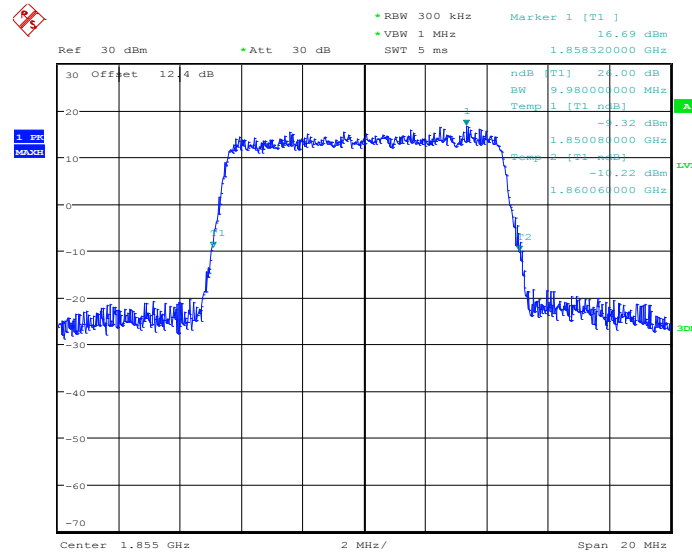

Date: 9.MAY.2014 15:58:57



### 99% Occupied Bandwidth Plot on Channel 18900

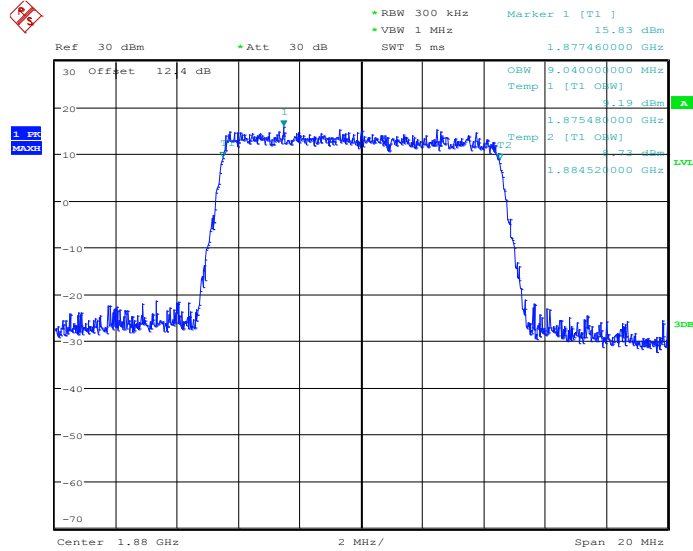

Date: 9.MAY.2014 16:04:39

### 26dB Bandwidth Plot on Channel 18900

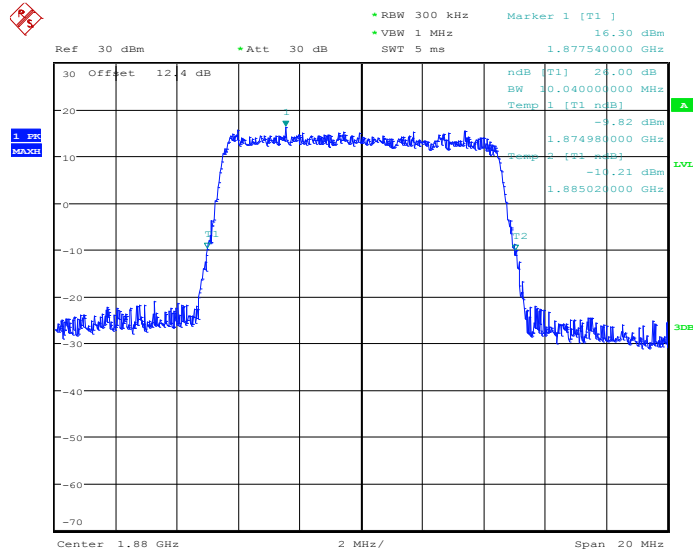

Date: 9.MAY.2014 16:05:15



### 99% Occupied Bandwidth Plot on Channel 19150

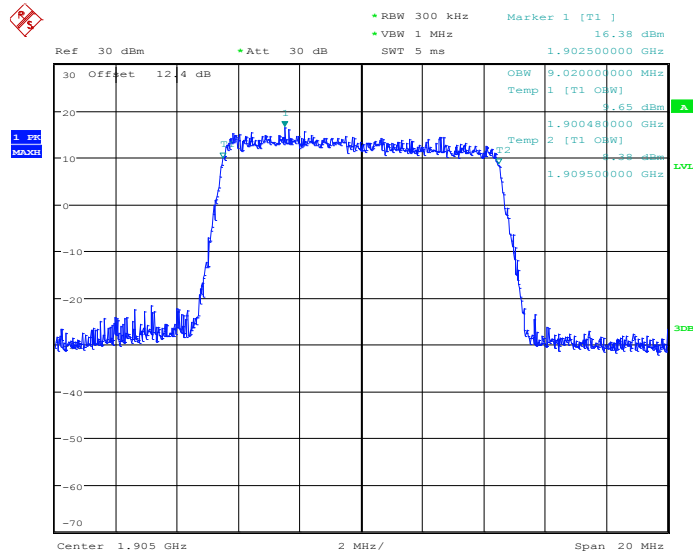

Date: 9.MAY.2014 16:07:48

### 26dB Bandwidth Plot on Channel 19150

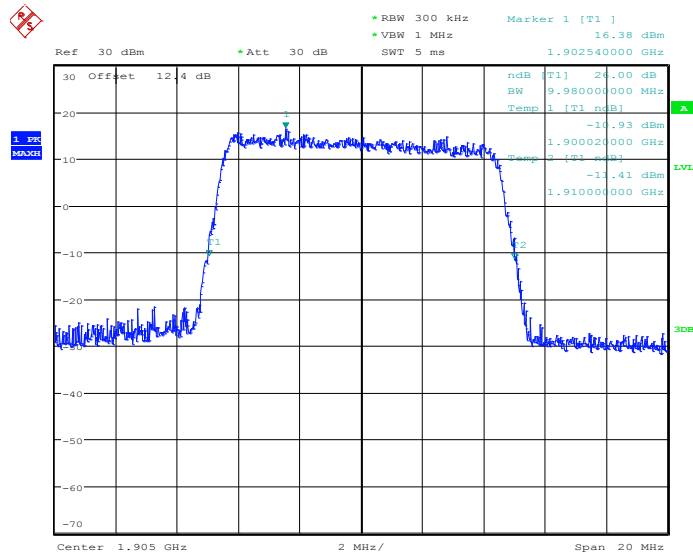

Date: 9.MAY.2014 16:08:23



<b>Band :</b>	LTE Band 2	<b>BW / Mod. :</b>	15MHz / QPSK
---------------	------------	--------------------	--------------

99% Occupied Bandwidth Plot on Channel 18675

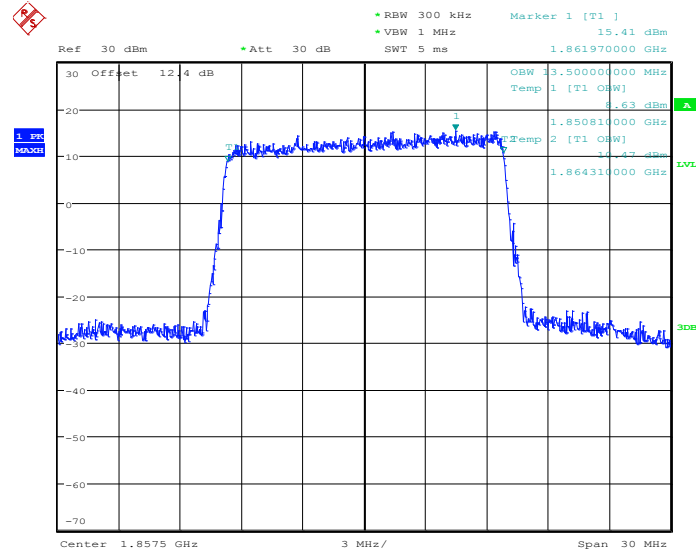

Date: 9.MAY.2014 16:13:50

26dB Bandwidth Plot on Channel 18675

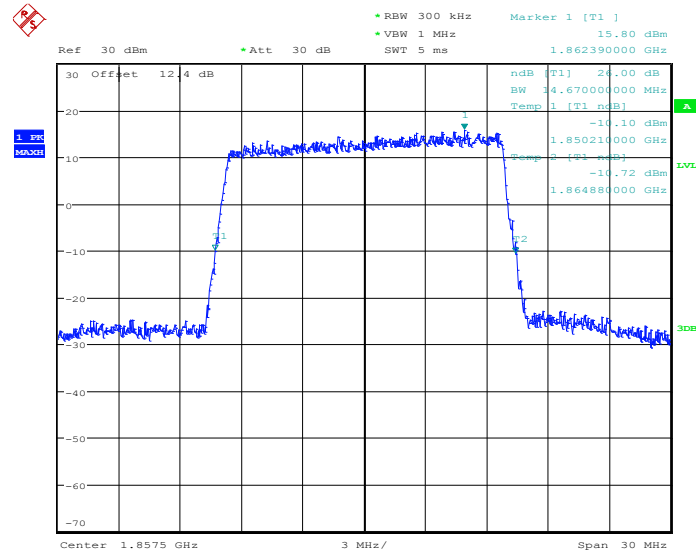

Date: 9.MAY.2014 16:14:23



### 99% Occupied Bandwidth Plot on Channel 18900

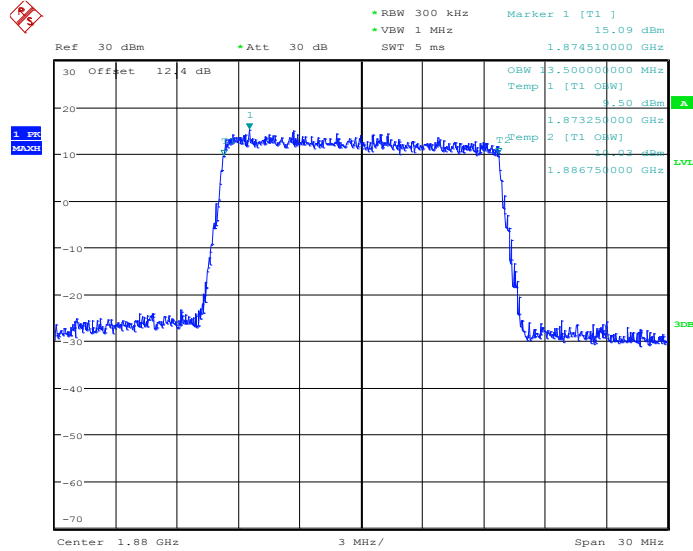

Date: 9.MAY.2014 16:20:08

### 26dB Bandwidth Plot on Channel 18900

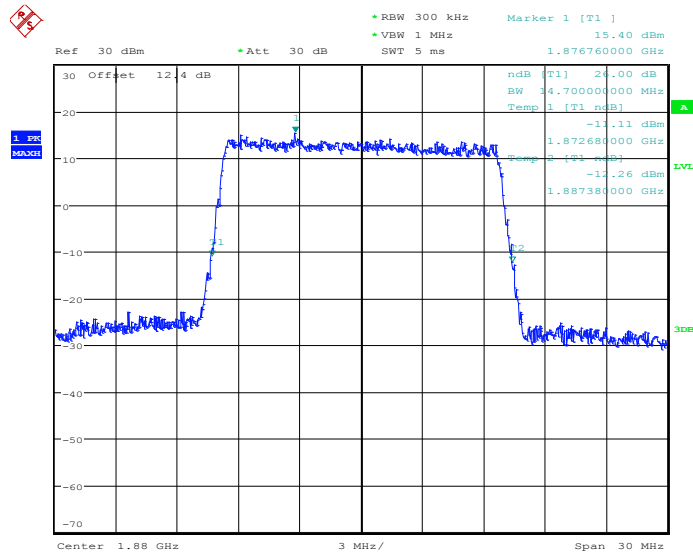

Date: 9.MAY.2014 16:20:42



### 99% Occupied Bandwidth Plot on Channel 19125

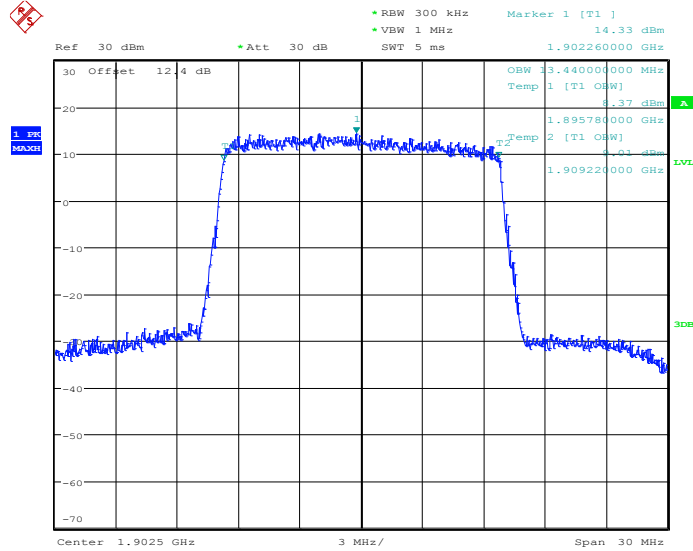

Date: 9.MAY.2014 16:23:17

### 26dB Bandwidth Plot on Channel 19125

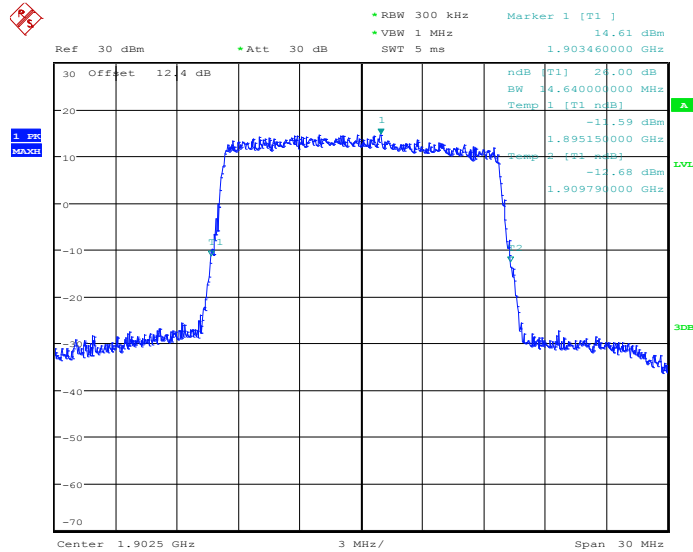

Date: 9.MAY.2014 16:23:51





Band :	LTE Band 2	BW / Mod. :	15MHz / 16QAM
--------	------------	-------------	---------------

99% Occupied Bandwidth Plot on Channel 18675

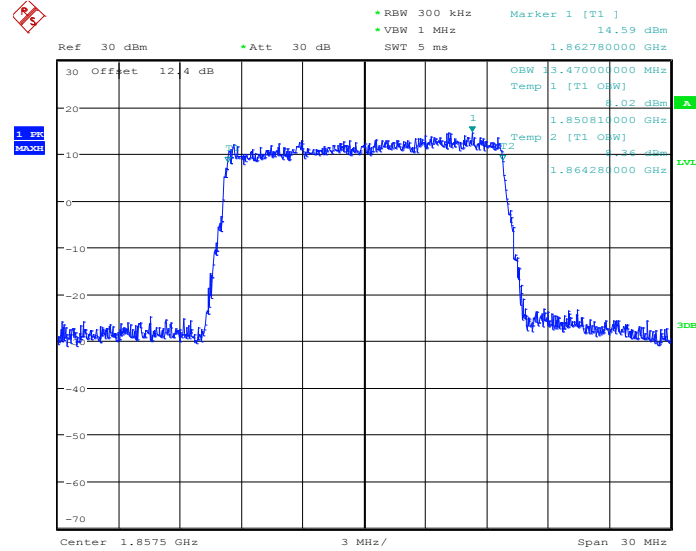

Date: 9.MAY.2014 16:14:06

26dB Bandwidth Plot on Channel 18675

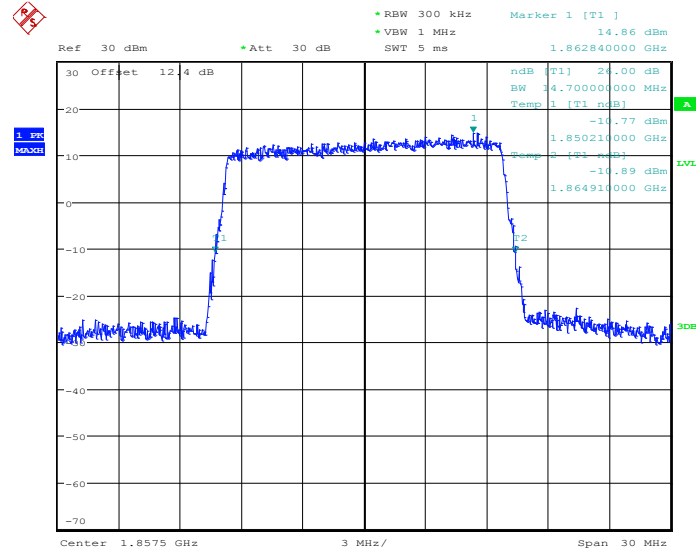

Date: 9.MAY.2014 16:14:41



### 99% Occupied Bandwidth Plot on Channel 18900

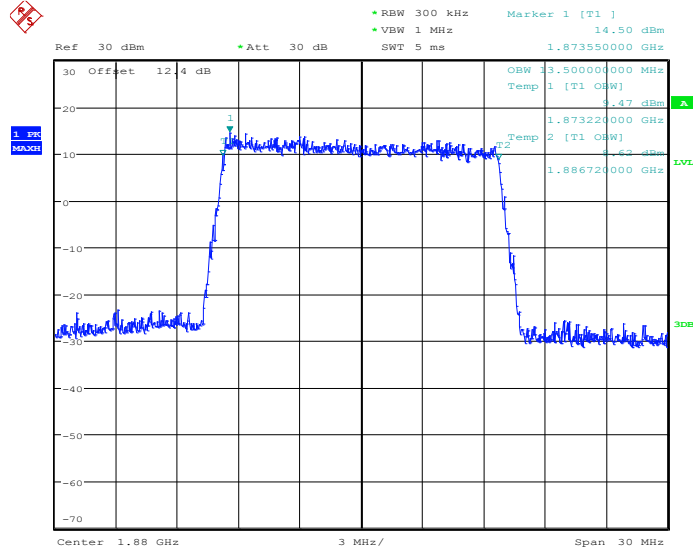

Date: 9.MAY.2014 16:20:24

### 26dB Bandwidth Plot on Channel 18900

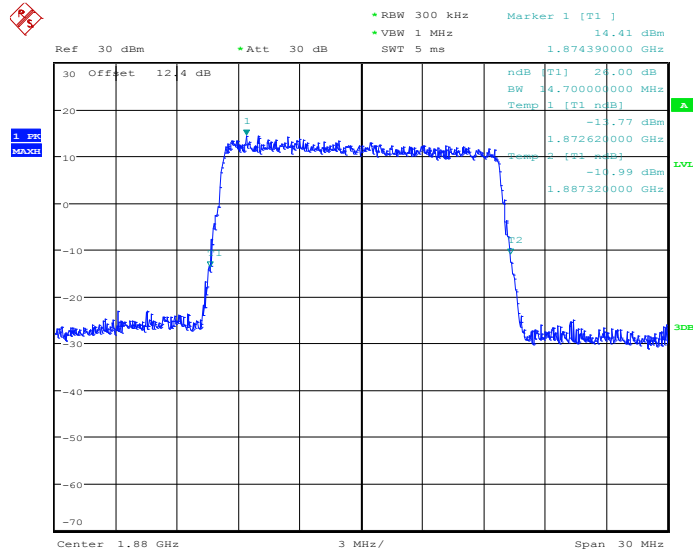

Date: 9.MAY.2014 16:21:00



### 99% Occupied Bandwidth Plot on Channel 19125

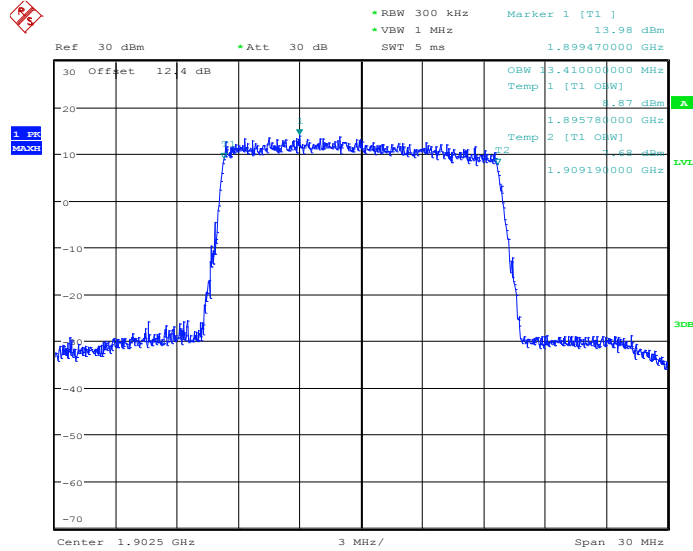

Date: 9.MAY.2014 16:23:33

### 26dB Bandwidth Plot on Channel 19125

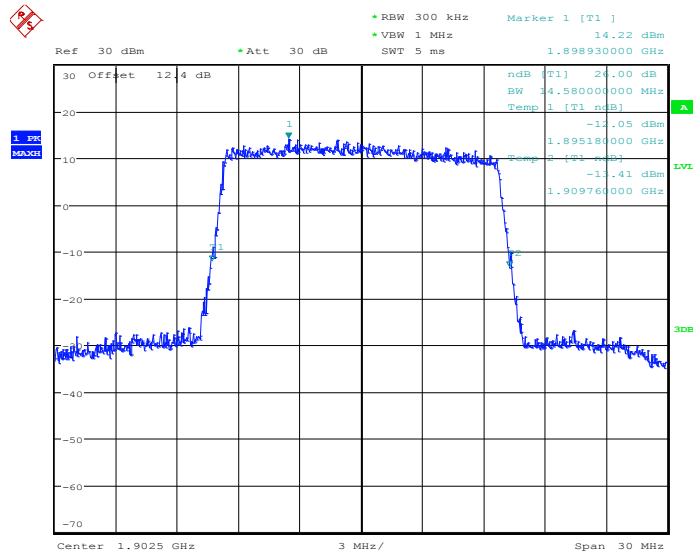

Date: 9.MAY.2014 16:24:09



<b>Band :</b>	LTE Band 2	<b>BW / Mod. :</b>	20MHz / QPSK
---------------	------------	--------------------	--------------

99% Occupied Bandwidth Plot on Channel 18700

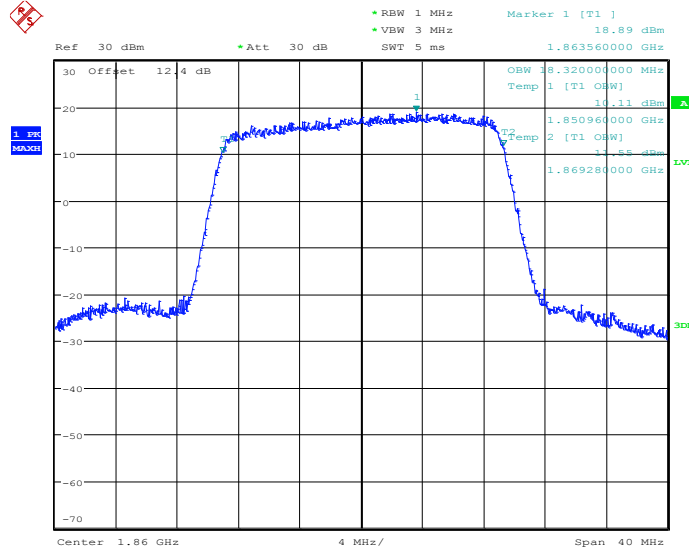

Date: 9.MAY.2014 16:29:36

26dB Bandwidth Plot on Channel 18700

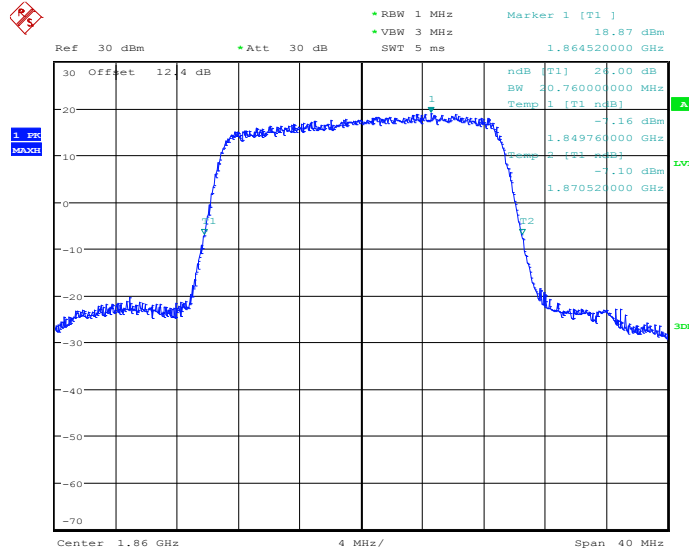

Date: 9.MAY.2014 16:30:10



### 99% Occupied Bandwidth Plot on Channel 18900

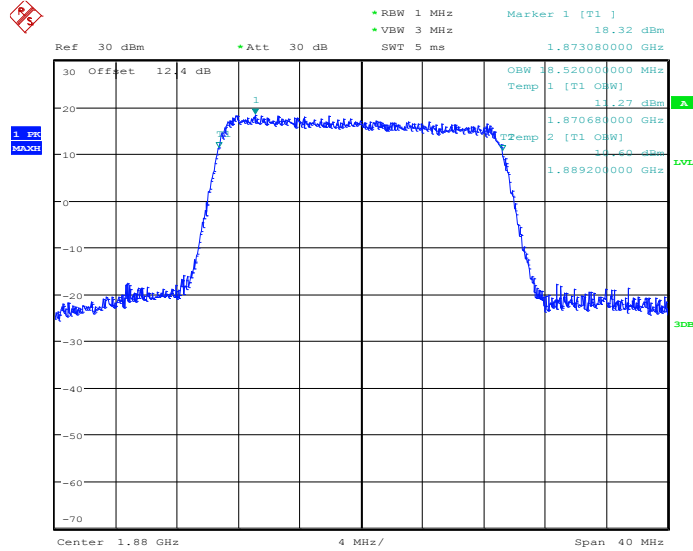

Date: 9.MAY.2014 16:35:53

### 26dB Bandwidth Plot on Channel 18900

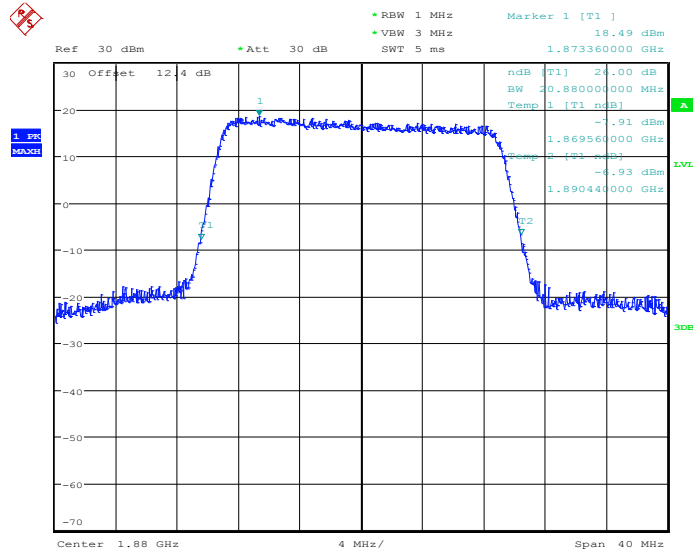

Date: 9.MAY.2014 16:36:27