



MOTOROLA

HAC Test Report for Near Field Emissions IHDT56KB1

Date of test: Jan-20-2009 to Jan-27-2009
Date of Report: Jan-30-2009

Laboratory: Motorola Mobile Devices Business Product Safety & Compliance Laboratory
600 N. US Highway 45
Room: MW113
Libertyville, Illinois 60048

Test Responsible: Thomas Knipple
Senior RF Engineer

Statement of Compliance: Motorola declares under its sole responsibility that portable cellular telephone FCC IHDT56KB1 to which this declaration relates, complies with recommendations and guidelines FCC 47 CFR §20.19. The measurements were performed to ensure compliance to the ANSI C63.19-2007. It also declares that the product was tested in accordance with the appropriate measurement standards, guidelines and recommended practices. Any deviations from these standards, guidelines and recommended practices are noted below:

(none)

Results Summary: M Category = M3

©Motorola, Inc. 2009

This test report shall not be reproduced except in full, without written approval of the laboratory.

The results and statements contained herein relate only to the items tested. The names of individuals involved may be mentioned only in connection with the statements or results from this report.

Motorola encourages all feedback, both positive and negative, on this test report.

Table of Contents

1. INTRODUCTION	3
2. DESCRIPTION OF THE DEVICE UNDER TEST.....	3
3. TEST EQUIPMENT USED.....	4
4. VALIDATION	5
5. PROBE MODULATION FACTOR	6
6. TEST RESULTS.....	8
APPENDIX 1: DETAILS JUSTIFYING THE CONVERSION TO PEAK	11
A1.1 Procedure for PMF measurements.....	12
A1.2 0-Span Spectrum Plots for PMF measurements.....	13
APPENDIX 2: HAC DISTRIBUTION PLOTS FOR VALIDATION	15
APPENDIX 3: HAC DISTRIBUTION PLOTS FOR E-FIELD AND H-FIELD	16
APPENDIX 4: MOTOROLA UNCERTAINTY BUDGET	17
A4.1 Motorola Uncertainty Budget for RF HAC Testing	18
A4.2 Probe Rotation Contributions to Isotropy Error	19
APPENDIX 5: PICTURES OF TEST SETUP	20
APPENDIX 6: PROBE CALIBRATION CERTIFICATES.....	21
APPENDIX 7: DIPOLE CHARACTERIZATION CERTIFICATE	22

1. Introduction

The Motorola Mobile Devices Business Product Safety Laboratory has performed Hearing Aid Compatibility (HAC) measurements for the portable cellular phone (FCC ID IHDT56KB1). The portable cellular phone was tested in accordance with ANSI PC63.19-2007 standard. The test results presented herein clearly demonstrate compliance FCC 47 CFR § 20.19. This report demonstrates compliance for near field emissions only and not for Telecoil HAC performance compliance.

2. Description of the Device Under Test

Table 1: Information for the Device Under Test

Serial number	364VJYJS39	
Mode(s) of Operation	800 iDEN	900 iDEN
Modulation Mode(s)	QAM	QAM
Maximum Output Power Setting	28.06 dBm	28.06 dBm
Duty Cycle	1:6/2:6	1:6/2:6
Transmitting Frequency Range(s)	806.0125 – 824.9875 MHz	896.01875 – 900.98125 MHz
Production Unit or Identical Prototype (47 CFR §2.908)	Identical Prototype	
Device Category	Portable	

3. Test Equipment Used

The Motorola Mobile Devices Business Product Safety & Compliance Laboratory utilizes a Dosimetric Assessment System (Dasy4™ v4.7) manufactured by Schmid & Partner Engineering AG (SPEAG™), of Zurich Switzerland. All the HAC measurements are taken within a shielded enclosure. The measurement uncertainty budget is given in Appendix 4. The list of calibrated equipment used for the measurements is shown below.

Table 2: Dosimetric System Equipment

Description	Serial Number	Cal Due Date
E-Field Probe ER3DV6R	2244	Sep-22-2009
H-Field Probe H3DV6	6078	Sep-22-2009
DAE3	703	Sep-19-2009
DAE3	639	Sep-22-2009
835/898 MHz Dipole CD835V3	1076	Mar-11-2010

Table 3: Additional Test Equipment

Description	Serial Number	Cal Due Date
Power Supply 6632B	US37360829	Sep-06-2009
Signal Generator E4438C	MY45090104	Sep-12-2009
Amplifier ZHL-42-SMA	1040	
3db Attenuator 8491A	50581	Sep-04-2009
Directional Coupler 778D	18621	Sep-05-2009
Power Meter E4417A	MY45100140	Dec-24-2009
Power Sensor #1 – E9323A	US40412053	Sep-04-2009
Power Sensor #2 - E9323A	US40412063	Sep-04-2009
10db attenuator 8491A	3929M50702	Oct-17-2009
Spectrum Analyzer E4403B	US39440471	Dec-09-2009

4. Validation

Validations of the DASY4 v4.7 test system were performed using the measurement equipment listed in Section 3.1. All validations occur in free space using the DASY4 test arch. Note that the 10 mm probe to dipole separation is measured from the top edge of the dipole to the calibration reference point of the probe. SPEAG uses the center point of the probe sensor(s) as the reference point when establishing targets for their dipoles. Therefore, because SPEAG’s dipoles and targets are used, it is appropriate to measure the 10 mm separation distance to the center of the sensors as they do. This reference point was used for validation only. Validations were performed at 835 MHz and 898 MHz. The results obtained from the validations are displayed in the table below. The field contour plots are included in Appendix 2.

Validations were performed to verify that measured E-field and H-field values are within ±25% from the target reference values provided by the manufacturer (Ref: Appendix 7). Per Section 4.3.2.1 of the C63.19 standard, “Values within ±25% are acceptable, of which 12% is deviation and 13% is measurement uncertainty.” Therefore, the E- and H-Field dipole verification results, shown in Table 4, are in accordance with the acceptable parameters defined by the standard.

Table 4: Dipole Measurement Summary

Date	Dipole	F (MHz)	Protocol	Input Power (mW)	E-Field Results (V/m)	Target for Dipole (V/m)	% Deviation
Jan-20-2009	1076	835	CW	100	162.1	159.0	+1.9
		898	CW	100	148.3	151.4	-2.0
Jan-27-2009		835	CW	100	158.95	159.0	-0.0
		898	CW	100	145.7	151.4	-3.8

	Dipole	F (MHz)	Protocol	Input Power (mW)	H-Field Results (A/m)	Target for Dipole (A/m)	% Deviation
Jan-20-2009	1076	835	CW	100	0.453	0.445	+1.8
		898	CW	100	0.414	0.416	-0.4
Jan-27-2009		835	CW	100	0.457	0.445	+2.7
		898	CW	100	0.422	0.416	+1.4

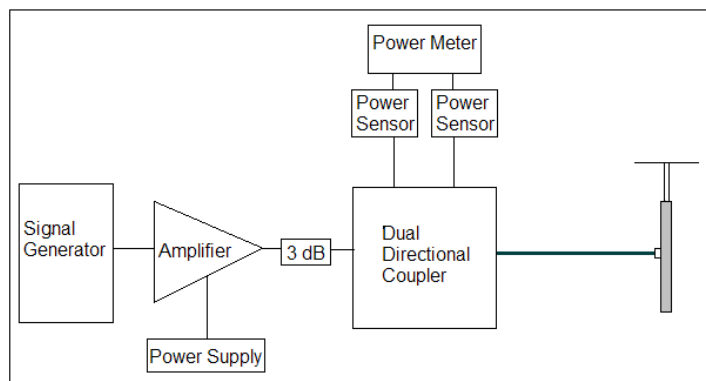

Figure 1: Setup for Validation

5. Probe Modulation Factor

After every probe calibration, the response of the probe to each applicable modulated signal (iDEN, etc) must be assessed at both 835 MHz and 898 MHz. The response of the probe system to a CW field at the frequency(s) of interest is compared to its response to a modulated signal with equal peak amplitude. For each PMF assessment, a Signal Generator was used to replace the original CW signal with the desired modulated signal. The PMF results applicable to this test document are shown in Tables 5.

RF Field Probe Modulation Response was measured with the field probe and associated measurement equipment. The PMF was measured using a signal generator as follows:

1. Illuminate a dipole with a CW signal at the intended measured frequency.
2. Fix the probe at a set location relative to the dipole; typically located at the field reference point.
3. Record the reading of the probe measurement system of the CW signal.
4. Substitute a modulated signal of the same amplitude, using the same modulation as that used by the intended WD for the CW signal.
5. Record the reading of the probe measurement system of the modulated signal.
6. The ratio of the CW to modulated signal reading is the probe modulation factor.

Using dual directional coupler, the forward power and reverse power are measured and adjusted when connected to the dipole.

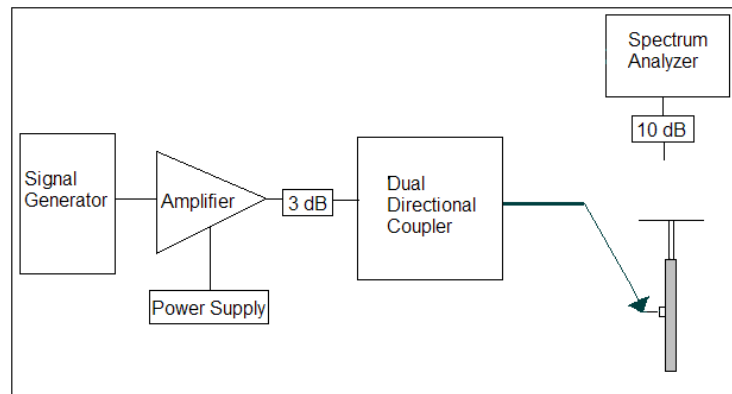

Figure 2a: Setup to Dipole

A spectrum analyzer is used to set the peak amplitude of the modulated signal equal to the amplitude of the CW signal. The procedure, used to ensure that the amplitude is the same, is shown in Appendix 1. The 0-span spectrum plots are also provided in Appendix 1.

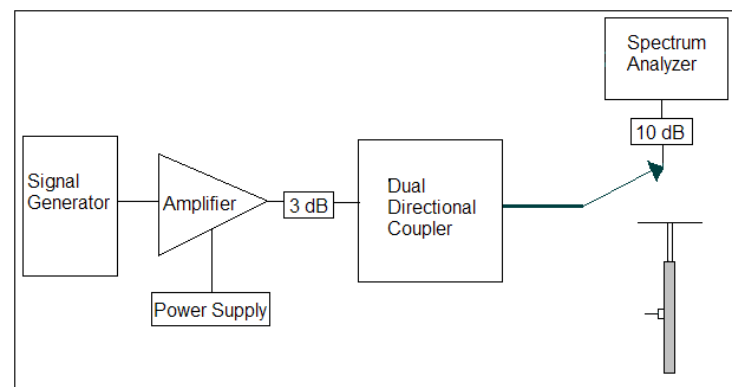

Figure 2b: Setup for Desired Peak Power using Spectrum Analyzer

When measuring PMFs, the signal is injected into the dipole. When peak power level produces the field strength less or around M3 limit, the peak power level is used. When peak power level produces the field strength much greater than M3 limit, the power level which gives the field strength around M3 limit is used.

Table 5: PMF Measurement Summary

f (MHz)	Protocol	E-Field Probe SN 2244		H-Field Probe SN 6078	
		E-Field (V/m)	E-Field Modulation Factor	H-Field (A/m)	H-Field Modulation Factor
813	CW	288.6		1.086	
	IDEN (2:6 Rate)	80.17	3.60	0.3418	3.18
	IDEN (1:6 Rate)	57.11	5.05	0.2458	4.42
898	CW	215.1		1.044	
	IDEN (2:6 Rate)	63.26	3.40	0.3309	3.16
	IDEN (1:6 Rate)	44.30	4.86	0.2341	4.46

f (MHz)	Protocol	E-Field Probe SN 2244		H-Field Probe SN 6078	
		E-Field (V/m)	E-Field Modulation Factor	H-Field (A/m)	H-Field Modulation Factor
813	CW	108.1		0.5050	
	80% AM	66.37	1.63	0.3244	1.56
898	CW	85.69		0.4184	
	80% AM	52.39	1.64	0.2616	1.60

6. Test Results

The phone was tested in normal configurations for the ear use. When applicable, configurations are tested with the antenna in its fully extended position. These test configurations are tested at the high, middle and low frequency channels of each applicable operating mode; for example, GSM, CDMA, and TDMA.

The test sample is capable of operation in a test mode that allows control of the transmitter without the need to place actual phone calls. This guarantees that the unit does not change its transmitter power, and that the resultant HAC field values will not be affected by external connections. For the purposes of this testing the unit is commanded to test mode and manually set to the proper channel, transmitter power level and transmit mode of operation. The phone is then placed in the HAC measurement system with a fully charged battery. At the end of each test the DASY™ system measures the drift of the field strength at a fixed reference point to ensure that the test sample has not changed in transmitter power. For the purposes of these tests, the transmitter was operated at the highest output level available.

The Cellular Phone model covered by this report has the following battery options:

Battery #1 – SNN5792A – 1100 mAH Battery

Battery #2 – SNN5795A – 930 mAH Battery

Battery #3 – SNN5793A – 1750 mAH Battery

Battery #3 – SNN5754A – 1480 mAH Battery

Battery #1 was tested in all configurations. The phone was placed in the measurement system with a fully charged battery. The configurations that resulted in the highest field-strength values per band, vocoder, and field type were tested using the other batteries listed above.

The DASY4 v4.7 measurement system specified in section 3.1 was utilized within the intended operations as set by the SPEAG™ setup. The default settings for the grid spacing of the scan were set to 5 mm as shown in the Field plots included in Appendix 2 and 3. The 5 cm x 5 cm area measurement grid is centered on the acoustic output of the device. The Test Arch provided by SPEAG is used to position the DUT. The pictures of the setup are included in Appendix 5. The WD reference plane is parallel to the device and contains the highest point on its contour in the area of the phone that normally rests against the user's ear. The measurement plane contains the center point of the probe sensor(s). The device is positioned such that the WD reference plane is located 15 mm from, and parallel to, the measurement plane. This is in accordance with section 4.4 of the standard, which states that "The WD reference plane is a plane parallel with the front "face" of the WD and containing the highest point on its contour in the area of the phone that normally rests against the user's ear."

The HAC Rating results for E-Field and H-field are shown in Tables 6 through 9. Also shown are the measured conducted output powers, the measured drifts, excluded areas, and the peak fields. PMF measurements are taken from Section 5. The worst-case test conditions are indicated with **bold numbers** in the tables and are detailed in Appendix 3: HAC distribution plots for E-Field and H-Field.

Drift was measured using the typical DASY4 v4.7 measurement routines. The field is measured at the reference location (center of the ear piece) at the beginning of the test. Then after completion of the E or H field measurement, the probe returns to the same reference location and takes another measurement. The drift is the delta between these two values and is included in the test report scans.

Per SPEAG's recommendation, the phone plots in Appendix 3 use the iDEN transmitter ratios of 2:6 and 1:6 as "Duty Cycle." Per SPEAG's recommendation, in order to account for probe modulation response, PMF is applied during the SEMCAD (post-processing) portion. PMF also appears in the phone plots in Appendix 3.

iDEN 800/900 Emissions Limits	
Rating	E-Field
M3	199.5 – 354.8 V/m
M4	< 199.5 V/m

Table 6: HAC E-Field measurement results for the portable cellular telephone at highest possible output power (2:6 Rate)

Frequency Band (MHz)	Frequency Setting	Conducted Output Power (dBm)	Measured PMF	Drift (dB)	Excluded Cells	Peak Field (V/m)	Rating	
iDEN 800 MHz	806.0125	28.06	3.60	0.069	7,8,9	284.2	M3	
	813.5125	28.05		-0.044	8,9	249.9	M3	
	824.9875	28.06		0.011	8,9	224.8	M3	
	with Battery 2				-0.006	7,8,9	284.3	M3
	with Battery 3				0.048	7,8,9	259.1	M3
	with Battery 4				-0.037	8,9	210.0	M3
iDEN 900 MHz	896.01875	28.03	3.40	-0.206	8,9	173.9	M4	
	900.98125	28.04		-0.025	8,9	160.2	M4	
	with Battery 2				-0.003	8,9	170.8	M4
	with Battery 3				-0.081	8,9	179.8	M4
	with Battery 4				-0.061	8,9	181.2	M4

Table 7: HAC E-Field measurement results for the portable cellular telephone at highest possible output power (1:6 Rate)

Frequency Band (MHz)	Frequency Setting	Conducted Output Power (dBm)	Measured PMF	Drift (dB)	Excluded Cells	Peak Field (V/m)	Rating	
iDEN 800 MHz	806.0125	28.06	5.05	-0.021	7,8,9	284.7	M3	
	813.5125	28.05		-0.107	8,9	244.7	M3	
	824.9875	28.06		0.048	8,9	221.4	M3	
	with Battery 2				-0.077	7,8,9	280.9	M3
	with Battery 3				0.012	7,8,9	254.8	M3
	with Battery 4				-0.044	8,9	209.2	M3
iDEN 900 MHz	896.01875	28.03	4.86	-0.210	8,9	168.3	M4	
	900.98125	28.04		0.046	8,9	166.4	M4	
	with Battery 2				0.063	8,9	173.5	M4
	with Battery 3				-0.074	8,9	182.7	M4
	with Battery 4				0.014	8,9	188.0	M4

iDEN 800/900 Emissions Limits	
Rating	H-Field
M3	0.60 – 1.07 A/m
M4	< 0.60 A/m

Table 8: HAC H-Field measurement results for the portable cellular telephone at highest possible output power (2:6 Rate)

Frequency Band (MHz)	Frequency Setting	Conducted Output Power (dBm)	Measured PMF	Drift (dB)	Excluded Cells	Peak Field (A/m)	Rating
iDEN 800 MHz	806.0125	28.06	3.18	0.069	1,4,7	0.325	M4
	813.5125	28.05		0.058	1,4,7	0.393	M4
	824.9875	28.06		0.056	1,4,7	0.442	M4
	with Battery 2			0.005	1,4,7	0.451	M4
	with Battery 3			-0.021	1,4,7	0.468	M4
	with Battery 4			0.044	1,4,7	0.476	M4
iDEN 900 MHz	896.01875	28.03	3.16	-0.030	1,4,7	0.362	M4
	900.98125	28.04		0.032	1,4,7	0.338	M4
	with Battery 2			-0.025	1,4,7	0.366	M4
	with Battery 3			0.006	1,4,7	0.441	M4
	with Battery 4			-0.014	1,4,7	0.427	M4

Table 9: HAC H-Field measurement results for the portable cellular telephone at highest possible output power (1:6 Rate)

Frequency Band (MHz)	Frequency Setting	Conducted Output Power (dBm)	Measured PMF	Drift (dB)	Excluded Cells	Peak Field (A/m)	Rating
iDEN 800 MHz	806.0125	28.06	4.42	-0.003	1,4,7	0.317	M4
	813.5125	28.05		0.019	1,4,7	0.386	M4
	824.9875	28.06		0.080	1,4,7	0.453	M4
	with Battery 2			0.126	1,4,7	0.443	M4
	with Battery 3			-0.126	1,4,7	0.461	M4
	with Battery 4			0.041	1,4,7	0.469	M4
iDEN 900 MHz	896.01875	28.03	4.46	-0.066	1,4,7	0.374	M4
	900.98125	28.04		-0.045	1,4,7	0.349	M4
	with Battery 2			0.100	1,4,7	0.373	M4
	with Battery 3			0.038	1,4,7	0.455	M4
	with Battery 4			0.007	1,4,7	0.416	M4

Appendix 1

Details justifying the conversion to peak

A1.1 Procedure for PMF measurements

1. Setup the HAC validation rack as you would for a normal CW HAC validation with forward power = 100 mW
2. Setup the dipole and phantom as you would for a normal CW HAC validation.
3. Open the "HAC Probe Mod Factor" template and verify the following parameters:
Medium = "Air";
Communication System = "HAC – Dipole";
Ensure the proper probe & DAE are installed and laser aligned
4. **MEASURE CW:** Using the original CW signal, run the jobs in the "CW Measurement" procedure.
5. Do **not** turn off the signal generator power
6. **Setting the CW Reference Level on the Spectrum Analyzer:** To set the Reference level on the Spectrum Analyzer, remove the Validation Rack's Main Cable from the dipole and connect to the Spectrum Analyzer INPUT using a 10 dB attenuator and an adapter.
7. Set-Up the Spectrum Analyzer for the following Settings:
Frequency: Freq. being tested (EX: 835/1880)
Span: Zero Span
Res BW: iDEN – 100 kHz; GSM – 300 kHz; CDMA – 3 MHz; WCDMA – 5 MHz;
Video BW: iDEN – 300 kHz; GSM – 1MHz; CDMA and WCDMA – 30 kHz*;
Sweep Time: 20 ms; 120 ms for iDEN
Scale: 1dB
Detector: PEAK / Manual
8. Adjust REF level until the CW signal is aligned with the Center Line (approx. 15 dB). NOTE: After this point, the Reference Line must remain fixed. Do not change it.
9. **MEASURE THE MODULATED SIGNAL(S):**
 - 9.1. Change the signal generator to the desired modulation.
 - 9.2. Set the Spectrum Analyzer Sweep Time to 20ms.
 - 9.3. With the Main cable still connected to the Spectrum Analyzer, adjust the amplitude of the power on the signal generator so that the PEAK of the modulated signal is at the CW Reference Line:
 - 9.3.1 On the Spectrum Analyzer, press the [View Trace] button and then select (Max Hold), this will show only the Peak output.
 - 9.3.2 Press (Clear Write) and then (Max Hold) each time an amplitude adjustment is made.
 - 9.4. Allow the Max Hold line to stabilize. Then check that the highest peak of the Max Hold line corresponds with the CW Reference Line (without going over). If not correct, repeat section 6.
 - 9.5. Remove the validation main cable from the spectrum analyzer and re-connect it to the Dipole.
10. Repeat 9 until all remaining modulation(s) have been completed.

*The use of 30 kHz VBW is validated. The power measurements are verified using an average power meter.

A1.2 0-span Spectrum Plots for PMF measurements

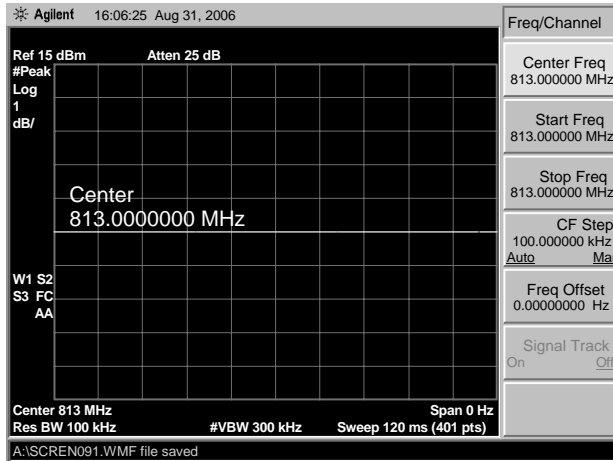

CW 813 MHz

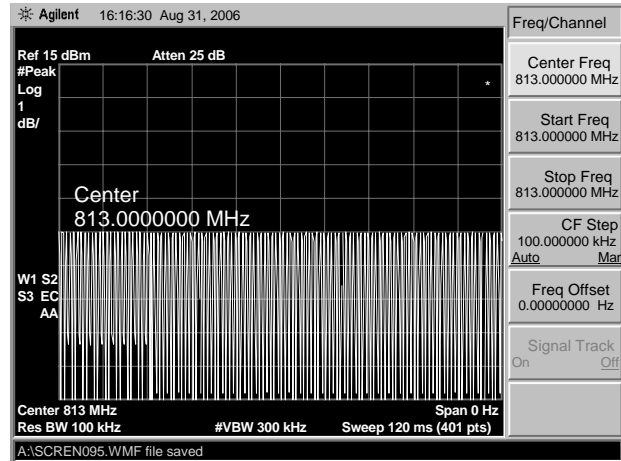

80% AM 813 MHz

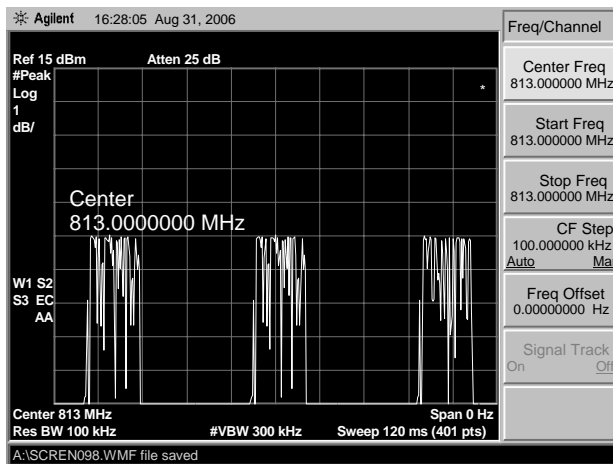

iDEN 813 MHz (2:6 rate)

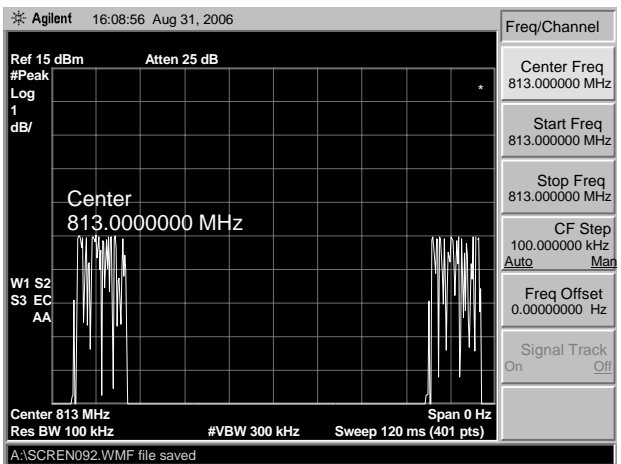

iDEN 813 MHz (1:6 rate)

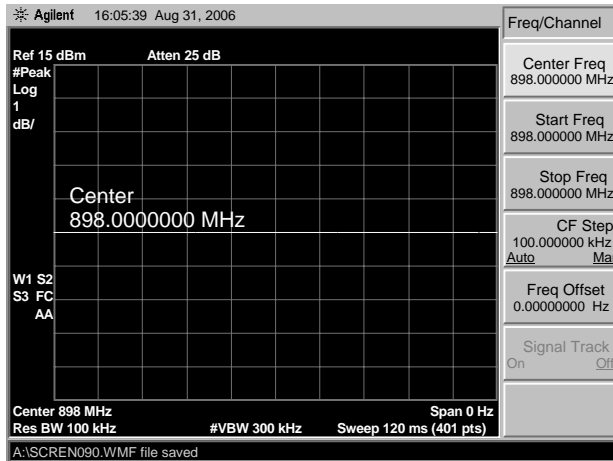

CW 898 MHz

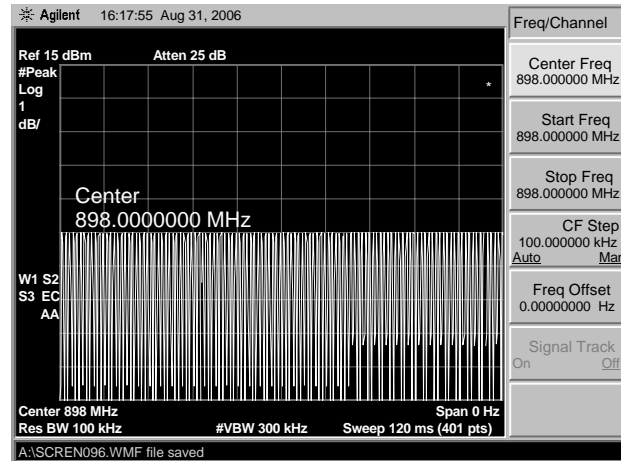

80% AM 898 MHz

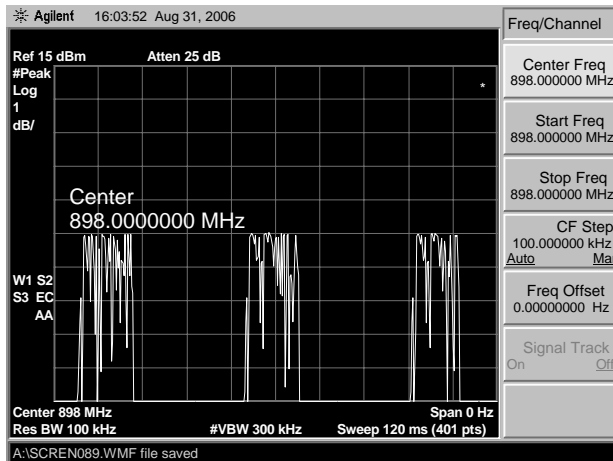

iDEN 898 MHz (2:6 rate)

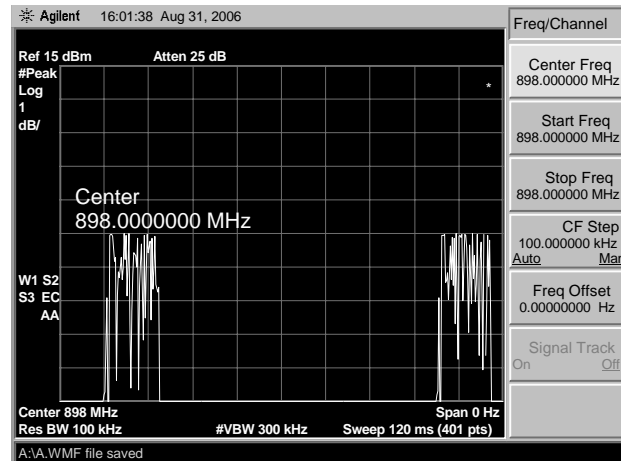

iDEN 898 MHz (1:6 rate)

Appendix 2

HAC distribution plots for Validation

Date/Time: 1/20/2009 6:57:31 AM

Test Laboratory: Motorola - 012009, E - 835 CW +1.9% GOOD

DUT: HAC-Dipole 835 MHz; Type: CD835V3; Serial: 1076; FCC ID: IHDT56KB1

Procedure Notes: 835 MHz HAC Validation; Dipole Sn# 1076; Input Power = 100 mW

Communication System: CW - HAC; Frequency: 835 MHz; Duty Cycle: 1:1

Medium: Air; Medium parameters used: $\sigma = 0$ mho/m, $\epsilon_r = 1$; $\rho = 0$ kg/m³

DASY4 Configuration:

- Probe: ER3DV6R - SN2244; ConvF(1, 1, 1); Calibrated: 9/22/2008
- Sensor-Surface: 0mm (Fix Surface)Sensor-Surface: (Fix Surface)
- Electronics: DAE4 Sn703; Calibrated: 9/19/2008
- Phantom: R-3, HAC Test Arch (rev.2); Type: SD HAC P01 BA; Serial: 1071;
- Measurement SW: DASY4, V4.7 Build 71; Postprocessing SW: SEMCAD, V1.8 Build 184

E Scan - Probe center 10mm above Dipole/Hearing Aid Compatibility Test (41x361x1):

Measurement grid: dx=5mm, dy=5mm

Probe Modulation Factor = 1.00; Device Reference Point: 0.000, 0.000, -6.30 mm

Reference Value = 101.9 V/m; Power Drift = 0.031 dB

Maximum value of Total (interpolated) = 162.2 V/m

Average value of Total (interpolated) = $(162.2 + 162.0) / 2 = 162.1$ V/m

Peak E-field in V/m

Grid 1 154.7 M4	Grid 2 162.2 M4	Grid 3 161.3 M4
Grid 4 81.8 M4	Grid 5 84.9 M4	Grid 6 84.4 M4
Grid 7 152.1 M4	Grid 8 162.0 M4	Grid 9 161.4 M4

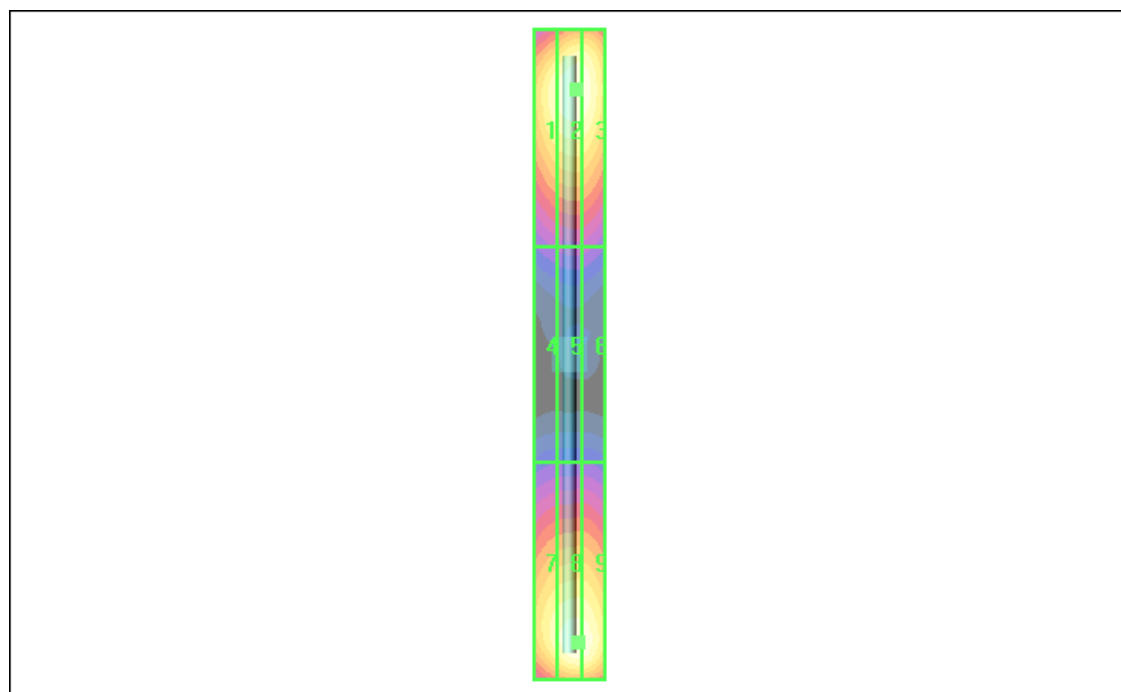
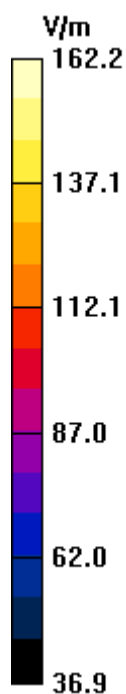

Date/Time: 1/20/2009 8:11:53 AM

Test Laboratory: Motorola - 012009, E - 898 CW -2.0% GOOD

DUT: HAC-Dipole 898 MHz; Type: CD835V3; Serial: 1076; FCC ID: IHDT56KB1

Procedure Notes: 898 MHz HAC Validation; Dipole Sn# 1076-898; Input Power = 100 mW

Communication System: CW - HAC; Frequency: 898 MHz; Duty Cycle: 1:1

Medium: Air; Medium parameters used: $\sigma = 0$ mho/m, $\epsilon_r = 1$; $\rho = 0$ kg/m³

DASY4 Configuration:

- Probe: ER3DV6R - SN2244; ConvF(1, 1, 1); Calibrated: 9/22/2008
- Sensor-Surface: 0mm (Fix Surface)Sensor-Surface: (Fix Surface)
- Electronics: DAE4 Sn703; Calibrated: 9/19/2008
- Phantom: R-3, HAC Test Arch (rev.2); Type: SD HAC P01 BA; Serial: 1071;
- Measurement SW: DASY4, V4.7 Build 71; Postprocessing SW: SEMCAD, V1.8 Build 184

E Scan - Probe center 10mm above Dipole/Hearing Aid Compatibility Test (41x361x1):

Measurement grid: dx=5mm, dy=5mm

Probe Modulation Factor = 1.00; Device Reference Point: 0.000, 0.000, -6.30 mm

Reference Value = 88.3 V/m; Power Drift = -0.070 dB

Maximum value of Total (interpolated) = 151.3 V/m

Average value of Total (interpolated) = $(151.3 + 145.3) / 2 = 148.3$ V/m

Peak E-field in V/m

Grid 1 143.9 M4	Grid 2 151.3 M4	Grid 3 150.3 M4
Grid 4 69.5 M4	Grid 5 72.4 M4	Grid 6 71.7 M4
Grid 7 136.6 M4	Grid 8 145.3 M4	Grid 9 144.6 M4

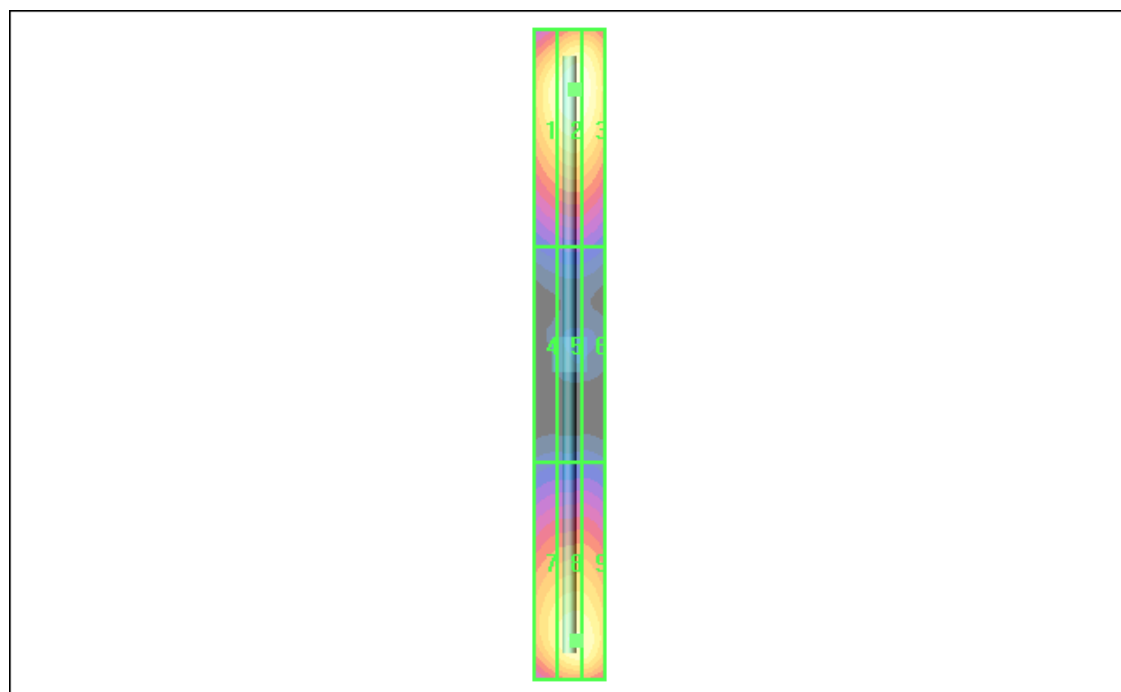
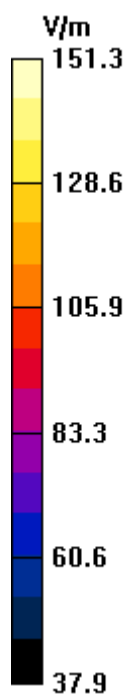

Date/Time: 1/27/2009 6:23:42 AM

Test Laboratory: Motorola - 012709, E - 835 CW -0.0% GOOD

DUT: HAC-Dipole 835 MHz; Type: CD835V3; Serial: 1076; FCC ID: IHDT56KB1

Procedure Notes: 835 MHz HAC Validation; Dipole Sn# 1076; Input Power = 100 mW

Communication System: CW - HAC; Frequency: 835 MHz; Duty Cycle: 1:1

Medium: Air; Medium parameters used: $\sigma = 0$ mho/m, $\epsilon_r = 1$; $\rho = 0$ kg/m³

DASY4 Configuration:

- Probe: ER3DV6R - SN2244; ConvF(1, 1, 1); Calibrated: 9/22/2008
- Sensor-Surface: 0mm (Fix Surface)Sensor-Surface: (Fix Surface)
- Electronics: DAE4 Sn703; Calibrated: 9/19/2008
- Phantom: R-3, HAC Test Arch (rev.2); Type: SD HAC P01 BA; Serial: 1071;
- Measurement SW: DASY4, V4.7 Build 71; Postprocessing SW: SEMCAD, V1.8 Build 184

E Scan - Probe center 10mm above Dipole/Hearing Aid Compatibility Test (41x361x1):

Measurement grid: dx=5mm, dy=5mm

Probe Modulation Factor = 1.00; Device Reference Point: 0.000, 0.000, -6.30 mm

Reference Value = 100.9 V/m; Power Drift = 0.054 dB

Maximum value of Total (interpolated) = 161.7 V/m

Average value of Total (interpolated) = $(161.7 + 156.2) / 2 = 158.95$ V/m

Peak E-field in V/m

Grid 1 149.3 M4	Grid 2 156.2 M4	Grid 3 154.6 M4
Grid 4 81.7 M4	Grid 5 85.0 M4	Grid 6 84.5 M4
Grid 7 150.0 M4	Grid 8 161.7 M4	Grid 9 161.4 M4

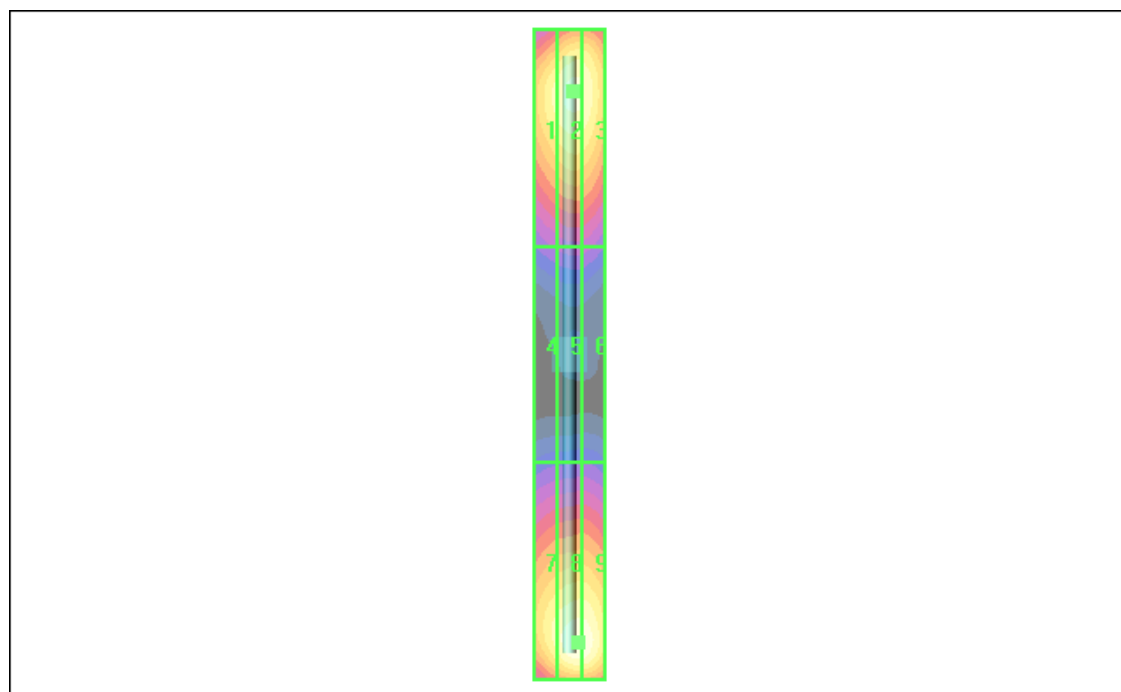
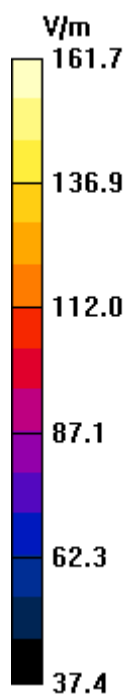

Date/Time: 1/27/2009 7:13:38 AM

Test Laboratory: Motorola - 012709, E - 898 CW -3.8% GOOD

DUT: HAC-Dipole 898 MHz; Type: CD835V3; Serial: 1076; FCC ID: IHDT56KB1

Procedure Notes: 898 MHz HAC Validation; Dipole Sn# 1076-898; Input Power = 100 mW

Communication System: CW - HAC; Frequency: 898 MHz; Duty Cycle: 1:1

Medium: Air; Medium parameters used: $\sigma = 0$ mho/m, $\epsilon_r = 1$; $\rho = 0$ kg/m³

DASY4 Configuration:

- Probe: ER3DV6R - SN2244; ConvF(1, 1, 1); Calibrated: 9/22/2008
- Sensor-Surface: 0mm (Fix Surface)Sensor-Surface: (Fix Surface)
- Electronics: DAE4 Sn703; Calibrated: 9/19/2008
- Phantom: R-3, HAC Test Arch (rev.2); Type: SD HAC P01 BA; Serial: 1071;
- Measurement SW: DASY4, V4.7 Build 71; Postprocessing SW: SEMCAD, V1.8 Build 184

E Scan - Probe center 10mm above Dipole/Hearing Aid Compatibility Test (41x361x1):

Measurement grid: dx=5mm, dy=5mm

Probe Modulation Factor = 1.00; Device Reference Point: 0.000, 0.000, -6.30 mm

Reference Value = 87.8 V/m; Power Drift = -0.051 dB

Maximum value of Total (interpolated) = 147.0 V/m

Average value of Total (interpolated) = $(147.0 + 144.4) / 2 = 145.7$ V/m

Peak E-field in V/m

Grid 1 137.6 M4	Grid 2 144.4 M4	Grid 3 143.7 M4
Grid 4 69.5 M4	Grid 5 72.5 M4	Grid 6 72.0 M4
Grid 7 141.0 M4	Grid 8 147.0 M4	Grid 9 146.1 M4

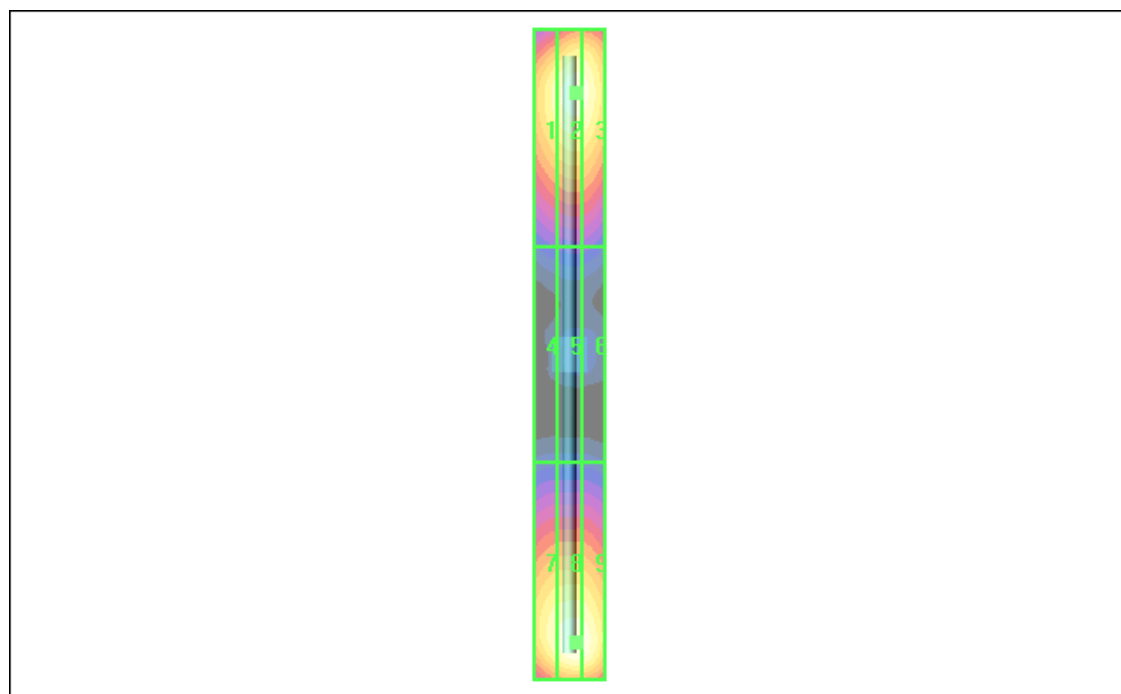
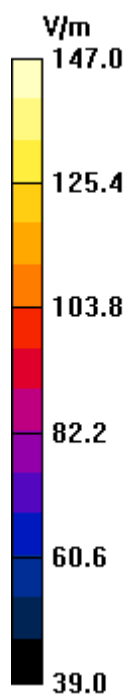

Date/Time: 1/20/2009 7:12:12 AM

Test Laboratory: Motorola - 012009, H - 835 CW +1.8% GOOD

DUT: HAC-Dipole 835 MHz; Type: CD835V3; Serial: 1076; FCC ID: IHDT56KB1

Procedure Notes: 835 MHz HAC Validation; Dipole Sn# 1076; Input Power = 100 mW

Communication System: CW - HAC; Frequency: 835 MHz; Duty Cycle: 1:1

Medium: Air; Medium parameters used: $\sigma = 0$ mho/m, $\epsilon_r = 1$; $\rho = 0$ kg/m³

DASY4 Configuration:

- Probe: H3DV6 - SN6078; ; Calibrated: 9/22/2008
- Sensor-Surface: 0mm (Fix Surface)Sensor-Surface: (Fix Surface)
- Electronics: DAE4 Sn639; Calibrated: 9/22/2008
- Phantom: R-3, HAC Test Arch (rev.2); Type: SD HAC P01 BA; Serial: 1071;
- Measurement SW: DASY4, V4.7 Build 71; Postprocessing SW: SEMCAD, V1.8 Build 184

H Scan - Probe center 10mm above Dipole/Hearing Aid Compatibility Test (41x361x1):

Measurement grid: dx=5mm, dy=5mm

Probe Modulation Factor = 1.00; Device Reference Point: 0.000, 0.000, -6.30 mm

Reference Value = 0.476 A/m; Power Drift = 0.040 dB

Maximum value of Total (interpolated) = 0.453 A/m

Peak H-field in A/m

Grid 1 0.372 M4	Grid 2 0.415 M4	Grid 3 0.406 M4
Grid 4 0.413 M4	Grid 5 0.453 M4	Grid 6 0.442 M4
Grid 7 0.360 M4	Grid 8 0.391 M4	Grid 9 0.384 M4

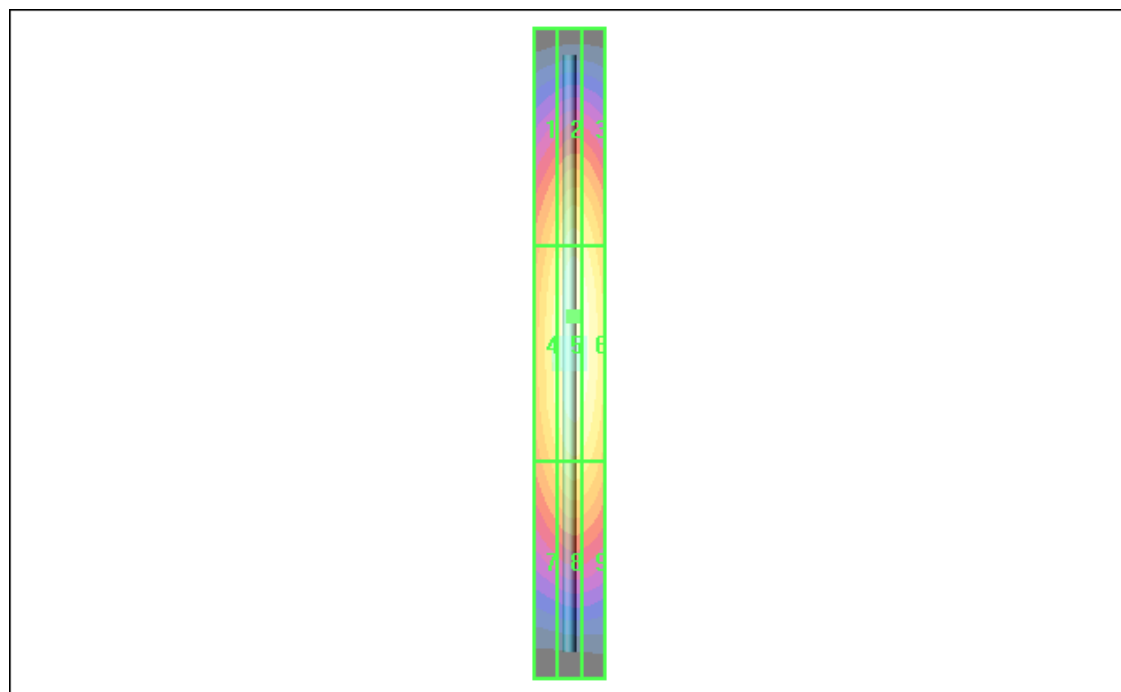
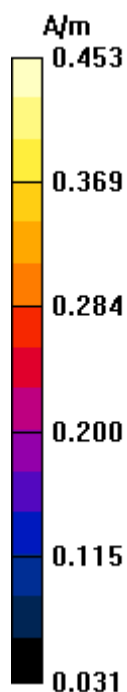

Date/Time: 1/20/2009 7:27:43 AM

Test Laboratory: Motorola - 012009, H - 898 CW -0.4% GOOD

DUT: HAC-Dipole 898 MHz; Type: CD835V3; Serial: 1076; FCC ID: IHDT56KB1

Procedure Notes: 898 MHz HAC Validation; Dipole Sn# 1076-898; Input Power = 100 mW

Communication System: CW - HAC; Frequency: 898 MHz; Duty Cycle: 1:1

Medium: Air; Medium parameters used: $\sigma = 0$ mho/m, $\epsilon_r = 1$; $\rho = 0$ kg/m³

DASY4 Configuration:

- Probe: H3DV6 - SN6078; ; Calibrated: 9/22/2008
- Sensor-Surface: 0mm (Fix Surface)Sensor-Surface: (Fix Surface)
- Electronics: DAE4 Sn639; Calibrated: 9/22/2008
- Phantom: R-3, HAC Test Arch (rev.2); Type: SD HAC P01 BA; Serial: 1071;
- Measurement SW: DASY4, V4.7 Build 71; Postprocessing SW: SEMCAD, V1.8 Build 184

H Scan - Probe center 10mm above Dipole/Hearing Aid Compatibility Test (41x361x1):

Measurement grid: dx=5mm, dy=5mm

Probe Modulation Factor = 1.00; Device Reference Point: 0.000, 0.000, -6.30 mm

Reference Value = 0.423 A/m; Power Drift = 0.043 dB

Maximum value of Total (interpolated) = 0.414 A/m

Peak H-field in A/m

Grid 1 0.357 M4	Grid 2 0.394 M4	Grid 3 0.388 M4
Grid 4 0.377 M4	Grid 5 0.414 M4	Grid 6 0.405 M4
Grid 7 0.336 M4	Grid 8 0.366 M4	Grid 9 0.360 M4

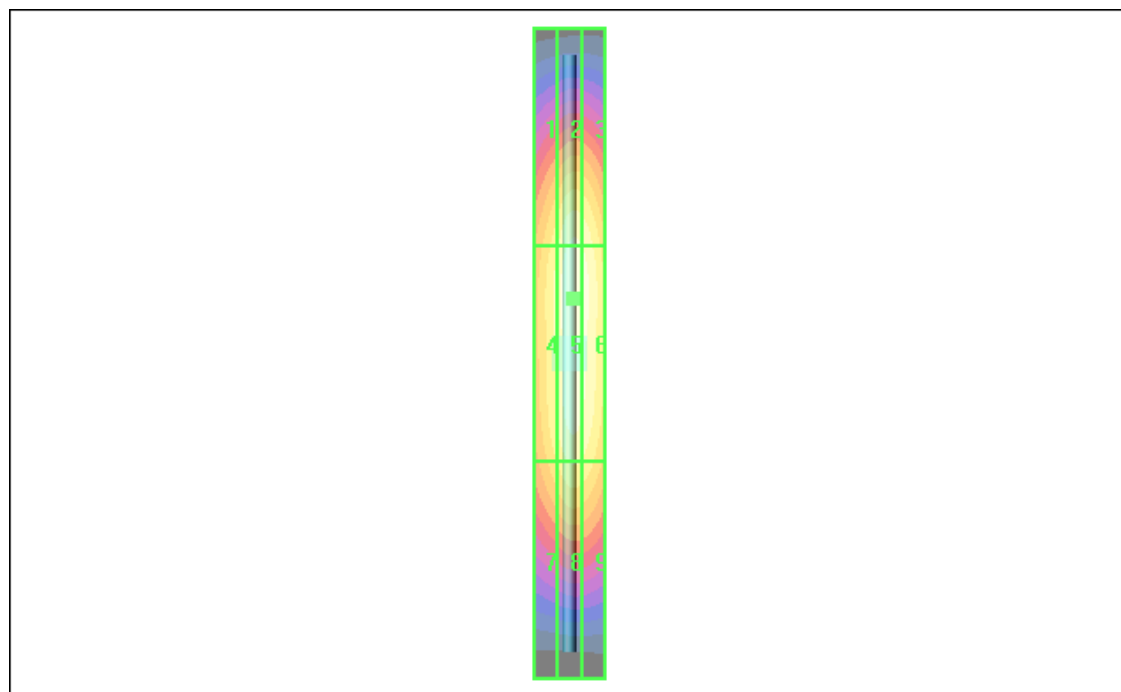
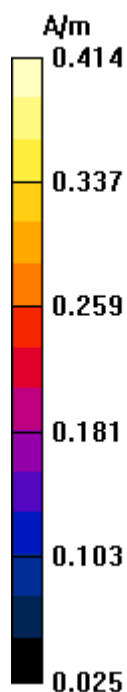

Date/Time: 1/27/2009 6:43:39 AM

Test Laboratory: Motorola - 012709, H - 835 CW +2.7% GOOD**DUT: HAC-Dipole 835 MHz; Type: CD835V3; Serial: 1076; FCC ID: IHDT56KB1**

Procedure Notes: 835 MHz HAC Validation; Dipole Sn# 1076; Input Power = 100 mW

Communication System: CW - HAC; Frequency: 835 MHz; Duty Cycle: 1:1

Medium: Air; Medium parameters used: $\sigma = 0$ mho/m, $\epsilon_r = 1$; $\rho = 0$ kg/m³

DASY4 Configuration:

- Probe: H3DV6 - SN6078; ; Calibrated: 9/22/2008
- Sensor-Surface: 0mm (Fix Surface)Sensor-Surface: (Fix Surface)
- Electronics: DAE4 Sn639; Calibrated: 9/22/2008
- Phantom: R-3, HAC Test Arch (rev.2); Type: SD HAC P01 BA; Serial: 1071;
- Measurement SW: DASY4, V4.7 Build 71; Postprocessing SW: SEMCAD, V1.8 Build 184

H Scan - Probe center 10mm above Dipole/Hearing Aid Compatibility Test (41x361x1):

Measurement grid: dx=5mm, dy=5mm

Probe Modulation Factor = 1.00; Device Reference Point: 0.000, 0.000, -6.30 mm

Reference Value = 0.473 A/m; Power Drift = 0.056 dB

Maximum value of Total (interpolated) = 0.457 A/m

Peak H-field in A/m

Grid 1 0.371 M4	Grid 2 0.412 M4	Grid 3 0.404 M4
Grid 4 0.415 M4	Grid 5 0.457 M4	Grid 6 0.446 M4
Grid 7 0.357 M4	Grid 8 0.393 M4	Grid 9 0.382 M4

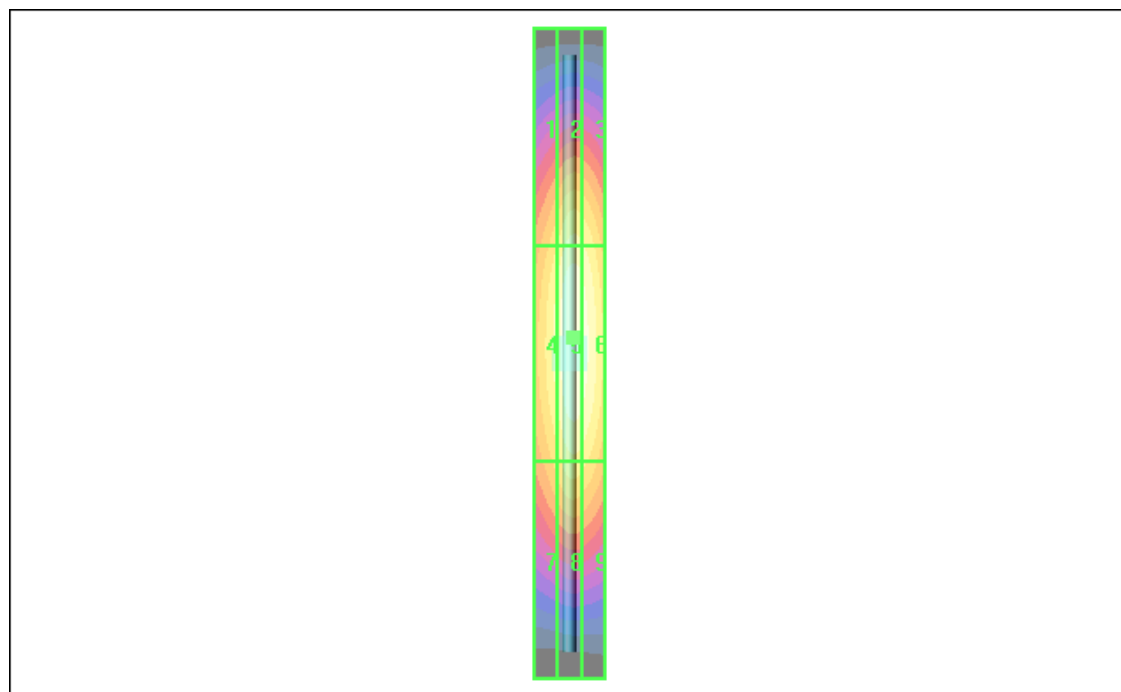
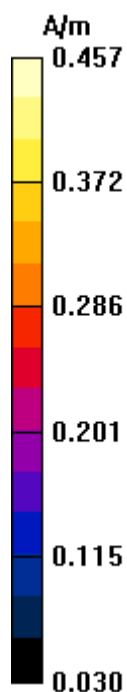

Date/Time: 1/27/2009 6:58:12 AM

Test Laboratory: Motorola - 012709, H - 898 CW +1.4% GOOD

DUT: HAC-Dipole 898 MHz; Type: CD835V3; Serial: 1076; FCC ID: IHDT56KB1

Procedure Notes: 898 MHz HAC Validation; Dipole Sn# 1076-898; Input Power = 100 mW

Communication System: CW - HAC; Frequency: 898 MHz; Duty Cycle: 1:1

Medium: Air; Medium parameters used: $\sigma = 0$ mho/m, $\epsilon_r = 1$; $\rho = 0$ kg/m³

DASY4 Configuration:

- Probe: H3DV6 - SN6078; ; Calibrated: 9/22/2008
- Sensor-Surface: 0mm (Fix Surface)Sensor-Surface: (Fix Surface)
- Electronics: DAE4 Sn639; Calibrated: 9/22/2008
- Phantom: R-3, HAC Test Arch (rev.2); Type: SD HAC P01 BA; Serial: 1071;
- Measurement SW: DASY4, V4.7 Build 71; Postprocessing SW: SEMCAD, V1.8 Build 184

H Scan - Probe center 10mm above Dipole/Hearing Aid Compatibility Test (41x361x1):

Measurement grid: dx=5mm, dy=5mm

Probe Modulation Factor = 1.00; Device Reference Point: 0.000, 0.000, -6.30 mm

Reference Value = 0.428 A/m; Power Drift = 0.051 dB

Maximum value of Total (interpolated) = 0.422 A/m

Peak H-field in A/m

Grid 1 0.363 M4	Grid 2 0.401 M4	Grid 3 0.393 M4
Grid 4 0.386 M4	Grid 5 0.422 M4	Grid 6 0.413 M4
Grid 7 0.346 M4	Grid 8 0.376 M4	Grid 9 0.367 M4

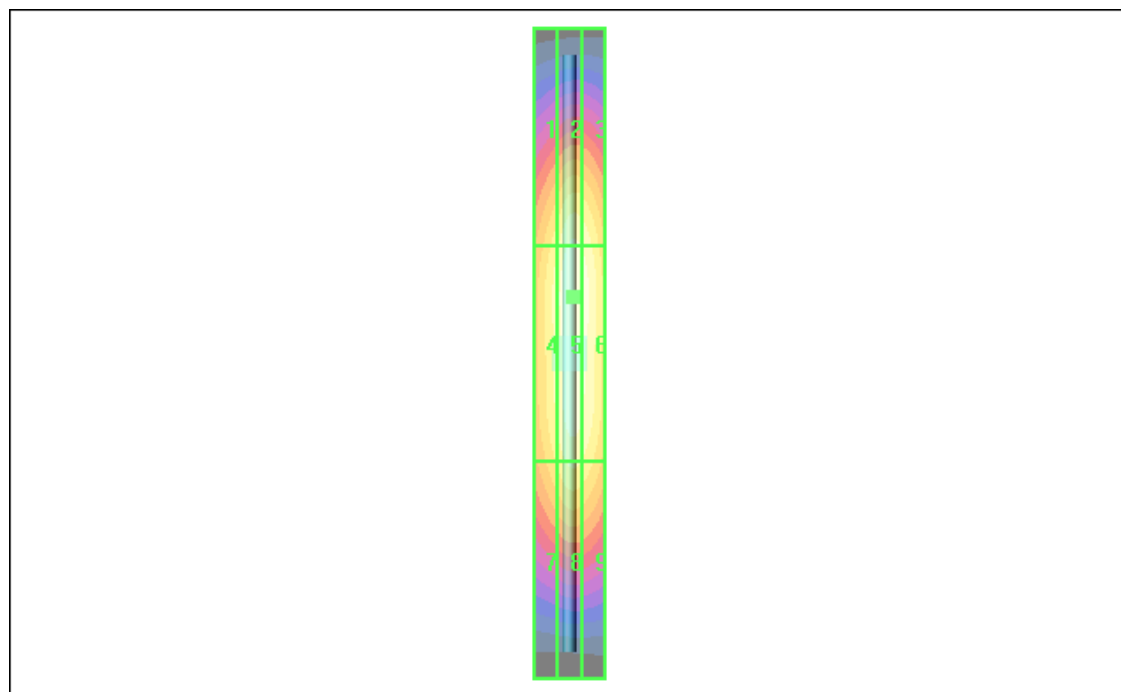
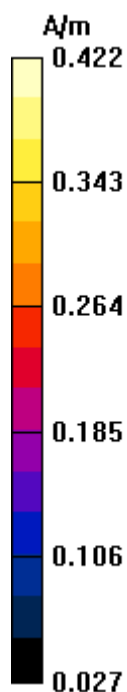

Appendix 3

HAC distribution plots for E-Field and H-Field

Date/Time: 1/20/2009 4:11:40 PM

Test Laboratory: Motorola - iDEN 800 E-Field, 2:6 Vocoder

Serial: 364VJYJS39; FCC ID: IHDT56KB1

Procedure Notes: Pwr Step: 0 dB; Antenna Position: Internal; Accessory Model #: N/A

Battery Model #: SNN5795A; Vocoder Rate: 2:6; PMF Value: 3.6; Positioner: SPEAG Clamp

Communication System: iDEN 2:6; Frequency: 806.01 MHz; Channel Number: 1; Duty Cycle: 1:3

Medium: Air; Medium parameters used: $\sigma = 0$ mho/m, $\epsilon_r = 1$; $\rho = 0$ kg/m³

DASY4 Configuration:

- Probe: ER3DV6R - SN2244; ConvF(1, 1, 1); Calibrated: 9/22/2008
- Sensor-Surface: (Fix Surface)
- Electronics: DAE4 Sn703; Calibrated: 9/19/2008
- Phantom: R-3, HAC Test Arch (rev.2); Type: SD HAC P01 BA; Serial: 1071;
- Measurement SW: DASY4, V4.7 Build 71; Postprocessing SW: SEMCAD, V1.8 Build 184

E Scan - Sensor center 15mm above WD, Hearing Aid Compatibility Test (101x101x1):

Measurement grid: dx=5mm, dy=5mm

Maximum value of peak Total field = 284.3 V/m; Probe Modulation Factor = 3.60

Device Reference Point: 0.000, 0.000, -6.30 mm; Reference Value = 103.6 V/m; Power Drift = -0.006 dB

Hearing Aid Near-Field Category: **M3 (AWF 0 dB)**

Peak E-field in V/m

Grid 1 248.1 M3	Grid 2 265.6 M3	Grid 3 251.8 M3
Grid 4 260.8 M3	Grid 5 284.3 M3	Grid 6 269.5 M3
Grid 7 274.9 M3	Grid 8 285.4 M3	Grid 9 269.3 M3

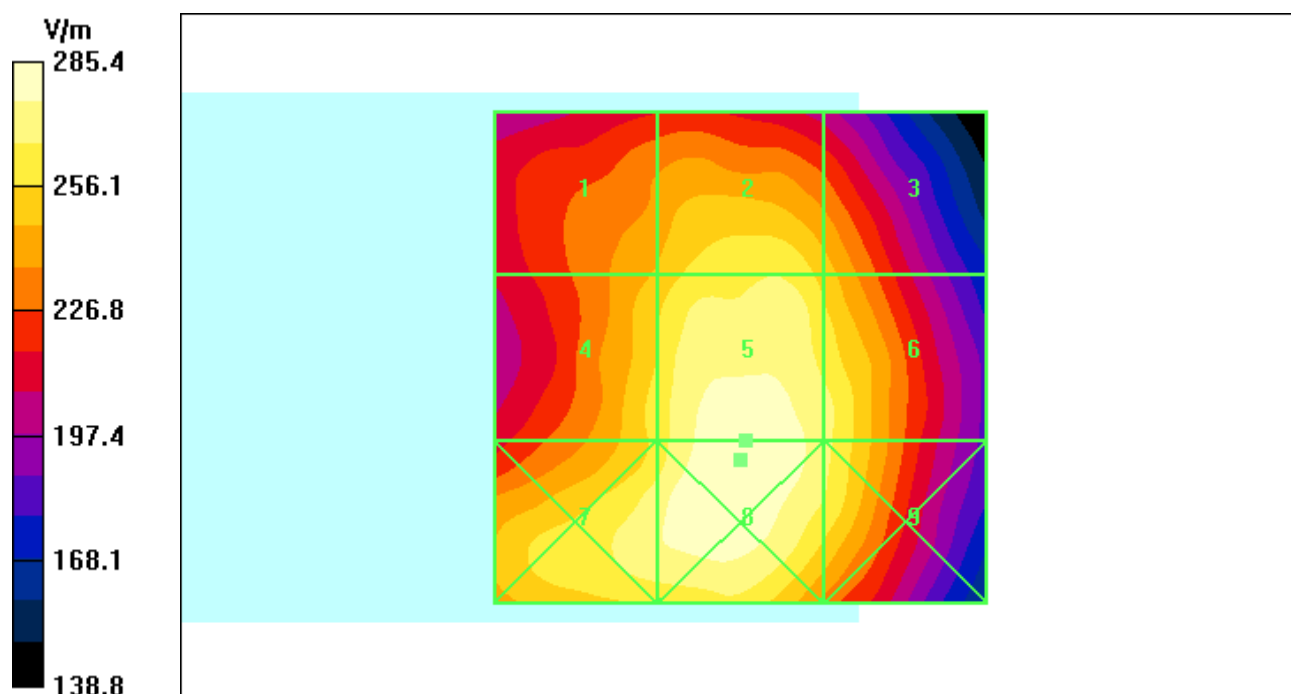

Date/Time: 1/27/2009 11:03:09 AM

Test Laboratory: Motorola - iDEN 900 E-Field, 2:6 Vocoder

Serial: 364VJYJS39; FCC ID: IHDT56KB1

Procedure Notes: Pwr Step: 0 dB; Antenna Position: Internal; Accessory Model #: N/A

Battery Model #: SNN5754A; Vocoder Rate: 2:6; PMF Value: 3.40; Positioner: SPEAG Clamp

Communication System: iDEN 2:6; Frequency: 896.02 MHz; Channel Number: 5; Duty Cycle: 1:3

Medium: Air; Medium parameters used: $\sigma = 0$ mho/m, $\epsilon_r = 1$; $\rho = 0$ kg/m³

DASY4 Configuration:

- Probe: ER3DV6R - SN2244; ConvF(1, 1, 1); Calibrated: 9/22/2008
- Sensor-Surface: (Fix Surface)
- Electronics: DAE4 Sn703; Calibrated: 9/19/2008
- Phantom: R-3, HAC Test Arch (rev.2); Type: SD HAC P01 BA; Serial: 1071;
- Measurement SW: DASY4, V4.7 Build 71; Postprocessing SW: SEMCAD, V1.8 Build 184

E Scan - Sensor center 15mm above WD, Hearing Aid Compatibility Test (101x101x1):

Measurement grid: dx=5mm, dy=5mm

Maximum value of peak Total field = 181.2 V/m; Probe Modulation Factor = 3.40

Device Reference Point: 0.000, 0.000, -6.30 mm; Reference Value = 62.2 V/m; Power Drift = -0.061 dB

Hearing Aid Near-Field Category: **M4 (AWF 0 dB)**

Peak E-field in V/m

Grid 1 132.9 M4	Grid 2 163.8 M4	Grid 3 163.8 M4
Grid 4 156.0 M4	Grid 5 181.2 M4	Grid 6 180.4 M4
Grid 7 160.8 M4	Grid 8 181.1 M4	Grid 9 180.9 M4

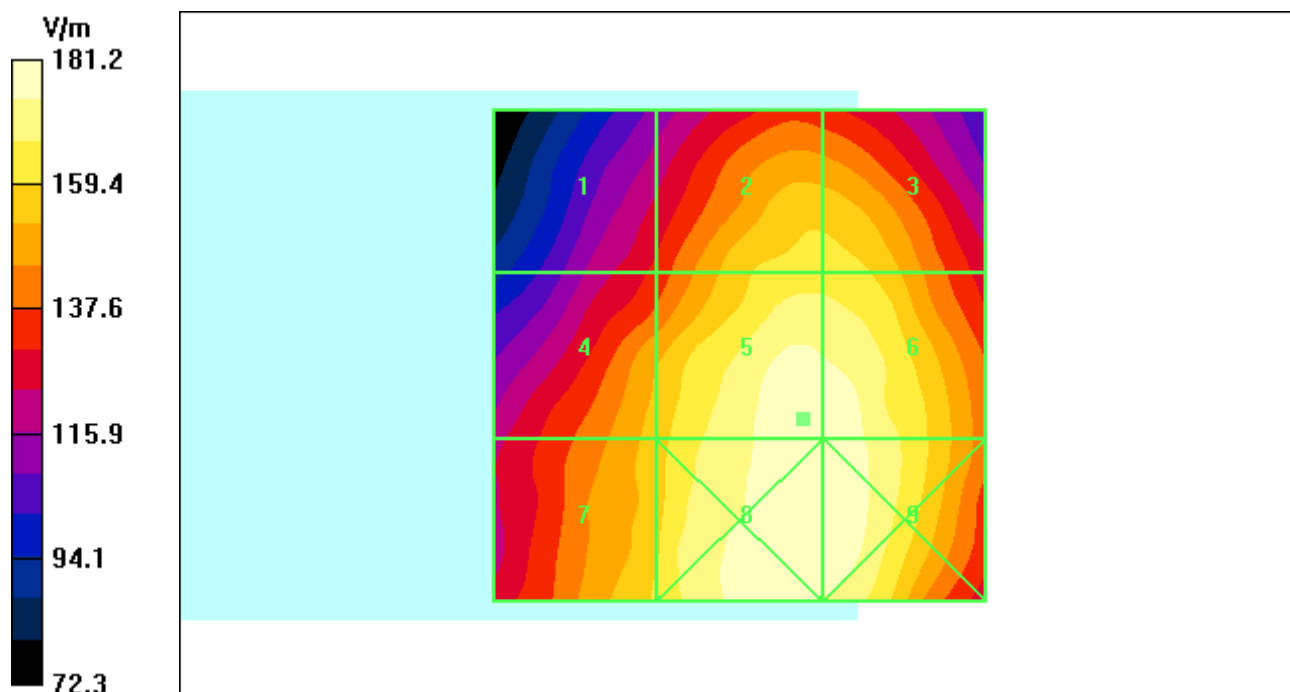

Date/Time: 1/20/2009 3:30:44 PM

Test Laboratory: Motorola - iDEN 800 E-Field, 1:6 Vocoder

Serial: 364VJYJS39; FCC ID: IHDT56KB1

Procedure Notes: Pwr Step: 0 dB; Antenna Position: Internal; Accessory Model #: N/A

Battery Model #: SNN5792A; Vocoder Rate: 1:6; PMF Value: 5.05; Positioner: SPEAG Clamp

Communication System: iDEN 1:6; Frequency: 806.01 MHz; Channel Number: 1; Duty Cycle: 1:6

Medium: Air; Medium parameters used: $\sigma = 0$ mho/m, $\epsilon_r = 1$; $\rho = 0$ kg/m³

DASY4 Configuration:

- Probe: ER3DV6R - SN2244; ConvF(1, 1, 1); Calibrated: 9/22/2008
- Sensor-Surface: (Fix Surface)
- Electronics: DAE4 Sn703; Calibrated: 9/19/2008
- Phantom: R-3, HAC Test Arch (rev.2); Type: SD HAC P01 BA; Serial: 1071;
- Measurement SW: DASY4, V4.7 Build 71; Postprocessing SW: SEMCAD, V1.8 Build 184

E Scan - Sensor center 15mm above WD, Hearing Aid Compatibility Test (101x101x1):

Measurement grid: dx=5mm, dy=5mm

Maximum value of peak Total field = 284.7 V/m; Probe Modulation Factor = 5.05

Device Reference Point: 0.000, 0.000, -6.30 mm; Reference Value = 74.2 V/m; Power Drift = -0.021 dB

Hearing Aid Near-Field Category: **M3 (AWF 0 dB)**

Peak E-field in V/m

Grid 1 244.2 M3	Grid 2 262.8 M3	Grid 3 251.5 M3
Grid 4 256.3 M3	Grid 5 284.7 M3	Grid 6 269.3 M3
Grid 7 272.0 M3	Grid 8 286.2 M3	Grid 9 269.9 M3

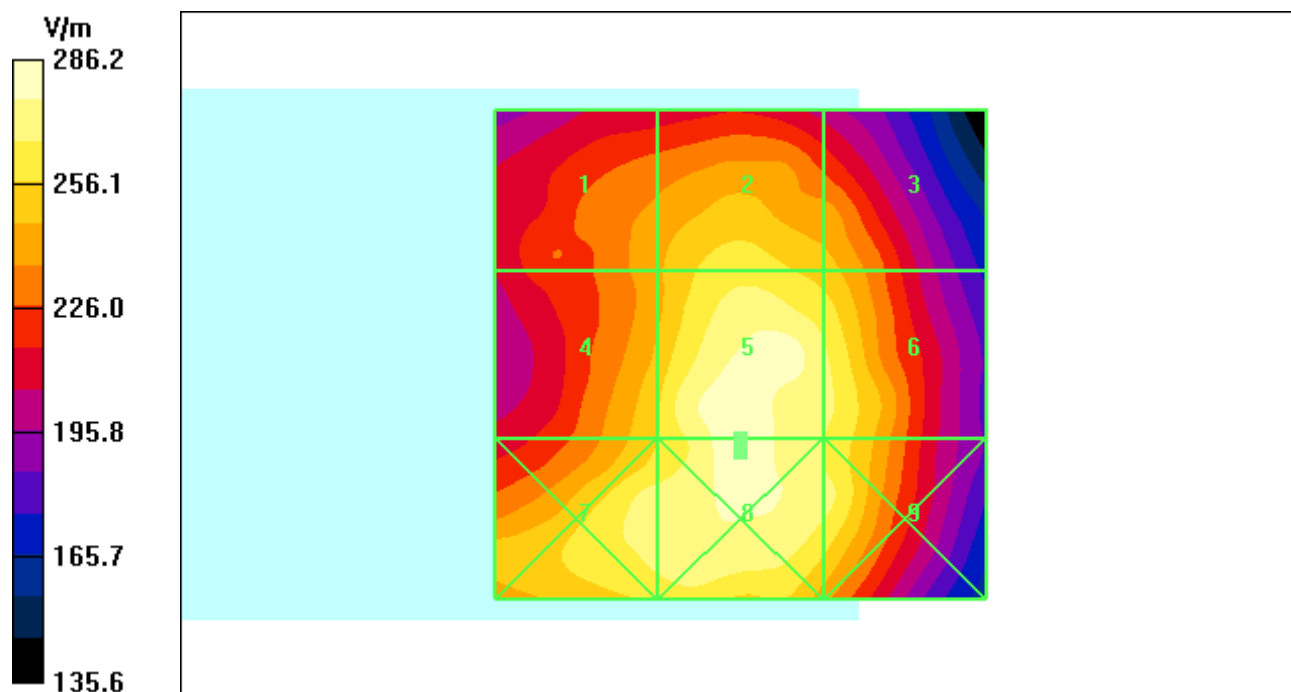

Date/Time: 1/27/2009 10:53:22 AM

Test Laboratory: Motorola - iDEN 900 E-Field, 1:6 Vocoder

Serial: 364VJYJS39; FCC ID: IHDT56KB1

Procedure Notes: Pwr Step: 0 dB; Antenna Position: Internal; Accessory Model #: N/A

Battery Model #: SNN5754A; Vocoder Rate: 1:6; PMF Value: 4.86; Positioner: SPEAG Clamp

Communication System: iDEN 1:6; Frequency: 896.02 MHz; Channel Number: 5; Duty Cycle: 1:6

Medium: Air; Medium parameters used: $\sigma = 0$ mho/m, $\epsilon_r = 1$; $\rho = 0$ kg/m³

DASY4 Configuration:

- Probe: ER3DV6R - SN2244; ConvF(1, 1, 1); Calibrated: 9/22/2008
- Sensor-Surface: (Fix Surface)
- Electronics: DAE4 Sn703; Calibrated: 9/19/2008
- Phantom: R-3, HAC Test Arch (rev.2); Type: SD HAC P01 BA; Serial: 1071;
- Measurement SW: DASY4, V4.7 Build 71; Postprocessing SW: SEMCAD, V1.8 Build 184

E Scan - Sensor center 15mm above WD, Hearing Aid Compatibility Test (101x101x1):

Measurement grid: dx=5mm, dy=5mm

Maximum value of peak Total field = 188.0 V/m; Probe Modulation Factor = 4.86

Device Reference Point: 0.000, 0.000, -6.30 mm; Reference Value = 45.2 V/m; Power Drift = 0.014 dB

Hearing Aid Near-Field Category: **M4 (AWF 0 dB)**

Peak E-field in V/m

Grid 1 138.1 M4	Grid 2 172.6 M4	Grid 3 172.6 M4
Grid 4 160.9 M4	Grid 5 187.6 M4	Grid 6 188.0 M4
Grid 7 170.2 M4	Grid 8 191.0 M4	Grid 9 188.5 M4

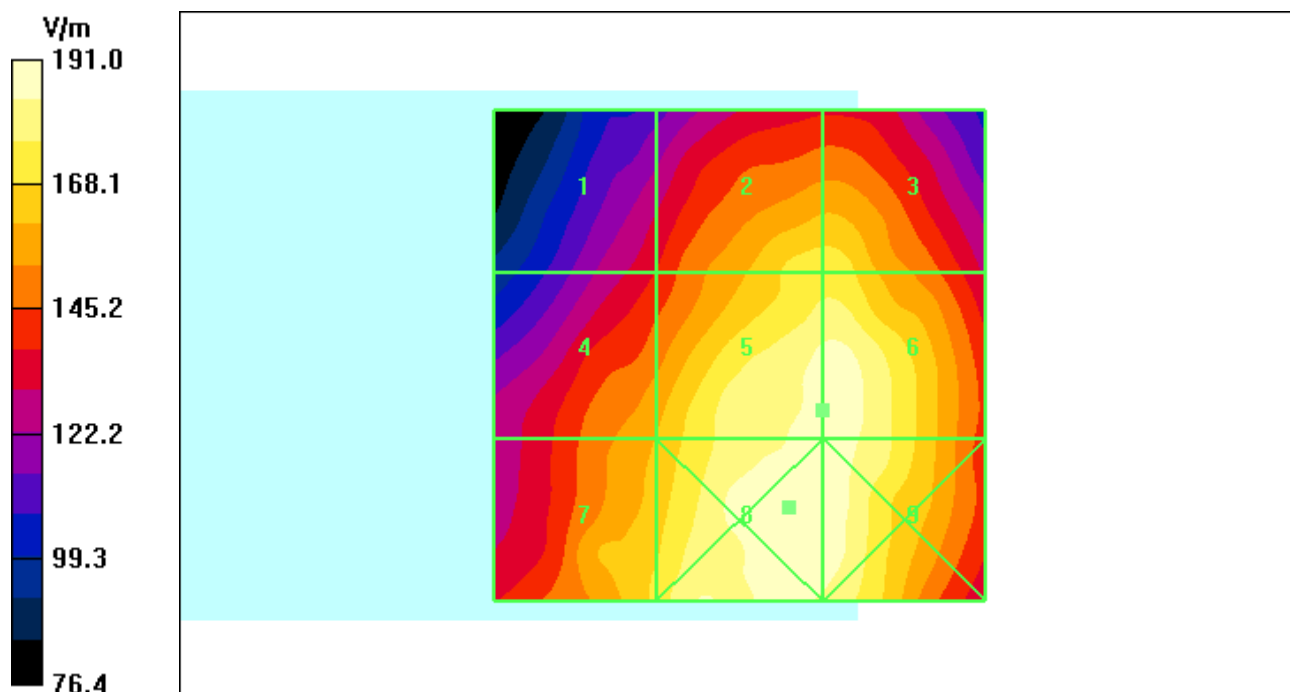

Date/Time: 1/27/2009 3:13:55 PM

Test Laboratory: Motorola - iDEN 800 H-Field, 2:6 Vocoder

Serial: 364VJYJS39; FCC ID: IHDT56KB1

Procedure Notes: Pwr Step: 0 dB; Antenna Position: Internal; Accessory Model #: N/A

Battery Model #: SNN5754A; Vocoder Rate: 1:6; PMF Value: 3.18; Positioner: SPEAG Clamp

Communication System: iDEN 2:6; Frequency: 824.98 MHz; Channel Number: 4; Duty Cycle: 1:3

Medium: Air; Medium parameters used: $\sigma = 0$ mho/m, $\epsilon_r = 1$; $\rho = 0$ kg/m³

DASY4 Configuration:

- Probe: H3DV6 - SN6078; ; Calibrated: 9/22/2008
- Sensor-Surface: (Fix Surface)
- Electronics: DAE4 Sn639; Calibrated: 9/22/2008
- Phantom: R-3, HAC Test Arch (rev.2); Type: SD HAC P01 BA; Serial: 1071;
- Measurement SW: DASY4, V4.7 Build 71; Postprocessing SW: SEMCAD, V1.8 Build 184

H Scan - Sensor center 15mm above WD, Hearing Aid Compatibility Test (101x101x1):

Measurement grid: dx=5mm, dy=5mm

Maximum value of peak Total field = 0.476 A/m; Probe Modulation Factor = 3.18

Device Reference Point: 0.000, 0.000, -6.30 mm; Reference Value = 0.082 A/m; Power Drift = 0.044 dB

Hearing Aid Near-Field Category: **M4 (AWF 0 dB)**

Peak H-field in A/m

Grid 1 0.571 M4	Grid 2 0.476 M4	Grid 3 0.289 M4
Grid 4 0.480 M4	Grid 5 0.382 M4	Grid 6 0.257 M4
Grid 7 0.505 M4	Grid 8 0.422 M4	Grid 9 0.259 M4

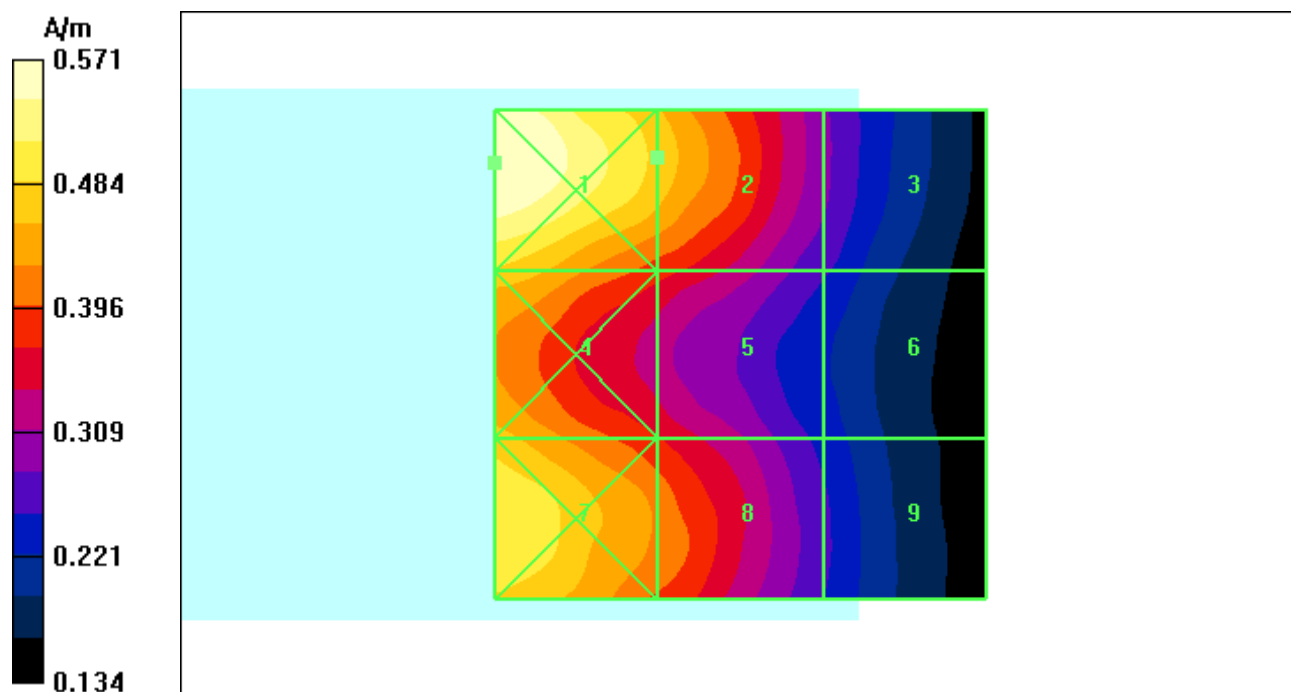

Date/Time: 1/27/2009 2:27:35 PM

Test Laboratory: Motorola - iDEN 900 H-Field, 2:6 Vocoder

Serial: 364VJYJS39; FCC ID: IHDT56KB1

Procedure Notes: Pwr Step: 0 dB; Antenna Position: Internal; Accessory Model #: N/A

Battery Model #: SNN5793A; Vocoder Rate: 2:6; PMF Value: 3.16; Positioner: SPEAG Clamp

Communication System: iDEN 2:6; Frequency: 896.02 MHz; Channel Number: 5; Duty Cycle: 1:3

Medium: Air; Medium parameters used: $\sigma = 0$ mho/m, $\epsilon_r = 1$; $\rho = 0$ kg/m³

DASY4 Configuration:

- Probe: H3DV6 - SN6078; ; Calibrated: 9/22/2008
- Sensor-Surface: (Fix Surface)
- Electronics: DAE4 Sn639; Calibrated: 9/22/2008
- Phantom: R-3, HAC Test Arch (rev.2); Type: SD HAC P01 BA; Serial: 1071;
- Measurement SW: DASY4, V4.7 Build 71; Postprocessing SW: SEMCAD, V1.8 Build 184

H Scan - Sensor center 15mm above WD, Hearing Aid Compatibility Test (101x101x1):

Measurement grid: dx=5mm, dy=5mm

Maximum value of peak Total field = 0.441 A/m; Probe Modulation Factor = 3.16

Device Reference Point: 0.000, 0.000, -6.30 mm; Reference Value = 0.097 A/m; Power Drift = 0.006 dB

Hearing Aid Near-Field Category: **M4 (AWF 0 dB)**

Peak H-field in A/m

Grid 1 0.560 M4	Grid 2 0.441 M4	Grid 3 0.276 M4
Grid 4 0.521 M4	Grid 5 0.407 M4	Grid 6 0.265 M4
Grid 7 0.526 M4	Grid 8 0.412 M4	Grid 9 0.252 M4

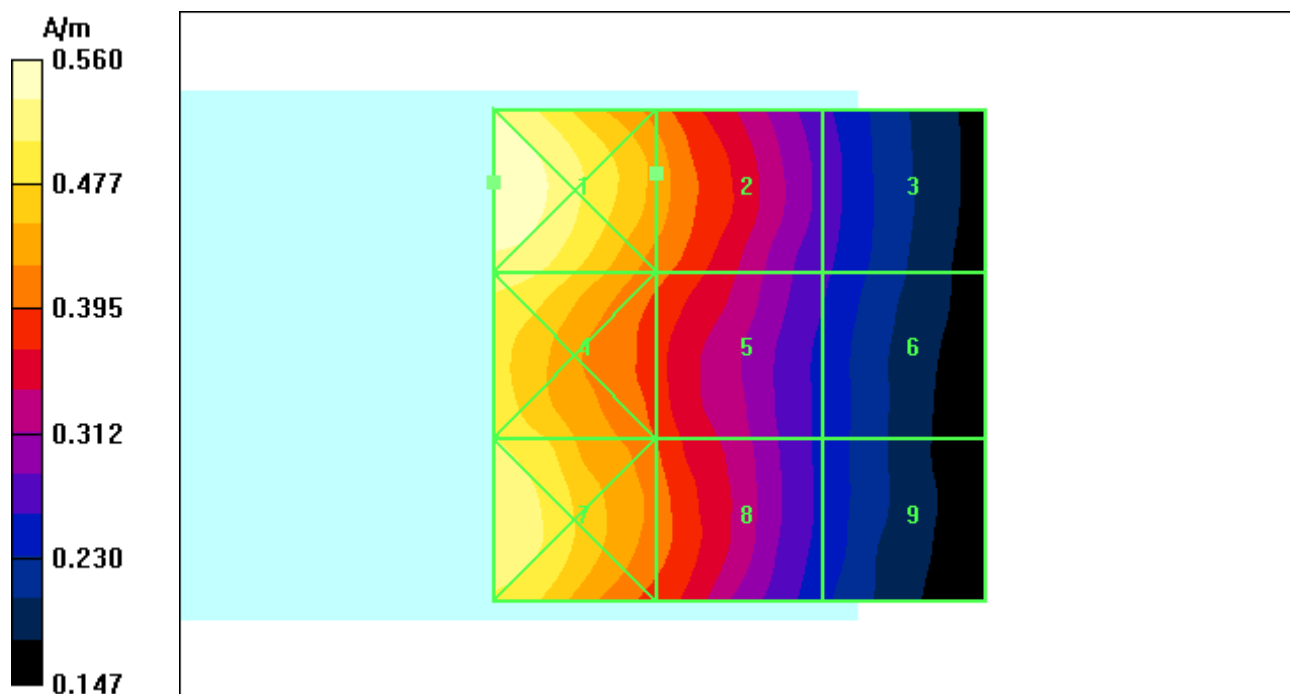

Date/Time: 1/27/2009 3:02:00 PM

Test Laboratory: Motorola - iDEN 800 H-Field, 1:6 Vocoder

Serial: 364VJYJS39; FCC ID: IHDT56KB1

Procedure Notes: Pwr Step: 0 dB; Antenna Position: Internal; Accessory Model #: N/A

Battery Model #: SNN5754A; Vocoder Rate: 1:6; PMF Value: 4.42; Positioner: SPEAG Clamp

Communication System: iDEN 1:6; Frequency: 824.98 MHz; Channel Number: 4; Duty Cycle: 1:6

Medium: Air; Medium parameters used: $\sigma = 0$ mho/m, $\epsilon_r = 1$; $\rho = 0$ kg/m³

DASY4 Configuration:

- Probe: H3DV6 - SN6078; ; Calibrated: 9/22/2008
- Sensor-Surface: (Fix Surface)
- Electronics: DAE4 Sn639; Calibrated: 9/22/2008
- Phantom: R-3, HAC Test Arch (rev.2); Type: SD HAC P01 BA; Serial: 1071;
- Measurement SW: DASY4, V4.7 Build 71; Postprocessing SW: SEMCAD, V1.8 Build 184

H Scan - Sensor center 15mm above WD, Hearing Aid Compatibility Test (101x101x1):

Measurement grid: dx=5mm, dy=5mm

Maximum value of peak Total field = 0.469 A/m; Probe Modulation Factor = 4.42

Device Reference Point: 0.000, 0.000, -6.30 mm; Reference Value = 0.059 A/m; Power Drift = 0.041 dB

Hearing Aid Near-Field Category: **M4 (AWF 0 dB)**

Peak H-field in A/m

Grid 1 0.573 M4	Grid 2 0.469 M4	Grid 3 0.287 M4
Grid 4 0.472 M4	Grid 5 0.378 M4	Grid 6 0.256 M4
Grid 7 0.511 M4	Grid 8 0.419 M4	Grid 9 0.256 M4

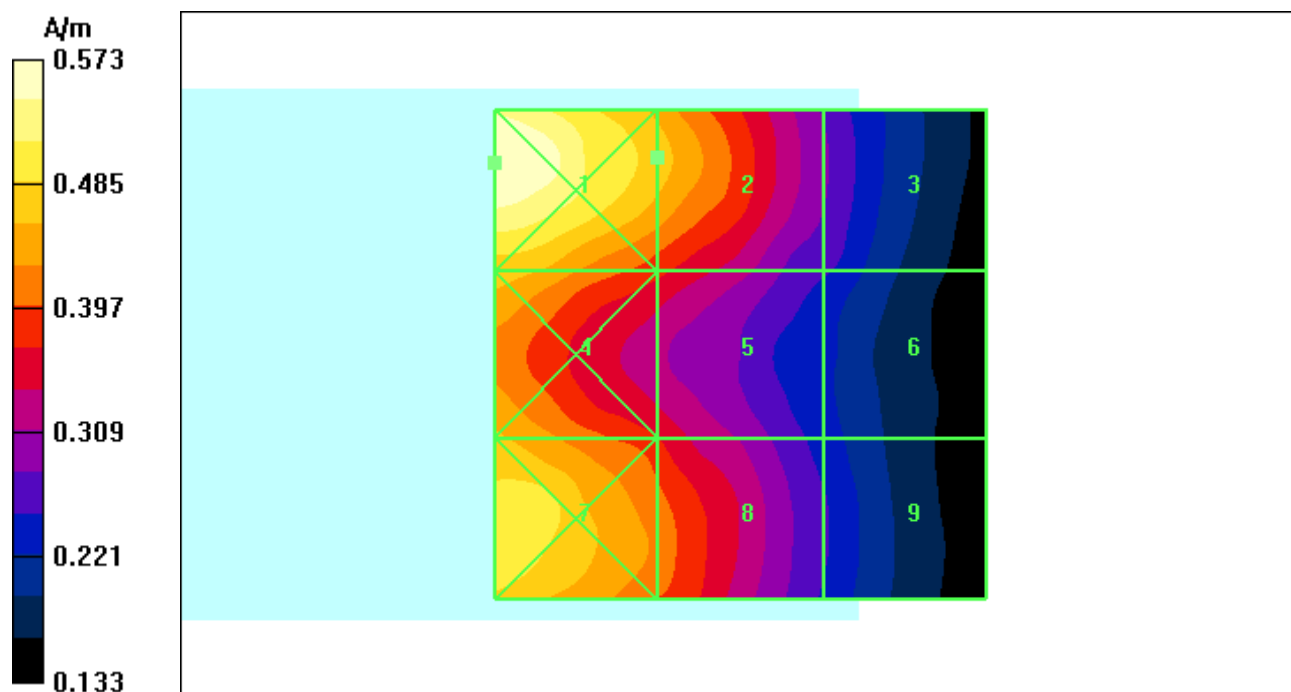

Date/Time: 1/27/2009 2:18:23 PM

Test Laboratory: Motorola - iDEN 900 H-Field, 1:6 Vocoder

Serial: 364VJYJS39; FCC ID: IHDT56KB1

Procedure Notes: Pwr Step: 0 dB; Antenna Position: Internal; Accessory Model #: N/A

Battery Model #: SNN5793A; Vocoder Rate: 1:6; PMF Value: 4.46; Positioner: SPEAG Clamp

Communication System: iDEN 1:6; Frequency: 896.02 MHz; Channel Number: 5; Duty Cycle: 1:6

Medium: Air; Medium parameters used: $\sigma = 0$ mho/m, $\epsilon_r = 1$; $\rho = 0$ kg/m³

DASY4 Configuration:

- Probe: H3DV6 - SN6078; ; Calibrated: 9/22/2008
- Sensor-Surface: (Fix Surface)
- Electronics: DAE4 Sn639; Calibrated: 9/22/2008
- Phantom: R-3, HAC Test Arch (rev.2); Type: SD HAC P01 BA; Serial: 1071;
- Measurement SW: DASY4, V4.7 Build 71; Postprocessing SW: SEMCAD, V1.8 Build 184

H Scan - Sensor center 15mm above WD, Hearing Aid Compatibility Test (101x101x1):

Measurement grid: dx=5mm, dy=5mm

Maximum value of peak Total field = 0.455 A/m; Probe Modulation Factor = 4.46

Device Reference Point: 0.000, 0.000, -6.30 mm; Reference Value = 0.070 A/m; Power Drift = 0.038 dB

Hearing Aid Near-Field Category: **M4 (AWF 0 dB)**

Peak H-field in A/m

Grid 1 0.566 M4	Grid 2 0.455 M4	Grid 3 0.281 M4
Grid 4 0.531 M4	Grid 5 0.417 M4	Grid 6 0.271 M4
Grid 7 0.530 M4	Grid 8 0.419 M4	Grid 9 0.259 M4

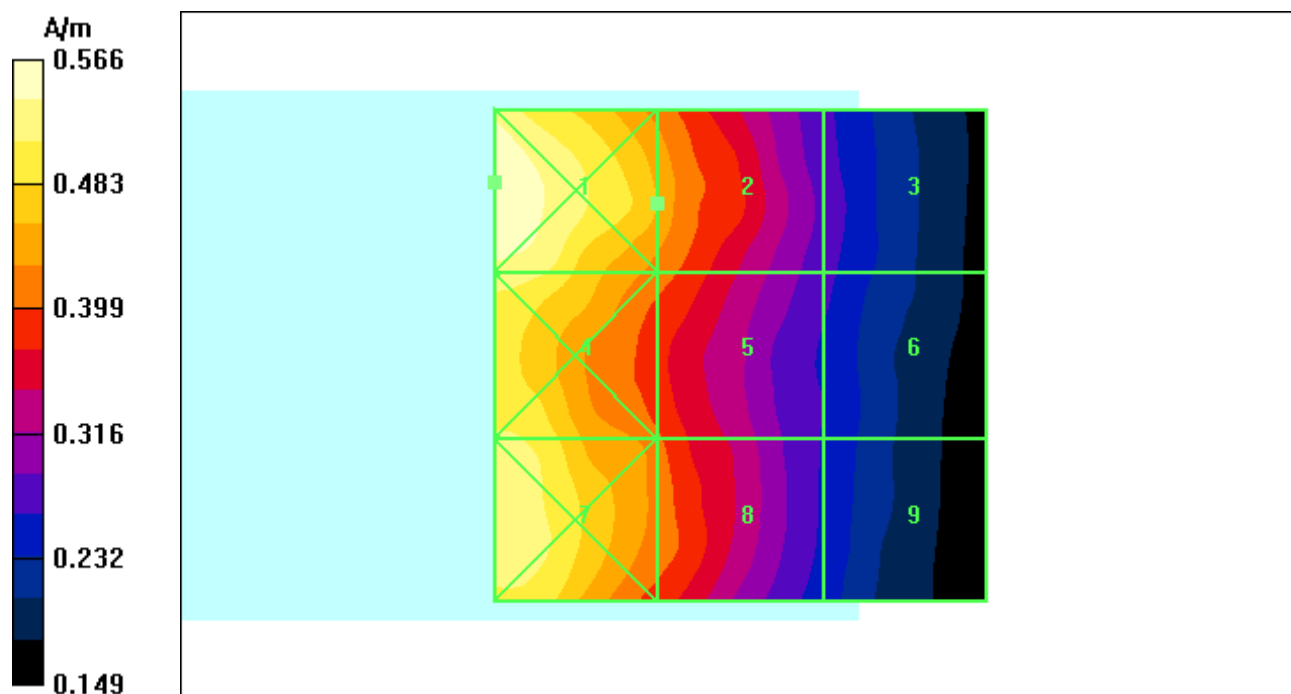

Appendix 4
Measurement Uncertainty Budget

A4.1 Motorola Uncertainty Budget for RF HAC Testing

TABLE A4.1: Motorola Uncertainty Budget

UNCERTAINTY DESCRIPTION	Uncertainty Value (+/- %)	Prob . Dist.	Div.	(ci) E	(ci) H	Std. Unc. E	Std. Unc. H
MEASUREMENT SYSTEM							
Probe Calibration	5.1%	N	1.0000	1	1	5.1%	5.1%
Axial Isotropy	7.8%	R	1.7321	1	0.786	4.5%	3.5%
Sensor Displacement	16.5%	R	1.7321	1	0.145	9.5%	1.4%
Test Arch	7.2%	R	1.7321	1	0	4.2%	0.0%
Linearity	4.7%	R	1.7321	1	1	2.7%	2.7%
Scaling to Peak Envelope Power	2.0%	R	1.7321	1	1	1.2%	1.2%
System Detection Limit	1.0%	R	1.7321	1	1	0.6%	0.6%
Readout Electronics	0.3%	N	1.0000	1	1	0.3%	0.3%
Response Time	0.8%	R	1.7321	1	1	0.5%	0.5%
Integration Time	2.6%	R	1.7321	1	1	1.5%	1.5%
RF Reflections	5.6%	R	1.7321	1	1	3.2%	3.2%
Probe Positioner	1.2%	R	1.7321	1	0.67	0.7%	0.5%
Probe Positioning	4.7%	R	1.7321	1	0.67	2.7%	1.8%
Extrap. & Interpolation	1.0%	R	1.7321	1	1	0.6%	0.6%
TEST SAMPLE RELATED							
Total Device Positioning	3.2%	R	1.7321	1	1.306	1.8%	2.4%
Device Holder & Phantom	2.4%	R	1.7321	1	1	1.4%	1.4%
Power Drift	5.0%	R	1.7321	1	1	2.9%	2.9%
PHANTOM AND SETUP RELATED							
Phantom Thickness	2.4%	R	1.7321	1	0.67	1.4%	0.9%
Combined Std.Uncertainty on Power						14.1%	9.1%
Combined Std.Uncertainty on Field						7.1%	4.6%
Expanded Std. Uncertainty on Power						28.3%	18.2%
Expanded Std. Uncertainty on Field						14.1%	9.1%

A4.2 Probe Rotation Contributions to Isotropy Error

Probe rotation data was taken “for special focus on spherical isotropicity in measurement uncertainty and perturbation of EM fields.” This data was taken at the interpolated maximum and directly accounted for in the uncertainty budget as “Axial Isotropy.” Thirteen mobile devices were used to determine the probe isotropy uncertainty factors in section A4.1. Based on the resulting 82 E-Field probe rotations and 82 H-Field probe rotations, the upper 95% confidence interval value was calculated for each. These values represent a conservative assessment of the effect of the probe isotropy and have been appropriately included in the respective E- and H-uncertainty budgets.

TABLE A4.2: Probe Rotation Data Summary

	AVE	ST.DE V	Sample Size (n)	2σ	(ci)	Standard Uncertainty
E-field	4.4%	1.7%	82	7.8%	1	4.5%
H-field	3.8%	1.2%	82	6.1%	0.786	3.5%

Isotropy error measurements were taken for 13 products across the respective frequency bands. The +2σ values of all measurements was used as a worst case value for the uncertainty budget. Any significant differences between bands were also evaluated.

Appendix 5
Pictures of Test Setup

See Exhibit 7B

Appendix 6
Probe Calibration Certificates



Accredited by the Swiss Accreditation Service (SAS)
The Swiss Accreditation Service is one of the signatories to the EA
Multilateral Agreement for the recognition of calibration certificates

Accreditation No.: **SCS 108**

Client **Motorola MDb**

Certificate No: **ER3-2244_Sep08**

CALIBRATION CERTIFICATE

Object: **ER3DV6R - SN:2244**

Calibration procedure(s): **QA CAL-02.v5
Calibration procedure for E-field probes optimized for close near field
evaluations in air**

Calibration date: **September 22, 2008**

Condition of the calibrated item: **In Tolerance**

This calibration certificate documents the traceability to national standards, which realize the physical units of measurements (SI).
The measurements and the uncertainties with confidence probability are given on the following pages and are part of the certificate.

All calibrations have been conducted in the closed laboratory facility: environment temperature (22 ± 3)°C and humidity < 70%.

Calibration Equipment used (M&TE critical for calibration)

Primary Standards	ID #	Cal Date (Certificate No.)	Scheduled Calibration
Power meter E4419B	GB41293874	1-Apr-08 (No. 217-00788)	Apr-09
Power sensor E4412A	MY41495277	1-Apr-08 (No. 217-00788)	Apr-09
Power sensor E4412A	MY41498087	1-Apr-08 (No. 217-00788)	Apr-09
Reference 3 dB Attenuator	SN: S5054 (3c)	1-Jul-08 (No. 217-00865)	Jul-09
Reference 20 dB Attenuator	SN: S5086 (20b)	31-Mar-08 (No. 217-00787)	Apr-09
Reference 30 dB Attenuator	SN: S5129 (30b)	1-Jul-08 (No. 217-00866)	Jul-09
Reference Probe ER3DV6	SN: 2328	2-Oct-07 (No. ER3-2328_Oct07)	Oct-08
DAE4	SN: 789	5-Dec-07 (No. DAE4-789_Dec07)	Dec-08
Secondary Standards	ID #	Check Date (in house)	Scheduled Check
RF generator HP 8648C	US3642U01700	4-Aug-99 (in house check Oct-07)	In house check: Oct-09
Network Analyzer HP 8753E	US37390585	18-Oct-01 (in house check Oct-07)	In house check: Oct-08

	Name	Function	Signature
Calibrated by:	Katja Pokovic	Technical Manager	
Approved by:	Niels Kuster	Quality Manager	

Issued: September 22, 2008

This calibration certificate shall not be reproduced except in full without written approval of the laboratory.



Accredited by the Swiss Accreditation Service (SAS)
The Swiss Accreditation Service is one of the signatories to the EA
Multilateral Agreement for the recognition of calibration certificates

Accreditation No.: **SCS 108**

Glossary:

NORM _{x,y,z}	sensitivity in free space
DCP	diode compression point
Polarization φ	φ rotation around probe axis
Polarization ϑ	ϑ rotation around an axis that is in the plane normal to probe axis (at measurement center), i.e., $\vartheta = 0$ is normal to probe axis
Connector Angle	information used in DASY system to align probe sensor X to the robot coordinate system

Calibration is Performed According to the Following Standards:

- a) IEEE Std 1309-2005, " IEEE Standard for calibration of electromagnetic field sensors and probes, excluding antennas, from 9 kHz to 40 GHz", December 2005.

Methods Applied and Interpretation of Parameters:

- *NORM_{x,y,z}*: Assessed for E-field polarization $\vartheta = 0$ for XY sensors and $\vartheta = 90$ for Z sensor ($f \leq 900$ MHz in TEM-cell; $f > 1800$ MHz: R22 waveguide).
- *NORM(f)_{x,y,z}* = *NORM_{x,y,z}* * *frequency_response* (see Frequency Response Chart).
- *DCP_{x,y,z}*: DCP are numerical linearization parameters assessed based on the data of power sweep (no uncertainty required). DCP does not depend on frequency.
- *Spherical isotropy (3D deviation from isotropy)*: in a locally homogeneous field realized using an open waveguide setup.
- *Sensor Offset*: The sensor offset corresponds to the offset of virtual measurement center from the probe tip (on probe axis). No tolerance required.
- *Connector Angle*: The angle is assessed using the information gained by determining the *NORM_x* (no uncertainty required).

Probe ER3DV6R

SN:2244

Manufactured:	February 1, 2000
Last calibrated:	July 12, 2007
Recalibrated:	September 22, 2008

Calibrated for DASY Systems

(Note: non-compatible with DASY2 system!)

DASY - Parameters of Probe: ER3DV6R SN:2244Sensitivity in Free Space [$\mu\text{V}/(\text{V}/\text{m})^2$]

NormX	1.83 \pm 10.1 % (k=2)
NormY	1.85 \pm 10.1 % (k=2)
NormZ	2.04 \pm 10.1 % (k=2)

Diode Compression^A

DCP X	95 mV
DCP Y	94 mV
DCP Z	97 mV

Frequency Correction

X	0.0
Y	0.0
Z	0.0

Sensor Offset

(Probe Tip to Sensor Center)

X	2.5 mm
Y	2.5 mm
Z	2.5 mm

Connector Angle

25 °

The reported uncertainty of measurement is stated as the standard uncertainty of measurement multiplied by the coverage factor k=2, which for a normal distribution corresponds to a coverage probability of approximately 95%.

^A numerical linearization parameter: uncertainty not required

Frequency Response of E-Field

(TEM-Cell:ifi110 EXX, Waveguide R22)

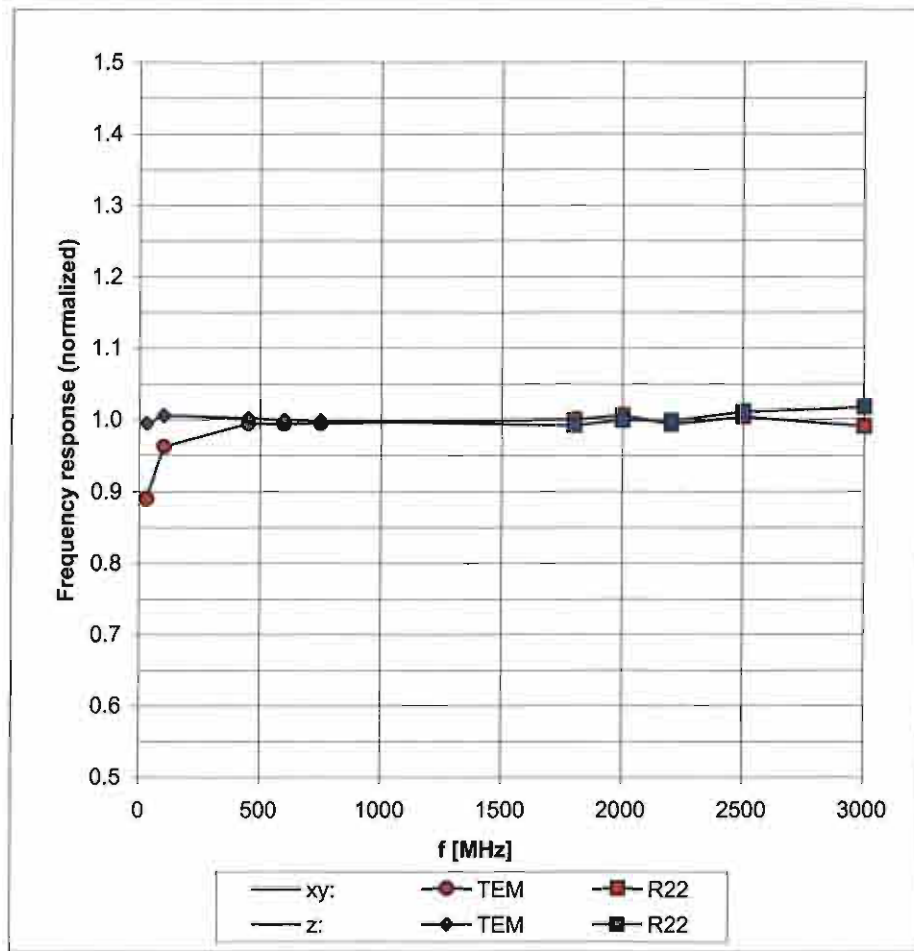

Uncertainty of Frequency Response of E-field: $\pm 6.3\%$ (k=2)

Receiving Pattern (ϕ), $\vartheta = 0^\circ$

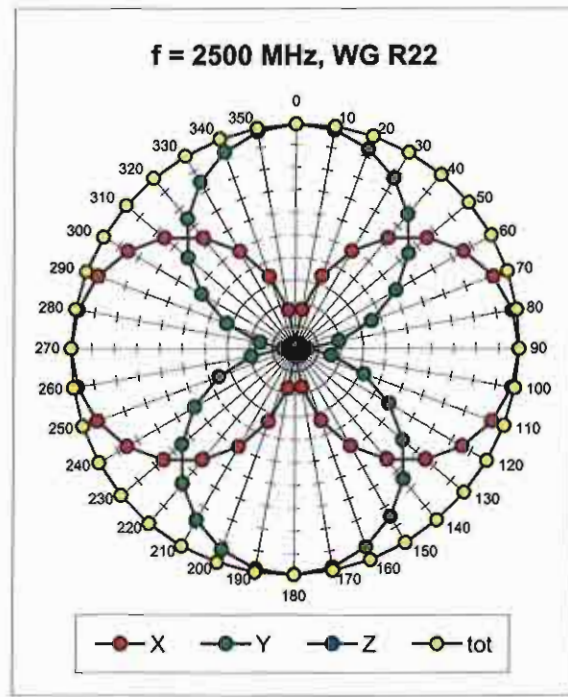
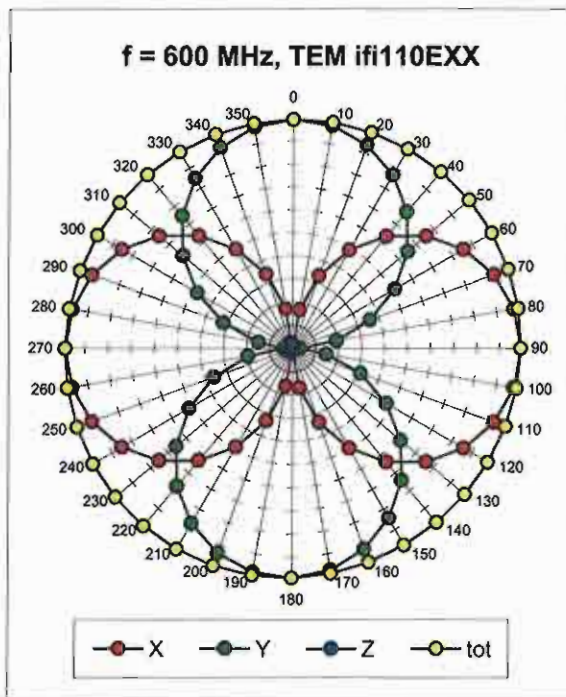

Receiving Pattern (ϕ), $\vartheta = 90^\circ$

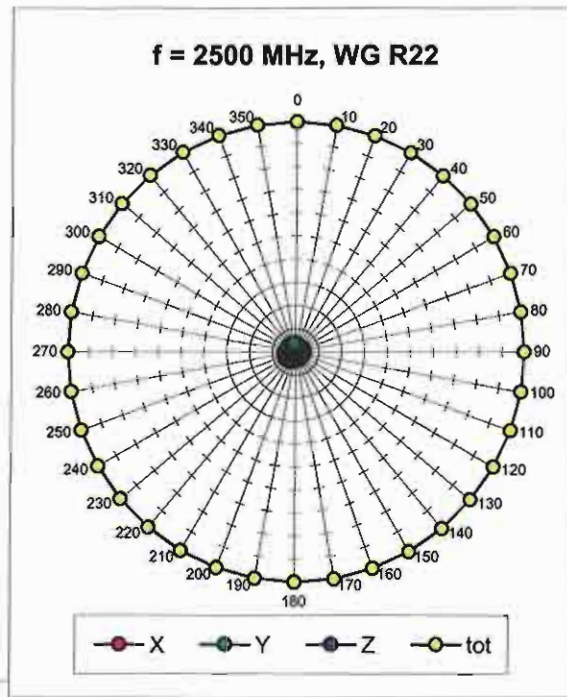
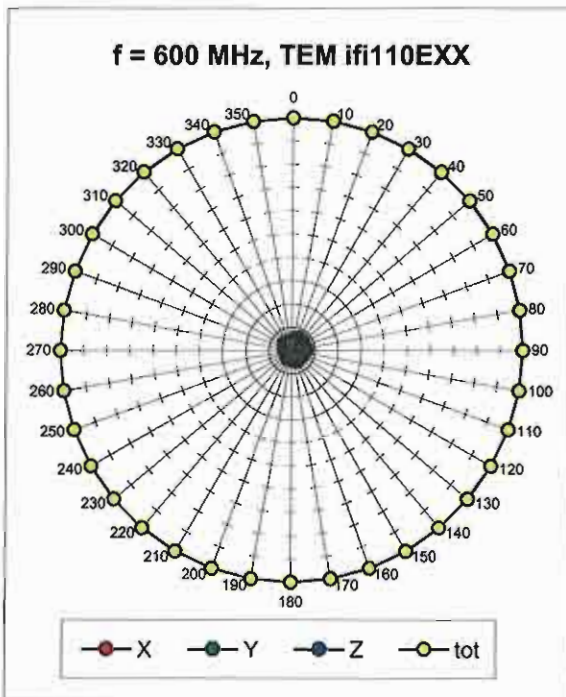

Receiving Pattern (ϕ), $\vartheta = 0^\circ$

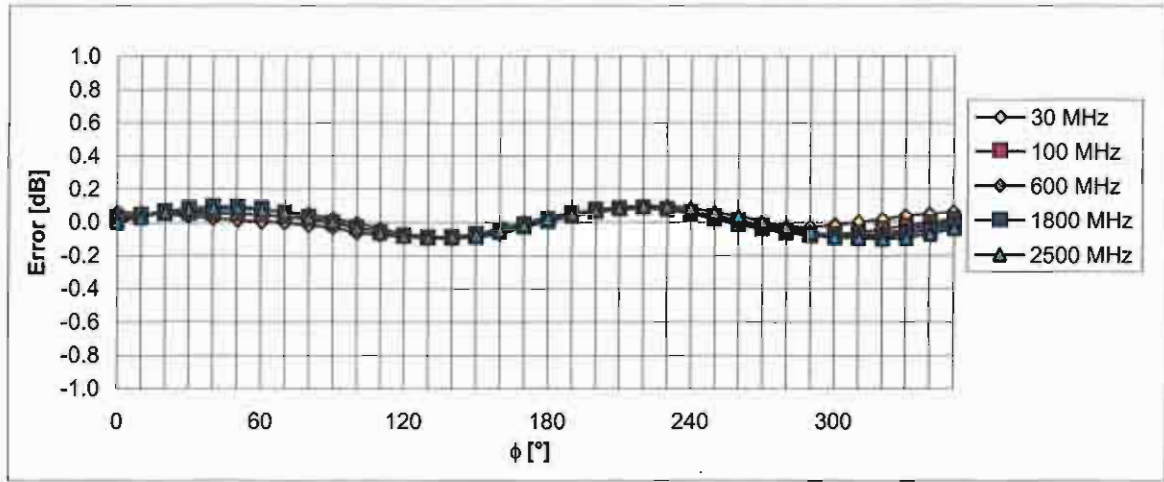

Uncertainty of Axial Isotropy Assessment: $\pm 0.5\%$ (k=2)

Receiving Pattern (ϕ), $\vartheta = 90^\circ$

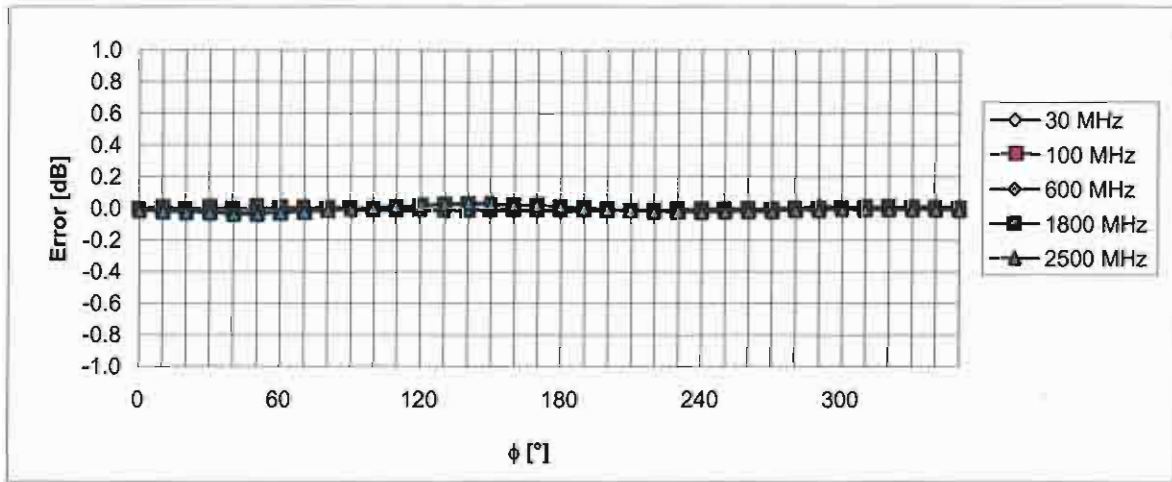

Uncertainty of Axial Isotropy Assessment: $\pm 0.5\%$ (k=2)

Dynamic Range f(E-field) (Waveguide R22, f = 1800 MHz)

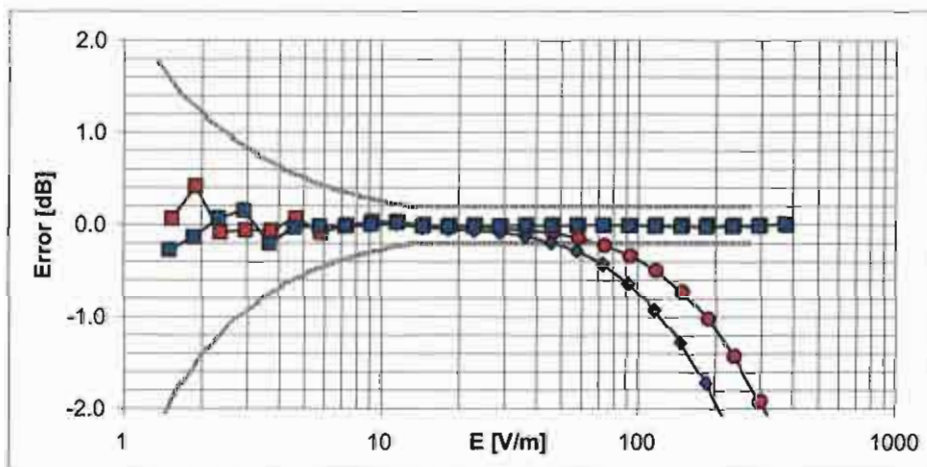
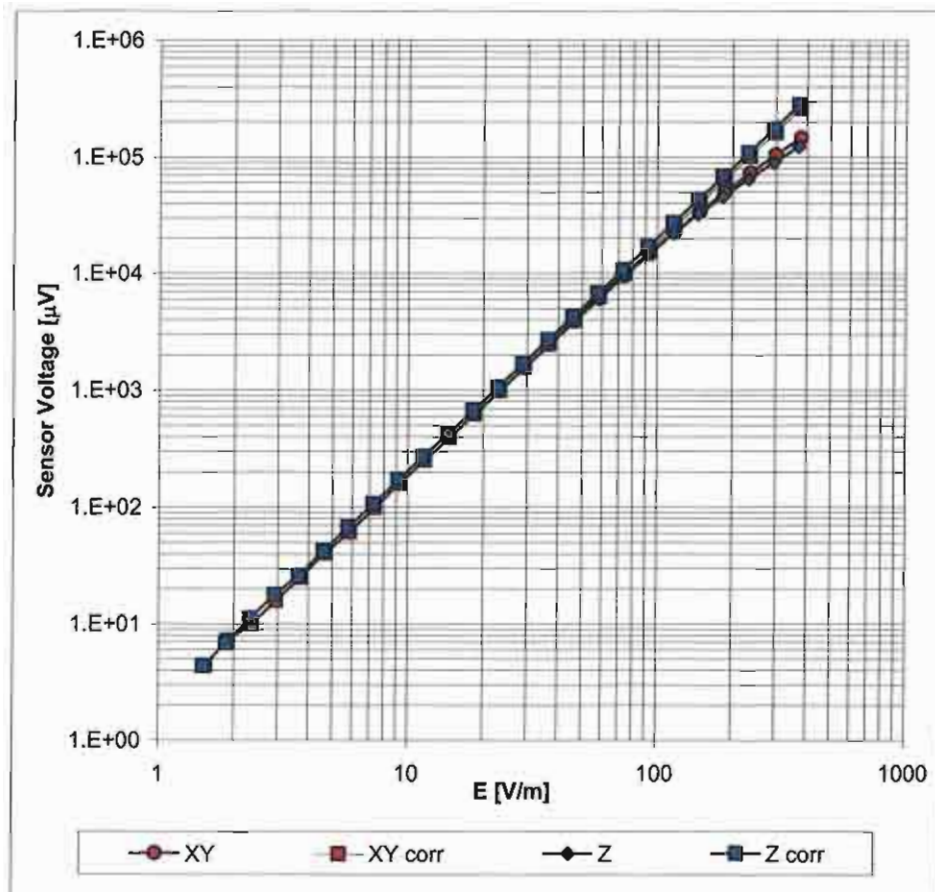

Uncertainty of Linearity Assessment: $\pm 0.6\%$ ($k=2$)

Deviation from Isotropy in Air Error (ϕ, ϑ), $f = 900$ MHz

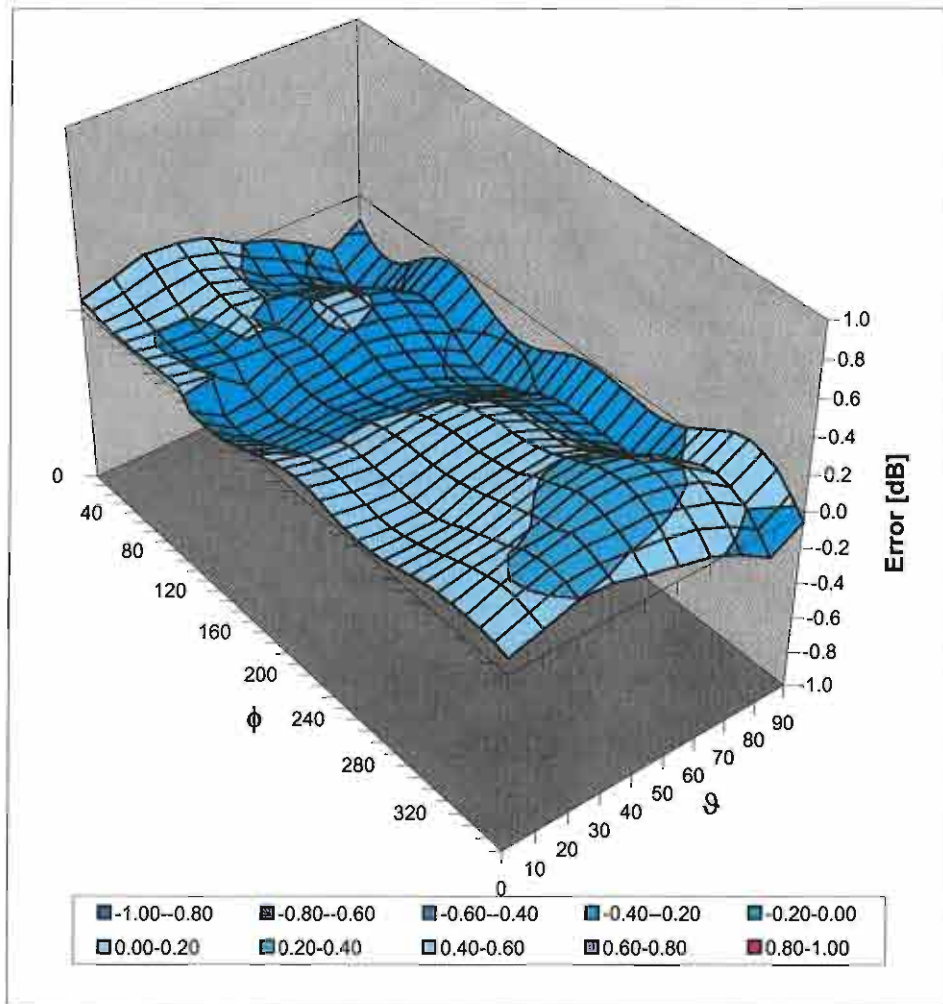

Uncertainty of Spherical Isotropy Assessment: $\pm 2.6\%$ ($k=2$)



Accredited by the Swiss Accreditation Service (SAS)
The Swiss Accreditation Service is one of the signatories to the EA
Multilateral Agreement for the recognition of calibration certificates

Accreditation No.: **SCS 108**

Client **Motorola MDb**

Certificate No: **H3-6078_Sep08**

CALIBRATION CERTIFICATE

Object: **H3DV6 - SN:6078**

Calibration procedure(s): **QA CAL-03.v5
Calibration procedure for H-field probes optimized for close near field
evaluations in air**

Calibration date: **September 22, 2008**

Condition of the calibrated item: **In Tolerance**

This calibration certificate documents the traceability to national standards, which realize the physical units of measurements (SI).
The measurements and the uncertainties with confidence probability are given on the following pages and are part of the certificate.

All calibrations have been conducted in the closed laboratory facility: environment temperature (22 ± 3)°C and humidity < 70%.

Calibration Equipment used (M&TE critical for calibration)

Primary Standards	ID #	Cal Date (Certificate No.)	Scheduled Calibration
Power meter E4419B	GB41293874	1-Apr-08 (No. 217-00788)	Apr-09
Power sensor E4412A	MY41495277	1-Apr-08 (No. 217-00788)	Apr-09
Power sensor E4412A	MY41498087	1-Apr-08 (No. 217-00788)	Apr-09
Reference 3 dB Attenuator	SN: S5054 (3c)	1-Jul-08 (No. 217-00865)	Jul-09
Reference 20 dB Attenuator	SN: S5086 (20b)	31-Mar-08 (No. 217-00787)	Apr-09
Reference 30 dB Attenuator	SN: S5129 (30b)	1-Jul-08 (No. 217-00866)	Jul-09
Reference Probe H3DV6	SN: 6182	2-Oct-07 (No. H3-6182_Oct07)	Oct-08
DAE4	SN: 789	5-Dec-07 (No. DAE4-789_Dec07)	Dec-08
Secondary Standards	ID #	Check Date (in house)	Scheduled Check
RF generator HP 8648C	US3642U01700	4-Aug-99 (in house check Oct-07)	In house check: Oct-09
Network Analyzer HP 8753E	US37390585	18-Oct-01 (in house check Oct-07)	In house check: Oct-08

Calibrated by: **Katja Polovic** (Name) / **Technical Manager** (Function) /  (Signature)

Approved by: **Niels Kuster** (Name) / **Quality Manager** (Function) /  (Signature)

Issued: September 22, 2008

This calibration certificate shall not be reproduced except in full without written approval of the laboratory.



Accredited by the Swiss Accreditation Service (SAS)
The Swiss Accreditation Service is one of the signatories to the EA
Multilateral Agreement for the recognition of calibration certificates

Accreditation No.: **SCS 108**

Glossary:

NORM _{x,y,z}	sensitivity in free space
DCP	diode compression point
Polarization φ	φ rotation around probe axis
Polarization ϑ	ϑ rotation around an axis that is in the plane normal to probe axis (at measurement center), i.e., $\vartheta = 0$ is normal to probe axis
Connector Angle	information used in DASY system to align probe sensor X to the robot coordinate system

Calibration is Performed According to the Following Standards:

- a) IEEE Std 1309-2005, "IEEE Standard for calibration of electromagnetic field sensors and probes, excluding antennas, from 9 kHz to 40 GHz", December 2005.

Methods Applied and Interpretation of Parameters:

- X, Y, Z_{a0a1a2} : Assessed for E-field polarization $\vartheta = 90$ for XY sensors and $\vartheta = 0$ for Z sensor ($f \leq 900$ MHz in TEM-cell; $f > 1800$ MHz: R22 waveguide).
- $X, Y, Z(f)_{a0a1a2} = X, Y, Z_{a0a1a2} * \text{frequency_response}$ (see Frequency Response Chart).
- $DCP_{x,y,z}$: DCP are numerical linearization parameters assessed based on the data of power sweep (no uncertainty required). DCP does not depend on frequency.
- *Spherical isotropy (3D deviation from isotropy)*: in a locally homogeneous field realized using an open waveguide setup.
- *Sensor Offset*: The sensor offset corresponds to the offset of virtual measurement center from the probe tip (on probe axis). No tolerance required.
- *Connector Angle*: The angle is assessed using the information gained by determining the X_{a0a1a2} (no uncertainty required).

Probe H3DV6

SN:6078

Manufactured:	October 2, 2000
Last calibrated:	July 12, 2007
Recalibrated:	September 22, 2008

Calibrated for DASY Systems

(Note: non-compatible with DASY2 system!)

DASY - Parameters of Probe: H3DV6 SN:6078Sensitivity in Free Space [A/m / $\sqrt{(\mu\text{V})}$]

	a0	a1	a2
X	2.834E-03	-2.604E-4	4.575E-5 \pm 5.1 % (k=2)
Y	2.736E-03	-1.824E-4	2.098E-5 \pm 5.1 % (k=2)
Z	3.107E-03	-2.976E-4	8.980E-6 \pm 5.1 % (k=2)

Diode Compression¹

DCP X	83 mV
DCP Y	89 mV
DCP Z	82 mV

Sensor Offset (Probe Tip to Sensor Center)

X	3.0 mm
Y	3.0 mm
Z	3.0 mm

Connector Angle -220 °

The reported uncertainty of measurement is stated as the standard uncertainty of measurement multiplied by the coverage factor k=2, which for a normal distribution corresponds to a coverage probability of approximately 95%.

¹ numerical linearization parameter: uncertainty not required

Frequency Response of H-Field

(TEM-Cell:ifi110 EXX, Waveguide R22)

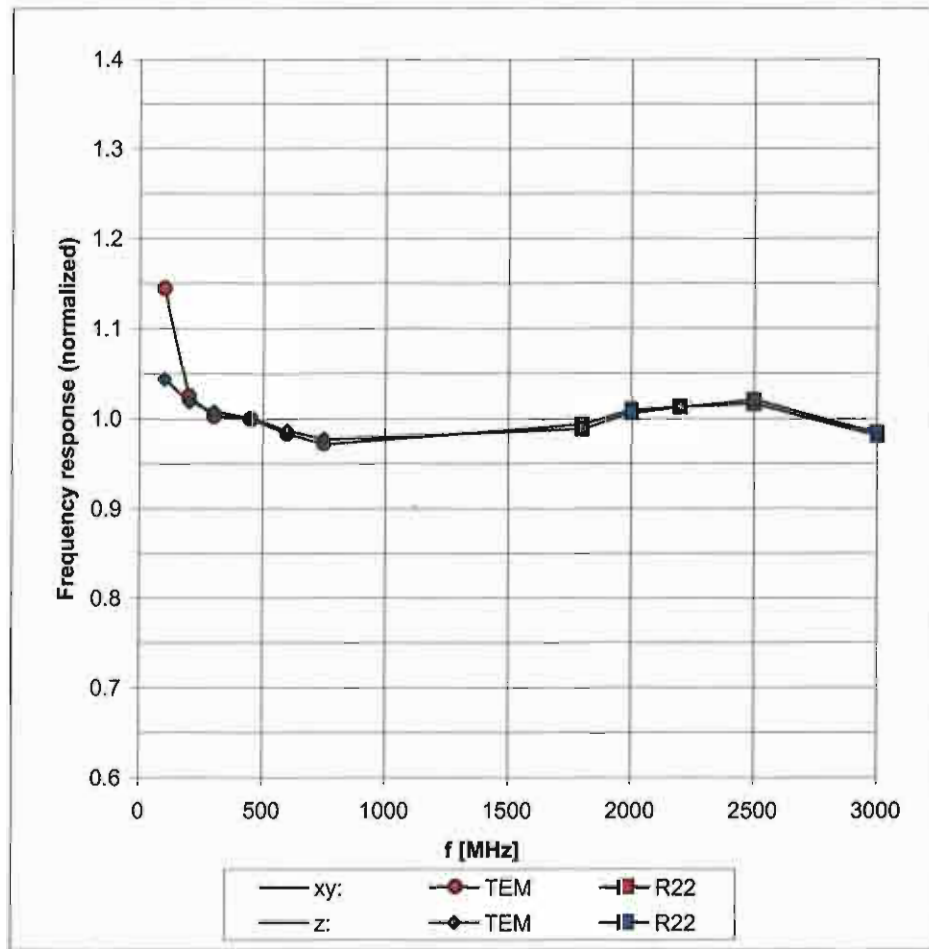

Uncertainty of Frequency Response of E-field: $\pm 6.3\%$ (k=2)

Receiving Pattern (ϕ), $\vartheta = 90^\circ$

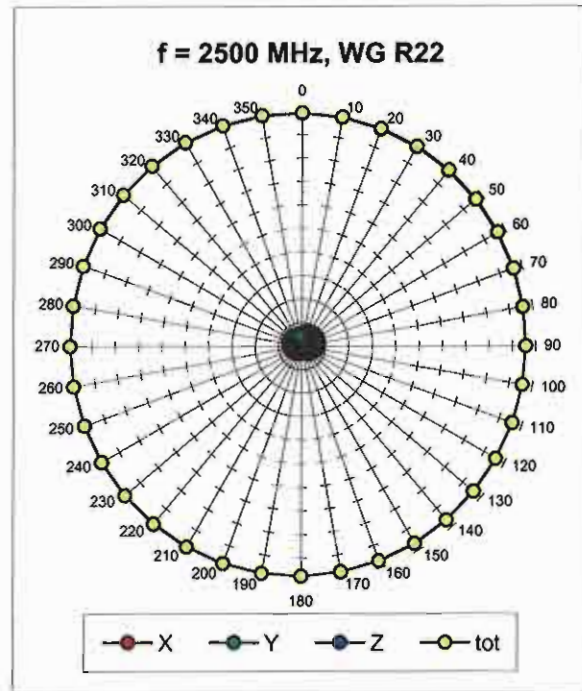
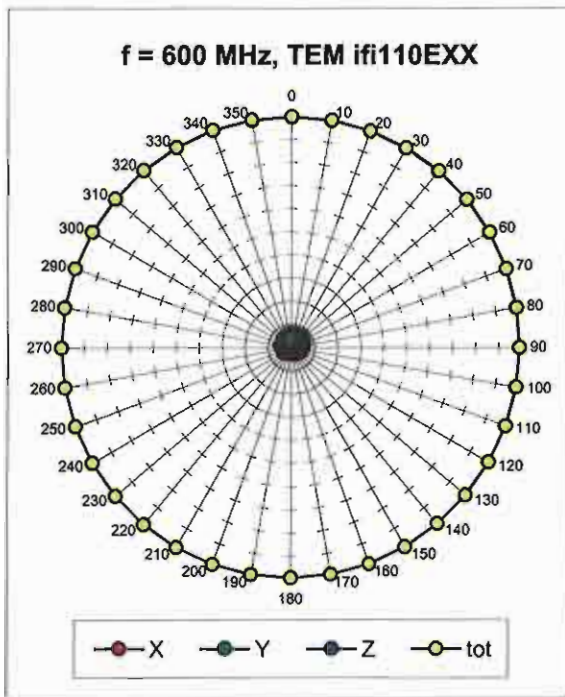

Receiving Pattern (ϕ), $\vartheta = 0^\circ$

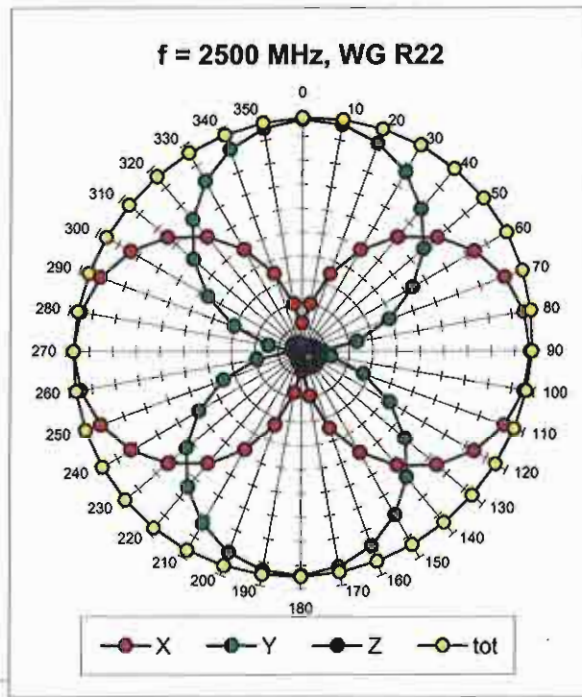
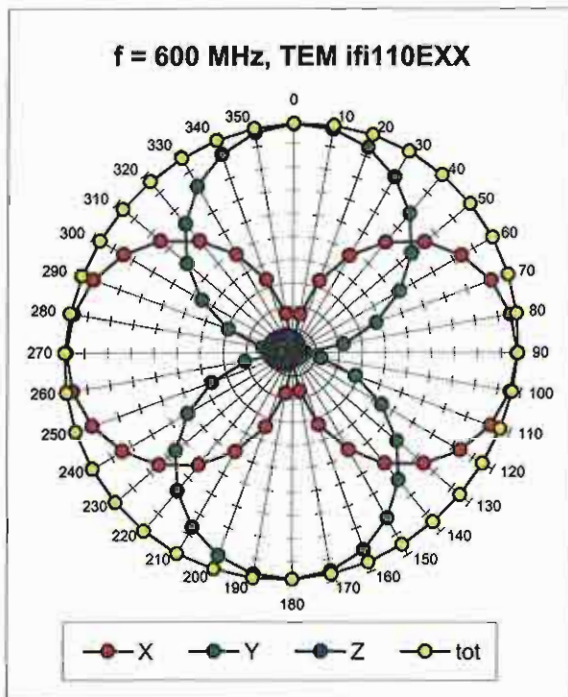

Receiving Pattern (ϕ), $\vartheta = 90^\circ$

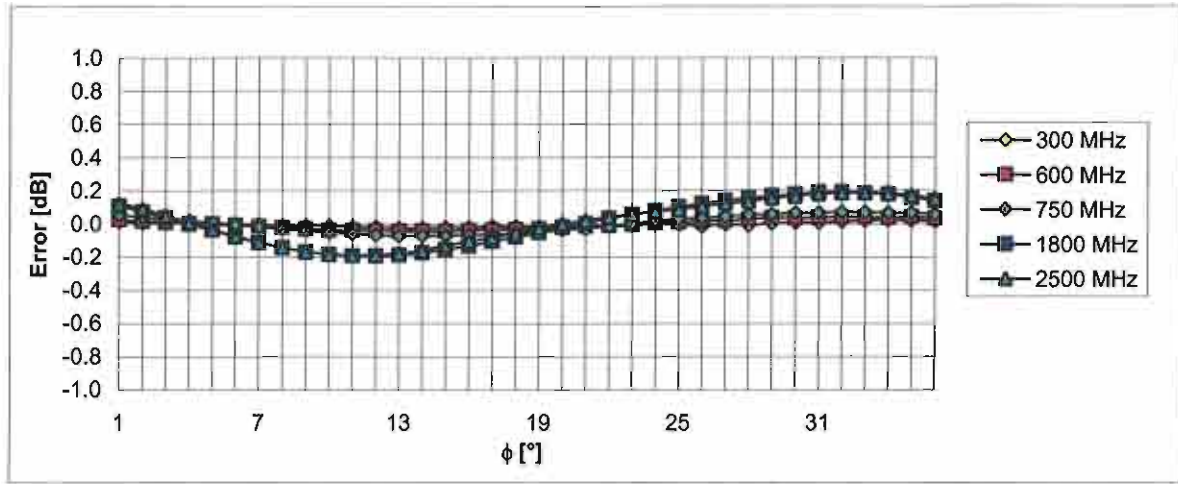

Uncertainty of Axial Isotropy Assessment: $\pm 0.5\%$ (k=2)

Receiving Pattern (ϕ), $\vartheta = 0^\circ$

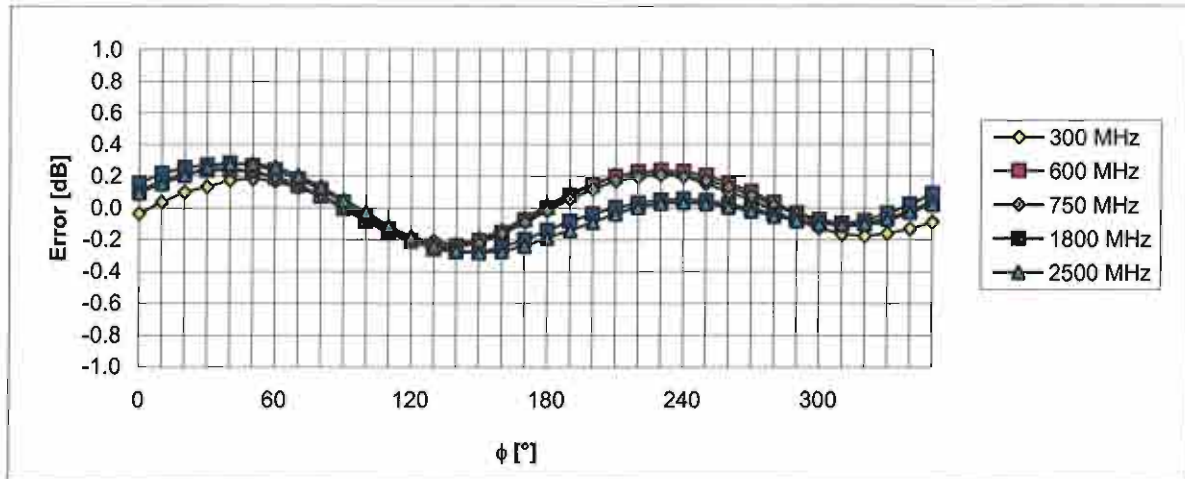

Uncertainty of Axial Isotropy Assessment: $\pm 0.5\%$ (k=2)

Dynamic Range f(H-field) (Waveguide R22, f = 1800 MHz)

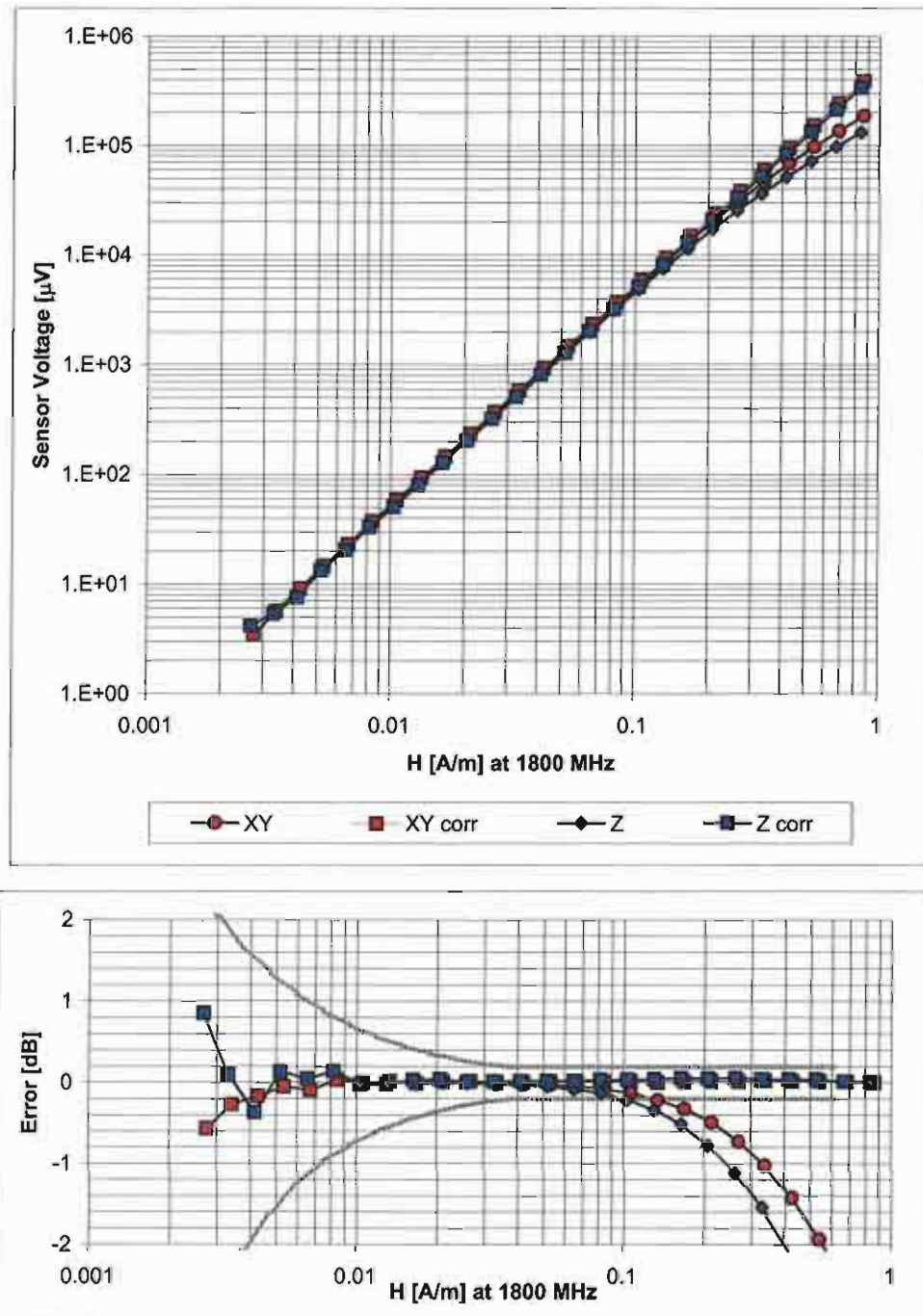

Uncertainty of Linearity Assessment: ± 0.6% (k=2)

Deviation from Isotropy in Air Error (ϕ, ϑ), $f = 900$ MHz

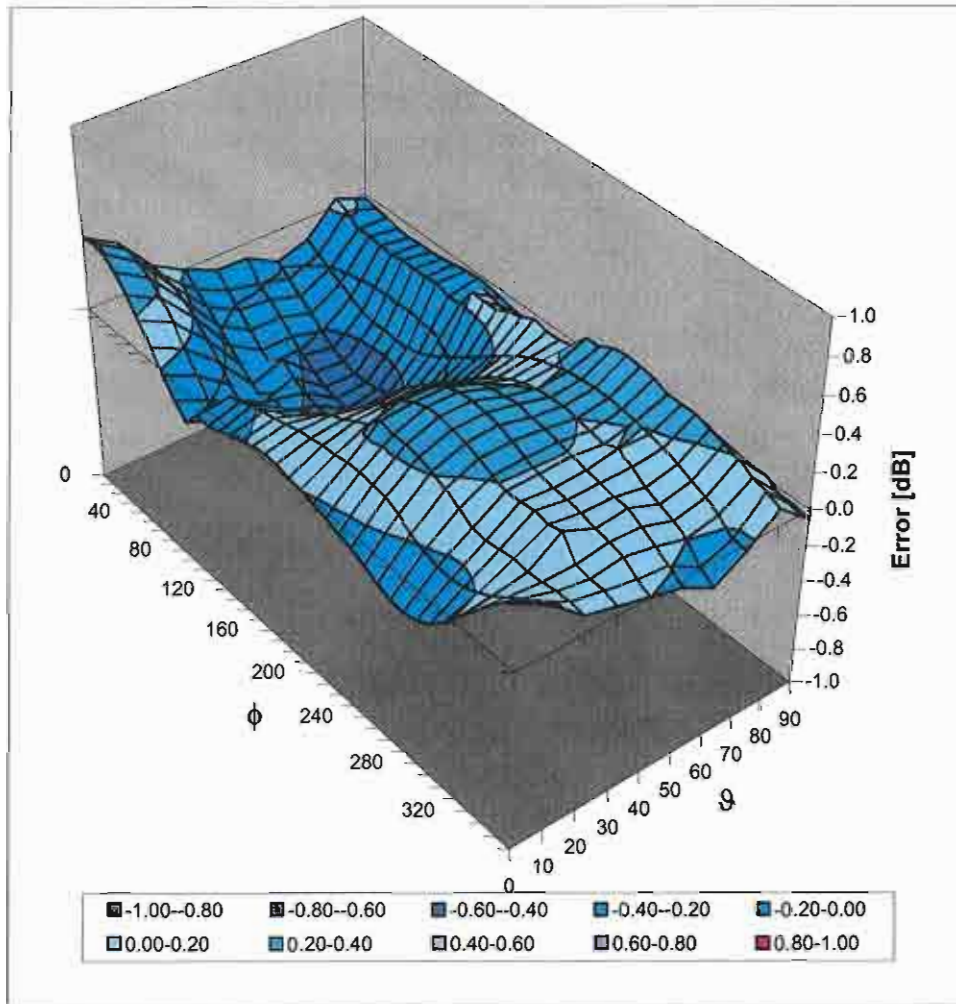

Uncertainty of Spherical Isotropy Assessment: $\pm 2.6\%$ ($k=2$)

Appendix 7

Dipole Characterization Certificate



Accredited by the Swiss Accreditation Service (SAS)
The Swiss Accreditation Service is one of the signatories to the EA
Multilateral Agreement for the recognition of calibration certificates

Accreditation No.: **SCS 108**

Client **Motorola MDB**

Certificate No: **CD835V3-1076_Mar08**

CALIBRATION CERTIFICATE

Object **CD835V3 - SN: 1076**

Calibration procedure(s) **QA CAL-20.v4
Calibration procedure for dipoles in air**

Calibration date: **March 11, 2008**

Condition of the calibrated item **In Tolerance**

This calibration certificate documents the traceability to national standards, which realize the physical units of measurements (SI).
All calibrations have been conducted in the closed laboratory facility: environment temperature (22 ± 3)°C and humidity < 70%.

Calibration Equipment used (M&TE critical for calibration)

Primary Standards	ID #	Cal Date (Calibrated by, Certificate No.)	Scheduled Calibration
Power meter EPM-442A	GB37480704	04-Oct-07 (METAS, No. 217-00736)	Oct-08
Power sensor HP 8481A	US37292783	04-Oct-07 (METAS, No. 217-00736)	Oct-08
Probe ER3DV6	SN: 2336	31-Dec-07 (SPEAG, No. ER3-2336_Dec07)	Dec-08
Probe H3DV6	SN: 6065	31-Dec-07 (SPEAG, No. H3-6065_-Dec07)	Dec-08
DAE4	SN: 781	2-Oct-07 (SPEAG, No. DAE4-781_Oct07)	Oct-08

Secondary Standards	ID #	Check Date (in house)	Scheduled Check
Power meter EPM-4419B	GB42420191	11-May-05 (SPEAG, in house check Oct -07)	In house check: Nov-08
Power sensor HP 8482A	US37295597	11-May-05 (SPEAG, in house check Oct -07)	In house check: Nov-08
Power sensor HP 8482H	3318A09450	08-Jan-02 (SPEAG, in house check Oct -07)	In house check: Nov-08
Network Analyzer HP 8753E	US37390585	18-Oct-01 (SPEAG, in house check Oct-07)	In house check: Nov-09
RF generator E4433B	MY 41310391	22-Nov-04 (SPEAG, in house check Oct-07)	In house check: Nov-09

	Name	Function	Signature
Calibrated by:	Mike Meill	Laboratory Technician	<i>M. Meill</i>
Approved by:	Fin Bomholt	Technical Director	<i>F. Bomholt</i>

Issued: March 13, 2008

This calibration certificate shall not be reproduced except in full without written approval of the laboratory.



Accredited by the Swiss Accreditation Service (SAS)
The Swiss Accreditation Service is one of the signatories to the EA
Multilateral Agreement for the recognition of calibration certificates

Accreditation No.: **SCS 108**

References

- [1] ANSI-C63.19-2006
American National Standard for Methods of Measurement of Compatibility between Wireless Communications Devices and Hearing Aids.

Methods Applied and Interpretation of Parameters:

- *Coordinate System:* y-axis is in the direction of the dipole arms. z-axis is from the basis of the antenna (mounted on the table) towards its feed point between the two dipole arms. x-axis is normal to the other axes. In coincidence with standard [1], the measurement planes (probe sensor center) are selected to be at a distance of 10 mm above the top edge of the dipole arms.
- *Measurement Conditions:* Further details are available from the hardcopies at the end of the certificate. All figures stated in the certificate are valid at the frequency indicated. The forward power to the dipole connector is set with a calibrated power meter connected and monitored with an auxiliary power meter connected to a directional coupler. While the dipole under test is connected, the forward power is adjusted to the same level.
- *Antenna Positioning:* The dipole is mounted on a HAC Test Arch phantom using the matching dipole positioner with the arms horizontal and the feeding cable coming from the floor. The measurements are performed in a shielded room with absorbers around the setup to reduce the reflections. It is verified before the mounting of the dipole under the Test Arch phantom, that its arms are perfectly in a line. It is installed on the HAC dipole positioner with its arms parallel below the dielectric reference wire and able to move elastically in vertical direction without changing its relative position to the top center of the Test Arch phantom. The vertical distance to the probe is adjusted after dipole mounting with a DASY4 Surface Check job. Before the measurement, the distance between phantom surface and probe tip is verified. The proper measurement distance is selected by choosing the matching section of the HAC Test Arch phantom with the proper device reference point (upper surface of the dipole) and the matching grid reference point (tip of the probe) considering the probe sensor offset. The vertical distance to the probe is essential for the accuracy.
- *Feed Point Impedance and Return Loss:* These parameters are measured using a HP 8753E Vector Network Analyzer. The impedance is specified at the SMA connector of the dipole. The influence of reflections was eliminated by applying the averaging function while moving the dipole in the air, at least 70cm away from any obstacles.
- *E-field distribution:* E field is measured in the x-y-plane with an isotropic ER3D-field probe with 100 mW forward power to the antenna feed point. In accordance with [1], the scan area is 20mm wide, its length exceeds the dipole arm length (180 or 90mm). The sensor center is 10 mm (in z) above the top of the dipole arms. Two 3D maxima are available near the end of the dipole arms. Assuming the dipole arms are perfectly in one line, the average of these two maxima (in subgrid 2 and subgrid 8) is determined to compensate for any non-parallelity to the measurement plane as well as the sensor displacement. The E-field value stated as calibration value represents the maximum of the interpolated 3D-E-field, 10mm above the dipole surface.
- *H-field distribution:* H-field is measured with an isotropic H-field probe with 100mW forward power to the antenna feed point, in the x-y-plane. The scan area and sensor distance is equivalent to the E-field scan. The maximum of the field is available at the center (subgrid 5) above the feed point. The H-field value stated as calibration value represents the maximum of the interpolated H-field, 10mm above the dipole surface at the feed point.

1 Measurement Conditions

DASY system configuration, as far as not given on page 1.

DASY Version	DASY4	V4.7 B61
DASY PP Version	SEMCAD	V1.8 B176
Phantom	HAC Test Arch	SD HAC P01 BA, #1070
Distance Dipole Top - Probe Center	10 mm	
Scan resolution	dx, dy = 5 mm	area = 20 x 180 mm
Frequency	835 MHz ± 1 MHz	
Forward power at dipole connector	20.0 dBm = 100mW	
Input power drift	< 0.05 dB	

2 Maximum Field values

H-field 10 mm above dipole surface	condition	interpolated maximum
Maximum measured	100 mW forward power	0.445 A/m

Uncertainty for H-field measurement: 8.2% (k=2)

E-field 10 mm above dipole surface	condition	Interpolated maximum
Maximum measured above high end-	100 mW forward power	160.4 V/m
Maximum measured above low end	100 mW forward power	157.6 V/m
Averaged maximum above arm	100 mW forward power	159.0 V/m

Uncertainty for E-field measurement: 12.8% (k=2)

3 Appendix

3.1 Antenna Parameters

Frequency	Return Loss	Impedance
800 MHz	16.7 dB	(42.7 – j11.6) Ohm
835 MHz	23.9 dB	(47.0 + j5.4) Ohm
900 MHz	18.6 dB	(58.8 – j9.4) Ohm
950 MHz	19.2 dB	(51.4 + j11.1) Ohm
960 MHz	14.0 dB	(60.4 + j19.7) Ohm

3.2 Antenna Design and Handling

The calibration dipole has a symmetric geometry with a built-in two stub matching network, which leads to the enhanced bandwidth.

The dipole is built of standard semirigid coaxial cable. The internal matching line is open ended. The antenna is therefore open for DC signals.

Do not apply force to dipole arms, as they are liable to bend. The soldered connections near the feedpoint may be damaged. After excessive mechanical stress or overheating, check the impedance characteristics to ensure that the internal matching network is not affected.

After long term use with 40W radiated power, only a slight warming of the dipole near the feedpoint can be measured.

3.3 Measurement Sheets

3.3.1 Return Loss and Smith Chart

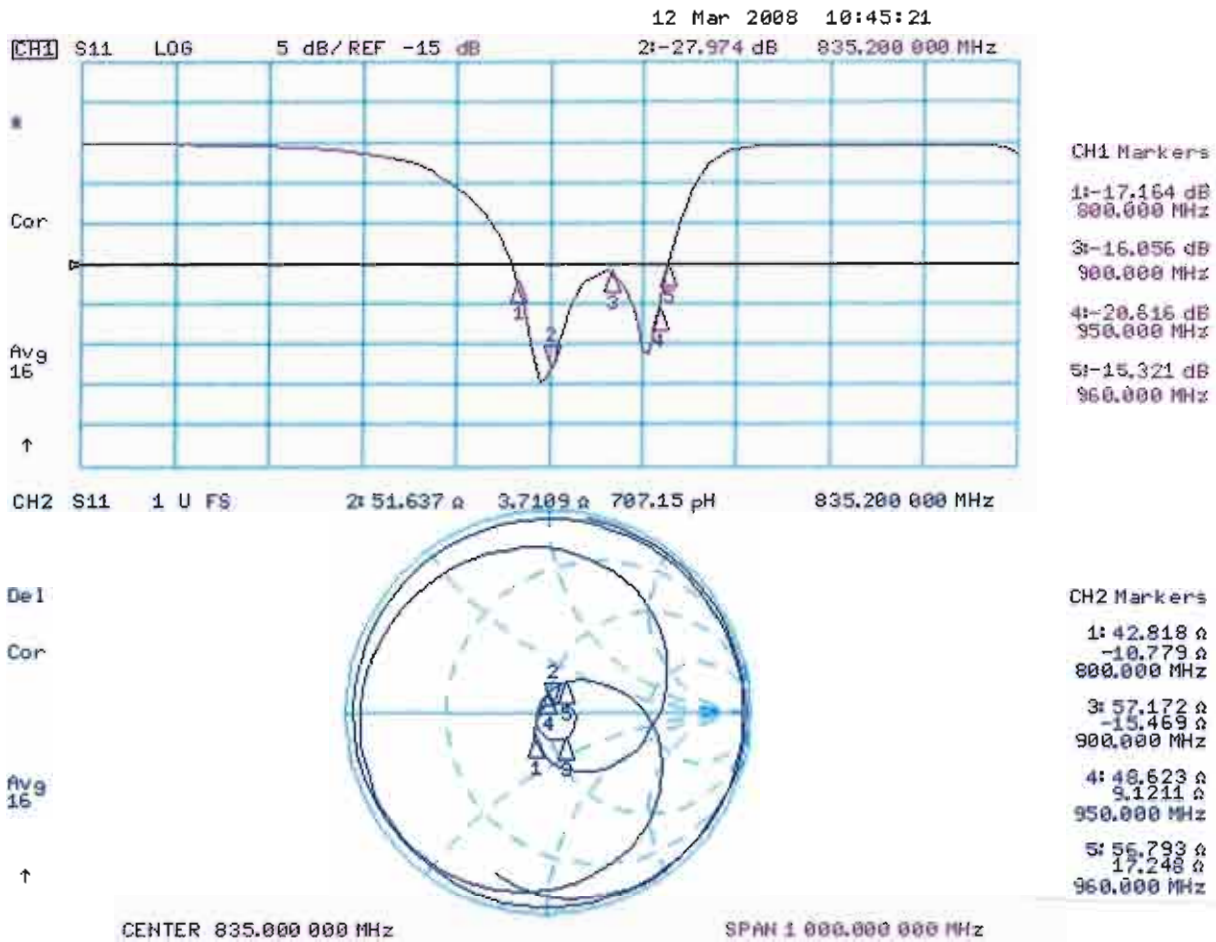

3.3.2 DASYS4 H-field result

Date/Time: 11.03.2008 11:59:27

Test Laboratory: SPEAG Lab 2

DUT: HAC-Dipole 835 MHz; Type: D835V3; Serial: 1076

Communication System: CW; Frequency: 835 MHz; Duty Cycle: 1:1

Medium parameters used: $\sigma = 0$ mho/m, $\epsilon_r = 1$; $\rho = 1$ kg/m³

Phantom section: H Dipole Section

Measurement Standard: DASYS4 (High Precision Assessment)

DASYS4 Configuration:

- Probe: H3DV6 - SN6065; Calibrated: 31.12.2007
- Sensor-Surface: (Fix Surface)
- Electronics: DAE4 Sn781; Calibrated: 02.10.2007
- Phantom: HAC Test Arch with Coil; Type: SD HAC P01 BA; Serial: 1070
- Measurement SW: DASYS4, V4.7 Build 61; Postprocessing SW: SEMCAD, V1.8 Build 176

H Scan - Sensor Center 10mm above CD835 Dipole/Hearing Aid Compatibility Test (41x361x1):

Measurement grid: dx=5mm, dy=5mm

Maximum value of peak Total field = 0.443 A/m

Probe Modulation Factor = 1.00

Device Reference Point: 0.000, 0.000, 354.7 mm

Reference Value = 0.471 A/m; Power Drift = 0.002 dB

Hearing Aid Near-Field Category: M4 (AWF 0 dB)

Peak H-field in A/m

Grid 1	Grid 2	Grid 3
0.371 M4	0.391 M4	0.370 M4
Grid 4	Grid 5	Grid 6
0.419 M4	0.443 M4	0.420 M4
Grid 7	Grid 8	Grid 9
0.367 M4	0.391 M4	0.370 M4

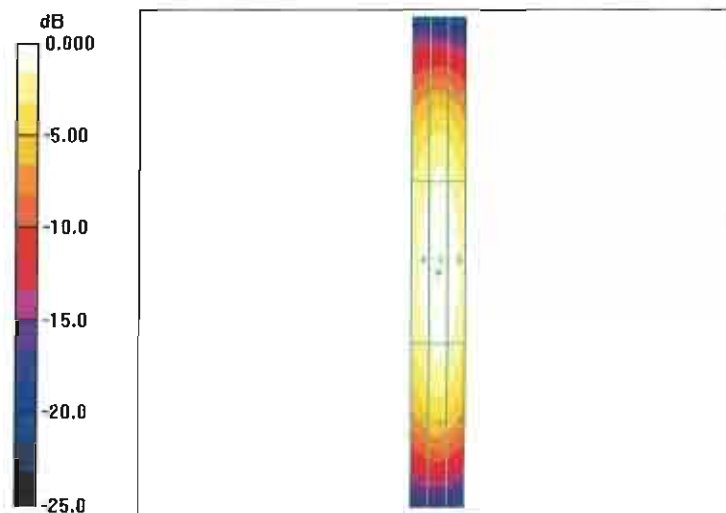

0 dB = 0.443A/m

3.3.3 DASY4 E-Field result

Date/Time: 10.03.2008 13:12:08

Test Laboratory: SPEAG Lab 2

DUT: HAC-Dipole 835 MHz; Type: D835V3; Serial: 1076

Communication System: CW; Frequency: 835; Duty Cycle: 1:1

Medium parameters used: $\sigma = 0$ mho/m, $\epsilon_r = 1$; $\rho = 1000$ kg/m³

Phantom section: E Dipole Section

Measurement Standard: DASY4 (High Precision Assessment)

DASY4 Configuration:

- Probe: ER3DV6 - SN2336; ConvF(1, 1, 1); Calibrated: 31.12.2007
- Sensor-Surface: (Fix Surface)
- Electronics: DAE4 Sn781; Calibrated: 02.10.2007
- Phantom: HAC Test Arch with Coil; Type: SD HAC P01 BA; Serial: 1070
- Measurement SW: DASY4, V4.7 Build 61; Postprocessing SW: SEMCAD, V1.8 Build 176

E Scan - Sensor Center 10mm above CD835 Dipole/Hearing Aid Compatibility Test (41x361x1):

Measurement grid: dx=5mm, dy=5mm

Maximum value of peak Total field = 157.2 V/m

Probe Modulation Factor = 1.00

Device Reference Point: 0.000, 0.000, 354.7 mm

Reference Value = 101.7 V/m; Power Drift = 0.009 dB

Hearing Aid Near-Field Category: M4 (AWF 0 dB)

Peak E-field in V/m

Grid 1	Grid 2	Grid 3
152.8 M4	157.2 M4	152.8 M4
Grid 4	Grid 5	Grid 6
83.9 M4	85.8 M4	82.5 M4
Grid 7	Grid 8	Grid 9
149.0 M4	153.7 M4	149.6 M4

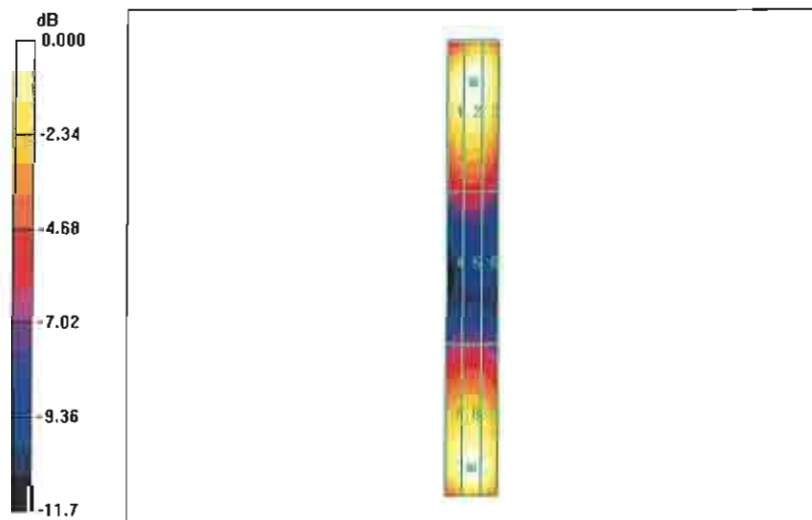

0 dB = 157.2 V/m

4. Additional Measurements

4.1 Measurement Conditions

DASY system configuration, as far as not given on page 1.

DASY Version	DASY4	V4.7 B53
DASY PP Version	SEMCAD	V1.8 B172
Phantom	HAC Test Arch	SD HAC P01 BA, #1002
Distance Dipole Top - Probe Center	10 mm	
Scan resolution	dx, dy = 5 mm	area = 20 x 180 mm
Frequency	813 MHz ± 1 MHz	
Forward power at dipole connector	20.0 dBm = 100mW	
Input power drift	< 0.05 dB	

4.1.1 Maximum Field values

H-field 10 mm above dipole surface	condition	interpolated maximum
Maximum measured	100 mW forward power	0.448 A/m

Uncertainty for H-field measurement: 8.2% (k=2)

E-field 10 mm above dipole surface	condition	Interpolated maximum
Maximum measured above high end	100 mW forward power	172.5 V/m
Maximum measured above low end	100 mW forward power	163.8V/m
Averaged maximum above arm	100 mW forward power	168.2 V/m

Uncertainty for E-field measurement: 12.8% (k=2)

4.1.2 DASY4 H-field result

Date/Time: 11.03.2008 11:59:27

Test Laboratory: SPEAG Lab 2

DUT: HAC-Dipole 835 MHz; Type: D835V3; Serial: 1076

Communication System: CW; Frequency: 813 MHz; Duty Cycle: 1:1

Medium parameters used: $\sigma = 0$ mho/m, $\epsilon_r = 1$; $\rho = 1$ kg/m³

Phantom section: H Dipole Section

Measurement Standard: DASY4 (High Precision Assessment)

DASY4 Configuration:

- Probe: H3DV6 - SN6065; Calibrated: 31.12.2007
- Sensor-Surface: (Fix Surface)
- Electronics: DAE4 Sn781; Calibrated: 02.10.2007
- Phantom: HAC Test Arch with Coil; Type: SD HAC P01 BA; Serial: 1070
- Measurement SW: DASY4, V4.7 Build 61; Postprocessing SW: SEMCAD, V1.8 Build 176

H Scan - Sensor Center 10mm above CD835 Dipole @ 813MHz/Hearing Aid Compatibility Test (41x361x1):

Measurement grid: dx=5mm, dy=5mm

Maximum value of peak Total field = 0.452 A/m

Probe Modulation Factor = 1.00

Reference Value = 0.481 A/m; Power Drift = -0.003 dB

Hearing Aid Near-Field Category: M4 (AWF 0 dB)

Peak H-field in A/m

Grid 1	Grid 2	Grid 3
0.374 M4	0.395 M4	0.374 M4
Grid 4	Grid 5	Grid 6
0.427 M4	0.452 M4	0.429 M4
Grid 7	Grid 8	Grid 9
0.371 M4	0.395 M4	0.373 M4

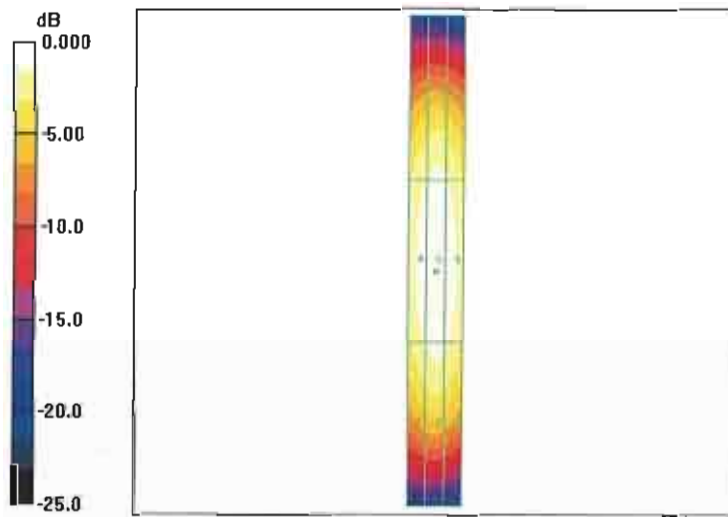

0 dB = 0.452 A/m

4.1.3 DASY4 E-field result

Date/Time: 10.03.2008 13:12:08

Test Laboratory: SPEAG Lab 2

DUT: HAC-Dipole 835 MHz; Type: D835V3; Serial: 1076

Communication System: CW; Frequency: 813; Duty Cycle: 1:1

Medium parameters used: $\sigma = 0$ mho/m, $\epsilon_r = 1$; $\rho = 1000$ kg/m³

Phantom section: E Dipole Section

Measurement Standard: DASY4 (High Precision Assessment)

DASY4 Configuration:

- Probe: ER3DV6 - SN2336; ConvF(1, 1, 1); Calibrated: 31.12.2007
- Sensor-Surface: (Fix Surface)
- Electronics: DAE4 Sn781; Calibrated: 02.10.2007
- Phantom: HAC Test Arch with Coil; Type: SD HAC P01 BA; Serial: 1070
- Measurement SW: DASY4, V4.7 Build 61; Postprocessing SW: SEMCAD, V1.8 Build 176

E Scan - Sensor Center 10mm above CD835 Dipole @ 813MHz/Hearing Aid Compatibility Test (41x361x1):

Measurement grid: dx=5mm, dy=5mm

Maximum value of peak Total field = 161.6 V/m

Probe Modulation Factor = 1.00

Reference Value = 104.9 V/m; Power Drift = 0.006 dB

Hearing Aid Near-Field Category: M4 (AWF 0 dB)

Peak E-field in V/m

Grid 1 157.3 M4	Grid 2 161.6 M4	Grid 3 157.1 M4
Grid 4 86.3 M4	Grid 5 88.2 M4	Grid 6 85.2 M4
Grid 7 151.8 M4	Grid 8 156.5 M4	Grid 9 152.3 M4

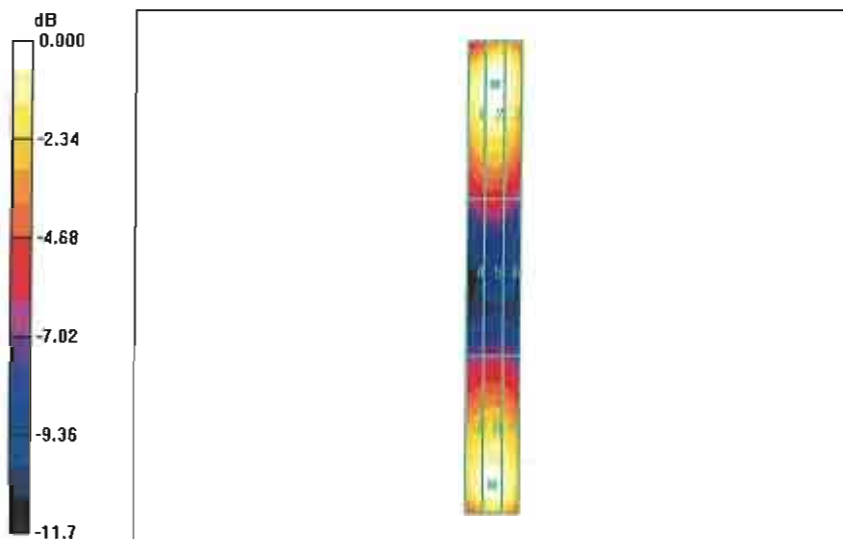

0 dB = 161.6 V/m

4.2 Measurement Conditions

DASY system configuration, as far as not given on page 1.

DASY Version	DASY4	V4.7 B53
DASY PP Version	SEMCAD	V1.8 B172
Phantom	HAC Test Arch	SD HAC P01 BA, #1002
Distance Dipole Top - Probe Center	10 mm	
Scan resolution	dx, dy = 5 mm	area = 20 x 180 mm
Frequency	898 MHz ± 1 MHz	
Forward power at dipole connector	20.0 dBm = 100mW	
Input power drift	< 0.05 dB	

4.2.1 Maximum Field values

H-field 10 mm above dipole surface	condition	Interpolated maximum
Maximum measured	100 mW forward power	0.416 A/m

Uncertainty for H-field measurement: 8.2% (k=2)

E-field 10 mm above dipole surface	condition	Interpolated maximum
Maximum measured above high end	100 mW forward power	158.8 V/m
Maximum measured above low end	100 mW forward power	143.9 V/m
Averaged maximum above arm	100 mW forward power	151.4 V/m

Uncertainty for E-field measurement: 12.8% (k=2)

4.2.2 DASY4 H-field result

Date/Time: 11.03.2008 11:59:27

Test Laboratory: SPEAG Lab 2

DUT: HAC-Dipole 835 MHz; Type: D835V3; Serial: 1076

Communication System: CW; Frequency: 898 MHz; Duty Cycle: 1:1

Medium parameters used: $\sigma = 0$ mho/m, $\epsilon_r = 1$; $\rho = 1$ kg/m³

Phantom section: H Dipole Section

Measurement Standard: DASY4 (High Precision Assessment)

DASY4 Configuration:

- Probe: H3DV6 - SN6065; Calibrated: 31.12.2007
- Sensor-Surface: (Fix Surface)
- Electronics: DAE4 Sn781; Calibrated: 02.10.2007
- Phantom: HAC Test Arch with Coil; Type: SD HAC P01 BA; Serial: 1070
- Measurement SW: DASY4, V4.7 Build 61; Postprocessing SW: SEMCAD, V1.8 Build 176

H Scan - Sensor Center 10mm above CD835 Dipole @ 898MHz/Hearing Aid Compatibility Test (41x361x1): Measurement grid: dx=5mm, dy=5mm

Maximum value of peak Total field = 0.425 A/m

Probe Modulation Factor = 1.00

Device Reference Point: 0.000, 0.000, 354.7 mm

Reference Value = 0.445 A/m; Power Drift = -0.036 dB

Hearing Aid Near-Field Category: M4 (AWF 0 dB)

Peak H-field in A/m

Grid 1 0.373 M4	Grid 2 0.394 M4	Grid 3 0.372 M4
Grid 4 0.402 M4	Grid 5 0.425 M4	Grid 6 0.403 M4
Grid 7 0.372 M4	Grid 8 0.396 M4	Grid 9 0.375 M4

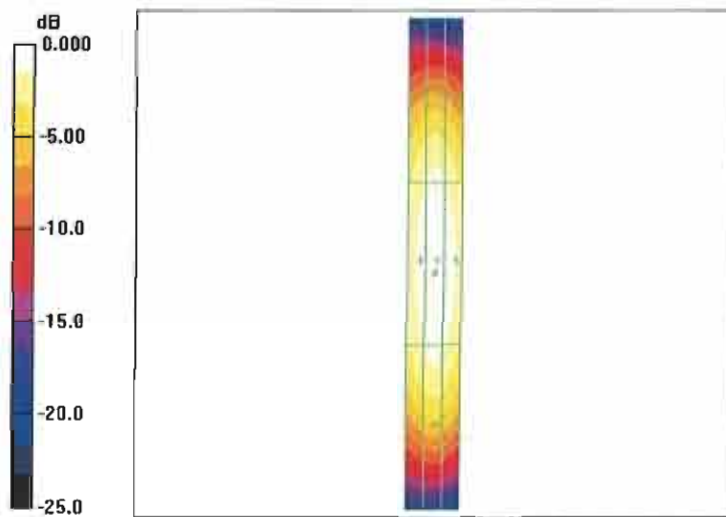

0 dB = 0.425 A/m

4.2.3 DASYS4 E-field result

Date/Time: 10.03.2008 13:12:08

Test Laboratory: SPEAG Lab 2

DUT: HAC-Dipole 835 MHz; Type: D835V3; Serial: 1076

Communication System: CW; Frequency: 898; Duty Cycle: 1:1

Medium parameters used: $\sigma = 0$ mho/m, $\epsilon_r = 1$; $\rho = 1000$ kg/m³

Phantom section: E Dipole Section

Measurement Standard: DASYS4 (High Precision Assessment)

DASYS4 Configuration:

- Probe: ER3DV6 - SN2336; ConvF(1, 1, 1); Calibrated: 31.12.2007
- Sensor-Surface: (Fix Surface)
- Electronics: DAE4 Sn781; Calibrated: 02.10.2007
- Phantom: HAC Test Arch with Coil; Type: SD HAC P01 BA; Serial: 1070
- Measurement SW: DASYS4, V4.7 Build 61; Postprocessing SW: SEMCAD, V1.8 Build 176

E Scan - Sensor Center 10mm above CD835 Dipole @ 898MHz/Hearing Aid Compatibility Test (41x361x1):

Measurement grid: dx=5mm, dy=5mm

Maximum value of peak Total field = 154.8 V/m

Probe Modulation Factor = 1.00

Device Reference Point: 0.000, 0.000, 354.7 mm

Reference Value = 93.0 V/m; Power Drift = -0.013 dB

Hearing Aid Near-Field Category: M4 (AWF 0 dB)

Peak E-field in V/m

Grid 1 150.5 M4	Grid 2 154.8 M4	Grid 3 150.5 M4
Grid 4 74.3 M4	Grid 5 76.0 M4	Grid 6 73.2 M4
Grid 7 148.9 M4	Grid 8 153.5 M4	Grid 9 149.5 M4

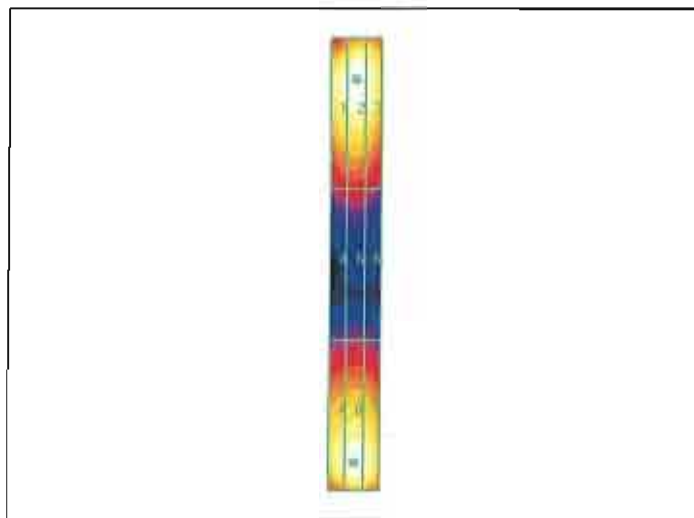
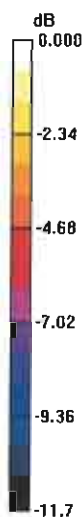

0 dB = 154.8 V/m