



FCC RF Test Report

APPLICANT : Motorola Mobility LLC
EQUIPMENT : Mobile Cellular Phone
BRAND NAME : Motorola
MODEL NAME : XT2523-3, XT2523-6
FCC ID : IHDT56AT4
STANDARD : 47 CFR Part 22(H)
CLASSIFICATION : Licensed Non-Broadcast Transmitter Held to Ear(TNE)
TEST DATE(S) : Oct. 28, 2024 ~ Oct. 29, 2024

We, Sporton International Inc. (Shenzhen), would like to declare that the tested sample has been evaluated in accordance with the procedures given in ANSI C63.26-2015 and shown compliance with the applicable technical standards.

The test results in this report apply exclusively to the tested model / sample. Without written approval of Sporton International Inc. (Shenzhen), the test report shall not be reproduced except in full.

Jason Jia



Approved by: Jason Jia

Sporton International Inc. (ShenZhen)

1/F, 2/F, Bldg 5, Shiling Industrial Zone, Xinwei Village, Xili, Nanshan, Shenzhen, 518055

People's Republic of China



TABLE OF CONTENTS

REVISION HISTORY... 3
SUMMARY OF TEST RESULT ... 4
1 GENERAL DESCRIPTION ... 5
1.1 Applicant ... 5
1.2 Manufacturer ... 5
1.3 Product Feature of Equipment Under Test ... 5
1.4 Product Specification of Equipment Under Test ... 5
1.5 Modification of EUT ... 5
1.6 Maximum ERP Power and Emission Designator ... 6
1.7 Testing Location ... 6
1.8 Test Software ... 6
1.9 Applicable Standards ... 7
1.10 Specification of Accessory ... 7
2 TEST CONFIGURATION OF EQUIPMENT UNDER TEST ... 8
2.1 Test Mode ... 8
2.2 Connection Diagram of Test System ... 9
2.3 Support Unit used in test configuration and system ... 9
2.4 Measurement Results Explanation Example ... 9
2.5 Frequency List of Low/Middle/High Channels ... 10
3 CONDUCTED TEST ITEMS ... 11
3.1 Measuring Instruments ... 11
3.2 Test Setup ... 11
3.3 Test Result of Conducted Test ... 11
3.4 Conducted Output Power and ERP ... 12
3.5 Peak-to-Average Ratio ... 13
3.6 Occupied Bandwidth ... 14
3.7 Conducted Band Edge ... 15
3.8 Conducted Spurious Emission ... 16
3.9 Frequency Stability ... 17
4 RADIATED TEST ITEMS ... 18
4.1 Measuring Instruments ... 18
4.2 Test Setup ... 18
4.3 Test Result of Radiated Test ... 19
4.4 Radiated Spurious Emission ... 20
5 LIST OF MEASURING EQUIPMENT ... 21
6 MEASUREMENT UNCERTAINTY ... 22
APPENDIX A. TEST RESULTS OF CONDUCTED TEST
APPENDIX B. TEST RESULTS OF RADIATED TEST
APPENDIX C. TEST SETUP PHOTOGRAPHS



SUMMARY OF TEST RESULT

Report Section	FCC Rule	Description	Limit	Result	Remark
3.4	§2.1046	Conducted Output Power	-	Report Only	-
	§22.913(a)(5)	Effective Radiated Power (Band 5)	ERP < 7 Watt	PASS	-
3.5	N/A	Peak-to-Average Ratio	<13 dB	PASS	-
3.6	§2.1049	Occupied Bandwidth	-	Report Only	-
3.7	§2.1051 §22.917(a)	Conducted Band Edge Measurement (Band 5)	< 43+10log ₁₀ (P[Watts])	PASS	-
3.8	§2.1051 §22.917(a)	Conducted Spurious Emission (Band 5)	< 43+10log ₁₀ (P[Watts])	PASS	-
3.9	§2.1055 §22.355	Frequency Stability Temperature & Voltage	< 2.5 ppm for Part 22	PASS	-
4.4	§2.1053 §22.917(a)	Radiated Spurious Emission (Band 5)	< 43+10log ₁₀ (P[Watts])	PASS	Under limit 45.49 dB at 2496.27 MHz

Conformity Assessment Condition:

- The test results (PASS/FAIL) with all measurement uncertainty excluded are presented against the regulation limits or in accordance with the requirements stipulated by the applicant/manufacture who shall bear all the risks of non-compliance that may potentially occur if measurement uncertainty is taken into account.
- The measurement uncertainty please refer to each test result in the section "Measurement Uncertainty"

Disclaimer:

The product specifications of the EUT presented in the test report that may affect the test assessments are declared by the manufacturer who shall take full responsibility for the authenticity.



1 General Description

1.1 Applicant

Motorola Mobility LLC
222 W, Merchandise Mart Plaza, Chicago IL 60654 USA

1.2 Manufacturer

Motorola Mobility LLC
222 W, Merchandise Mart Plaza, Chicago IL 60654 USA

1.3 Product Feature of Equipment Under Test

Product Feature	
Equipment	Mobile Cellular Phone
Brand Name	Motorola
Model Name	XT2523-3, XT2523-6
FCC ID	IHDT56AT4
IMEI Code	Conducted: 350288530019378/350288530019386 Radiation: 350288530017992/350288530018008
HW Version	DVT2
SW Version	VVTA35.44, UUTB34.23
EUT Stage	Identical Prototype

1.4 Product Specification of Equipment Under Test

Standards-related Product Specification	
Tx Frequency	LTE Band 5 : 824 MHz ~ 849 MHz
Rx Frequency	LTE Band 5 : 869 MHz ~ 894 MHz
Bandwidth	LTE Band 5 : 1.4MHz / 3MHz / 5MHz / 10MHz
Maximum Output Power to Antenna	<ANT0> LTE Band 5 : 23.44 dBm <ANT3> LTE Band 5 : 23.13 dBm
Antenna Gain	<ANT0> LTE Band 5 : -4.2 dBi <ANT3> LTE Band 5 : -4 dBi
Type of Modulation	QPSK / 16QAM / 64QAM

Note: The maximum ERP is calculated from max output power and max antenna gain, so only the maximum ERP of Antenna 0 for LTE Band5 is shown in the report.

1.5 Modification of EUT

No modifications are made to the EUT during all test items.



1.6 Maximum ERP Power and Emission Designator

LTE Band 5		QPSK		16QAM/64QAM	
BW (MHz)	Frequency Range (MHz)	Maximum ERP(W)	Emission Designator (99%OBW)	Maximum ERP(W)	Emission Designator (99%OBW)
1.4	824.7 ~ 848.3	0.0489	1M09G7D	0.0414	1M09W7D
3	825.5 ~ 847.5	0.0495	2M70G7D	0.0419	2M72W7D
5	826.5 ~ 846.5	0.0499	4M50G7D	0.0423	4M48W7D
10	829.0 ~ 844.0	0.0512	9M07G7D	0.0425	8M97W7D

Note: All modulations have been tested, and only the worst test results of PSK & QAM are shown in the report.

1.7 Testing Location

Sporton International Inc. (ShenZhen) is accredited to ISO/IEC 17025:2017 by American Association for Laboratory Accreditation with Certificate Number 5145.01.

Test Firm	Sporton International Inc. (ShenZhen)		
Test Site Location	1/F, 2/F, Bldg 5, Shiling Industrial Zone, Xinwei Village, Xili, Nanshan, Shenzhen, 518055 People's Republic of China TEL: +86-755-86379589 FAX: +86-755-86379595		
Test Site No.	Sporton Site No.	FCC Designation No.	FCC Test Firm Registration No.
	TH01-SZ	CN1256	421272

Test Firm	Sporton International Inc. (ShenZhen)		
Test Site Location	101, 1st Floor, Block B, Building 1, No. 2, Tengfeng 4th Road, Fenghuang Community, Fuyong Street, Baoan District, Shenzhen City, Guangdong Province 518103 People's Republic of China TEL: +86-755-86066985		
Test Site No.	Sporton Site No.	FCC Designation No.	FCC Test Firm Registration No.
	03CH01-SZ	CN1256	421272

1.8 Test Software

Item	Site	Manufacture	Name	Version
1.	03CH01-SZ	AUDIX	E3	6.2009-8-24



1.9 Applicable Standards

According to the specifications of the manufacturer, the EUT must comply with the requirements of the following standards:

- 47 CFR Part 22(H)
- ANSI C63.26-2015
- FCC KDB 971168 D01 Power Meas License Digital Systems v03r01
- FCC KDB 412172 D01 Determining ERP and EIRP v01r01

Remark:

1. All test items were verified and recorded according to the standards and without any deviation during the test.
2. This EUT has also been tested and complied with the requirements of FCC Part 15, Subpart B, recorded in a separate test report.

1.10 Specification of Accessory

Accessories Information				
AC Adapter 1(US)	Brand Name	Motorola(AOHAI)	Model Name	MC-101
AC Adapter 1(EU)	Brand Name	Motorola(AOHAI)	Model Name	MC-102
AC Adapter 1(UK)	Brand Name	Motorola(AOHAI)	Model Name	MC-103
AC Adapter 1(IN)	Brand Name	Motorola(AOHAI)	Model Name	MC-104
AC Adapter 1(AU)	Brand Name	Motorola(AOHAI)	Model Name	MC-105
AC Adapter 1(AR)	Brand Name	Motorola(AOHAI)	Model Name	MC-106
AC Adapter 2(US)	Brand Name	Motorola(CHENYANG)	Model Name	MC-101
AC Adapter 2(EU)	Brand Name	Motorola(CHENYANG)	Model Name	MC-102
AC Adapter 2(UK)	Brand Name	Motorola(CHENYANG)	Model Name	MC-103
AC Adapter 2(AU)	Brand Name	Motorola(CHENYANG)	Model Name	MC-105
AC Adapter 2(AR)	Brand Name	Motorola(CHENYANG)	Model Name	MC-106
AC Adapter 2(BR)	Brand Name	Motorola(CHENYANG)	Model Name	MC-107
AC Adapter 2(PRC)	Brand Name	Motorola(CHENYANG)	Model Name	MC-108
AC Adapter 3(CHILE)	Brand Name	Motorola(SALCOMP)	Model Name	MC-109
Battery 1	Brand Name	Motorola(ATL)	Model Name	RL52
Battery 2	Brand Name	Motorola(Jiade)	Model Name	RL52
Battery 3	Brand Name	Motorola(Sunwoda)	Model Name	RL52
USB Cable 1	Brand Name	Motorola(Yihuaxing)	Model Name	T365-020 T365-020-01 T365-020-02
USB Cable 2	Brand Name	Motorola(WASHIN)	Model Name	HX-TL-01 HX-TL-08 HX-TL-07
USB Cable 3	Brand Name	Motorola(Juwei)	Model Name	JWUB1614-T03H JWUB1705-T03H JWUB1856-T03H
USB Cable 4	Brand Name	Motorola(I-SHENG)	Model Name	SC18D38574



2 Test Configuration of Equipment Under Test

2.1 Test Mode

Antenna port conducted and radiated test items listed below are performed according to KDB 971168 D01 Power Meas License Digital Systems v03r01 with maximum output power.

Radiated measurements are performed by rotating the EUT in three different orthogonal test planes to find the maximum emission. (X-Plane)

Test Items	Band	Bandwidth (MHz)						Modulation			RB #			Test Channel			
		1.4	3	5	10	15	20	QPSK	16QAM	64QAM	1	Half	Full	L	M	H	
Max. Output Power	5	v	v	v	v	-	-	v	v	v	v	v	v	v	v	v	
Peak-to-Average Ratio	5				v	-	-	v	v	v			v		v		
26dB and 99% Bandwidth	5	v	v	v	v	-	-	v	v				v		v		
Conducted Band Edge	5	v	v	v	v	-	-	v	v	v	v		v			v	
Conducted Spurious Emission	5	v	v	v	v	-	-	v				v			v	v	v
Frequency Stability	5				v	-	-	v					v		v		
E.R.P	5	v	v	v	v	-	-	v	v	v	v	v	v	v	v	v	v
Radiated Spurious Emission	5	Worst Case												v			
Note	1. The mark "v" means that this configuration is chosen for testing 2. The mark "-" means that this bandwidth is not supported. 3. The device is investigated from 30MHz to 10 times of fundamental signal for radiated spurious emission test under different RB size/offset and modulations in exploratory test. Subsequently, only the worst case emissions are reported.																

2.2 Connection Diagram of Test System

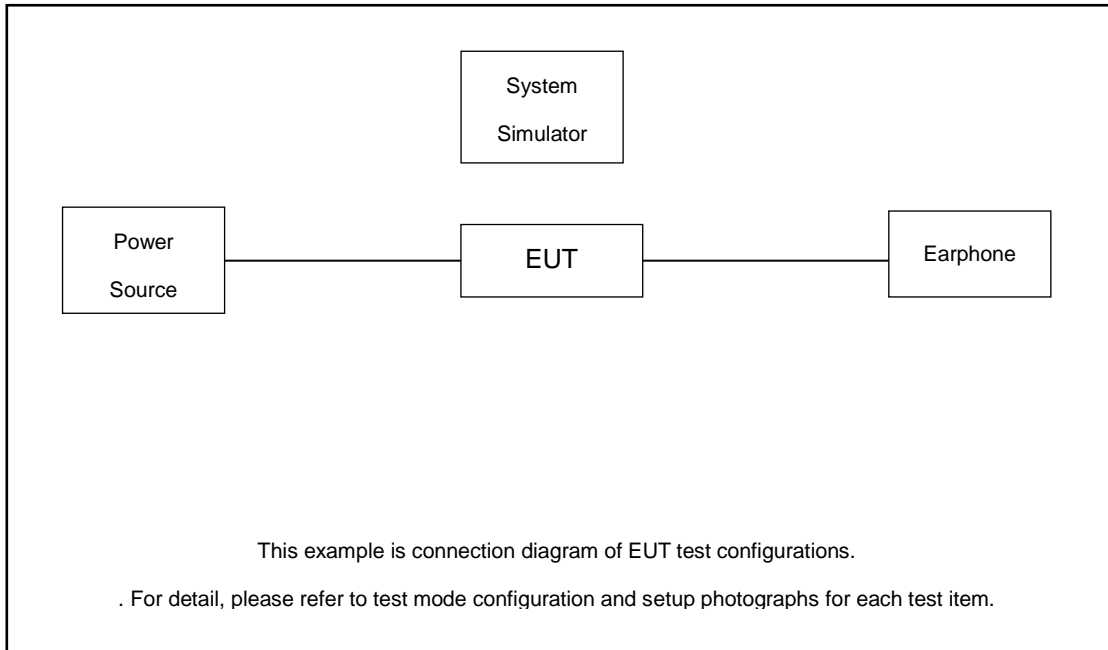

2.3 Support Unit used in test configuration and system

Item	Equipment	Trade Name	Model No.	FCC ID	Data Cable	Power Cord
1.	Power Supply	GWINSTEK	PSS-2002	N/A	N/A	Unshielded, 1.8 m
2.	LTE Base Station	Anritsu	MT8820C	N/A	N/A	Unshielded, 1.8 m

2.4 Measurement Results Explanation Example

For all conducted test items:

The offset level is set in the spectrum analyzer to compensate the RF cable loss and attenuator factor between EUT conducted output port and spectrum analyzer. With the offset compensation, the spectrum analyzer reading level is exactly the EUT RF output level.

The spectrum analyzer offset is derived from RF cable loss and attenuator factor.

$$\text{Offset} = \text{RF cable loss} + \text{attenuator factor}.$$

Following shows an offset computation example with cable loss 4.0 dB and 10dB attenuator.

Example :

$$\begin{aligned} \text{Offset(dB)} &= \text{RF cable loss(dB)} + \text{attenuator factor(dB)}. \\ &= 4.0 + 10 = 14.0 \text{ (dB)} \end{aligned}$$



2.5 Frequency List of Low/Middle/High Channels

LTE Band 5 Channel and Frequency List				
BW [MHz]	Channel/Frequency(MHz)	Lowest	Middle	Highest
10	Channel	20450	20525	20600
	Frequency	829	836.5	844
5	Channel	20425	20525	20625
	Frequency	826.5	836.5	846.5
3	Channel	20415	20525	20635
	Frequency	825.5	836.5	847.5
1.4	Channel	20407	20525	20643
	Frequency	824.7	836.5	848.3

3 Conducted Test Items

3.1 Measuring Instruments

See list of measuring instruments of this test report.

3.2 Test Setup

3.2.1 Conducted Output Power



3.2.2 Peak-to-Average Ratio, Occupied Bandwidth ,Conducted Band-Edge and Conducted Spurious Emission

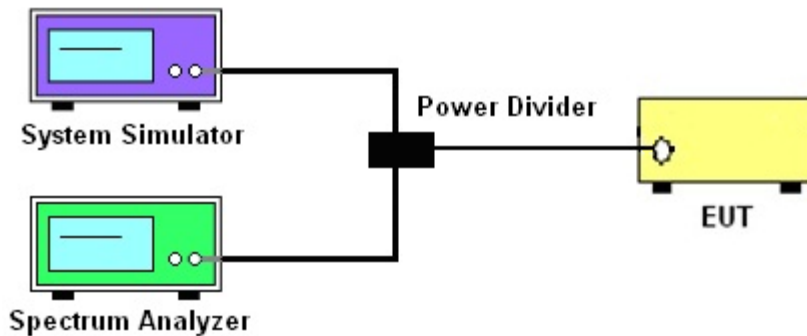

3.2.3 Frequency Stability

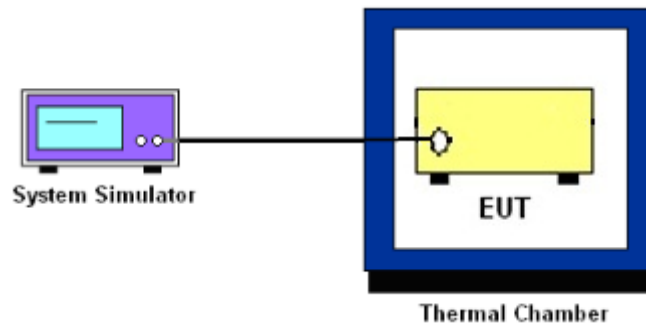

3.3 Test Result of Conducted Test

Please refer to Appendix A.



3.4 Conducted Output Power and ERP

3.4.1 Description of the Conducted Output Power Measurement and ERP Measurement

A system simulator was used to establish communication with the EUT. Its parameters were set to force the EUT transmitting at maximum output power. The measured power in the radio frequency on the transmitter output terminals shall be reported.

The ERP of mobile transmitters must not exceed 7 Watts for LTE Band 5.

According to KDB 412172 D01 Power Approach,

$EIRP = P_T + G_T - L_C$, $ERP = EIRP - 2.15$, where

P_T = transmitter output power in dBm

G_T = gain of the transmitting antenna in dBi

L_C = signal attenuation in the connecting cable between the transmitter and antenna in dB

3.4.2 Test Procedures

1. The testing follows ANSI C63.26 Section 5.2
2. The transmitter output port was connected to the system simulator.
3. Set EUT at maximum power through the system simulator.
4. Select lowest, middle, and highest channels for each band and different modulation.
5. Measure and record the power level from the system simulator.



3.5 Peak-to-Average Ratio

3.5.1 Description of the PAR Measurement

Power Complementary Cumulative Distribution Function (CCDF) curves provide a means for characterizing the power peaks of a digitally modulated signal on a statistical basis. A CCDF curve depicts the probability of the peak signal amplitude exceeding the average power level. Most contemporary measurement instrumentation include the capability to produce CCDF curves for an input signal provided that the instrument's resolution bandwidth can be set wide enough to accommodate the entire input signal bandwidth. In measuring transmissions in this band using an average power technique, the peak-to-average ratio (PAR) of the transmission may not exceed 13 dB.

3.5.2 Test Procedures

1. The testing follows ANSI C63.26 Section 5.2.3.4 (CCDF).
2. The EUT was connected to spectrum and system simulator via a power divider.
3. Set the CCDF (Complementary Cumulative Distribution Function) option in spectrum analyzer.
4. The highest RF powers were measured and recorded the maximum PAPR level associated with a probability of 0.1 %.
5. Record the deviation as Peak to Average Ratio.



3.6 Occupied Bandwidth

3.6.1 Description of Occupied Bandwidth Measurement

The occupied bandwidth is the width of a frequency band such that, below the lower and above the upper frequency limits, the mean powers emitted are each equal to a specified percentage 0.5% of the total mean transmitted power.

The 26 dB emission bandwidth is defined as the frequency range between two points, one above and one below the carrier frequency, at which the spectral density of the emission is attenuated 26 dB below the maximum in-band spectral density of the modulated signal. Spectral density (power per unit bandwidth) is to be measured with a detector of resolution bandwidth equal to approximately 1.0% of the emission bandwidth.

3.6.2 Test Procedures

1. The testing follows ANSI C63.26 Section 5.4
2. The EUT was connected to spectrum analyzer and system simulator via a power divider.
3. The spectrum analyzer center frequency is set to the nominal EUT channel center frequency. The span range for the spectrum analyzer shall be between two and five times the anticipated OBW.
4. The nominal resolution bandwidth (RBW) shall be in the range of 1 to 5 % of the anticipated OBW, and the VBW shall be at least 3 times the RBW.
5. Set the detection mode to peak, and the trace mode to max hold.
6. Determine the reference value: Set the EUT to transmit a modulated signal. Allow the trace to stabilize. Set the spectrum analyzer marker to the highest level of the displayed trace.
(this is the reference value)
7. Determine the “-26 dB down amplitude” as equal to (Reference Value – X).
8. Place two markers, one at the lowest and the other at the highest frequency of the envelope of the spectral display such that each marker is at or slightly below the “-X dB down amplitude” determined in step 6. If a marker is below this “-X dB down amplitude” value it shall be placed as close as possible to this value. The OBW is the positive frequency difference between the two markers.
9. Use the 99 % power bandwidth function of the spectrum analyzer and report the measured bandwidth.



3.7 Conducted Band Edge

3.7.1 Description of Conducted Band Edge Measurement

22.917(a)

For operations in the 824 – 849 MHz band, the FCC limit is $43 + 10\log_{10}(P[\text{Watts}])$ dB below the transmitter power P(Watts) in a 100kHz bandwidth. However, in the 1MHz bands immediately outside and adjacent to the licensee's frequency block, a resolution bandwidth of at least one percent of the emission bandwidth of the fundamental emission of the transmitter may be employed.

3.7.2 Test Procedures

1. The testing follows ANSI C63.26 section 5.7
1. The EUT was connected to spectrum analyzer and system simulator via a power divider.
2. The band edges of low and high channels for the highest RF powers were measured.
3. Set RBW $\geq 1\%$ EBW in the 1MHz band immediately outside and adjacent to the band edge.
4. Beyond the 1 MHz band from the band edge, RBW=1MHz was used
5. Set spectrum analyzer with RMS detector.
6. The RF fundamental frequency should be excluded against the limit line in the operating frequency band.
7. Checked that all the results comply with the emission limit line.

Example:

The limit line is derived from $43 + 10\log(P)$ dB below the transmitter power P(Watts)
 $= P(W) - [43 + 10\log(P)]$ (dB)
 $= [30 + 10\log(P)]$ (dBm) - $[43 + 10\log(P)]$ (dB) = -13dBm.

8. When using the integration method, the starting frequency of the integration shall be centered at one-half of the RBW away from the band edge.



3.8 Conducted Spurious Emission

3.8.1 Description of Conducted Spurious Emission Measurement

The power of any emission outside of the authorized operating frequency ranges must be lower than the transmitter power (P) by a factor of at least $43 + 10 \log (P)$ dB.

It is measured by means of a calibrated spectrum analyzer and scanned from 30 MHz up to a frequency including its 10th harmonic.

3.8.2 Test Procedures

1. The testing follows ANSI C63.26 section 5.7
2. The EUT was connected to spectrum analyzer and system simulator via a power divider.
3. The RF output of EUT was connected to the spectrum analyzer by RF cable and attenuator. The path loss was compensated to the results for each measurement.
4. The middle channel for the highest RF power within the transmitting frequency was measured.
5. The conducted spurious emission for the whole frequency range was taken.
6. Make the measurement with the spectrum analyzer's RBW = 1MHz, VBW = 3MHz.
7. Set spectrum analyzer with RMS detector.
8. Taking the record of maximum spurious emission.
9. The RF fundamental frequency should be excluded against the limit line in the operating frequency band.
10. The limit line is derived from $43 + 10\log(P)$ dB below the transmitter power P(Watts)
= P(W)- [43 + 10log(P)] (dB)
= [30 + 10log(P)] (dBm) - [43 + 10log(P)] (dB)
= -13dBm.



3.9 Frequency Stability

3.9.1 Description of Frequency Stability Measurement

The frequency stability shall be measured by variation of ambient temperature and variation of primary supply voltage to ensure that the fundamental emission stays within the authorized frequency block. The frequency stability of the transmitter shall be maintained within $\pm 0.00025\%$ ($\pm 2.5\text{ppm}$) of the center frequency.

3.9.2 Test Procedures for Temperature Variation

1. The testing follows ANSI C63.26 section 5.6.4
2. The EUT was set up in the thermal chamber and connected with the system simulator.
3. With power OFF, the temperature was decreased to -30°C and the EUT was stabilized before testing. Power was applied and the maximum change in frequency was recorded within one minute.
4. With power OFF, the temperature was raised in 10°C step up to 50°C . The EUT was stabilized at each step for at least half an hour. Power was applied and the maximum frequency change was recorded within one minute.

3.9.3 Test Procedures for Voltage Variation

1. The testing follows ANSI C63.26 section 5.6.5
2. The EUT was placed in a temperature chamber at $20\pm 5^{\circ}\text{C}$ and connected with the system simulator.
3. The power supply voltage to the EUT was varied from 85% to 115% of the nominal value for other than hand carried battery equipment.
4. For hand carried, battery powered equipment, reduce the primary ac or dc supply voltage to the battery operating end point, which shall be specified by the manufacturer.
5. The variation in frequency was measured for the worst case.

4 Radiated Test Items

4.1 Measuring Instruments

See list of measuring instruments of this test report.

4.2 Test Setup

4.2.1 For radiated test below 30MHz

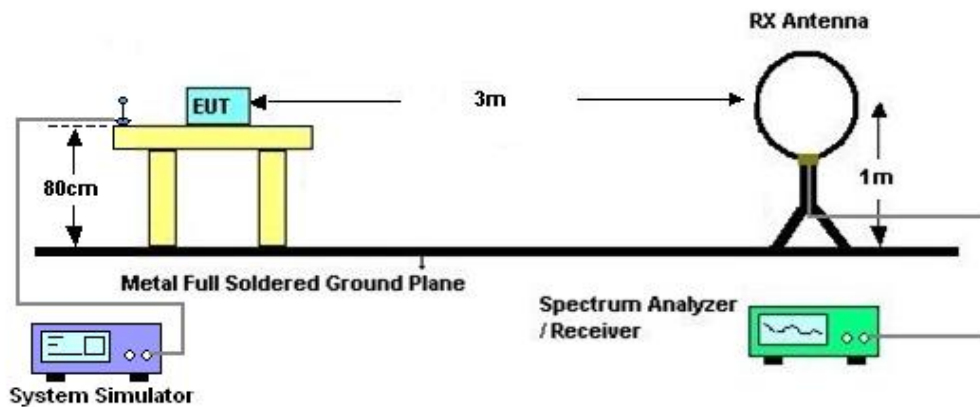

4.2.2 For radiated test from 30MHz to 1GHz

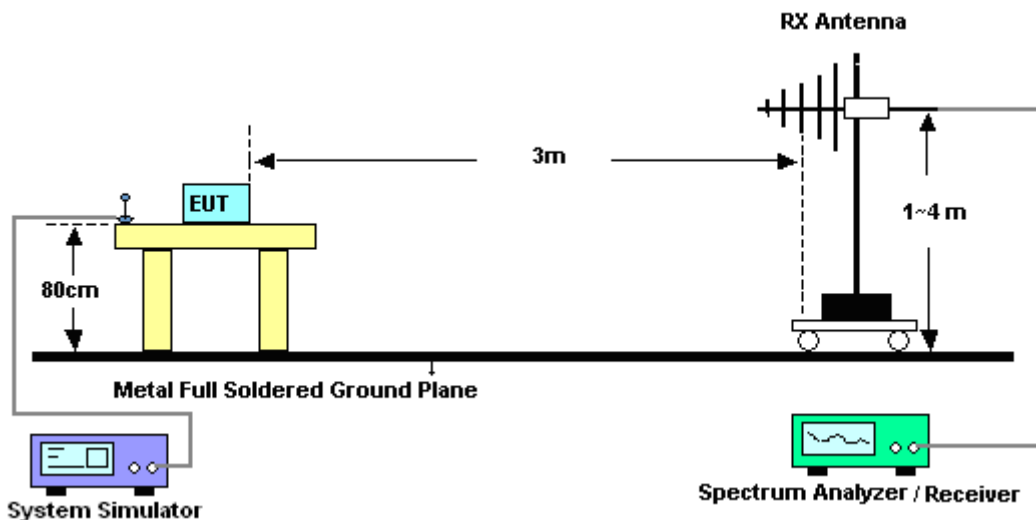

4.2.3 For radiated test above 1GHz

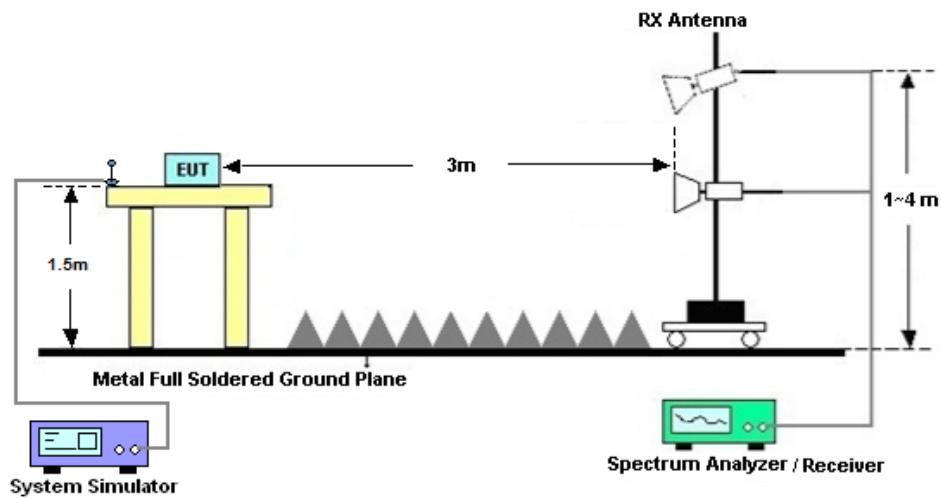

4.3 Test Result of Radiated Test

The low frequency, which started from 9 kHz to 30MHz, was pre-scanned and the result which was 20dB lower than the limit line was not reported.

Please refer to Appendix B.



4.4 Radiated Spurious Emission

4.4.1 Description of Radiated Spurious Emission

The radiated spurious emission was measured by substitution method according to ANSI C63.26. The power of any emission outside of the authorized operating frequency ranges must be attenuated below the transmitter power (P) by a factor of at least $43 + 10 \log (P)$ dB.

The spectrum is scanned from 30 MHz up to a frequency including its 10th harmonic.

4.4.2 Test Procedures

1. The testing follows ANSI C63.26 Section 5.5
2. The EUT was placed on a turntable with 0.8 meter height for frequency below 1GHz and 1.5 meter height for frequency above 1GHz respectively above ground.
3. The EUT was set 3 meters from the receiving antenna mounted on the antenna tower.
4. The table was rotated 360 degrees to determine the position of the highest spurious emission.
5. The height of the receiving antenna is varied between 1m to 4m to search the maximum spurious emission for both horizontal and vertical polarizations.
6. During the measurement, the system simulator parameters were set to force the EUT transmitting at maximum output power.
7. Make the measurement with the spectrum analyzer's RBW = 1MHz, VBW = 3MHz, taking the record of maximum spurious emission.
8. A horn antenna was substituted in place of the EUT and was driven by a signal generator.
9. Tune the output power of signal generator to the same emission level with EUT maximum spurious emission.
10. $EIRP \text{ (dBm)} = S.G. \text{ Power} - Tx \text{ Cable Loss} + Tx \text{ Antenna Gain}$
11. $ERP \text{ (dBm)} = EIRP - 2.15$
12. The RF fundamental frequency should be excluded against the limit line in the operating frequency band.

The limit line is derived from $43 + 10\log(P)$ dB below the transmitter power P(Watts)
= $P(W) - [43 + 10\log(P)] \text{ (dB)}$
= $[30 + 10\log(P)] \text{ (dBm)} - [43 + 10\log(P)] \text{ (dB)}$
= -13dBm.



5 List of Measuring Equipment

Instrument	Manufacturer	Model No.	Serial No.	Characteristics	Calibration Date	Test Date	Due Date	Remark
Spectrum Analyzer	R&S	FSV40	101078	10Hz~40GHz	Apr. 09, 2024	Oct. 29, 2024	Apr. 08, 2025	Conducted (TH01-SZ)
DC Power Supply	TTI	PL330P	290070	Max 32V , 3A	Oct. 15, 2024	Oct. 29, 2024	Oct. 14, 2025	Conducted (TH01-SZ)
Power Divider	TOJOIN	PS-2SM-04 265	60.06.020.007 7	0.4GHz~26.5GHz	Dec. 25, 2023	Oct. 29, 2024	Dec. 24, 2024	Conducted (TH01-SZ)
Thermal Chamber	Ten Billion Hongzhangroup	LP-150U	H2014081803	-40~+150°C	Jul. 03, 2024	Oct. 29, 2024	Jul. 02, 2025	Conducted (TH01-SZ)
EMI Test Receiver&SA	Agilent	N9038A	MY52260185	20Hz~26.5GHz	Dec. 27, 2023	Oct. 28, 2024	Dec. 26, 2024	Radiation (03CH01-SZ)
Loop Antenna	R&S	HFH2-Z2E	101141	9kHz~30MHz	Dec. 29, 2023	Oct. 28, 2024	Dec. 28, 2024	Radiation (03CH01-SZ)
Bilog Antenna	TeseQ	CBL6112D	35407	30MHz-2GHz	Oct. 24, 2023	Oct. 28, 2024	Oct. 23, 2025	Radiation (03CH01-SZ)
Double Ridge Horn Antenna	ETS-Lindgren	3117	00119436	1GHz~18GHz	Jul. 04, 2024	Oct. 28, 2024	Jul. 03, 2025	Radiation (03CH01-SZ)
SHF-EHF Horn	com-power	AH-840	101071	18Ghz-40GHz	Apr. 09,2024	Oct. 28, 2024	Apr. 08,2025	Radiation (03CH01-SZ)
LF Amplifier	Burgeon	BPA-530	102209	0.01~3000Mhz	Apr. 09, 2024	Oct. 28, 2024	Apr. 08, 2025	Radiation (03CH01-SZ)
HF Amplifier	MITEQ	AMF-7D-00 101800-30-1	1943528	1GHz~18GHz	Oct. 17, 2024	Oct. 28, 2024	Oct. 16, 2025	Radiation (03CH01-SZ)
HF Amplifier	KEYSIGHT	83017A	MY53270105	0.5GHz~26.5Ghz	Oct. 17, 2024	Oct. 28, 2024	Oct. 16, 2025	Radiation (03CH01-SZ)
HF Amplifier	MITEQ	TTA1840-35 -HG	1871923	18GHz~40GHz	Jul. 03, 2024	Oct. 28, 2024	Jul. 02, 2025	Radiation (03CH01-SZ)
AC Power Source	Chroma	61601	61601000198 5	N/A	Oct. 17, 2024	Oct. 28, 2024	Oct. 16, 2025	Radiation (03CH01-SZ)
Turn Table	EM	EM1000	N/A	0~360 degree	NCR	Oct. 28, 2024	NCR	Radiation (03CH01-SZ)
Antenna Mast	EM	EM1000	N/A	1 m~4 m	NCR	Oct. 28, 2024	NCR	Radiation (03CH01-SZ)

NCR: No Calibration Required



6 Measurement Uncertainty

The measurement uncertainties shown below were calculated in accordance with the requirements of ANSI 63.26-2015. All the measurement uncertainty value were shown with a coverage K=2 to indicate 95% level of confidence. The measurement data show herein meets or exceeds the CISPR measurement uncertainty values specified in CISPR 16-4-2 and can be compared directly to specified limit to determine compliance.

Uncertainty of Conducted Measurement

Test Item	Uncertainty
Conducted Spurious Emission & Bandedge	±1.34 dB
Occupied Channel Bandwidth	±0.012 MHz
Conducted Power	±1.34 dB
Peak to Average Ratio	±1.34 dB
Frequency Stability	±1.3 Hz

Uncertainty of Radiated Emission Measurement (30 MHz ~ 1000 MHz)

Measuring Uncertainty for a Level of Confidence of 95% (U = 2Uc(y))	2.48 dB
---	---------

Uncertainty of Radiated Emission Measurement (1 GHz ~ 18 GHz)

Measuring Uncertainty for a Level of Confidence of 95% (U = 2Uc(y))	3.53 dB
---	---------

Uncertainty of Radiated Emission Measurement (18 GHz ~ 40 GHz)

Measuring Uncertainty for a Level of Confidence of 95% (U = 2Uc(y))	4.02 dB
---	---------

----- THE END -----



Appendix A. Test Results of Conducted Test

Test Engineer :	Jason Wang	Temperature :	22~23°C
		Relative Humidity :	40~42%

Conducted Output Power(Average power) and ERP

LTE Band5 Ant0

BW [MHz]	Modulation	RB Size	RB Offset	Power Low Ch. / Freq.	Power Middle Ch. / Freq.	Power High Ch. / Freq.	ERP(W)		
Channel				20450	20525	20600	ERP(W)		
Frequency (MHz)				829	836.5	844	L	M	H
10	QPSK	1	0	23.34	23.35	23.35	0.0500	0.0501	0.0501
10	QPSK	1	25	23.43	23.44	23.43	0.0511	0.0512	0.0511
10	QPSK	1	49	23.34	23.29	23.29	0.0500	0.0494	0.0494
10	QPSK	25	0	22.49	22.53	22.45	0.0411	0.0415	0.0407
10	QPSK	25	12	22.45	22.44	22.42	0.0407	0.0406	0.0405
10	QPSK	25	25	22.48	22.45	22.34	0.0410	0.0407	0.0397
10	QPSK	50	0	22.48	22.50	22.45	0.0410	0.0412	0.0407
10	16QAM	1	0	22.50	22.63	22.58	0.0412	0.0425	0.0420
10	64QAM	1	0	21.43	21.53	21.47	0.0322	0.0330	0.0325
Channel				20425	20525	20625	ERP(W)		
Frequency (MHz)				826.5	836.5	846.5	L	M	H
5	QPSK	1	0	23.22	23.33	23.31	0.0486	0.0499	0.0497
5	16QAM	1	0	22.45	22.61	22.51	0.0407	0.0423	0.0413
Channel				20415	20525	20635	ERP(W)		
Frequency (MHz)				825.5	836.5	847.5	L	M	H
3	QPSK	1	0	23.20	23.30	23.30	0.0484	0.0495	0.0495
3	16QAM	1	0	22.48	22.57	22.48	0.0410	0.0419	0.0410
Channel				20407	20525	20643	ERP(W)		
Frequency (MHz)				824.7	836.5	848.3	L	M	H
1.4	QPSK	1	0	23.23	23.24	23.22	0.0488	0.0489	0.0486
1.4	16QAM	1	0	22.35	22.51	22.52	0.0398	0.0413	0.0414



LTE Band 5

Peak-to-Average Ratio

Mode	LTE Band 5 / 10MHz			
Mod.	QPSK	16QAM	64QAM	Limit: 13dB
RB Size	Full RB	Full RB	Full RB	Result
Middle CH	5.10	5.86	6.26	PASS



LTE Band 5 / 10MHz / QPSK

Middle Channel / Full RB

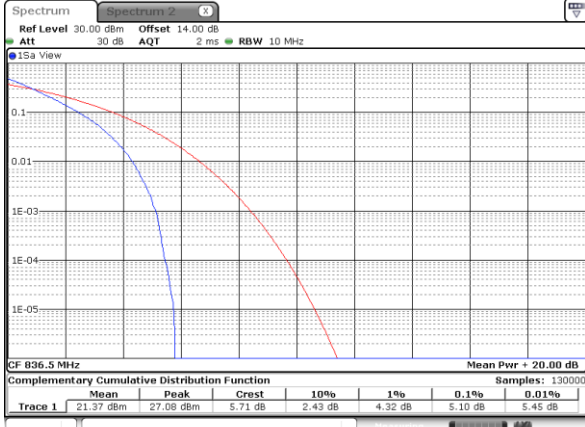

Date: 29 OCT 2024 08:41:02

LTE Band 5 / 10MHz / 16QAM

Middle Channel / Full RB

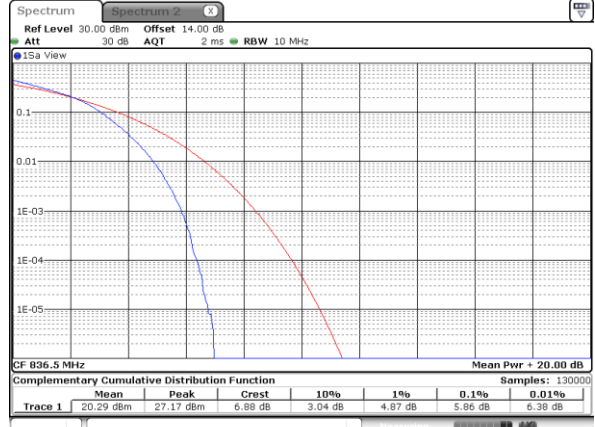

Date: 29 OCT 2024 08:41:27

LTE Band 5 / 10MHz / 64QAM

Middle Channel / Full RB

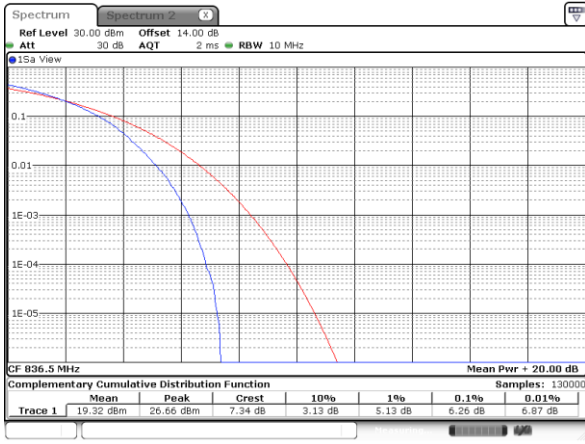

Date: 29 OCT 2024 08:41:52



26dB Bandwidth

Mode	LTE Band 5 : 26dB BW(MHz)											
	1.4MHz		3MHz		5MHz		10MHz		15MHz		20MHz	
Mod.	QPSK	16QAM	QPSK	16QAM	QPSK	16QAM	QPSK	16QAM	QPSK	16QAM	QPSK	16QAM
Middle CH	1.27	1.26	2.96	2.97	4.93	4.84	9.79	9.71	-	-	-	-



LTE Band 5

Middle Channel / 1.4MHz / QPSK

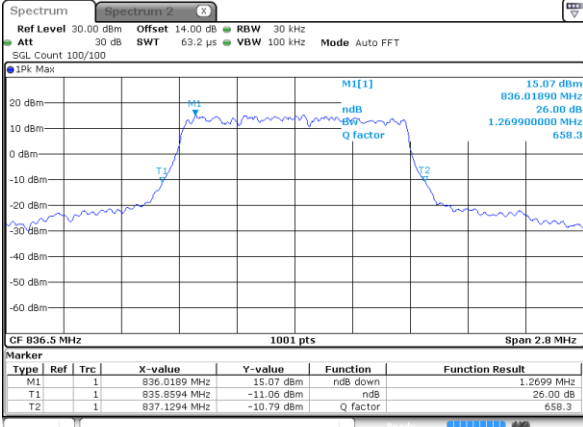

Date: 29 OCT 2024 07:56:04

Middle Channel / 1.4MHz / 16QAM

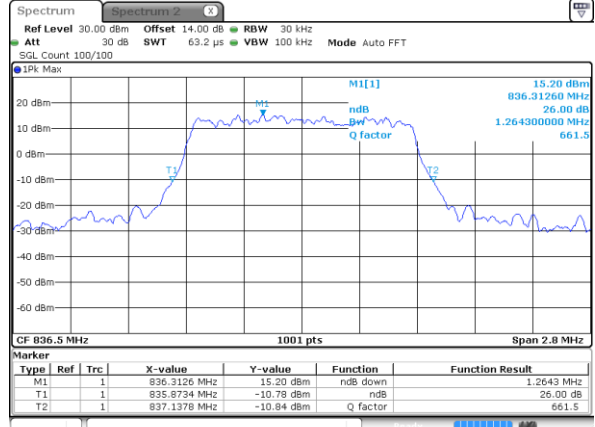

Date: 29 OCT 2024 07:56:47

Middle Channel / 3MHz / QPSK

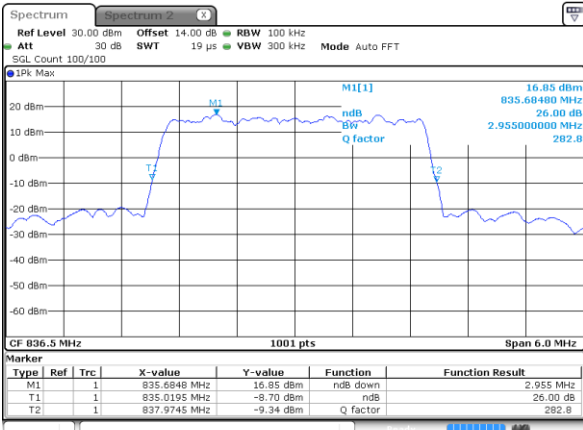

Date: 29 OCT 2024 08:12:13

Middle Channel / 3MHz / 16QAM

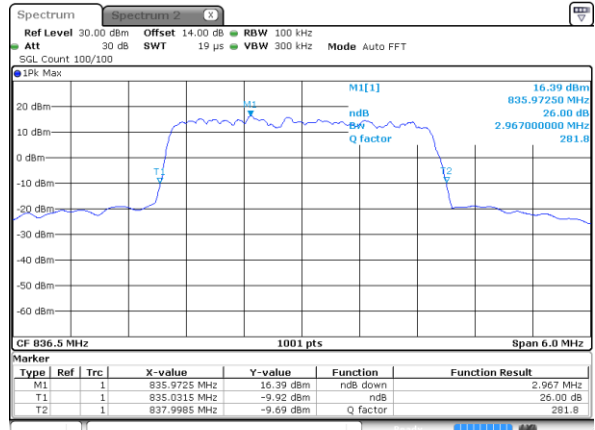

Date: 29 OCT 2024 08:12:51

Middle Channel / 5MHz / QPSK

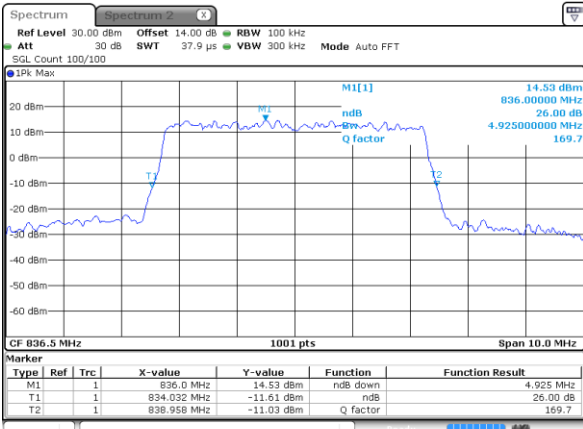

Date: 29 OCT 2024 08:26:10

Middle Channel / 5MHz / 16QAM

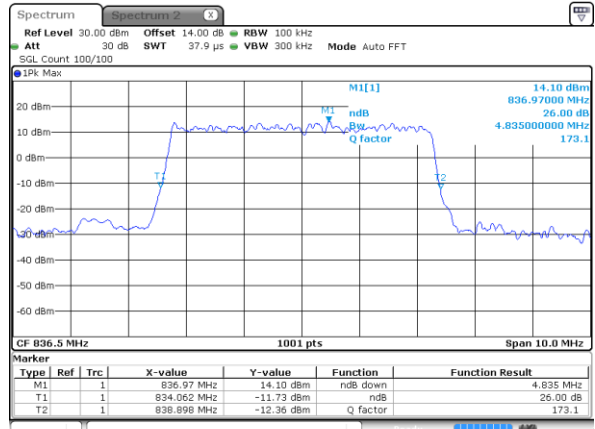

Date: 29 OCT 2024 08:26:48



LTE Band 5

Middle Channel / 10MHz / QPSK

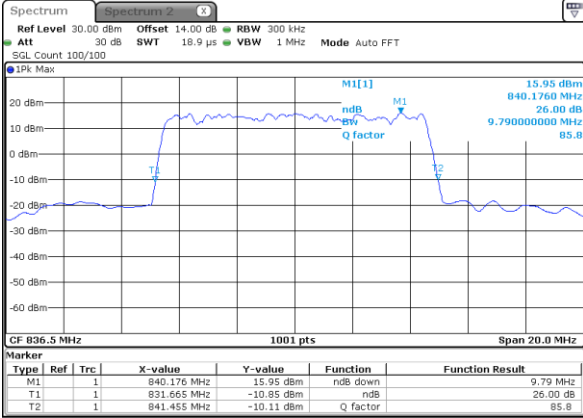

Middle Channel / 10MHz / 16QAM

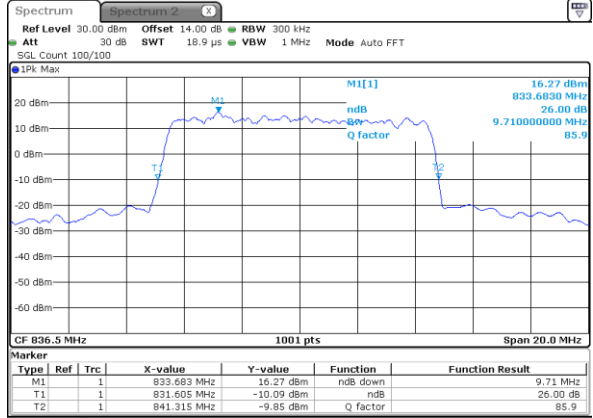



Occupied Bandwidth

Mode	LTE Band 5 : 99%OBW(MHz)											
	1.4MHz		3MHz		5MHz		10MHz		15MHz		20MHz	
Mod.	QPSK	16QAM	QPSK	16QAM	QPSK	16QAM	QPSK	16QAM	QPSK	16QAM	QPSK	16QAM
Middle CH	1.09	1.09	2.70	2.72	4.50	4.48	9.07	8.97	-	-	-	-



LTE Band 5

Middle Channel / 1.4MHz / QPSK

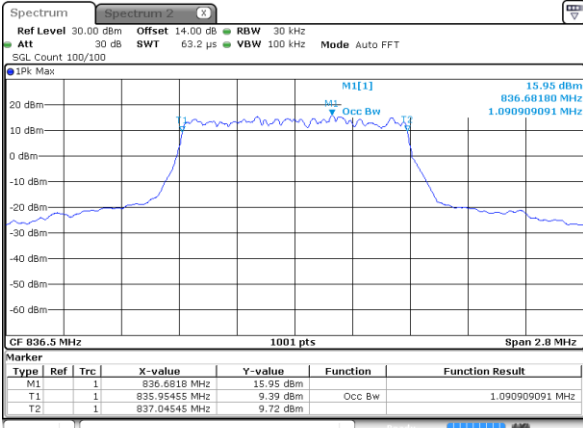

Middle Channel / 1.4MHz / 16QAM

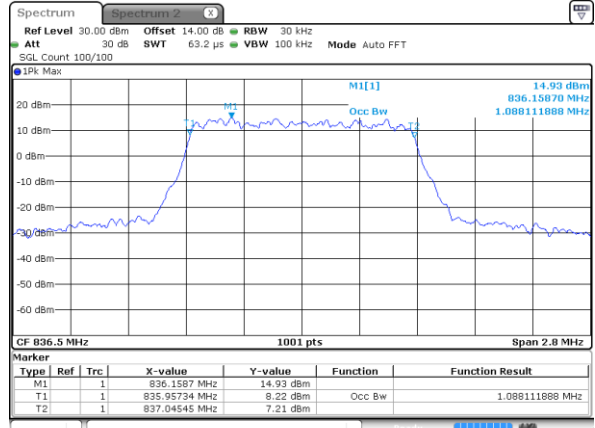

Middle Channel / 3MHz / QPSK

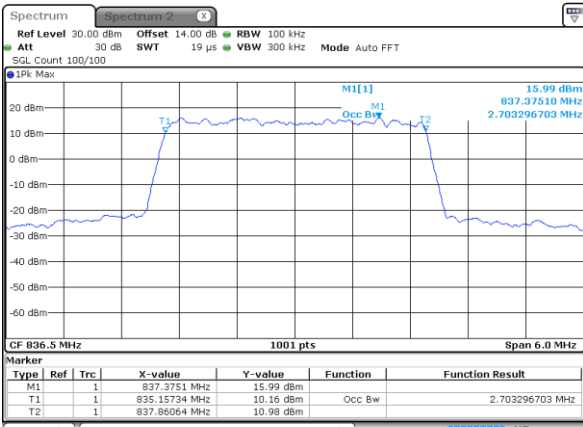

Middle Channel / 3MHz / 16QAM

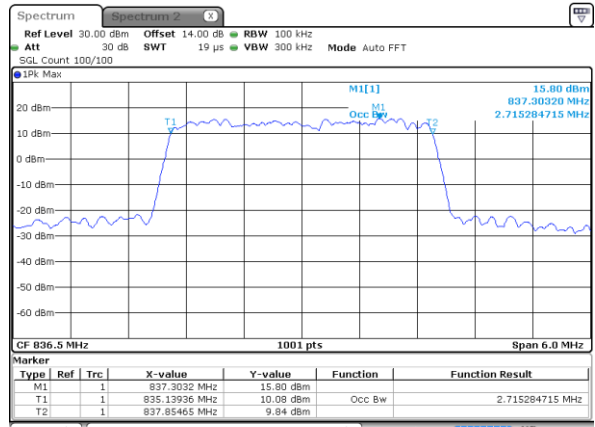

Middle Channel / 5MHz / QPSK

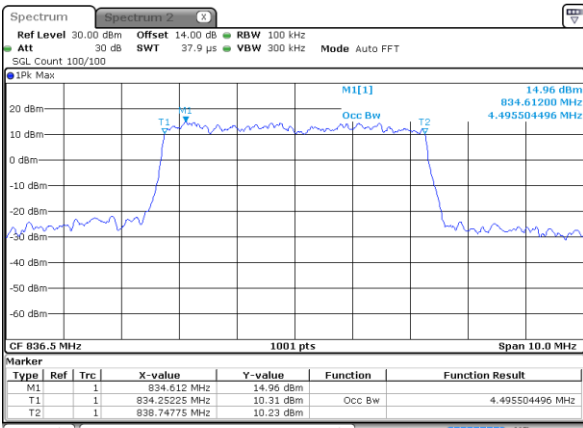

Middle Channel / 5MHz / 16QAM

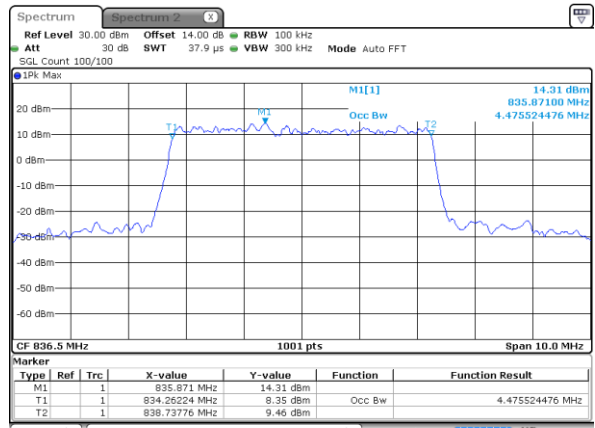



LTE Band 5

Middle Channel / 10MHz / QPSK

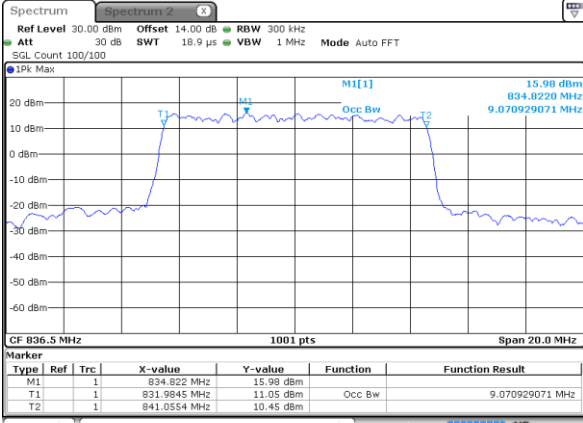

Date: 29 OCT 2024 08:39:47

Middle Channel / 10MHz / 16QAM

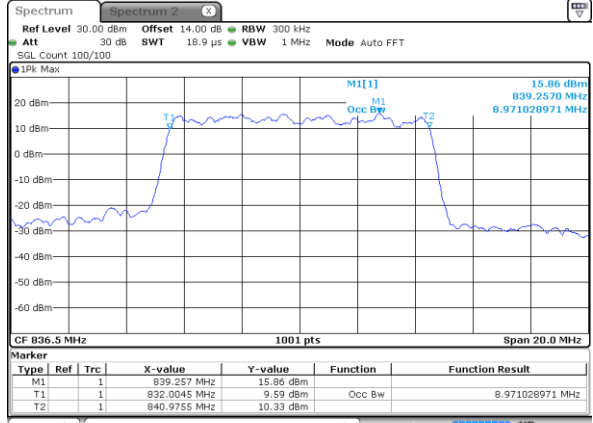

Date: 29 OCT 2024 08:40:24



Conducted Band Edge

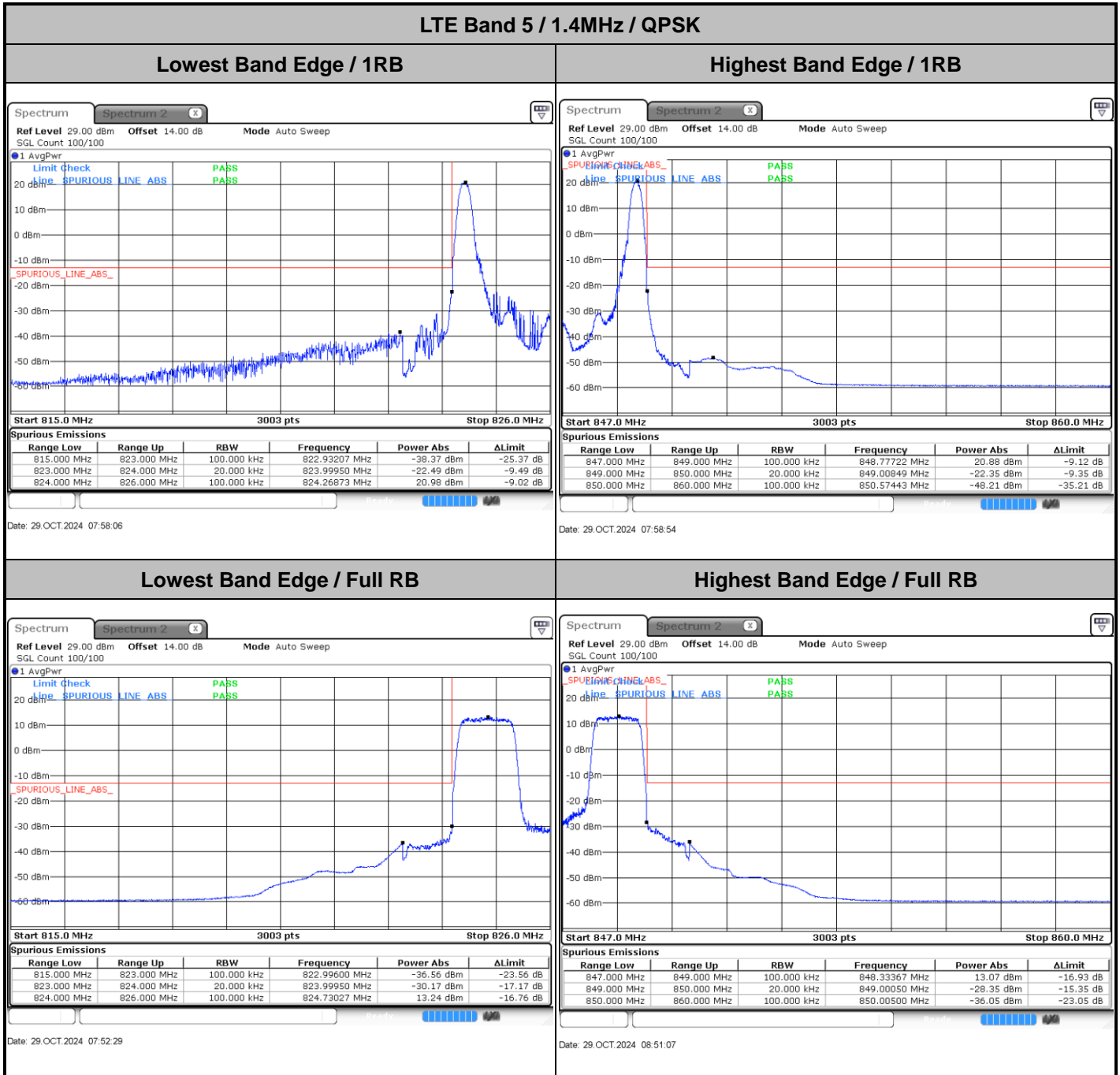



LTE Band 5 / 1.4MHz / 16QAM

Lowest Band Edge / 1 RB



Date: 29.OCT.2024 07:57:34

Highest Band Edge / 1 RB

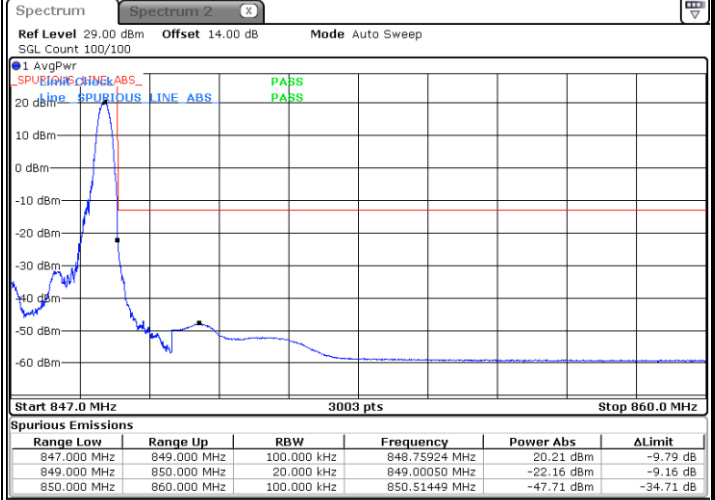

Date: 29.OCT.2024 08:01:54

Lowest Band Edge / Full RB

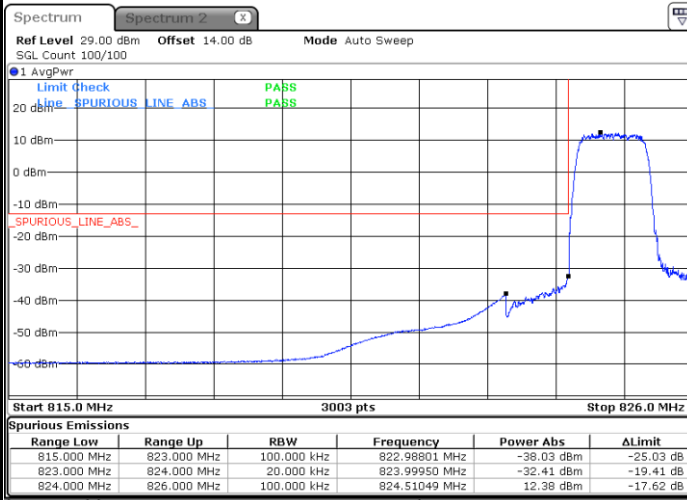

Date: 29.OCT.2024 07:53:35

Highest Band Edge / Full RB

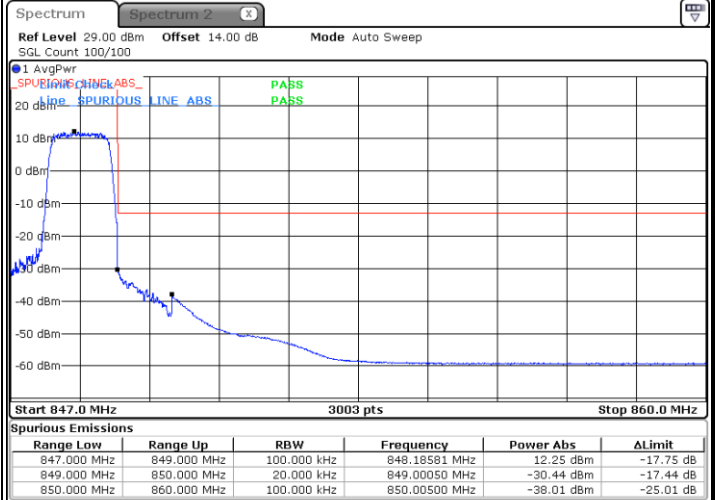

Date: 29.OCT.2024 08:57:14



LTE Band 5 / 1.4MHz / 64QAM

Lowest Band Edge / 1 RB

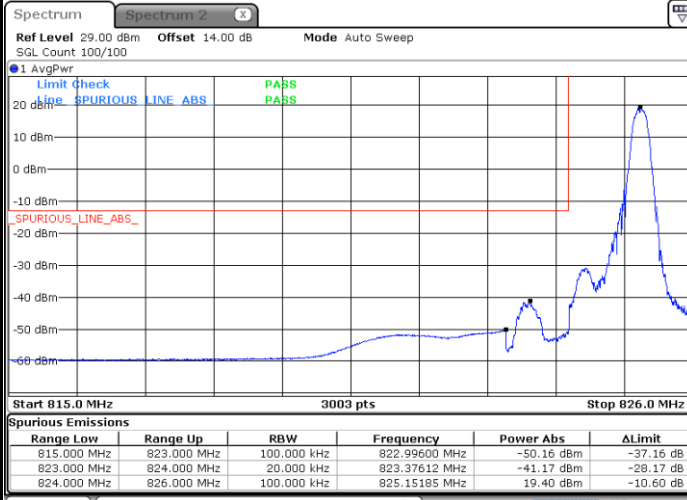

Date: 29.OCT.2024 07:59:42

Highest Band Edge / 1 RB

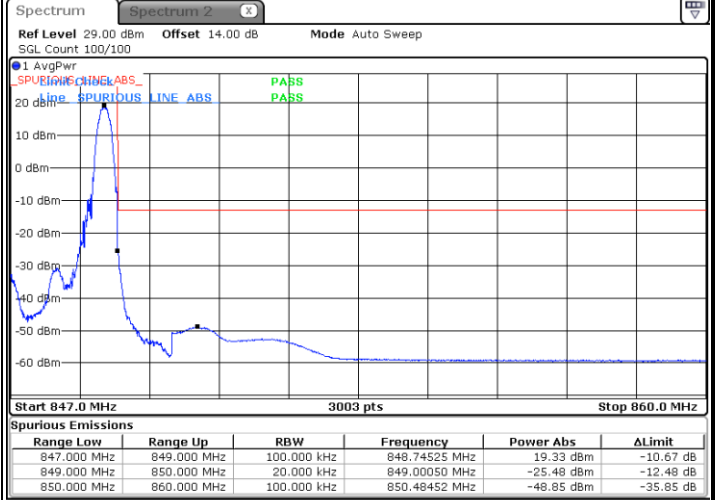

Date: 29.OCT.2024 08:04:23

Lowest Band Edge / Full RB

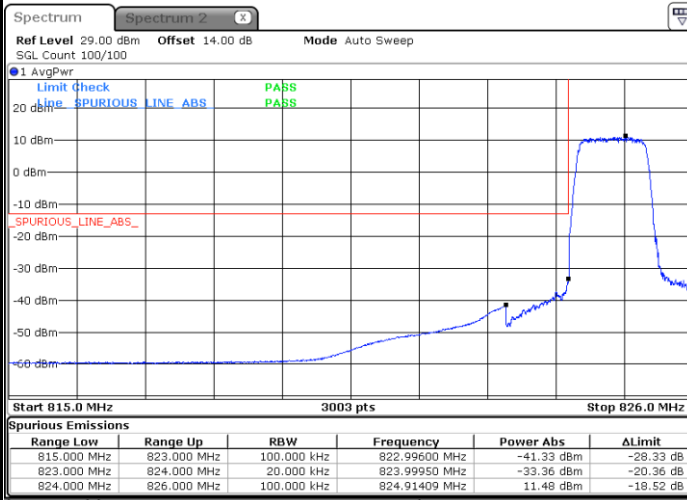

Date: 29.OCT.2024 07:54:08

Highest Band Edge / Full RB

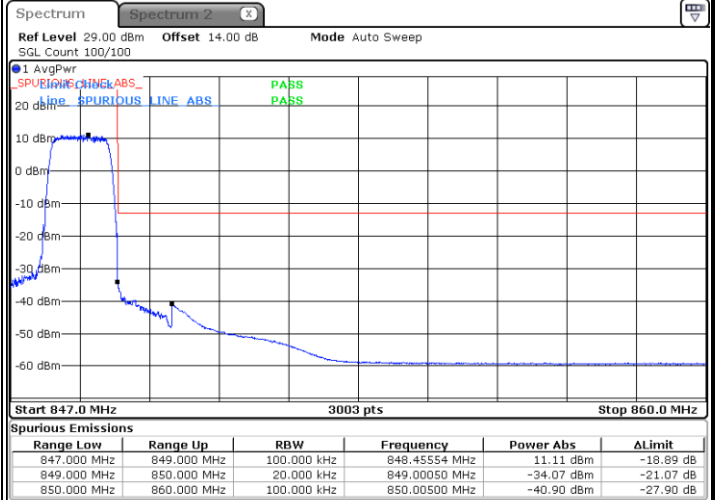

Date: 29.OCT.2024 09:00:48



LTE Band 5 / 3MHz / QPSK

Lowest Band Edge / 1RB

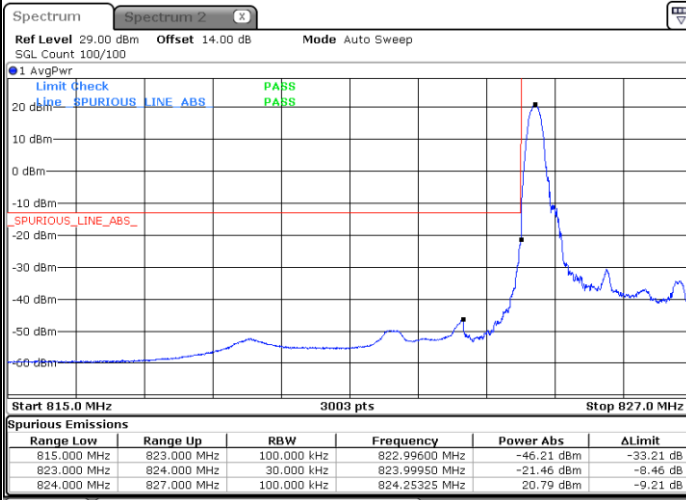

Date: 29.OCT.2024 08:06:04

Highest Band Edge / 1RB

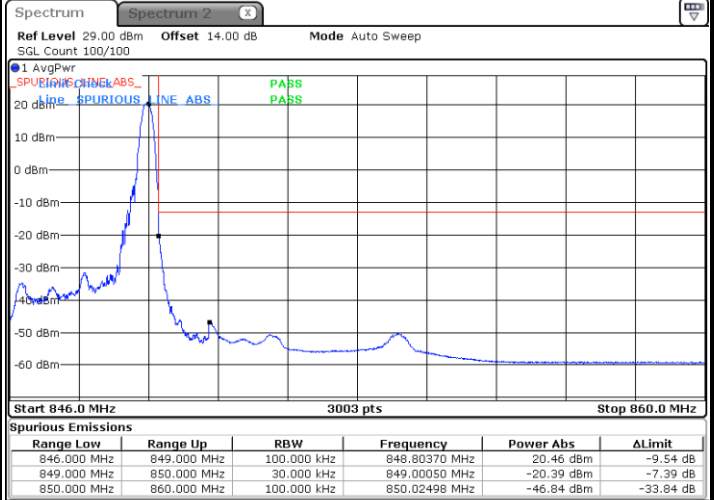

Date: 29.OCT.2024 08:13:40

Lowest Band Edge / Full RB

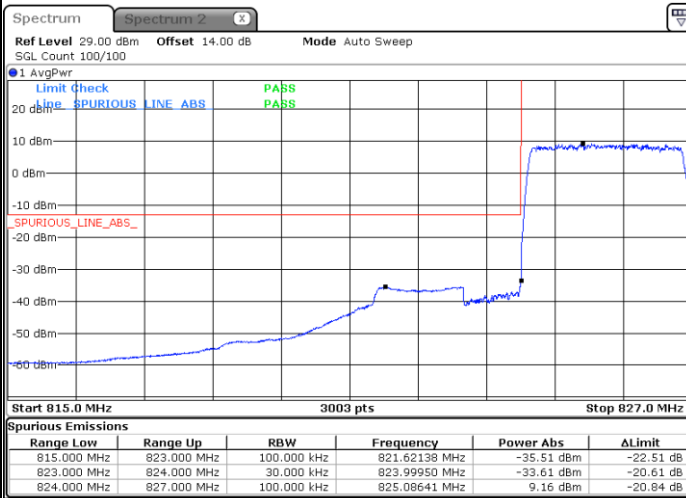

Date: 29.OCT.2024 08:08:31

Highest Band Edge / Full RB

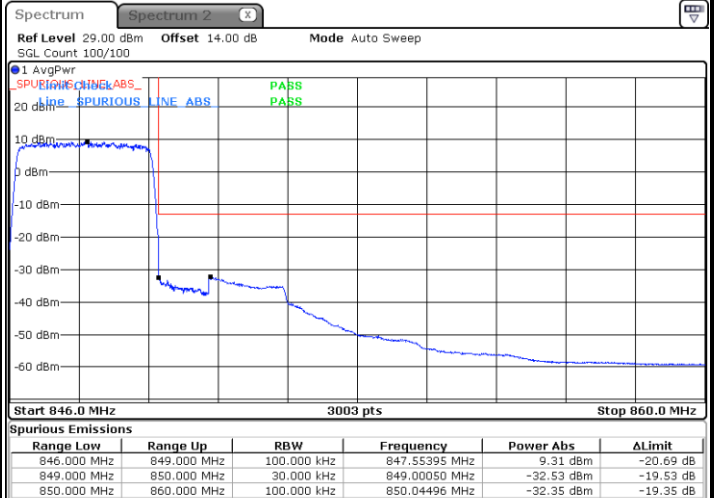

Date: 29.OCT.2024 08:16:13



LTE Band 5 / 3MHz / 16QAM

Lowest Band Edge / 1 RB

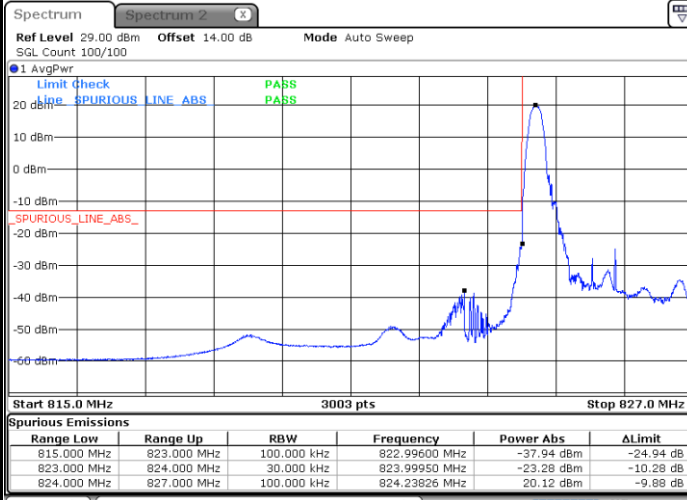

Date: 29.OCT.2024 08:06:53

Highest Band Edge / 1 RB

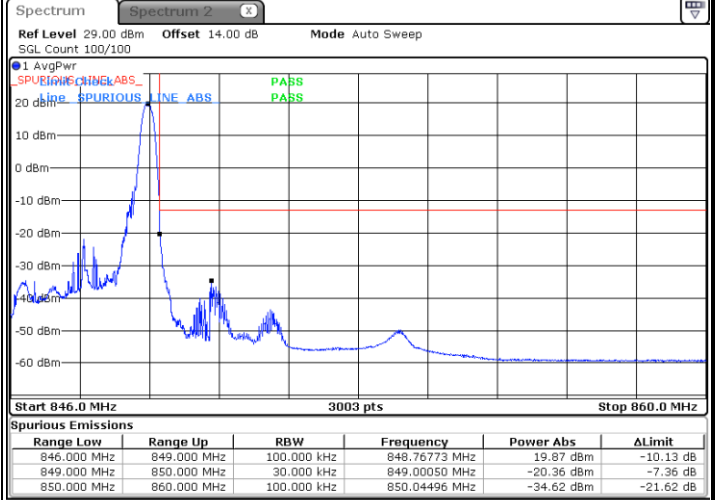

Date: 29.OCT.2024 08:14:35

Lowest Band Edge / Full RB

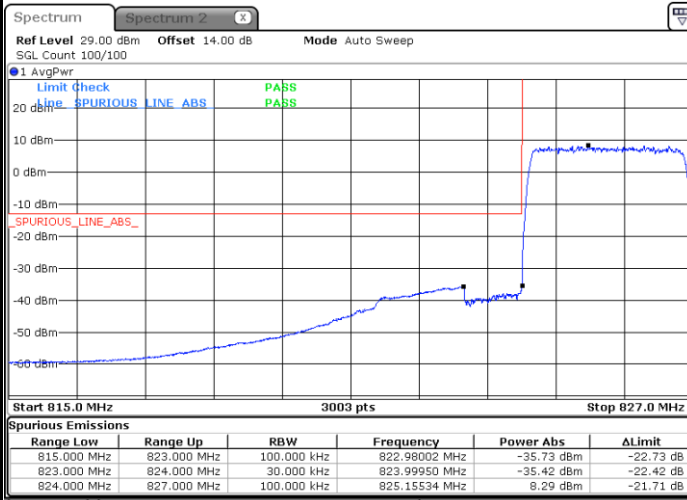

Date: 29.OCT.2024 08:09:20

Highest Band Edge / Full RB

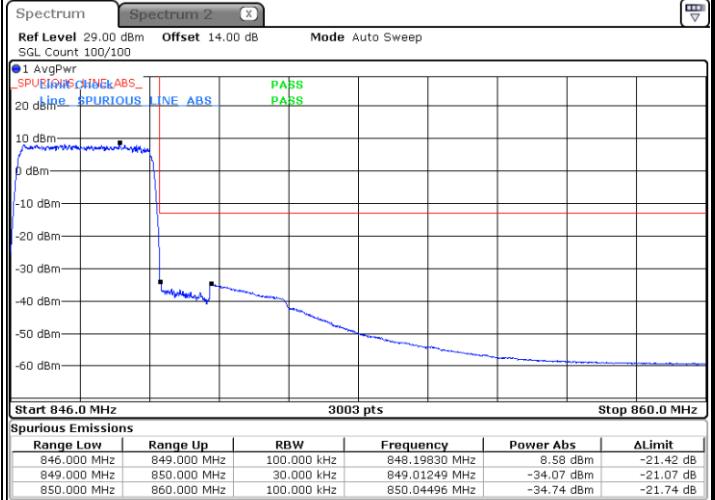

Date: 29.OCT.2024 08:17:02



LTE Band 5 / 3MHz / 64QAM

Lowest Band Edge / 1 RB

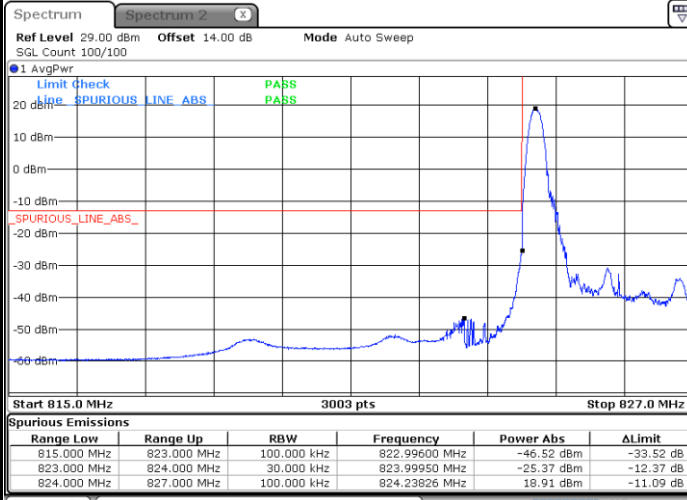

Date: 29.OCT.2024 08:07:42

Highest Band Edge / 1 RB

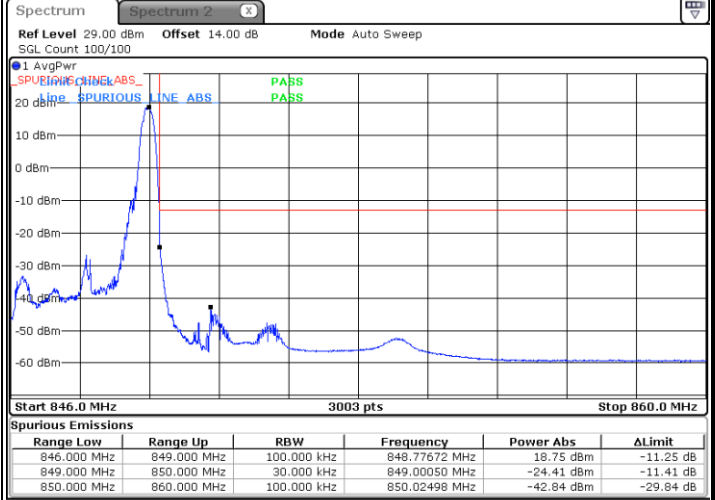

Date: 29.OCT.2024 08:15:24

Lowest Band Edge / Full RB

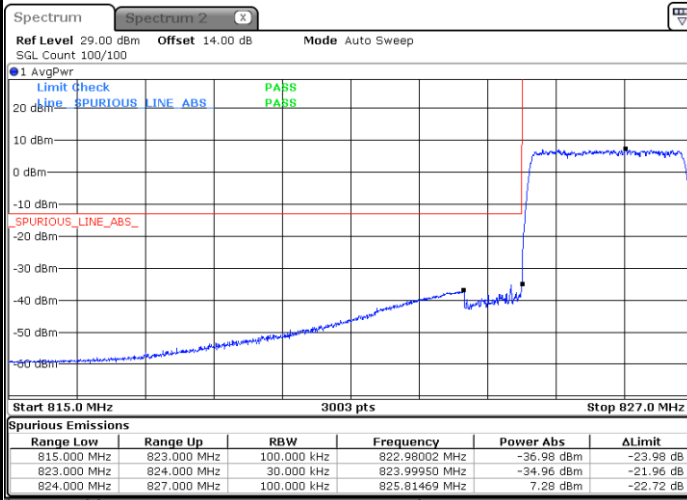

Date: 29.OCT.2024 08:10:09

Highest Band Edge / Full RB

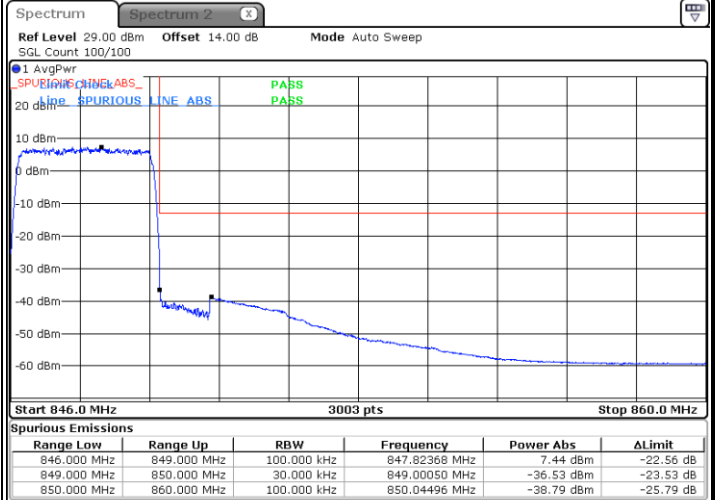

Date: 29.OCT.2024 08:17:51



LTE Band 5 / 5MHz / QPSK

Lowest Band Edge / 1RB

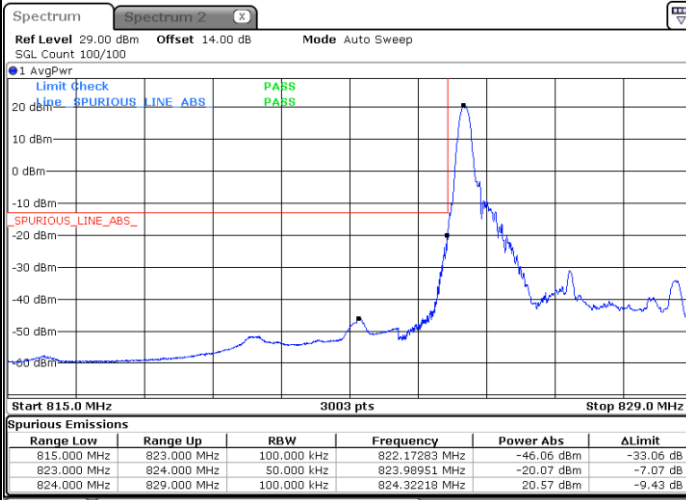

Date: 29.OCT.2024 08:20:02

Highest Band Edge / 1RB



Date: 29.OCT.2024 08:27:36

Lowest Band Edge / Full RB

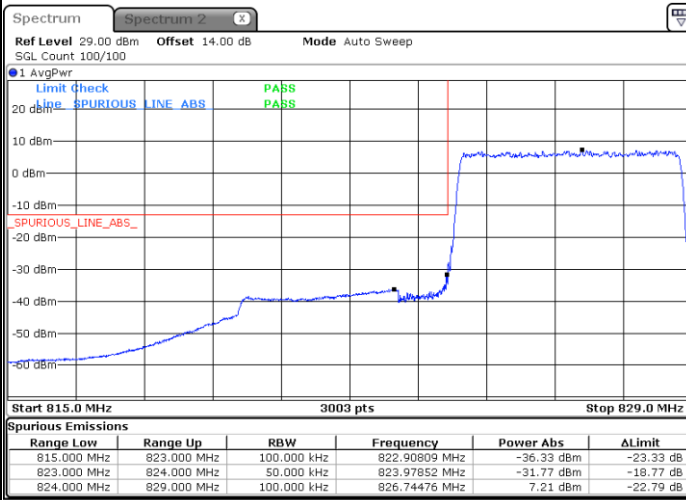

Date: 29.OCT.2024 08:22:29

Highest Band Edge / Full RB

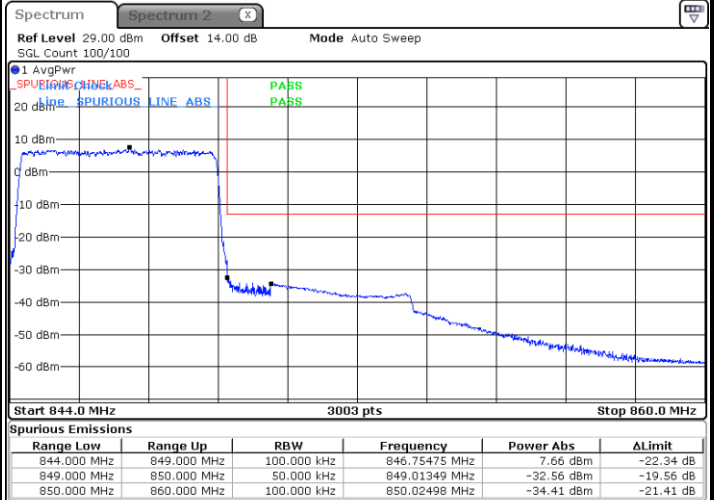

Date: 29.OCT.2024 08:30:03



LTE Band 5 / 5MHz / 16QAM

Lowest Band Edge / 1 RB

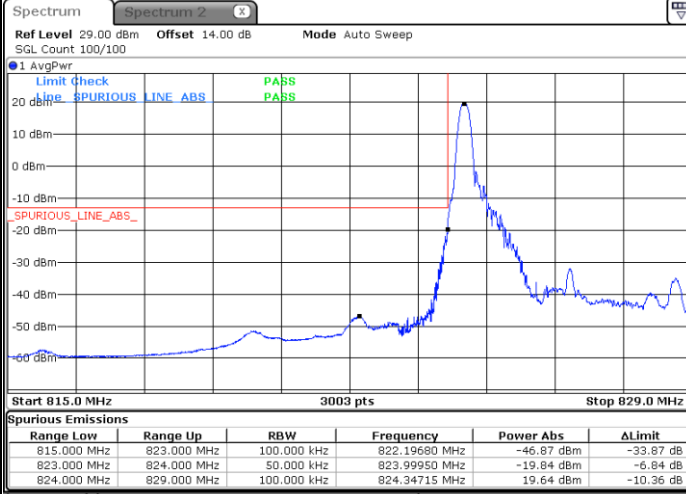

Highest Band Edge / 1 RB



Lowest Band Edge / Full RB

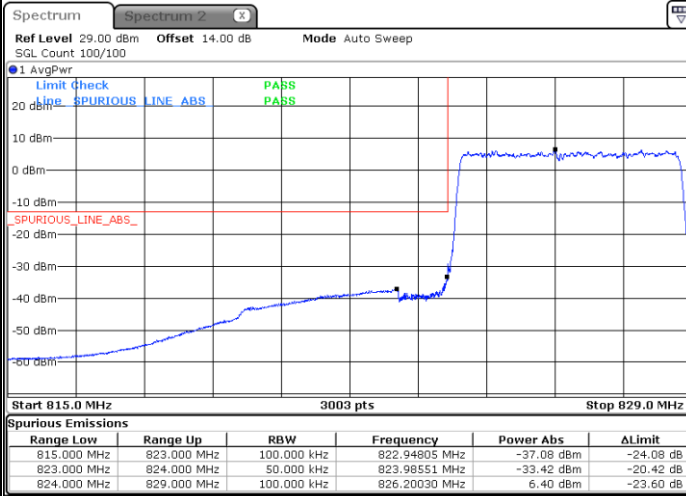

Highest Band Edge / Full RB

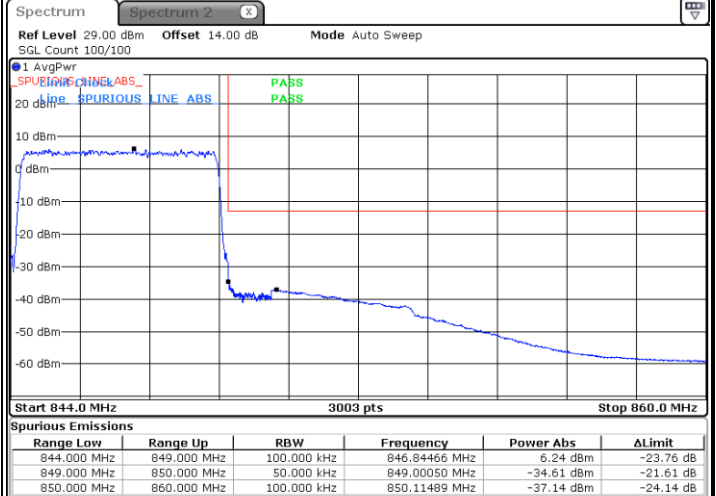



LTE Band 5 / 5MHz / 64QAM

Lowest Band Edge / 1 RB

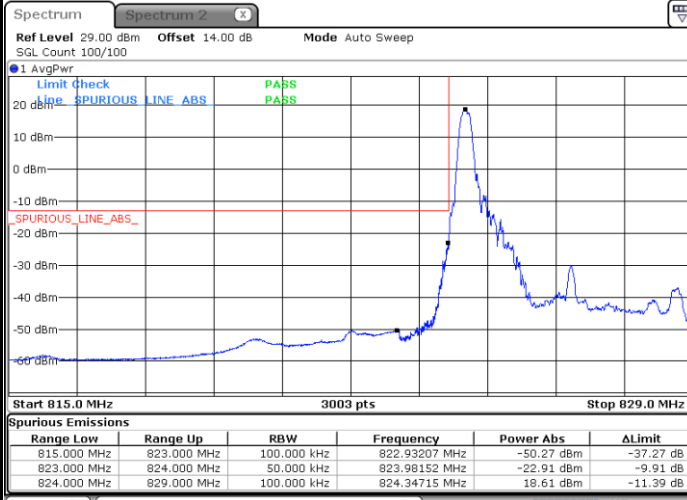

Date: 29.OCT.2024 08:21:40

Highest Band Edge / 1 RB

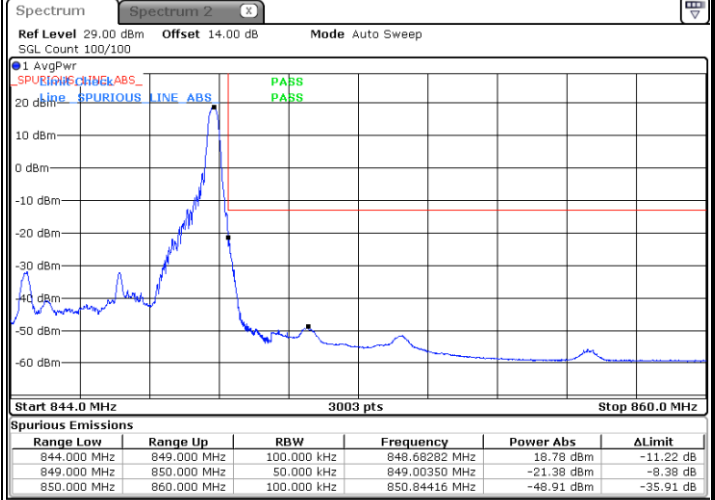

Date: 29.OCT.2024 08:29:14

Lowest Band Edge / Full RB

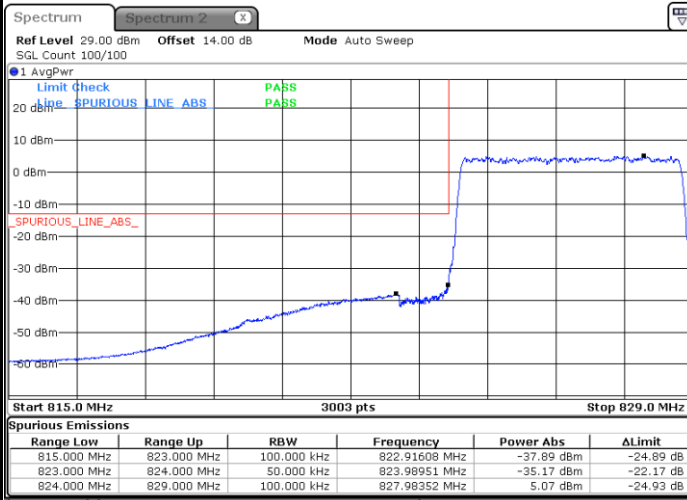

Date: 29.OCT.2024 08:24:07

Highest Band Edge / Full RB

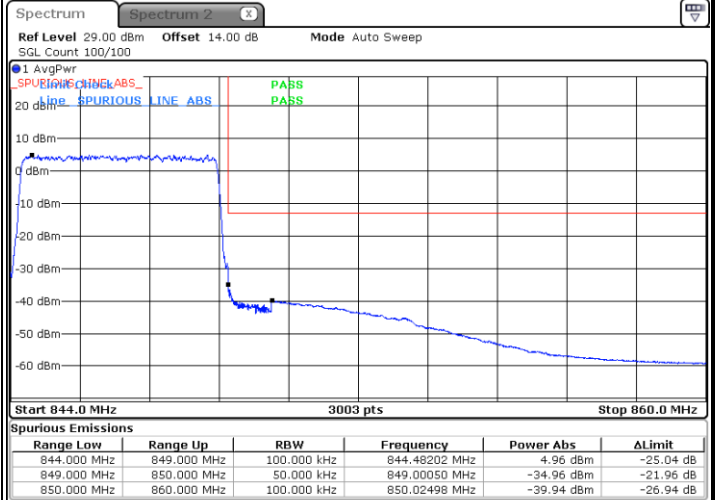

Date: 29.OCT.2024 08:31:41



LTE Band 5 / 10MHz / QPSK

Lowest Band Edge / 1RB

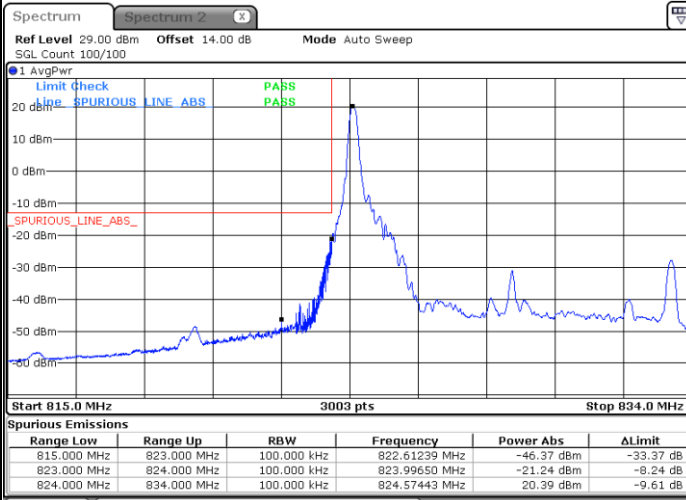

Date: 29.OCT.2024 08:33:52

Highest Band Edge / 1RB

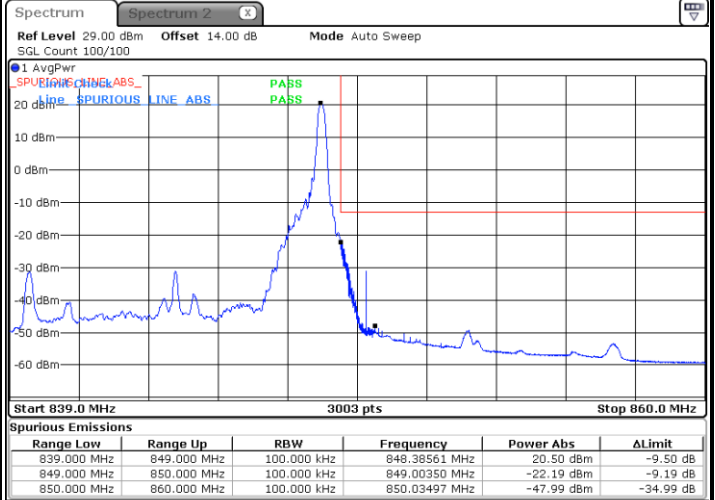

Date: 29.OCT.2024 08:42:40

Lowest Band Edge / Full RB

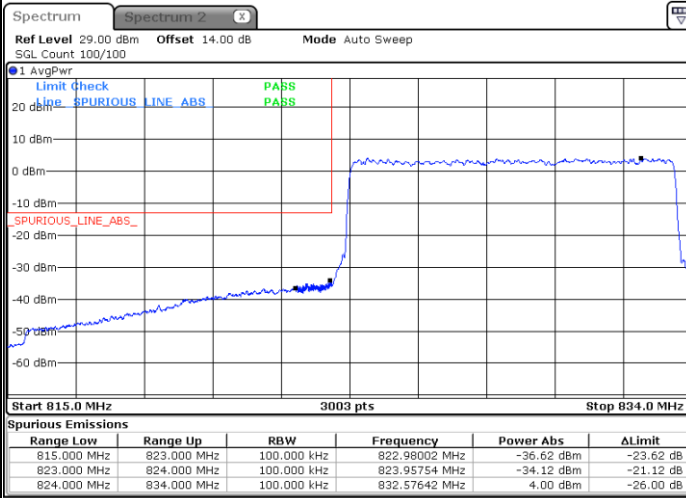

Date: 29.OCT.2024 08:36:19

Highest Band Edge / Full RB

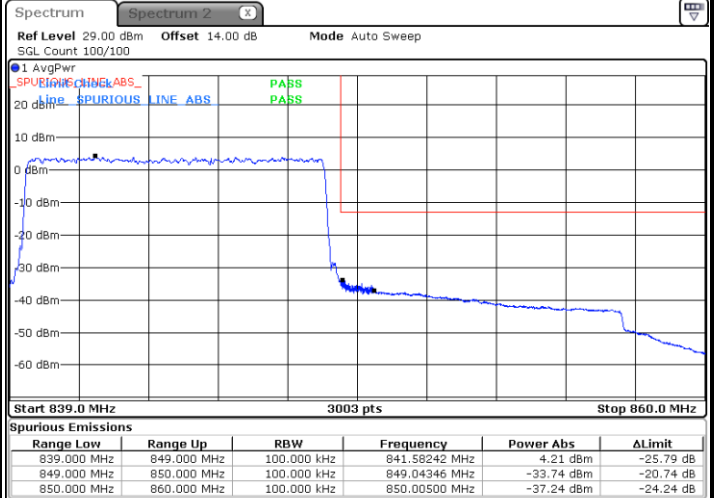

Date: 29.OCT.2024 08:45:07



LTE Band 5 / 10MHz / 16QAM

Lowest Band Edge / 1 RB

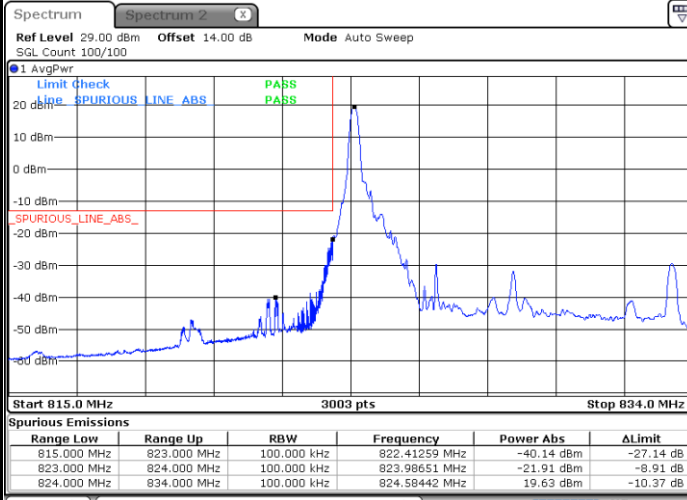

Date: 29.OCT.2024 08:34:41

Highest Band Edge / 1 RB

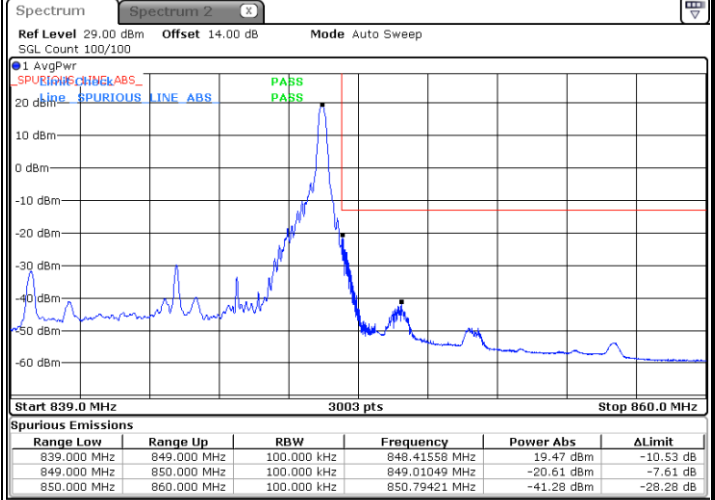

Date: 29.OCT.2024 08:43:29

Lowest Band Edge / Full RB

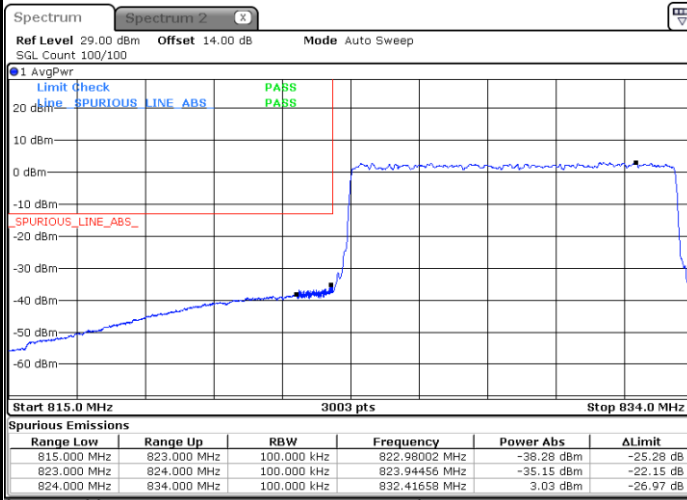

Date: 29.OCT.2024 08:37:08

Highest Band Edge / Full RB

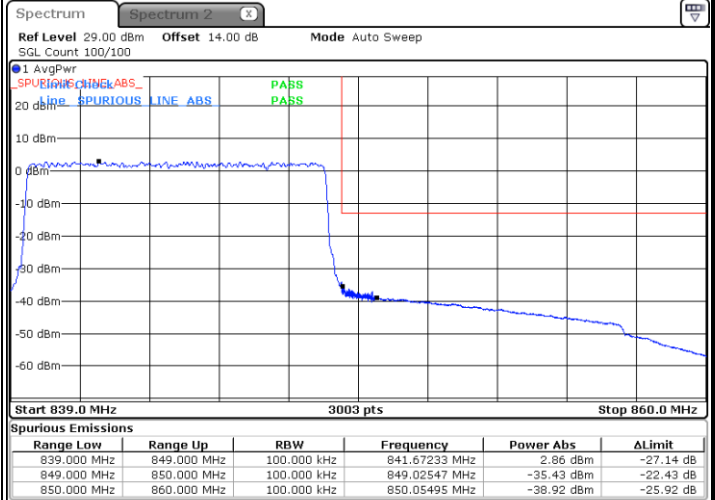

Date: 29.OCT.2024 08:45:56



LTE Band 5 / 10MHz / 64QAM

Lowest Band Edge / 1 RB

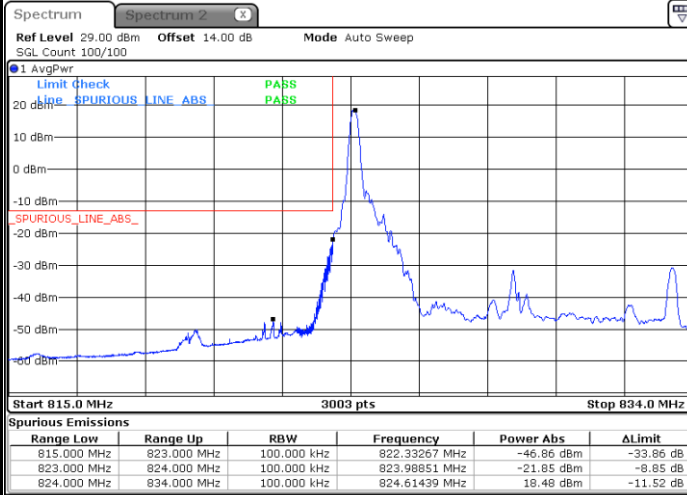

Date: 29.OCT.2024 08:35:30

Highest Band Edge / 1 RB

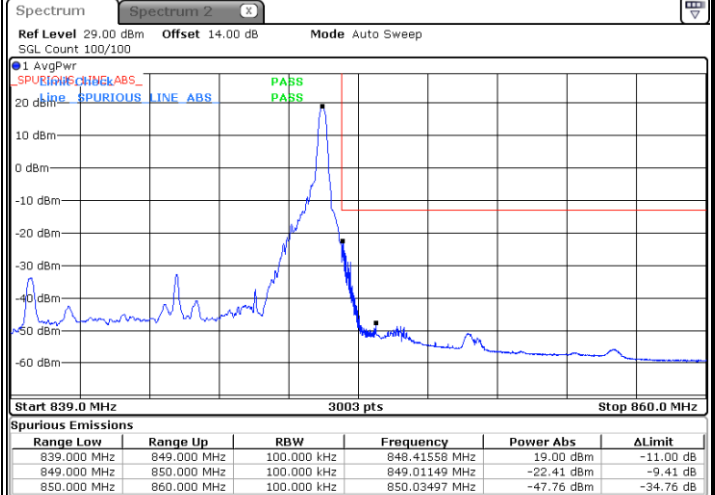

Date: 29.OCT.2024 08:44:18

Lowest Band Edge / Full RB

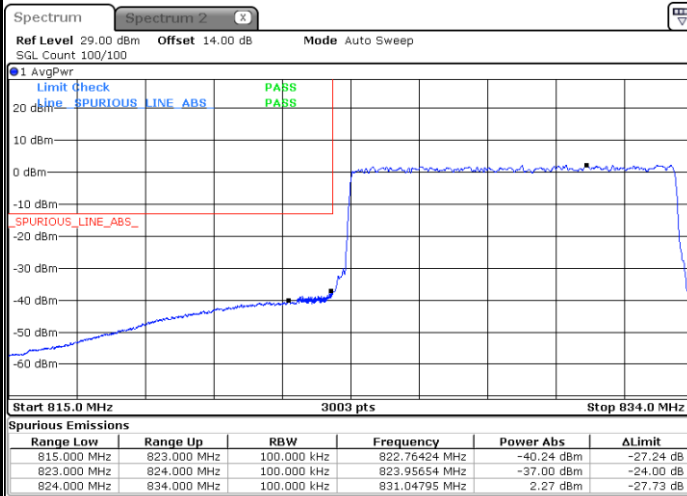

Date: 29.OCT.2024 08:37:57

Highest Band Edge / Full RB

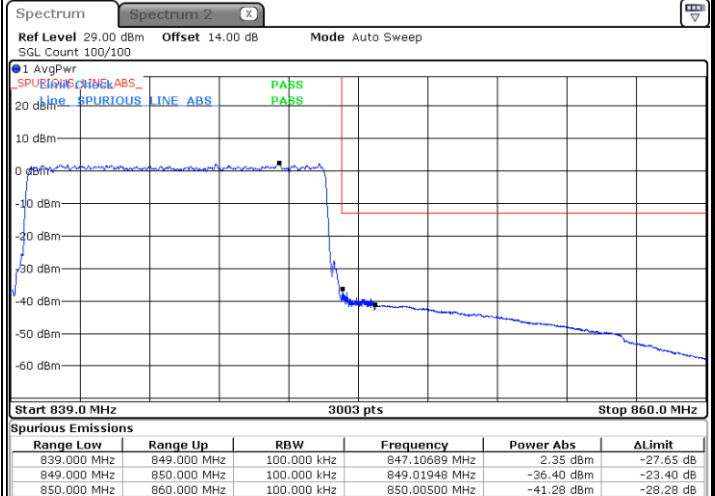

Date: 29.OCT.2024 08:46:45



Conducted Spurious Emission

LTE Band 5 / 1.4MHz

Lowest Channel / QPSK

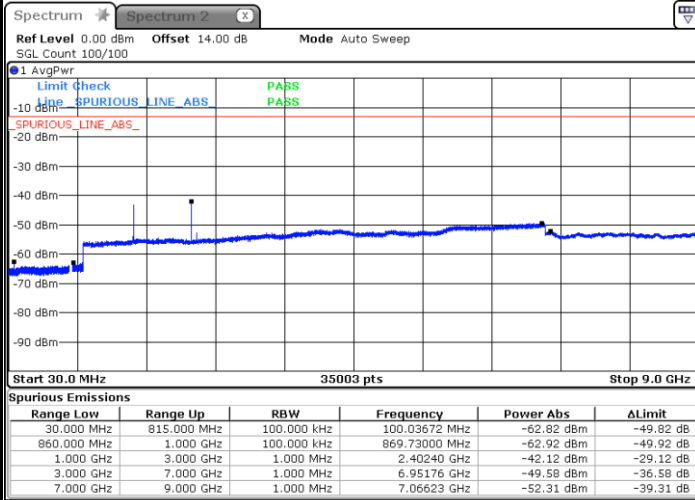

Date: 29.OCT.2024 07:54:45

Middle Channel / QPSK

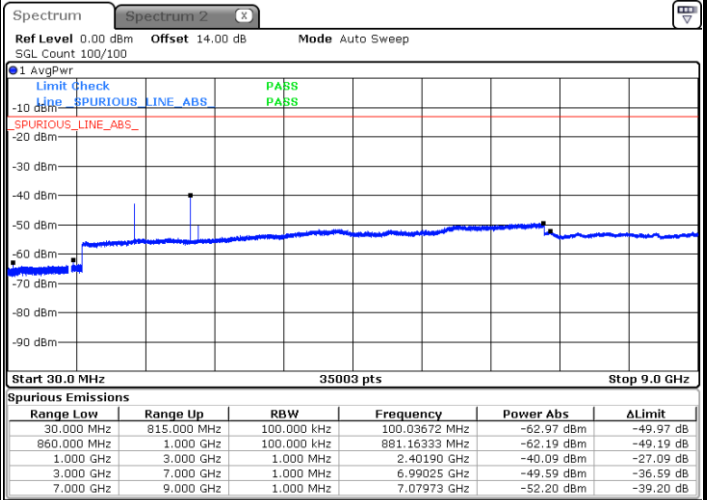

Date: 29.OCT.2024 07:55:35

Highest Channel / QPSK

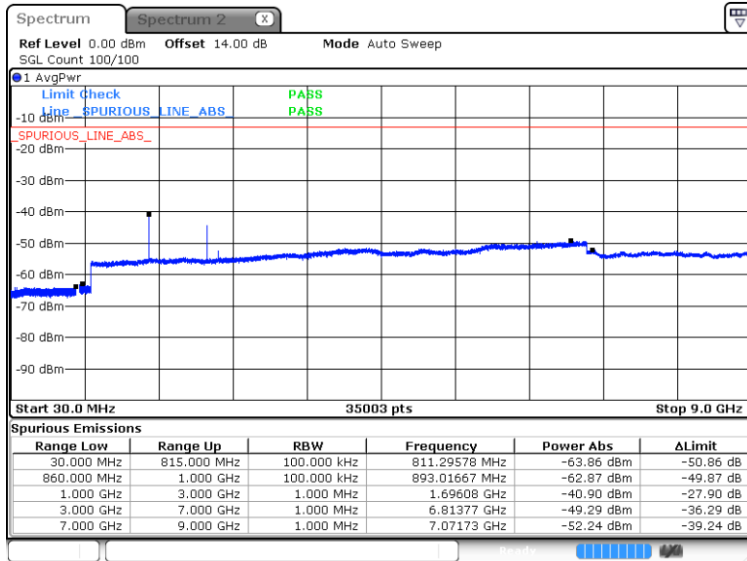

Date: 29.OCT.2024 08:03:22



LTE Band 5 / 3MHz

Lowest Channel / QPSK

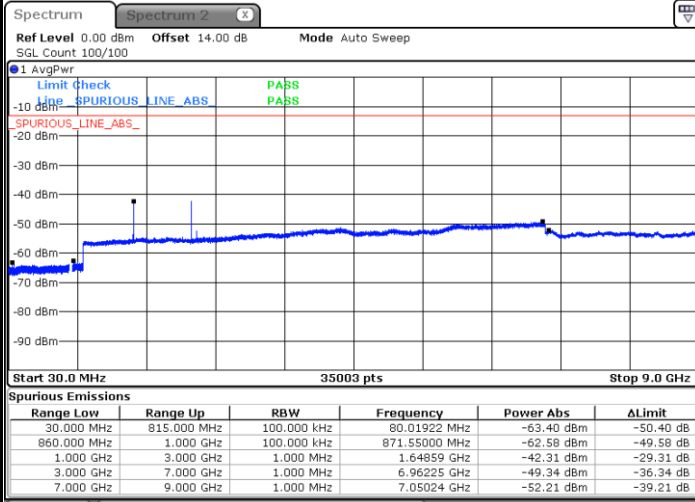

Date: 29.OCT.2024 08:10:53

Middle Channel / QPSK

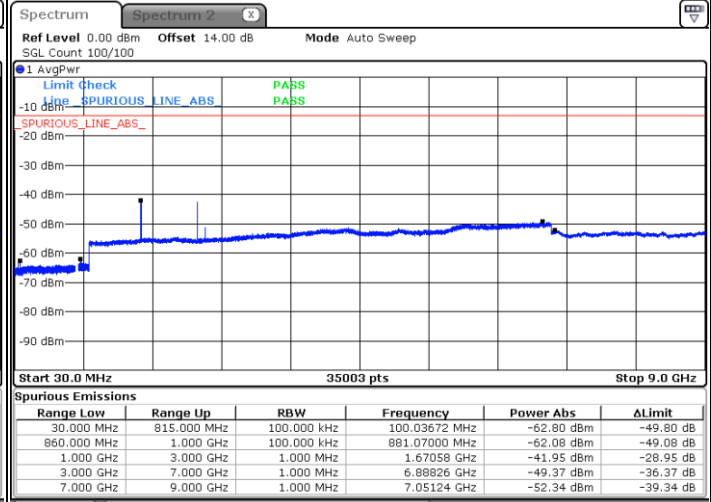

Date: 29.OCT.2024 08:11:55

Highest Channel / QPSK

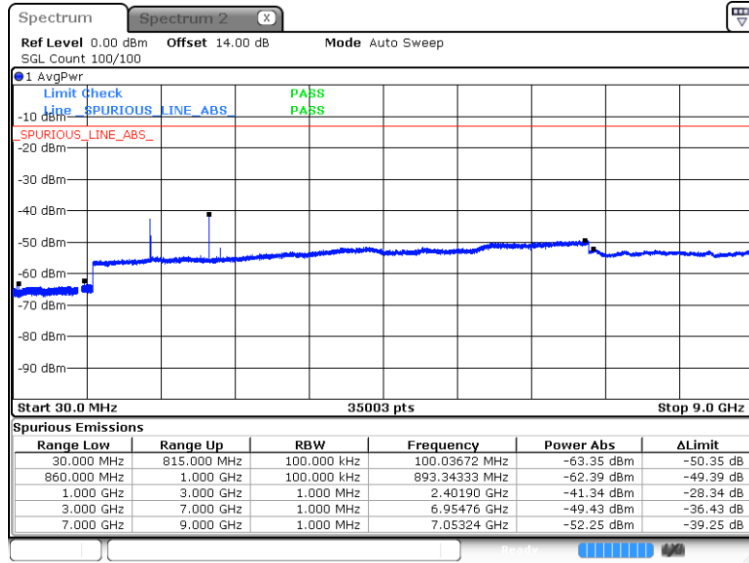

Date: 29.OCT.2024 08:18:34



LTE Band 5 / 5MHz

Lowest Channel / QPSK

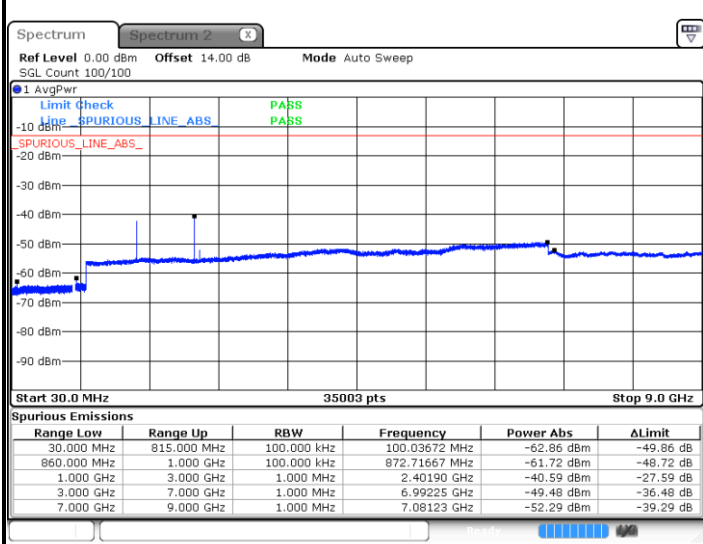

Date: 29.OCT.2024 08:24:50

Middle Channel / QPSK

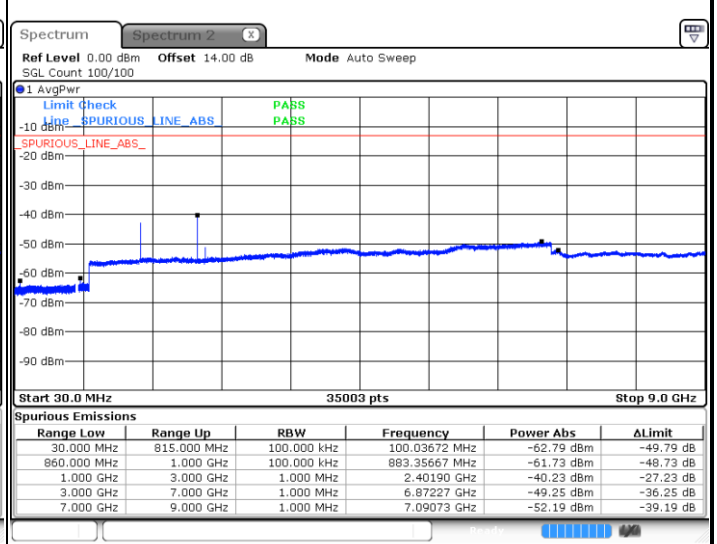

Date: 29.OCT.2024 08:25:33

Highest Channel / QPSK

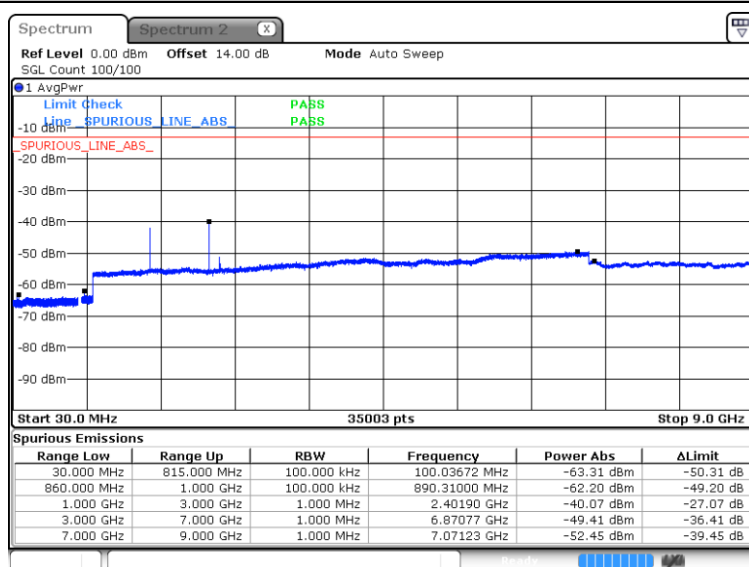

Date: 29.OCT.2024 08:32:24



LTE Band 5 / 10MHz

Lowest Channel / QPSK

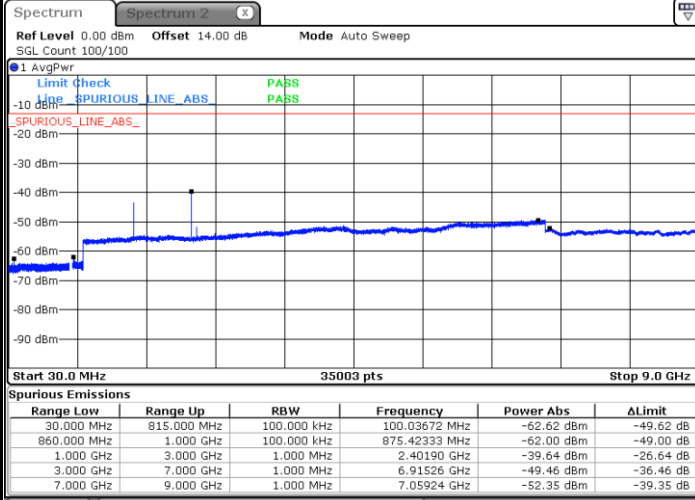

Date: 29.OCT.2024 08:38:40

Middle Channel / QPSK

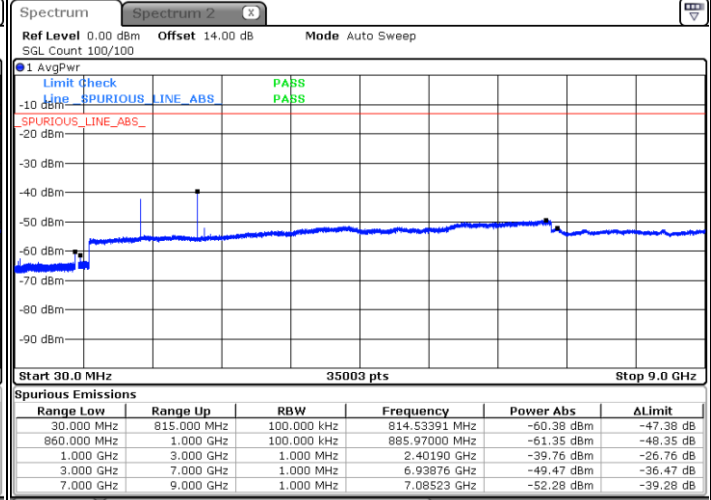

Date: 29.OCT.2024 08:39:23

Highest Channel / QPSK

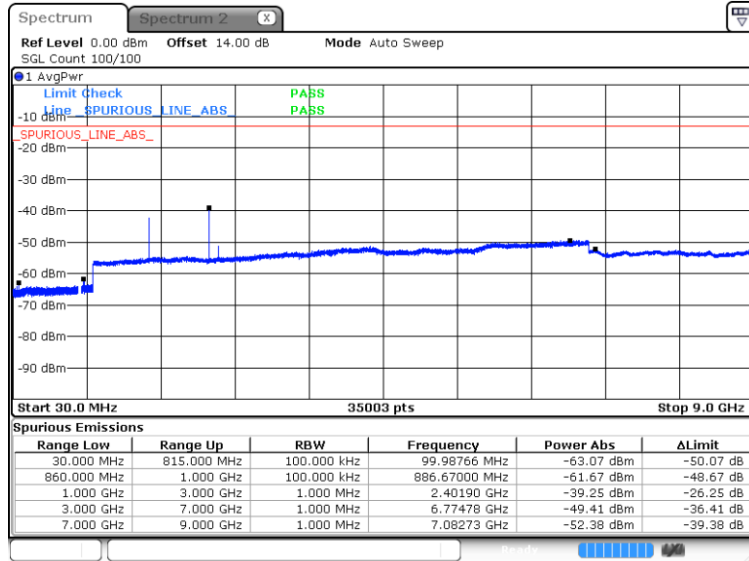

Date: 29.OCT.2024 08:47:29



Frequency Stability

Test Conditions		LTE Band 5 (QPSK) / Middle Channel	Limit
Temperature (°C)	Voltage (Volt)	BW 10MHz	2.5ppm
		Deviation (ppm)	Result
50	Normal Voltage	0.0026	PASS
40	Normal Voltage	0.0031	
30	Normal Voltage	0.0023	
20(Ref.)	Normal Voltage	0.0000	
10	Normal Voltage	0.0013	
0	Normal Voltage	0.0025	
-10	Normal Voltage	0.0018	
-20	Normal Voltage	0.0016	
-30	Normal Voltage	0.0024	
20	Maximum Voltage	0.0031	
20	Normal Voltage	0.0000	
20	Battery End Point	0.0044	

Note:

1. Normal Voltage = 3.91 V. ; Minimum Voltage = 3.5 V. ; Maximum Voltage = 4.45 V.
2. The frequency fundamental emissions stay within the authorized frequency block.



Appendix B. Test Results of Radiated Test

Radiated Spurious Emission

Test Engineer :	Jia Kuang	Temperature :	22~25°C
		Relative Humidity :	48~52%

LTE Band 5 / 20MHz / QPSK/Ant0									
Channel	Frequency (MHz)	ERP (dBm)	Limit (dBm)	Over Limit (dB)	SPA Reading (dBm)	S.G. Power (dBm)	TX Cable loss (dB)	TX Antenna Gain (dBi)	Polarization (H/V)
Middle	1664.18	-64.27	-13	-51.27	-76.47	-67.52	4.00	9.40	H
	2496.27	-58.49	-13	-45.49	-77.86	-62.06	4.88	10.60	H
	3328.36	-58.86	-13	-45.86	-80.11	-63.79	5.52	12.60	H
	1664.18	-64.90	-13	-51.90	-77.77	-68.15	4.00	9.40	V
	2496.27	-60.06	-13	-47.06	-79.69	-63.63	4.88	10.60	V
	3328.36	-58.88	-13	-45.88	-80.63	-63.81	5.52	12.60	V

Remark: Spurious emissions within 30-1000MHz were found more than 20dB below limit line.