



FCC RF Test Report

APPLICANT : Motorola Mobility LLC
EQUIPMENT : Mobile Cellular Phone
BRAND NAME : Motorola
MODEL NAME : XT2523-2, XT2523-8
FCC ID : IHDT56AT3
STANDARD : 47 CFR Part 22(H), 24(E), 27(F), 27(L), 27(M)
CLASSIFICATION : PCS Licensed Transmitter Held to Ear (PCE)
TEST DATE(S) : Sep. 10, 2024 ~ Sep. 29, 2024

We, Sporton International Inc. (Kunshan), would like to declare that the tested sample has been evaluated in accordance with the procedures given in ANSI C63.26-2015 and shown compliance with the applicable technical standards.

The test results in this report apply exclusively to the tested model / sample. Without written approval of Sporton International Inc. (Kunshan), the test report shall not be reproduced except in full.

Jason Jia

Approved by: Jason Jia



Sporton International Inc. (Kunshan)

**No. 1098, Pengxi North Road, Kunshan Economic Development Zone Jiangsu Province 215300
People's Republic of China**



TABLE OF CONTENTS

REVISION HISTORY... 3
SUMMARY OF TEST RESULT ... 4
1 GENERAL DESCRIPTION ... 6
1.1 Applicant ... 6
1.2 Manufacturer ... 6
1.3 Product Feature of Equipment Under Test ... 6
1.4 Product Specification of Equipment Under Test ... 7
1.5 Modification of EUT ... 8
1.6 Specification of Accessory ... 8
1.7 Maximum ERP/EIRP Power and Emission Designator ... 9
1.8 Testing Location ... 11
1.9 Test Software ... 11
1.10 Applicable Standards ... 12
2 TEST CONFIGURATION OF EQUIPMENT UNDER TEST ... 13
2.1 Test Mode ... 13
2.2 Connection Diagram of Test System ... 16
2.3 Support Unit used in test configuration and system ... 16
2.4 Measurement Results Explanation Example ... 16
2.5 Frequency List of Low/Middle/High Channels ... 17
3 CONDUCTED TEST ITEMS ... 21
3.1 Measuring Instruments ... 21
3.2 Test Setup ... 21
3.3 Test Result of Conducted Test ... 21
3.4 Conducted Output Power and ERP/EIRP ... 22
3.5 Peak-to-Average Ratio ... 23
3.6 Occupied Bandwidth ... 24
3.7 Conducted Band Edge ... 25
3.8 Conducted Spurious Emission ... 27
3.9 Frequency Stability ... 28
4 RADIATED TEST ITEMS ... 29
4.1 Measuring Instruments ... 29
4.2 Test Setup ... 29
4.3 Test Result of Radiated Test ... 30
4.4 Radiated Spurious Emission ... 31
5 LIST OF MEASURING EQUIPMENT ... 32
6 MEASUREMENT UNCERTAINTY ... 33
APPENDIX A. TEST RESULTS OF CONDUCTED TEST
APPENDIX B. TEST RESULTS OF RADIATED TEST
APPENDIX C. TEST SETUP PHOTOGRAPHS



SUMMARY OF TEST RESULT

Report Section	FCC Rule	Description	Limit	Result	Remark
3.4	§2.1046	Conducted Output Power	-	Report Only	-
	§22.913(a)(5)	Effective Radiated Power (Band 5) (Band 26)	ERP < 7 Watt	PASS	-
	§27.50(b)(10)	Effective Radiated Power (Band 13)	ERP < 3 Watt		-
	§24.232(c) §27.50(h)(2)	Equivalent Isotropic Radiated Power (Band 2) (Band 7) (Band 38)	EIRP < 2Watt		-
	§27.50(d)(4)	Equivalent Isotropic Radiated Power (Band 4) (Band 66)	EIRP < 1Watt		-
3.5	§24.232(d)	Peak-to-Average Ratio	<13 dB		PASS
3.6	§2.1049	Occupied Bandwidth	-	Report Only	-
3.7	§2.1051 §22.917(a) §24.238(a) §27.53(c)(2)(4) §27.53(h)	Conducted Band Edge Measurement (Band 2) (Band 4) (Band 5) (Band 13)(Band 26) (Band 66)	< 43+10log ₁₀ (P[Watts])	PASS	-
	§27.53(m)(4)	Conducted Band Edge Measurement (Band 7) (Band 38)	§27.53(m)(4)		
3.8	§2.1051 §22.917(a) §24.238(a) §27.53(c)(2) §27.53(h)	Conducted Spurious Emission (Band 2) (Band 4) (Band 5) (Band 13)(Band 26) (Band 66)	< 43+10log ₁₀ (P[Watts])	PASS	-
	§2.1051 §27.53(m)(4)	Conducted Spurious Emission (Band 7) (Band 38)	< 55+10log ₁₀ (P[Watts])		
3.9	§2.1055 §22.355	Frequency Stability Temperature & Voltage	< 2.5 ppm for Part 22	PASS	-
	§2.1055 §24.235 §27.54		Within Authorized Band		



Report Section	FCC Rule	Description	Limit	Result	Remark
4.4	§2.1053 §22.917(a) §24.238(a) §27.53(c)(2) §27.53(f) §27.53(g) §27.53(h)	Radiated Spurious Emission (Band 2) (Band 4) (Band 5) (Band 13)(Band 26) (Band 66)	$< 43+10\log_{10}(P[\text{Watts}])$	PASS	Under limit 10.77 dB at 1559.500 MHz
	§2.1053 §27.53(m)(4)	Radiated Spurious Emission (Band 7) (Band 38)	$< 55+10\log_{10}(P[\text{Watts}])$		

Conformity Assessment Condition:

1. The test results (PASS/FAIL) with all measurement uncertainty excluded are presented against the regulation limits or in accordance with the requirements stipulated by the applicant/manufacturer who shall bear all the risks of non-compliance that may potentially occur if measurement uncertainty is taken into account.
2. The measurement uncertainty please refer to each test result in the section "Measurement Uncertainty"

Disclaimer:

The product specifications of the EUT presented in the test report that may affect the test assessments are declared by the manufacturer who shall take full responsibility for the authenticity.



1 General Description

1.1 Applicant

Motorola Mobility LLC
222 W, Merchandise Mart Plaza, Chicago IL 60654, USA

1.2 Manufacturer

Motorola Mobility LLC
222 W, Merchandise Mart Plaza, Chicago IL 60654, USA

1.3 Product Feature of Equipment Under Test

Product Feature	
Equipment	Mobile Cellular Phone
Brand Name	Motorola
Model Name	XT2523-2, XT2523-8
FCC ID	IHDT56AT3
IMEI Code	Conducted: 351368280029899/351368280029907 for Sample 1 Radiation: 351368280023991/351368280024007 for Sample 1 351368280034295/351368280034303 for Sample 2 351368280037959/351368280037967 for Sample 3
HW Version	DVT2
SW Version	VVTA35.44, UUTB34.23
EUT Stage	Identical Prototype

Remark:

1. The above EUT's information was declared by manufacturer. Please refer to the specifications or user's manual for more detailed description.
2. There are three types of EUT for each model name(XT2523-2, XT2523-8), the differences could be referred to the XT2523-2, XT2523-8_Operational Description of Product Equality Declaration which is exhibit separately. According to the difference, we choose sample 1 of XT2523-2 to full test and the sample 2/3 is verified for the difference. The test results of XT2523-8 are referred to the model name XT2523-2.



1.4 Product Specification of Equipment Under Test

Standards-related Product Specification	
Tx Frequency	LTE Band 2 : 1850 MHz ~ 1910 MHz LTE Band 4 : 1710 MHz ~ 1755 MHz LTE Band 5 : 824 MHz ~ 849 MHz LTE Band 7 : 2500 MHz ~ 2570 MHz LTE Band 13 : 777 MHz ~ 787 MHz LTE Band 26 : 824 MHz ~ 849 MHz LTE Band 38 : 2570 MHz ~ 2620 MHz LTE Band 66 : 1710 MHz ~ 1780 MHz
Rx Frequency	LTE Band 2 : 1930 MHz ~ 1990 MHz LTE Band 4 : 2110 MHz ~ 2155 MHz LTE Band 5 : 869 MHz ~ 894 MHz LTE Band 7 : 2620 MHz ~ 2690 MHz LTE Band 13 : 746 MHz ~ 756 MHz LTE Band 26 : 869 MHz ~ 894 MHz LTE Band 38 : 2570 MHz ~ 2620 MHz LTE Band 66 : 2110 MHz~ 2180 MHz
Bandwidth	LTE Band 2 : 1.4MHz / 3MHz / 5MHz / 10MHz / 15MHz / 20MHz LTE Band 4 : 1.4MHz / 3MHz / 5MHz / 10MHz / 15MHz / 20MHz LTE Band 5 : 1.4MHz / 3MHz / 5MHz / 10MHz LTE Band 7 : 5MHz/ 10MHz / 15MHz / 20MHz LTE Band 13 : 5MHz / 10MHz LTE Band 26 : 1.4MHz / 3MHz / 5MHz / 10MHz / 15MHz LTE Band 38 : 5MHz / 10MHz / 15MHz / 20MHz LTE Band 66 : 1.4MHz / 3MHz / 5MHz / 10MHz / 15MHz / 20MHz
Maximum Output Power to Antenna	Ant0: LTE Band 2 : 23.42 dBm LTE Band 4 : 23.38 dBm LTE Band 5 : 23.44 dBm LTE Band 7 : 23.50 dBm LTE Band 13 : 23.43 dBm LTE Band 26 : 23.50 dBm LTE Band 38 : 23.43 dBm LTE Band 66 : 23.43 dBm Ant3: LTE Band 2 : 23.18 dBm LTE Band 4 : 22.90 dBm LTE Band 5 : 23.13 dBm LTE Band 7 : 22.83 dBm LTE Band 26 : 23.15 dBm LTE Band 38 : 22.82 dBm LTE Band 66 : 22.95 dBm
Antenna Gain	Ant0: LTE Band 2 : -2.6 dBi LTE Band 4 : -3.0 dBi LTE Band 5 : -4.2 dBi LTE Band 7 : -2.5 dBi LTE Band 13 : -3.6 dBi LTE Band 26 : -4.1 dBi LTE Band 38 : -2.7 dBi LTE Band 66 : -3.0 dBi



	Ant3: LTE Band 2 : -2.8 dBi LTE Band 4 : -3.4 dBi LTE Band 5 : -4.1 dBi LTE Band 7 : -3.2 dBi LTE Band 26 : -4.1 dBi LTE Band 38 : -2.6 dBi LTE Band 66 : -3.4 dBi
Type of Modulation	QPSK / 16QAM / 64QAM

Note: The maximum ERP/EIRP is calculated from max output power and max antenna gain, only the maximum ERP/EIRP of Antenna 0 for LTE Band 2/4/5/7/13/26/38/66 are shown in the report.

1.5 Modification of EUT

No modifications are made to the EUT during all test items.

1.6 Specification of Accessory

Accessories Information				
AC Adapter 1(US)	Brand Name	Motorola(AOHAI)	Model Name	MC-101
AC Adapter 1(EU)	Brand Name	Motorola(AOHAI)	Model Name	MC-102
AC Adapter 1(UK)	Brand Name	Motorola(AOHAI)	Model Name	MC-103
AC Adapter 1(IN)	Brand Name	Motorola(AOHAI)	Model Name	MC-104
AC Adapter 1(AU)	Brand Name	Motorola(AOHAI)	Model Name	MC-105
AC Adapter 1(AR)	Brand Name	Motorola(AOHAI)	Model Name	MC-106
AC Adapter 2(US)	Brand Name	Motorola(CHENYANG)	Model Name	MC-101
AC Adapter 2(EU)	Brand Name	Motorola(CHENYANG)	Model Name	MC-102
AC Adapter 2(UK)	Brand Name	Motorola(CHENYANG)	Model Name	MC-103
AC Adapter 2(AU)	Brand Name	Motorola(CHENYANG)	Model Name	MC-105
AC Adapter 2(AR)	Brand Name	Motorola(CHENYANG)	Model Name	MC-106
AC Adapter 2(BR)	Brand Name	Motorola(CHENYANG)	Model Name	MC-107
AC Adapter 2(PRC)	Brand Name	Motorola(CHENYANG)	Model Name	MC-108
AC Adapter 3(CHILE)	Brand Name	Motorola(SALCOMP)	Model Name	MC-109
Battery 1	Brand Name	Motorola(ATL)	Model Name	RL52
Battery 2	Brand Name	Motorola(Jiade)	Model Name	RL52
Battery 3	Brand Name	Motorola(Sunwoda)	Model Name	RL52
USB Cable 1	Brand Name	Motorola(Yihuaxing)	Model Name	T365-020 T365-020-01 T365-020-02
USB Cable 2	Brand Name	Motorola(WASHIN)	Model Name	HX-TL-01 HX-TL-08 HX-TL-07
USB Cable 3	Brand Name	Motorola(Juwei)	Model Name	JWUB1614-T03H JWUB1705-T03H JWUB1856-T03H
USB Cable 4	Brand Name	Motorola(I-SHENG)	Model Name	SC18D38574



1.7 Maximum ERP/EIRP Power and Emission Designator

LTE Band 2		QPSK		16QAM/64QAM	
BW (MHz)	Frequency Range (MHz)	Maximum EIRP(W)	Emission Designator (99%OBW)	Maximum EIRP(W)	Emission Designator (99%OBW)
1.4	1850.7 ~ 1909.3	0.1104	1M09G7D	0.0973	1M10W7D
3	1851.5 ~ 1908.5	0.1094	2M71G7D	0.0940	2M70W7D
5	1852.5 ~ 1907.5	0.1096	4M50G7D	0.0935	4M49W7D
10	1855.0 ~ 1905.0	0.1107	9M11G7D	0.0942	9M05W7D
15	1857.5 ~ 1902.5	0.1109	13M5G7D	0.0935	13M4W7D
20	1860.0 ~ 1900.0	0.1208	18M0G7D	0.0944	17M9W7D
LTE Band 4		QPSK		16QAM/64QAM	
BW (MHz)	Frequency Range (MHz)	Maximum EIRP(W)	Emission Designator (99%OBW)	Maximum EIRP(W)	Emission Designator (99%OBW)
1.4	1710.7 ~ 1754.3	0.1023	1M09G7D	0.0855	1M08W7D
3	1711.5 ~ 1753.5	0.1021	2M70G7D	0.0855	2M72W7D
5	1712.5 ~ 1752.5	0.1016	4M51G7D	0.0857	4M50W7D
10	1715.0 ~ 1750.0	0.1007	9M09G7D	0.0857	9M07W7D
15	1717.5 ~ 1747.5	0.1021	13M4G7D	0.0855	13M5W7D
20	1720.0 ~ 1745.0	0.1091	17M9G7D	0.0859	17M9W7D
LTE Band 5		QPSK		16QAM/64QAM	
BW (MHz)	Frequency Range (MHz)	Maximum ERP(W)	Emission Designator (99%OBW)	Maximum ERP(W)	Emission Designator (99%OBW)
1.4	824.7 ~ 848.3	0.0489	1M09G7D	0.0414	1M09W7D
3	825.5 ~ 847.5	0.0495	2M71G7D	0.0419	2M72W7D
5	826.5 ~ 846.5	0.0499	4M47G7D	0.0423	4M47W7D
10	829.0 ~ 844.0	0.0512	9M09G7D	0.0425	9M03W7D
LTE Band 7		QPSK		16QAM/64QAM	
BW (MHz)	Frequency Range (MHz)	Maximum EIRP(W)	Emission Designator (99%OBW)	Maximum EIRP(W)	Emission Designator (99%OBW)
5	2502.5 ~ 2567.5	0.1122	4M50G7D	0.1016	4M48W7D
10	2505.0 ~ 2565.0	0.1117	9M03G7D	0.1016	9M03W7D
15	2507.5 ~ 2562.5	0.1119	13M4G7D	0.1014	13M4W7D
20	2510.0 ~ 2560.0	0.1259	18M0G7D	0.1026	17M9W7D



LTE Band 13		QPSK		16QAM/64QAM	
BW (MHz)	Frequency Range (MHz)	Maximum ERP(W)	Emission Designator (99%OBW)	Maximum ERP(W)	Emission Designator (99%OBW)
5	779.5 ~ 784.5	0.0566	4M49G7D	0.0471	4M49W7D
10	782.0	0.0586	9M01G7D	0.0480	8M99W7D
LTE Band 26		QPSK		16QAM/64QAM	
BW (MHz)	Frequency Range (MHz)	Maximum ERP(W)	Emission Designator (99%OBW)	Maximum ERP(W)	Emission Designator (99%OBW)
1.4	824.7 ~ 848.3	0.0488	1M09G7D	0.0413	1M09W7D
3	825.5 ~ 847.5	0.0492	2M71G7D	0.0415	2M72W7D
5	826.5 ~ 846.5	0.0491	4M47G7D	0.0416	4M47W7D
10	829.0 ~ 844.0	0.0482	9M09G7D	0.0417	9M03W7D
15	831.5 ~ 841.5	0.0531	13M5G7D	0.0419	13M4W7D
CH26790	824.0	0.0526	13M4G7D	0.0406	13M5W7D
LTE Band 38		QPSK		16QAM/64QAM	
BW (MHz)	Frequency Range (MHz)	Maximum EIRP(W)	Emission Designator (99%OBW)	Maximum EIRP(W)	Emission Designator (99%OBW)
5	2572.5 ~ 2617.5	0.1076	4M48G7D	0.0933	4M48W7D
10	2575.0 ~ 2615.0	0.1064	9M05G7D	0.0946	8M99W7D
15	2577.5 ~ 2612.5	0.1072	13M5G7D	0.0944	13M5W7D
20	2580.0 ~ 2610.0	0.1183	17M9G7D	0.0964	18M0W7D
LTE Band 66		QPSK		16QAM/64QAM	
BW (MHz)	Frequency Range (MHz)	Maximum EIRP(W)	Emission Designator (99%OBW)	Maximum EIRP(W)	Emission Designator (99%OBW)
1.4	1710.7 ~ 1779.3	0.1023	1M09G7D	0.0948	1M08W7D
3	1711.5 ~ 1778.5	0.1005	2M70G7D	0.0938	2M72W7D
5	1712.5 ~ 1777.5	0.1002	4M51G7D	0.0944	4M50W7D
10	1715.0 ~ 1775.0	0.1016	9M09G7D	0.0944	9M07W7D
15	1717.5 ~ 1772.5	0.1009	13M4G7D	0.0940	13M5W7D
20	1720.0 ~ 1770.0	0.1104	17M9G7D	0.0968	17M9W7D

Note:

1. LTE Band 26 overlaps the entire frequency range of LTE Band 5. Therefore, the test results provided in this report covers Band 5 and the portion of Band 26 subject to Part 22.
2. LTE Band 66 overlaps the entire frequency range of LTE Band 4. Therefore, the test results provided in this report covers Band 66 as well as Band 4.



1.8 Testing Location

Sporton International Inc. (ShenZhen) is accredited to ISO/IEC 17025:2017 by American Association for Laboratory Accreditation with Certificate Number 5145.01.

Test Firm	Sporton International Inc. (ShenZhen)		
Test Site Location	1/F, 2/F, Bldg 5, Shiling Industrial Zone, Xinwei Village, Xili, Nanshan, Shenzhen, 518055 People's Republic of China TEL: +86-755-86379589 FAX: +86-755-86379595		
Test Site No.	Sporton Site No.	FCC Designation No.	FCC Test Firm Registration No.
	TH01-SZ	CN1256	421272

Test Firm	Sporton International Inc. (ShenZhen)		
Test Site Location	101, 1st Floor, Block B, Building 1, No. 2, Tengfeng 4th Road, Fenghuang Community, Fuyong Street, Baoan District, Shenzhen City, Guangdong Province 518103 People's Republic of China TEL: +86-755-86066985		
Test Site No.	Sporton Site No.	FCC Designation No.	FCC Test Firm Registration No.
	03CH01-SZ	CN1256	421272

1.9 Test Software

Item	Site	Manufacturer	Name	Version
1.	03CH01-SZ	AUDIX	E3	6.2009-8-24



1.10 Applicable Standards

According to the specifications of the manufacturer, the EUT must comply with the requirements of the following standards:

- ♦ 47 CFR Part 22(H), 24(E), 27(F), 27(L), 27(M)
- ♦ ANSI C63.26-2015
- ♦ FCC KDB 971168 D01 Power Meas License Digital Systems v03r01
- ♦ FCC KDB 412172 D01 Determining ERP and EIRP v01r01

Remark:

1. All test items were verified and recorded according to the standards and without any deviation during the test.
2. This EUT has also been tested and complied with the requirements of FCC Part 15, Subpart B, recorded in a separate test report.



2 Test Configuration of Equipment Under Test

2.1 Test Mode

Antenna port conducted and radiated test items listed below are performed according to KDB 971168 D01 Power Meas License Digital Systems v03r01 with maximum output power.

Radiated measurements are performed by rotating the EUT in three different orthogonal test planes to find the maximum emission.

Test Items	Band	Bandwidth (MHz)						Modulation			RB #			Test Channel		
		1.4	3	5	10	15	20	QPSK	16QAM	64QAM	1	Half	Full	L	M	H
Max. Output Power	2	v	v	v	v	v	v	v	v	v	v	v	v	v	v	v
	4	v	v	v	v	v	v	v	v	v	v	v	v	v	v	v
	5	v	v	v	v	-	-	v	v	v	v	v	v	v	v	v
	7	-	-	v	v	v	v	v	v	v	v	v	v	v	v	v
	13	-	-	v	v	-	-	v	v	v	v	v	v	v	v	v
	26	v	v	v	v	v	-	v	v	v	v	v	v	v	v	v
	38	-	-	v	v	v	v	v	v	v	v	v	v	v	v	v
	66	v	v	v	v	v	v	v	v	v	v	v	v	v	v	v
Peak-to-Average Ratio	2						v	v	v	v	v		v		v	
	7	-	-				v	v	v	v	v		v		v	
	13	-	-		v	-	-	v	v	v	v		v		v	
	26				v		-	v	v	v	v		v		v	
	38	-	-				v	v	v	v	v		v		v	
	66						v	v	v	v	v		v		v	



Test Items	Band	Bandwidth (MHz)						Modulation			RB #			Test Channel		
		1.4	3	5	10	15	20	QPSK	16QAM	64QAM	1	Half	Full	L	M	H
26dB and 99% Bandwidth	2	v	v	v	v	v	v	v	v	v			v		v	
	7	-	-	v	v	v	v	v	v	v			v		v	
	13	-	-	v	v	-	-	v	v	v			v		v	
	26	v	v	v	v	v	-	v	v	v			v		v	
	38	-	-	v	v	v	v	v	v	v			v		v	
	66	v	v	v	v	v	v	v	v	v			v		v	
Conducted Band Edge	2	v	v	v	v	v	v	v	v	v	v		v	v		v
	7	-	-	v	v	v	v	v	v	v	v		v	v		v
	13	-	-	v	v	-	-	v	v	v	v		v	v		v
	26	v	v	v	v	v	-	v	v	v	v		v	v		v
	38	-	-	v	v	v	v	v	v	v	v		v	v		v
	66	v	v	v	v	v	v	v	v	v	v		v	v		v
Conducted Spurious Emission	2	v	v	v	v	v	v	v	v	v	v			v	v	v
	7	-	-	v	v	v	v	v	v	v	v			v	v	v
	13	-	-	v	v	-	-	v	v	v	v			v	v	v
	26	v	v	v	v	v	-	v	v	v	v			v	v	v
	38	-	-	v	v	v	v	v	v	v	v			v	v	v
	66	v	v	v	v	v	v	v	v	v	v			v	v	v
Frequency Stability	2				v			v					v		v	
	7	-	-		v			v					v		v	
	13	-	-		v	-	-	v					v		v	
	26				v		-	v					v		v	
	38	-	-		v			v					v		v	
	66				v			v					v		v	



Test Items	Band	Bandwidth (MHz)						Modulation			RB #			Test Channel		
		1.4	3	5	10	15	20	QPSK	16QAM	64QAM	1	Half	Full	L	M	H
E.R.P / E.I.R.P	2	v	v	v	v	v	v	v	v	v	v	v	v	v	v	v
	7	-	-	v	v	v	v	v	v	v	v	v	v	v	v	v
	13	-	-	v	v	-	-	v	v	v	v	v	v	v	v	v
	26	v	v	v	v	v	-	v	v	v	v	v	v	v	v	v
	38	-	-	v	v	v	v	v	v	v	v	v	v	v	v	v
	66	v	v	v	v	v	v	v	v	v	v	v	v	v	v	v
Radiated Spurious Emission	2	Worst Case												v		
	7	Worst Case												v		
	13	Worst Case												v		
	26	Worst Case												v		
	38	Worst Case												v		
	66	Worst Case												v		
Note	<ol style="list-style-type: none"> The mark "v " means that this configuration is chosen for testing The mark "- " means that this bandwidth is not supported. The device is investigated from 30MHz to 10 times of fundamental signal for radiated spurious emission test under different RB size/offset and modulations in exploratory test. Subsequently, only the worst case emissions are reported. LTE Band 26 overlaps the entire frequency range of LTE Band 5. Therefore, the test results provided in this report covers Band 5 and the portion of Band 26 subject to Part 22. LTE Band 66 overlaps the entire frequency range of LTE Band 4. Therefore, the test results provided in this report covers Band 66 as well as Band 4. 															

2.2 Connection Diagram of Test System

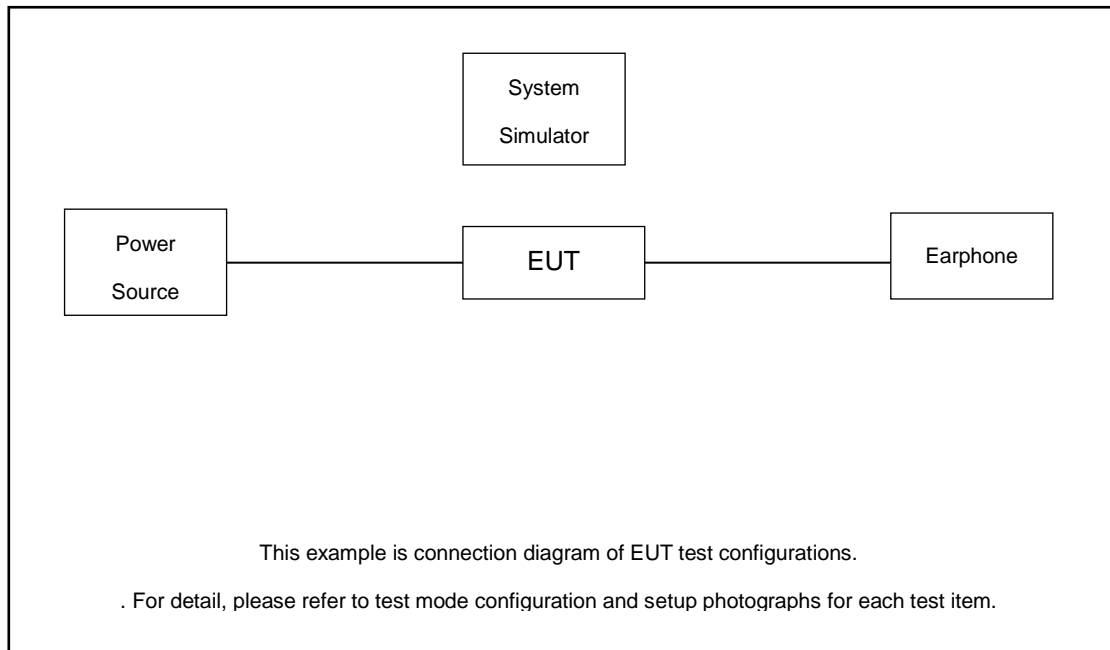

2.3 Support Unit used in test configuration and system

Item	Equipment	Trade Name	Model No.	FCC ID	Data Cable	Power Cord
1.	Power Supply	GWINSTEK	PSS-2002	N/A	N/A	Unshielded, 1.8 m
2.	LTE Base Station	Anritsu	MT8820C	N/A	N/A	Unshielded, 1.8 m

2.4 Measurement Results Explanation Example

For all conducted test items:

The offset level is set in the spectrum analyzer to compensate the RF cable loss and attenuator factor between EUT conducted output port and spectrum analyzer. With the offset compensation, the spectrum analyzer reading level is exactly the EUT RF output level.

The spectrum analyzer offset is derived from RF cable loss and attenuator factor.

$$\text{Offset} = \text{RF cable loss} + \text{attenuator factor}.$$

Following shows an offset computation example with cable loss 4.5 dB and 10dB attenuator.

Example :

$$\begin{aligned} \text{Offset(dB)} &= \text{RF cable loss(dB)} + \text{attenuator factor(dB)}. \\ &= 4.5 + 10 = 14.5 \text{ (dB)} \end{aligned}$$



2.5 Frequency List of Low/Middle/High Channels

LTE Band 2 Channel and Frequency List				
BW [MHz]	Channel/Frequency(MHz)	Lowest	Middle	Highest
20	Channel	18700	18900	19100
	Frequency	1860	1880	1900
15	Channel	18675	18900	19125
	Frequency	1857.5	1880	1902.5
10	Channel	18650	18900	19150
	Frequency	1855	1880	1905
5	Channel	18625	18900	19175
	Frequency	1852.5	1880	1907.5
3	Channel	18615	18900	19185
	Frequency	1851.5	1880	1908.5
1.4	Channel	18607	18900	19193
	Frequency	1850.7	1880	1909.3

LTE Band 4 Channel and Frequency List				
BW [MHz]	Channel/Frequency(MHz)	Lowest	Middle	Highest
20	Channel	20050	20175	20300
	Frequency	1720	1732.5	1745
15	Channel	20025	20175	20325
	Frequency	1717.5	1732.5	1747.5
10	Channel	20000	20175	20350
	Frequency	1715	1732.5	1750
5	Channel	19975	20175	20375
	Frequency	1712.5	1732.5	1752.5
3	Channel	19965	20175	20385
	Frequency	1711.5	1732.5	1753.5
1.4	Channel	19957	20175	20393
	Frequency	1710.7	1732.5	1754.3



LTE Band 5 Channel and Frequency List				
BW [MHz]	Channel/Frequency(MHz)	Lowest	Middle	Highest
10	Channel	20450	20525	20600
	Frequency	829	836.5	844
5	Channel	20425	20525	20625
	Frequency	826.5	836.5	846.5
3	Channel	20415	20525	20635
	Frequency	825.5	836.5	847.5
1.4	Channel	20407	20525	20643
	Frequency	824.7	836.5	848.3

LTE Band 7 Channel and Frequency List				
BW [MHz]	Channel/Frequency(MHz)	Lowest	Middle	Highest
20	Channel	20850	21100	21350
	Frequency	2510	2535	2560
15	Channel	20825	21100	21375
	Frequency	2507.5	2535	2562.5
10	Channel	20800	21100	21400
	Frequency	2505	2535	2565
5	Channel	20775	21100	21425
	Frequency	2502.5	2535	2567.5



LTE Band 13 Channel and Frequency List				
BW [MHz]	Channel/Frequency(MHz)	Lowest	Middle	Highest
10	Channel	-	23230	-
	Frequency	-	782	-
5	Channel	23205	23230	23255
	Frequency	779.5	782	784.5

LTE Band 26 Channel and Frequency List				
BW [MHz]	Channel/Frequency(MHz)	Lowest	Middle	Highest
15	Channel	26865	26915	26965
	Frequency	831.5	836.5	841.5
10	Channel	26840	26915	26990
	Frequency	829	836.5	844
5	Channel	26815	26915	27015
	Frequency	826.5	836.5	846.5
3	Channel	26805	26915	27025
	Frequency	825.5	836.5	847.5
1.4	Channel	26797	26915	27033
	Frequency	824.7	836.5	848.3

LTE Band 38 Channel and Frequency List				
BW [MHz]	Channel/Frequency(MHz)	Lowest	Middle	Highest
20	Channel	37850	38000	38150
	Frequency	2580	2595	2610
15	Channel	37825	38000	38175
	Frequency	2577.5	2595	2612.5
10	Channel	37800	38000	38200
	Frequency	2575	2595	2615
5	Channel	37775	38000	38225
	Frequency	2572.5	2595	2617.5



LTE Band 66 Channel and Frequency List				
BW [MHz]	Channel/Frequency(MHz)	Lowest	Middle	Highest
20	Channel	132072	132322	132572
	Frequency	1720	1745	1770
15	Channel	132047	132322	132597
	Frequency	1717.5	1745	1772.5
10	Channel	132022	132322	132622
	Frequency	1715	1745	1775
5	Channel	131997	132322	132647
	Frequency	1712.5	1745	1777.5
3	Channel	131987	132322	132657
	Frequency	1711.5	1745	1778.5
1.4	Channel	131979	132322	132665
	Frequency	1710.7	1745	1779.3

3 Conducted Test Items

3.1 Measuring Instruments

See list of measuring instruments of this test report.

3.2 Test Setup

3.2.1 Conducted Output Power

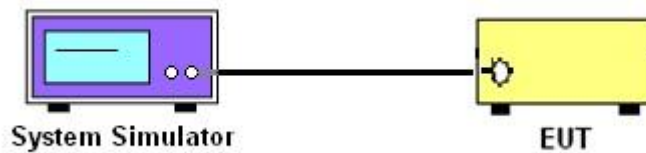

3.2.2 Peak-to-Average Ratio, Occupied Bandwidth ,Conducted Band-Edge and Conducted Spurious Emission

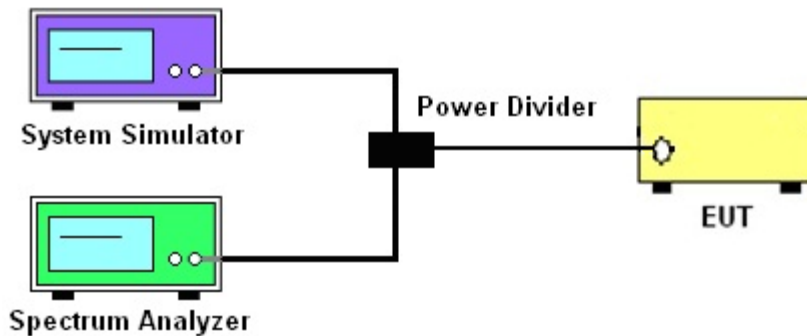

3.2.3 Frequency Stability

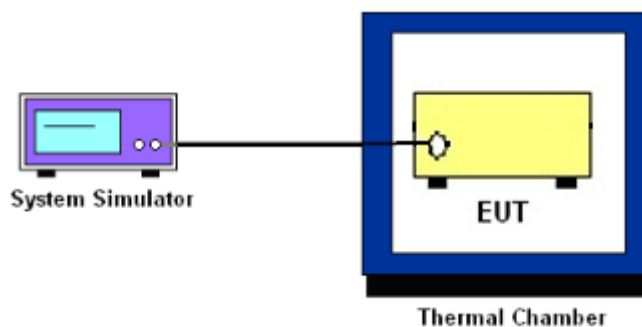

3.3 Test Result of Conducted Test

Please refer to Appendix A.



3.4 Conducted Output Power and ERP/EIRP

3.4.1 Description of the Conducted Output Power Measurement and ERP/EIRP Measurement

A system simulator was used to establish communication with the EUT. Its parameters were set to force the EUT transmitting at maximum output power. The measured power in the radio frequency on the transmitter output terminals shall be reported.

The ERP of mobile transmitters must not exceed 7 Watts for LTE Band 5 and Band 26.

The ERP of mobile transmitters must not exceed 3 Watts for LTE Band 13

The EIRP of mobile transmitters must not exceed 2 Watts for LTE Band 2 and Band 7 and Band 38.

The EIRP of mobile transmitters must not exceed 1 Watts for LTE Band 4 and Band 66.

According to KDB 412172 D01 Power Approach,

$EIRP = P_T + G_T - L_C$, $ERP = EIRP - 2.15$, where

P_T = transmitter output power in dBm

G_T = gain of the transmitting antenna in dBi

L_C = signal attenuation in the connecting cable between the transmitter and antenna in dB

3.4.2 Test Procedures

1. The testing follows ANSI C63.26 Section 5.2
2. The transmitter output port was connected to the system simulator.
3. Set EUT at maximum power through the system simulator.
4. Select lowest, middle, and highest channels for each band and different modulation.
5. Measure and record the power level from the system simulator.



3.5 Peak-to-Average Ratio

3.5.1 Description of the PAR Measurement

Power Complementary Cumulative Distribution Function (CCDF) curves provide a means for characterizing the power peaks of a digitally modulated signal on a statistical basis. A CCDF curve depicts the probability of the peak signal amplitude exceeding the average power level. Most contemporary measurement instrumentation include the capability to produce CCDF curves for an input signal provided that the instrument's resolution bandwidth can be set wide enough to accommodate the entire input signal bandwidth. In measuring transmissions in this band using an average power technique, the peak-to-average ratio (PAR) of the transmission may not exceed 13 dB.

3.5.2 Test Procedures

1. The testing follows ANSI C63.26 Section 5.2.3.4 (CCDF).
2. The EUT was connected to spectrum and system simulator via a power divider.
3. Set the CCDF (Complementary Cumulative Distribution Function) option in spectrum analyzer.
4. The highest RF powers were measured and recorded the maximum PAPR level associated with a probability of 0.1 %.
5. Record the deviation as Peak to Average Ratio.



3.6 Occupied Bandwidth

3.6.1 Description of Occupied Bandwidth Measurement

The occupied bandwidth is the width of a frequency band such that, below the lower and above the upper frequency limits, the mean powers emitted are each equal to a specified percentage 0.5% of the total mean transmitted power.

The 26 dB emission bandwidth is defined as the frequency range between two points, one above and one below the carrier frequency, at which the spectral density of the emission is attenuated 26 dB below the maximum in-band spectral density of the modulated signal. Spectral density (power per unit bandwidth) is to be measured with a detector of resolution bandwidth equal to approximately 1.0% of the emission bandwidth.

3.6.2 Test Procedures

1. The testing follows ANSI C63.26 Section 5.4
2. The EUT was connected to spectrum analyzer and system simulator via a power divider.
3. The spectrum analyzer center frequency is set to the nominal EUT channel center frequency. The span range for the spectrum analyzer shall be between two and five times the anticipated OBW.
4. The nominal resolution bandwidth (RBW) shall be in the range of 1 to 5 % of the anticipated OBW, and the VBW shall be at least 3 times the RBW.
5. Set the detection mode to peak, and the trace mode to max hold.
6. Determine the reference value: Set the EUT to transmit a modulated signal. Allow the trace to stabilize. Set the spectrum analyzer marker to the highest level of the displayed trace.
(this is the reference value)
7. Determine the “-26 dB down amplitude” as equal to (Reference Value – X).
8. Place two markers, one at the lowest and the other at the highest frequency of the envelope of the spectral display such that each marker is at or slightly below the “-X dB down amplitude” determined in step 6. If a marker is below this “-X dB down amplitude” value it shall be placed as close as possible to this value. The OBW is the positive frequency difference between the two markers.
9. Use the 99 % power bandwidth function of the spectrum analyzer and report the measured bandwidth.



3.7 Conducted Band Edge

3.7.1 Description of Conducted Band Edge Measurement

22.917(a)

For operations in the 824 – 849 MHz band, the FCC limit is $43 + 10\log_{10}(P[\text{Watts}])$ dB below the transmitter power $P(\text{Watts})$ in a 100kHz bandwidth. However, in the 1MHz bands immediately outside and adjacent to the licensee's frequency block, a resolution bandwidth of at least one percent of the emission bandwidth of the fundamental emission of the transmitter may be employed.

24.238 (a)

For operations in the 1850-1910 and 1930-1990 MHz band, the FCC limit is $43 + 10\log_{10}(P[\text{Watts}])$ dB below the transmitter power $P(\text{Watts})$ in a 1MHz bandwidth. However, in the 1 MHz bands immediately outside and adjacent to the frequency block a resolution bandwidth of at least one percent of the emission bandwidth of the fundamental emission of the transmitter may be employed.

27.53 (c)

For operations in the 776-788 MHz band, the FCC limit is $43 + 10\log_{10}(P[\text{Watts}])$ dB below the transmitter power $P(\text{Watts})$ in a 100 kHz bandwidth. However, in the 100 kHz bands immediately outside and adjacent to the frequency block, a resolution bandwidth of at least 30 kHz may be employed. In addition, the power of any unwanted emissions in any 6.25 kHz bandwidth for all frequencies between 763-775 MHz and 793-806 MHz shall be attenuated below the transmitter power, P (dBW), by at least $65 + 10 \log_{10} p(\text{watts})$, dB, for mobile and portable equipment.

27.53 (h)

For operations in the 1710 – 1755 MHz band, the FCC limit is $43 + 10\log_{10}(P[\text{Watts}])$ dB below the transmitter power $P(\text{Watts})$ in a 1 MHz bandwidth. However, in the 1MHz bands immediately outside and adjacent to the licensee's frequency block, a resolution bandwidth of at least one percent of the emission bandwidth of the fundamental emission of the transmitter may be employed.



27.53(m)(4)

For mobile digital stations, the attenuation factor shall be not less than $40 + 10 \log (P)$ dB on all frequencies between the channel edge and 5 megahertz from the channel edge, $43 + 10 \log (P)$ dB on all frequencies between 5 megahertz and X megahertz from the channel edge, and $55 + 10 \log (P)$ dB on all frequencies more than X megahertz from the channel edge, where X is the greater of 6 megahertz or the actual emission bandwidth as defined in paragraph (m)(6) of this section. In addition, the attenuation factor shall not be less that $43 + 10 \log (P)$ dB on all frequencies between 2490.5 MHz and 2496 MHz and $55 + 10 \log (P)$ dB at or below 2490.5 MHz. Mobile Satellite Service licensees operating on frequencies below 2495 MHz may also submit a documented interference complaint against BRS licensees operating on channel BRS Channel 1 on the same terms and conditions as adjacent channel BRS or EBS licensees.

3.7.2 Test Procedures

1. The testing follows ANSI C63.26 section 5.7
1. The EUT was connected to spectrum analyzer and system simulator via a power divider.
2. The band edges of low and high channels for the highest RF powers were measured.
3. Set RBW $\geq 1\%$ EBW in the 1MHz band immediately outside and adjacent to the band edge.
4. Beyond the 1 MHz band from the band edge, RBW=1MHz was used or a narrower RBW was used and the measured power was integrated over the full required measurement bandwidth of 1 MHz.
5. Set spectrum analyzer with RMS detector.
6. The RF fundamental frequency should be excluded against the limit line in the operating frequency band.
7. Checked that all the results comply with the emission limit line.

Example:

The limit line is derived from $43 + 10\log(P)$ dB below the transmitter power P(Watts)
 $= P(W) - [43 + 10\log(P)]$ (dB)
 $= [30 + 10\log(P)]$ (dBm) - $[43 + 10\log(P)]$ (dB) = -13dBm.

8. For LTE Band 7, 38, the other 40 dB, and 55 dB have additionally applied same calculation above.
9. When using the integration method, the starting frequency of the integration shall be centered at one-half of the RBW away from the band edge.



3.8 Conducted Spurious Emission

3.8.1 Description of Conducted Spurious Emission Measurement

The power of any emission outside of the authorized operating frequency ranges must be lower than the transmitter power (P) by a factor of at least $43 + 10 \log (P)$ dB.

For Band 7,38:

The power of any emission outside of the authorized operating frequency ranges must be lower than the transmitter power (P) by a factor of at least $55 + 10 \log (P)$ dB.

It is measured by means of a calibrated spectrum analyzer and scanned from 30 MHz up to a frequency including its 10th harmonic.

3.8.2 Test Procedures

1. The testing follows ANSI C63.26 section 5.7
2. The EUT was connected to spectrum analyzer and system simulator via a power divider.
3. The RF output of EUT was connected to the spectrum analyzer by RF cable and attenuator. The path loss was compensated to the results for each measurement.
4. The middle channel for the highest RF power within the transmitting frequency was measured.
5. The conducted spurious emission for the whole frequency range was taken.
6. Make the measurement with the spectrum analyzer's RBW = 1MHz, VBW = 3MHz.
7. Set spectrum analyzer with RMS detector.
8. Taking the record of maximum spurious emission.
9. The RF fundamental frequency should be excluded against the limit line in the operating frequency band.
10. The limit line is derived from $43 + 10\log(P)$ dB below the transmitter power P(Watts)
 $= P(W) - [43 + 10\log(P)]$ (dB)
 $= [30 + 10\log(P)]$ (dBm) - $[43 + 10\log(P)]$ (dB)
 $= -13$ dBm.
11. For Band 7, 38
The limit line is derived from $55 + 10\log(P)$ dB below the transmitter power P(Watts)
 $= P(W) - [55 + 10\log(P)]$ (dB)
 $= [30 + 10\log(P)]$ (dBm) - $[55 + 10\log(P)]$ (dB)
 $= -25$ dBm.



3.9 Frequency Stability

3.9.1 Description of Frequency Stability Measurement

The frequency stability shall be measured by variation of ambient temperature and variation of primary supply voltage to ensure that the fundamental emission stays within the authorized frequency block. The frequency stability of the transmitter shall be maintained within $\pm 0.00025\%$ ($\pm 2.5\text{ppm}$) of the center frequency.

3.9.2 Test Procedures for Temperature Variation

1. The testing follows ANSI C63.26 section 5.6.4
2. The EUT was set up in the thermal chamber and connected with the system simulator.
3. With power OFF, the temperature was decreased to -30°C and the EUT was stabilized before testing. Power was applied and the maximum change in frequency was recorded within one minute.
4. With power OFF, the temperature was raised in 10°C step up to 50°C . The EUT was stabilized at each step for at least half an hour. Power was applied and the maximum frequency change was recorded within one minute.

3.9.3 Test Procedures for Voltage Variation

1. The testing follows ANSI C63.26 section 5.6.5
2. The EUT was placed in a temperature chamber at $20\pm 5^{\circ}\text{C}$ and connected with the system simulator.
3. The power supply voltage to the EUT was varied from 85% to 115% of the nominal value for other than hand carried battery equipment.
4. For hand carried, battery powered equipment, reduce the primary ac or dc supply voltage to the battery operating end point, which shall be specified by the manufacturer.
5. The variation in frequency was measured for the worst case.

4 Radiated Test Items

4.1 Measuring Instruments

See list of measuring instruments of this test report.

4.2 Test Setup

4.2.1 For radiated test below 30MHz

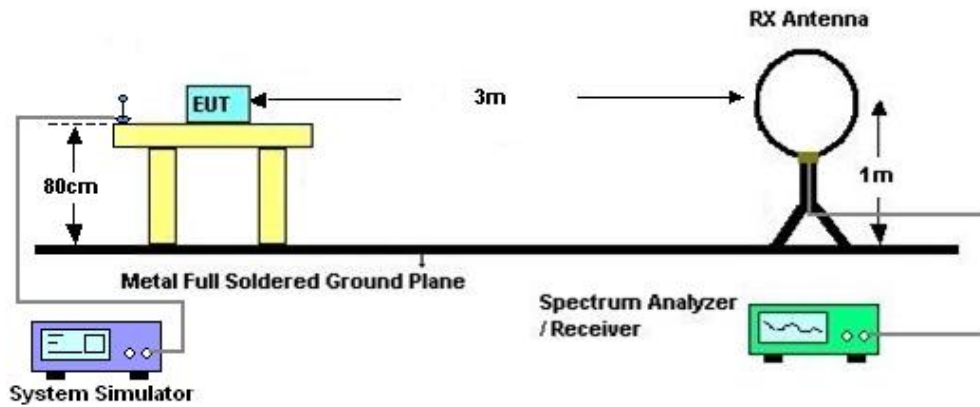

4.2.2 For radiated test from 30MHz to 1GHz

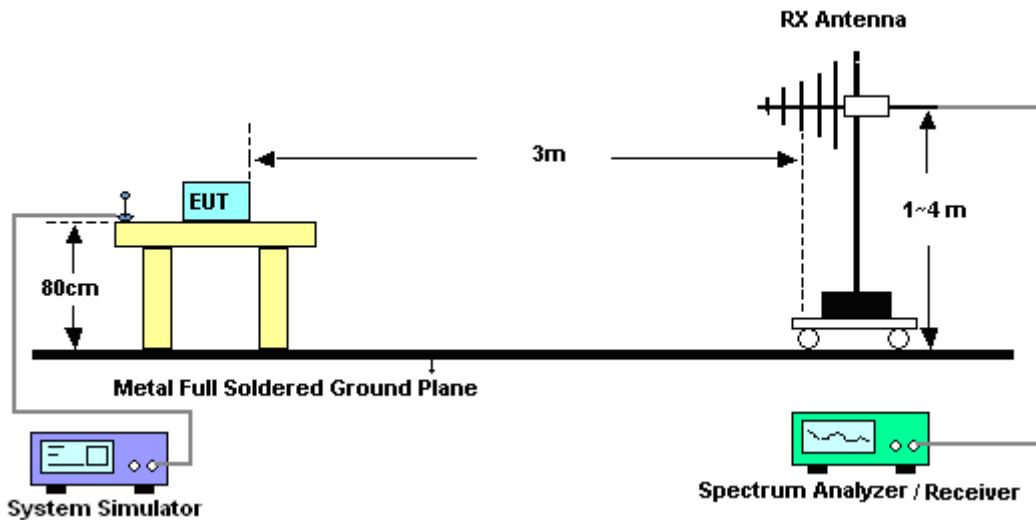

4.2.3 For radiated test above 1GHz

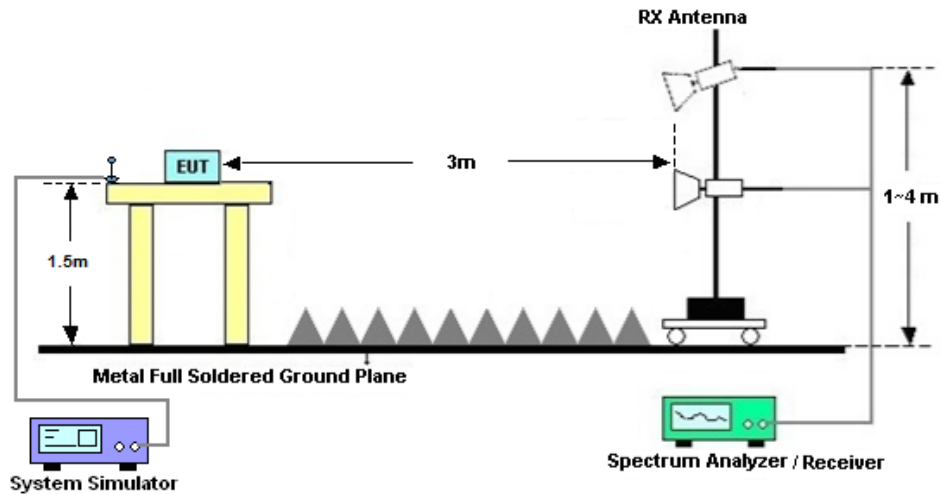

4.3 Test Result of Radiated Test

The low frequency, which started from 9 kHz to 30MHz, was pre-scanned and the result which was 20dB lower than the limit line was not reported.

Please refer to Appendix B.



4.4 Radiated Spurious Emission

4.4.1 Description of Radiated Spurious Emission

The radiated spurious emission was measured by substitution method according to ANSI C63.26. The power of any emission outside of the authorized operating frequency ranges must be attenuated below the transmitter power (P) by a factor of at least $43 + 10 \log (P)$ dB.

For Band 7, 38

The power of any emission outside of the authorized operating frequency ranges must be attenuated below the transmitter power (P) by a factor of at least $55 + 10 \log (P)$ dB.

For LTE Band 13

For operations in the 746-758 MHz, 775-788 MHz, and 805-806 MHz bands, emissions in the band 1559-1610 MHz shall be limited to -70 dBW/MHz equivalent isotropically radiated power (EIRP) for wideband signals, and -80 dBW EIRP for discrete emissions of less than 700 Hz bandwidth.

The spectrum is scanned from 30 MHz up to a frequency including its 10th harmonic.

4.4.2 Test Procedures

1. The testing follows ANSI C63.26 Section 5.5
2. The EUT was placed on a turntable with 0.8 meter height for frequency below 1GHz and 1.5 meter height for frequency above 1GHz respectively above ground.
3. The EUT was set 3 meters from the receiving antenna mounted on the antenna tower.
4. The table was rotated 360 degrees to determine the position of the highest spurious emission.
5. The height of the receiving antenna is varied between 1m to 4m to search the maximum spurious emission for both horizontal and vertical polarizations.
6. During the measurement, the system simulator parameters were set to force the EUT transmitting at maximum output power.
7. Make the measurement with the spectrum analyzer's RBW = 1MHz, VBW = 3MHz, taking the record of maximum spurious emission.
8. A horn antenna was substituted in place of the EUT and was driven by a signal generator.
9. Tune the output power of signal generator to the same emission level with EUT maximum spurious emission.
10. $EIRP (dBm) = S.G. Power - Tx Cable Loss + Tx Antenna Gain$
11. $ERP (dBm) = EIRP - 2.15$
12. The RF fundamental frequency should be excluded against the limit line in the operating frequency band.
The limit line is derived from $43 + 10\log(P)$ dB below the transmitter power P(Watts)
 $= P(W) - [43 + 10\log(P)] (dB)$
 $= [30 + 10\log(P)] (dBm) - [43 + 10\log(P)] (dB)$
 $= -13dBm.$
13. For Band 7, 38:
The limit line is derived from $55 + 10\log(P)$ dB below the transmitter power P(Watts)



5 List of Measuring Equipment

Instrument	Manufacturer	Model No.	Serial No.	Characteristics	Calibration Date	Test Date	Due Date	Remark
Spectrum Analyzer	R&S	FSV40	101078	10Hz~40GHz	Apr. 09, 2024	Sep. 10, 2024~ Sep. 29, 2024	Apr. 08, 2025	Conducted (TH01-SZ)
DC Power Supply	TTI	PL330P	290070	Max 32V , 3A	Oct. 16, 2023	Sep. 10, 2024~ Sep. 29, 2024	Oct. 15, 2024	Conducted (TH01-SZ)
Power Divider	TOJOIN	PS-2SM-04 265	60.06.020.007 7	0.4GHz~26.5GHz	Dec. 25, 2023	Sep. 10, 2024~ Sep. 29, 2024	Dec. 24, 2024	Conducted (TH01-SZ)
Thermal Chamber	Ten Billion Hongzhangroup	LP-150U	H2014081803	-40~+150°C	Jul. 03, 2024	Sep. 10, 2024~ Sep. 29, 2024	Jul. 02, 2025	Conducted (TH01-SZ)
EMI Test Receiver&SA	Agilent	N9038A	MY52260185	20Hz~26.5GHz	Dec. 27, 2023	Sep. 26, 2024~ Sep. 28, 2024	Dec. 26, 2024	Radiation (03CH01-SZ)
Loop Antenna	R&S	HFH2-Z2E	101141	9kHz~30MHz	Dec. 29, 2023	Sep. 26, 2024~ Sep. 28, 2024	Dec. 28, 2024	Radiation (03CH01-SZ)
Bilog Antenna	TeseQ	CBL6112D	35407	30MHz-2GHz	Oct. 24, 2023	Sep. 26, 2024~ Sep. 28, 2024	Oct. 23, 2025	Radiation (03CH01-SZ)
Double Ridge Horn Antenna	ETS-Lindgren	3117	00119436	1GHz~18GHz	Jul. 04, 2024	Sep. 26, 2024~ Sep. 28, 2024	Jul. 03, 2025	Radiation (03CH01-SZ)
SHF-EHF Horn	com-power	AH-840	101071	18Ghz-40GHz	Apr. 09,2024	Sep. 26, 2024~ Sep. 28, 2024	Apr. 08,2025	Radiation (03CH01-SZ)
LF Amplifier	Burgeon	BPA-530	102209	0.01~3000Mhz	Apr. 09, 2024	Sep. 26, 2024~ Sep. 28, 2024	Apr. 08, 2025	Radiation (03CH01-SZ)
HF Amplifier	MITEQ	AMF-7D-00 101800-30-1	1943528	1GHz~18GHz	Oct. 18,2023	Sep. 26, 2024~ Sep. 28, 2024	Oct. 17,2024	Radiation (03CH01-SZ)
HF Amplifier	KEYSIGHT	83017A	MY53270105	0.5GHz~26.5Ghz	Oct. 18,2023	Sep. 26, 2024~ Sep. 28, 2024	Oct. 17,2024	Radiation (03CH01-SZ)
HF Amplifier	MITEQ	TTA1840-35 -HG	1871923	18GHz~40GHz	Jul. 03, 2024	Sep. 26, 2024~ Sep. 28, 2024	Jul. 02, 2025	Radiation (03CH01-SZ)
AC Power Source	Chroma	61601	61601000198 5	N/A	Oct. 18,2023	Sep. 26, 2024~ Sep. 28, 2024	Oct. 17,2024	Radiation (03CH01-SZ)
Turn Table	EM	EM1000	N/A	0~360 degree	NCR	Sep. 26, 2024~ Sep. 28, 2024	NCR	Radiation (03CH01-SZ)
Antenna Mast	EM	EM1000	N/A	1 m~4 m	NCR	Sep. 26, 2024~ Sep. 28, 2024	NCR	Radiation (03CH01-SZ)

NCR: No Calibration Required



6 Measurement Uncertainty

The measurement uncertainties shown below were calculated in accordance with the requirements of ANSI 63.26-2015. All the measurement uncertainty value were shown with a coverage K=2 to indicate 95% level of confidence. The measurement data show herein meets or exceeds the CISPR measurement uncertainty values specified in CISPR 16-4-2 and can be compared directly to specified limit to determine compliance.

Uncertainty of Conducted Measurement

Test Item	Uncertainty
Conducted Spurious Emission & Bandedge	±1.34 dB
Occupied Channel Bandwidth	±0.012 MHz
Conducted Power	±1.34 dB
Peak to Average Ratio	±1.34 dB
Frequency Stability	±1.3 Hz

Uncertainty of Radiated Emission Measurement (30 MHz ~ 1000 MHz)

Measuring Uncertainty for a Level of Confidence of 95% (U = 2Uc(y))	2.48 dB
---	---------

Uncertainty of Radiated Emission Measurement (1 GHz ~ 18 GHz)

Measuring Uncertainty for a Level of Confidence of 95% (U = 2Uc(y))	3.53 dB
---	---------

Uncertainty of Radiated Emission Measurement (18GHz ~ 40 GHz)

Measuring Uncertainty for a Level of Confidence of 95% (U = 2Uc(y))	4.02 dB
---	---------

----- THE END -----



Appendix A. Test Results of Conducted Test

Test Engineer :	Fly	Temperature :	22~23°C
		Relative Humidity :	40~42%

Conducted Output Power(Average power) and ERP/EIRP

LTE Band 2_Ant.0

BW [MHz]	Modulation	RB Size	RB Offset	Power Low Ch. / Freq.	Power Middle Ch. / Freq.	Power High Ch. / Freq.	EIRP(W)		
Channel				18700	18900	19100	EIRP(W)		
Frequency (MHz)				1860	1880	1900	L	M	H
20	QPSK	1	0	23.09	23.03	23.06	0.1119	0.1104	0.1112
20	QPSK	1	49	23.37	23.42	23.36	0.1194	0.1208	0.1191
20	QPSK	1	99	22.96	22.98	22.98	0.1086	0.1091	0.1091
20	QPSK	50	0	22.34	22.40	22.33	0.0942	0.0955	0.0940
20	QPSK	50	24	22.30	22.36	22.31	0.0933	0.0946	0.0935
20	QPSK	50	50	22.32	22.37	22.29	0.0938	0.0948	0.0931
20	QPSK	100	0	22.33	22.41	22.33	0.0940	0.0957	0.0940
20	16QAM	1	0	22.35	22.32	22.34	0.0944	0.0938	0.0942
20	64QAM	1	0	21.22	21.20	21.22	0.0728	0.0724	0.0728
Channel				18675	18900	19125	EIRP(W)		
Frequency (MHz)				1857.5	1880	1902.5	L	M	H
15	QPSK	1	0	23.01	22.89	23.05	0.1099	0.1069	0.1109
15	16QAM	1	0	22.22	22.29	22.31	0.0916	0.0931	0.0935
Channel				18650	18900	19150	EIRP(W)		
Frequency (MHz)				1855	1880	1905	L	M	H
10	QPSK	1	0	23.04	23.01	23.02	0.1107	0.1099	0.1102
10	16QAM	1	0	22.34	22.23	22.24	0.0942	0.0918	0.0920
Channel				18625	18900	19175	EIRP(W)		
Frequency (MHz)				1852.5	1880	1907.5	L	M	H
5	QPSK	1	0	22.97	22.98	23.00	0.1089	0.1091	0.1096
5	16QAM	1	0	22.29	22.31	22.29	0.0931	0.0935	0.0931
Channel				18615	18900	19185	EIRP(W)		
Frequency (MHz)				1851.5	1880	1908.5	L	M	H
3	QPSK	1	0	22.99	22.89	22.99	0.1094	0.1069	0.1094
3	16QAM	1	0	22.33	22.19	22.32	0.0940	0.0910	0.0938
Channel				18607	18900	19193	EIRP(W)		
Frequency (MHz)				1850.7	1880	1909.3	L	M	H
1.4	QPSK	1	0	22.97	22.88	23.03	0.1089	0.1067	0.1104
1.4	16QAM	1	0	22.48	22.37	22.47	0.0973	0.0948	0.0971



LTE Band 4_Ant.0

BW [MHz]	Modulation	RB Size	RB Offset	Power Low Ch. / Freq.	Power Middle Ch. / Freq.	Power High Ch. / Freq.	EIRP(W)		
Channel				20050	20175	20300			
Frequency (MHz)				1720	1732.5	1745	L	M	H
20	QPSK	1	0	23.10	23.08	23.12	0.1023	0.1019	0.1028
20	QPSK	1	49	23.35	23.38	23.34	0.1084	0.1091	0.1081
20	QPSK	1	99	23.11	23.10	23.07	0.1026	0.1023	0.1016
20	QPSK	50	0	22.42	22.45	22.41	0.0875	0.0881	0.0873
20	QPSK	50	24	22.37	22.35	22.39	0.0865	0.0861	0.0869
20	QPSK	50	50	22.40	22.39	22.35	0.0871	0.0869	0.0861
20	QPSK	100	0	22.39	22.43	22.41	0.0869	0.0877	0.0873
20	16QAM	1	0	22.33	22.34	22.30	0.0857	0.0859	0.0851
20	64QAM	1	0	21.20	21.29	21.18	0.0661	0.0675	0.0658
Channel				20025	20175	20325	EIRP(W)		
Frequency (MHz)				1717.5	1732.5	1747.5	L	M	H
15	QPSK	1	0	23.07	22.94	23.09	0.1016	0.0986	0.1021
15	16QAM	1	0	22.18	22.32	22.26	0.0828	0.0855	0.0843
Channel				20000	20175	20350	EIRP(W)		
Frequency (MHz)				1715	1732.5	1750	L	M	H
10	QPSK	1	0	23.03	22.94	22.97	0.1007	0.0986	0.0993
10	16QAM	1	0	22.31	22.33	22.26	0.0853	0.0857	0.0843
Channel				19975	20175	20375	EIRP(W)		
Frequency (MHz)				1712.5	1732.5	1752.5	L	M	H
5	QPSK	1	0	23.04	23.03	23.07	0.1009	0.1007	0.1016
5	16QAM	1	0	22.23	22.33	22.25	0.0838	0.0857	0.0841
Channel				19965	20175	20385	EIRP(W)		
Frequency (MHz)				1711.5	1732.5	1753.5	L	M	H
3	QPSK	1	0	23.09	23.05	23.03	0.1021	0.1012	0.1007
3	16QAM	1	0	22.19	22.32	22.20	0.0830	0.0855	0.0832
Channel				19950	20175	20393	EIRP(W)		
Frequency (MHz)				1710	1732.5	1754.3	L	M	H
1.4	QPSK	1	0	23.01	23.06	23.10	0.1002	0.1014	0.1023
1.4	16QAM	1	0	22.32	22.24	22.15	0.0855	0.0839	0.0822



LTE Band 5_Ant.0

BW [MHz]	Modulation	RB Size	RB Offset	Power Low Ch. / Freq.	Power Middle Ch. / Freq.	Power High Ch. / Freq.	ERP(W)		
Channel				20450	20525	20600			
Frequency (MHz)				829	836.5	844	L	M	H
10	QPSK	1	0	23.34	23.35	23.35	0.0500	0.0501	0.0501
10	QPSK	1	25	23.43	23.44	23.43	0.0511	0.0512	0.0511
10	QPSK	1	49	23.34	23.29	23.29	0.0500	0.0494	0.0494
10	QPSK	25	0	22.49	22.53	22.45	0.0411	0.0415	0.0407
10	QPSK	25	12	22.45	22.44	22.42	0.0407	0.0406	0.0405
10	QPSK	25	25	22.48	22.45	22.34	0.0410	0.0407	0.0397
10	QPSK	50	0	22.48	22.50	22.45	0.0410	0.0412	0.0407
10	16QAM	1	0	22.50	22.63	22.58	0.0412	0.0425	0.0420
10	64QAM	1	0	21.43	21.53	21.47	0.0322	0.0330	0.0325
Channel				20425	20525	20625	ERP(W)		
Frequency (MHz)				826.5	836.5	846.5	L	M	H
5	QPSK	1	0	23.22	23.33	23.31	0.0486	0.0499	0.0497
5	16QAM	1	0	22.45	22.61	22.51	0.0407	0.0423	0.0413
Channel				20415	20525	20635	ERP(W)		
Frequency (MHz)				825.5	836.5	847.5	L	M	H
3	QPSK	1	0	23.20	23.30	23.30	0.0484	0.0495	0.0495
3	16QAM	1	0	22.48	22.57	22.48	0.0410	0.0419	0.0410
Channel				20407	20525	20643	ERP(W)		
Frequency (MHz)				824.7	836.5	848.3	L	M	H
1.4	QPSK	1	0	23.23	23.24	23.22	0.0488	0.0489	0.0486
1.4	16QAM	1	0	22.35	22.51	22.52	0.0398	0.0413	0.0414



LTE Band 7_Ant.0

BW [MHz]	Modulation	RB Size	RB Offset	Power Low Ch. / Freq.	Power Middle Ch. / Freq.	Power High Ch. / Freq.	EIRP(W)		
Channel				20850	20850	21350			
Frequency (MHz)				2510	2535	2560	L	M	H
20	QPSK	1	0	23.08	23.12	23.01	0.1143	0.1153	0.1125
20	QPSK	1	49	23.44	23.50	23.44	0.1242	0.1259	0.1242
20	QPSK	1	99	23.08	23.13	23.06	0.1143	0.1156	0.1138
20	QPSK	50	0	22.77	22.85	22.78	0.1064	0.1084	0.1067
20	QPSK	50	24	22.72	22.78	22.73	0.1052	0.1067	0.1054
20	QPSK	50	50	22.75	22.83	22.72	0.1059	0.1079	0.1052
20	QPSK	100	0	22.71	22.81	22.70	0.1050	0.1074	0.1047
20	16QAM	1	0	22.54	22.61	22.58	0.1009	0.1026	0.1019
20	64QAM	1	0	21.52	21.60	21.52	0.0798	0.0813	0.0798
Channel				20825	21100	21375	EIRP(W)		
Frequency (MHz)				2507.5	2535	2562.5	L	M	H
15	QPSK	1	0	22.93	22.99	22.99	0.1104	0.1119	0.1119
15	16QAM	1	0	22.52	22.56	22.44	0.1005	0.1014	0.0986
Channel				20800	21100	21400	EIRP(W)		
Frequency (MHz)				2505	2535	2565	L	M	H
10	QPSK	1	0	22.93	22.97	22.98	0.1104	0.1114	0.1117
10	16QAM	1	0	22.46	22.57	22.56	0.0991	0.1016	0.1014
Channel				20775	21100	21425	EIRP(W)		
Frequency (MHz)				2502.5	2535	2567.5	L	M	H
5	QPSK	1	0	22.96	23.00	22.98	0.1112	0.1122	0.1117
5	16QAM	1	0	22.41	22.50	22.57	0.0979	0.1000	0.1016



LTE Band 13_Ant.0

BW [MHz]	Modulation	RB Size	RB Offset	Power Low Ch. / Freq.	Power Middle Ch. / Freq.	Power High Ch. / Freq.	ERP(W)		
Channel				23230					
Frequency (MHz)				782				M	
10	QPSK	1	0		23.30			0.0569	
10	QPSK	1	25		23.43			0.0586	
10	QPSK	1	49		23.33			0.0573	
10	QPSK	25	0		22.45			0.0468	
10	QPSK	25	12		22.43			0.0466	
10	QPSK	25	25		22.27			0.0449	
10	QPSK	50	0		22.36			0.0458	
10	16QAM	1	0		22.56			0.0480	
10	64QAM	1	0		21.53			0.0378	
Channel				23205	23230	23255	ERP(W)		
Frequency (MHz)				779.5	782	784.5	L	M	H
5	QPSK	1	0	23.28	23.24	23.20	0.0566	0.0561	0.0556
5	16QAM	1	0	22.47	22.45	22.48	0.0470	0.0468	0.0471



LTE Band 26_Ant.0

BW [MHz]	Modulation	RB Size	RB Offset	Power Low Ch. / Freq.	Power Low Ch. / Freq.	Power Middle Ch. / Freq.	Power High Ch. / Freq.	ERP(W)			
Channel				26790	26865	26915	26965				
Frequency (MHz)				824	831.5	836.5	841.5	Straddle Ch	L	M	H
15	QPSK	1	0	23.16	23.18	23.18	23.19	0.0491	0.0493	0.0493	0.0494
15	QPSK	1	37	23.46	23.48	23.50	23.45	0.0526	0.0528	0.0531	0.0525
15	QPSK	1	74	23.22	23.23	23.14	23.14	0.0498	0.0499	0.0489	0.0489
15	QPSK	36	0	22.38	22.41	22.43	22.39	0.0410	0.0413	0.0415	0.0411
15	QPSK	36	20	22.36	22.39	22.41	22.37	0.0408	0.0411	0.0413	0.0409
15	QPSK	36	39	22.28	22.30	22.35	22.29	0.0401	0.0403	0.0407	0.0402
15	QPSK	75	0	22.32	22.30	22.39	22.35	0.0405	0.0403	0.0411	0.0407
15	16QAM	1	0	22.34	22.43	22.36	22.47	0.0406	0.0415	0.0408	0.0419
15	64QAM	1	0	21.30	21.32	21.31	21.38	0.0320	0.0321	0.0321	0.0326
Channel					26840	26915	26990	ERP(W)			
Frequency (MHz)					829	836.5	844	L	M	H	
10	QPSK	1	0		23.08	23.05	23.04		0.0482	0.0479	0.0478
10	16QAM	1	0		22.41	22.24	22.45		0.0413	0.0397	0.0417
Channel					26815	26915	27015	ERP(W)			
Frequency (MHz)					826.5	836.5	846.5	L	M	H	
5	QPSK	1	0		23.16	23.11	23.12		0.0491	0.0485	0.0486
5	16QAM	1	0		22.29	22.25	22.44		0.0402	0.0398	0.0416
Channel					26815	26915	27025	ERP(W)			
Frequency (MHz)					825.5	836.5	847.5	L	M	H	
3	QPSK	1	0		23.07	23.17	23.13		0.0481	0.0492	0.0488
3	16QAM	1	0		22.33	22.31	22.43		0.0406	0.0404	0.0415
Channel					26797	26915	27033	ERP(W)			
Frequency (MHz)					824.7	836.5	848.3	L	M	H	
1.4	QPSK	1	0		23.13	23.03	23.06		0.0488	0.0476	0.0480
1.4	16QAM	1	0		22.41	22.33	22.40		0.0413	0.0406	0.0412



LTE Band 66_Ant.0

BW [MHz]	Modulation	RB Size	RB Offset	Power Low Ch. / Freq.	Power Middle Ch. / Freq.	Power High Ch. / Freq.	EIRP(W)		
Channel				132072	132322	132572	EIRP(W)		
Frequency (MHz)				1720	1745	1770	L	M	H
20	QPSK	1	0	23.07	23.06	23.13	0.1016	0.1014	0.1030
20	QPSK	1	49	23.37	23.43	23.35	0.1089	0.1104	0.1084
20	QPSK	1	99	23.06	23.13	23.06	0.1014	0.1030	0.1014
20	QPSK	50	0	22.75	22.84	22.80	0.0944	0.0964	0.0955
20	QPSK	50	24	22.73	22.79	22.70	0.0940	0.0953	0.0933
20	QPSK	50	50	22.70	22.73	22.72	0.0933	0.0940	0.0938
20	QPSK	100	0	22.66	22.84	22.77	0.0925	0.0964	0.0948
20	16QAM	1	0	22.69	22.68	22.86	0.0931	0.0929	0.0968
20	64QAM	1	0	21.57	21.60	21.72	0.0719	0.0724	0.0745
Channel				132047	132322	132597	EIRP(W)		
Frequency (MHz)				1717.5	1745	1772.5	L	M	H
15	QPSK	1	0	22.97	22.93	23.04	0.0993	0.0984	0.1009
15	16QAM	1	0	22.60	22.54	22.73	0.0912	0.0899	0.0940
Channel				132022	132322	132622	EIRP(W)		
Frequency (MHz)				1715	1745	1775	L	M	H
10	QPSK	1	0	23.02	22.95	23.07	0.1005	0.0989	0.1016
10	16QAM	1	0	22.60	22.59	22.75	0.0912	0.0910	0.0944
Channel				131997	132322	132647	EIRP(W)		
Frequency (MHz)				1712.5	1745	1777.5	L	M	H
5	QPSK	1	0	23.00	22.99	23.01	0.1000	0.0998	0.1002
5	16QAM	1	0	22.56	22.57	22.75	0.0904	0.0906	0.0944
Channel				131987	132322	132657	EIRP(W)		
Frequency (MHz)				1711.5	1745	1778.5	L	M	H
3	QPSK	1	0	22.98	23.01	23.02	0.0995	0.1002	0.1005
3	16QAM	1	0	22.59	22.60	22.72	0.0910	0.0912	0.0938
Channel				131979	132322	132665	EIRP(W)		
Frequency (MHz)				1710.7	1745	1779.3	L	M	H
1.4	QPSK	1	0	22.96	23.10	23.03	0.0991	0.1023	0.1007
1.4	16QAM	1	0	22.58	22.71	22.77	0.0908	0.0935	0.0948



LTE Band 38_Ant.0

BW [MHz]	Modulation	RB Size	RB Offset	Power Low Ch. / Freq.	Power Middle Ch. / Freq.	Power High Ch. / Freq.	EIRP(W)		
Channel				37850	38000	38150			
Frequency (MHz)				2580	2595	2610	L	M	H
20	QPSK	1	0	23.06	22.97	22.95	0.1086	0.1064	0.1059
20	QPSK	1	49	23.41	23.43	23.39	0.1178	0.1183	0.1172
20	QPSK	1	99	23.04	23.04	23.07	0.1081	0.1081	0.1089
20	QPSK	50	0	22.68	22.70	22.67	0.0995	0.1000	0.0993
20	QPSK	50	24	22.62	22.63	22.66	0.0982	0.0984	0.0991
20	QPSK	50	50	22.64	22.69	22.60	0.0986	0.0998	0.0977
20	QPSK	100	0	22.62	22.67	22.65	0.0982	0.0993	0.0989
20	16QAM	1	0	22.54	22.46	22.46	0.0964	0.0946	0.0946
20	64QAM	1	0	21.30	21.23	21.22	0.0724	0.0713	0.0711
Channel				37825	38000	38175	EIRP(W)		
Frequency (MHz)				2577.5	2595	2612.5	L	M	H
15	QPSK	1	0	23.00	22.82	22.92	0.1072	0.1028	0.1052
15	16QAM	1	0	22.39	22.42	22.45	0.0931	0.0938	0.0944
Channel				37800	38000	38200	EIRP(W)		
Frequency (MHz)				2575	2595	2615	L	M	H
10	QPSK	1	0	22.97	22.85	22.93	0.1064	0.1035	0.1054
10	16QAM	1	0	22.46	22.36	22.41	0.0946	0.0925	0.0935
Channel				37775	38000	38225	EIRP(W)		
Frequency (MHz)				2572.5	2595	2617.5	L	M	H
5	QPSK	1	0	23.02	22.83	22.85	0.1076	0.1030	0.1035
5	16QAM	1	0	22.40	22.34	22.35	0.0933	0.0920	0.0923



LTE Band 2

Peak-to-Average Ratio

Mode	LTE Band 2 / 20MHz			
Mod.	QPSK	16QAM	64QAM	Limit: 13dB
RB Size	Full RB	Full RB	Full RB	Result
Middle CH	5.01	5.80	6.29	PASS

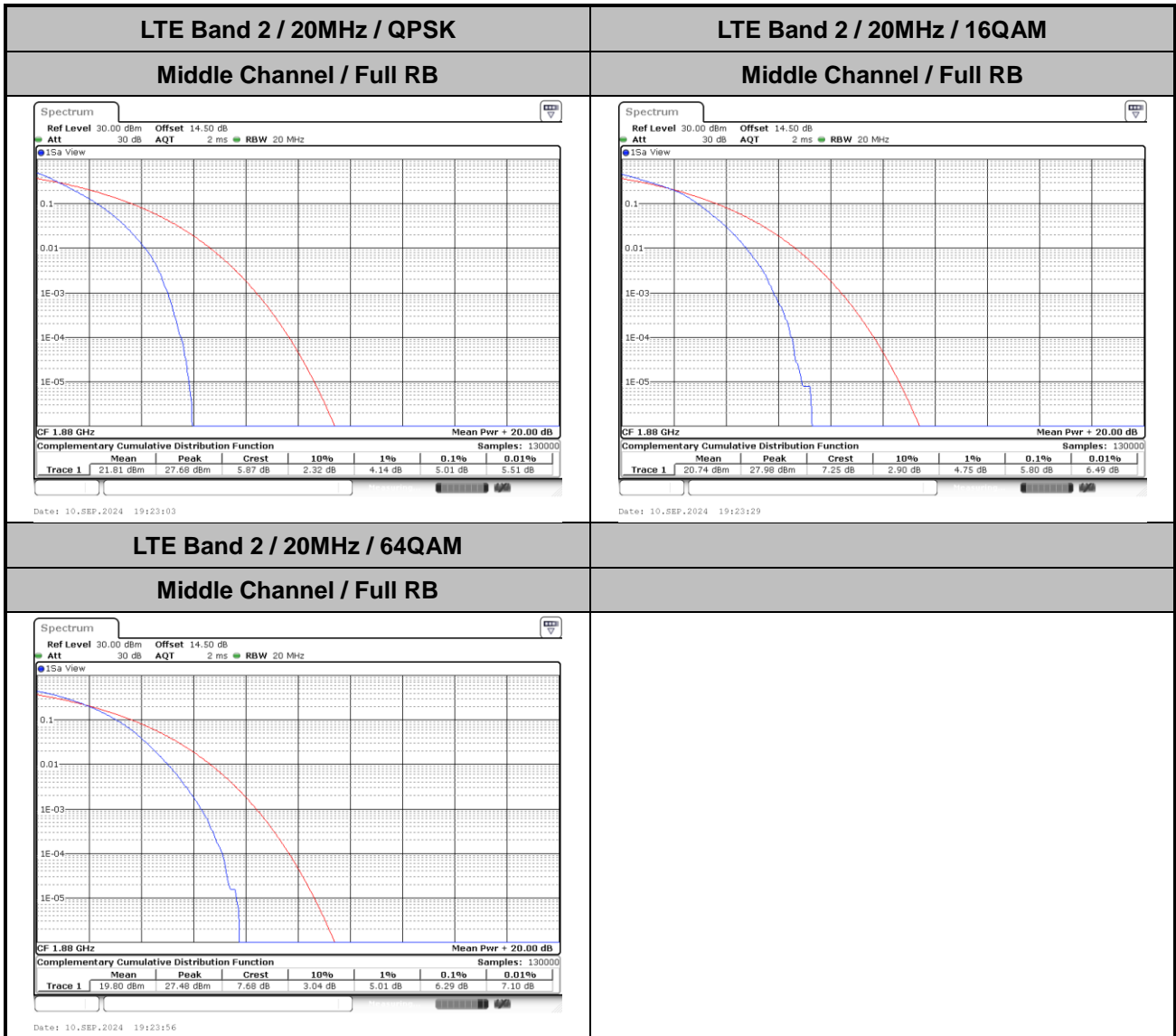



26dB Bandwidth

Mode	LTE Band 2 : 26dB BW(MHz)											
	1.4MHz		3MHz		5MHz		10MHz		15MHz		20MHz	
Mod.	QPSK	16QAM	QPSK	16QAM	QPSK	16QAM	QPSK	16QAM	QPSK	16QAM	QPSK	16QAM
Middle CH	1.26	1.30	2.94	2.96	4.84	4.80	9.83	9.71	14.18	14.36	18.86	18.90



LTE Band 2

Middle Channel / 1.4MHz / QPSK

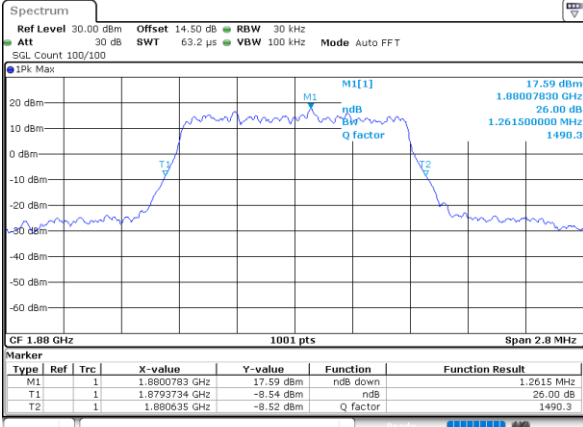

Date: 10_SEP.2024 18:08:00

Middle Channel / 1.4MHz / 16QAM

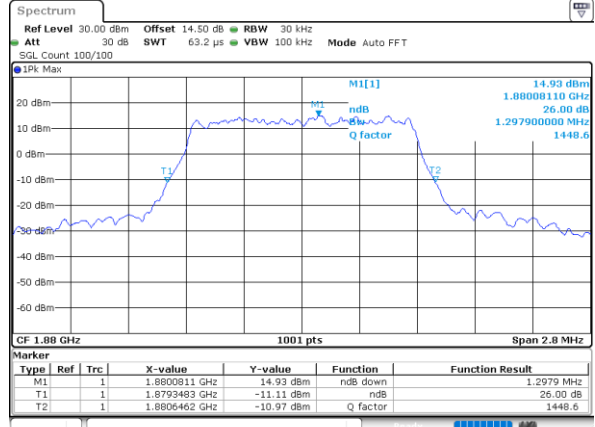

Date: 10_SEP.2024 18:08:139

Middle Channel / 3MHz / QPSK

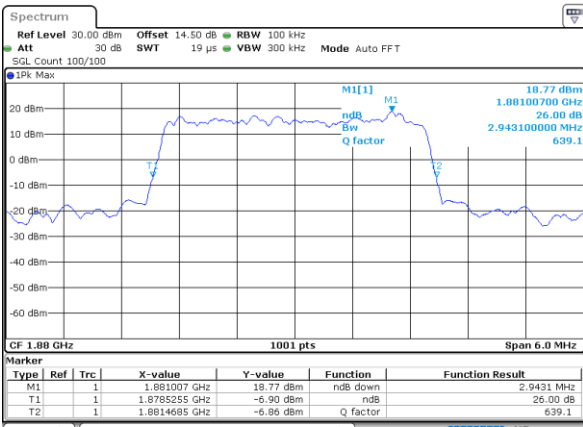

Date: 10_SEP.2024 18:22:48

Middle Channel / 3MHz / 16QAM

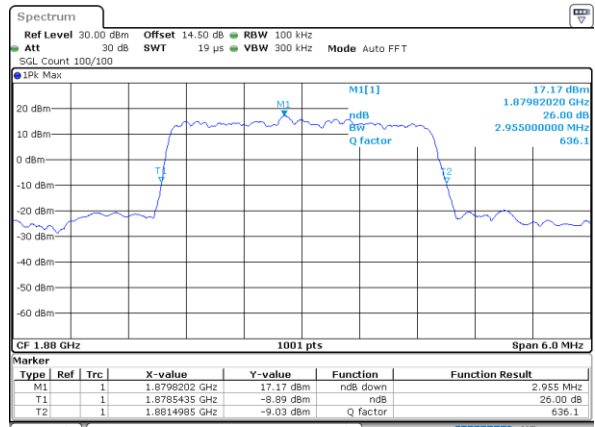

Date: 10_SEP.2024 18:23:127

Middle Channel / 5MHz / QPSK

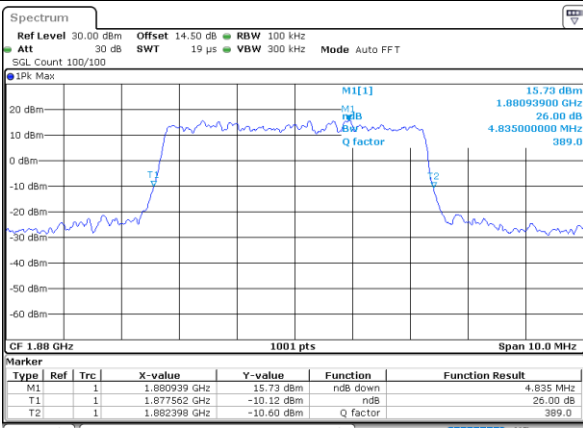

Date: 10_SEP.2024 18:37:35

Middle Channel / 5MHz / 16QAM

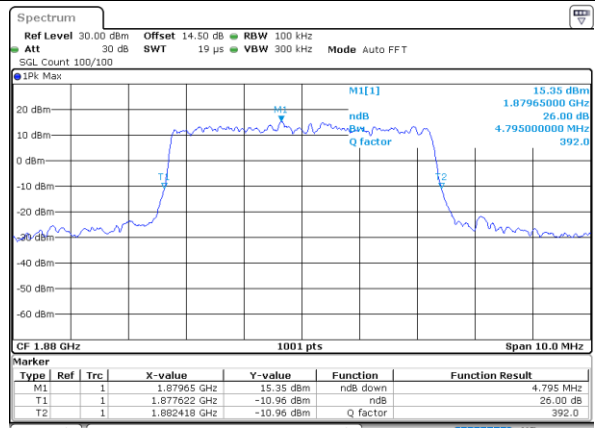

Date: 10_SEP.2024 18:38:14



LTE Band 2

Middle Channel / 10MHz / QPSK

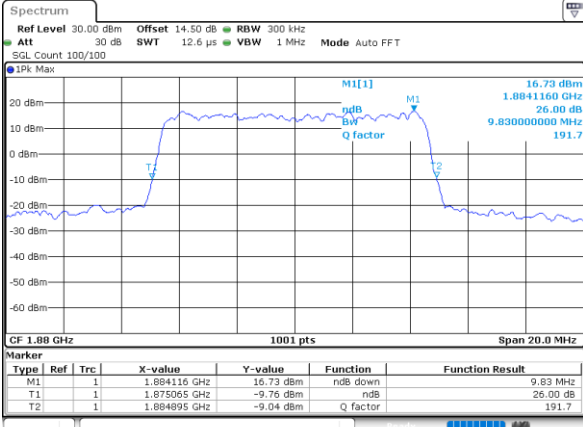

Date: 10_SEP.2024 18:52:22

Middle Channel / 10MHz / 16QAM

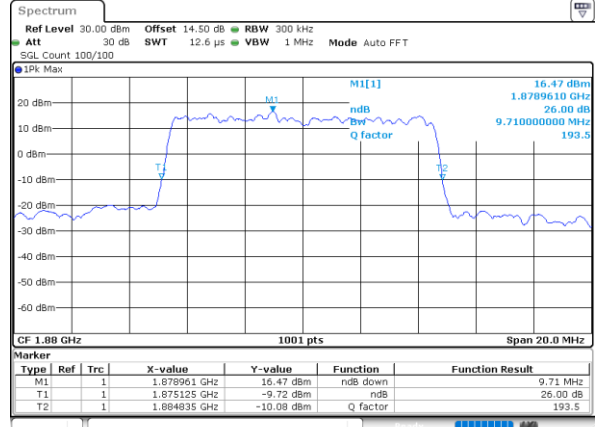

Date: 10_SEP.2024 18:53:01

Middle Channel / 15MHz / QPSK

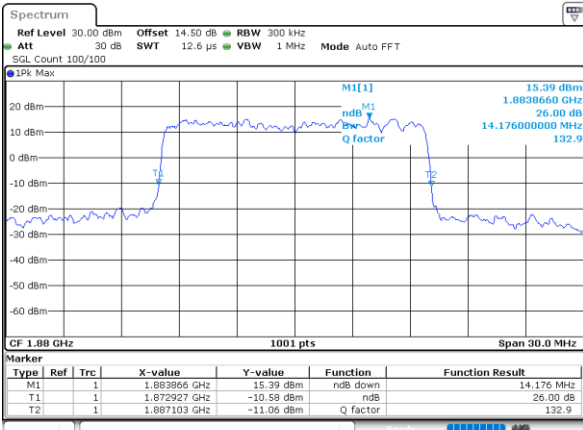

Date: 10_SEP.2024 19:07:09

Middle Channel / 15MHz / 16QAM

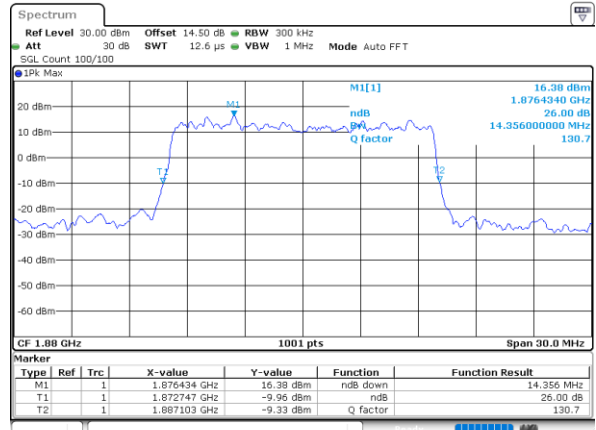

Date: 10_SEP.2024 19:07:48

Middle Channel / 20MHz / QPSK

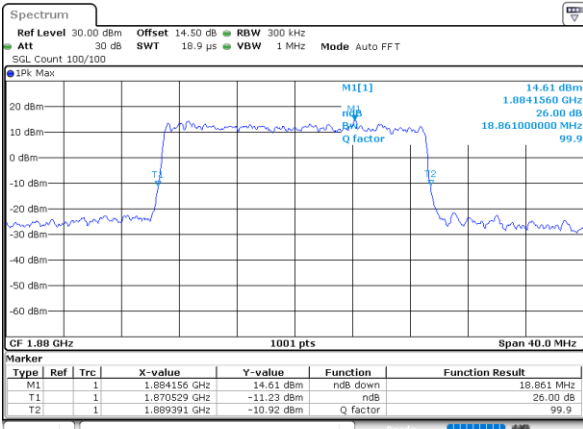

Date: 10_SEP.2024 19:21:57

Middle Channel / 20MHz / 16QAM

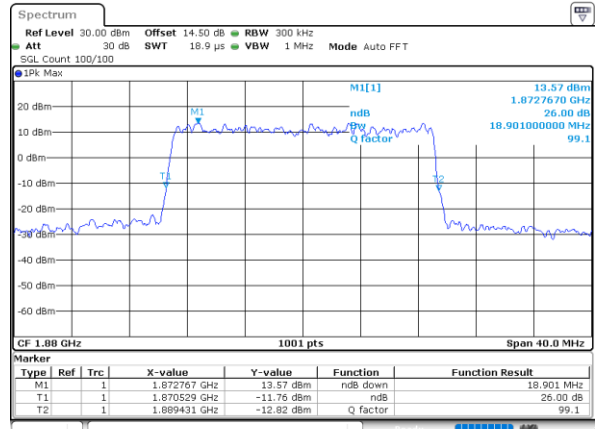

Date: 10_SEP.2024 19:22:36



Occupied Bandwidth

Mode	LTE Band 2 : 99%OBW(MHz)											
	1.4MHz		3MHz		5MHz		10MHz		15MHz		20MHz	
Mod.	QPSK	16QAM	QPSK	16QAM	QPSK	16QAM	QPSK	16QAM	QPSK	16QAM	QPSK	16QAM
Middle CH	1.09	1.10	2.71	2.70	4.50	4.49	9.11	9.05	13.46	13.43	18.02	17.94



LTE Band 2

Middle Channel / 1.4MHz / QPSK

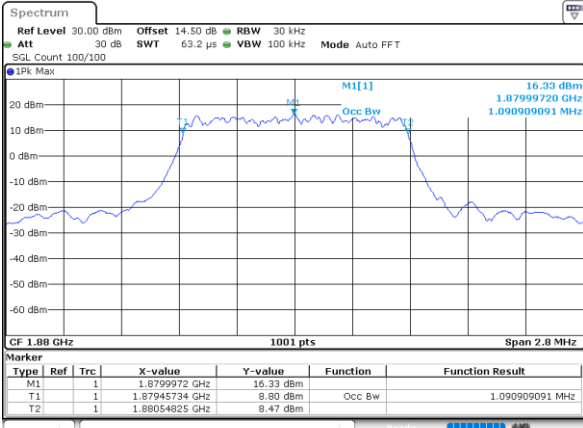

Date: 10_SEP.2024 18:07:46

Middle Channel / 1.4MHz / 16QAM

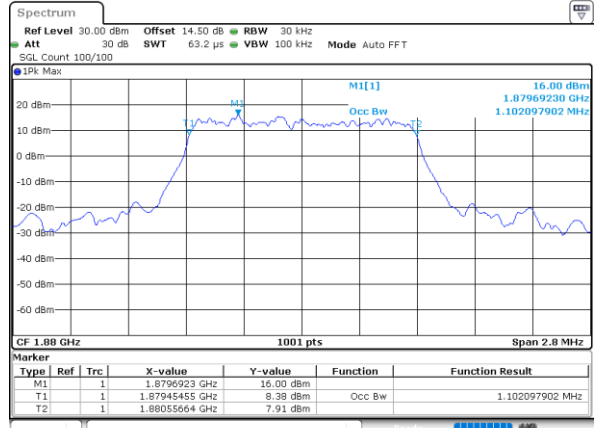

Date: 10_SEP.2024 18:08:26

Middle Channel / 3MHz / QPSK

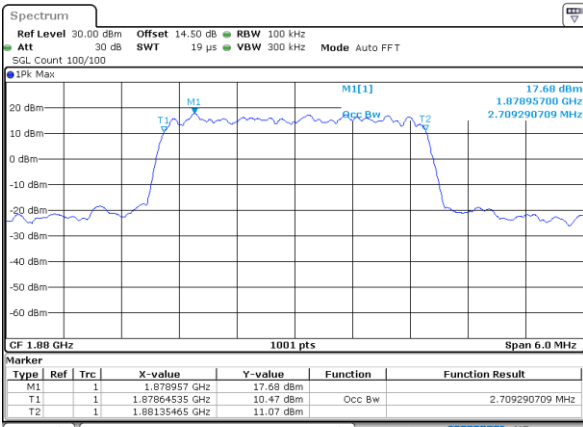

Date: 10_SEP.2024 18:22:04

Middle Channel / 3MHz / 16QAM

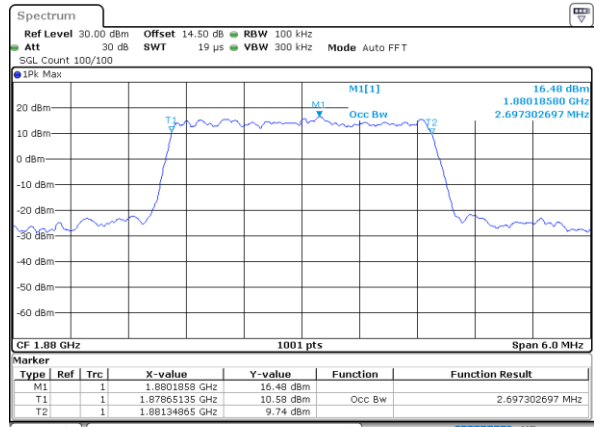

Date: 10_SEP.2024 18:23:13

Middle Channel / 5MHz / QPSK

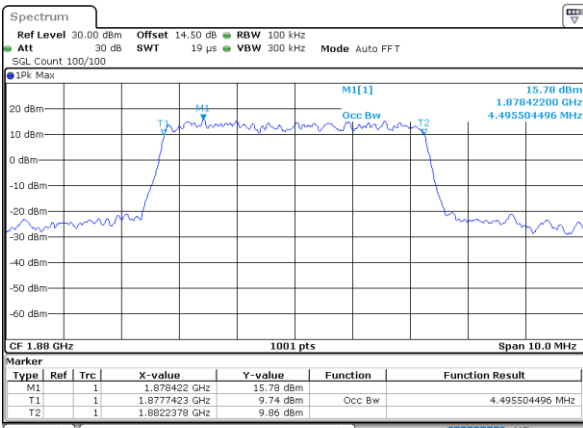

Date: 10_SEP.2024 18:37:21

Middle Channel / 5MHz / 16QAM

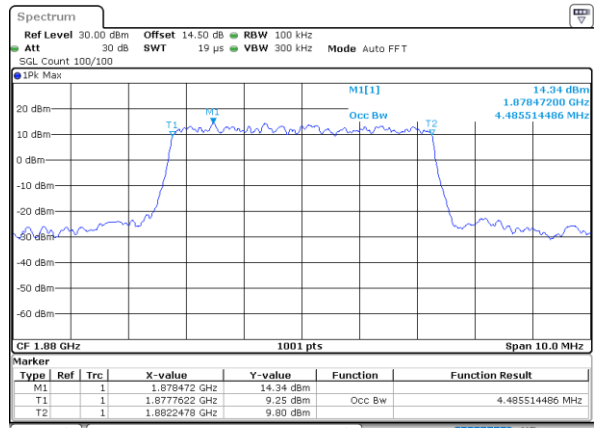

Date: 10_SEP.2024 18:38:00



LTE Band 2

Middle Channel / 10MHz / QPSK

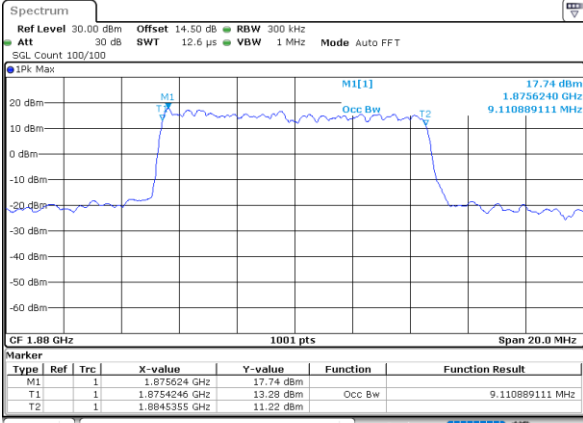

Date: 10_SEP.2024 18:52:08

Middle Channel / 10MHz / 16QAM

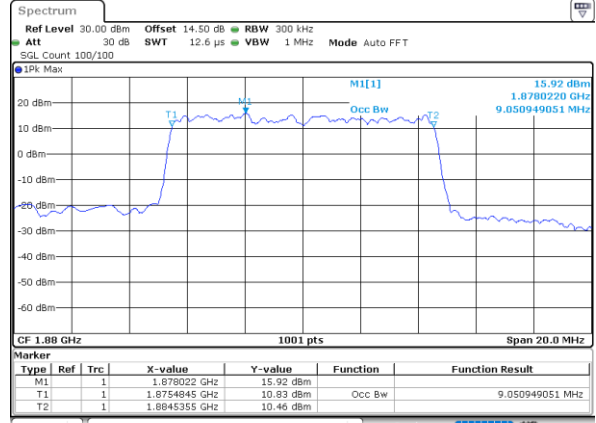

Date: 10_SEP.2024 18:52:47

Middle Channel / 15MHz / QPSK

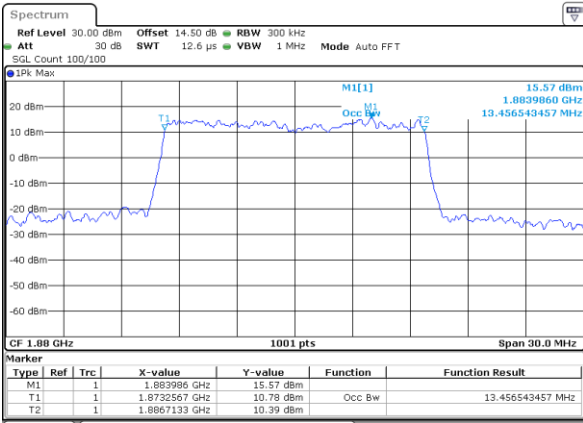

Date: 10_SEP.2024 19:06:55

Middle Channel / 15MHz / 16QAM

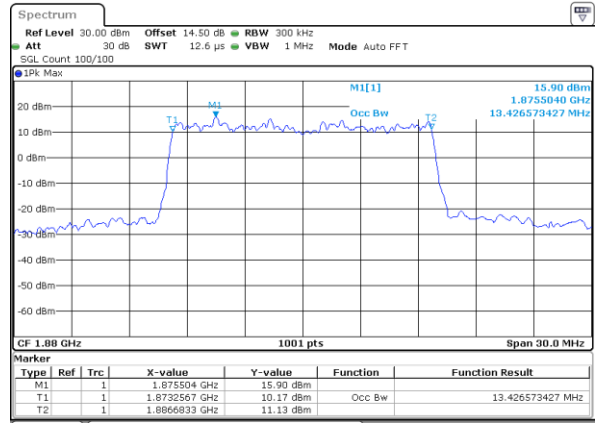

Date: 10_SEP.2024 19:07:34

Middle Channel / 20MHz / QPSK

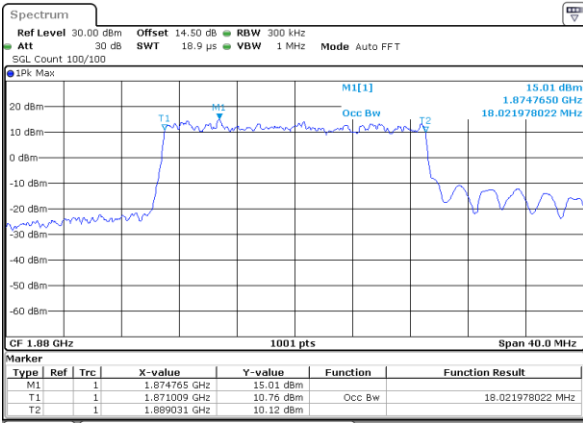

Date: 10_SEP.2024 19:21:43

Middle Channel / 20MHz / 16QAM

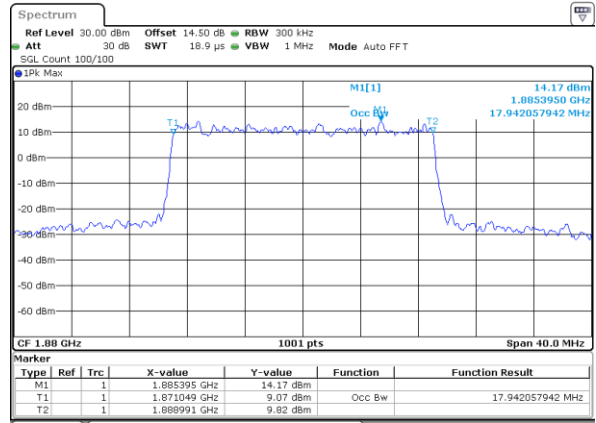

Date: 10_SEP.2024 19:22:23



Conducted Band Edge

LTE Band 2 / 1.4MHz / QPSK

Lowest Band Edge / 1RB

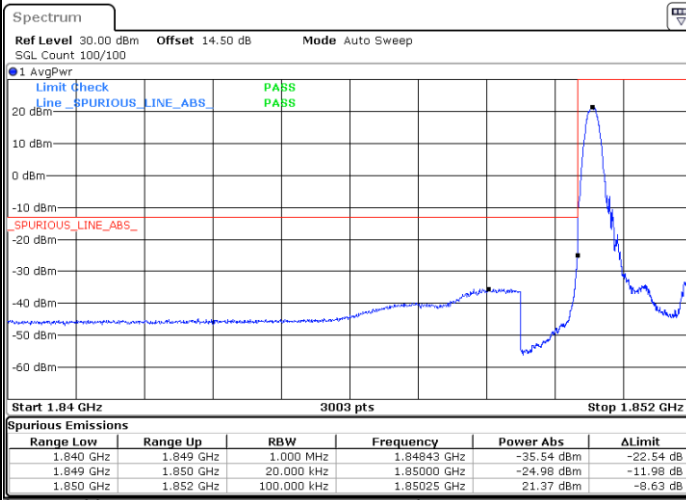

Highest Band Edge / 1RB



Lowest Band Edge / Full RB

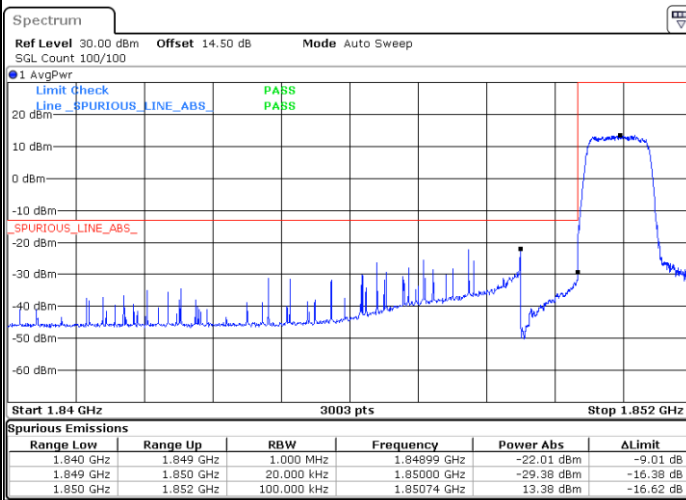

Highest Band Edge / Full RB

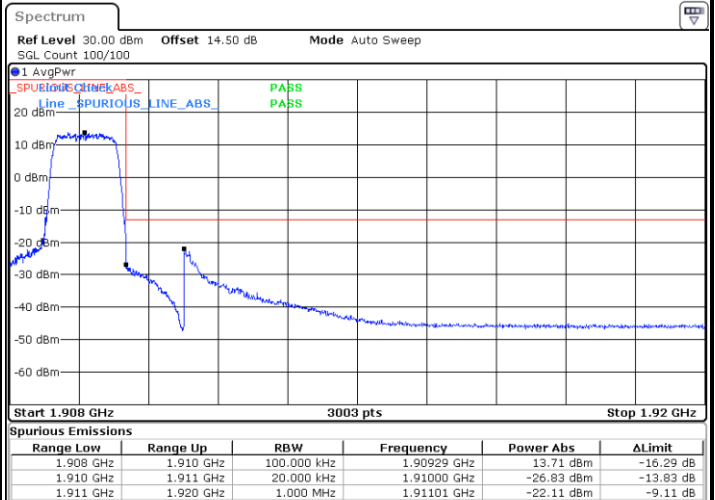



LTE Band 2 / 1.4MHz / 16QAM

Lowest Band Edge / 1 RB

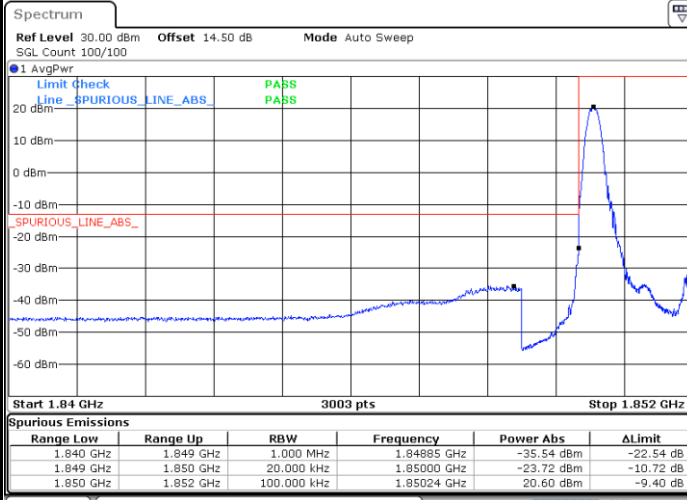

Date: 10.SEP.2024 18:01:50

Highest Band Edge / 1 RB

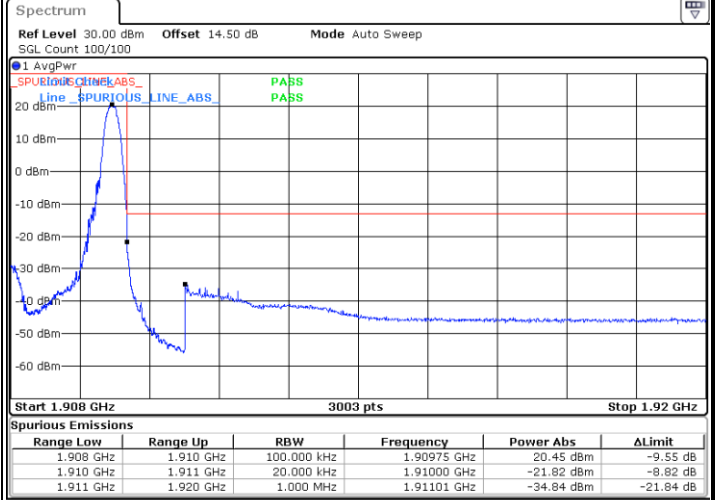

Date: 10.SEP.2024 18:10:09

Lowest Band Edge / Full RB

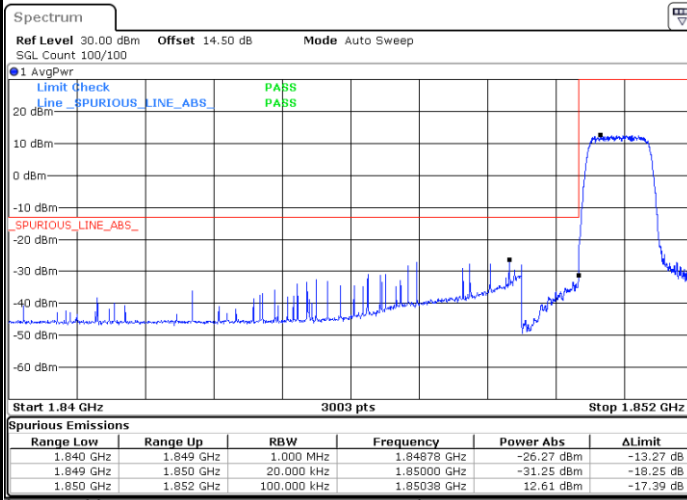

Date: 10.SEP.2024 18:05:20

Highest Band Edge / Full RB



Date: 10.SEP.2024 18:13:39



LTE Band 2 / 1.4MHz / 64QAM

Lowest Band Edge / 1 RB

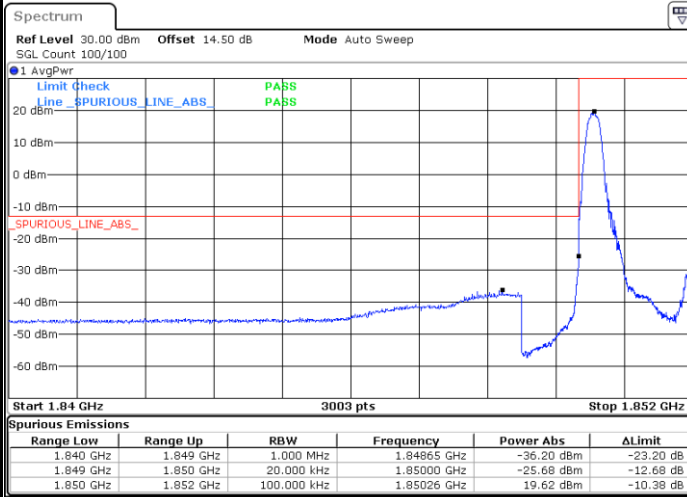

Date: 10.SEP.2024 18:02:36

Highest Band Edge / 1 RB

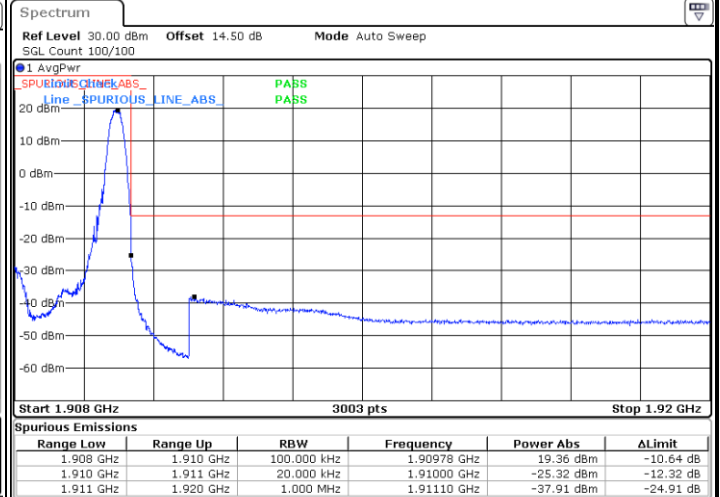

Date: 10.SEP.2024 18:10:54

Lowest Band Edge / Full RB

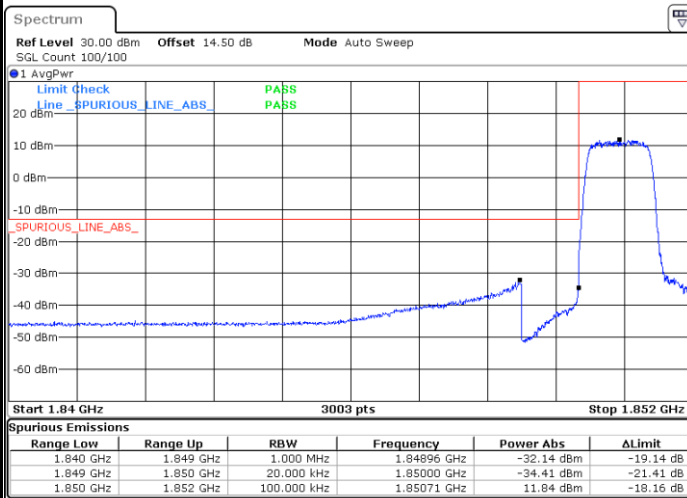

Date: 10.SEP.2024 18:06:06

Highest Band Edge / Full RB

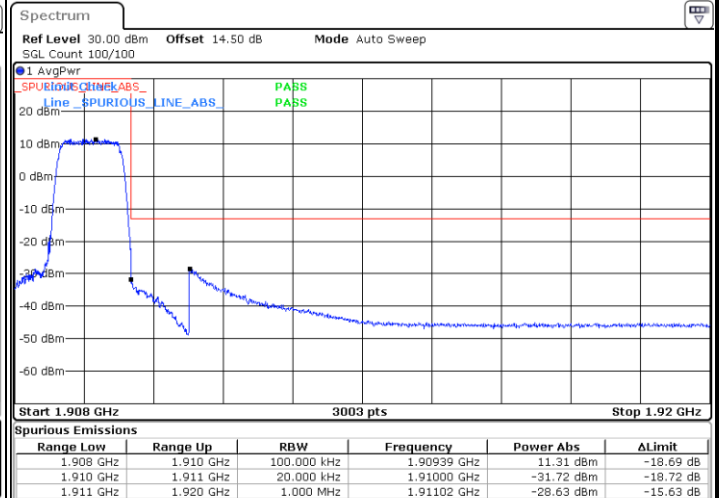

Date: 10.SEP.2024 18:14:25



LTE Band 2 / 3MHz / QPSK

Lowest Band Edge / 1RB

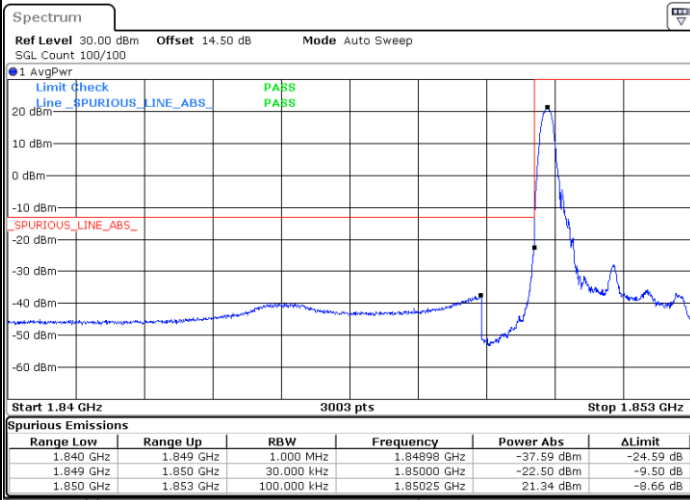

Date: 10.SEP.2024 18:15:53

Highest Band Edge / 1RB

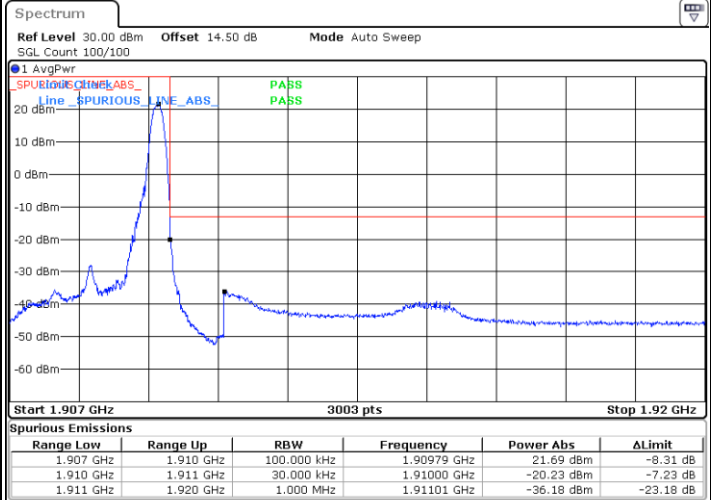

Date: 10.SEP.2024 18:24:12

Lowest Band Edge / Full RB

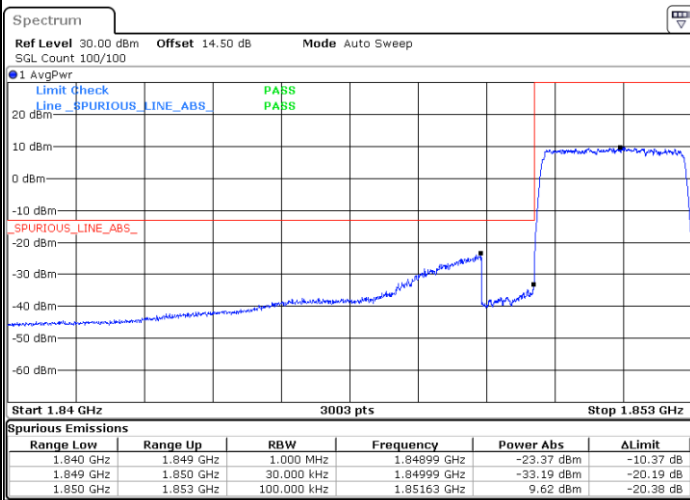

Date: 10.SEP.2024 18:19:23

Highest Band Edge / Full RB

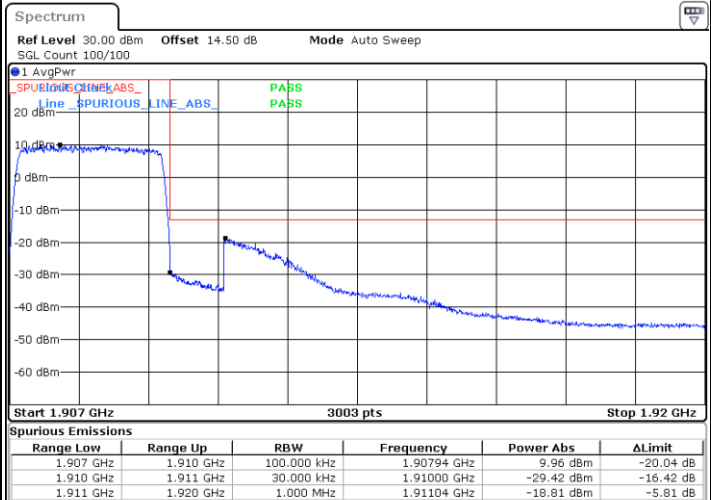

Date: 10.SEP.2024 18:26:27



LTE Band 2 / 3MHz / 16QAM

Lowest Band Edge / 1 RB

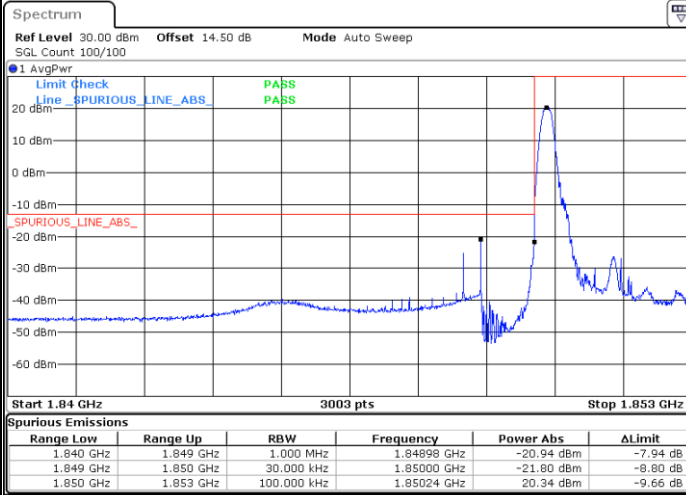

Date: 10.SEP.2024 18:16:38

Highest Band Edge / 1 RB

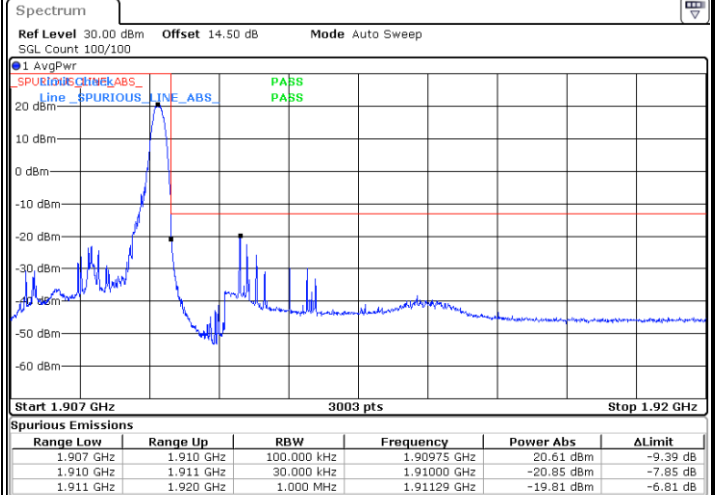

Date: 10.SEP.2024 18:24:57

Lowest Band Edge / Full RB

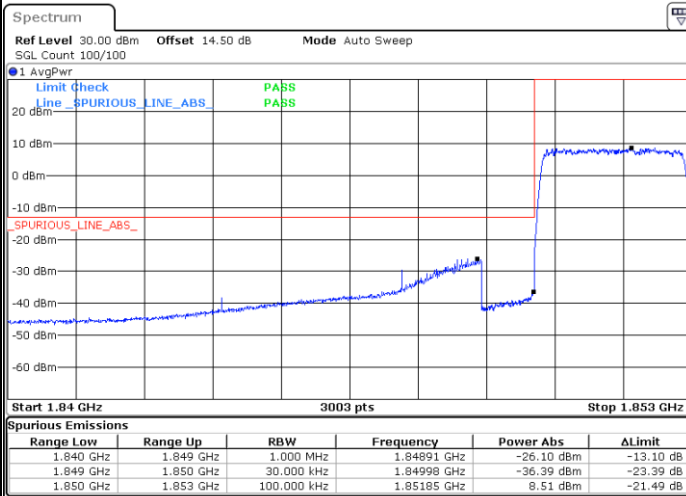

Date: 10.SEP.2024 18:20:08

Highest Band Edge / Full RB

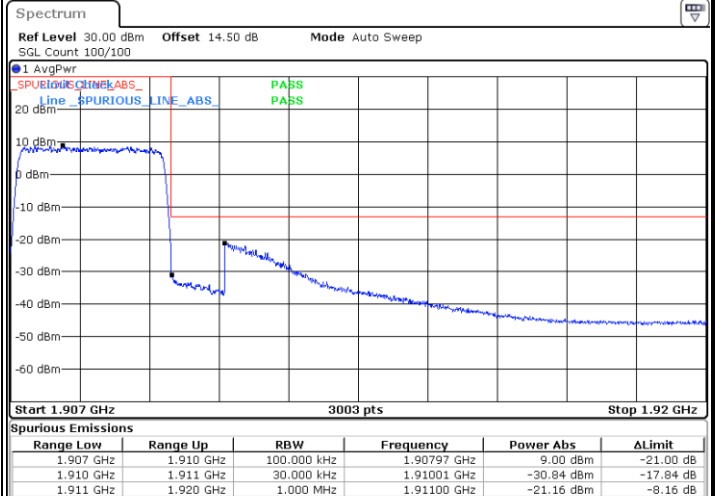

Date: 10.SEP.2024 18:27:12



LTE Band 2 / 3MHz / 64QAM

Lowest Band Edge / 1 RB

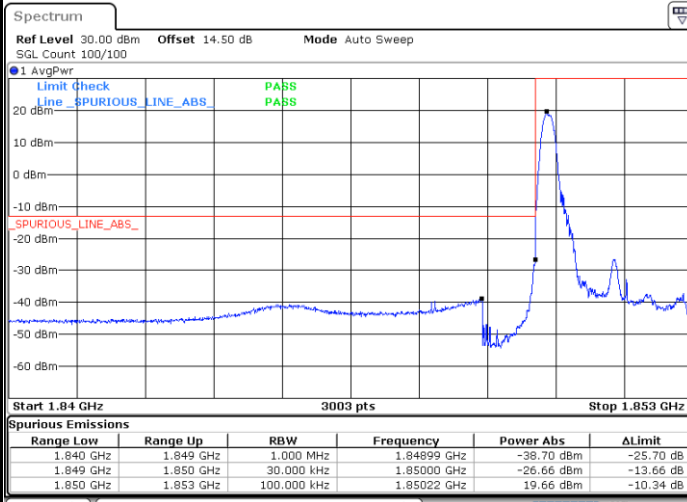

Date: 10.SEP.2024 18:17:23

Highest Band Edge / 1 RB

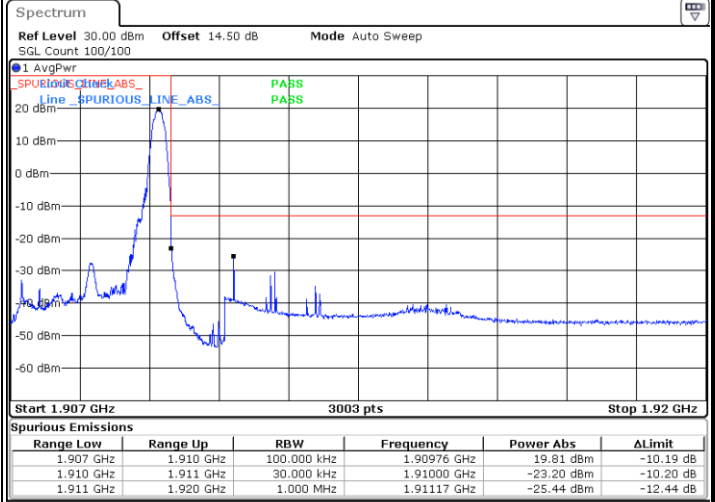

Date: 10.SEP.2024 18:25:42

Lowest Band Edge / Full RB

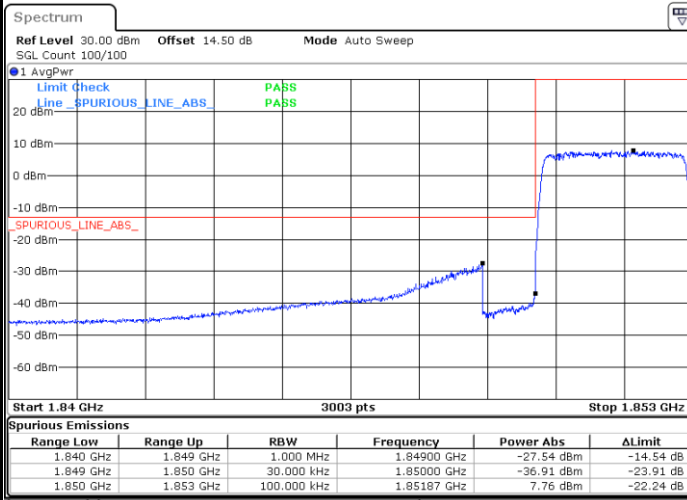

Date: 10.SEP.2024 18:20:53

Highest Band Edge / Full RB

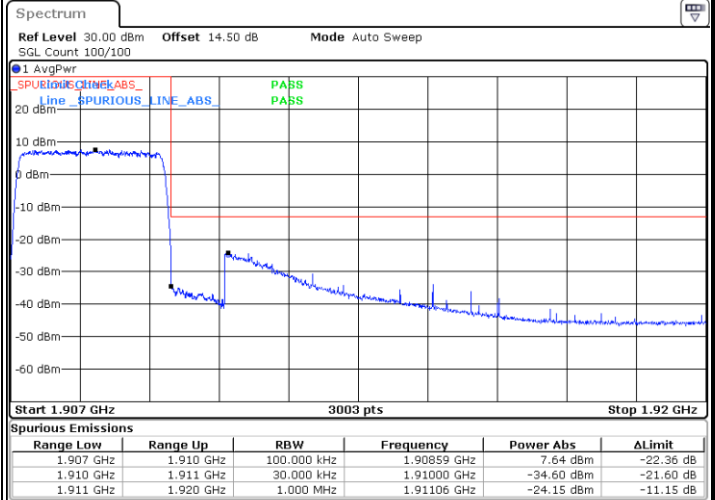

Date: 10.SEP.2024 18:27:57



LTE Band 2 / 5MHz / QPSK

Lowest Band Edge / 1RB

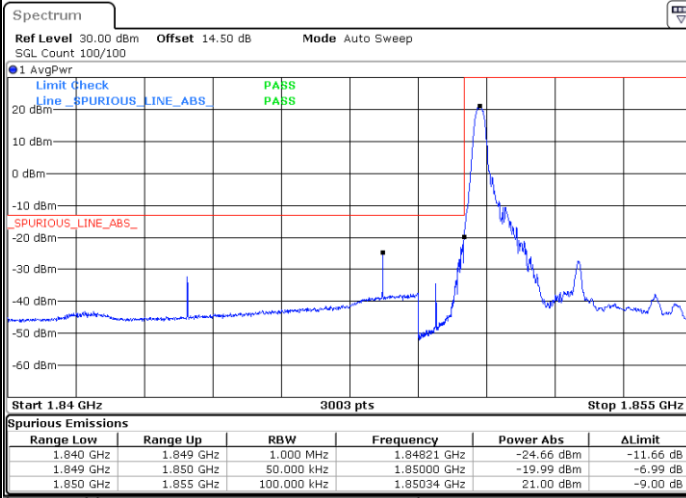

Date: 10.SEP.2024 18:30:40

Highest Band Edge / 1RB

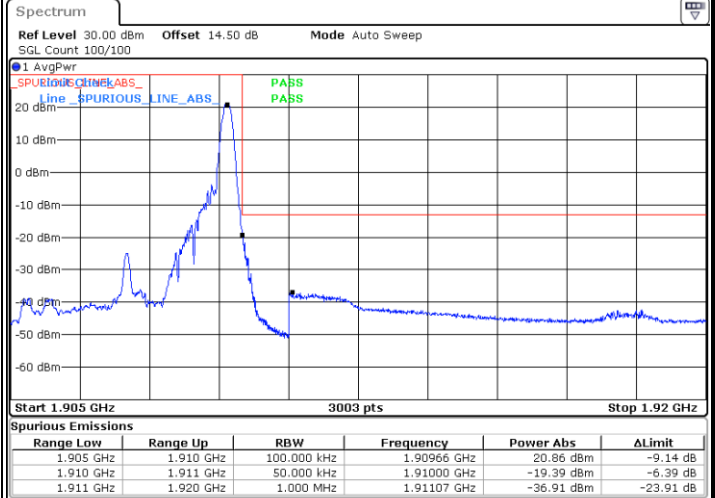

Date: 10.SEP.2024 18:38:59

Lowest Band Edge / Full RB

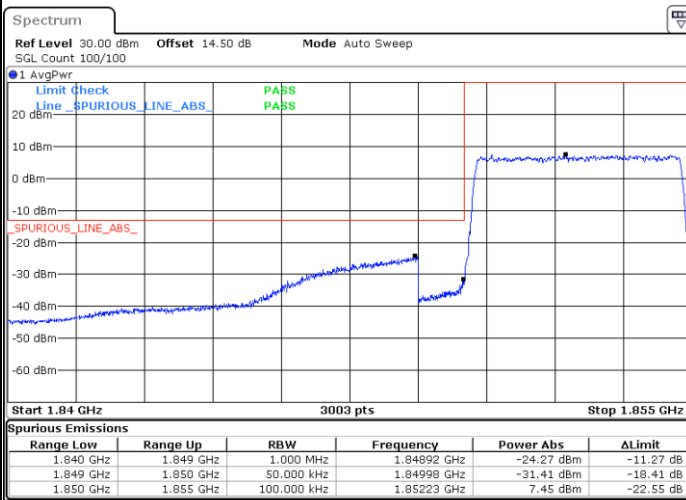

Date: 10.SEP.2024 18:34:10

Highest Band Edge / Full RB

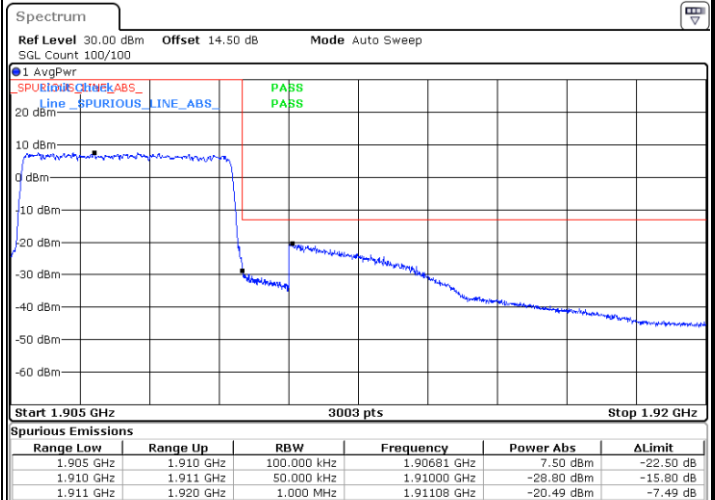

Date: 10.SEP.2024 18:41:15



LTE Band 2 / 5MHz / 16QAM

Lowest Band Edge / 1 RB

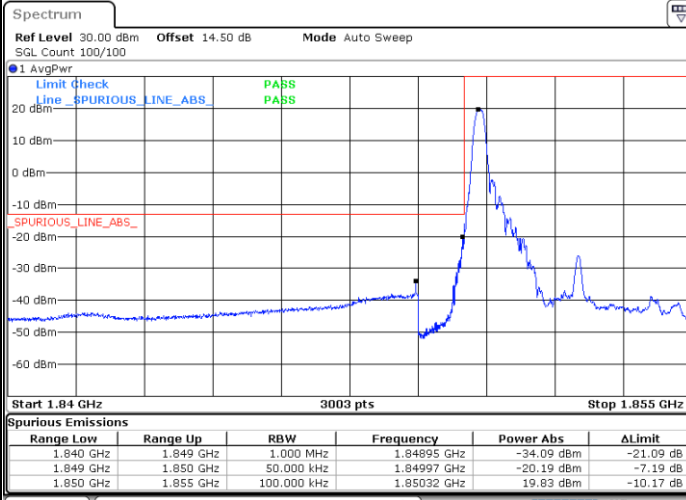

Date: 10.SEP.2024 18:31:25

Highest Band Edge / 1 RB

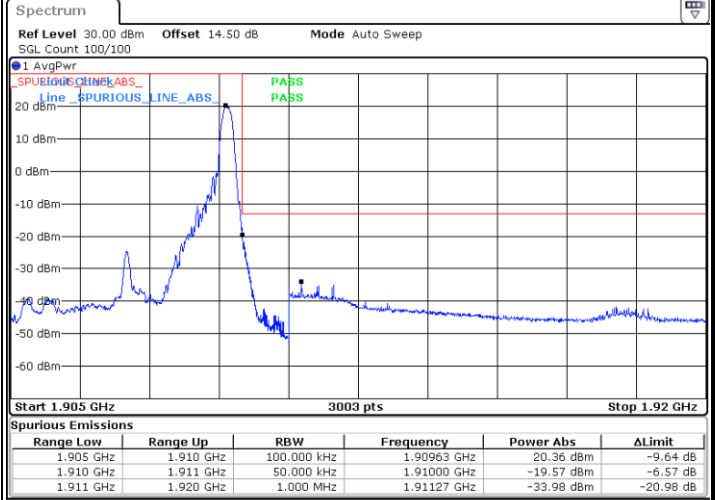

Date: 10.SEP.2024 18:39:44

Lowest Band Edge / Full RB

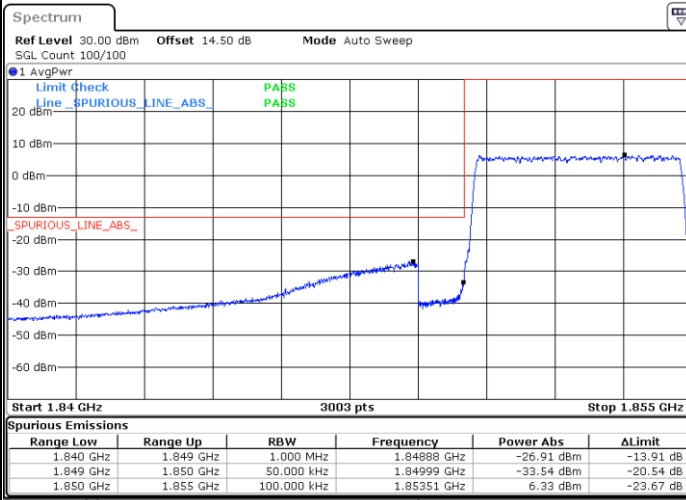

Date: 10.SEP.2024 18:34:56

Highest Band Edge / Full RB

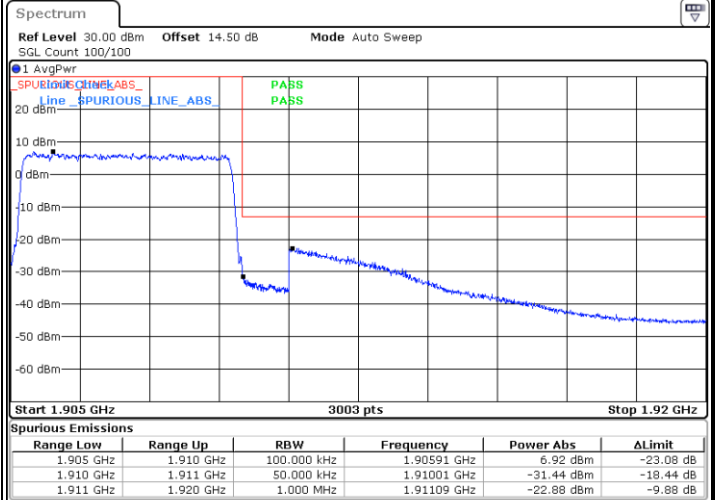

Date: 10.SEP.2024 18:42:00



LTE Band 2 / 5MHz / 64QAM

Lowest Band Edge / 1 RB

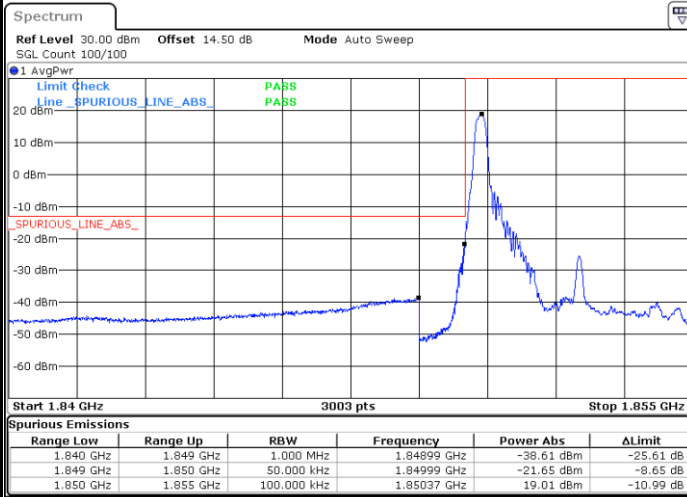

Highest Band Edge / 1 RB

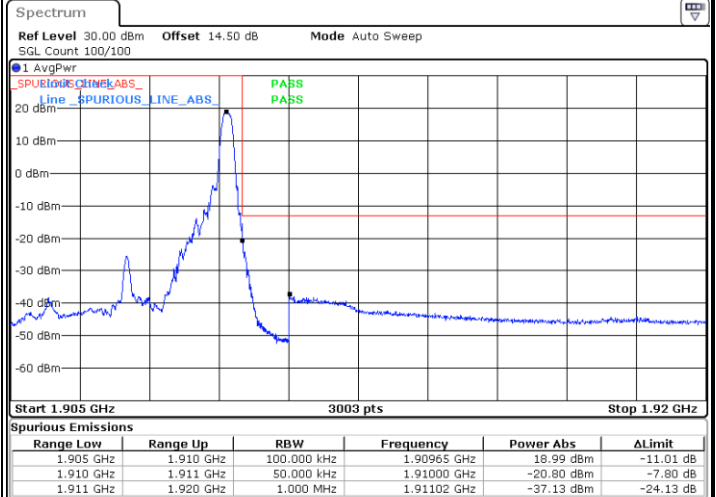

Lowest Band Edge / Full RB

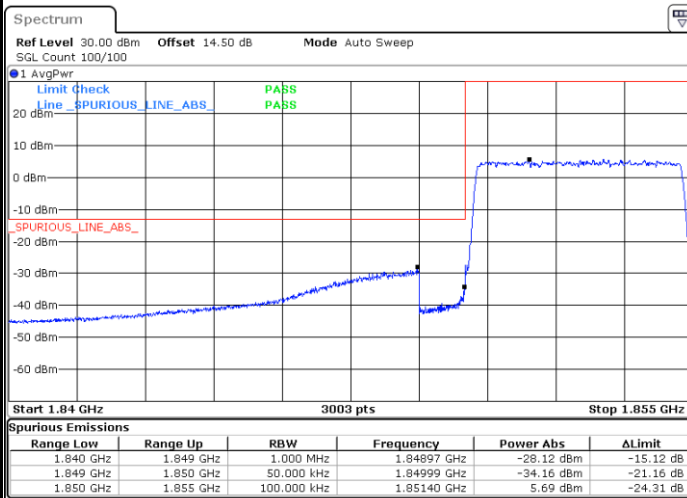

Highest Band Edge / Full RB

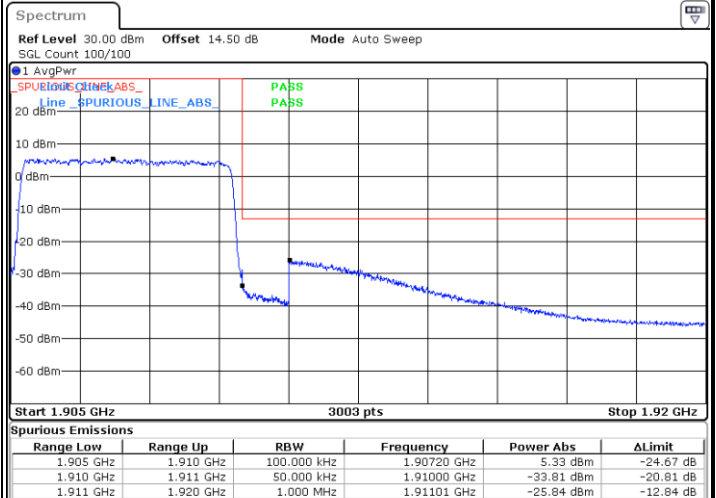



LTE Band 2 / 10MHz / QPSK

Lowest Band Edge / 1RB

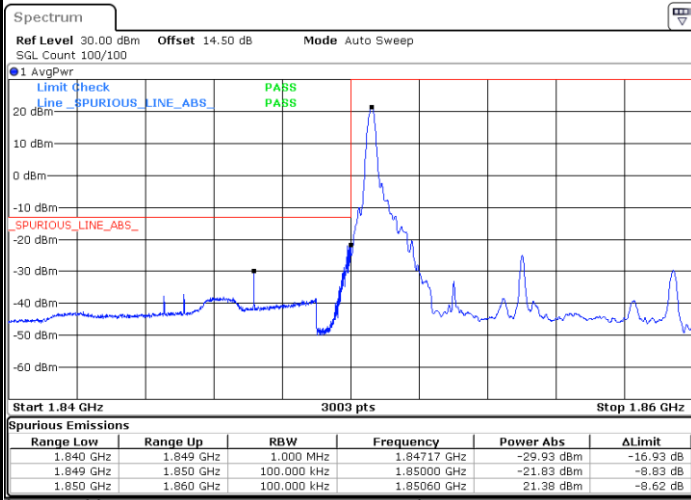

Date: 10.SEP.2024 18:45:28

Highest Band Edge / 1RB

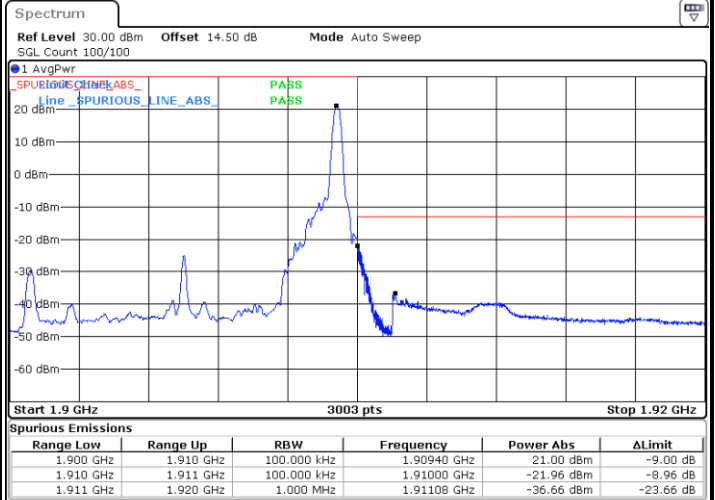

Date: 10.SEP.2024 18:53:46

Lowest Band Edge / Full RB

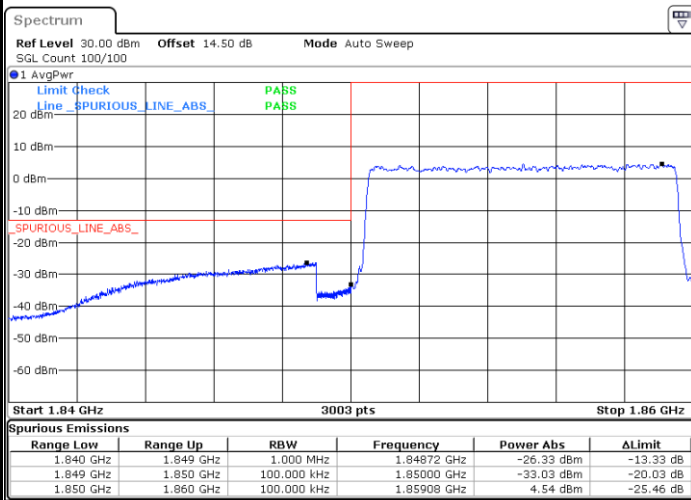

Date: 10.SEP.2024 18:47:43

Highest Band Edge / Full RB

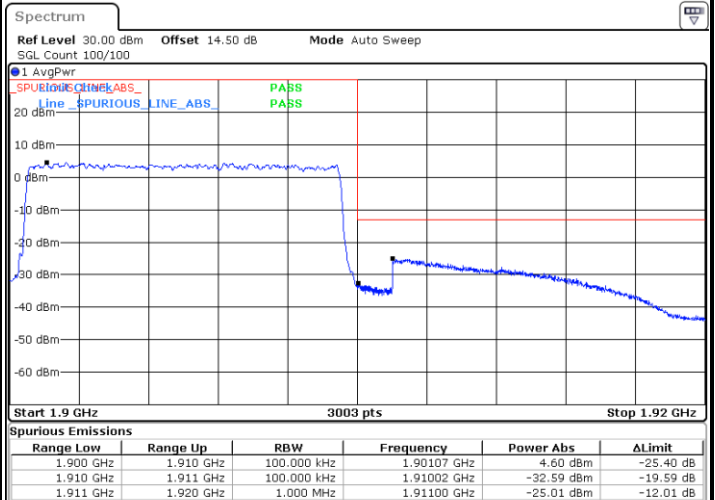

Date: 10.SEP.2024 17:58:01



LTE Band 2 / 10MHz / 16QAM

Lowest Band Edge / 1 RB

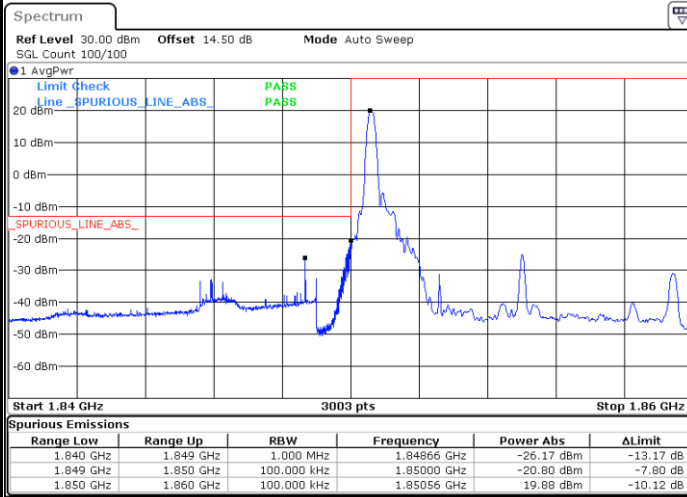

Date: 10.SEP.2024 18:46:13

Highest Band Edge / 1 RB

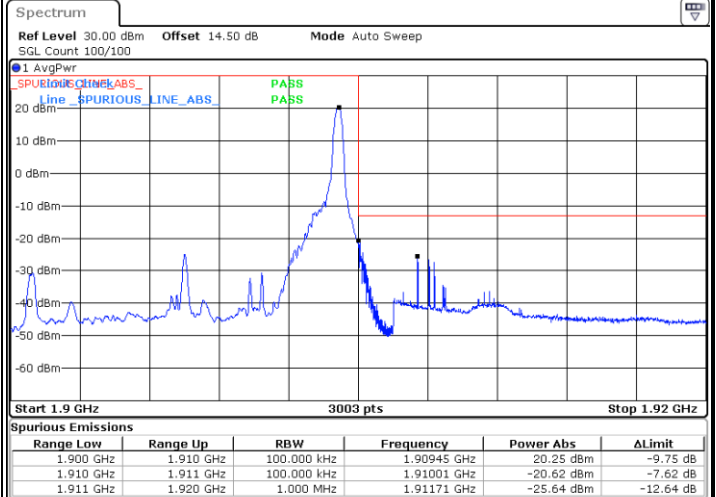

Date: 10.SEP.2024 18:54:31

Lowest Band Edge / Full RB

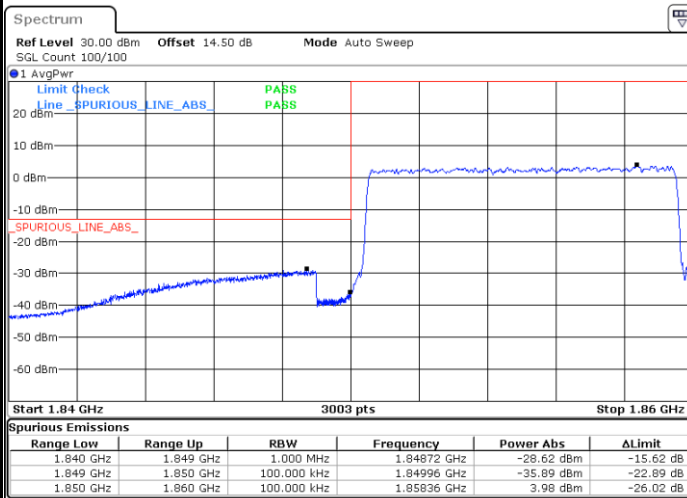

Date: 10.SEP.2024 18:48:28

Highest Band Edge / Full RB

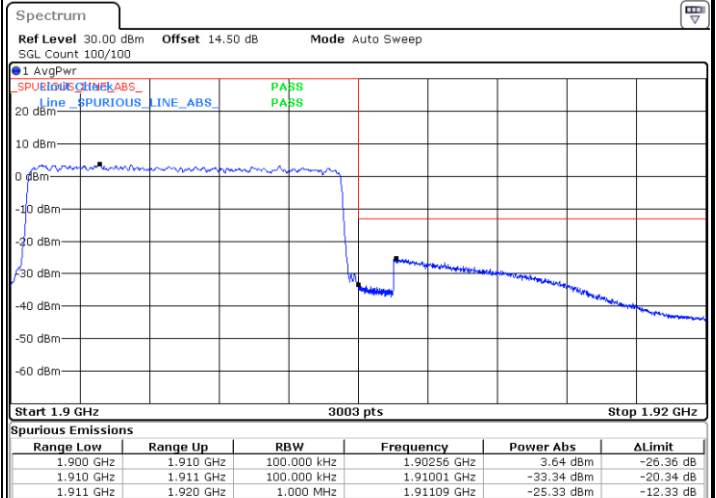

Date: 10.SEP.2024 18:56:46



LTE Band 2 / 10MHz / 64QAM

Lowest Band Edge / 1 RB

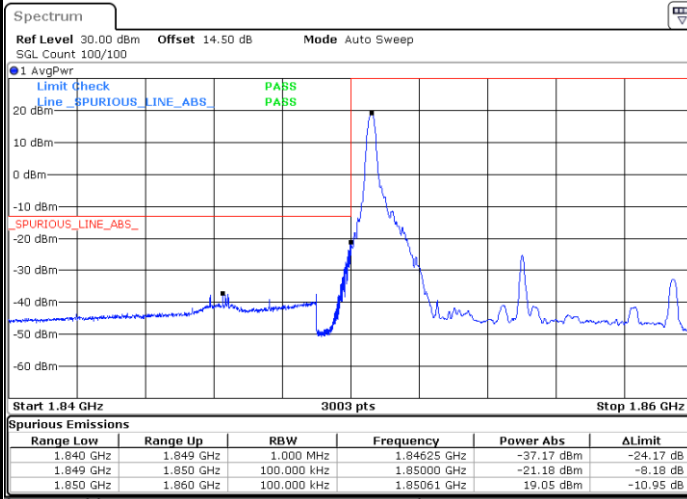

Date: 10.SEP.2024 18:46:58

Highest Band Edge / 1 RB

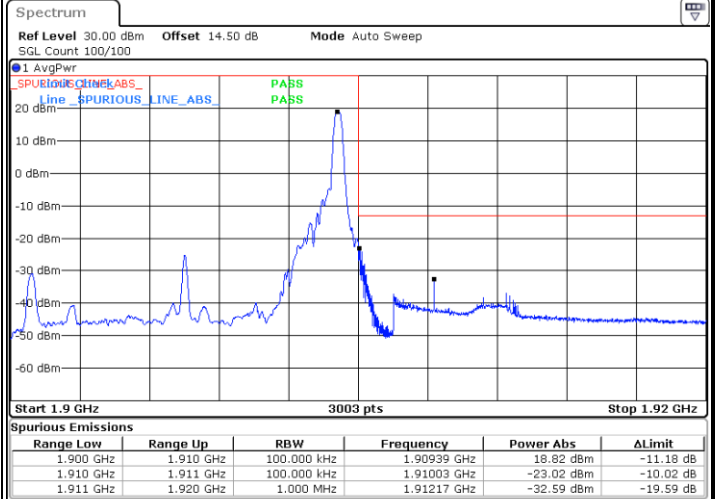

Date: 10.SEP.2024 18:55:16

Lowest Band Edge / Full RB

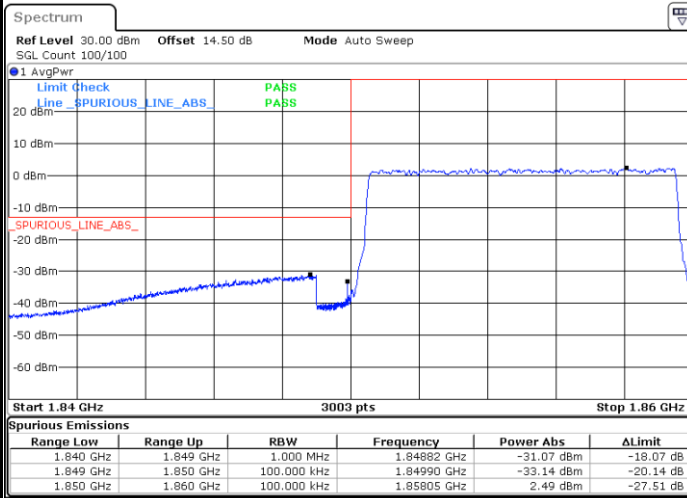

Date: 10.SEP.2024 18:49:13

Highest Band Edge / Full RB

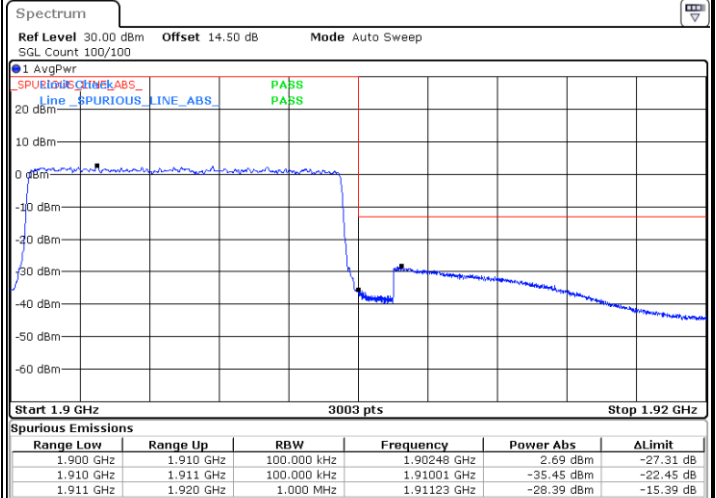

Date: 10.SEP.2024 18:57:32



LTE Band 2 / 15MHz / QPSK

Lowest Band Edge / 1RB

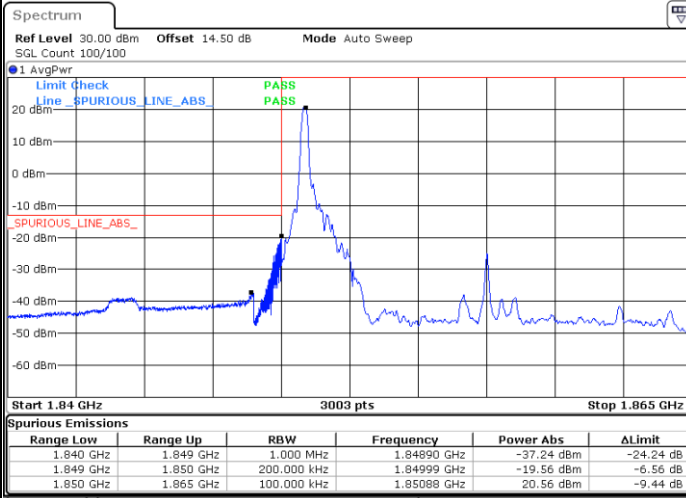

Date: 10.SEP.2024 19:00:14

Highest Band Edge / 1RB

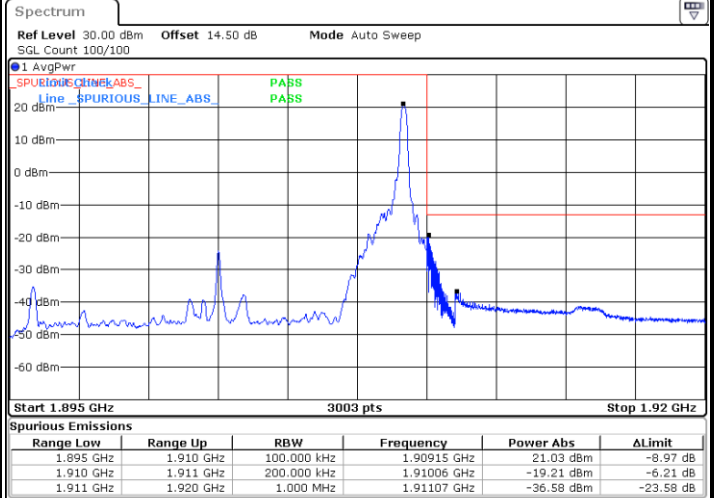

Date: 10.SEP.2024 19:08:33

Lowest Band Edge / Full RB

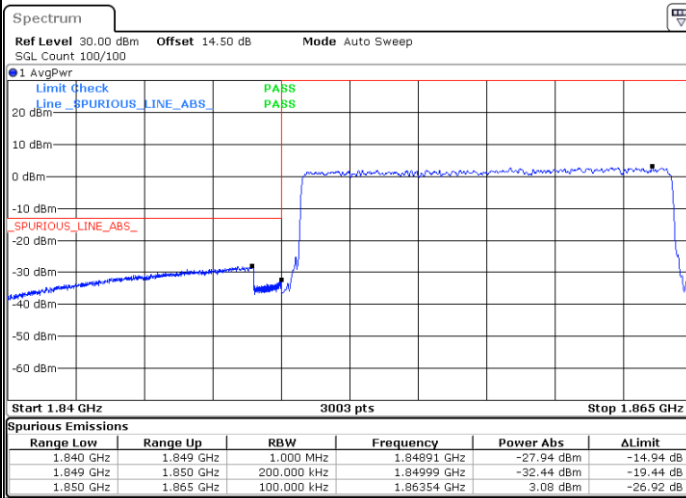

Date: 10.SEP.2024 19:02:30

Highest Band Edge / Full RB

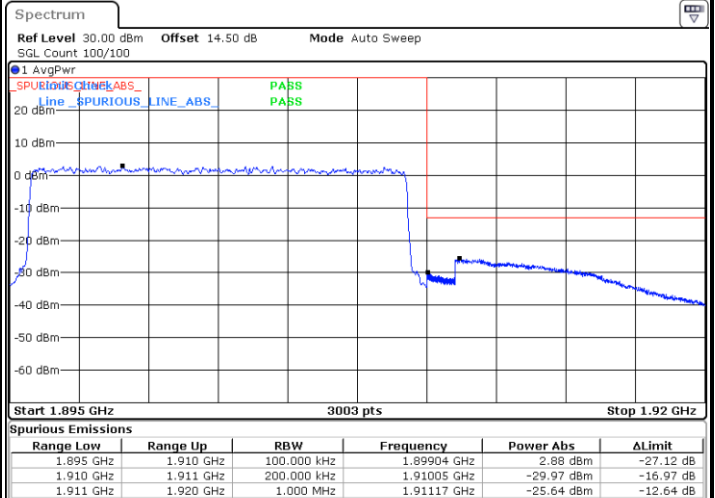

Date: 10.SEP.2024 19:10:48



LTE Band 2 / 15MHz / 16QAM

Lowest Band Edge / 1 RB

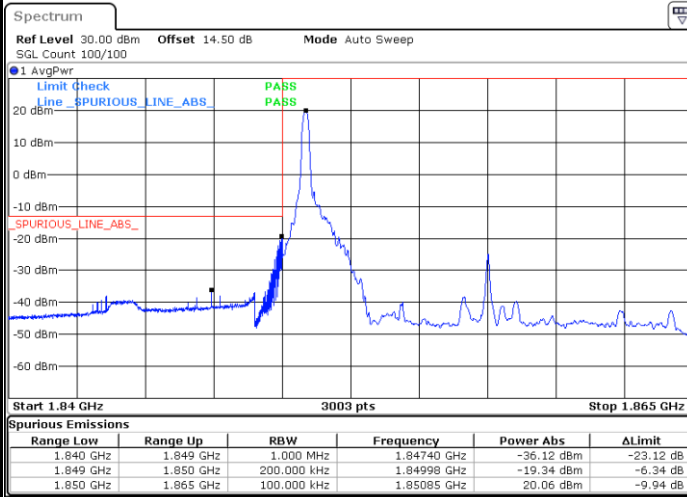

Date: 10.SEP.2024 19:00:59

Highest Band Edge / 1 RB

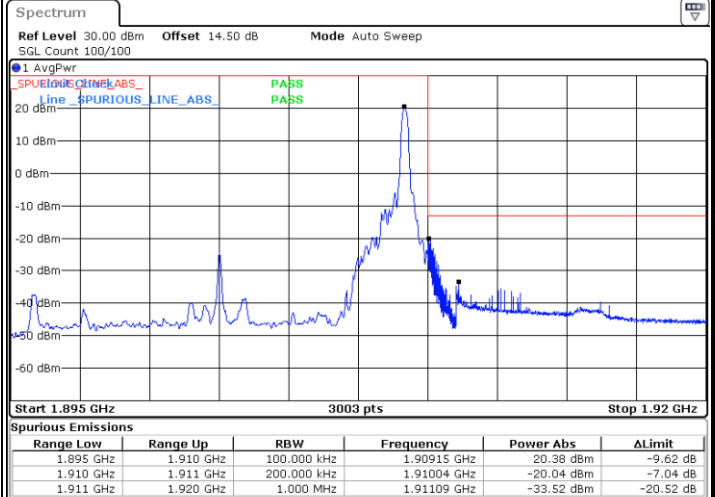

Date: 10.SEP.2024 19:09:18

Lowest Band Edge / Full RB

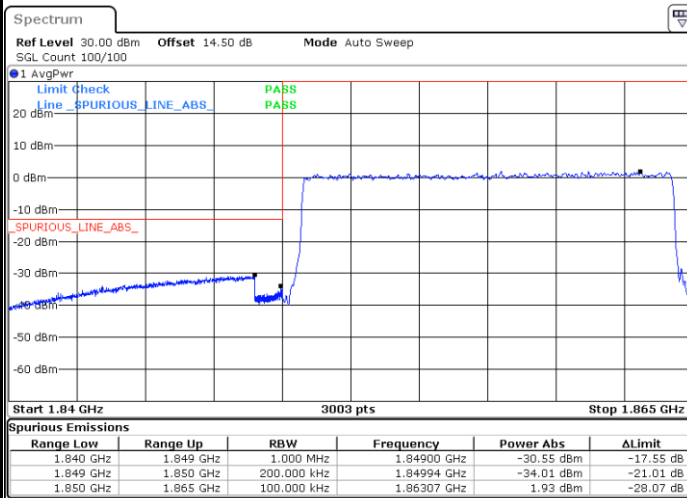

Date: 10.SEP.2024 19:03:15

Highest Band Edge / Full RB

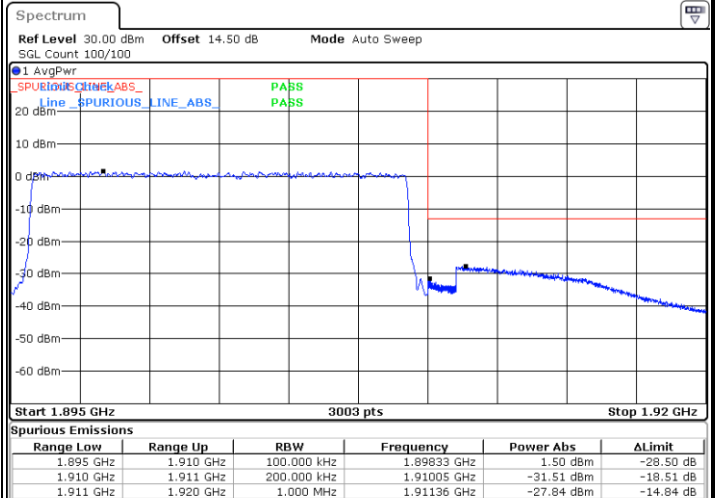

Date: 10.SEP.2024 19:11:34



LTE Band 2 / 15MHz / 64QAM

Lowest Band Edge / 1 RB

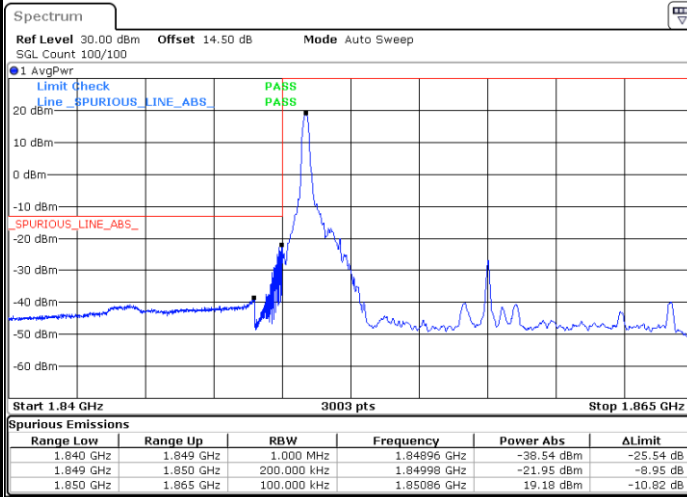

Date: 10.SEP.2024 19:01:45

Highest Band Edge / 1 RB

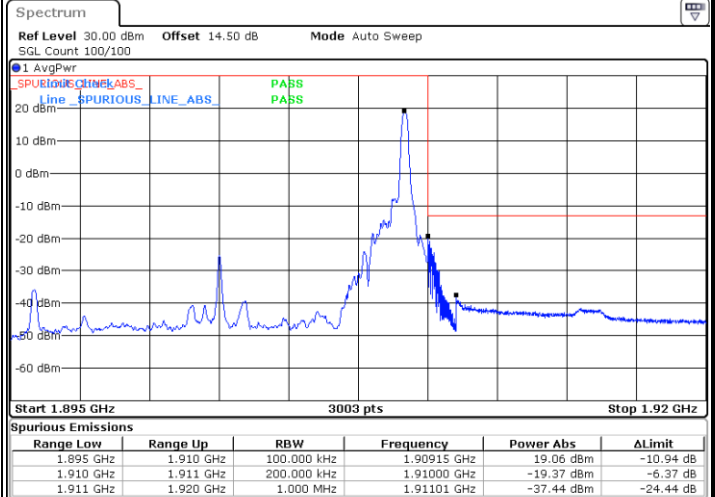

Date: 10.SEP.2024 19:10:03

Lowest Band Edge / Full RB

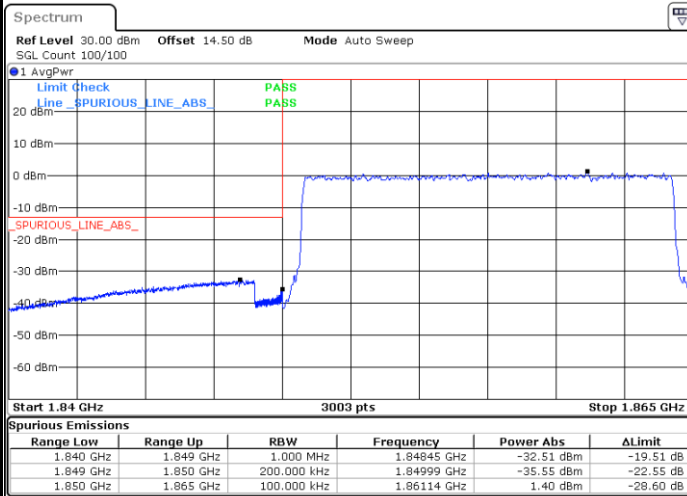

Date: 10.SEP.2024 19:04:00

Highest Band Edge / Full RB



Date: 10.SEP.2024 19:12:19



LTE Band 2 / 20MHz / QPSK

Lowest Band Edge / 1RB

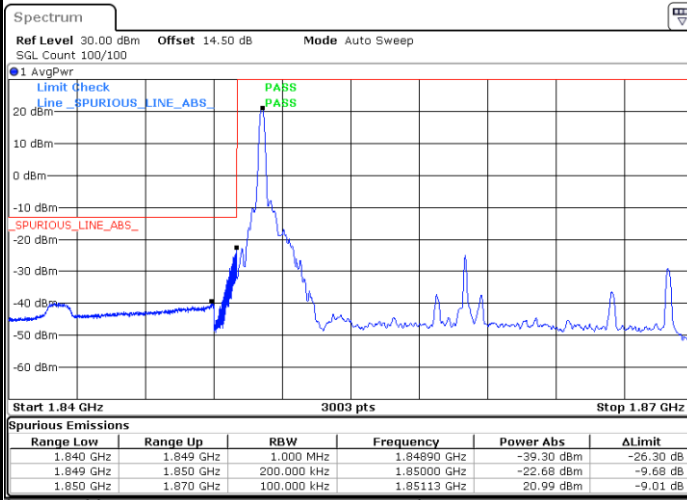

Date: 10.SEP.2024 19:15:02

Highest Band Edge / 1RB

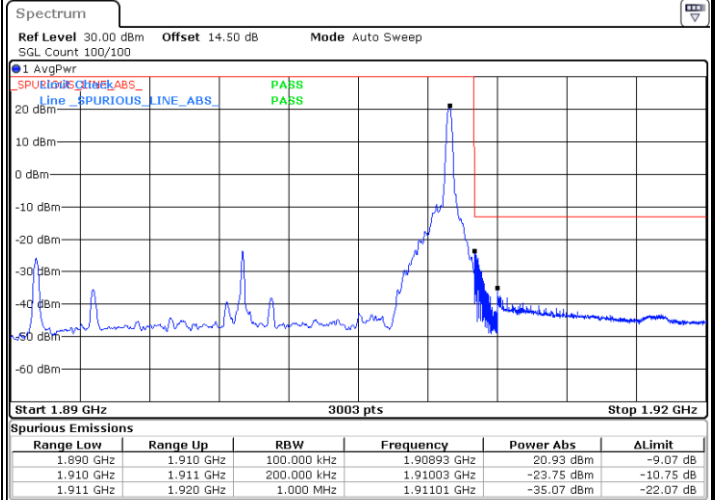

Date: 10.SEP.2024 19:24:41

Lowest Band Edge / Full RB

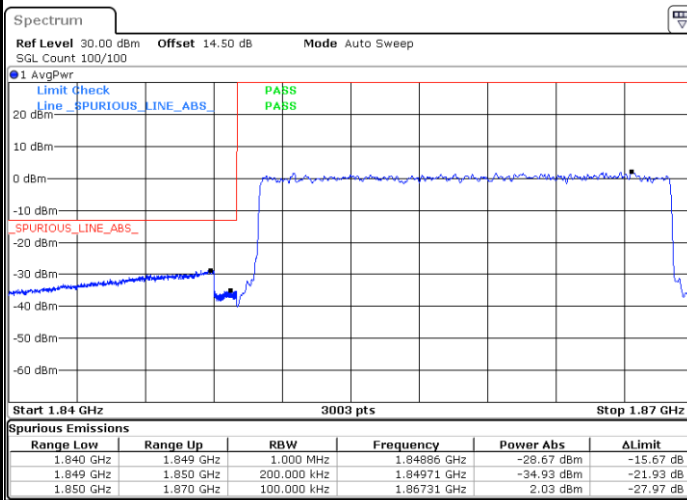

Date: 10.SEP.2024 19:17:17

Highest Band Edge / Full RB

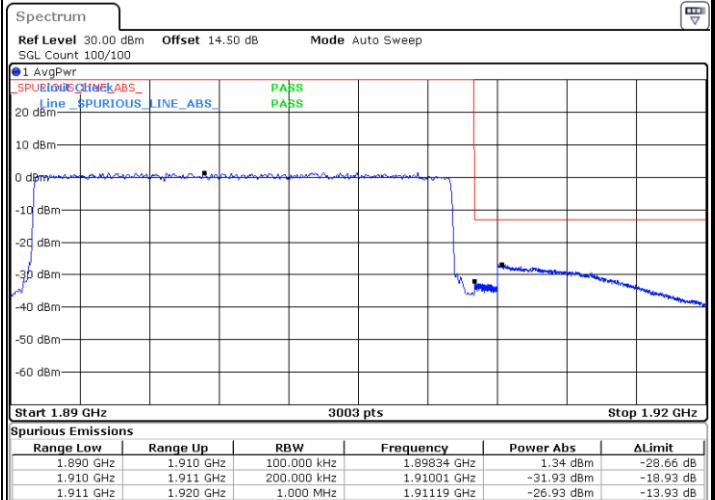

Date: 10.SEP.2024 19:26:56



LTE Band 2 / 20MHz / 16QAM

Lowest Band Edge / 1 RB

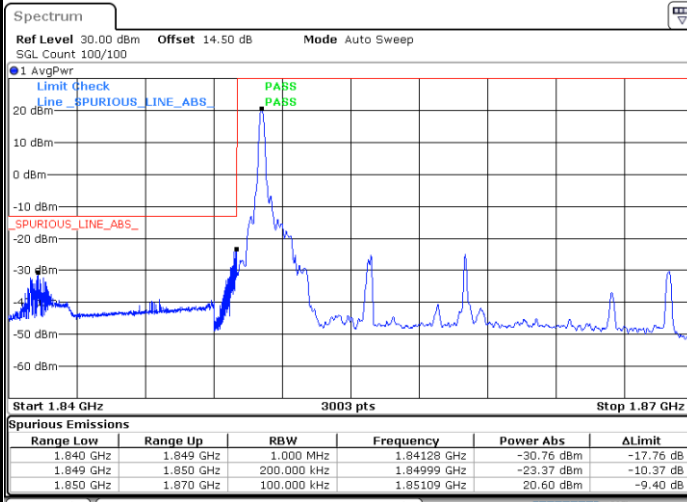

Date: 10.SEP.2024 19:15:47

Highest Band Edge / 1 RB

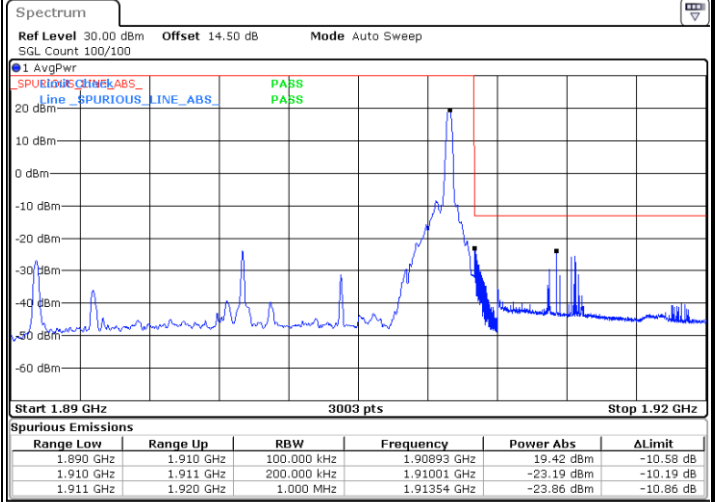

Date: 10.SEP.2024 19:25:26

Lowest Band Edge / Full RB

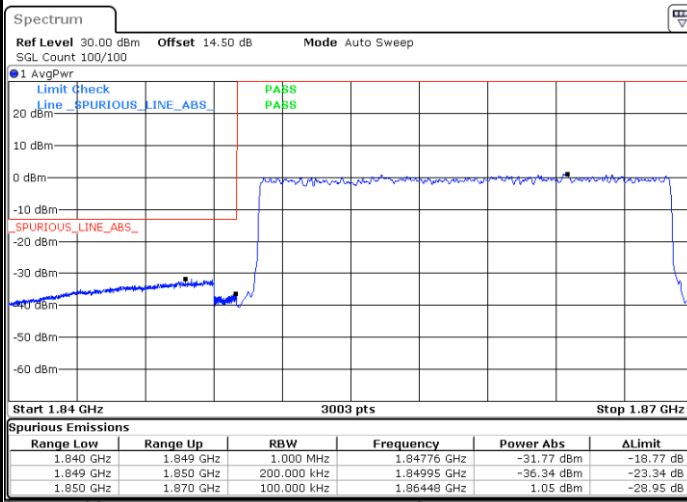

Date: 10.SEP.2024 19:18:03

Highest Band Edge / Full RB

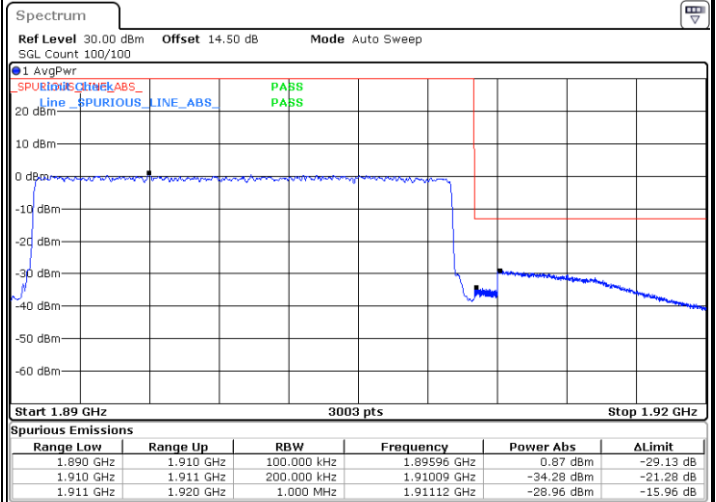

Date: 10.SEP.2024 19:27:42