



FCC RF Test Report

APPLICANT : Motorola Mobility LLC
EQUIPMENT : Mobile Phone
BRAND NAME : Motorola
MODEL NAME : XT2433-2, XT2433-1
FCC ID : IHDT56AS4
STANDARD : 47 CFR Part 2, 22(H), 24(E), 27(L)
CLASSIFICATION : PCS Licensed Transmitter Held to Ear (PCE)
TEST DATE(S) : Apr. 28, 2024 ~ Jun. 25, 2024

We, Sporton International Inc. (Kunshan), would like to declare that the tested sample has been evaluated in accordance with the procedures given in ANSI C63.26-2015 and shown compliance with the applicable technical standards.

This report contains data that were produced under subcontract by Sporton International Inc. (Shenzhen)

The test results in this report apply exclusively to the tested model / sample. Without written approval of Sporton International Inc. (Kunshan), the test report shall not be reproduced except in full.

Jason Jia

Approved by: Jason Jia



Sporton International Inc. (Kunshan)

**No. 1098, Pengxi North Road, Kunshan Economic Development Zone Jiangsu Province 215300
People's Republic of China**



TABLE OF CONTENTS

REVISION HISTORY... 3
SUMMARY OF TEST RESULT ... 4
1 GENERAL DESCRIPTION ... 5
1.1 Applicant ... 5
1.2 Manufacturer ... 5
1.3 Product Feature of Equipment Under Test ... 5
1.4 Product Specification of Equipment Under Test ... 6
1.5 Modification of EUT ... 6
1.6 Maximum ERP/EIRP Power and Emission Designator ... 7
1.7 Testing Location ... 9
1.8 Test Software ... 9
1.9 Applicable Standards ... 10
1.10 Specification of Accessory ... 10
2 TEST CONFIGURATION OF EQUIPMENT UNDER TEST ... 11
2.1 Test Mode ... 11
2.2 Connection Diagram of Test System ... 12
2.3 Support Unit used in test configuration and system ... 12
2.4 Measurement Results Explanation Example ... 12
2.5 Frequency List of Low/Middle/High Channels ... 13
3 CONDUCTED TEST ITEMS ... 16
3.1 Measuring Instruments ... 16
3.2 Test Setup ... 16
3.3 Test Result of Conducted Test ... 16
3.4 Conducted Output Power and ERP/EIRP ... 17
3.5 Peak-to-Average Ratio ... 18
3.6 Occupied Bandwidth ... 19
3.7 Conducted Band Edge ... 20
3.8 Conducted Spurious Emission ... 22
3.9 Frequency Stability ... 23
4 RADIATED TEST ITEMS ... 24
4.1 Measuring Instruments ... 24
4.2 Test Setup ... 24
4.3 Test Result of Radiated Test ... 25
4.4 Radiated Spurious Emission ... 26
5 LIST OF MEASURING EQUIPMENT ... 27
6 MEASUREMENT UNCERTAINTY ... 28
APPENDIX A. TEST RESULTS OF CONDUCTED TEST
APPENDIX B. TEST RESULTS OF RADIATED TEST
APPENDIX C. TEST SETUP PHOTOGRAPHS



REVISION HISTORY

REPORT NO.	VERSION	DESCRIPTION	ISSUED DATE
FG422904B	Rev. 01	Initial issue of report	Jul. 26, 2024



SUMMARY OF TEST RESULT

Report Section	FCC Rule	Description	Limit	Result	Remark
3.4	§2.1046	Conducted Output Power	-	PASS	-
	§22.913(a)(5)	Effective Radiated Power (Band 5) (Band 26)	ERP < 7 Watt		-
	§24.232(c)	Equivalent Isotropic Radiated Power (Band 2) (Band 25)	EIRP < 2Watt		-
	§27.50(d)(4)	Equivalent Isotropic Radiated Power (Band 4) (Band 66)	EIRP < 1Watt		-
3.5	§24.232(d)	Peak-to-Average Ratio	<13 dB	PASS	-
3.6	§2.1049	Occupied Bandwidth	-	PASS	-
3.7	§2.1051 §22.917(a) §24.238(a) §27.53(h)	Conducted Band Edge Measurement (Band 2) (Band 4) (Band 5) (Band 25) (Band 26) (Band 66)	< 43+10log10(P[Watts])	PASS	-
3.8	§2.1051 §22.917(a) §24.238(a) §27.53(h)	Conducted Spurious Emission (Band 2) (Band 4) (Band 5) (Band 25) (Band 26) (Band 66)	< 43+10log10(P[Watts])	PASS	-
3.9	§2.1055 §22.355	Frequency Stability Temperature & Voltage	< 2.5 ppm for Part 22	PASS	-
	§2.1055 §24.235 §27.54		Within Authorized Band		
4.4	§2.1053 §22.917(a) §24.238(a) §27.53(h)	Radiated Spurious Emission (Band 2) (Band 4) (Band 5) (Band 25) (Band 26) (Band 66)	< 43+10log ₁₀ (P[Watts])	PASS	Under limit 34.07 dB at 2489.25 MHz

Conformity Assessment Condition:

- The test results (PASS/FAIL) with all measurement uncertainty excluded are presented against the regulation limits or in accordance with the requirements stipulated by the applicant/manufacturer who shall bear all the risks of non-compliance that may potentially occur if measurement uncertainty is taken into account.
- The measurement uncertainty please refer to each test result in the section "Measurement Uncertainty"

Disclaimer:

The product specifications of the EUT presented in the test report that may affect the test assessments are declared by the manufacturer who shall take full responsibility for the authenticity.



1 General Description

1.1 Applicant

Motorola Mobility LLC
222 W, Merchandise Mart Plaza, Chicago, IL60654 USA

1.2 Manufacturer

Motorola Mobility LLC
222 W, Merchandise Mart Plaza, Chicago, IL60654 USA

1.3 Product Feature of Equipment Under Test

Product Feature	
Equipment	Mobile Phone
Brand Name	Motorola
Model Name	XT2433-2, XT2433-1
FCC ID	IHDT56AS4
IMEI Code	Conducted: 356304130045015/356304130015023 Radiation: 356304130083377/356304130123181
HW Version	DVT2
SW Version	UOA34.101
EUT Stage	Identical Prototype

Remark:

1. The above EUT's information was declared by manufacturer. Please refer to the specifications or user's manual for more detailed description.
2. The two models are only different for market segment, all the others are same.



1.4 Product Specification of Equipment Under Test

Standards-related Product Specification	
Tx Frequency	LTE Band 2 : 1850 MHz ~ 1910 MHz LTE Band 4 : 1710 MHz ~ 1755 MHz LTE Band 5 : 824 MHz ~ 849 MHz LTE Band 25 : 1850 MHz ~ 1915 MHz LTE Band 26 : 824 MHz ~ 849 MHz LTE Band 66 : 1710 MHz ~ 1780 MHz
Rx Frequency	LTE Band 2 : 1930 MHz ~ 1990 MHz LTE Band 4 : 2110 MHz ~ 2155 MHz LTE Band 5 : 869 MHz ~ 894 MHz LTE Band 25 : 1930 MHz ~ 1995 MHz LTE Band 26 : 869 MHz ~ 894 MHz LTE Band 66 : 2110 MHz~ 2180 MHz
Bandwidth	LTE Band 2 : 1.4MHz / 3MHz / 5MHz / 10MHz / 15MHz / 20MHz LTE Band 4 : 1.4MHz / 3MHz / 5MHz / 10MHz / 15MHz / 20MHz LTE Band 5 : 1.4MHz / 3MHz / 5MHz / 10MHz LTE Band 25 : 1.4MHz / 3MHz / 5MHz / 10MHz / 15MHz / 20MHz LTE Band 26 : 1.4MHz / 3MHz / 5MHz / 10MHz / 15MHz LTE Band 66 : 1.4MHz / 3MHz / 5MHz / 10MHz / 15MHz / 20MHz
Maximum Output Power to Antenna	<ANT 0> LTE Band 2 : 23.05 dBm LTE Band 4 : 22.91 dBm LTE Band 5 : 22.83 dBm LTE Band 25 : 23.13 dBm LTE Band 26 : 22.94 dBm LTE Band 66 : 22.99 dBm <ANT 4> LTE Band 2 : 20.59 dBm LTE Band 4 : 20.73 dBm LTE Band 5 : 20.63 dBm LTE Band 25 : 20.79 dBm LTE Band 66 : 20.89 dBm
Antenna Gain	<ANT0> LTE Band 2/25 : -3.1 dBi LTE Band 4/66 : -2.0 dBi LTE Band 5/26 : -5.3 dBi <ANT4> LTE Band 2/25 : -5.3 dBi LTE Band 4/66 : -5.3 dBi LTE Band 5 : -7.4 dBi
Type of Modulation	QPSK / 16QAM / 64QAM / 256QAM

Note: The maximum ERP/EIRP is calculated from max output power and max antenna gain, so only the maximum ERP/EIRP of Antenna 0 for LTE Band 2/4/5/25/26/66 are shown in the report.

1.5 Modification of EUT

No modifications are made to the EUT during all test items.



1.6 Maximum ERP/EIRP Power and Emission Designator

LTE Band 2		QPSK		16QAM/64QAM/256QAM	
BW (MHz)	Frequency Range (MHz)	Maximum EIRP(W)	Emission Designator (99%OBW)	Maximum EIRP(W)	Emission Designator (99%OBW)
1.4	1850.7 ~ 1909.3	0.0962	1M08G7D	0.0746	1M09W7D
3	1851.5 ~ 1908.5	0.0962	2M70G7D	0.0769	2M69W7D
5	1852.5 ~ 1907.5	0.0966	4M50G7D	0.0771	4M49W7D
10	1855.0 ~ 1905.0	0.0968	9M05G7D	0.0769	9M05W7D
15	1857.5 ~ 1902.5	0.0975	13M5G7D	0.0769	13M4W7D
20	1860.0 ~ 1900.0	0.0989	17M9G7D	0.0776	17M9W7D
LTE Band 25		QPSK		16QAM/64QAM/256QAM	
BW (MHz)	Frequency Range (MHz)	Maximum EIRP(W)	Emission Designator (99%OBW)	Maximum EIRP(W)	Emission Designator (99%OBW)
1.4	1850.7 ~ 1914.3	0.0975	1M08G7D	0.0789	1M09W7D
3	1851.5 ~ 1913.5	0.0986	2M70G7D	0.0800	2M69W7D
5	1852.5 ~ 1912.5	0.0998	4M50G7D	0.0802	4M49W7D
10	1855.0 ~ 1910.0	0.0993	9M05G7D	0.0802	9M05W7D
15	1857.5 ~ 1907.5	0.0977	13M5G7D	0.0787	13M4W7D
20	1860.0 ~ 1905.0	0.1007	17M9G7D	0.0805	17M9W7D
LTE Band 4		QPSK		16QAM/64QAM/256QAM	
BW (MHz)	Frequency Range (MHz)	Maximum EIRP(W)	Emission Designator (99%OBW)	Maximum EIRP(W)	Emission Designator (99%OBW)
1.4	1710.7 ~ 1754.3	0.1164	1M08G7D	0.0885	1M08W7D
3	1711.5 ~ 1753.5	0.1180	2M70G7D	0.0973	2M71W7D
5	1712.5 ~ 1752.5	0.1194	4M49G7D	0.0973	4M50W7D
10	1715.0 ~ 1750.0	0.1219	9M01G7D	0.0975	9M03W7D
15	1717.5 ~ 1747.5	0.1194	13M4G7D	0.0946	13M4W7D
20	1720.0 ~ 1745.0	0.1233	17M9G7D	0.0984	17M9W7D



LTE Band 5		QPSK		16QAM/64QAM/256QAM	
BW (MHz)	Frequency Range (MHz)	Maximum ERP(W)	Emission Designator (99%OBW)	Maximum ERP(W)	Emission Designator (99%OBW)
1.4	824.7 ~ 848.3	0.0336	1M08G7D	0.0273	1M08W7D
3	825.5 ~ 847.5	0.0338	2M72G7D	0.0271	2M70W7D
5	826.5 ~ 846.5	0.0333	4M49G7D	0.0271	4M48W7D
10	829.0 ~ 844.0	0.0345	9M05G7D	0.0274	9M03W7D
LTE Band 26		QPSK		16QAM/64QAM/256QAM	
BW (MHz)	Frequency Range (MHz)	Maximum ERP(W)	Emission Designator (99%OBW)	Maximum ERP(W)	Emission Designator (99%OBW)
1.4	824.7 ~ 848.3	0.0344	1M08G7D	0.0273	1M08W7D
3	825.5 ~ 847.5	0.0351	2M72G7D	0.0272	2M70W7D
5	826.5 ~ 846.5	0.0343	4M49G7D	0.0269	4M48W7D
10	829.0 ~ 844.0	0.0348	9M05G7D	0.0272	9M03W7D
15	831.5 ~ 841.5	0.0354	13M3G7D	0.0280	13M4W7D
CH26790	824.0	0.0334	13M4G7D	0.0261	13M5W7D
LTE Band 66		QPSK		16QAM/64QAM/256QAM	
BW (MHz)	Frequency Range (MHz)	Maximum EIRP(W)	Emission Designator (99%OBW)	Maximum EIRP(W)	Emission Designator (99%OBW)
1.4	1710.7 ~ 1779.3	0.1233	1M08G7D	0.0975	1M08W7D
3	1711.5 ~ 1778.5	0.1239	2M70G7D	0.1005	2M71W7D
5	1712.5 ~ 1777.5	0.1216	4M49G7D	0.0971	4M50W7D
10	1715.0 ~ 1775.0	0.1227	9M01G7D	0.0998	9M03W7D
15	1717.5 ~ 1772.5	0.1242	13M4G7D	0.0995	13M4W7D
20	1720.0 ~ 1770.0	0.1256	17M9G7D	0.0998	17M9W7D

Note:

1. LTE Band 26 overlaps the entire frequency range of LTE Band 5. Therefore, the test results provided in this report covers Band 26 as well as Band 5.
2. LTE Band 66 overlaps the entire frequency range of LTE Band 4. Therefore, the test results provided in this report covers Band 66 as well as Band 4.
3. LTE Band 25 overlaps the entire frequency range of LTE Band 2. Therefore, the test results provided in this report covers Band 25 as well as Band 2.



1.7 Testing Location

Sporton International Inc. (Kunshan) is accredited to ISO/IEC 17025:2017 by American Association for Laboratory Accreditation with Certificate Number 5145.02.

Test Firm	Sporton International Inc. (Kunshan)		
Test Site Location	No. 1098, Pengxi North Road, Kunshan Economic Development Zone Jiangsu Province 215300 People's Republic of China TEL : +86-512-57900158		
Test Site No.	Sporton Site No.	FCC Designation No.	FCC Test Firm Registration No.
	TH01-KS	CN1257	314309

Sporton International Inc. (ShenZhen) is accredited to ISO/IEC 17025:2017 by American Association for Laboratory Accreditation with Certificate Number 5145.01.

Test Firm	Sporton International Inc. (ShenZhen)		
Test Site Location	101, 1st Floor, Block B, Building 1, No. 2, Tengfeng 4th Road, Fenghuang Community, Fuyong Street, Baoan District, Shenzhen City, Guangdong Province 518103 People's Republic of China TEL: +86-755-86066985		
Test Site No.	Sporton Site No.	FCC Designation No.	FCC Test Firm Registration No.
	03CH03-SZ	CN1256	421272

1.8 Test Software

Item	Site	Manufacture	Name	Version
1.	TH01-KS	SPORTON	FCC LTE_Ver2.0 Auto_china_210503	2.0
2.	03CH03-SZ	AUDIX	E3	6.2009-8-24



1.9 Applicable Standards

According to the specifications of the manufacturer, the EUT must comply with the requirements of the following standards:

- 47 CFR Part 2, 22(H), 24(E), 27(L)
- ANSI C63.26-2015
- FCC KDB 971168 D01 Power Meas License Digital Systems v03r01
- FCC KDB 412172 D01 Determining ERP and EIRP v01r01

Remark:

1. All test items were verified and recorded according to the standards and without any deviation during the test.
2. This EUT has also been tested and complied with the requirements of FCC Part 15, Subpart B, recorded in a separate test report.

1.10 Specification of Accessory

Specification of Accessory				
AC Adapter 1(US)	Brand Name	Motorola(AOHAI)	Model Name	MC-201L
AC Adapter 1(EU)	Brand Name	Motorola(AOHAI)	Model Name	MC-202L
AC Adapter 1(UK)	Brand Name	Motorola(AOHAI)	Model Name	MC-203L
AC Adapter 1(IN)	Brand Name	Motorola(AOHAI)	Model Name	MC-204
AC Adapter 1(AU)	Brand Name	Motorola(AOHAI)	Model Name	MC-205L
AC Adapter 1(AR)	Brand Name	Motorola(AOHAI)	Model Name	MC-206L
AC Adapter 2(US)	Brand Name	Motorola(Salcomp)	Model Name	MC-201L
AC Adapter 2(EU)	Brand Name	Motorola(Salcomp)	Model Name	MC-202L
AC Adapter 2(UK)	Brand Name	Motorola(Salcomp)	Model Name	MC-203L
AC Adapter 2(AU)	Brand Name	Motorola(Salcomp)	Model Name	MC-205L
AC Adapter 2(AR)	Brand Name	Motorola(Salcomp)	Model Name	MC-206L
AC Adapter 2(BR)	Brand Name	Motorola(Salcomp)	Model Name	MC-207L
AC Adapter 2(Chile)	Brand Name	Motorola(Salcomp)	Model Name	MC-209L
AC Adapter 3(US)	Brand Name	Motorola(Chenyang)	Model Name	MC-201L
AC Adapter 3(EU)	Brand Name	Motorola(Chenyang)	Model Name	MC-202L
AC Adapter 3(AR)	Brand Name	Motorola(Chenyang)	Model Name	MC-206L
AC Adapter 3(BR)	Brand Name	Motorola(Chenyang)	Model Name	MC-207L
AC Adapter 4(BR)	Brand Name	Motorola(Cliptech)	Model Name	MC-207L
AC Adapter 5(IN)	Brand Name	Motorola(XIHI)	Model Name	MC-204
Battery 1	Brand Name	Motorola(ATL)	Model Name	QG50
Battery 2	Brand Name	Motorola(Sunwoda)	Model Name	QG50
Battery 3	Brand Name	Motorola(JIADE)	Model Name	QG50
USB Cable 1	Brand Name	Saibao	Model Name	SZN-A026A
USB Cable 2	Brand Name	Juwei	Model Name	JWUB1606-ZN01H



2 Test Configuration of Equipment Under Test

2.1 Test Mode

Antenna port conducted and radiated test items listed below are performed according to KDB 971168 D01 Power Meas License Digital Systems v03r01 with maximum output power.

Radiated measurements are performed by rotating the EUT in three different orthogonal test planes to find the maximum emission. (X Plane)

Test Items	Band	Bandwidth (MHz)						Modulation			RB #			Test Channel				
		1.4	3	5	10	15	20	QPSK	16 QAM	64 QAM	256 QAM	1	Half	Full	L	M	H	
Max. Output Power	2	v	v	v	v	v	v	v	v	v	v	v		v	v	v	v	
	4	v	v	v	v	v	v	v	v	v	v	v		v	v	v	v	
	5	v	v	v	v	-	-	v	v	v	v	v		v	v	v	v	
	25	v	v	v	v	v	v	v	v	v	v	v		v	v	v	v	
	26	v	v	v	v	v	-	v	v	v	v	v		v	v	v	v	
	66	v	v	v	v	v	v	v	v	v	v	v		v	v	v	v	
Peak-to-Average Ratio	25						v	v	v	v	v			v		v		
	26				v		-	v	v	v	v			v		v		
	66						v	v	v	v	v			v		v		
26dB and 99% Bandwidth	25	v	v	v	v	v	v	v	v					v		v		
	26	v	v	v	v	v	-	v	v					v		v		
	66	v	v	v	v	v	v	v	v					v		v		
Conducted Band Edge	25	v	v	v	v	v	v	v	v	v	v	v		v	v		v	
	26	v	v	v	v	v	-	v	v	v	v	v		v	v		v	
	66	v	v	v	v	v	v	v	v	v	v	v		v	v		v	
Conducted Spurious Emission	25	v	v	v	v	v	v	v						v		v	v	
	26	v	v	v	v	v	-	v						v		v	v	
	66	v	v	v	v	v	v	v						v		v	v	
Frequency Stability	25				v			v							v		v	
	26				v		-	v							v		v	
	66				v			v							v		v	
E.R.P / E.I.R.P	2	v	v	v	v	v	v	v	v	v	v	v		v	v	v	v	
	4	v	v	v	v	v	v	v	v	v	v	v		v	v	v	v	
	5	v	v	v	v	-	-	v	v	v	v	v		v	v	v	v	
	25	v	v	v	v	v	v	v	v	v	v	v		v	v	v	v	
	26	v	v	v	v	v	-	v	v	v	v	v		v	v	v	v	
	66	v	v	v	v	v	v	v	v	v	v	v		v	v	v	v	
Radiated Spurious Emission	25	Worst Case															v	
	26	Worst Case															v	
	66	Worst Case															v	
Note	<ol style="list-style-type: none"> The mark "v" means that this configuration is chosen for testing The mark "-" means that this bandwidth is not supported. The device is investigated from 30MHz to 10 times of fundamental signal for radiated spurious emission test under different RB size/offset and modulations in exploratory test. Subsequently, only the worst case emissions are reported. 																	

2.2 Connection Diagram of Test System

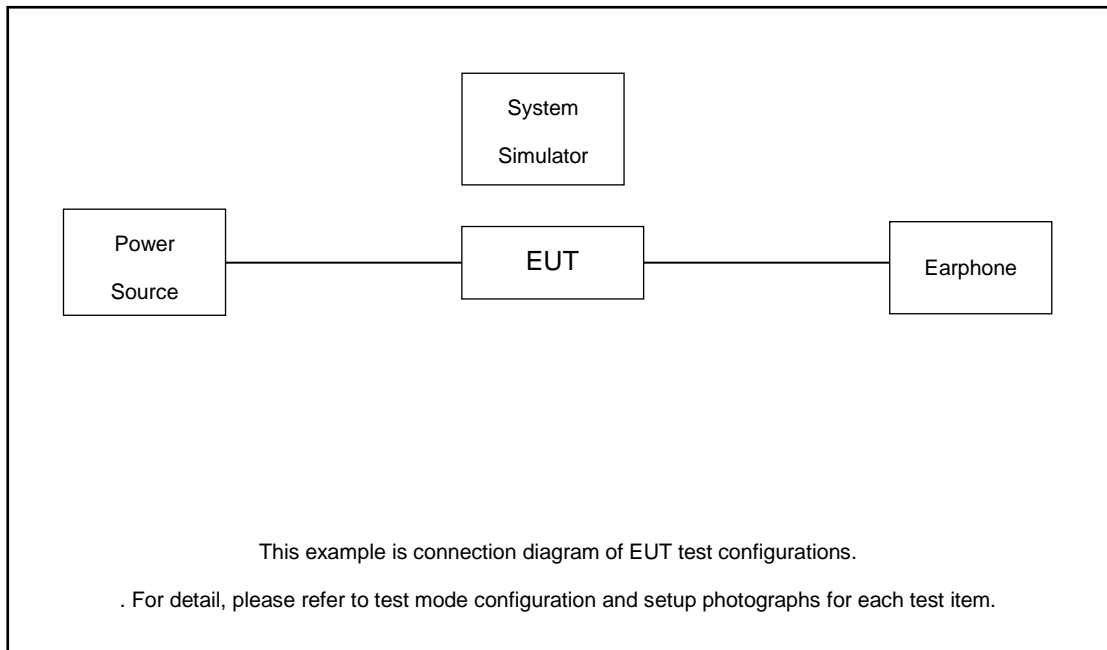

2.3 Support Unit used in test configuration and system

Item	Equipment	Trade Name	Model No.	FCC ID	Data Cable	Power Cord
1.	Power Supply	GWINSTEK	PSS-2002	N/A	N/A	Unshielded, 1.8 m
2.	LTE Base Station	Anritsu	MT8820C	N/A	N/A	Unshielded, 1.8 m
3.	Earphone	N/A	N/A	N/A	N/A	N/A

2.4 Measurement Results Explanation Example

For all conducted test items:

The offset level is set in the spectrum analyzer to compensate the RF cable loss between EUT conducted output port and spectrum analyzer. With the offset compensation, the spectrum analyzer reading level is exactly the EUT RF output level.

The spectrum analyzer offset is derived from RF cable loss.

Offset = RF cable loss.

Following shows an offset computation example with cable loss 5.6 dB.

Example :

$$\begin{aligned} \text{Offset(dB)} &= \text{RF cable loss(dB)}. \\ &= 5.6 \text{ (dB)} \end{aligned}$$



2.5 Frequency List of Low/Middle/High Channels

LTE Band 2 Channel and Frequency List				
BW [MHz]	Channel/Frequency(MHz)	Lowest	Middle	Highest
20	Channel	18700	18900	19100
	Frequency	1860	1880	1900
15	Channel	18675	18900	19125
	Frequency	1857.5	1880	1902.5
10	Channel	18650	18900	19150
	Frequency	1855	1880	1905
5	Channel	18625	18900	19175
	Frequency	1852.5	1880	1907.5
3	Channel	18615	18900	19185
	Frequency	1851.5	1880	1908.5
1.4	Channel	18607	18900	19193
	Frequency	1850.7	1880	1909.3

LTE Band 4 Channel and Frequency List				
BW [MHz]	Channel/Frequency(MHz)	Lowest	Middle	Highest
20	Channel	20050	20175	20300
	Frequency	1720	1732.5	1745
15	Channel	20025	20175	20325
	Frequency	1717.5	1732.5	1747.5
10	Channel	20000	20175	20350
	Frequency	1715	1732.5	1750
5	Channel	19975	20175	20375
	Frequency	1712.5	1732.5	1752.5
3	Channel	19965	20175	20385
	Frequency	1711.5	1732.5	1753.5
1.4	Channel	19957	20175	20393
	Frequency	1710.7	1732.5	1754.3



LTE Band 5 Channel and Frequency List				
BW [MHz]	Channel/Frequency(MHz)	Lowest	Middle	Highest
10	Channel	20450	20525	20600
	Frequency	829	836.5	844
5	Channel	20425	20525	20625
	Frequency	826.5	836.5	846.5
3	Channel	20415	20525	20635
	Frequency	825.5	836.5	847.5
1.4	Channel	20407	20525	20643
	Frequency	824.7	836.5	848.3

LTE Band 25 Channel and Frequency List				
BW [MHz]	Channel/Frequency(MHz)	Lowest	Middle	Highest
20	Channel	26140	26340	26590
	Frequency	1860	1880	1905
15	Channel	26115	26340	26615
	Frequency	1857.5	1880	1907.5
10	Channel	26090	26340	26640
	Frequency	1855	1880	1910
5	Channel	26065	26340	26665
	Frequency	1852.5	1880	1912.5
3	Channel	26055	26340	26675
	Frequency	1851.5	1880	1913.5
1.4	Channel	26047	26340	26683
	Frequency	1850.7	1880	1914.3



LTE Band 26 Channel and Frequency List				
BW [MHz]	Channel/Frequency(MHz)	Lowest	Middle	Highest
15	Channel	26865	26915	26965
	Frequency	831.5	836.5	841.5
10	Channel	26840	26915	26990
	Frequency	829	836.5	844
5	Channel	26815	26915	27015
	Frequency	826.5	836.5	846.5
3	Channel	26805	26915	27025
	Frequency	825.5	836.5	847.5
1.4	Channel	26797	26915	27033
	Frequency	824.7	836.5	848.3

LTE Band 66 Channel and Frequency List				
BW [MHz]	Channel/Frequency(MHz)	Lowest	Middle	Highest
20	Channel	132072	132322	132572
	Frequency	1720	1745	1770
15	Channel	132047	132322	132597
	Frequency	1717.5	1745	1772.5
10	Channel	132022	132322	132622
	Frequency	1715	1745	1775
5	Channel	131997	132322	132647
	Frequency	1712.5	1745	1777.5
3	Channel	131987	132322	132657
	Frequency	1711.5	1745	1778.5
1.4	Channel	131979	132322	132665
	Frequency	1710.7	1745	1779.3

3 Conducted Test Items

3.1 Measuring Instruments

See list of measuring instruments of this test report.

3.2 Test Setup

3.2.1 Conducted Output Power

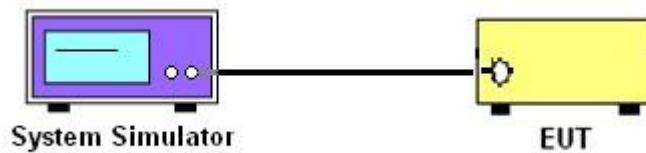

3.2.2 Peak-to-Average Ratio, Occupied Bandwidth ,Conducted Band-Edge and Conducted Spurious Emission

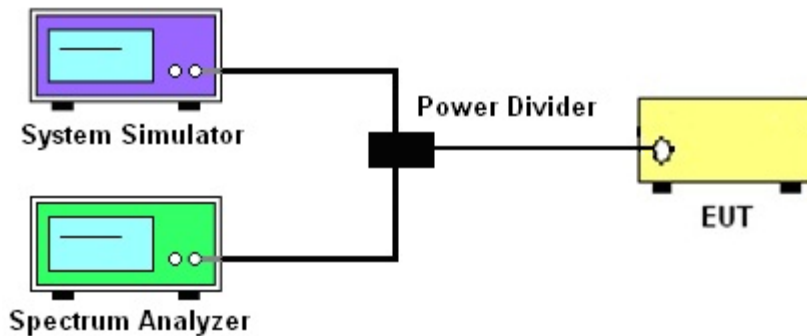

3.2.3 Frequency Stability

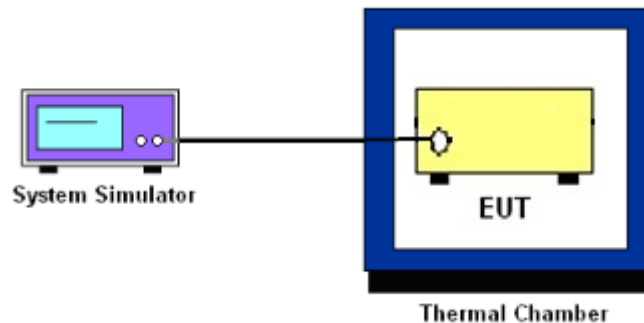

3.3 Test Result of Conducted Test

Please refer to Appendix A.



3.4 Conducted Output Power and ERP/EIRP

3.4.1 Description of the Conducted Output Power Measurement and ERP/EIRP Measurement

A system simulator was used to establish communication with the EUT. Its parameters were set to force the EUT transmitting at maximum output power. The measured power in the radio frequency on the transmitter output terminals shall be reported.

The ERP of mobile transmitters must not exceed 7 Watts for LTE Band 5 and Band 26.

The EIRP of mobile transmitters must not exceed 2 Watts for LTE Band 2 and Band 25.

The EIRP of mobile transmitters must not exceed 1 Watts for LTE Band 4 and Band 66.

According to KDB 412172 D01 Power Approach,

$EIRP = P_T + G_T - L_C$, $ERP = EIRP - 2.15$, where

P_T = transmitter output power in dBm

G_T = gain of the transmitting antenna in dBi

L_C = signal attenuation in the connecting cable between the transmitter and antenna in dB

3.4.2 Test Procedures

1. The testing follows ANSI C63.26 Section 5.2
2. The transmitter output port was connected to the system simulator.
3. Set EUT at maximum power through the system simulator.
4. Select lowest, middle, and highest channels for each band and different modulation.
5. Measure and record the power level from the system simulator.



3.5 Peak-to-Average Ratio

3.5.1 Description of the PAR Measurement

Power Complementary Cumulative Distribution Function (CCDF) curves provide a means for characterizing the power peaks of a digitally modulated signal on a statistical basis. A CCDF curve depicts the probability of the peak signal amplitude exceeding the average power level. Most contemporary measurement instrumentation include the capability to produce CCDF curves for an input signal provided that the instrument's resolution bandwidth can be set wide enough to accommodate the entire input signal bandwidth. In measuring transmissions in this band using an average power technique, the peak-to-average ratio (PAR) of the transmission may not exceed 13 dB.

3.5.2 Test Procedures

1. The testing follows ANSI C63.26 Section 5.2.3.4 (CCDF).
2. The EUT was connected to spectrum and system simulator via a power divider.
3. Set the CCDF (Complementary Cumulative Distribution Function) option in spectrum analyzer.
4. The highest RF powers were measured and recorded the maximum PAPR level associated with a probability of 0.1 %.
5. Record the deviation as Peak to Average Ratio.



3.6 Occupied Bandwidth

3.6.1 Description of Occupied Bandwidth Measurement

The occupied bandwidth is the width of a frequency band such that, below the lower and above the upper frequency limits, the mean powers emitted are each equal to a specified percentage 0.5% of the total mean transmitted power.

The 26 dB emission bandwidth is defined as the frequency range between two points, one above and one below the carrier frequency, at which the spectral density of the emission is attenuated 26 dB below the maximum in-band spectral density of the modulated signal. Spectral density (power per unit bandwidth) is to be measured with a detector of resolution bandwidth equal to approximately 1.0% of the emission bandwidth.

3.6.2 Test Procedures

1. The testing follows ANSI C63.26 Section 5.4
2. The EUT was connected to spectrum analyzer and system simulator via a power divider.
3. The spectrum analyzer center frequency is set to the nominal EUT channel center frequency. The span range for the spectrum analyzer shall be between two and five times the anticipated OBW.
4. The nominal resolution bandwidth (RBW) shall be in the range of 1 to 5 % of the anticipated OBW, and the VBW shall be at least 3 times the RBW.
5. Set the detection mode to peak, and the trace mode to max hold.
6. Determine the reference value: Set the EUT to transmit a modulated signal. Allow the trace to stabilize. Set the spectrum analyzer marker to the highest level of the displayed trace.
(this is the reference value)
7. Determine the “-26 dB down amplitude” as equal to (Reference Value – X).
8. Place two markers, one at the lowest and the other at the highest frequency of the envelope of the spectral display such that each marker is at or slightly below the “-X dB down amplitude” determined in step 6. If a marker is below this “-X dB down amplitude” value it shall be placed as close as possible to this value. The OBW is the positive frequency difference between the two markers.
9. Use the 99 % power bandwidth function of the spectrum analyzer and report the measured bandwidth.



3.7 Conducted Band Edge

3.7.1 Description of Conducted Band Edge Measurement

22.917(a)

For operations in the 824 – 849 MHz band, the FCC limit is $43 + 10\log_{10}(P[\text{Watts}])$ dB below the transmitter power $P(\text{Watts})$ in a 100kHz bandwidth. However, in the 1MHz bands immediately outside and adjacent to the licensee's frequency block, a resolution bandwidth of at least one percent of the emission bandwidth of the fundamental emission of the transmitter may be employed.

24.238 (a)

For operations in the 1850-1910 and 1930-1990 MHz band, the FCC limit is $43 + 10\log_{10}(P[\text{Watts}])$ dB below the transmitter power $P(\text{Watts})$ in a 1MHz bandwidth. However, in the 1 MHz bands immediately outside and adjacent to the frequency block a resolution bandwidth of at least one percent of the emission bandwidth of the fundamental emission of the transmitter may be employed.

27.53 (h)

For operations in the 1710 – 1755 MHz band, the FCC limit is $43 + 10\log_{10}(P[\text{Watts}])$ dB below the transmitter power $P(\text{Watts})$ in a 1 MHz bandwidth. However, in the 1MHz bands immediately outside and adjacent to the licensee's frequency block, a resolution bandwidth of at least one percent of the emission bandwidth of the fundamental emission of the transmitter may be employed.



3.7.2 Test Procedures

1. The testing follows ANSI C63.26 section 5.7
1. The EUT was connected to spectrum analyzer and system simulator via a power divider.
2. The band edges of low and high channels for the highest RF powers were measured.
3. Set RBW \geq 1% EBW in the 1MHz band immediately outside and adjacent to the band edge.
4. Beyond the 1 MHz band from the band edge, RBW=1MHz was used or a narrower RBW was used and the measured power was integrated over the full required measurement bandwidth of 1 MHz.
5. Set spectrum analyzer with RMS detector.
6. The RF fundamental frequency should be excluded against the limit line in the operating frequency band.
7. Checked that all the results comply with the emission limit line.

Example:

The limit line is derived from $43 + 10\log(P)$ dB below the transmitter power P(Watts)

$$= P(W) - [43 + 10\log(P)] \text{ (dB)}$$

$$= [30 + 10\log(P)] \text{ (dBm)} - [43 + 10\log(P)] \text{ (dB)} = -13\text{dBm.}$$

8. When using the integration method, the starting frequency of the integration shall be centered at one-half of the RBW away from the band edge.



3.8 Conducted Spurious Emission

3.8.1 Description of Conducted Spurious Emission Measurement

The power of any emission outside of the authorized operating frequency ranges must be lower than the transmitter power (P) by a factor of at least $43 + 10 \log (P)$ dB.

It is measured by means of a calibrated spectrum analyzer and scanned from 30 MHz up to a frequency including its 10th harmonic.

3.8.2 Test Procedures

1. The testing follows ANSI C63.26 section 5.7
2. The EUT was connected to spectrum analyzer and system simulator via a power divider.
3. The RF output of EUT was connected to the spectrum analyzer by RF cable and attenuator. The path loss was compensated to the results for each measurement.
4. The middle channel for the highest RF power within the transmitting frequency was measured.
5. The conducted spurious emission for the whole frequency range was taken.
6. Make the measurement with the spectrum analyzer's RBW = 1MHz, VBW = 3MHz.
7. Set spectrum analyzer with RMS detector.
8. Taking the record of maximum spurious emission.
9. The RF fundamental frequency should be excluded against the limit line in the operating frequency band.
10. The limit line is derived from $43 + 10\log(P)$ dB below the transmitter power P(Watts)
= P(W)- [43 + 10log(P)] (dB)
= [30 + 10log(P)] (dBm) - [43 + 10log(P)] (dB)
= -13dBm.



3.9 Frequency Stability

3.9.1 Description of Frequency Stability Measurement

The frequency stability shall be measured by variation of ambient temperature and variation of primary supply voltage to ensure that the fundamental emission stays within the authorized frequency block. The frequency stability of the transmitter shall be maintained within $\pm 0.00025\%$ ($\pm 2.5\text{ppm}$) of the center frequency.

3.9.2 Test Procedures for Temperature Variation

1. The testing follows ANSI C63.26 section 5.6.4
2. The EUT was set up in the thermal chamber and connected with the system simulator.
3. With power OFF, the temperature was decreased to -30°C and the EUT was stabilized before testing. Power was applied and the maximum change in frequency was recorded within one minute.
4. With power OFF, the temperature was raised in 10°C step up to 50°C . The EUT was stabilized at each step for at least half an hour. Power was applied and the maximum frequency change was recorded within one minute.

3.9.3 Test Procedures for Voltage Variation

1. The testing follows ANSI C63.26 section 5.6.5
2. The EUT was placed in a temperature chamber at $20\pm 5^{\circ}\text{C}$ and connected with the system simulator.
3. The power supply voltage to the EUT was varied from 85% to 115% of the nominal value for other than hand carried battery equipment.
4. For hand carried, battery powered equipment, reduce the primary ac or dc supply voltage to the battery operating end point, which shall be specified by the manufacturer.
5. The variation in frequency was measured for the worst case.

4 Radiated Test Items

4.1 Measuring Instruments

See list of measuring instruments of this test report.

4.2 Test Setup

4.2.1 For radiated test below 30MHz

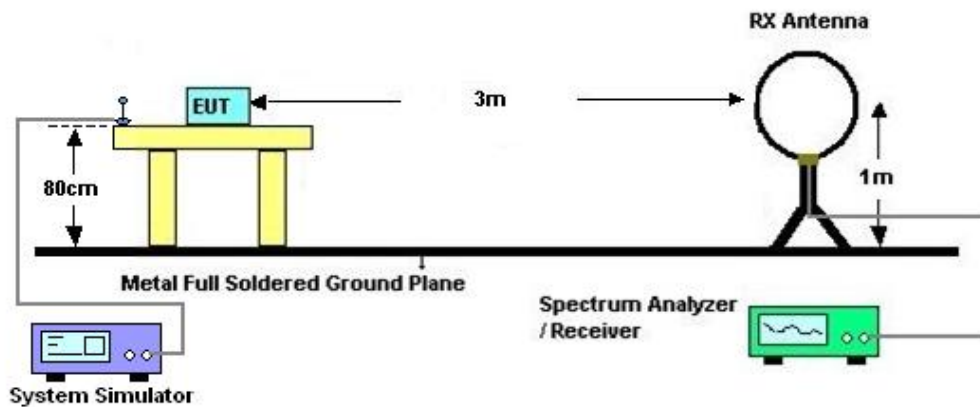

4.2.2 For radiated test from 30MHz to 1GHz

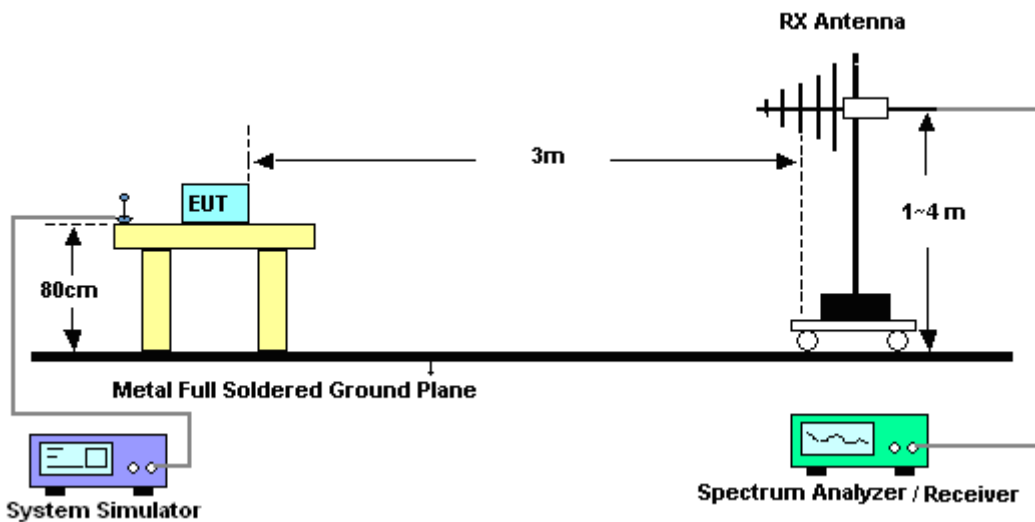

4.2.3 For radiated test above 1GHz

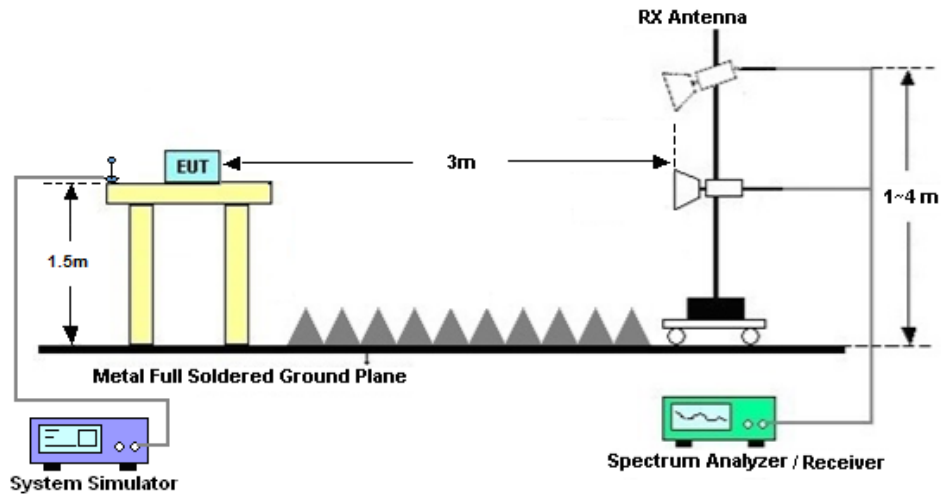

4.3 Test Result of Radiated Test

The low frequency, which started from 9 kHz to 30MHz, was pre-scanned and the result which was 20dB lower than the limit line was not reported.

Please refer to Appendix B.



4.4 Radiated Spurious Emission

4.4.1 Description of Radiated Spurious Emission

The radiated spurious emission was measured by substitution method according to ANSI C63.26. The power of any emission outside of the authorized operating frequency ranges must be attenuated below the transmitter power (P) by a factor of at least $43 + 10 \log (P)$ dB.

The spectrum is scanned from 30 MHz up to a frequency including its 10th harmonic.

4.4.2 Test Procedures

1. The testing follows ANSI C63.26 Section 5.5
2. The EUT was placed on a turntable with 0.8 meter height for frequency below 1GHz and 1.5 meter height for frequency above 1GHz respectively above ground.
3. The EUT was set 3 meters from the receiving antenna mounted on the antenna tower.
4. The table was rotated 360 degrees to determine the position of the highest spurious emission.
5. The height of the receiving antenna is varied between 1m to 4m to search the maximum spurious emission for both horizontal and vertical polarizations.
6. During the measurement, the system simulator parameters were set to force the EUT transmitting at maximum output power.
7. Make the measurement with the spectrum analyzer's RBW = 1MHz, VBW = 3MHz, taking the record of maximum spurious emission.
8. A horn antenna was substituted in place of the EUT and was driven by a signal generator.
9. Tune the output power of signal generator to the same emission level with EUT maximum spurious emission.
10. $EIRP (dBm) = S.G. Power - Tx Cable Loss + Tx Antenna Gain$
11. $ERP (dBm) = EIRP - 2.15$
12. The RF fundamental frequency should be excluded against the limit line in the operating frequency band.

The limit line is derived from $43 + 10\log(P)$ dB below the transmitter power P(Watts)
= $P(W) - [43 + 10\log(P)] (dB)$
= $[30 + 10\log(P)] (dBm) - [43 + 10\log(P)] (dB)$
= -13dBm.



5 List of Measuring Equipment

Instrument	Manufacturer	Model No.	Serial No.	Characteristics	Calibration Date	Test Date	Due Date	Remark
Spectrum Analyzer	R&S	FSV40	101040	10Hz~40GHz	Oct. 11, 2023	Apr. 28, 2024~ May 17, 2024	Oct. 10, 2024	Conducted (TH01-KS)
Power divider	STI	STI08-0055	-	0.5~40GHz	NCR	Apr. 28, 2024~ May 17, 2024	NCR	Conducted (TH01-KS)
Temperature & humidity	Hongzhan	LP-150U	H2014011440	-40~+150°C 20%~95%RH	Jul. 06, 2023	Apr. 28, 2024~ May 17, 2024	Jul. 05, 2024	Conducted (TH01-KS)
EMI Test Receiver&SA	KEYSIGHT	N9038A	MY54450083	20Hz~8.4GHz	Apr. 09, 2024	Jun. 23, 2024~ Jun. 25, 2024	Apr. 08, 2025	Radiation (03CH03-SZ)
EXA Spectrum Analyzer	KEYSIGHT	N9010A	MY55150246	10Hz~44GHz;	Apr. 09, 2024	Jun. 23, 2024~ Jun. 25, 2024	Apr. 08, 2025	Radiation (03CH03-SZ)
Loop Antenna	R&S	HFH2-Z2	100354	9kHz~30MHz	Jun. 28, 2022	Jun. 23, 2024~ Jun. 25, 2024	Jun. 27, 2024	Radiation (03CH03-SZ)
Bilog Antenna	TeseQ	CBL6112D	35408	30MHz~2GHz	Aug. 20, 2023	Jun. 23, 2024~ Jun. 25, 2024	Aug. 19, 2025	Radiation (03CH03-SZ)
Double Ridge Horn Antenna	SCHWARZBECK	BBHA9120D	9120D-1355	1GHz~18GHz	Apr. 09, 2024	Jun. 23, 2024~ Jun. 25, 2024	Apr. 08, 2025	Radiation (03CH03-SZ)
SHF-EHF Horn	com-power	AH-840	101071	18GHz~40GHz	Apr. 09, 2024	Jun. 23, 2024~ Jun. 25, 2024	Apr. 08, 2025	Radiation (03CH03-SZ)
Amplifier	Burgeon	BPA-530	102211	0.01Hz ~3000MHz	Oct. 18, 2023	Jun. 23, 2024~ Jun. 25, 2024	Oct. 17, 2024	Radiation (03CH03-SZ)
Amplifier	Agilent Technologies	83017A	MY39501302	500MHz~26.5GHz	Dec. 27, 2023	Jun. 23, 2024~ Jun. 25, 2024	Dec. 26, 2024	Radiation (03CH03-SZ)
HF Amplifier	MITEQ	TTA1840-35-HG	1871923	18GHz~40GHz	Jul. 07, 2023	Jun. 23, 2024~ Jun. 25, 2024	Jul. 06, 2024	Radiation (03CH03-SZ)
AC Power Source	Chroma	61601	616010002729	N/A	Oct. 18, 2023	Jun. 23, 2024~ Jun. 25, 2024	Oct. 17, 2024	Radiation (03CH03-SZ)
Turn Table	EM	EM1000	N/A	0~360 degree	NCR	Jun. 23, 2024~ Jun. 25, 2024	NCR	Radiation (03CH03-SZ)
Antenna Mast	EM	EM1000	N/A	1 m~4 m	NCR	Jun. 23, 2024~ Jun. 25, 2024	NCR	Radiation (03CH03-SZ)

NCR: No Calibration Required



6 Measurement Uncertainty

The measurement uncertainties shown below were calculated in accordance with the requirements of ANSI 63.26-2015. All the measurement uncertainty value were shown with a coverage K=2 to indicate 95% level of confidence. The measurement data show herein meets or exceeds the CISPR measurement uncertainty values specified in CISPR 16-4-2 and can be compared directly to specified limit to determine compliance.

Uncertainty of Conducted Measurement

Test Item	Uncertainty
Conducted Spurious Emission & Bandedge	±2.26 dB
Occupied Channel Bandwidth	±0.1%
Conducted Power	±0.46 dB
Peak to Average Ratio	±0.46 dB
Frequency Stability	±0.4 Hz

Uncertainty of Radiated Emission Measurement (9 KHz ~ 30 MHz)

Measuring Uncertainty for a Level of Confidence of 95% (U = 2Uc(y))	3.0 dB
---	--------

Uncertainty of Radiated Emission Measurement (30 MHz ~ 1000 MHz)

Measuring Uncertainty for a Level of Confidence of 95% (U = 2Uc(y))	3.6 dB
---	--------

Uncertainty of Radiated Emission Measurement (1 GHz ~ 40 GHz)

Measuring Uncertainty for a Level of Confidence of 95% (U = 2Uc(y))	3.8 dB
---	--------

----- THE END -----



Appendix A. Test Results of Conducted Test

Test Engineer :	Smile Wang	Temperature :	22~23°C
		Relative Humidity :	40~42%

Conducted Output Power(Average power) and ERP/EIRP

LTE Band 2_ANT0

BW [MHz]	Modulation	RB Size	RB Offset	Power Low Ch. / Freq.	Power Middle Ch. / Freq.	Power High Ch. / Freq.	EIRP(W)		
Channel				18700	18900	19100			
Frequency (MHz)				1860	1880	1900	L	M	H
20	QPSK	1	0	22.96	23.05	22.82	0.0968	0.0989	0.0938
20	QPSK	1	99	23.00	23.03	22.89	0.0977	0.0984	0.0953
20	QPSK	100	0	21.96	22.05	21.90	0.0769	0.0785	0.0759
20	16QAM	1	0	21.87	22.00	21.90	0.0753	0.0776	0.0759
20	64QAM	1	0	21.01	21.10	20.75	0.0618	0.0631	0.0582
20	256QAM	1	0	17.93	18.09	17.79	0.0304	0.0316	0.0294
Channel				18675	18900	19125	EIRP(W)		
Frequency (MHz)				1857.5	1880	1902.5	L	M	H
15	QPSK	1	0	22.86	22.99	22.83	0.0946	0.0975	0.0940
15	16QAM	1	0	21.75	21.96	21.87	0.0733	0.0769	0.0753
Channel				18650	18900	19150	EIRP(W)		
Frequency (MHz)				1855	1880	1905	L	M	H
10	QPSK	1	0	22.90	22.96	22.93	0.0955	0.0968	0.0962
10	16QAM	1	0	21.77	21.96	21.84	0.0736	0.0769	0.0748
Channel				18625	18900	19175	EIRP(W)		
Frequency (MHz)				1852.5	1880	1907.5	L	M	H
5	QPSK	1	0	22.95	22.87	22.85	0.0966	0.0948	0.0944
5	16QAM	1	0	21.78	21.84	21.97	0.0738	0.0748	0.0771
Channel				18615	18900	19185	EIRP(W)		
Frequency (MHz)				1851.5	1880	1908.5	L	M	H
3	QPSK	1	0	22.93	22.90	22.83	0.0962	0.0955	0.0940
3	16QAM	1	0	21.70	21.96	21.86	0.0724	0.0769	0.0752
Channel				18607	18900	19193	EIRP(W)		
Frequency (MHz)				1850.7	1880	1909.3	L	M	H
1.4	QPSK	1	0	22.90	22.93	22.74	0.0955	0.0962	0.0920
1.4	16QAM	1	0	21.69	21.83	21.71	0.0723	0.0746	0.0726



LTE Band 4_ANT0

BW [MHz]	Modulation	RB Size	RB Offset	Power Low Ch. / Freq.	Power Middle Ch. / Freq.	Power High Ch. / Freq.	EIRP(W)		
Channel				20050	20175	20300	EIRP(W)		
Frequency (MHz)				1720	1732.5	1745	L	M	H
20	QPSK	1	0	22.71	22.91	22.61	0.1178	0.1233	0.1151
20	QPSK	1	99	22.59	22.88	22.50	0.1146	0.1225	0.1122
20	QPSK	100	0	21.66	21.86	21.63	0.0925	0.0968	0.0918
20	16QAM	1	0	21.66	21.93	21.66	0.0925	0.0984	0.0925
20	64QAM	1	0	20.73	20.93	20.68	0.0746	0.0782	0.0738
20	256QAM	1	0	17.73	17.98	17.60	0.0374	0.0396	0.0363
Channel				20025	20175	20325	EIRP(W)		
Frequency (MHz)				1717.5	1732.5	1747.5	L	M	H
15	QPSK	1	0	22.66	22.77	22.48	0.1164	0.1194	0.1117
15	16QAM	1	0	21.53	21.76	21.54	0.0897	0.0946	0.0899
Channel				20000	20175	20350	EIRP(W)		
Frequency (MHz)				1715	1732.5	1750	L	M	H
10	QPSK	1	0	22.67	22.86	22.47	0.1167	0.1219	0.1114
10	16QAM	1	0	21.54	21.89	21.55	0.0899	0.0975	0.0902
Channel				19975	20175	20375	EIRP(W)		
Frequency (MHz)				1712.5	1732.5	1752.5	L	M	H
5	QPSK	1	0	22.59	22.77	22.42	0.1146	0.1194	0.1102
5	16QAM	1	0	21.49	21.88	21.60	0.0889	0.0973	0.0912
Channel				19965	20175	20385	EIRP(W)		
Frequency (MHz)				1711.5	1732.5	1753.5	L	M	H
3	QPSK	1	0	22.54	22.72	22.53	0.1132	0.1180	0.1130
3	16QAM	1	0	21.50	21.88	21.60	0.0891	0.0973	0.0912
Channel				19957	20175	20393	EIRP(W)		
Frequency (MHz)				1710	1732.5	1754.3	L	M	H
1.4	QPSK	1	0	22.66	22.52	22.57	0.1164	0.1127	0.1140
1.4	16QAM	1	0	21.47	21.28	21.44	0.0885	0.0847	0.0879



LTE Band 5_ANT0

BW [MHz]	Modulation	RB Size	RB Offset	Power Low Ch. / Freq.	Power Middle Ch. / Freq.	Power High Ch. / Freq.	ERP(W)		
Channel				20450	20525	20600	ERP(W)		
Frequency (MHz)				829	836.5	844	L	M	H
10	QPSK	1	0	22.57	22.83	22.73	0.0325	0.0345	0.0337
10	QPSK	1	49	22.50	22.75	22.70	0.0320	0.0339	0.0335
10	QPSK	50	0	21.52	21.76	21.69	0.0255	0.0270	0.0265
10	16QAM	1	0	21.53	21.83	21.75	0.0256	0.0274	0.0269
10	64QAM	1	0	20.55	20.80	20.79	0.0204	0.0216	0.0216
10	256QAM	1	0	17.61	17.91	17.81	0.0104	0.0111	0.0109
Channel				20425	20525	20625	ERP(W)		
Frequency (MHz)				826.5	836.5	846.5	L	M	H
5	QPSK	1	0	22.44	22.68	22.68	0.0316	0.0333	0.0333
5	16QAM	1	0	21.35	21.78	21.59	0.0245	0.0271	0.0259
Channel				20415	20525	20635	ERP(W)		
Frequency (MHz)				825.5	836.5	847.5	L	M	H
3	QPSK	1	0	22.45	22.74	22.63	0.0316	0.0338	0.0330
3	16QAM	1	0	21.35	21.78	21.74	0.0245	0.0271	0.0269
Channel				20407	20525	20643	ERP(W)		
Frequency (MHz)				824.7	836.5	848.3	L	M	H
1.4	QPSK	1	0	22.53	22.71	22.62	0.0322	0.0336	0.0329
1.4	16QAM	1	0	21.51	21.81	21.69	0.0255	0.0273	0.0265



LTE Band 25_ANT0

BW [MHz]	Modulation	RB Size	RB Offset	Power Low Ch. / Freq.	Power Middle Ch. / Freq.	Power High Ch. / Freq.	EIRP(W)		
Channel				26140	26340	26590	EIRP(W)		
Frequency (MHz)				1860	1880	1905	L	M	H
20	QPSK	1	0	23.10	23.13	23.09	0.1000	0.1007	0.0998
20	QPSK	1	99	23.01	22.99	23.03	0.0979	0.0975	0.0984
20	QPSK	100	0	22.11	22.14	22.12	0.0796	0.0802	0.0798
20	16QAM	1	0	22.09	22.16	22.05	0.0793	0.0805	0.0785
20	64QAM	1	0	21.06	21.03	21.15	0.0625	0.0621	0.0638
20	256QAM	1	0	18.11	18.15	18.07	0.0317	0.0320	0.0314
Channel				26115	26340	26615	EIRP(W)		
Frequency (MHz)				1857.5	1880	1907.5	L	M	H
15	QPSK	1	0	23.00	23.00	22.98	0.0977	0.0977	0.0973
15	16QAM	1	0	21.94	22.06	21.90	0.0766	0.0787	0.0759
Channel				26090	26340	26640	EIRP(W)		
Frequency (MHz)				1855	1880	1910	L	M	H
10	QPSK	1	0	23.05	23.04	23.07	0.0989	0.0986	0.0993
10	16QAM	1	0	21.99	22.14	21.94	0.0774	0.0802	0.0766
Channel				26065	26340	26665	EIRP(W)		
Frequency (MHz)				1852.5	1880	1912.5	L	M	H
5	QPSK	1	0	23.04	23.09	23.04	0.0986	0.0998	0.0986
5	16QAM	1	0	21.91	22.14	21.90	0.0760	0.0802	0.0759
Channel				26055	26340	26675	EIRP(W)		
Frequency (MHz)				1851.5	1880	1913.5	L	M	H
3	QPSK	1	0	23.04	23.00	23.02	0.0986	0.0977	0.0982
3	16QAM	1	0	21.91	22.13	21.90	0.0760	0.0800	0.0759
Channel				26047	26340	26683	EIRP(W)		
Frequency (MHz)				1850.7	1880	1914.3	L	M	H
1.4	QPSK	1	0	22.97	22.99	22.96	0.0971	0.0975	0.0968
1.4	16QAM	1	0	21.96	22.07	21.98	0.0769	0.0789	0.0773



LTE Band 26_ANT0

BW [MHz]	Modulation	RB Size	RB Offset	Power Low Ch. / Freq.	Power Low Ch. / Freq.	Power Middle Ch. / Freq.	Power High Ch. / Freq.	ERP(W)			
Channel				26790	26865	26915	26965				
Frequency (MHz)				824	831.5	836.5	841.5	Straddle Ch	L	M	H
15	QPSK	1	0	22.69	22.94	22.81	22.56	0.0334	0.0354	0.0344	0.0324
15	QPSK	1	74	22.61	22.84	22.49	22.51	0.0328	0.0346	0.0319	0.0321
15	QPSK	75	0	21.61	21.89	21.53	21.51	0.0261	0.0278	0.0256	0.0255
15	16QAM	1	0	21.62	21.92	21.66	21.63	0.0261	0.0280	0.0264	0.0262
15	64QAM	1	0	20.73	20.90	20.80	20.56	0.0213	0.0221	0.0216	0.0205
15	256QAM	1	0	17.74	17.86	17.55	17.65	0.0107	0.0110	0.0102	0.0105
Channel					26840	26915	26990	ERP(W)			
Frequency (MHz)					829	836.5	844		L	M	H
10	QPSK	1	0		22.41	22.76	22.86		0.0313	0.0340	0.0348
10	16QAM	1	0		21.47	21.63	21.80		0.0252	0.0262	0.0272
Channel					26815	26915	27015	ERP(W)			
Frequency (MHz)					826.5	836.5	846.5		L	M	H
5	QPSK	1	0		22.48	22.65	22.80		0.0318	0.0331	0.0343
5	16QAM	1	0		21.56	21.67	21.75		0.0258	0.0264	0.0269
Channel					26815	26915	27025	ERP(W)			
Frequency (MHz)					825.5	836.5	847.5		L	M	H
3	QPSK	1	0		22.45	22.73	22.90		0.0316	0.0337	0.0351
3	16QAM	1	0		21.59	21.59	21.80		0.0259	0.0259	0.0272
Channel					26797	26915	27033	ERP(W)			
Frequency (MHz)					824.7	836.5	848.3		L	M	H
1.4	QPSK	1	0		22.38	22.79	22.82		0.0311	0.0342	0.0344
1.4	16QAM	1	0		21.57	21.74	21.81		0.0258	0.0269	0.0273



LTE Band 66_ANT0

BW [MHz]	Modulation	RB Size	RB Offset	Power Low Ch. / Freq.	Power Middle Ch. / Freq.	Power High Ch. / Freq.	EIRP(W)		
Channel				132072	132322	132572	EIRP(W)		
Frequency (MHz)				1720	1745	1770	L	M	H
20	QPSK	1	0	22.61	22.99	22.81	0.1151	0.1256	0.1205
20	QPSK	1	99	22.57	22.86	22.65	0.1140	0.1219	0.1161
20	QPSK	100	0	21.61	22.01	21.76	0.0914	0.1002	0.0946
20	16QAM	1	0	21.53	21.99	21.76	0.0897	0.0998	0.0946
20	64QAM	1	0	20.55	21.04	20.73	0.0716	0.0802	0.0746
20	256QAM	1	0	17.60	17.90	17.79	0.0363	0.0389	0.0379
Channel				132047	132322	132597	EIRP(W)		
Frequency (MHz)				1717.5	1745	1772.5	L	M	H
15	QPSK	1	0	22.62	22.94	22.83	0.1153	0.1242	0.1211
15	16QAM	1	0	21.54	21.98	21.65	0.0899	0.0995	0.0923
Channel				132022	132322	132622	EIRP(W)		
Frequency (MHz)				1715	1745	1775	L	M	H
10	QPSK	1	0	22.58	22.89	22.75	0.1143	0.1227	0.1189
10	16QAM	1	0	21.56	21.99	21.69	0.0904	0.0998	0.0931
Channel				131997	132322	132647	EIRP(W)		
Frequency (MHz)				1712.5	1745	1777.5	L	M	H
5	QPSK	1	0	22.60	22.85	22.69	0.1148	0.1216	0.1172
5	16QAM	1	0	21.56	21.87	21.74	0.0904	0.0971	0.0942
Channel				131987	132322	132657	EIRP(W)		
Frequency (MHz)				1711.5	1745	1778.5	L	M	H
3	QPSK	1	0	22.50	22.93	22.83	0.1122	0.1239	0.1211
3	16QAM	1	0	21.61	22.02	21.67	0.0914	0.1005	0.0927
Channel				131979	132322	132665	EIRP(W)		
Frequency (MHz)				1710.7	1745	1779.3	L	M	H
1.4	QPSK	1	0	22.64	22.91	22.83	0.1159	0.1233	0.1211
1.4	16QAM	1	0	21.61	21.89	21.78	0.0914	0.0975	0.0951



LTE Band 25

Peak-to-Average Ratio

Mode	LTE Band 25 / 20MHz				
Mod.	QPSK	16QAM	64QAM	256QAM	Limit: 13dB
RB Size	Full RB	Full RB	Full RB	Full RB	Result
Middle CH	5.04	6.14	6.46	6.72	PASS

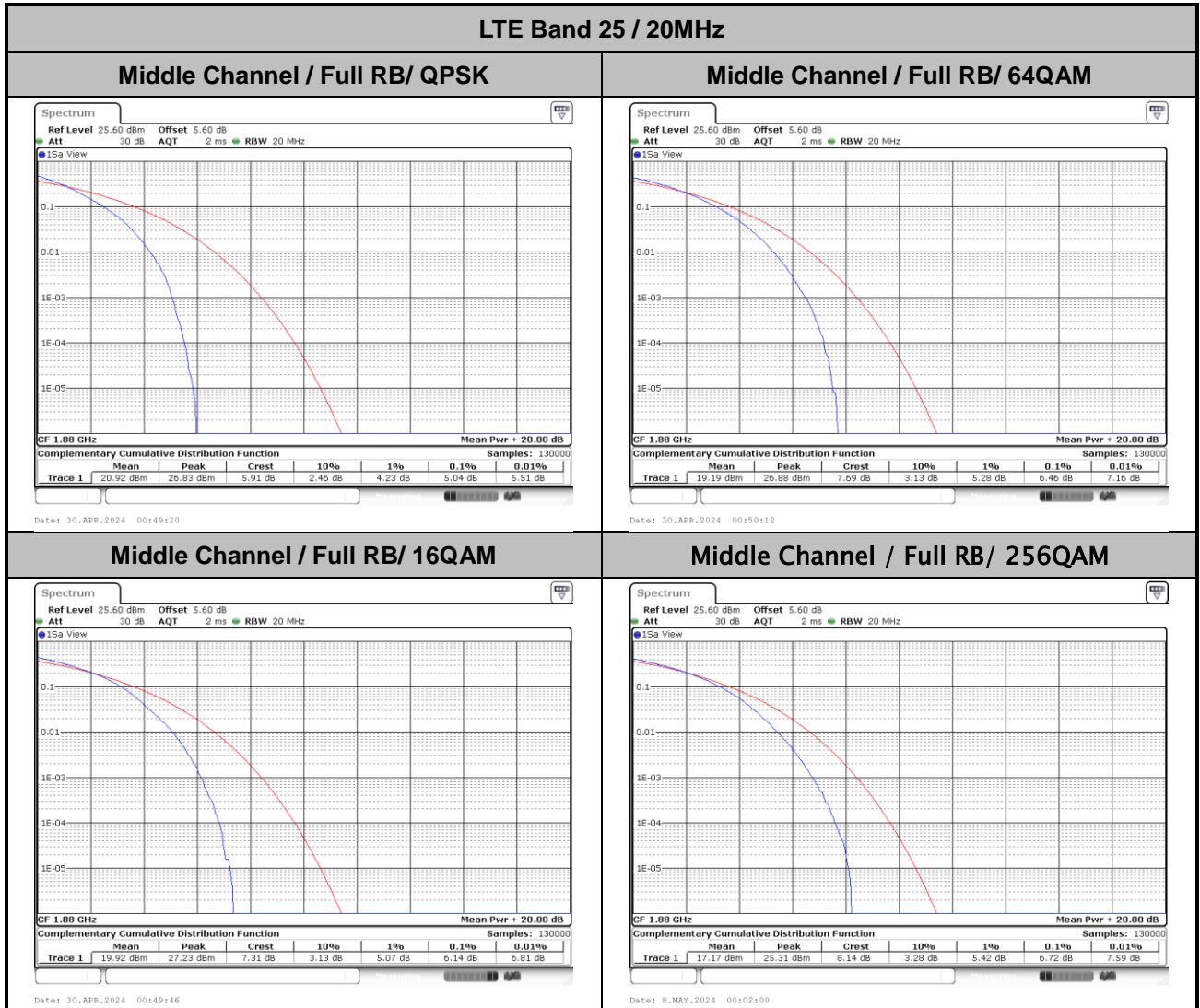



26dB Bandwidth

Mode	LTE Band 25 : 26dB BW(MHz)	
BW	1.4MHz	
Mod.	QPSK	16QAM
Middle CH	1.24	1.24
BW	3MHz	
Mod.	QPSK	16QAM
Middle CH	2.94	2.96
BW	5MHz	
Mod.	QPSK	16QAM
Middle CH	4.91	4.96
BW	10MHz	
Mod.	QPSK	16QAM
Middle CH	9.79	9.85
BW	15MHz	
Mod.	QPSK	16QAM
Middle CH	14.87	14.51
BW	20MHz	
Mod.	QPSK	16QAM
Middle CH	19.38	19.58



LTE Band 25

Middle Channel / 1.4MHz / QPSK

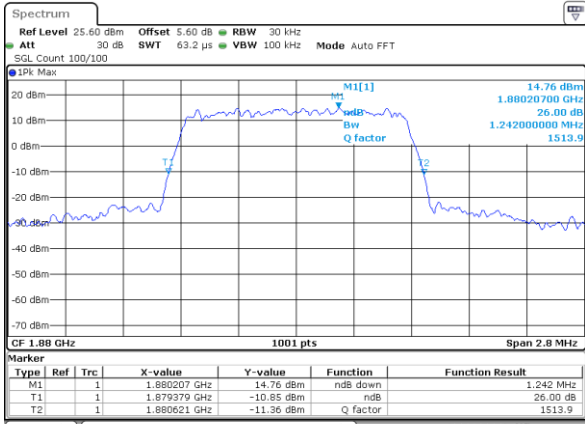

Date: 30.APR.2024 00:59:50

Middle Channel / 1.4MHz / 16QAM

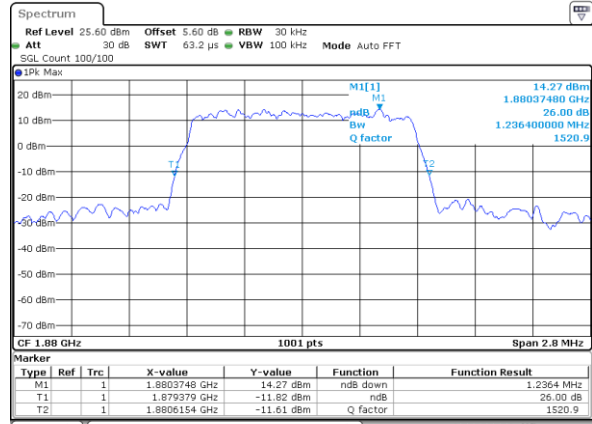

Date: 30.APR.2024 01:00:11

LTE Band 25

Middle Channel / 3MHz / QPSK

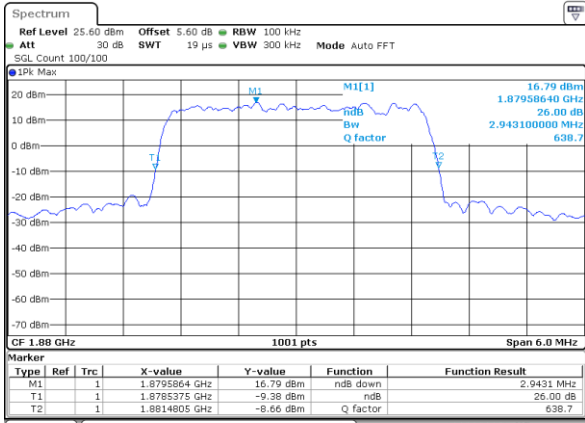

Date: 30.APR.2024 00:58:20

Middle Channel / 3MHz / 16QAM

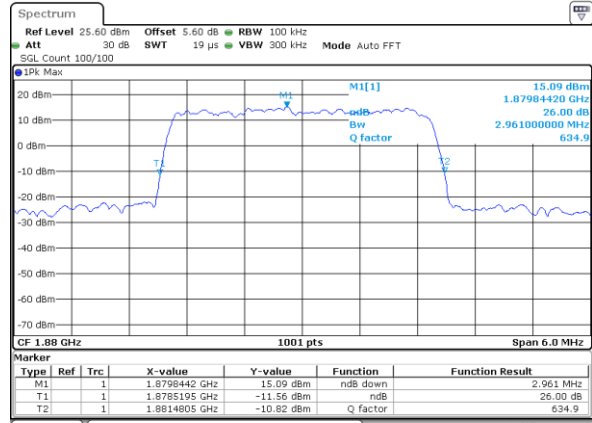

Date: 30.APR.2024 00:58:44

LTE Band 25

Middle Channel / 5MHz / QPSK

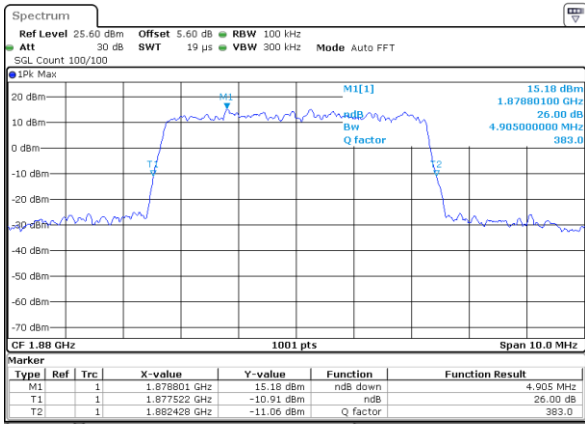

Date: 30.APR.2024 00:54:43

Middle Channel / 5MHz / 16QAM

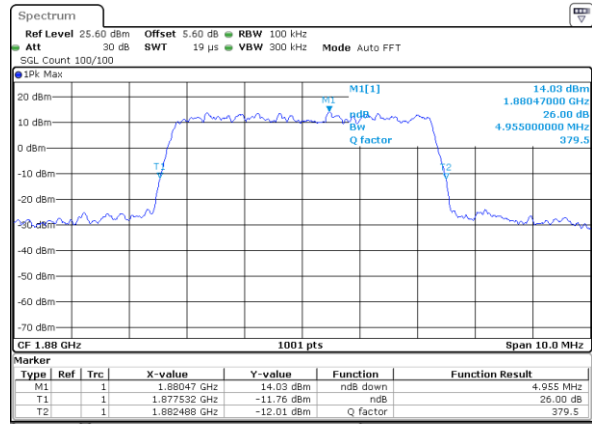

Date: 30.APR.2024 00:55:05



LTE Band 25

Middle Channel / 10MHz / QPSK

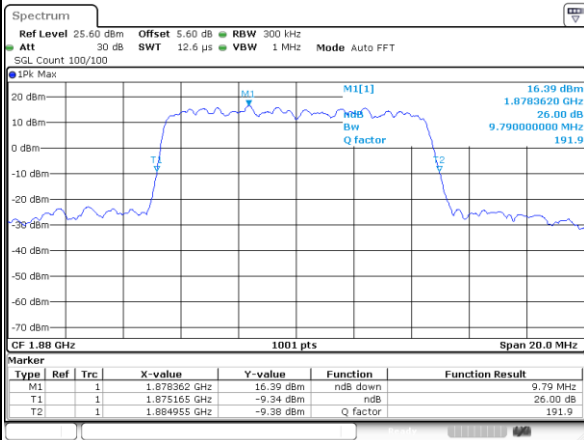

Date: 30.APR.2024 00:53:06

Middle Channel / 10MHz / 16QAM

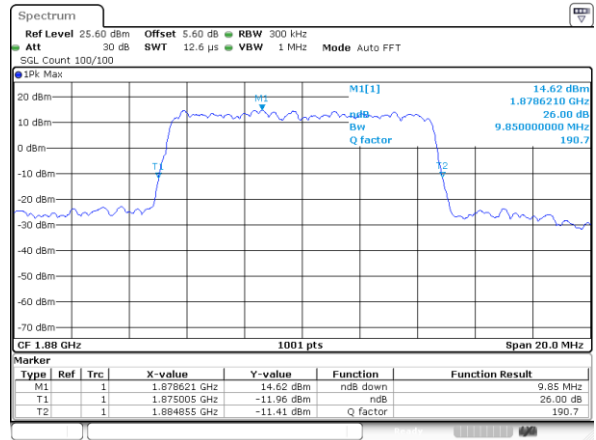

Date: 30.APR.2024 00:53:31

LTE Band 25

Middle Channel / 15MHz / QPSK

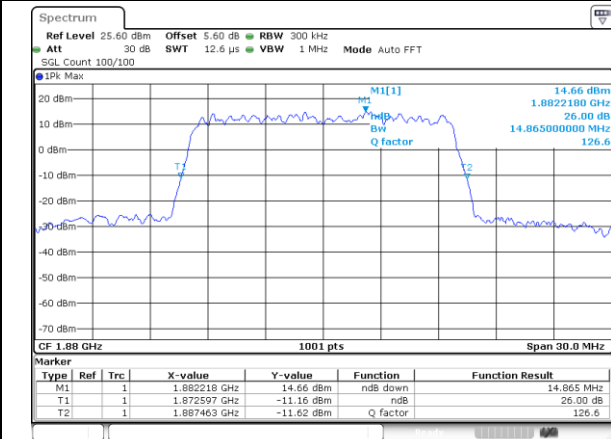

Date: 30.APR.2024 00:51:32

Middle Channel / 15MHz / 16QAM

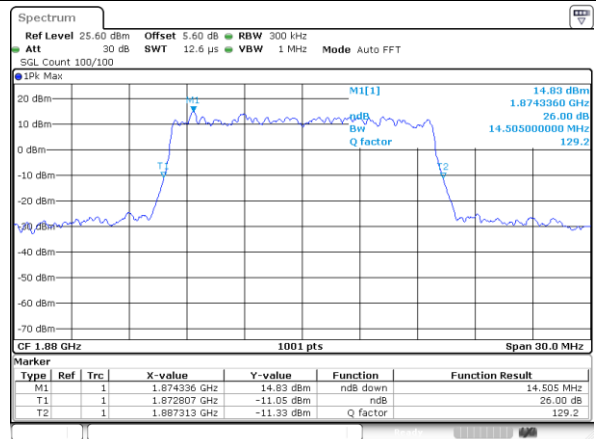

Date: 30.APR.2024 00:51:55

LTE Band 25

Middle Channel / 20MHz / QPSK

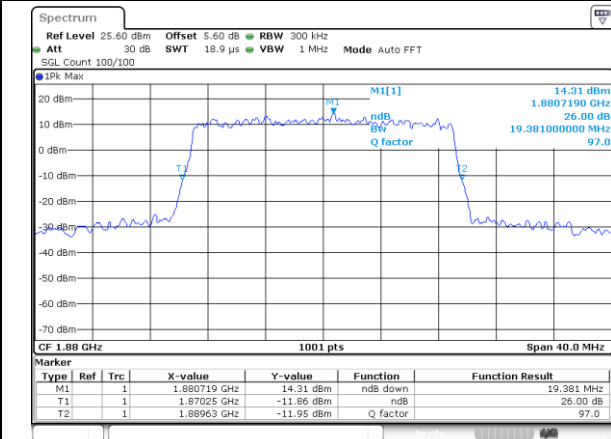

Date: 30.APR.2024 00:37:08

Middle Channel / 20MHz / 16QAM

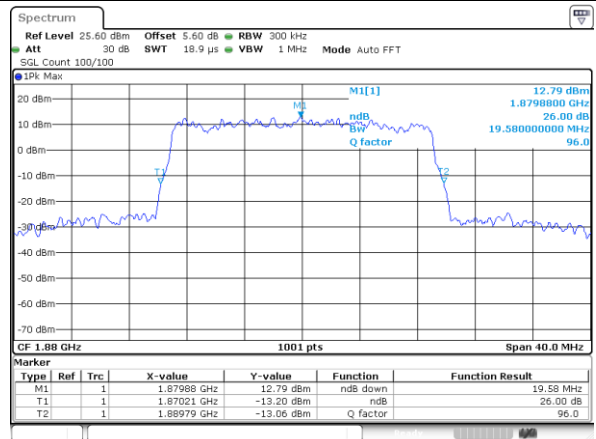

Date: 30.APR.2024 00:37:30



Occupied Bandwidth

Mode	LTE Band 25 : 99%OBW(MHz)	
BW	1.4MHz	
Mod.	QPSK	16QAM
Middle CH	1.08	1.09
BW	3MHz	
Mod.	QPSK	16QAM
Middle CH	2.70	2.69
BW	5MHz	
Mod.	QPSK	16QAM
Middle CH	4.50	4.49
BW	10MHz	
Mod.	QPSK	16QAM
Middle CH	9.05	9.05
BW	15MHz	
Mod.	QPSK	16QAM
Middle CH	13.46	13.43
BW	20MHz	
Mod.	QPSK	16QAM
Middle CH	17.86	17.86



LTE Band 25

Middle Channel / 1.4MHz / QPSK

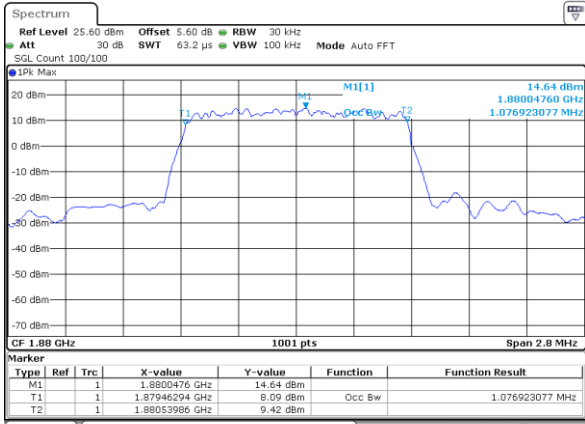

Date: 30.APR.2024 00:59:28

Middle Channel / 1.4MHz / 16QAM

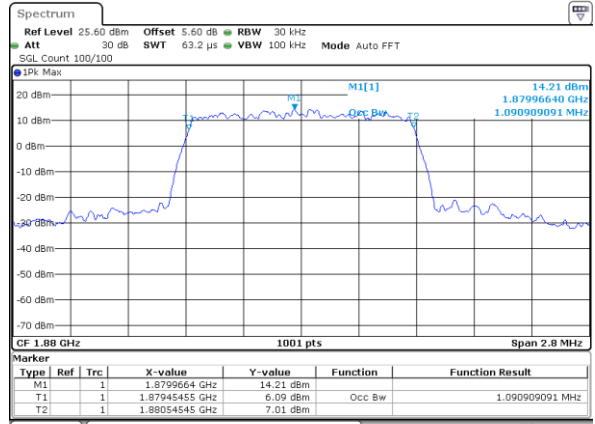

Date: 30.APR.2024 01:00:134

LTE Band 25

Middle Channel / 3MHz / QPSK

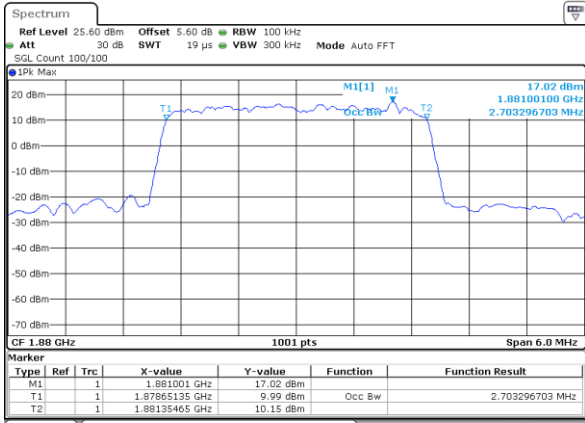

Date: 30.APR.2024 00:57:58

Middle Channel / 3MHz / 16QAM

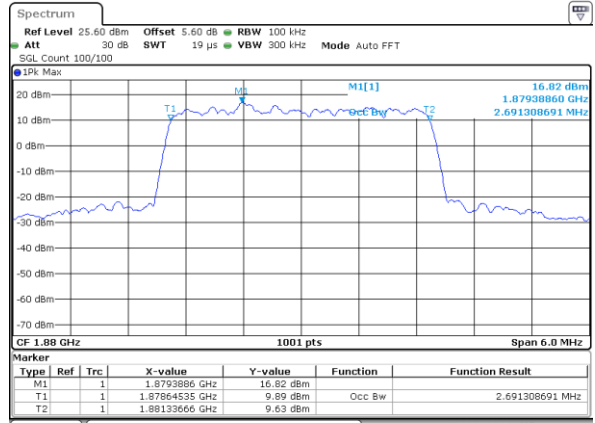

Date: 30.APR.2024 00:59:103

LTE Band 25

Middle Channel / 5MHz / QPSK

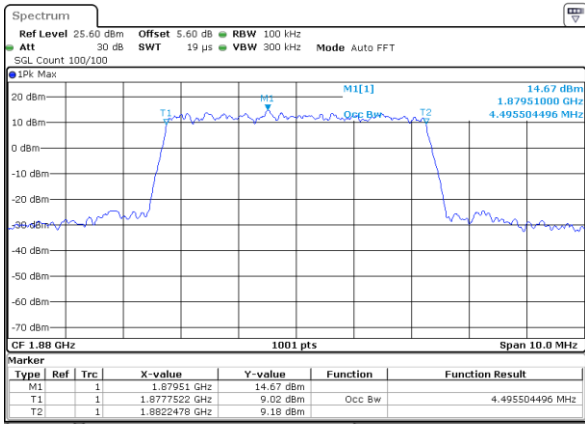

Date: 30.APR.2024 00:54:22

Middle Channel / 5MHz / 16QAM

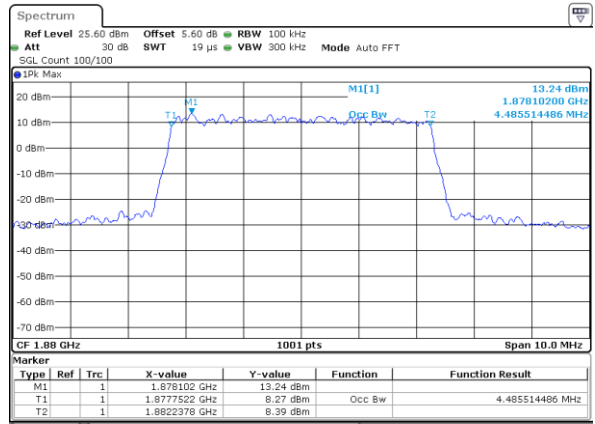

Date: 30.APR.2024 00:57:136



LTE Band 25

Middle Channel / 10MHz / QPSK

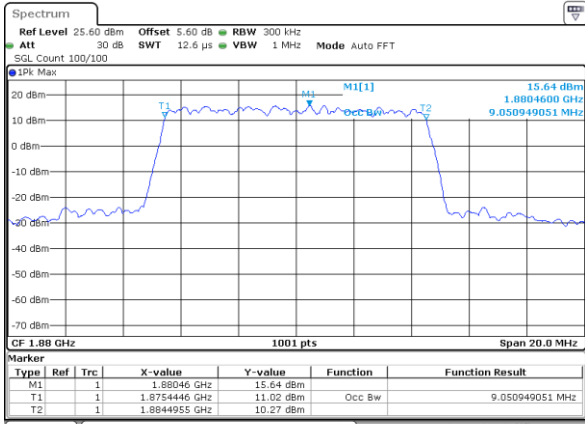

Date: 30.APR.2024 00:52:41

Middle Channel / 10MHz / 16QAM

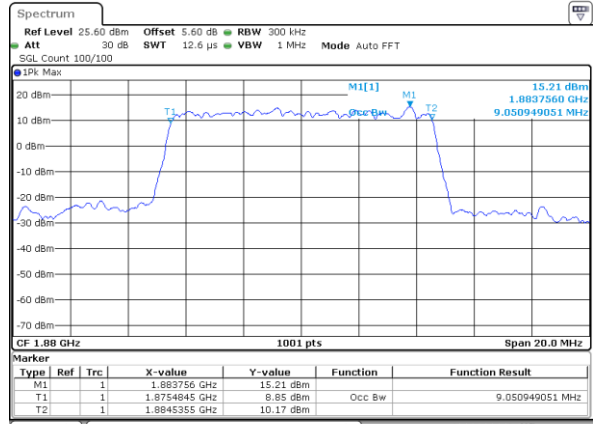

Date: 30.APR.2024 00:53:57

LTE Band 25

Middle Channel / 15MHz / QPSK

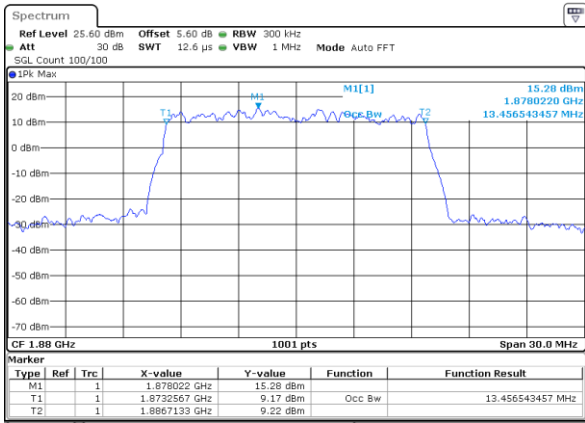

Date: 30.APR.2024 00:50:37

Middle Channel / 15MHz / 16QAM

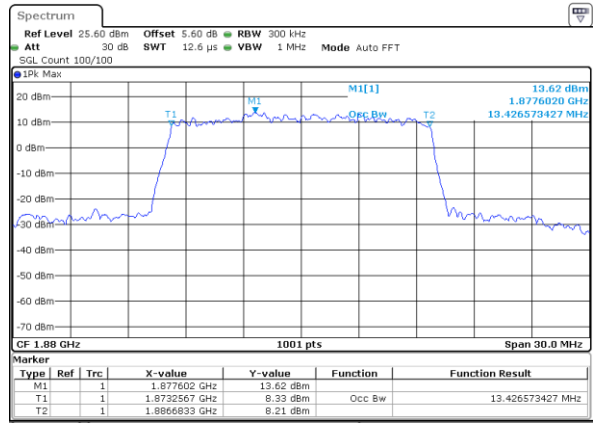

Date: 30.APR.2024 00:52:19

LTE Band 25

Middle Channel / 20MHz / QPSK

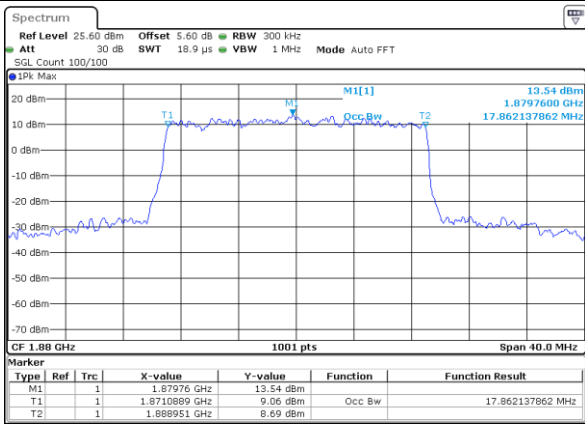

Date: 30.APR.2024 00:36:47

Middle Channel / 20MHz / 16QAM

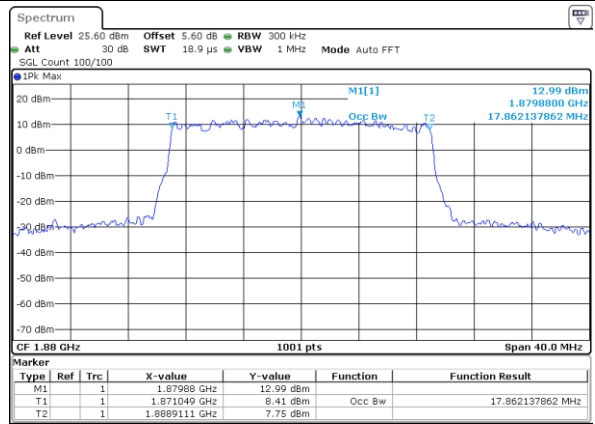

Date: 30.APR.2024 00:39:59



Conducted Band Edge

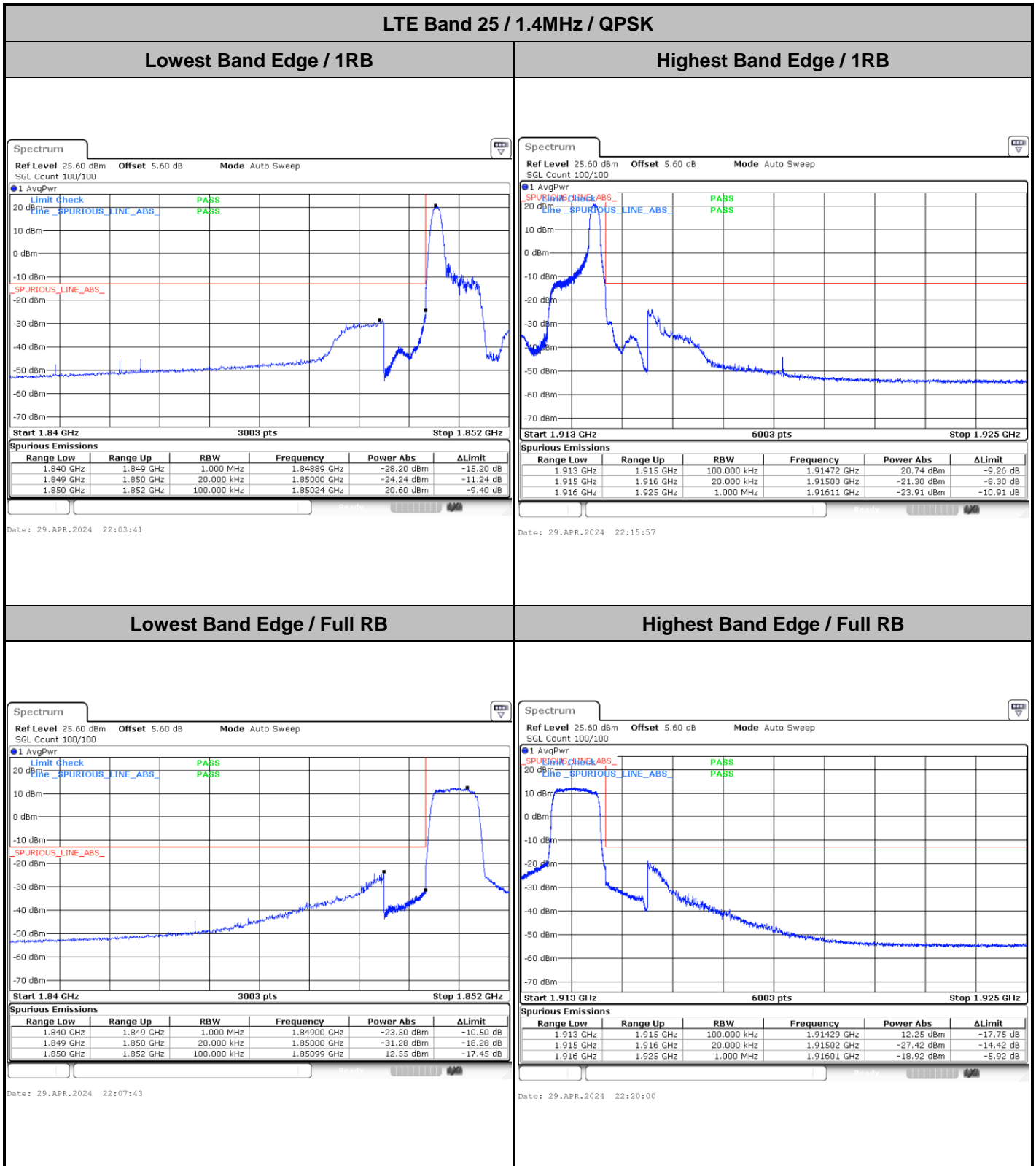



LTE Band 25 / 1.4MHz / 16QAM

Lowest Band Edge / 1 RB

Highest Band Edge / 1 RB

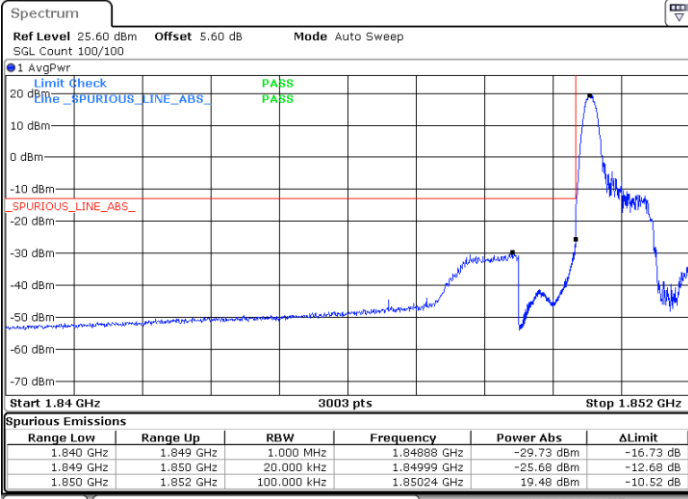

Date: 29.APR.2024 22:05:01

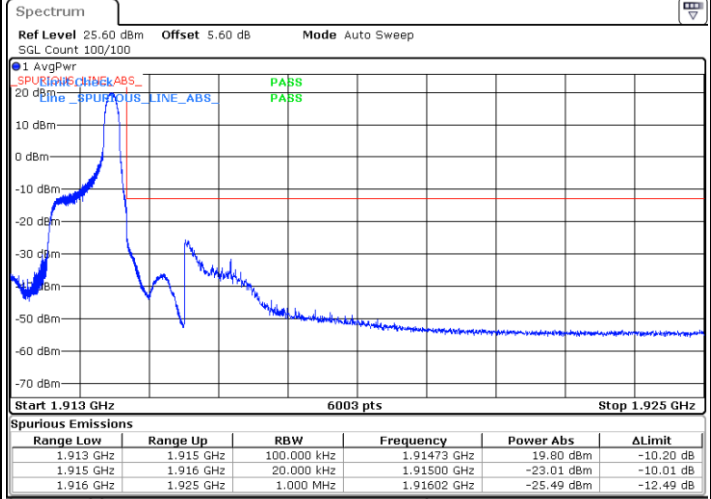

Date: 29.APR.2024 22:17:18

Lowest Band Edge / Full RB

Highest Band Edge / Full RB

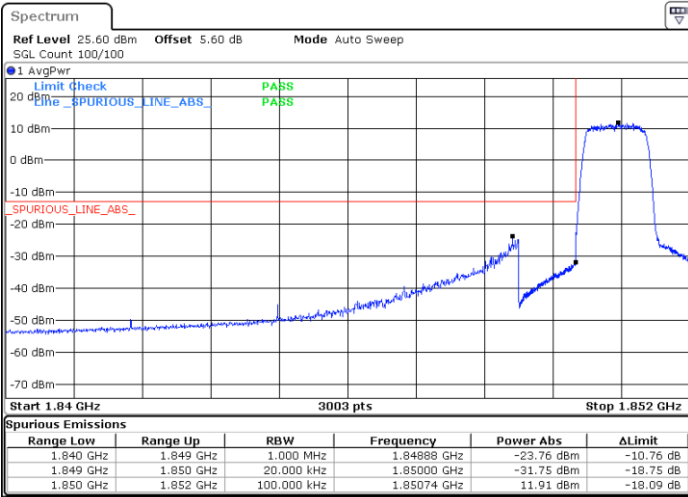

Date: 29.APR.2024 22:09:03

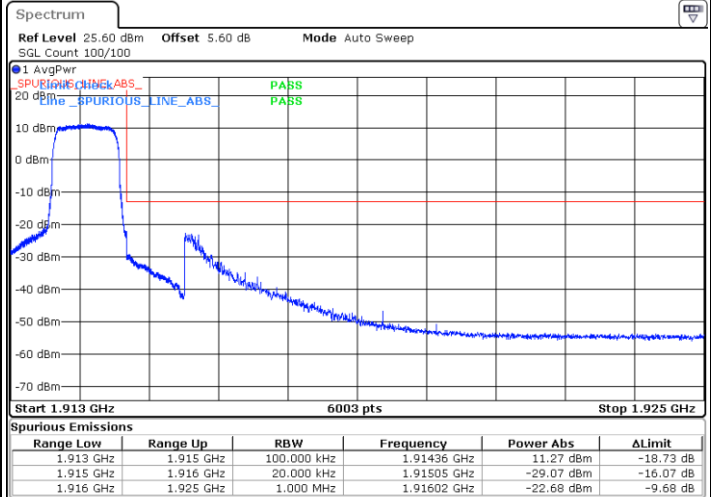

Date: 29.APR.2024 22:21:21



LTE Band 25 / 1.4MHz / 64QAM

Lowest Band Edge / 1 RB

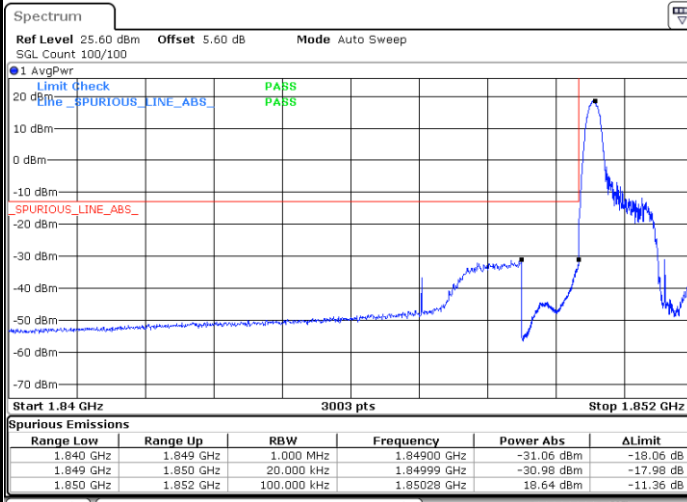

Date: 29.APR.2024 22:06:22

Highest Band Edge / 1 RB

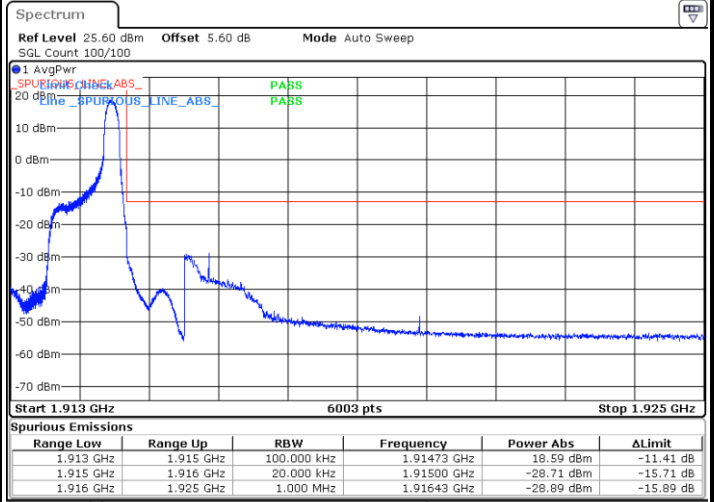

Date: 29.APR.2024 22:18:39

Lowest Band Edge / Full RB

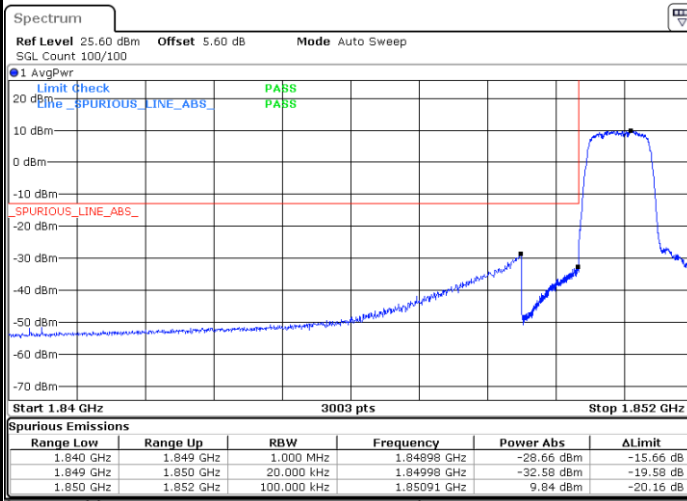

Date: 29.APR.2024 22:10:24

Highest Band Edge / Full RB

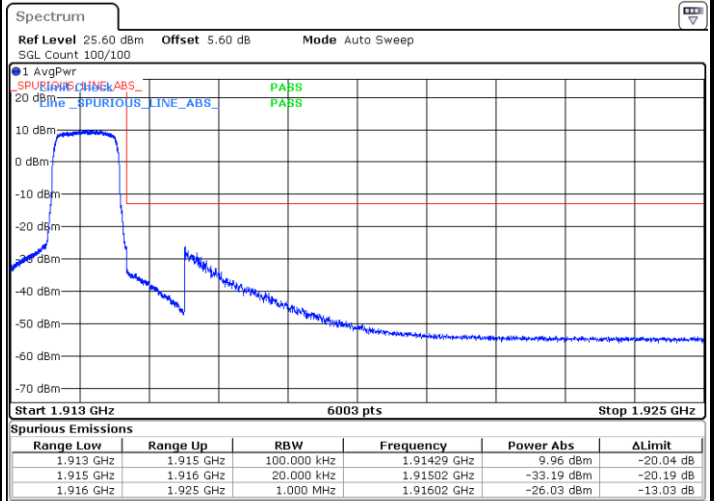

Date: 29.APR.2024 22:22:42



LTE Band 25 / 1.4MHz / 256QAM

Lowest Band Edge / 1 RB

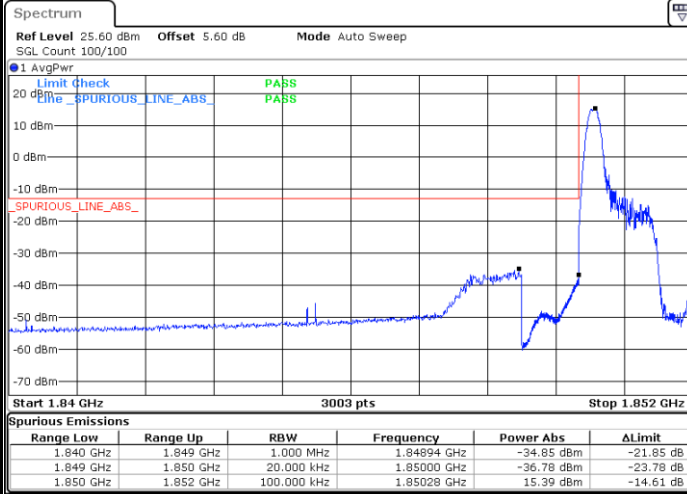

Date: 8.MAY.2024 00:11:06

Highest Band Edge / 1 RB

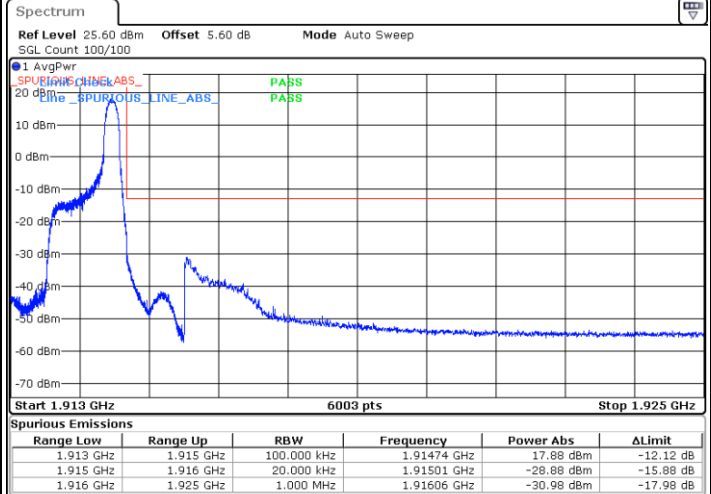

Date: 8.MAY.2024 00:16:48

Lowest Band Edge / Full RB

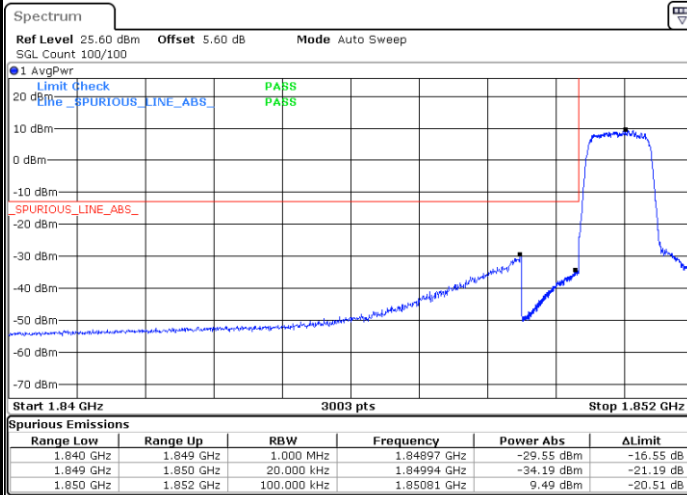

Date: 8.MAY.2024 00:12:28

Highest Band Edge / Full RB

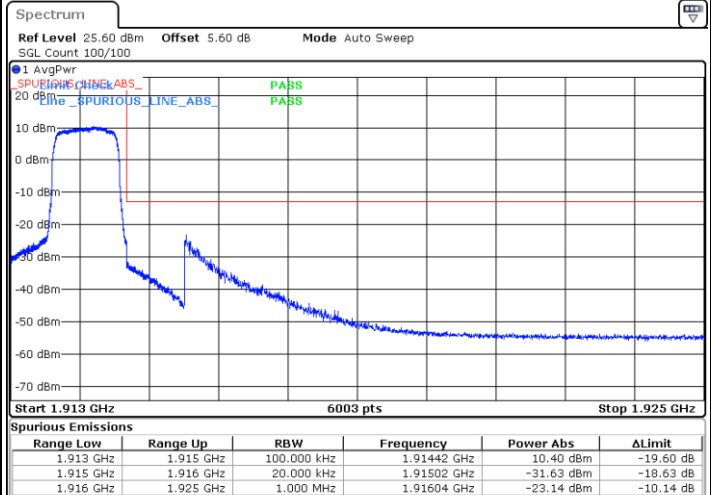

Date: 8.MAY.2024 00:14:58



LTE Band 25 / 3MHz / QPSK

Lowest Band Edge / 1RB

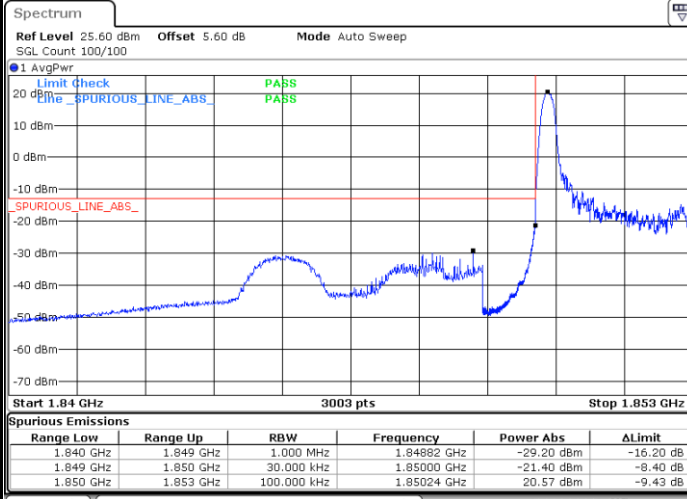

Date: 29.APR.2024 22:32:01

Highest Band Edge / 1 RB

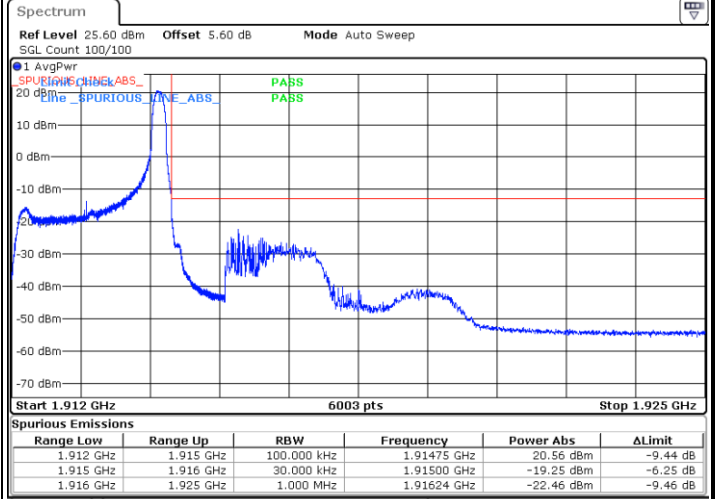

Date: 29.APR.2024 22:40:07

Lowest Band Edge / Full RB

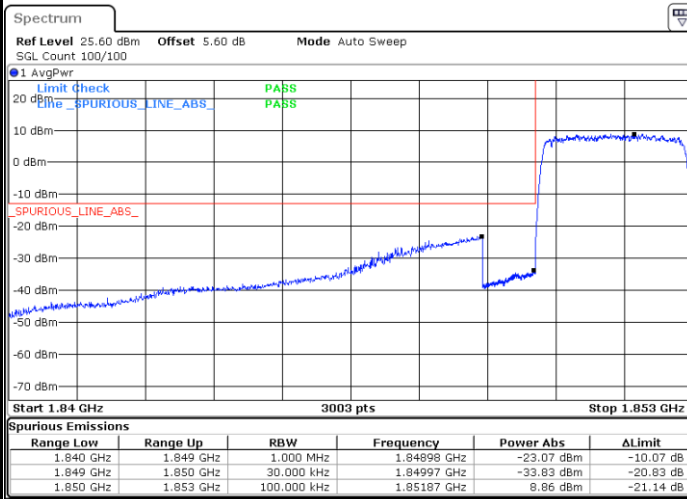

Date: 29.APR.2024 22:24:03

Highest Band Edge / Full RB

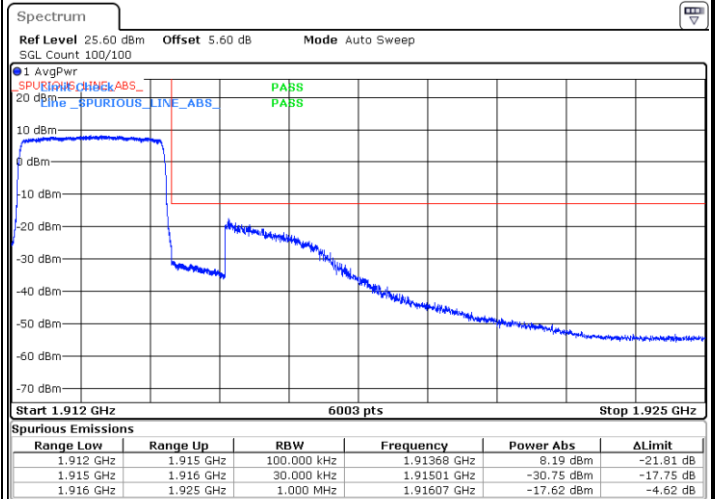

Date: 29.APR.2024 22:45:24



LTE Band 25 / 3MHz / 16QAM

Lowest Band Edge / 1 RB

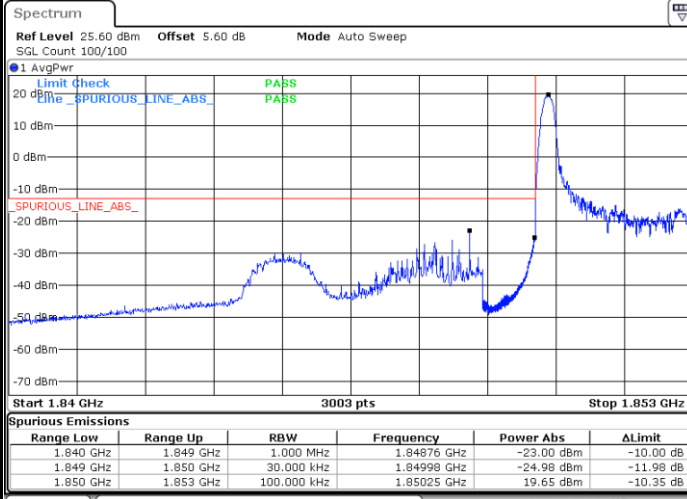

Date: 29.APR.2024 22:33:22

Highest Band Edge / 1 RB

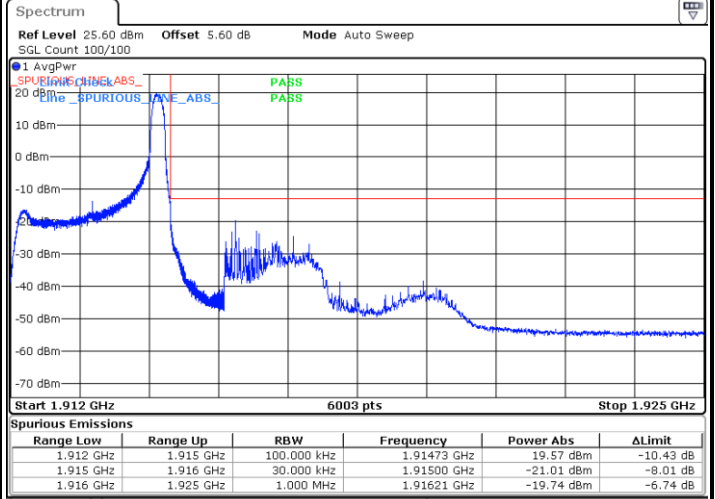

Date: 29.APR.2024 22:41:28

Lowest Band Edge / Full RB

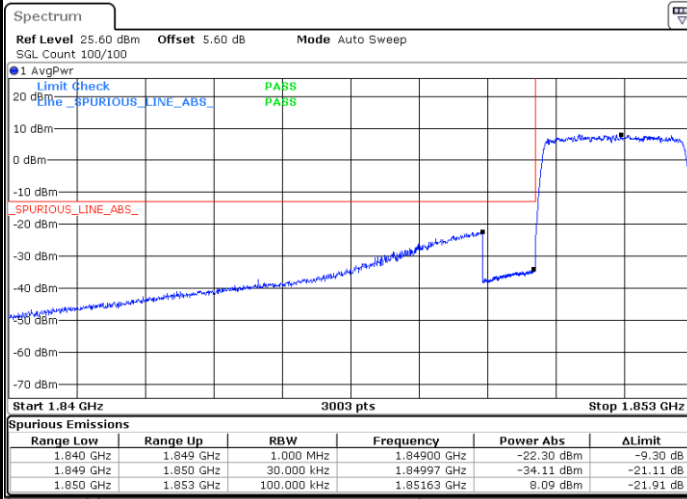

Date: 29.APR.2024 22:25:24

Highest Band Edge / Full RB

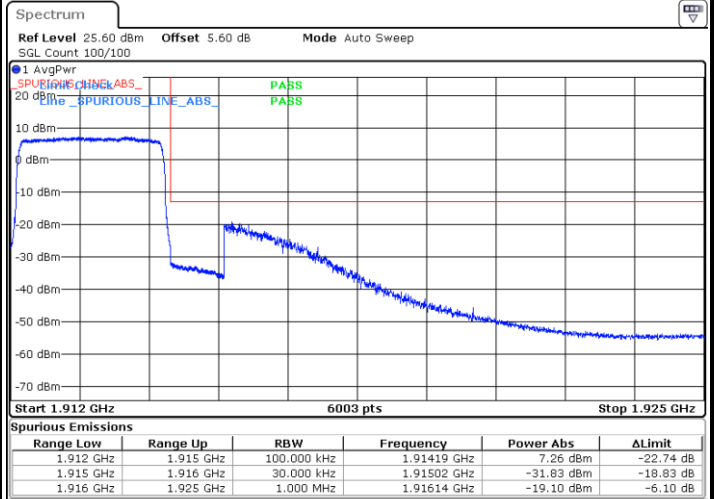

Date: 29.APR.2024 22:46:48



LTE Band 25 / 3MHz / 64QAM

Lowest Band Edge / 1 RB

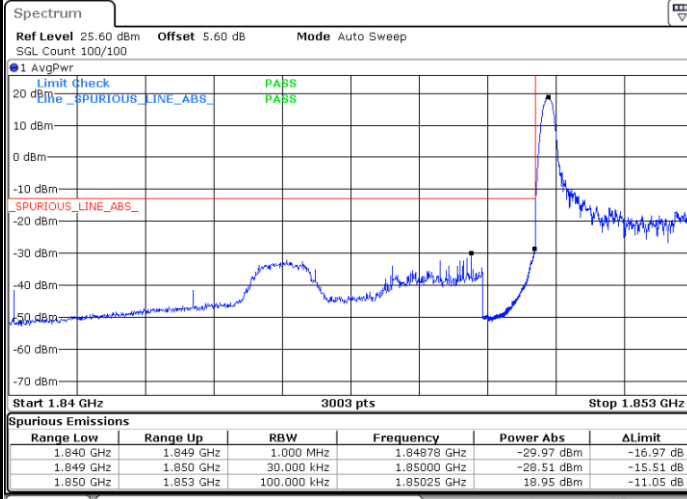

Date: 29.APR.2024 22:34:42

Highest Band Edge / 1 RB

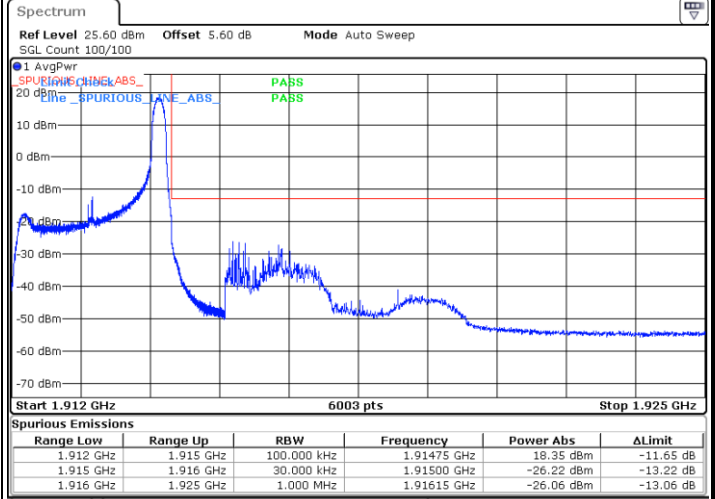

Date: 29.APR.2024 22:44:03

Lowest Band Edge / Full RB

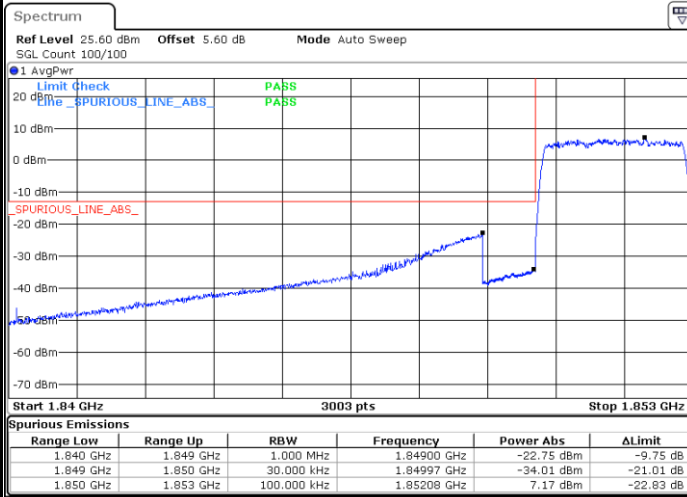

Date: 29.APR.2024 22:28:39

Highest Band Edge / Full RB

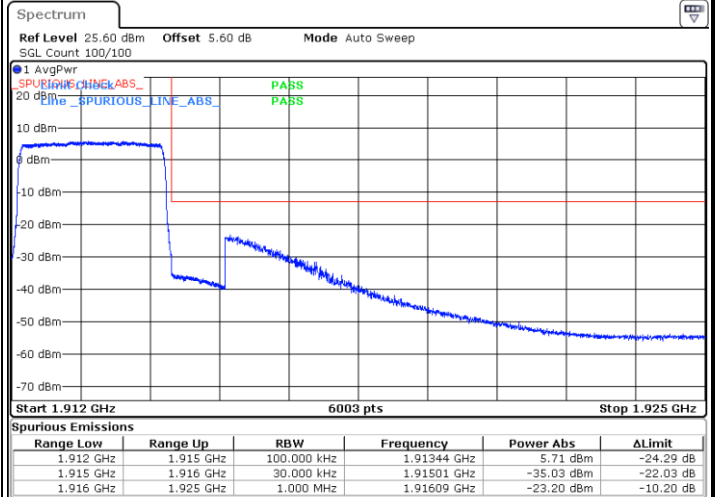

Date: 29.APR.2024 22:48:11



LTE Band 25 / 3MHz / 256QAM

Lowest Band Edge / 1 RB

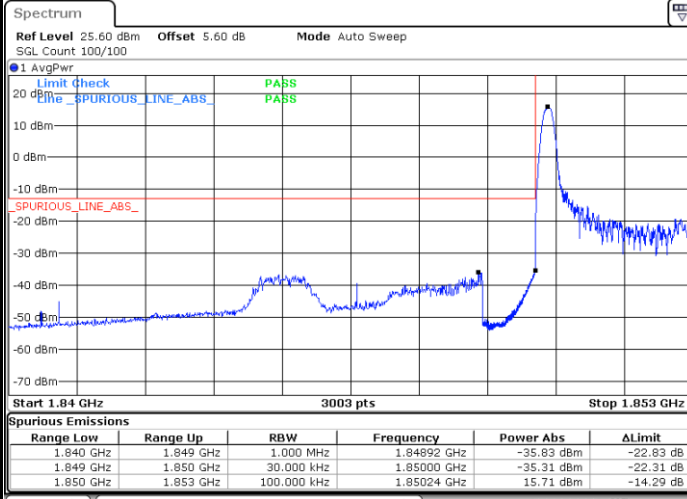

Date: 8.MAY.2024 00:04:07

Highest Band Edge / 1 RB

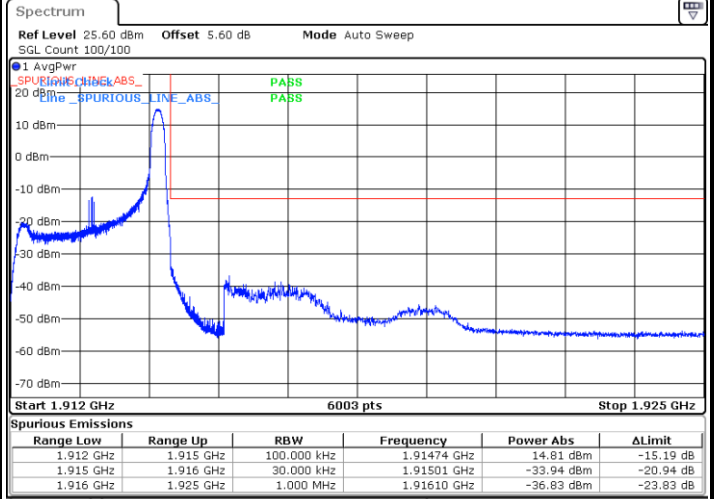

Date: 8.MAY.2024 00:08:13

Lowest Band Edge / Full RB

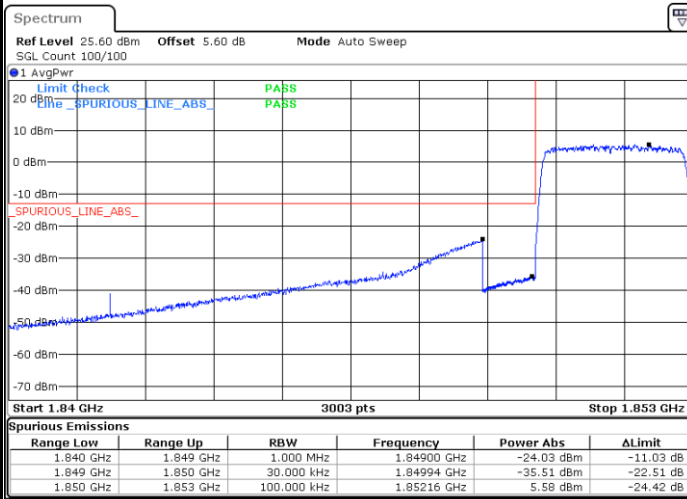

Date: 8.MAY.2024 00:05:46

Highest Band Edge / Full RB

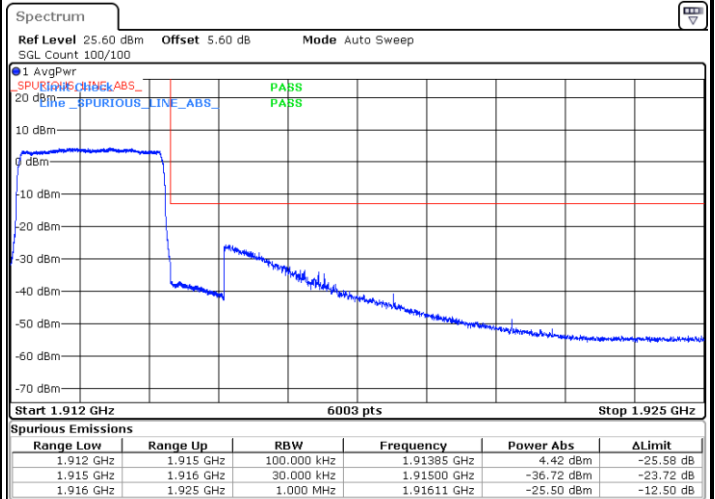

Date: 8.MAY.2024 00:06:56



LTE Band 25 / 5MHz / QPSK

Lowest Band Edge / 1 RB

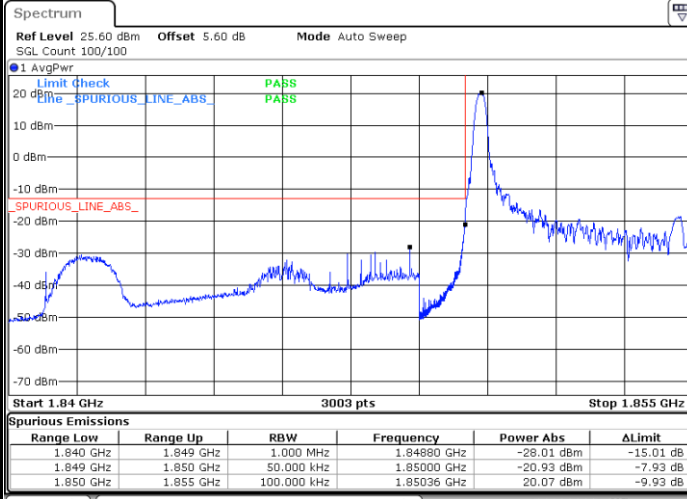

Date: 29.APR.2024 22:55:52

Highest Band Edge / 1 RB

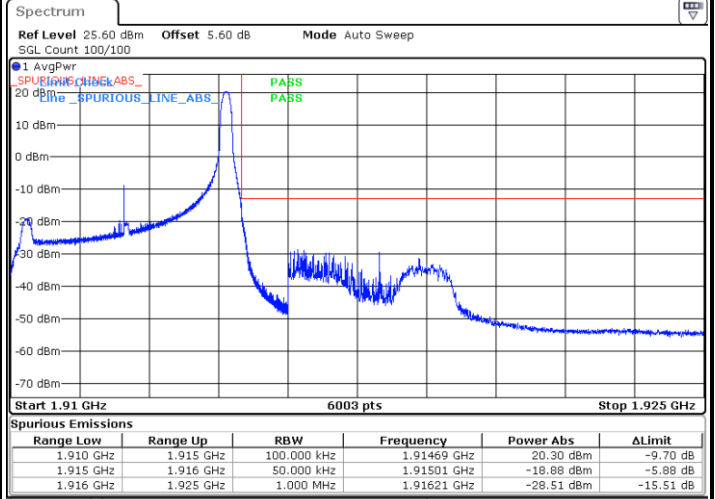

Date: 29.APR.2024 23:04:57

Lowest Band Edge / Full RB

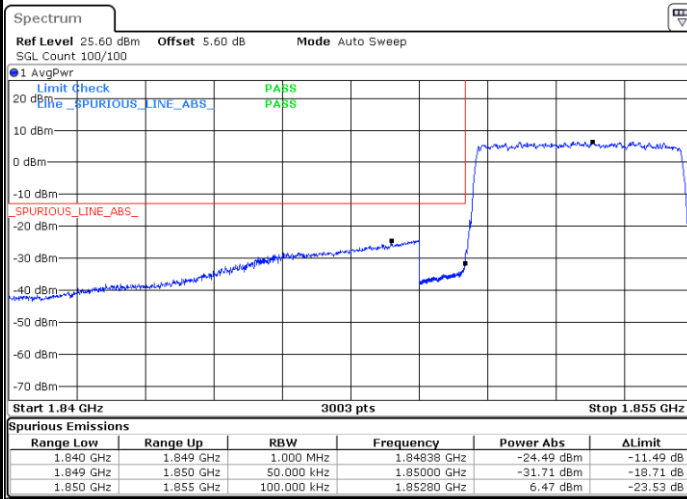

Date: 29.APR.2024 22:49:32

Highest Band Edge / Full RB

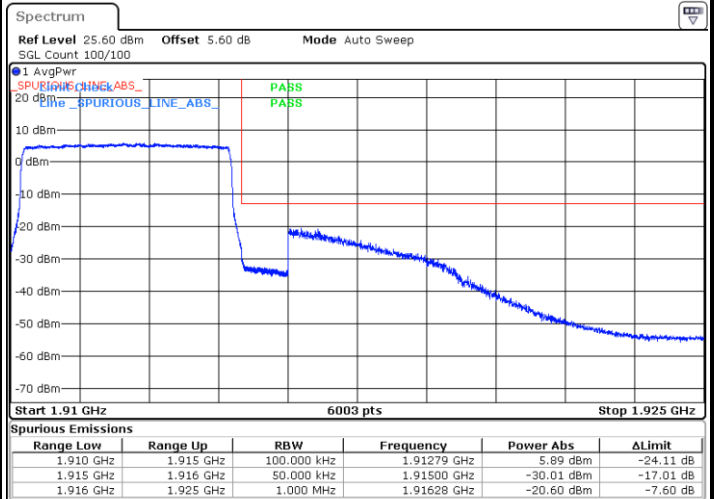

Date: 29.APR.2024 23:02:26



LTE Band 25 / 5MHz / 16QAM

Lowest Band Edge / 1RB

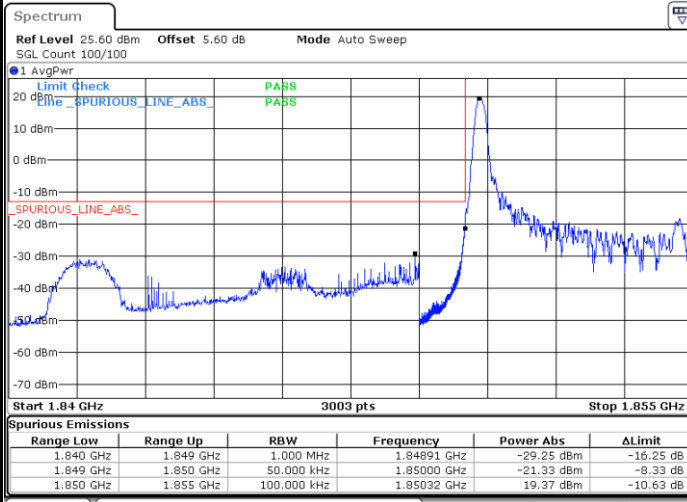

Date: 29.APR.2024 22:56:42

Highest Band Edge / 1 RB

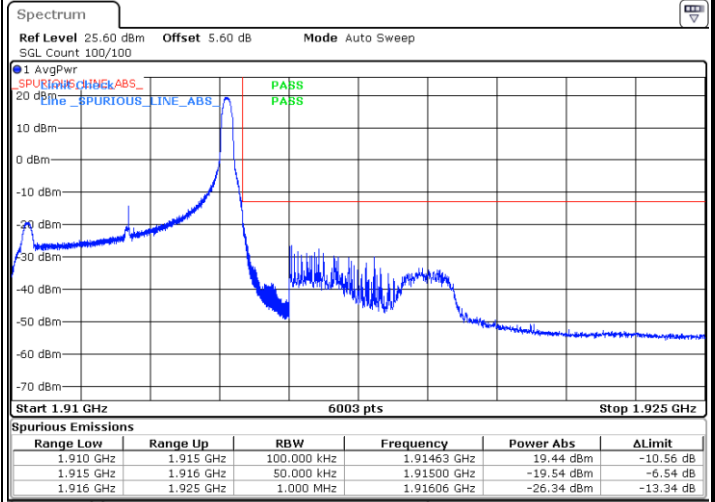

Date: 29.APR.2024 23:05:47

Lowest Band Edge / Full RB

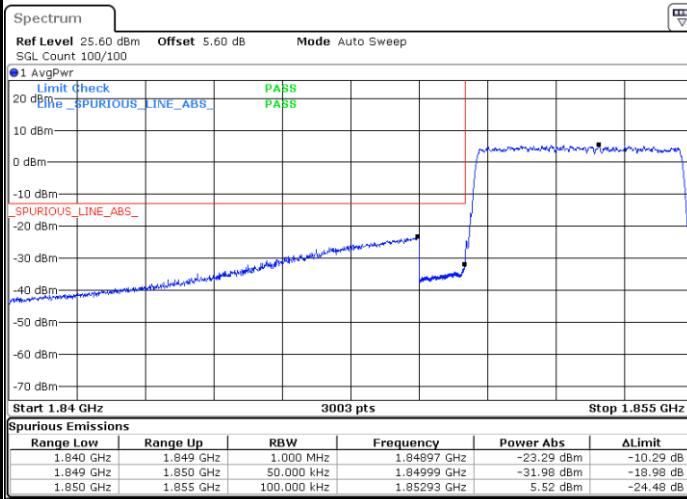

Date: 29.APR.2024 22:52:11

Highest Band Edge / Full RB

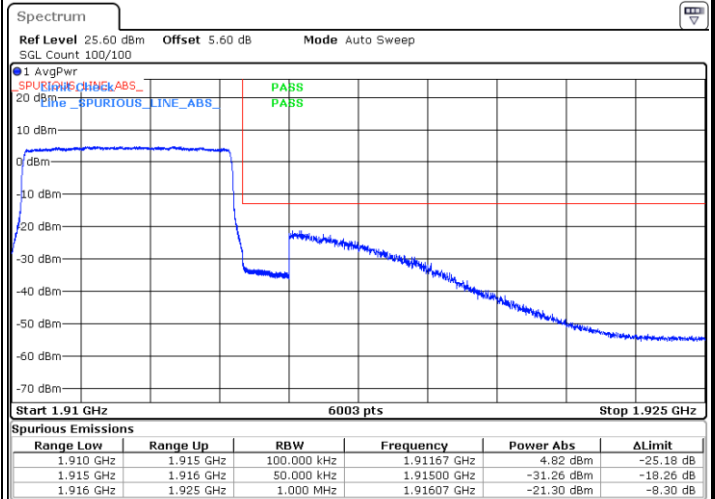

Date: 29.APR.2024 23:03:16



LTE Band 25 / 5MHz / 64QAM

Lowest Band Edge / 1RB

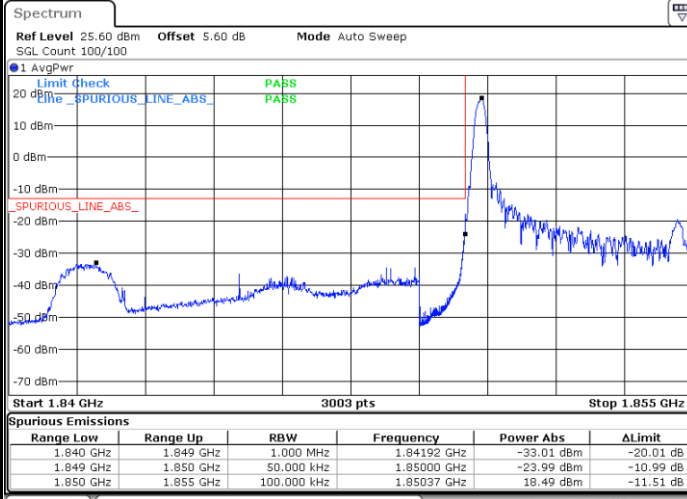

Date: 29.APR.2024 22:57:32

Highest Band Edge / 1 RB

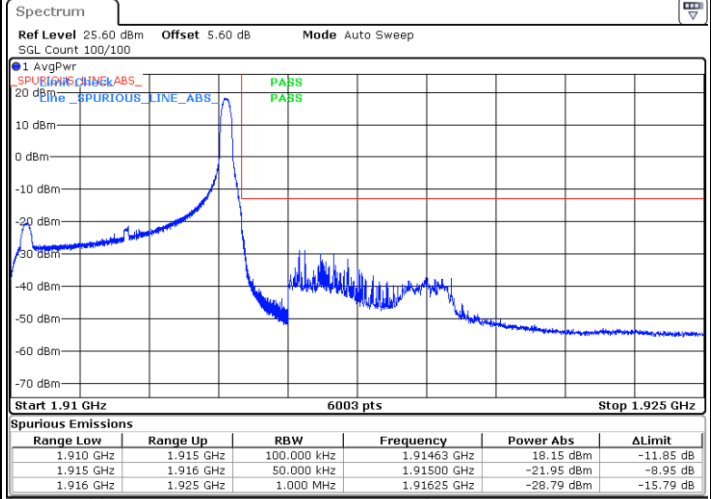

Date: 29.APR.2024 23:06:38

Lowest Band Edge / Full RB

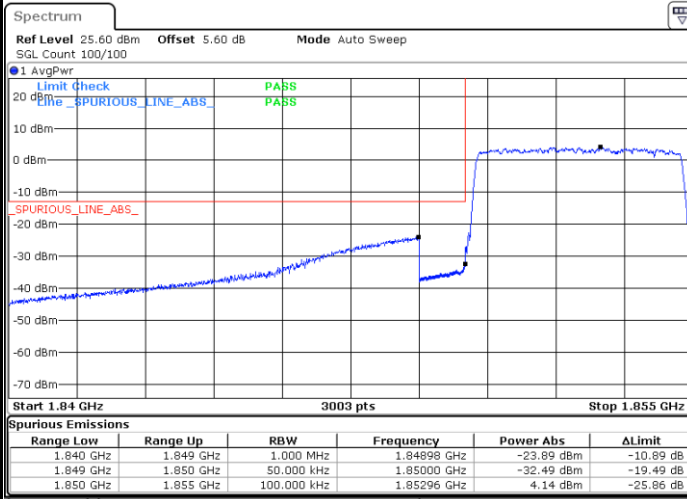

Date: 29.APR.2024 22:53:01

Highest Band Edge / Full RB

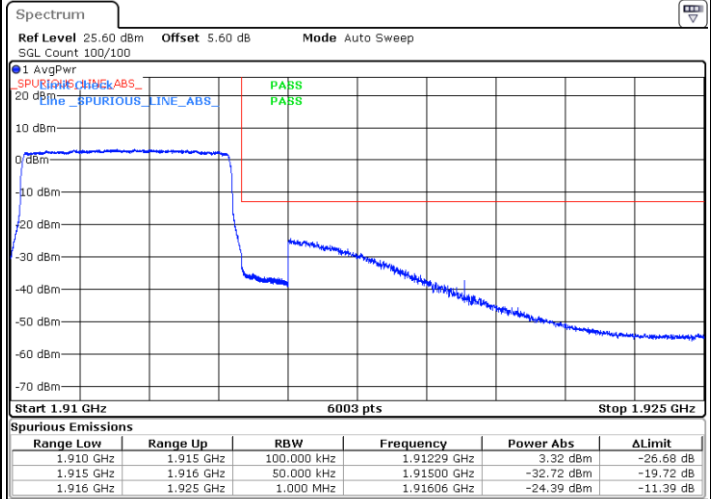

Date: 29.APR.2024 23:04:07



LTE Band 25 / 5MHz / 256QAM

Lowest Band Edge / 1RB

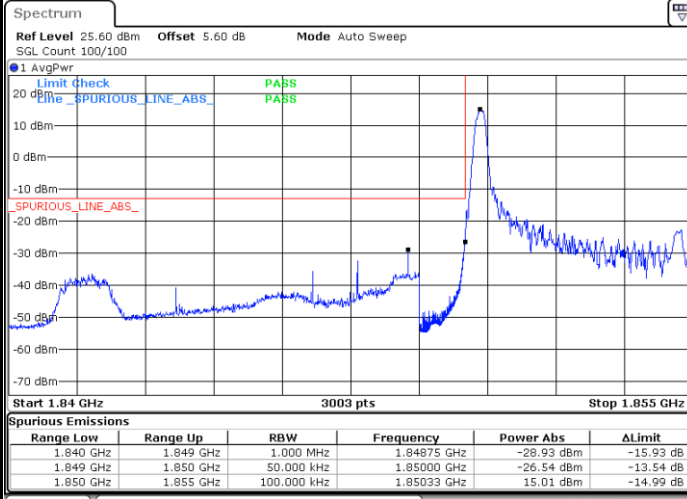

Date: 7.MAY.2024 23:47:15

Highest Band Edge / 1 RB

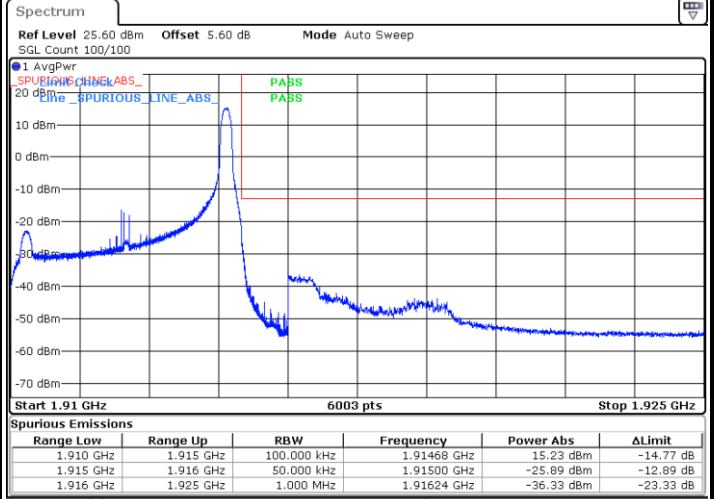

Date: 7.MAY.2024 23:44:39

Lowest Band Edge / Full RB

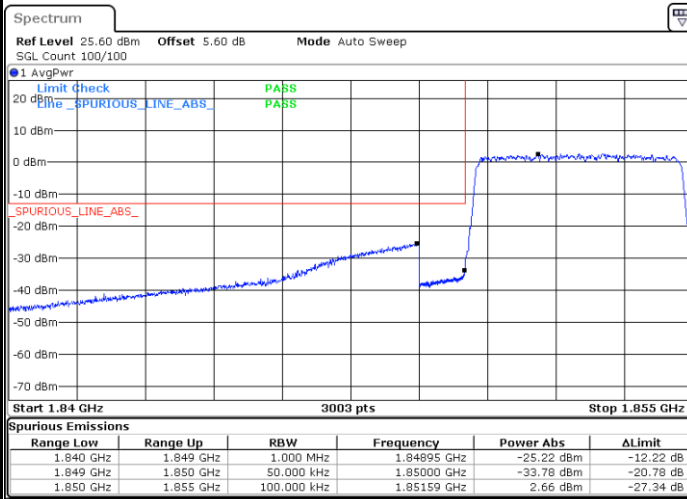

Date: 7.MAY.2024 23:46:32

Highest Band Edge / Full RB

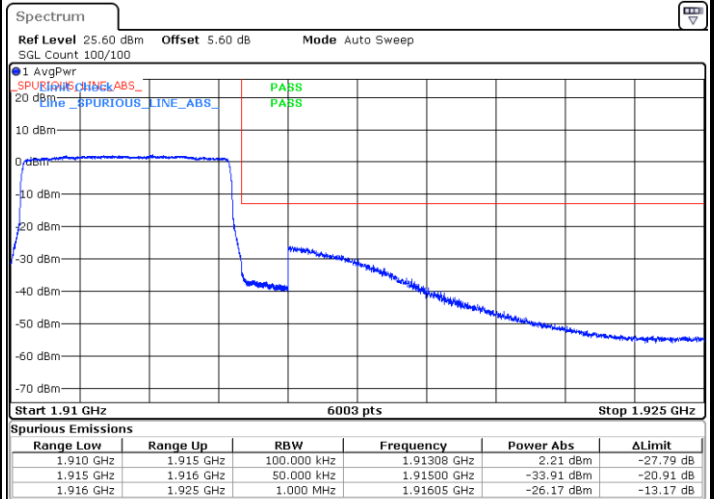

Date: 7.MAY.2024 23:45:31



LTE Band 25 / 10MHz / QPSK

Lowest Band Edge / 1 RB

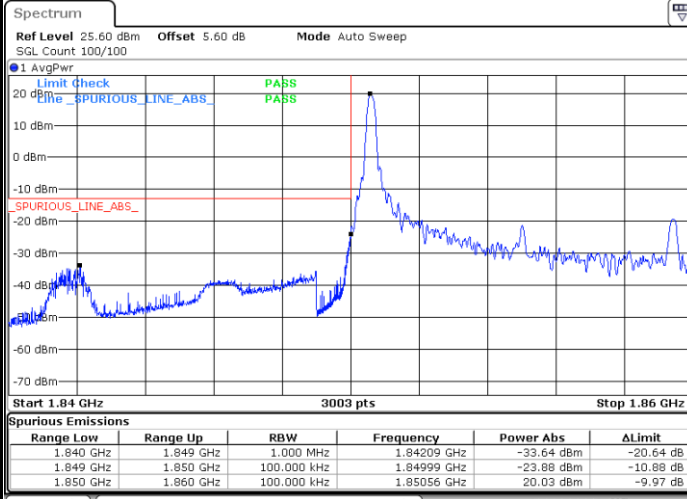

Date: 29.APR.2024 23:24:18

Highest Band Edge / 1 RB

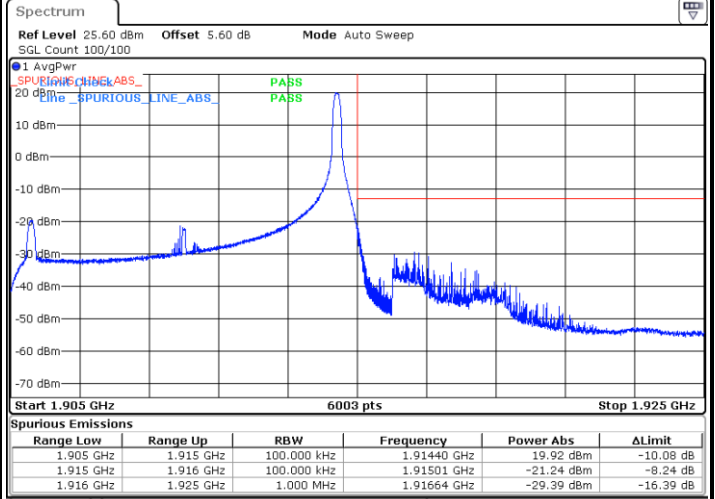

Date: 29.APR.2024 23:34:45

Lowest Band Edge / Full RB

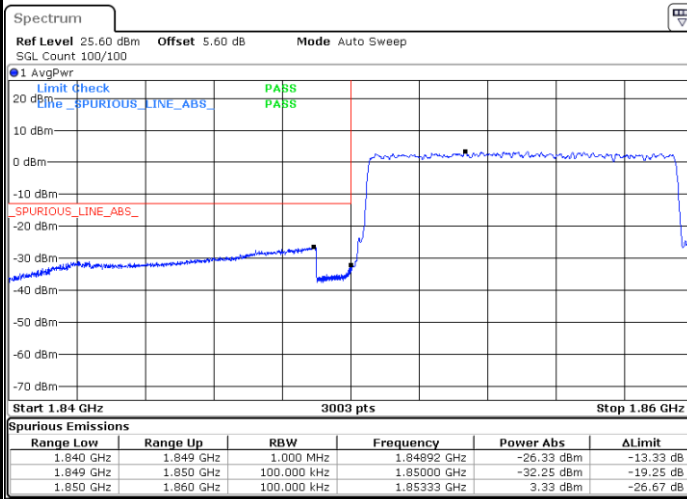

Date: 29.APR.2024 23:21:06

Highest Band Edge / Full RB

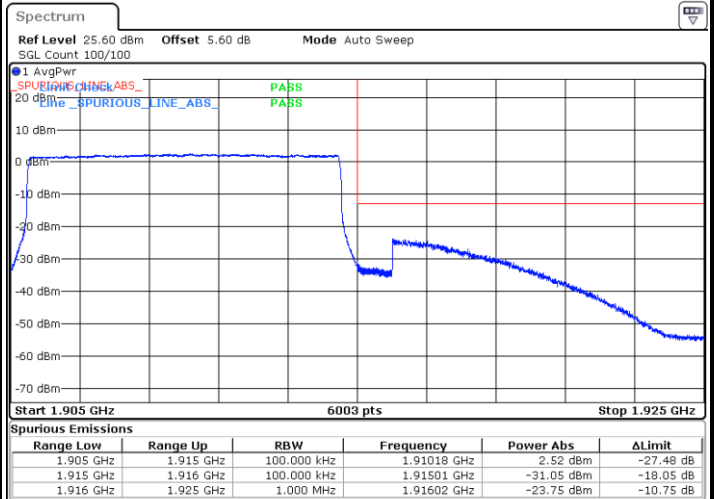

Date: 29.APR.2024 23:32:28



LTE Band 25 / 10MHz / 16QAM

Lowest Band Edge / 1 RB

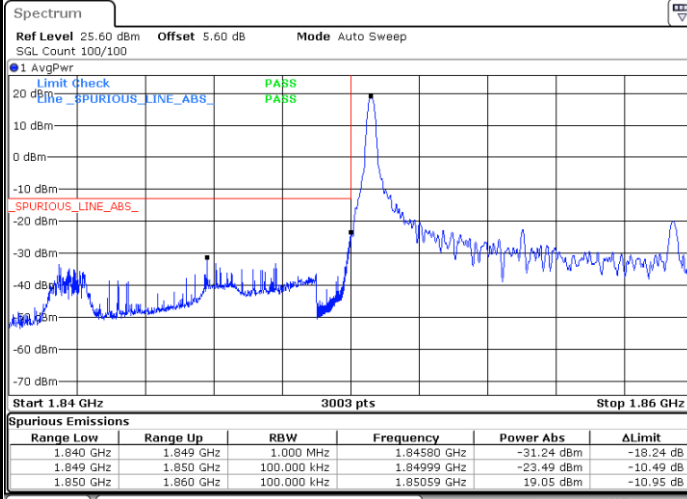

Date: 29.APR.2024 23:27:00

Highest Band Edge / 1 RB

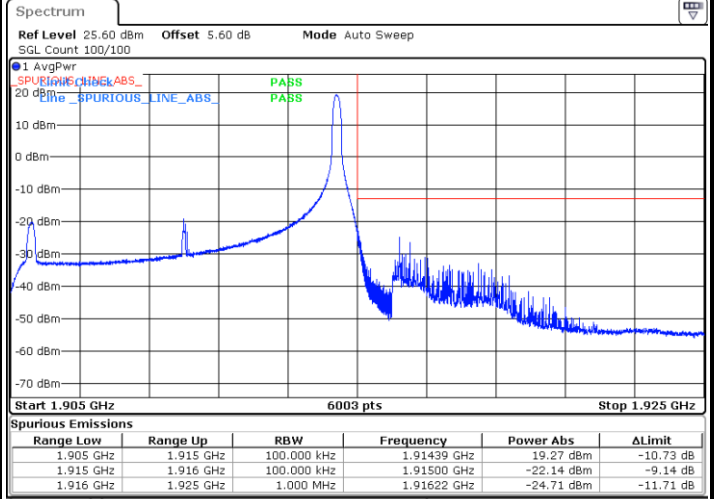

Date: 29.APR.2024 23:35:29

Lowest Band Edge / Full RB

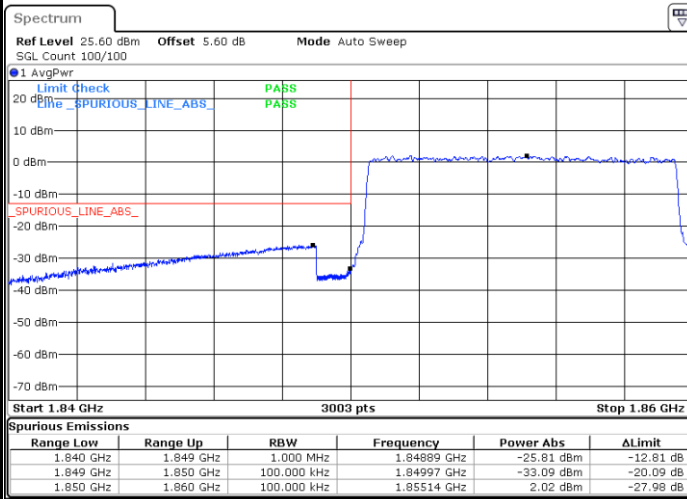

Date: 29.APR.2024 23:22:58

Highest Band Edge / Full RB

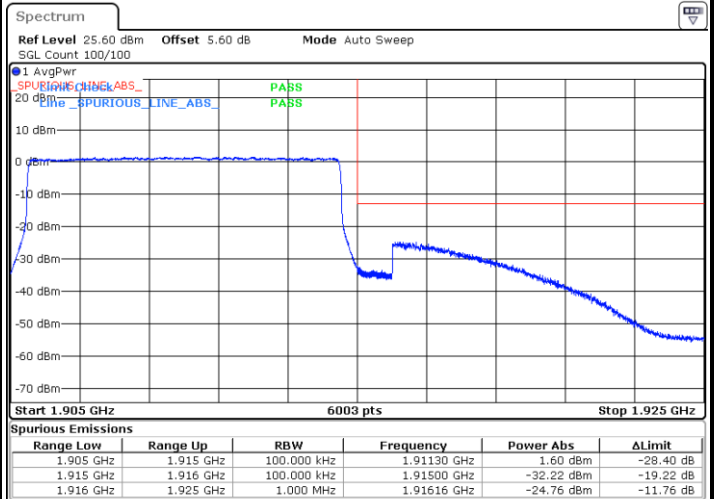

Date: 29.APR.2024 23:33:13



LTE Band 25 / 10MHz / 64QAM

Lowest Band Edge / 1 RB

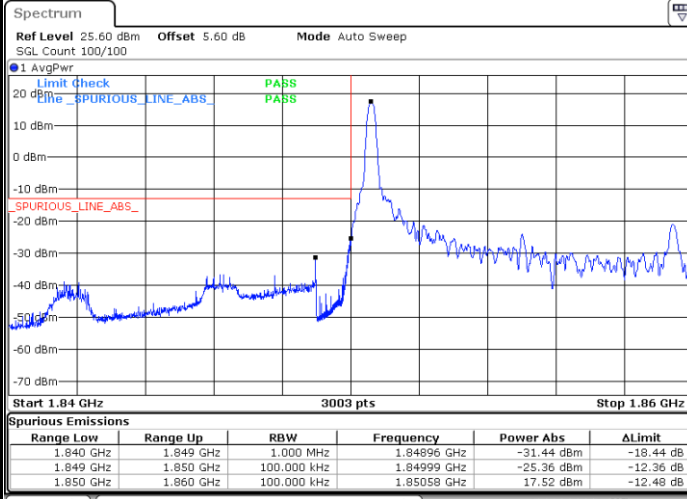

Date: 29.APR.2024 23:27:40

Highest Band Edge / 1 RB

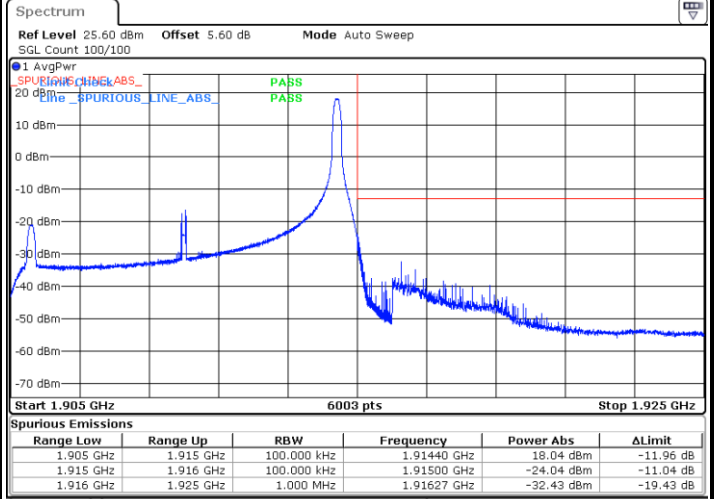

Date: 29.APR.2024 23:36:14

Lowest Band Edge / Full RB

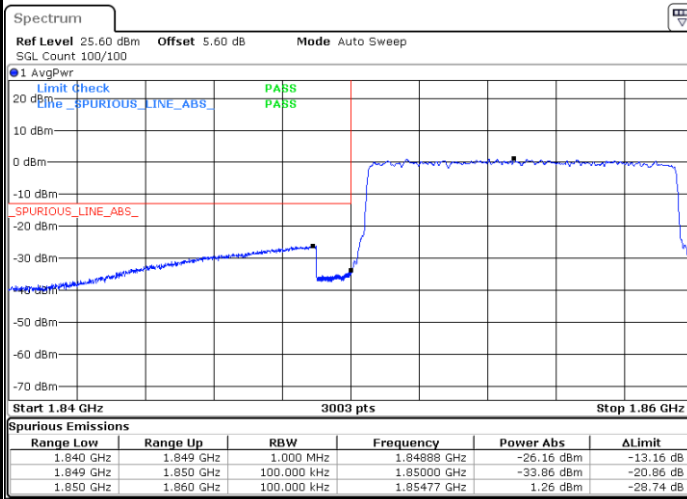

Date: 29.APR.2024 23:23:38

Highest Band Edge / Full RB

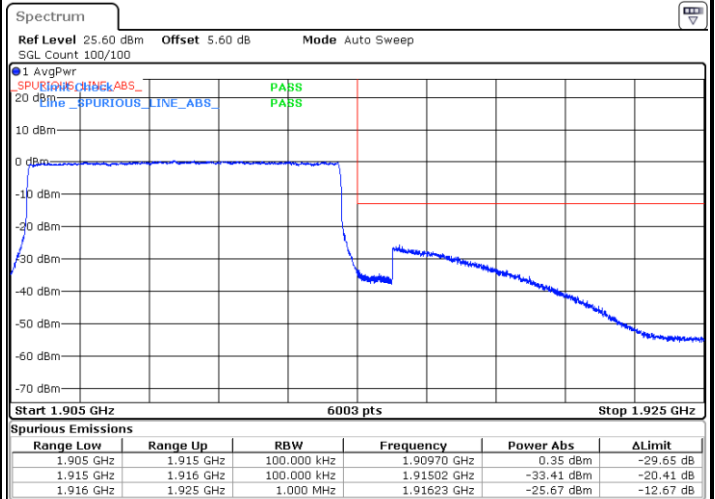

Date: 29.APR.2024 23:33:57



LTE Band 25 / 10MHz / 256QAM

Lowest Band Edge / 1 RB

Highest Band Edge / 1 RB

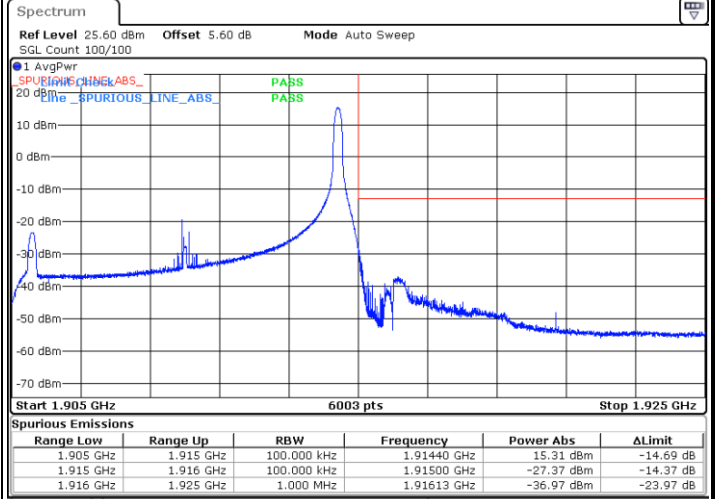
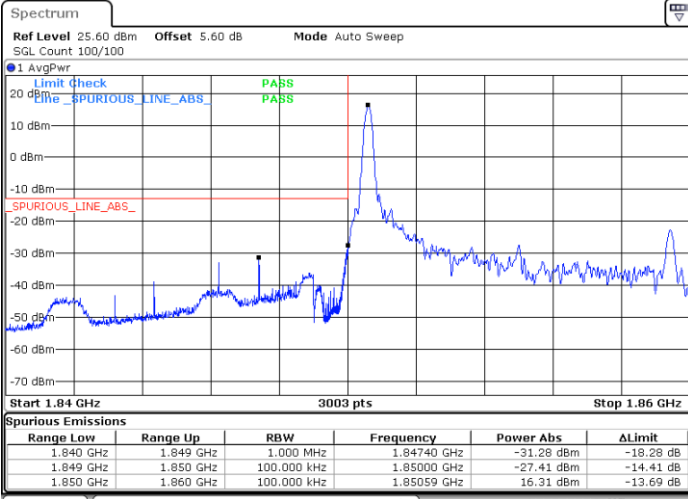

Date: 7.MAY.2024 23:48:57

Date: 7.MAY.2024 23:51:33

Lowest Band Edge / Full RB

Highest Band Edge / Full RB

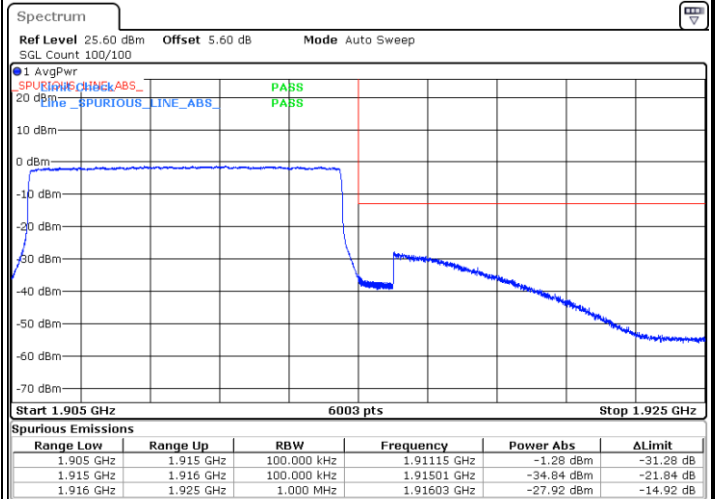
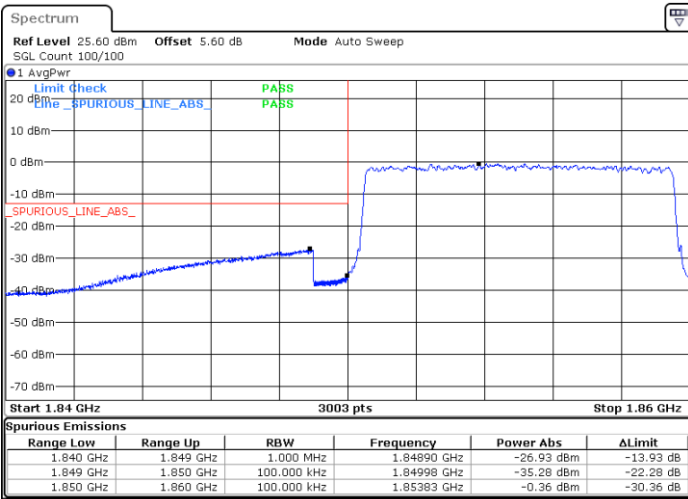

Date: 7.MAY.2024 23:49:31

Date: 7.MAY.2024 23:50:38



LTE Band 25 / 15MHz / QPSK

Lowest Band Edge / 1 RB

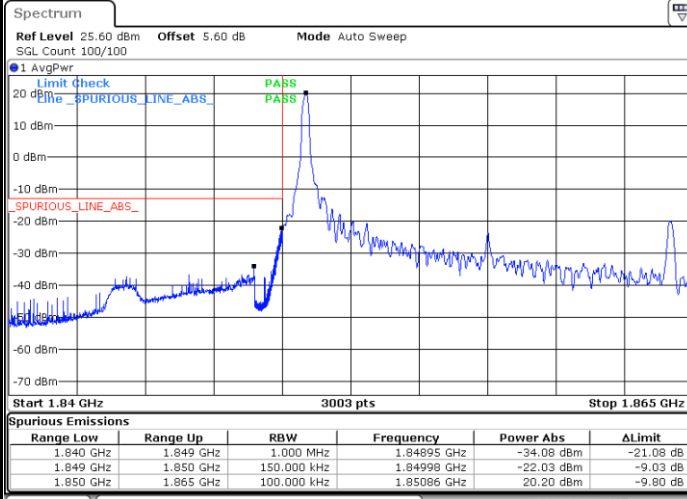

Date: 29.APR.2024 23:40:57

Highest Band Edge / 1 RB

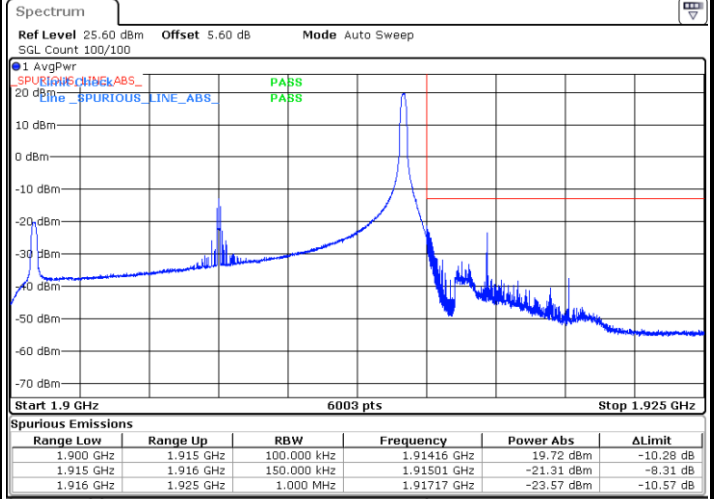

Date: 30.APR.2024 00:20:20

Lowest Band Edge / Full RB

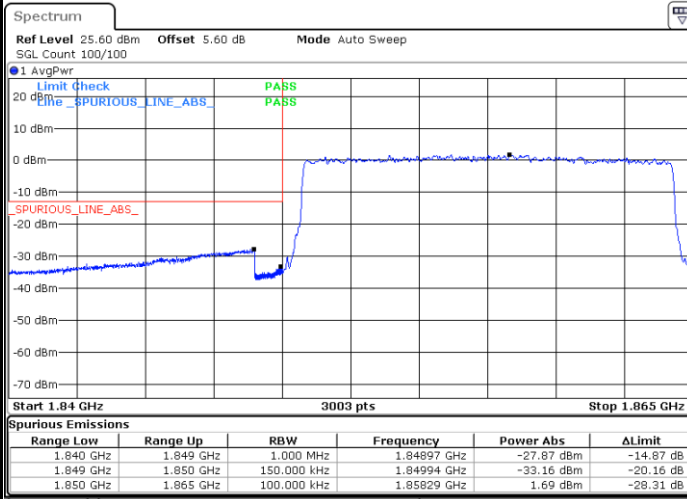

Date: 29.APR.2024 23:36:54

Highest Band Edge / Full RB

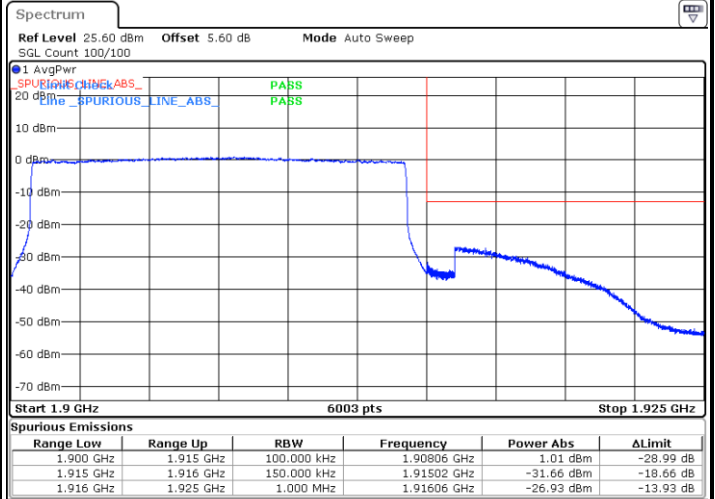

Date: 30.APR.2024 00:16:18